

# Probuilder<sup>®</sup>

CARBON SERIES™



3271 | Assault Chopper



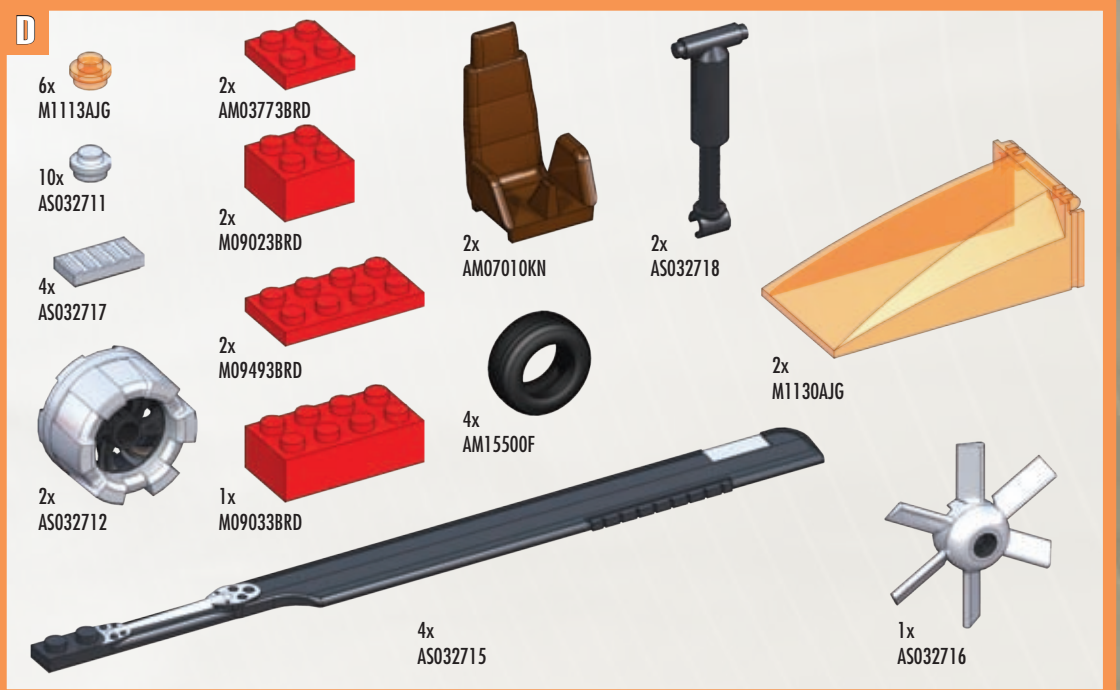
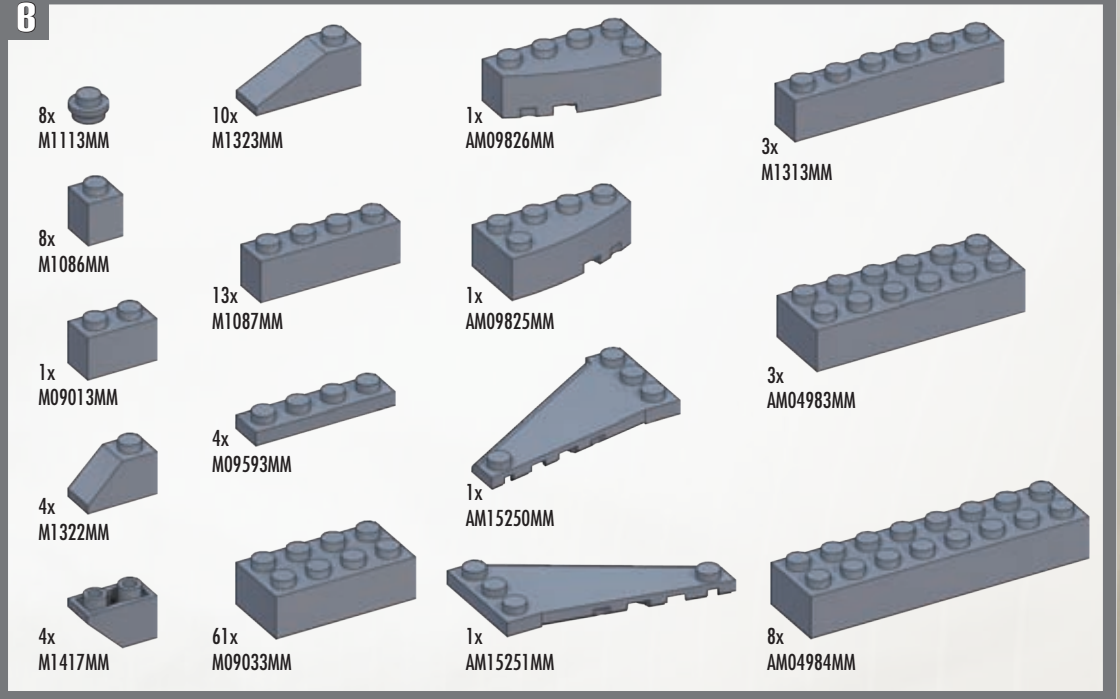
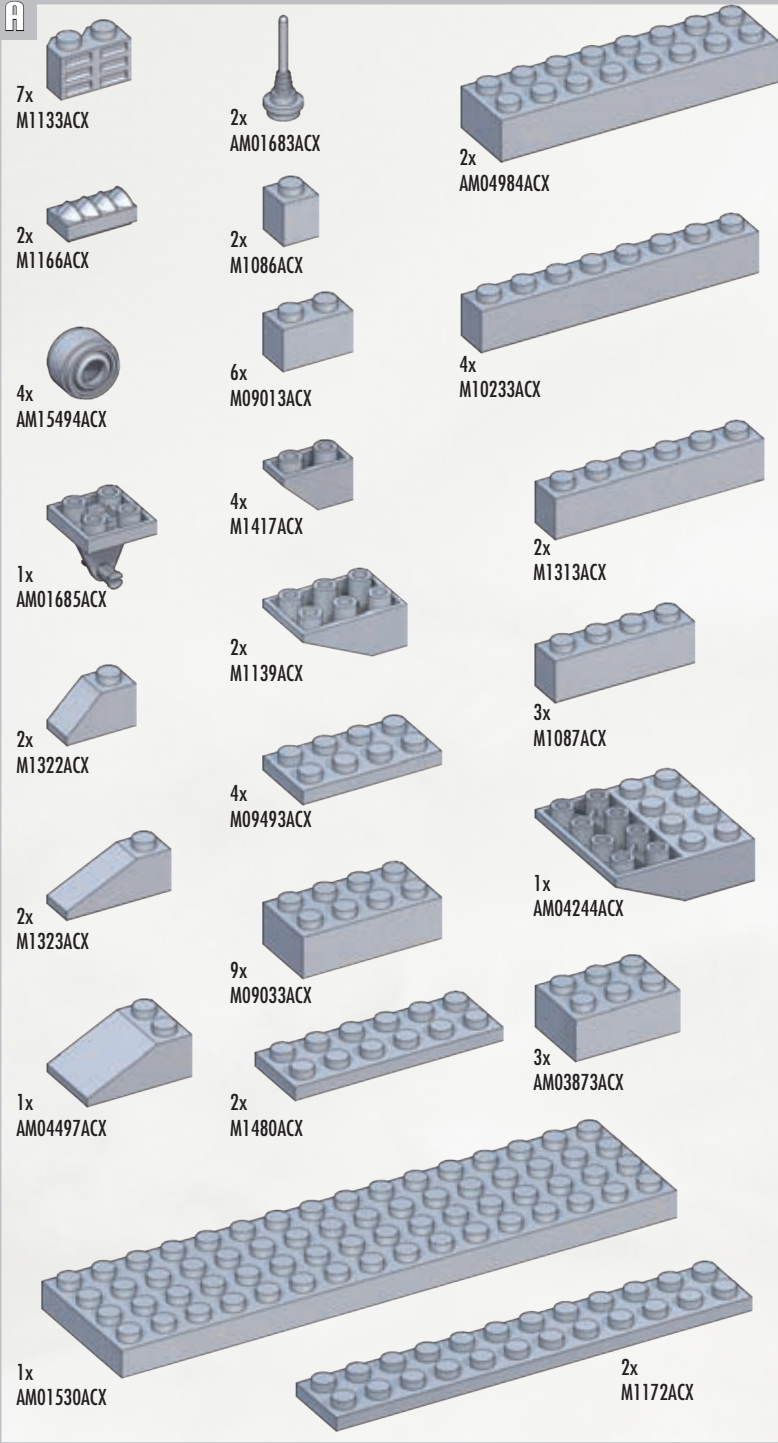

**C**

2x  
AM07629RH



12x  
M1086RH



6x  
M09013RH



15x  
M09393RH



4x  
AM07590RH



4x  
M0948RH



2x  
M1390RH



9x  
M09593RH



2x  
AM01531RH



2x  
M1139RH

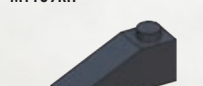

7x  
M1323RH



1x  
AM04497RH



2x  
M11101RH



2x  
AM03773RH



18x  
M1154RH



2x  
AM04430RH



9x  
M1322RH



24x  
AM10273RH



1x  
AM02800RH

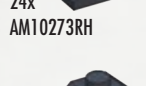

3x  
AM08480RH



6x  
M1367RH



2x  
AM08416RH



2x  
AM11972F



2x  
AM03873RH



3x  
M09033RH



2x  
M1480RH

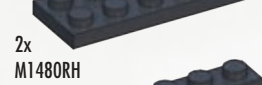

6x  
M1313RH

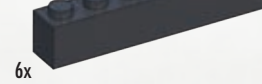

1x  
AM09292RH



1x  
M10233RH



3x  
AM04984RH



1x  
AM04985RH



1x  
M1172RH



2x  
AM15486RH



1x  
AM08463RH



1x  
AM08467RH

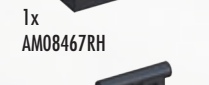

2x  
M1120RH



2x  
M1119RH

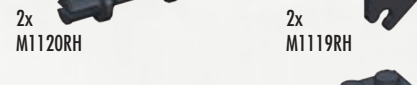

1x  
AM02056RH



1x  
M1155RH



1x  
AM03089RH



2x  
AM09931RH



1x  
AM03652RH



2x  
AM01749RH

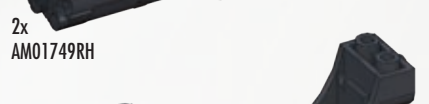

1x  
AM08465RH



1x  
AM08468RH



2x  
AM15510RH

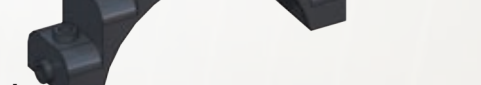

1x  
AM02057RH

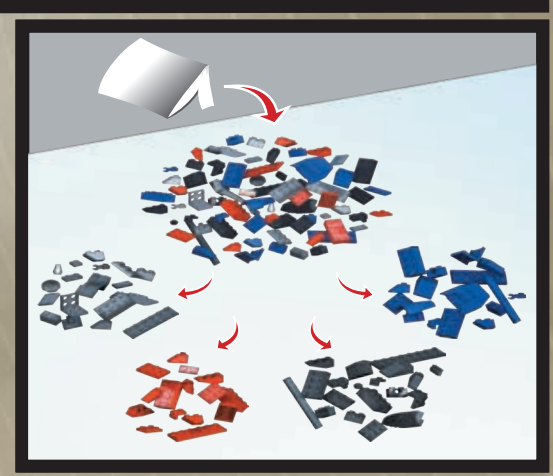

# Probuilder<sup>®</sup>

CARBON SERIES™



**EN** Please read these instructions carefully before first use and keep them for future reference. / **ES** Leer estas instrucciones cuidadosamente antes de la primera utilización y guardarlas para referencia futura. / **FR** Il est recommandé de lire attentivement ce feuillet avant la première utilisation et de le conserver pour référence future. / **DE** Die Gebrauchsanleitung bitte durchlesen und aufbewahren. / **NL** Wij raden u aan deze handleiding zorgvuldig te lezen en te bewaren voor eventuele raadpleging op een later tijdstip. / **IT** Leggere le istruzioni prima di cominciare ad usare il gioco e conservarle per referenze future. / **PT** Leia as instruções antes do primeiro uso e guarde-as para futura referência.

**EN** ⚠ **WARNING :**  
**CHOKING HAZARD.** - Small parts.  
Not for children under 3 years.

**ES** ⚠ **ADVERTENCIA :**  
**PELIGRO DE ASFIXIA.** - Contiene piezas pequeñas.  
No recomendado para niños menores de 3 años.

**FR** ⚠ **AVERTISSEMENT :**  
**RISQUE DE SUFFOCATION.** - Présence de petits éléments.  
Ne convient pas aux enfants de moins de 3 ans.

**DE** ⚠ **WARNUNG :**  
**ERSTICKUNGSGEFAHR.** - Enthält kleine Teile.  
Nicht für Kinder unter 3 Jahren geeignet.

**NL** ⚠ **WAARSCHUWING :**  
**VERSTIKKINGSGEVAAR.** - Bevat kleine onderdelen.  
Niet geschikt voor kinderen onder de 3 jaar.

**DA** ⚠ **ADVARSEL :**  
**KVÆLNINGSFARE.** - Indeholder smådele.  
Ikke til børn under 3 år.

**EL** ⚠ **ΠΡΟΕΙΔΟΠΟΙΗΣΗ :**  
**ΚΙΝΔΥΝΟΣ ΠΝΙΞΙΜΑΤΟΣ.** - Περιέχει μικρά αντικείμενα  
Όχι για παιδιά κάτω των 3 ετών.

**FI** ⚠ **VAROITUS :**  
**TUKEHTUMISVAARA.** - Sisältää pieniä osia.  
Ei alle 3-vuotiaalle lapsille.

**IT** ⚠ **ATTENZIONE :**  
**PERICOLO DI SOFFOCAMENTO.** - Contiene piccole parti.  
Non indicato per bambini sotto i 3 anni.

**NO** ⚠ **ADVARSEL :**  
**KVELNINGSFARE.** - Inneholder små deler.  
Kun for barn over 3 år.





**PT** ⚠ **ATENÇÃO :**  
**PERIGO DE ASFIXIA.** - Contém peças pequenas.  
Não é concebido para crianças de menos de 3 anos.

**SV** ⚠ **WARNING :**  
**KVÄVNINGSRISK.** - Innehåller små delar.  
Inte för barn under 3 år.

**JA** ⚠ **警告 :**  
窒息の危険性 - 小さな部品が含まれています  
3歳以下の子供には与えないで下さい。

**ZH** ⚠ **警告 :**  
有窒息危險 - 包含有小部件  
不适合3岁以下的小孩玩。

**AR** ⚠ **تحذير :**  
خطر اختناق - قطع صغيرة.  
غير صالحة للأطفال أقل من 3 سنوات.

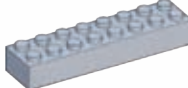
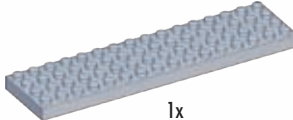
-  1x
-  1x
-  2x
-  4x
-  1x
-  1x
-  1x

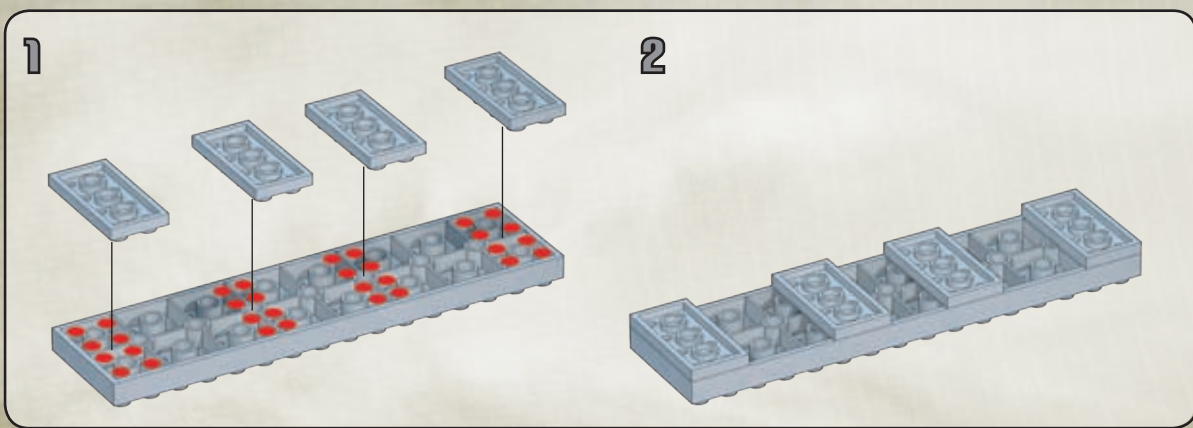
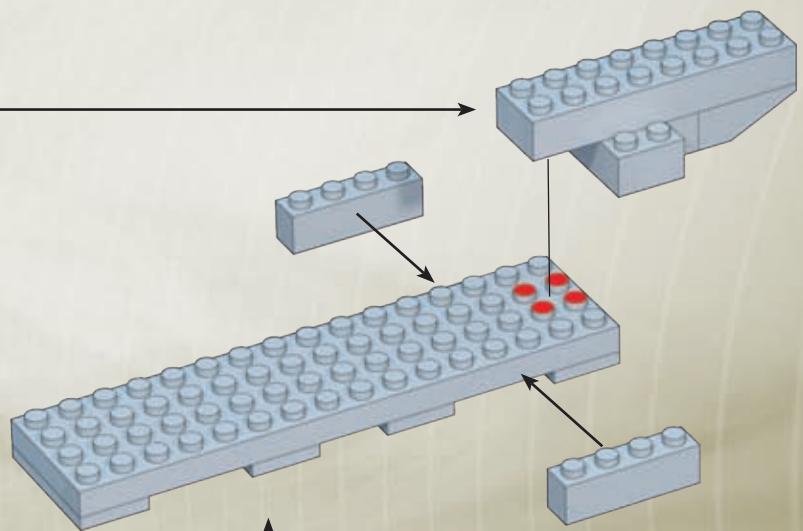
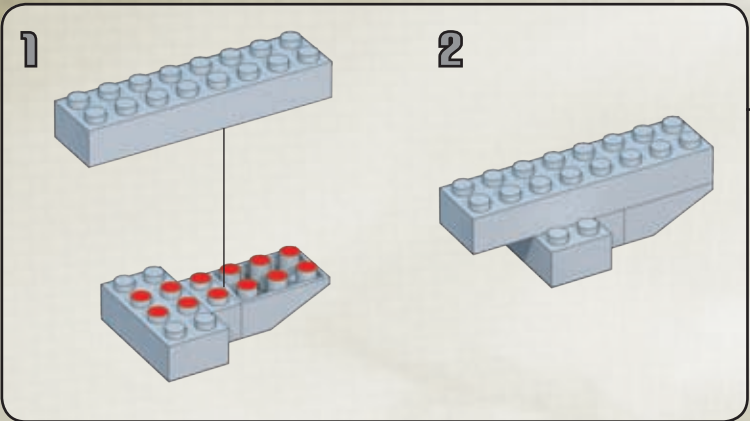

- A 2x 2x 2x
- B 1x 1x 1x

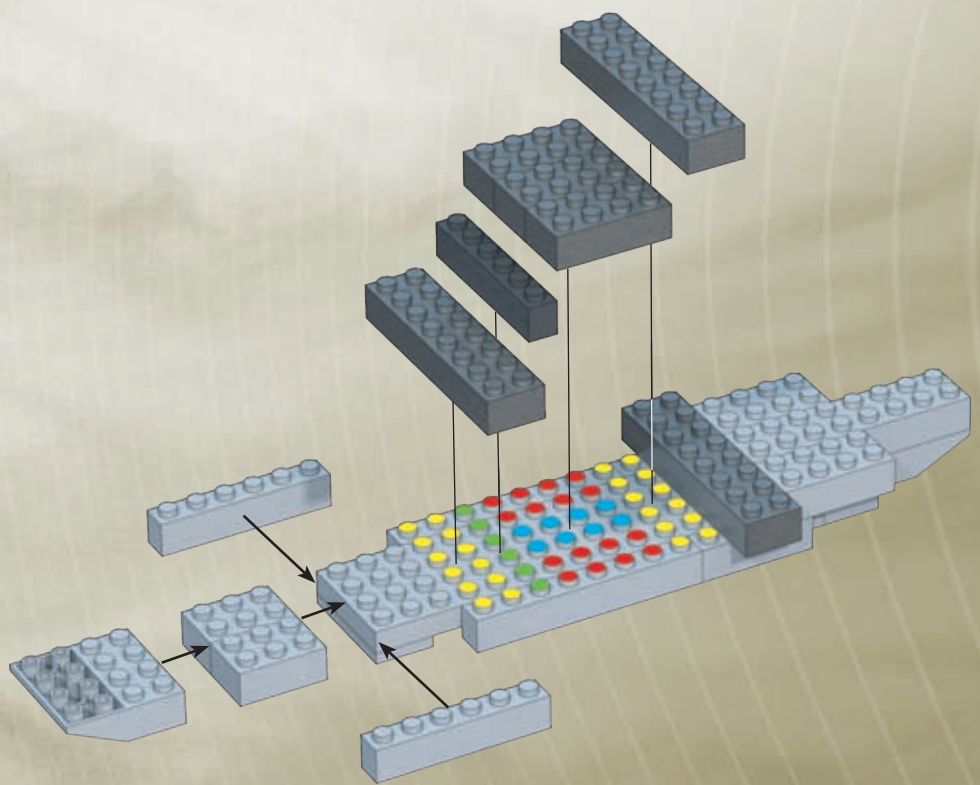
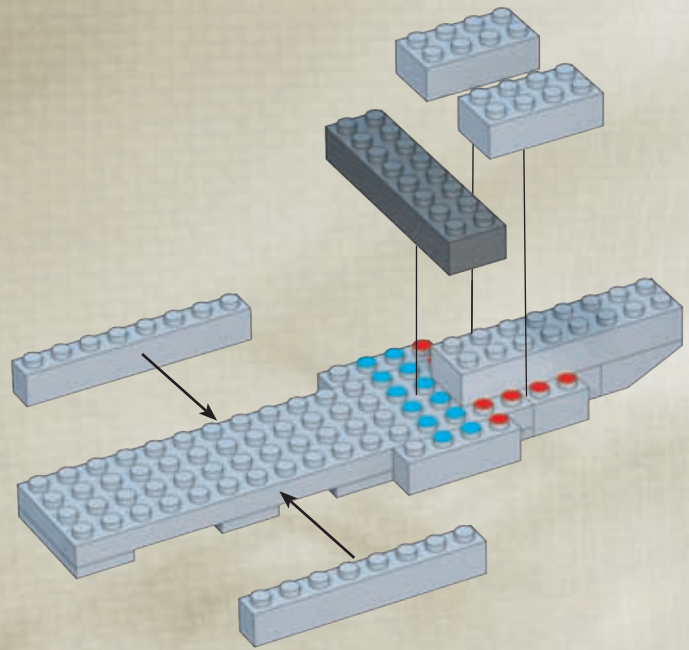

- A 2x 2x 1x 2x
- B 3x 2x
- C 1x

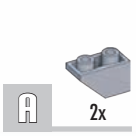
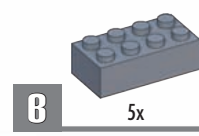
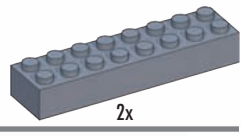
-  **A** 2x
-  **B** 5x
-  2x

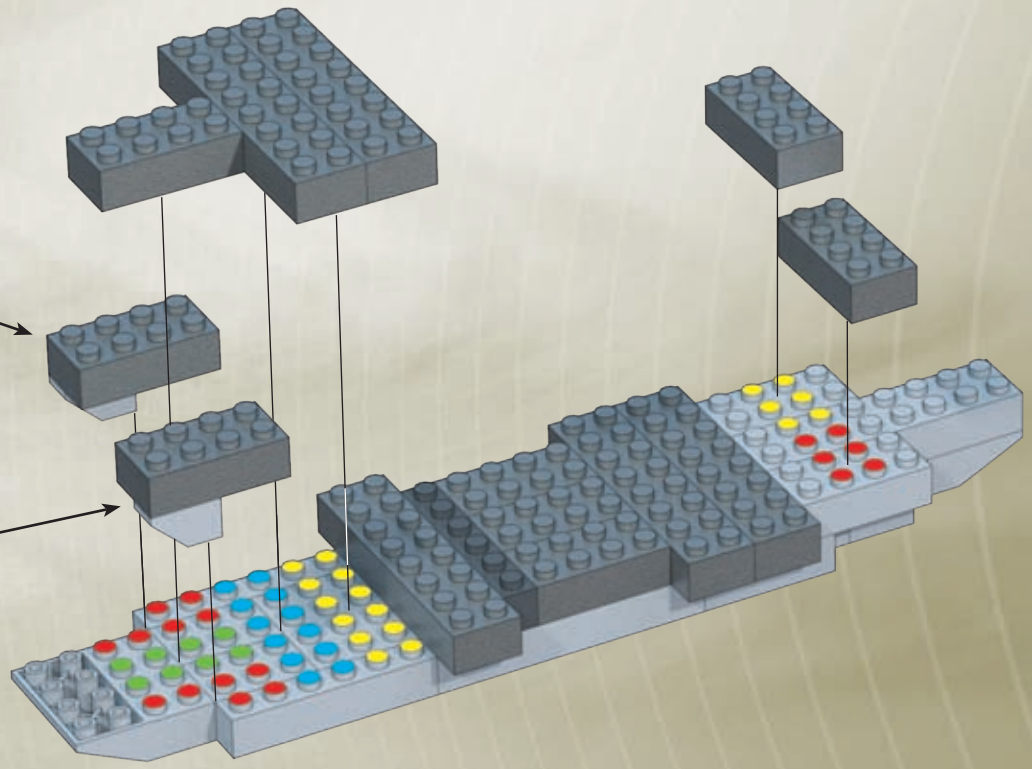
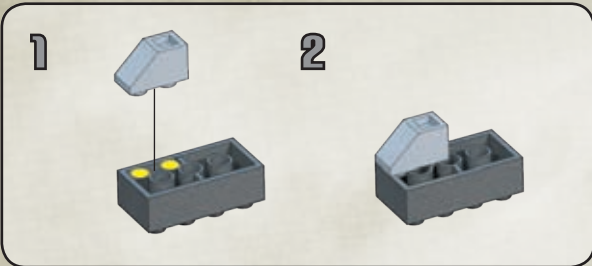

5

- A** 1x [grey 1x3 Technic brick]
- B** 4x [grey 1x4 Technic brick], 1x [grey 1x6 Technic brick]
- C** 2x [black 1x2 Technic brick], 1x [black 1x4 Technic brick], 1x [black 1x6 Technic brick]

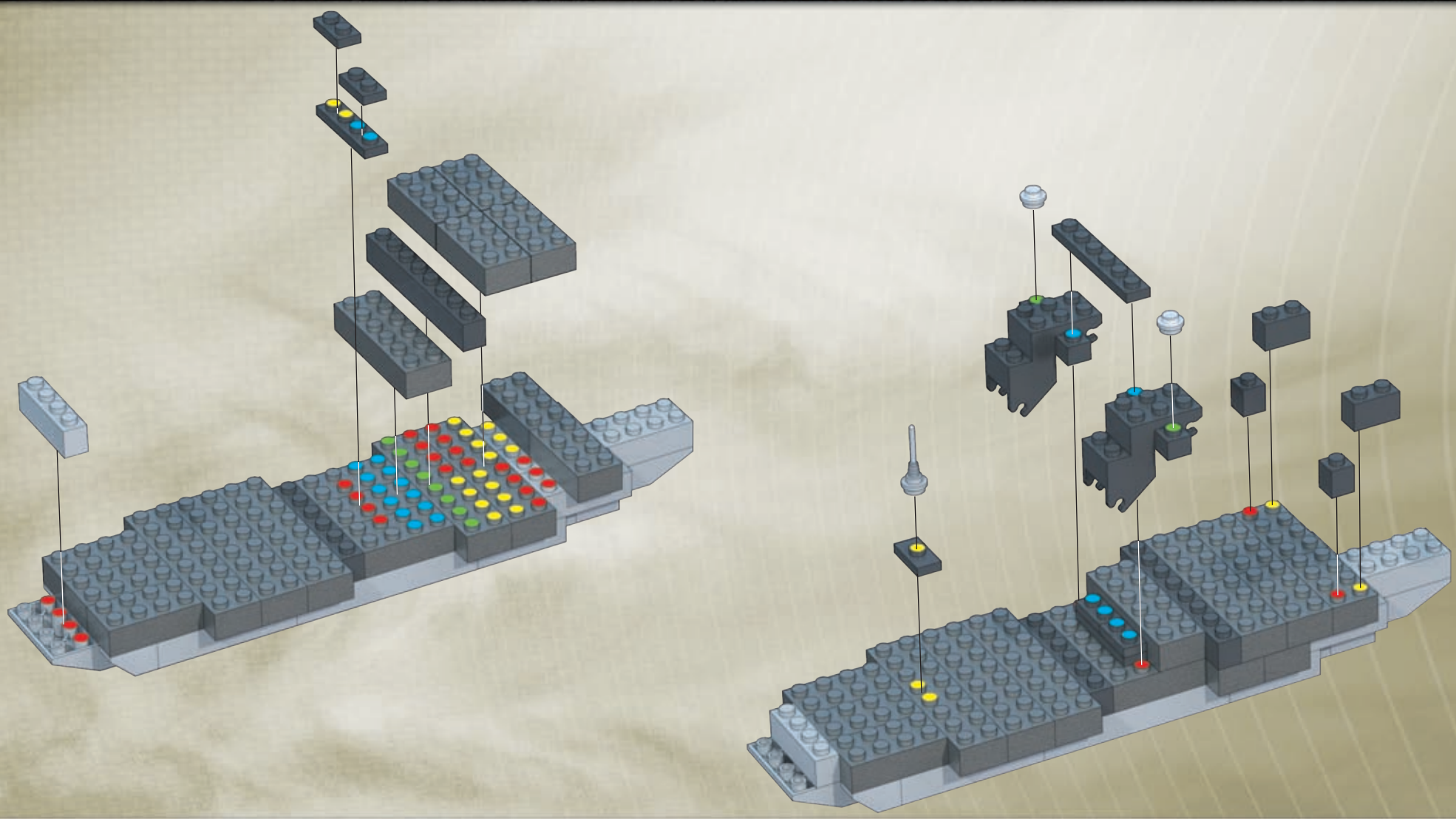

8

- A** 1x [grey 1x3 Technic brick]
- C** 2x [black 1x2 Technic brick], 1x [black 1x4 Technic brick], 2x [black 1x6 Technic brick], 1x [black 1x6 Technic brick], 2x [black 1x2 Technic brick]
- D** 2x [grey 1x3 Technic brick]

b



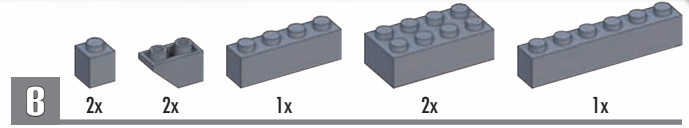
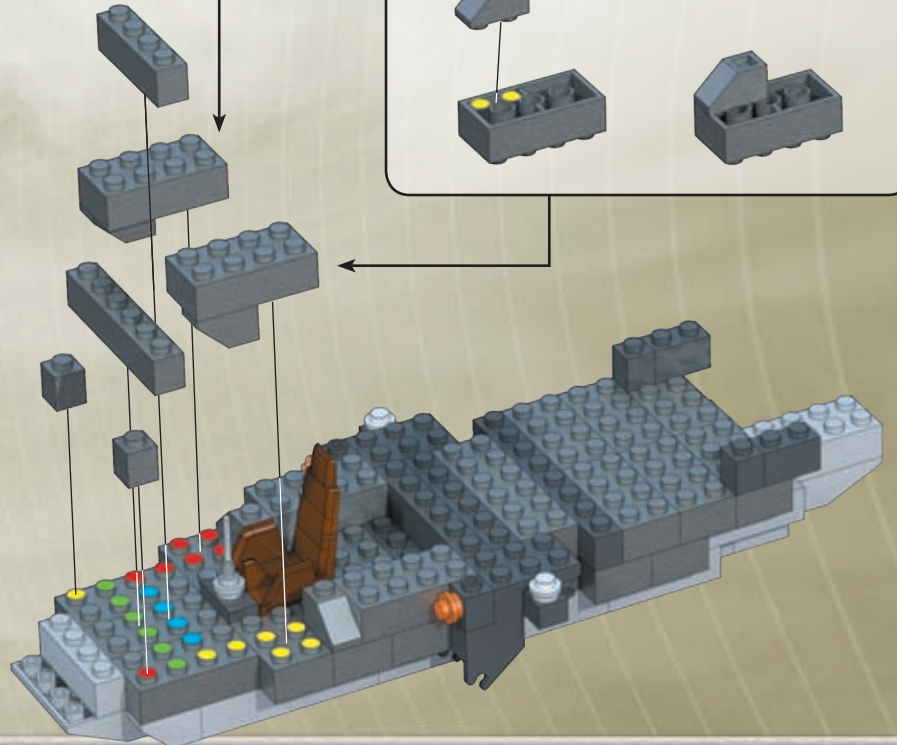
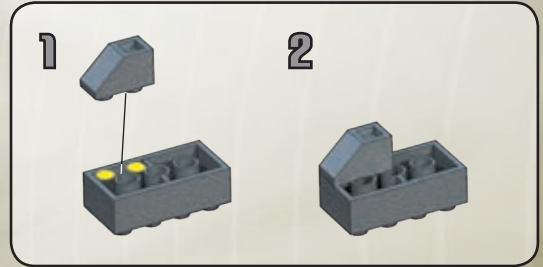
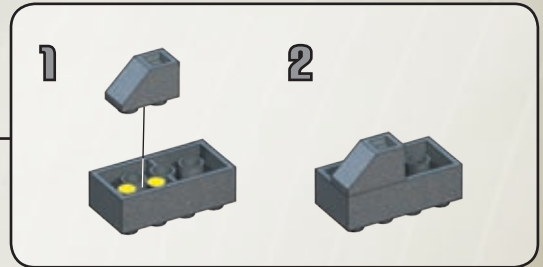
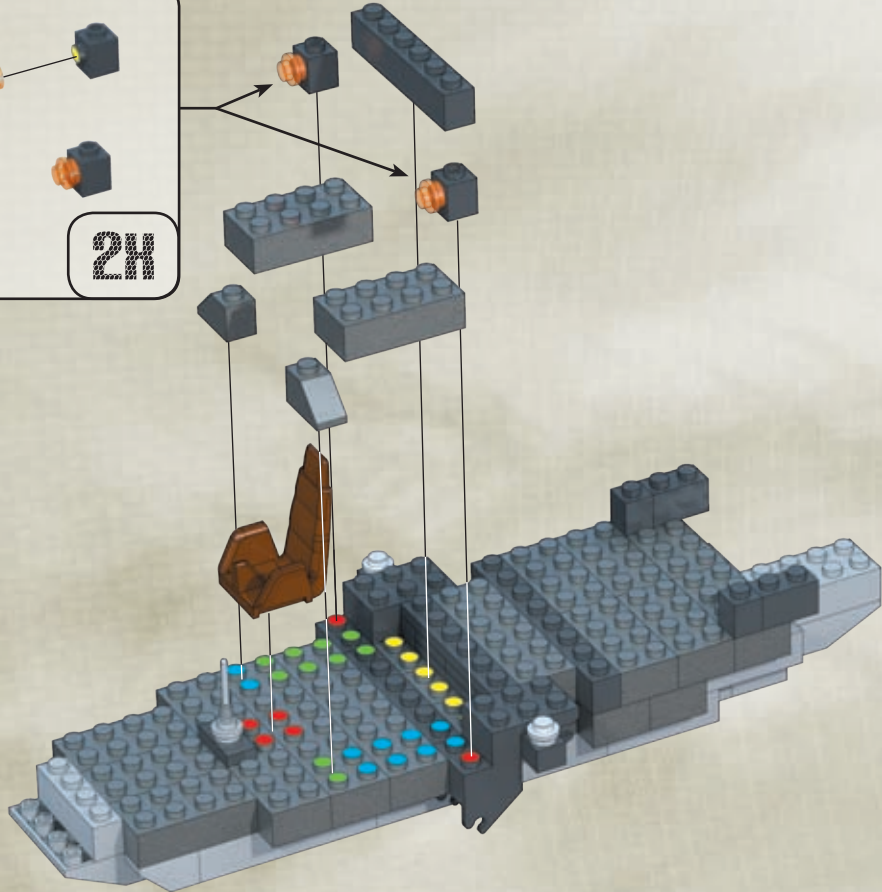
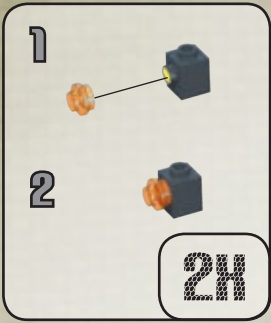
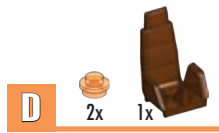
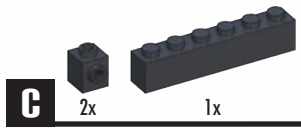
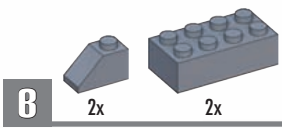

# 9

- A** 2x 3x 2x 1x 1x 1x    **B** 4x    **C** 2x 2x 1x

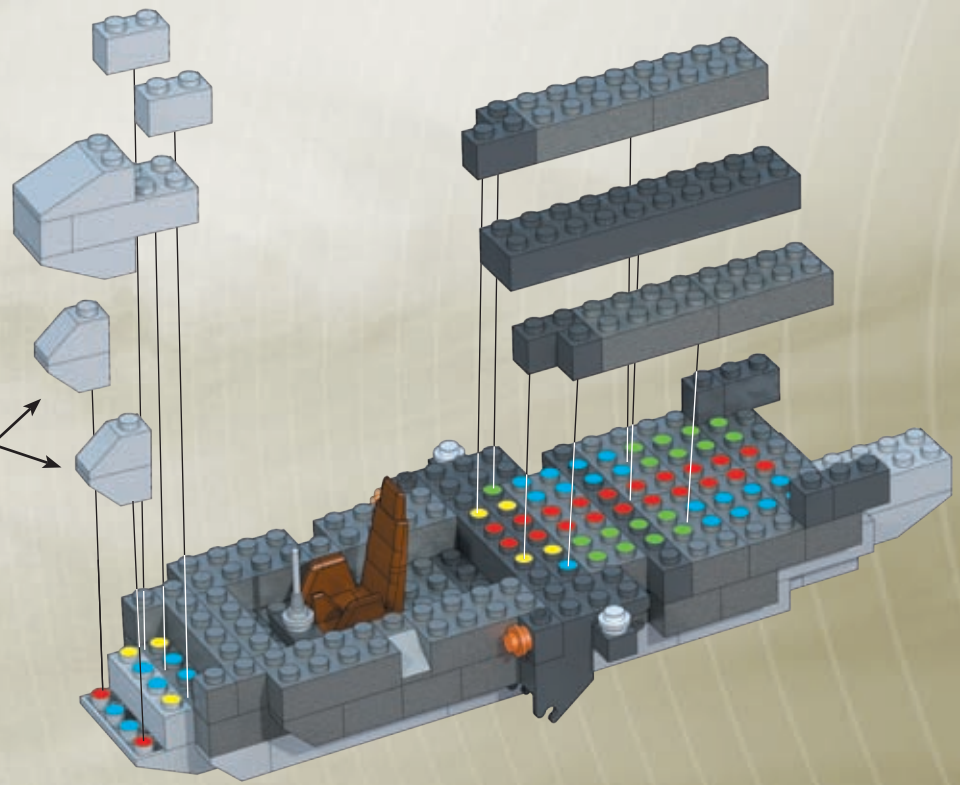
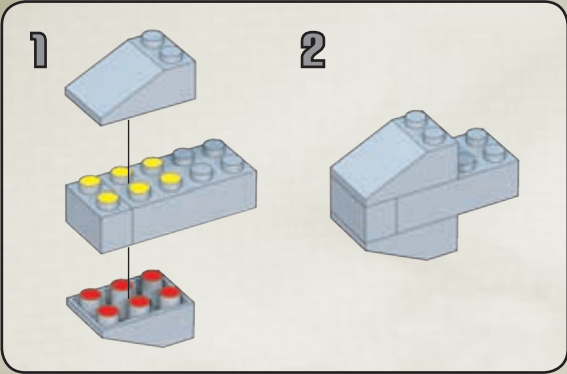

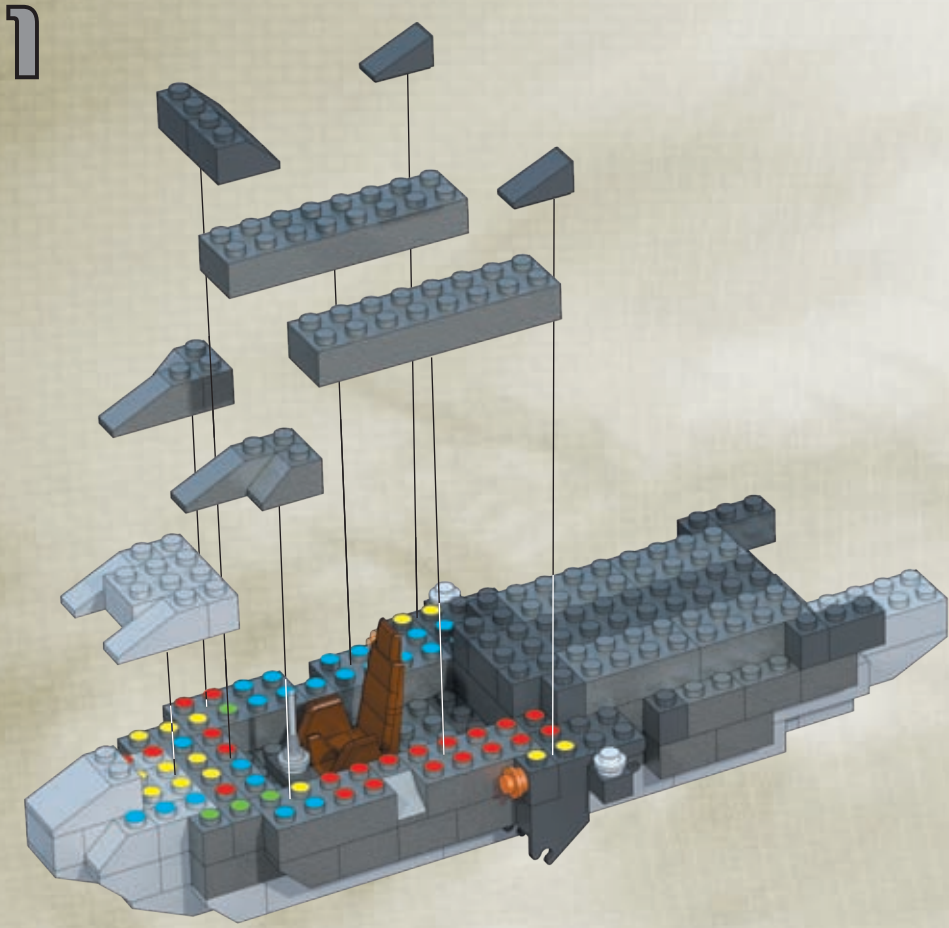
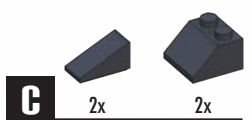
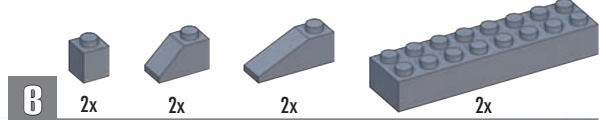
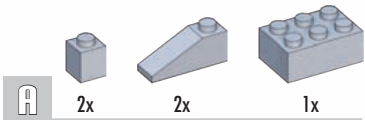

- A 2x
- 5x
- 1x
- 2x
- 2x
- 2x

1

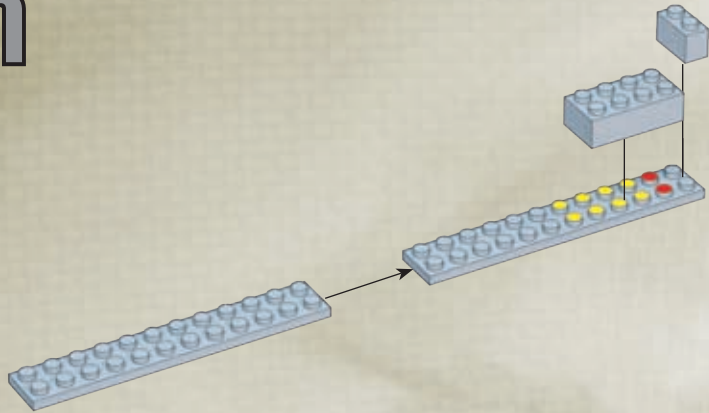

2

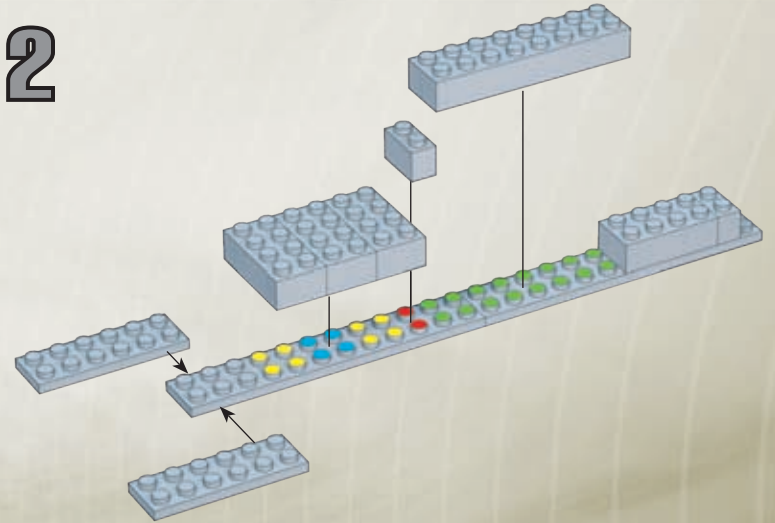

3

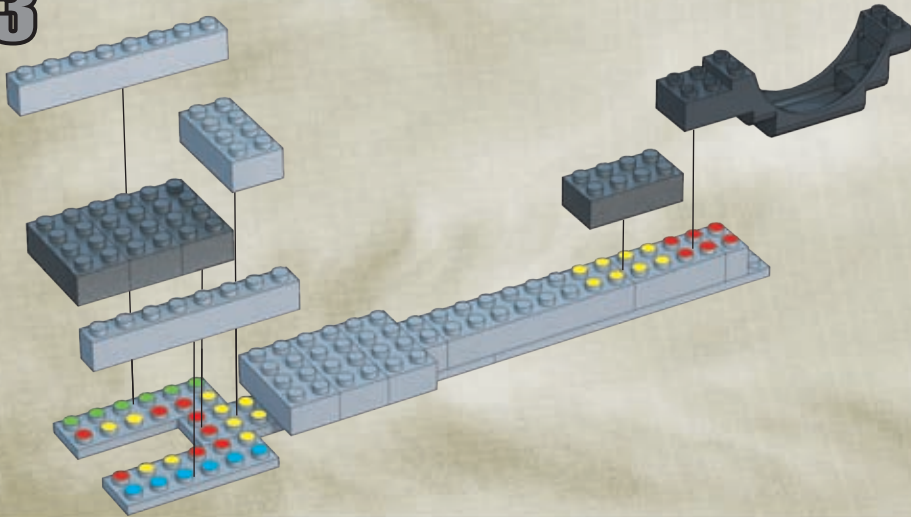

4

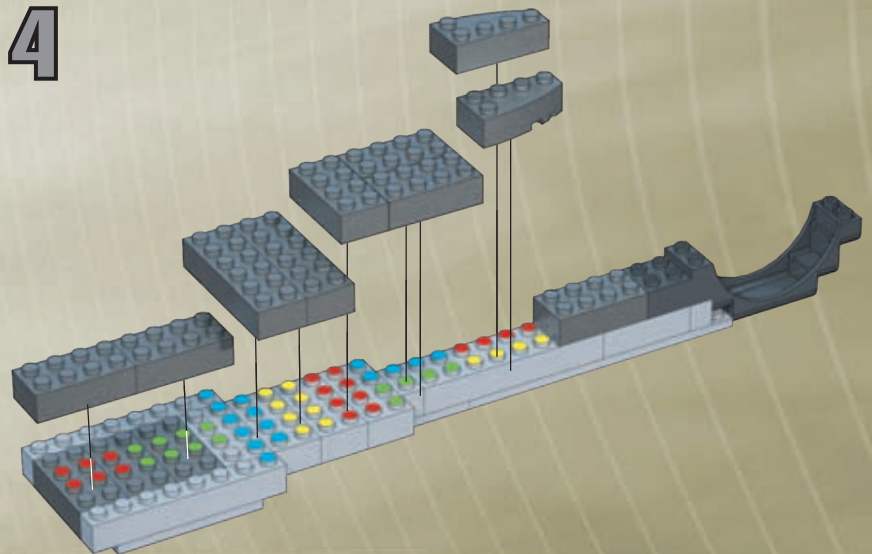

- B 1x
- 1x
- 9x
- 2x

- C 1x

- B** 2x 4x 12x 1x 1x 1x

- C** 2x 1x 1x

- D** 2x 2x

1

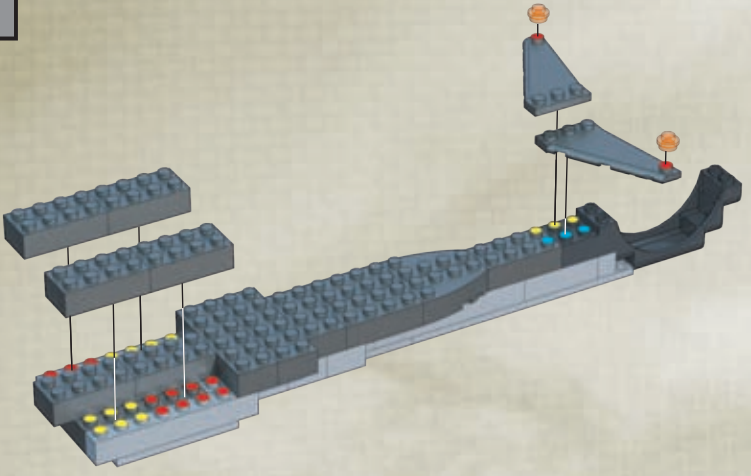

2

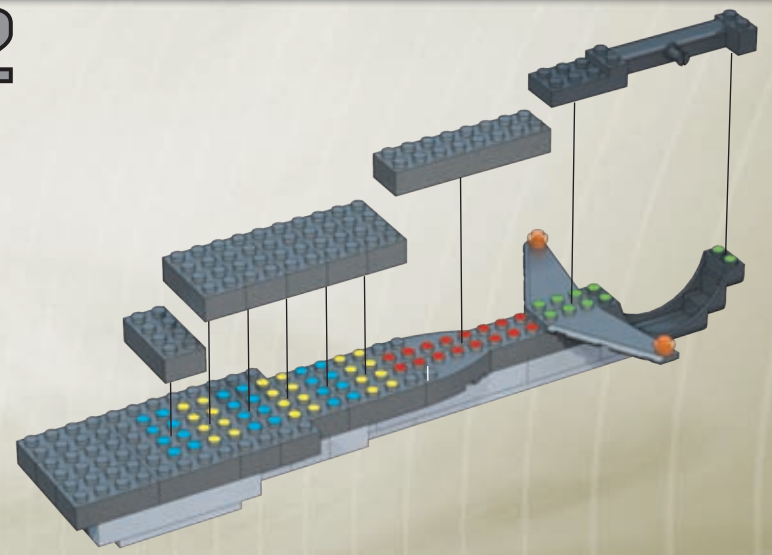

3

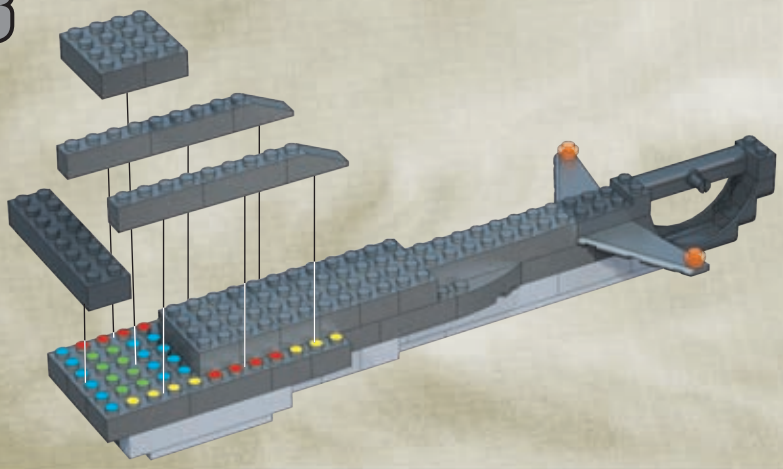

4

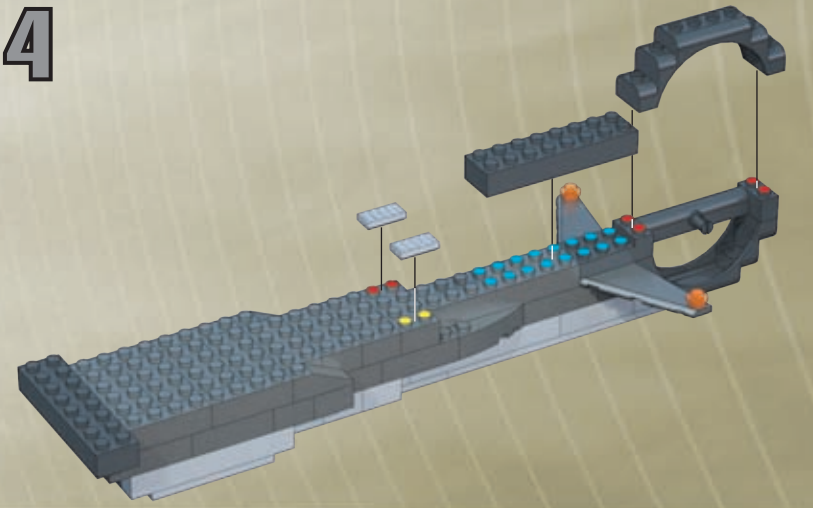

# 13

- B** 1x 2x 10x
- C** 2x 1x 2x 1x 1x 1x 5x 1x 1x
- D** 1x 1x 

1

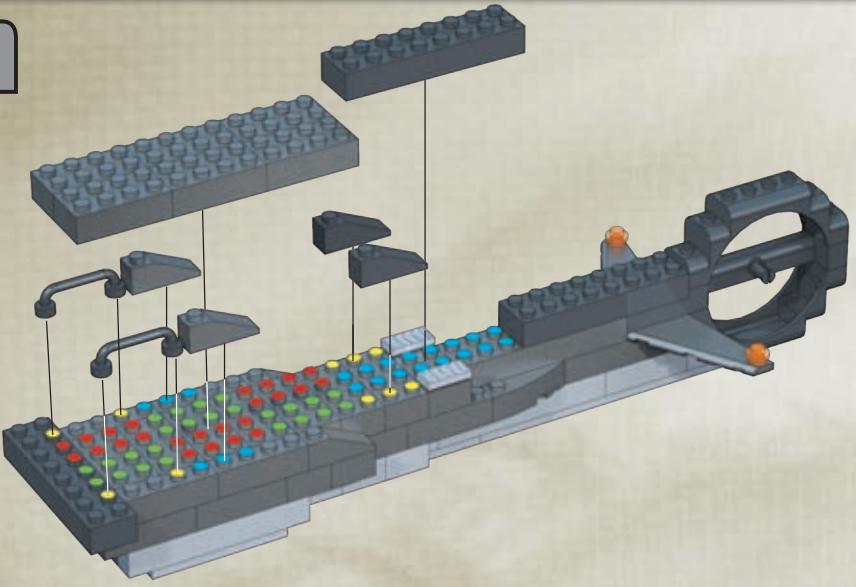

2

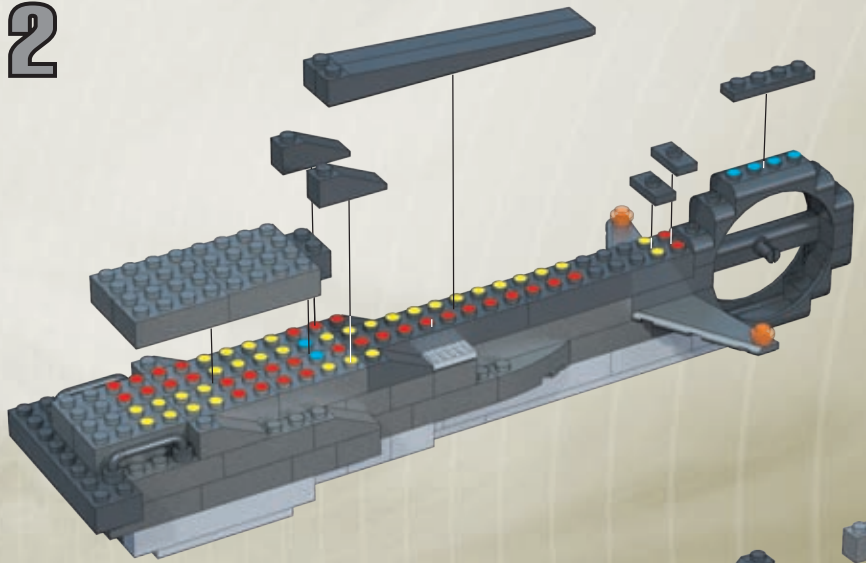

3

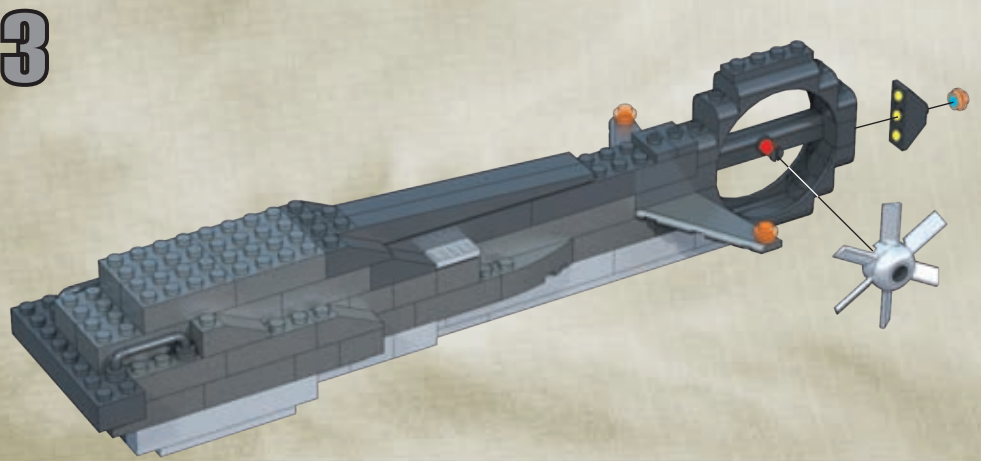

4

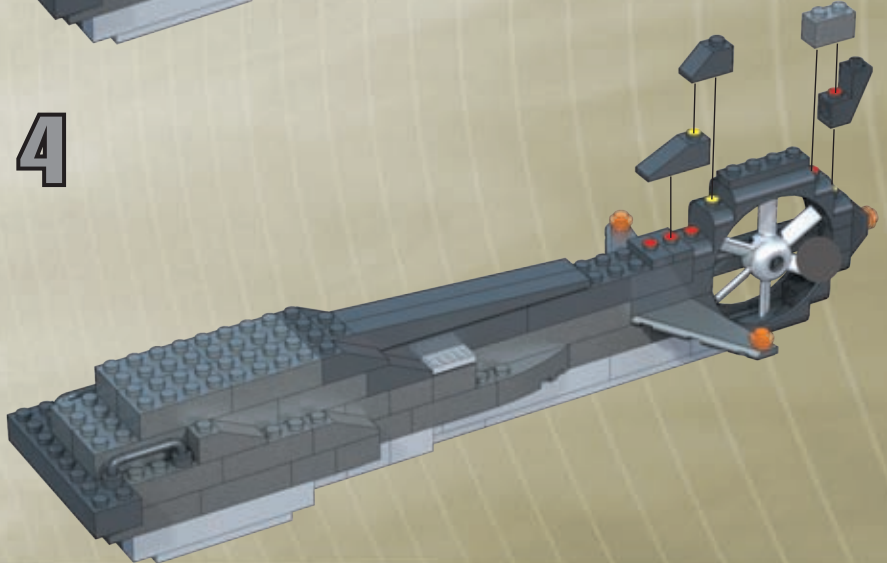

6 2x 4x

C 4x 2x

1

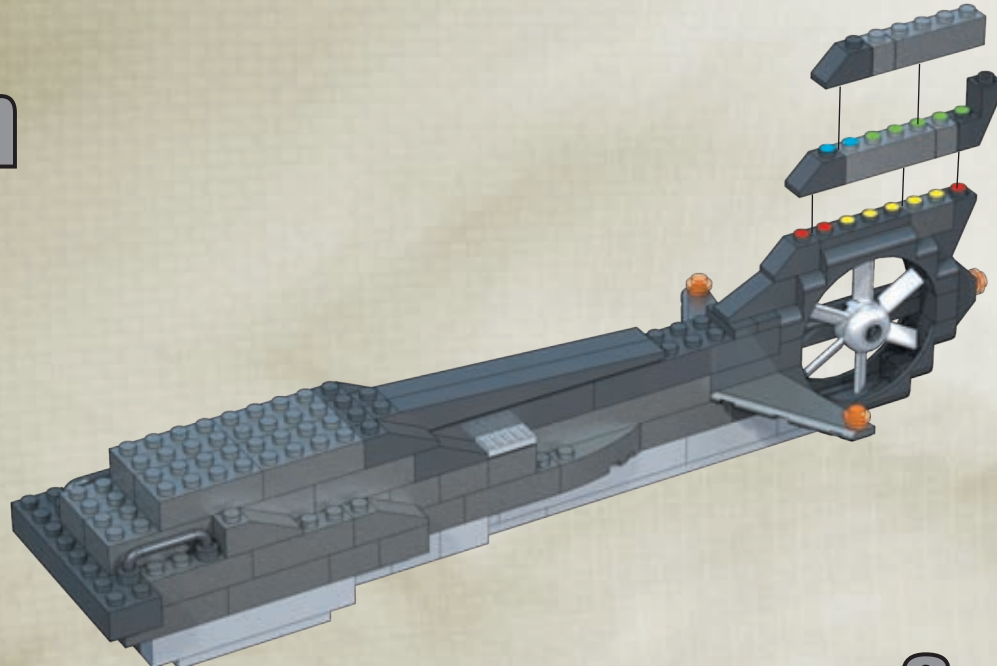

2



C 2x

D 1x

1



2

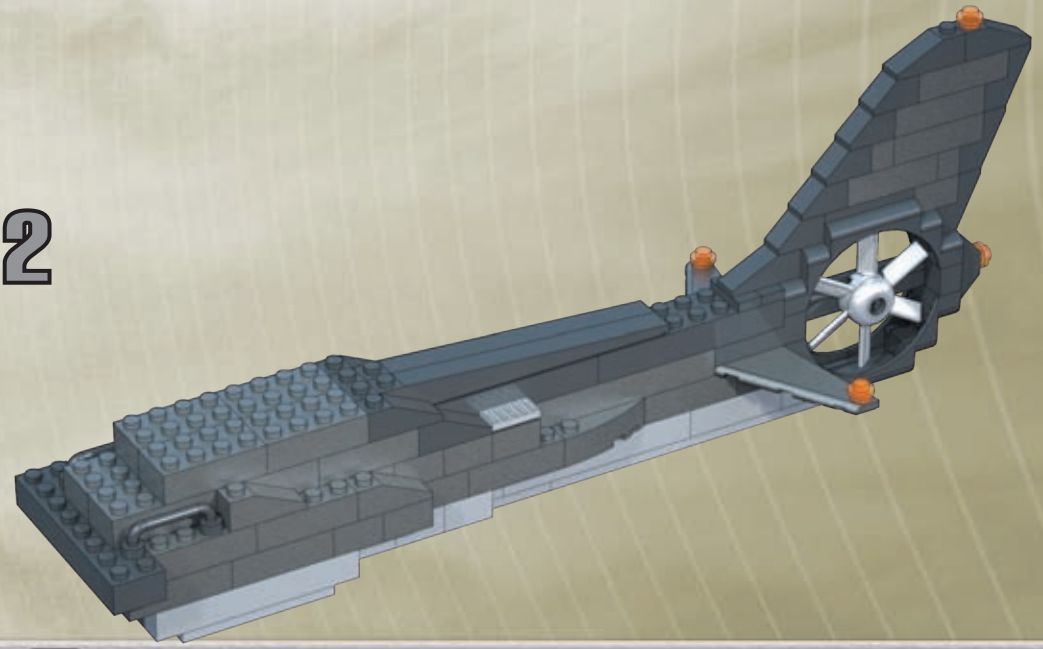



- D** 2x 1x 2x 1x

1

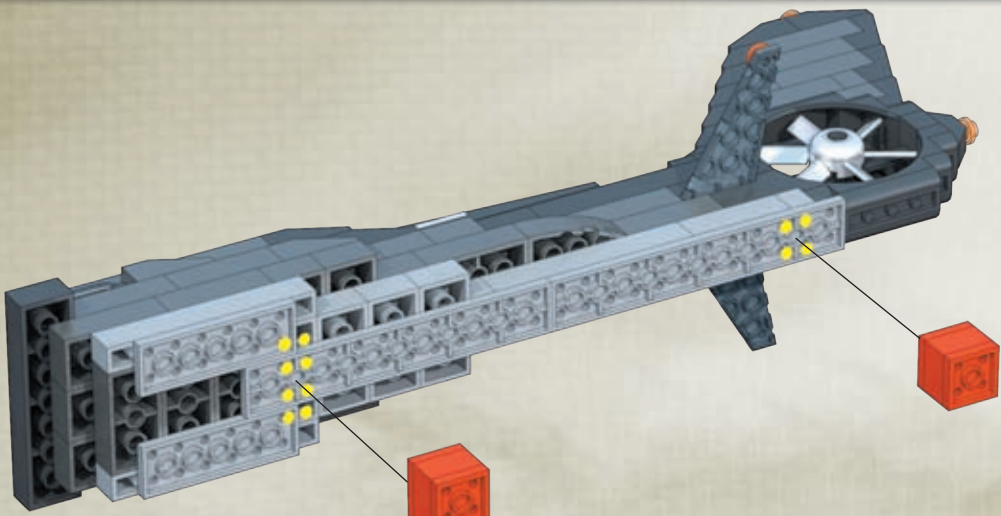

2

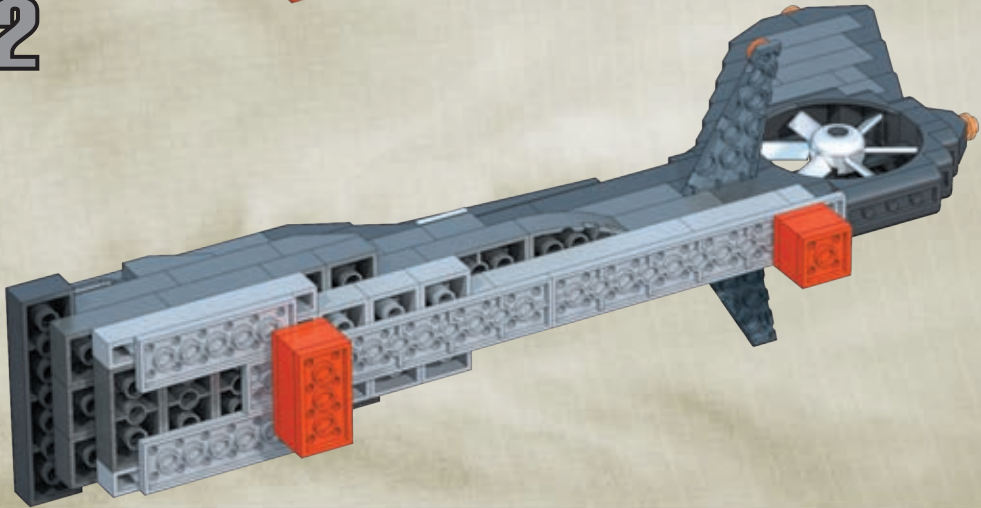

**1**

**2**

Place temporary pieces.  
Colocar las piezas provisionales.  
Installer les pièces temporaires.  
Provisorische Teile einsetzen.  
Instaleer de tijdelijke onderdelen.  
Piazzare i pezzi temporanei.  
Colocar peças temporárias.

**1**

**2**

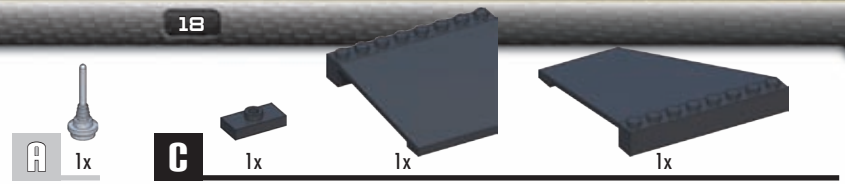
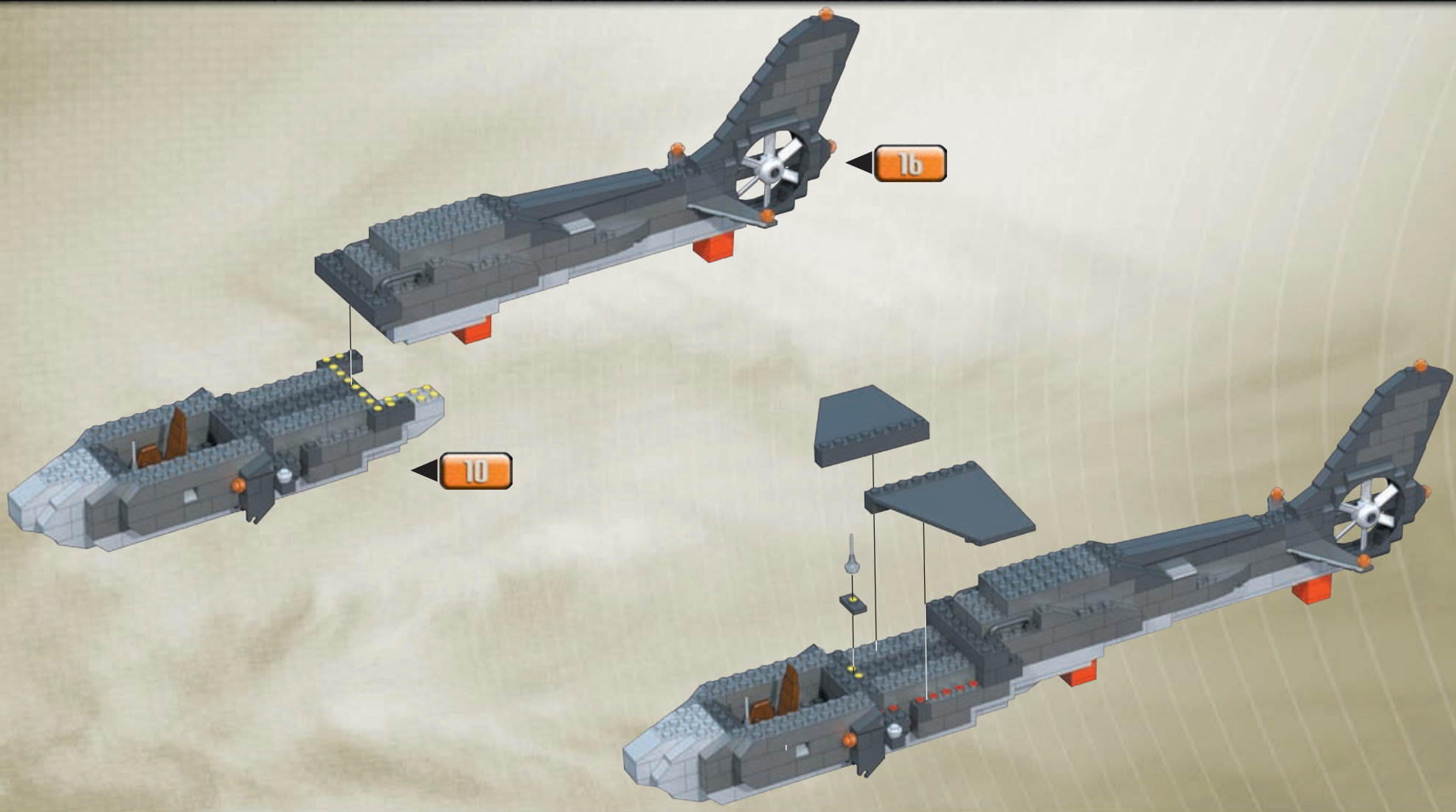

Place temporary pieces.  
Colocar las piezas provisionales.  
Installer les pièces temporaires.  
Provisorische Teile einsetzen.  
Instaleer de tijdelijke onderdelen.  
Piazzare i pezzi temporanei.  
Colocar peças temporárias.



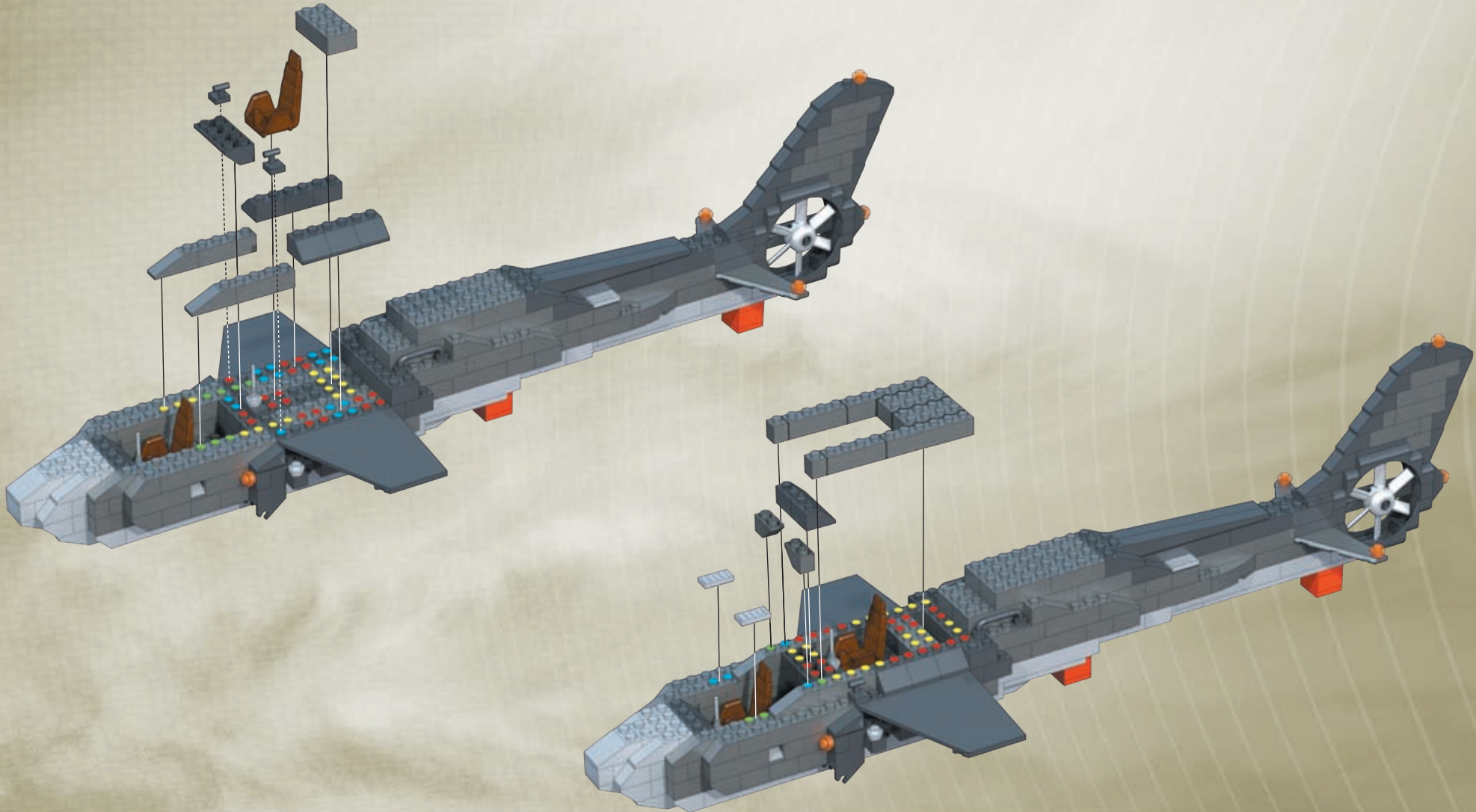





- B** 2x (grey wedge), 2x (grey 1x3), 1x (grey 1x4)
- C** 2x (grey 1x2 with hole), 2x (grey 1x2), 6x (grey 1x6)
- D** 1x (brown 1x2)

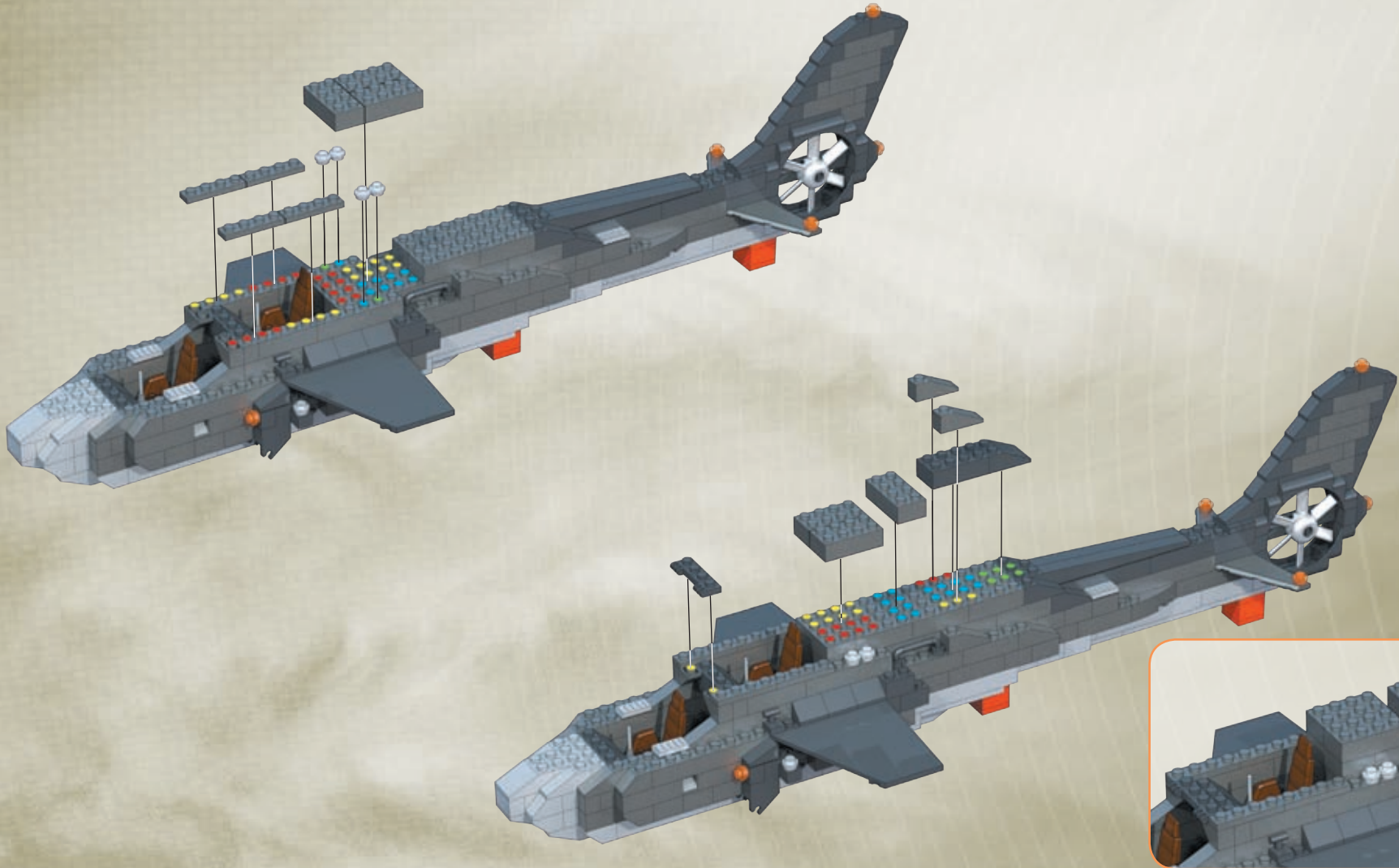

- B** 2x (grey 1x2), 2x (grey 1x2 with hole), 2x (grey 1x3), 2x (grey 1x4), 2x (grey 1x6)
- C** 2x (grey 1x2 with hole)
- D** 2x (grey 1x2)

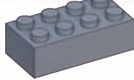
- B** 4x  3x 
- D** 4x 



- B** 2x  3x 
- C** 1x  1x  1x 

- A 3x
- C 4x
- 6x
- 1x
- 1x
- 6x
- 6x
- 1x
- 1x
- 2x

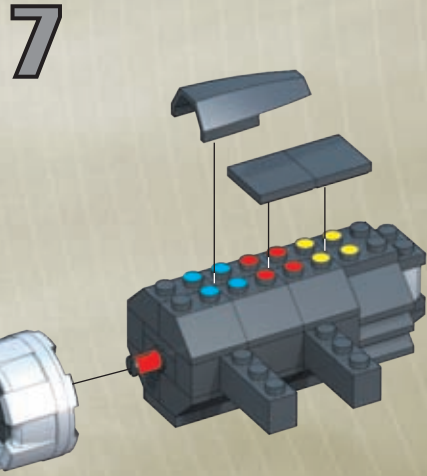
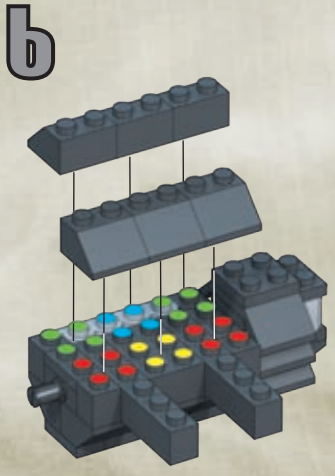
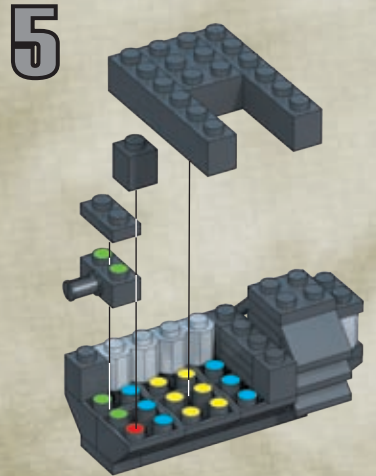
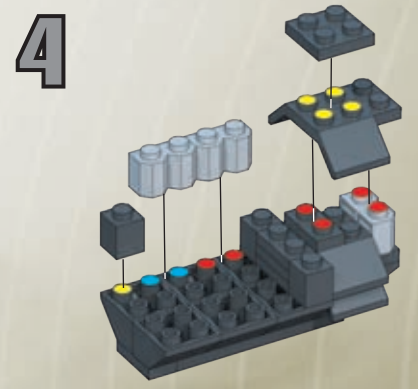
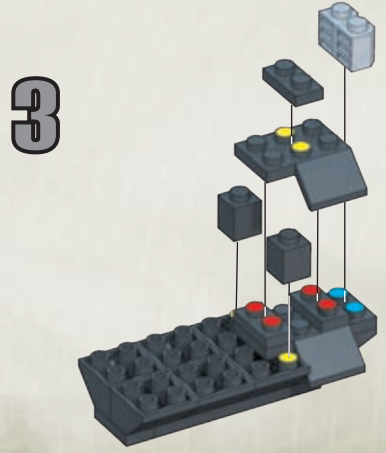
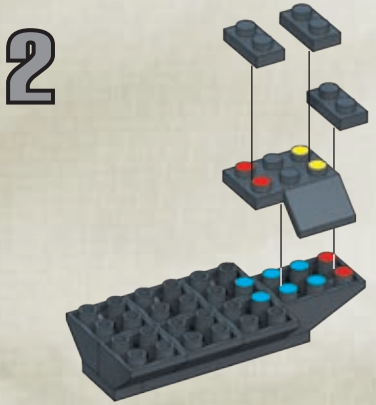
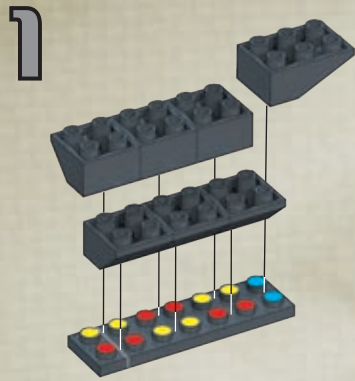

- C 3x
- 1x
- 1x
- 2x
- D 1x

- A 3x
- C 4x
- 6x
- 1x
- 1x
- 6x
- 6x
- 1x
- 1x
- 2x

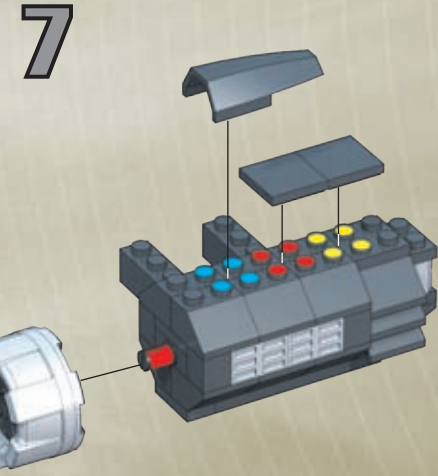
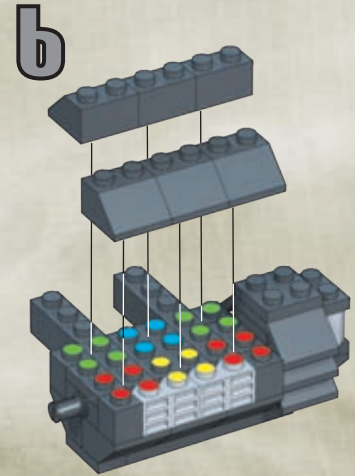
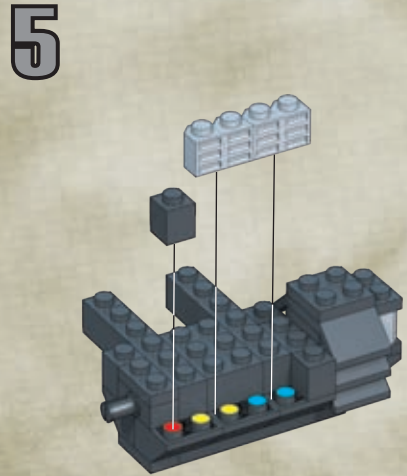
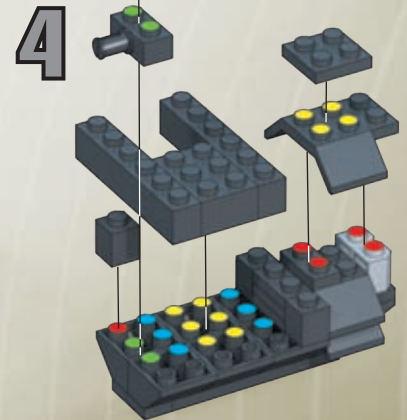
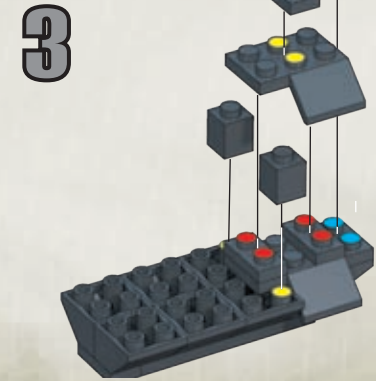
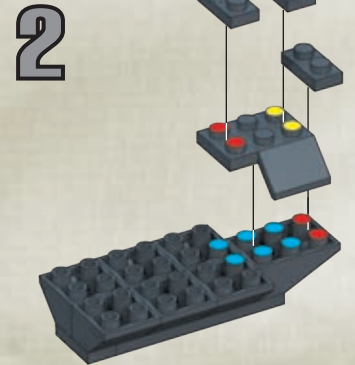
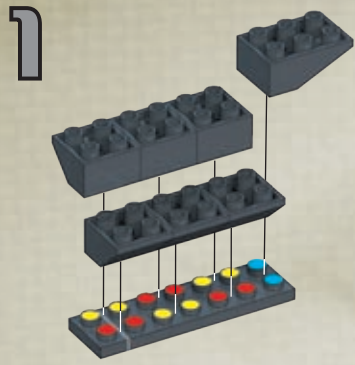

- C 3x
- 1x
- 1x
- 2x
- D 1x

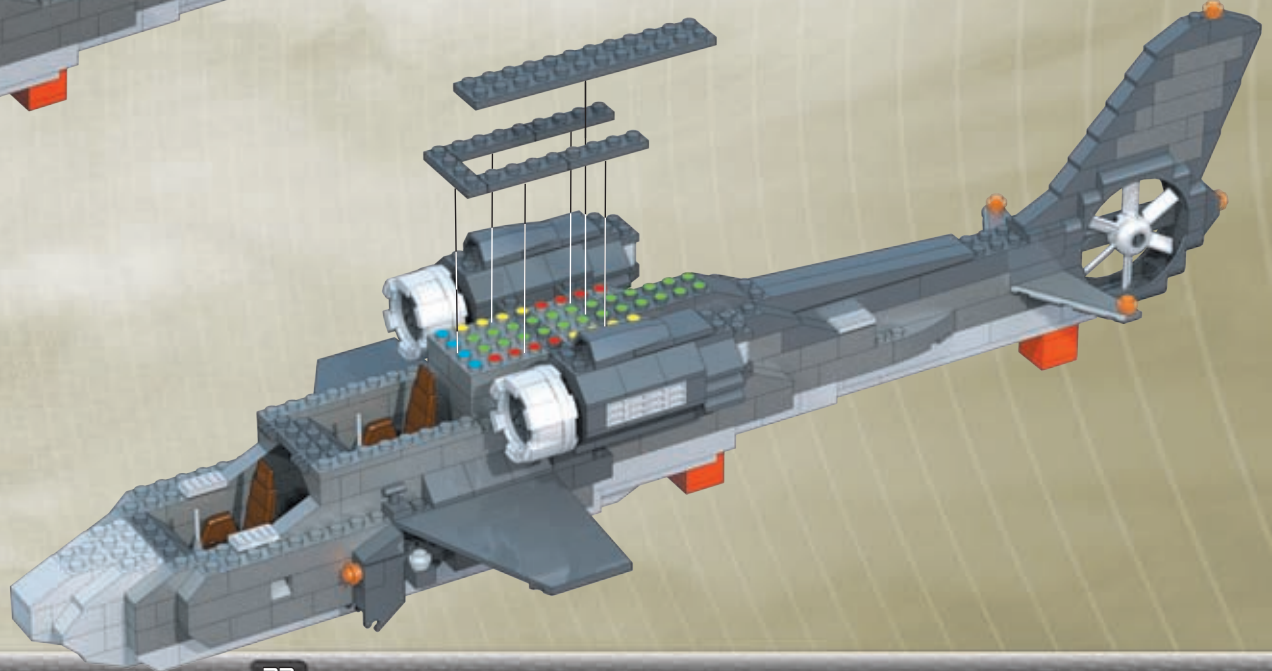
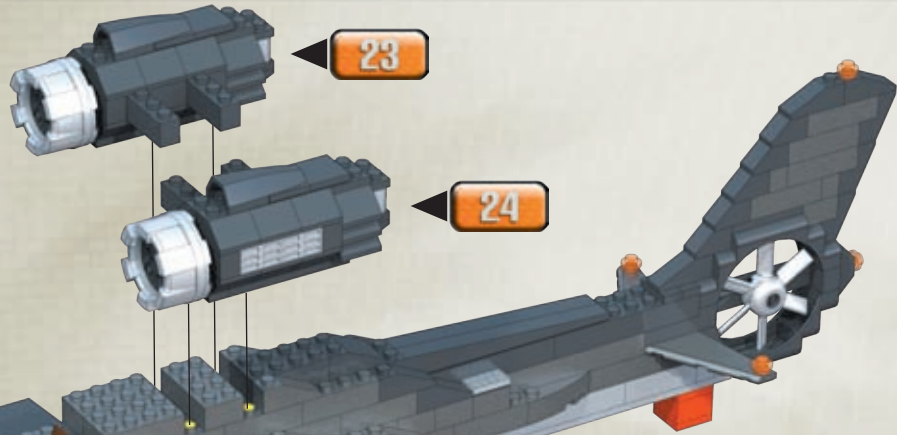
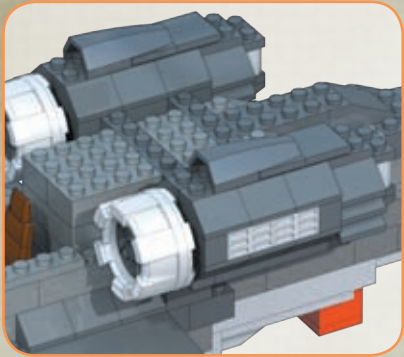

- B** 1x [1x 1x 3x grey brick]
- C** 2x [1x 1x 1x dark grey wedge], 1x [1x 1x 1x dark grey brick], 2x [1x 1x 2x dark grey wedge], 4x [1x 1x 1x 1x dark grey brick], 1x [1x 1x 1x 1x 1x dark grey long brick with hole], 1x [1x 1x 2x dark grey wedge]



- A** 1x [1x 1x 1x 1x 1x grey brick]
- C** 2x [1x 1x 1x dark grey wedge], 2x [1x 1x 2x dark grey brick]



29

- A 2x
- B 8x
- C 1x 2x 1x

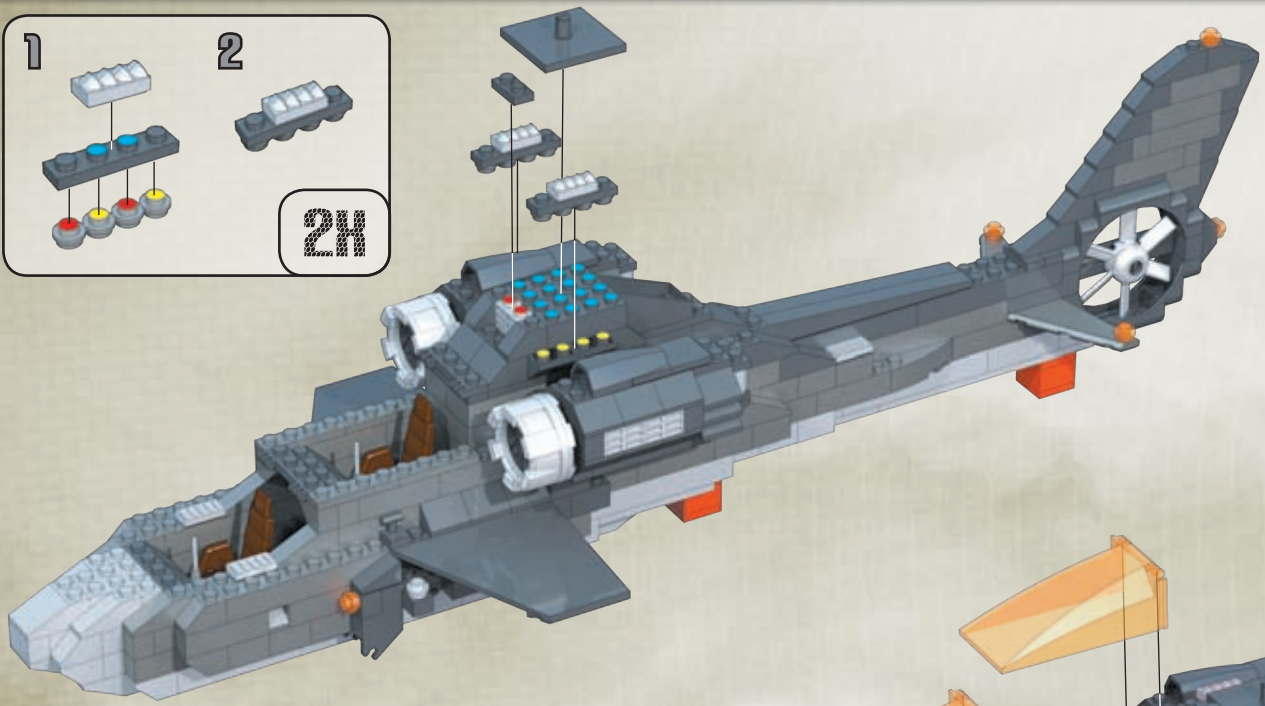
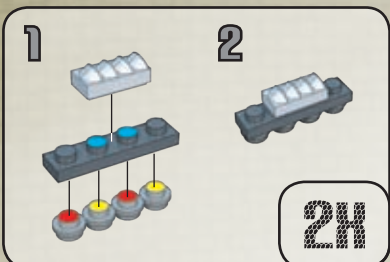

25

- D 2x

30

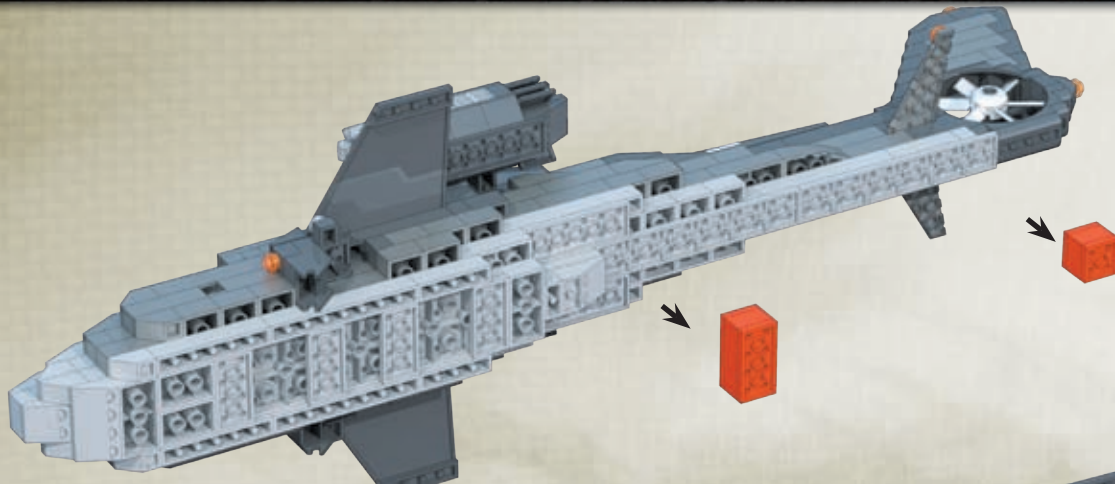

Remove temporary pieces.  
 Retirar las piezas provisionales.  
 Enlever les pièces temporaires.  
 Provisorische Teile entfernen.  
 Verwijder de tijdelijke onderdelen.  
 Rimuovere i pezzi temporanei.  
 Retirar peças temporárias.

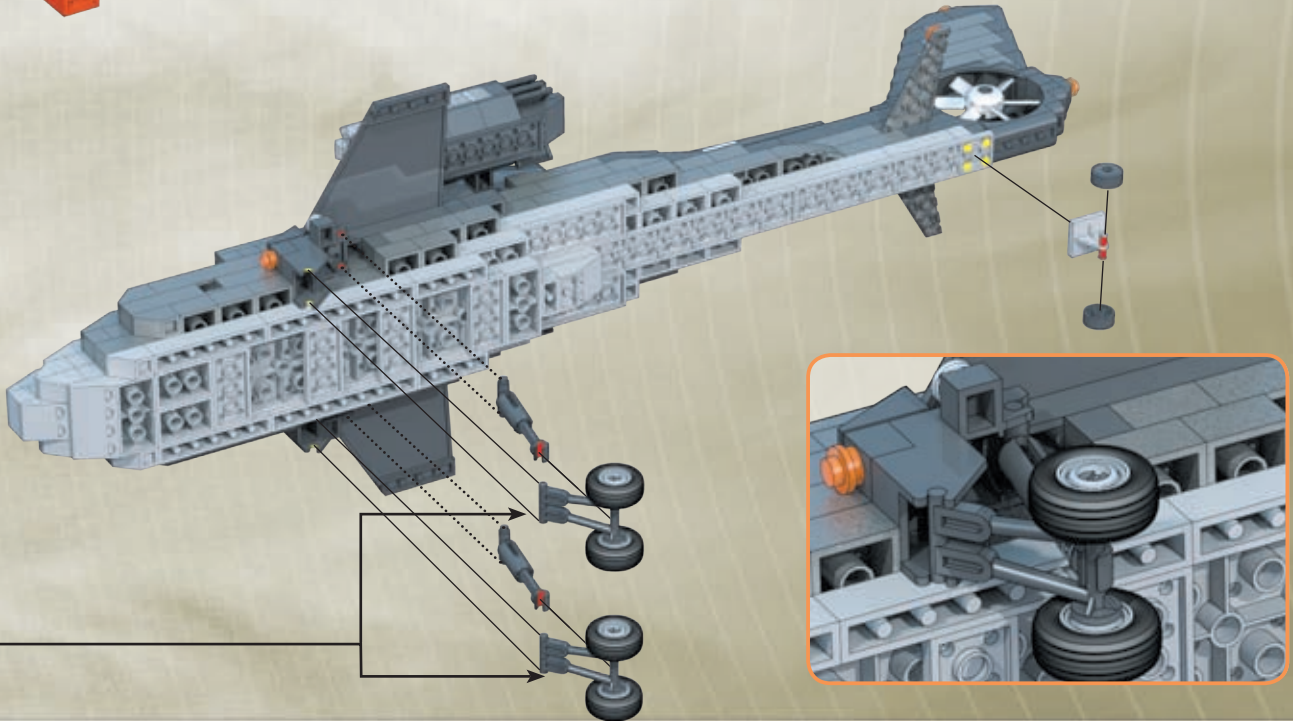
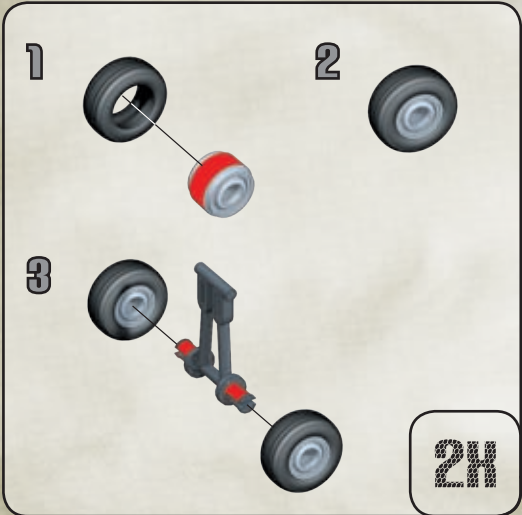

- A
- 4x
- 1x
- C
- 2x
- 2x
- D
- 4x
- 2x

C

2x

2x

1

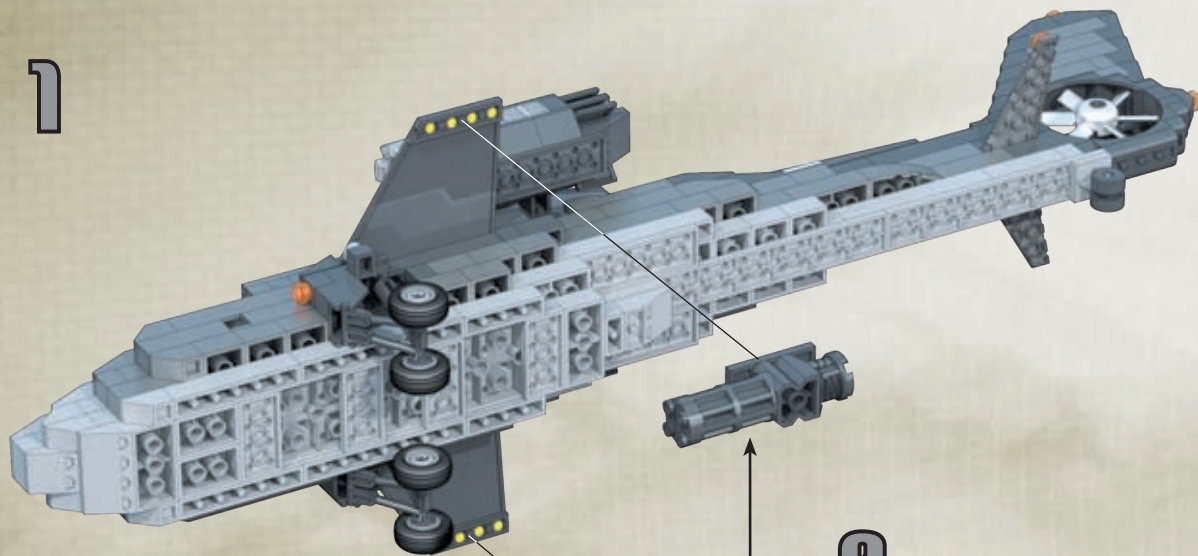

2

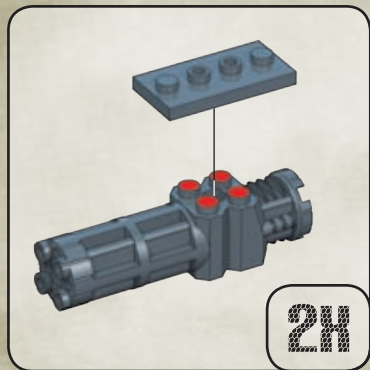
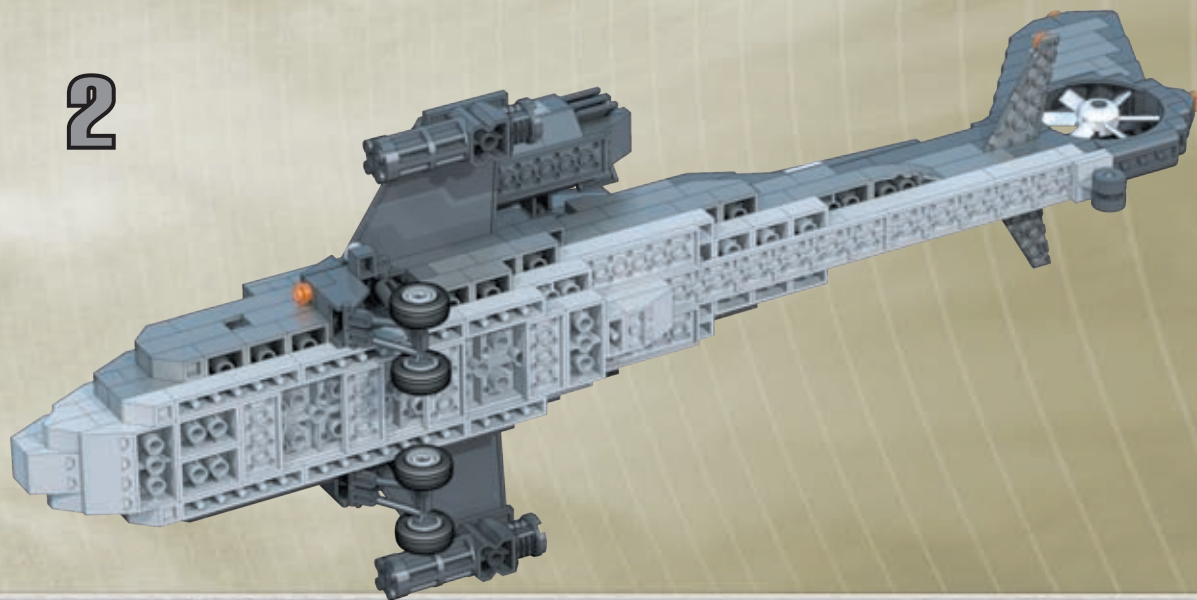

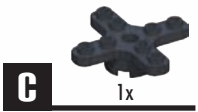

1

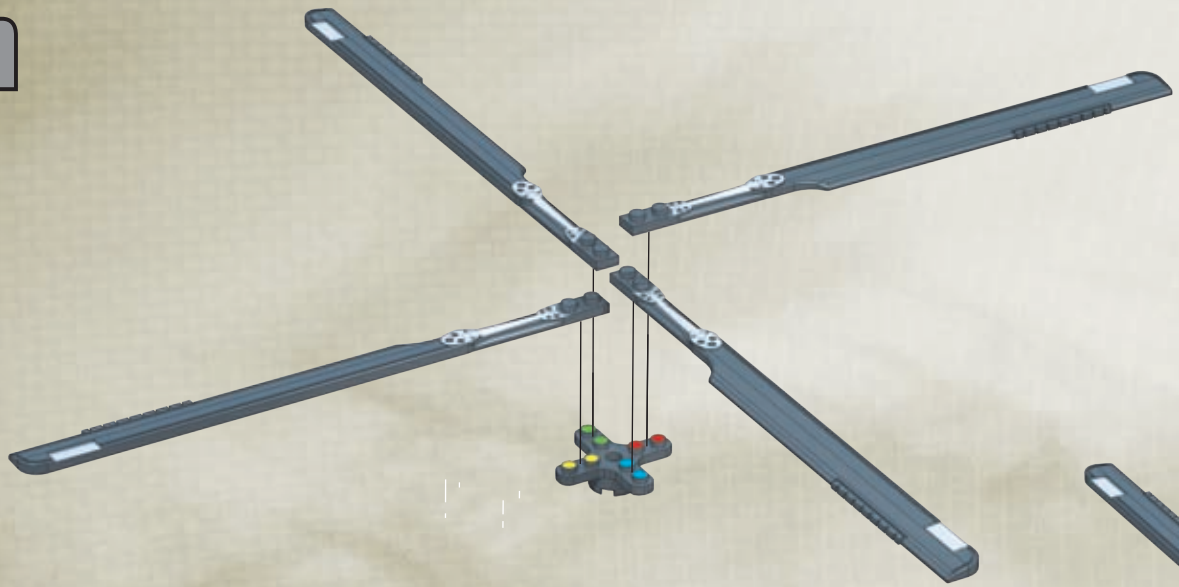

2

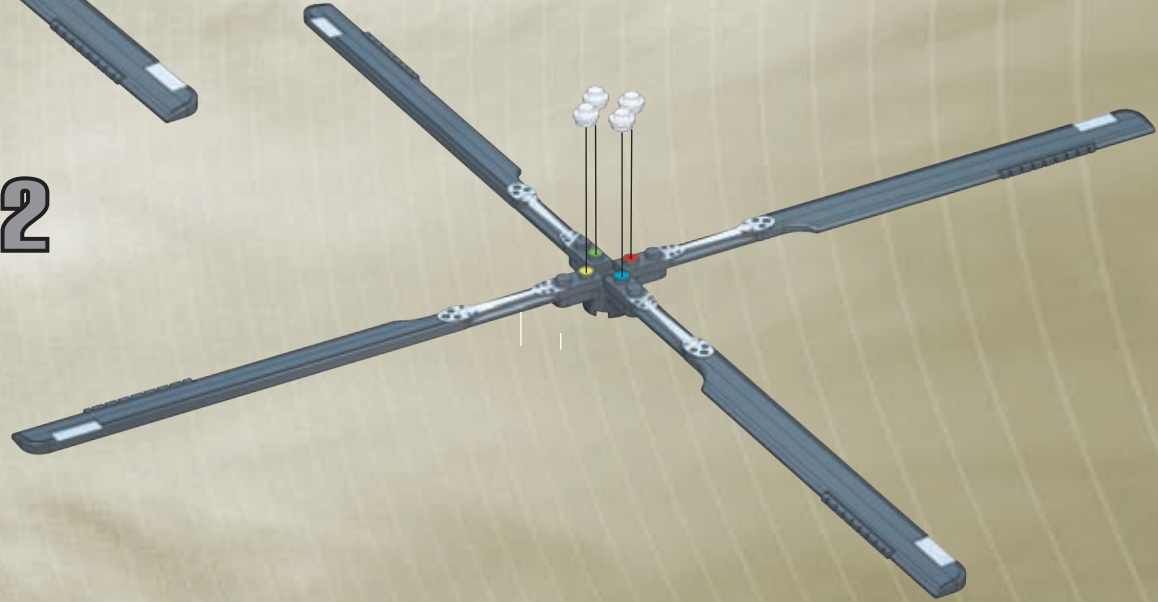

35

C 1x

1

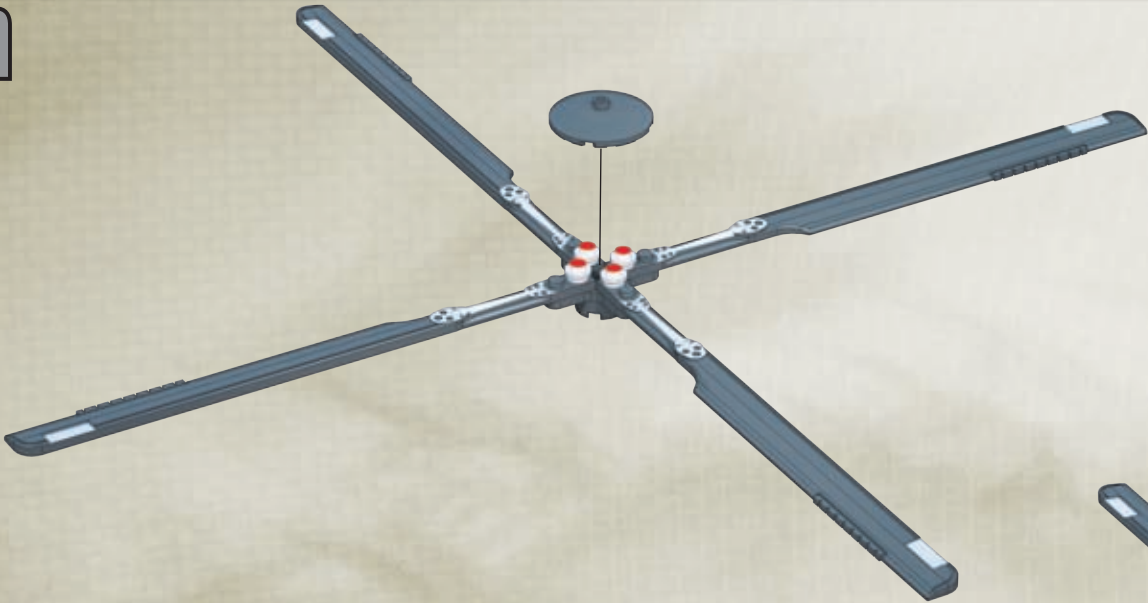

2







3271



# Probuilder



Carbon Series™

Assault Chopper

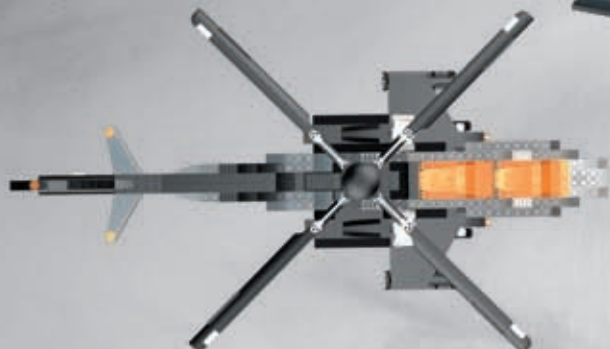

28 in • 71 cm



4.1 in • 10.4 cm



8.4 in • 21.3 cm



Ultimate collection!  
 ¡Una colección indispensable!  
 Collection ultime !  
 Die ultimative Sammlung!  
 Ultieme verzameling!  
 La collezione all'ultimo grido!  
 Uma coleção a não perder!



3274



3275



3268



3269



3272



3263

© 2009, MEGA Brands Inc.  
 MEGA Brands Inc. und das MEGA Brands Inc.-Logo sind eingetragene Warenzeichen von MEGA Brands Inc.  
 MEGA Brands Inc. and the MEGA Brands Inc. logo are registered trademarks of MEGA Brands Inc.  
 MEGA Brands Inc. y el logotipo MEGA Brands Inc. son marcas registradas de MEGA Brands Inc.  
 MEGA Brands Inc. et le logo de MEGA Brands Inc. sont des marques de commerce déposées de MEGA Brands Inc.  
 MEGA Brands Inc. en het MEGA Brands Inc. logo zijn gedeponeerde handelsmerken van MEGA Brands Inc.  
 MEGA Brands Inc. ed il logo di MEGA Brands Inc. sono marchi di fabbrica di MEGA Brands Inc.  
 MEGA Brands Inc. e o logo MEGA Brands Inc. são marcas registradas de MEGA Brands Inc.  
 Printed in Canada D032711A

