

NEO SHIFTERS™

6315

6+

115 PCS™



¡Luzes y sonidos electrónicos!
Lumieres et sons électroniques!
Elektronische lichter und geräusche!
Elektronische lichtenen geluiden!
Luci e suoni elettroniche!
Luzes e sons electronicos!



33
HYDRAX :: ENERGY BASE™



8x
AM0113MM

5x
AM0910KH

1x
AM15285NJ

6x
AM01793ZL

2x
AM09393LZ

12x
AS0631519

2x
AM15060NJ

2x
AM09755KJ

2x
AM09877MM

2x
AM15226NJ

2x
AM15304F

4x
AM09765TY

1x
AM15243MM

1x
AM15048NJ

2x
AM15037F

2x
AS063158

1x
AS0631518

1x
AM09738MM

2x
AM09731TY

1x
AS0631516

1x
AS0631513

1x
AS0631515

2x
AS063157

4x
AS0631511

16x
AX063154KH

2x
AX063153ZL

4x
AM09238MM

1x
AM15027LZ

1x
AM15027LZ

2x
AM15312ZL

1x
AS0631517

2x
AM15057KJ

2x
AS0631512

1x
AS063151

4x
AS063152

1x
AS0631525

1x
AS0631522

1x
AS063153

1x
AS0631531

2x
AS063154

1x
AS0631520

2x
AM15039KH

1x
AS0631530

2x
AS0631510

2x
AS0631510

1x
AS063155

1x
AS0631528



1



2



3



4



5

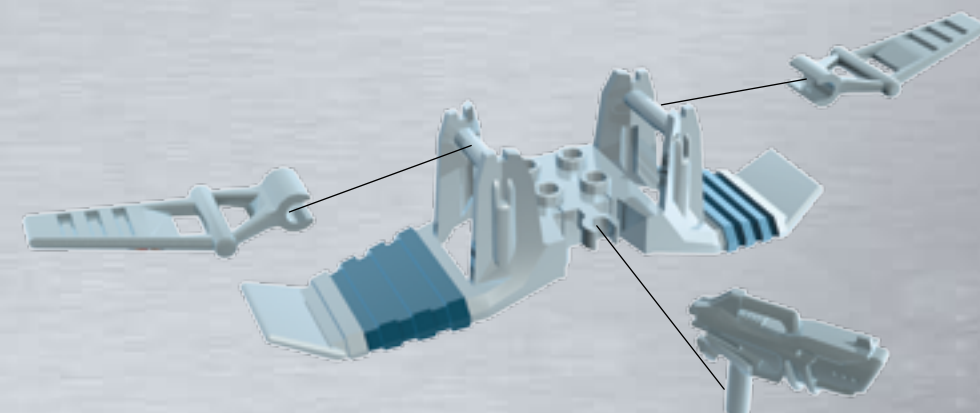
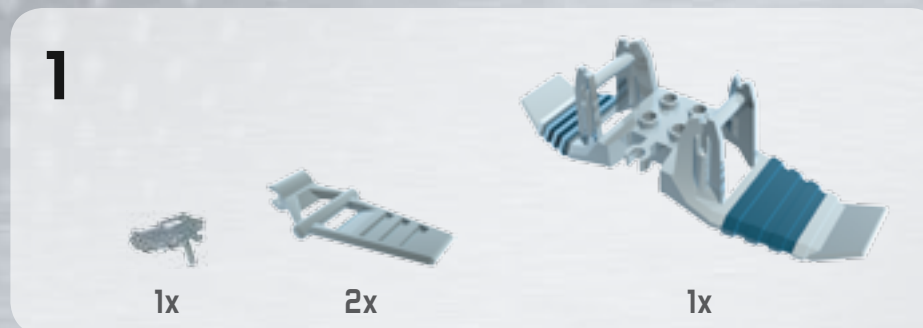

1



2





On / Off
Encender / Apagar
Marche / Arrêt
An / Aus
Acceso / Spento
Aan / Uit
Liga / Desliga

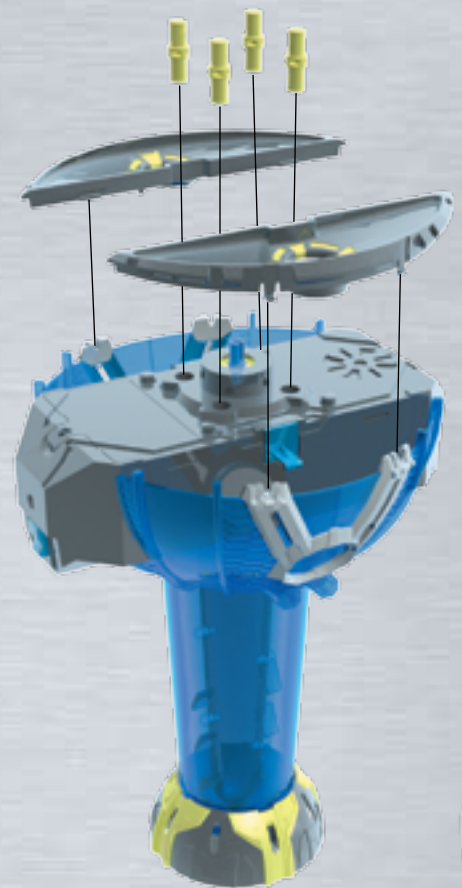
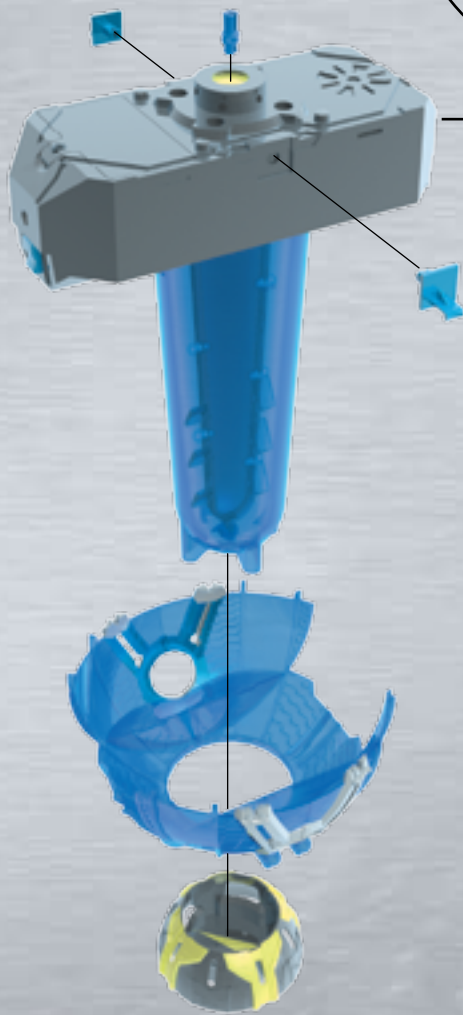
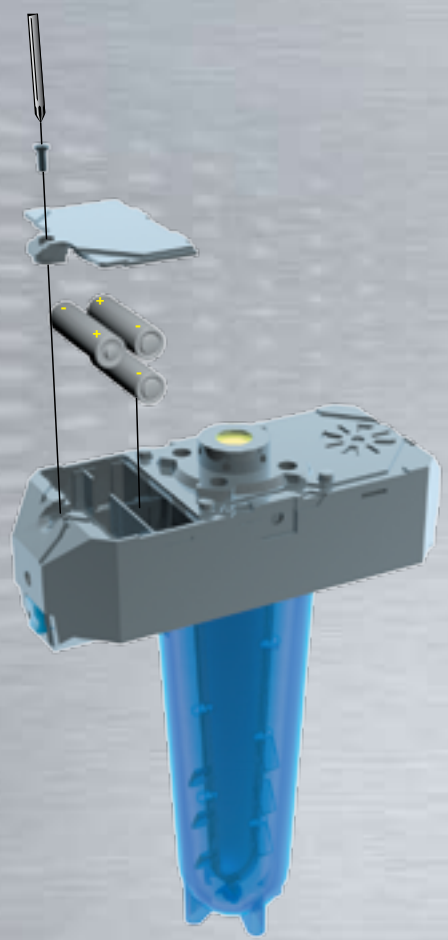
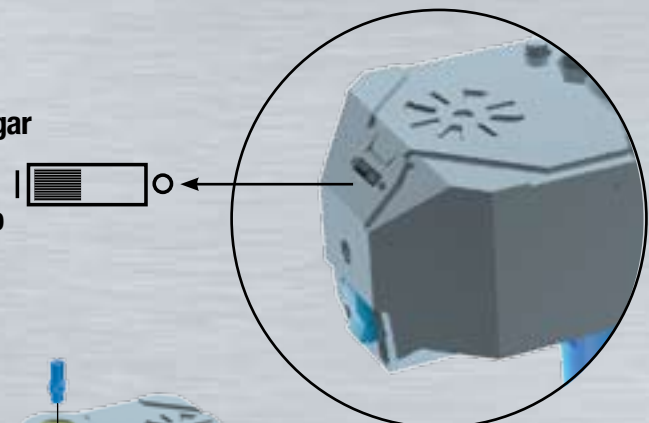

4

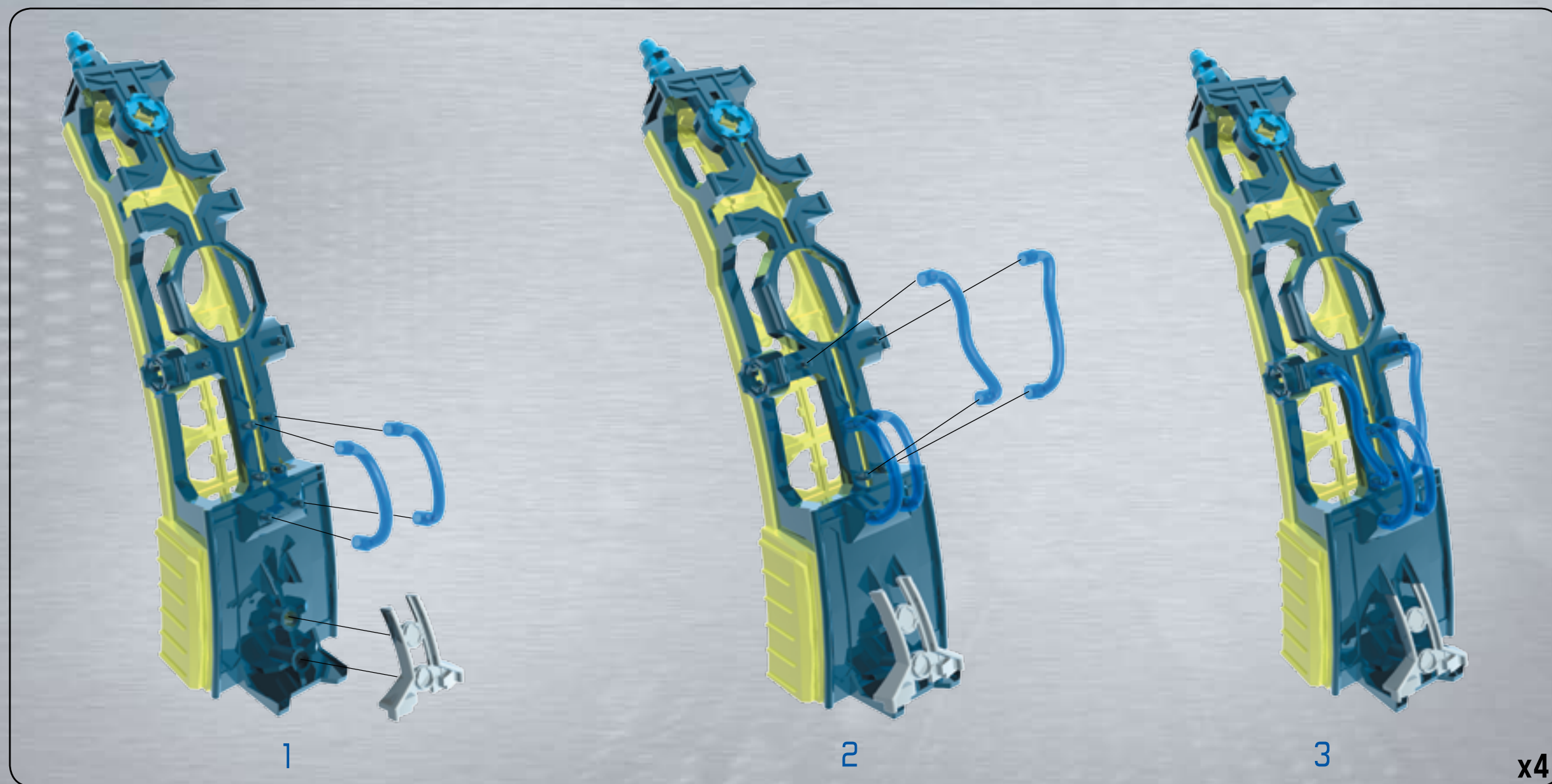
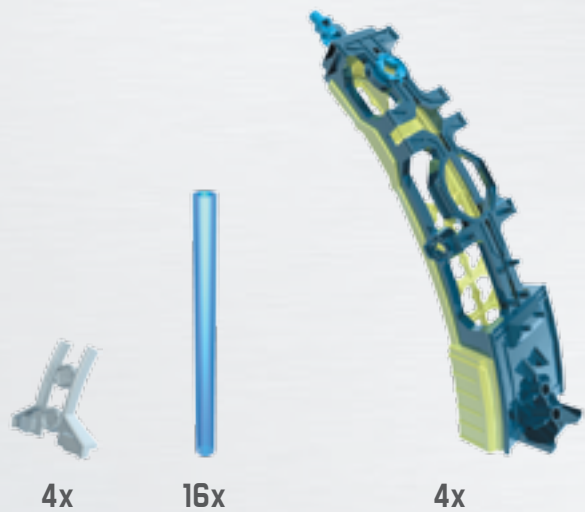

5

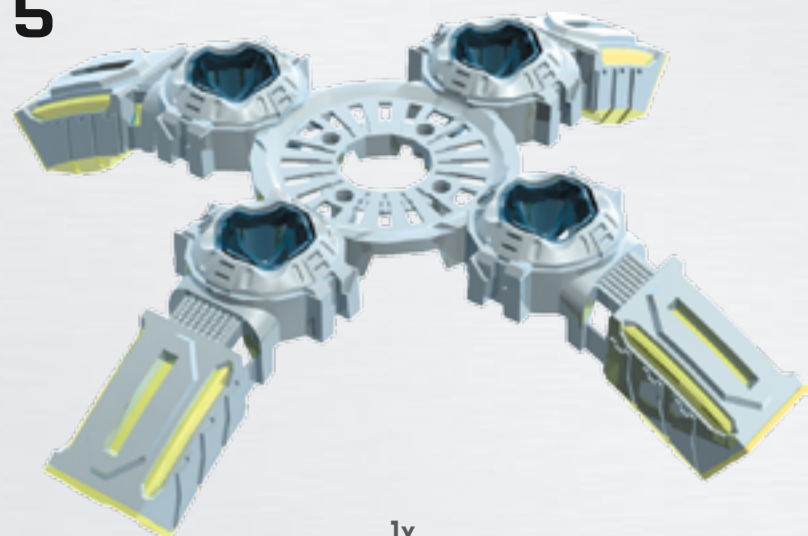

1x

6



2x

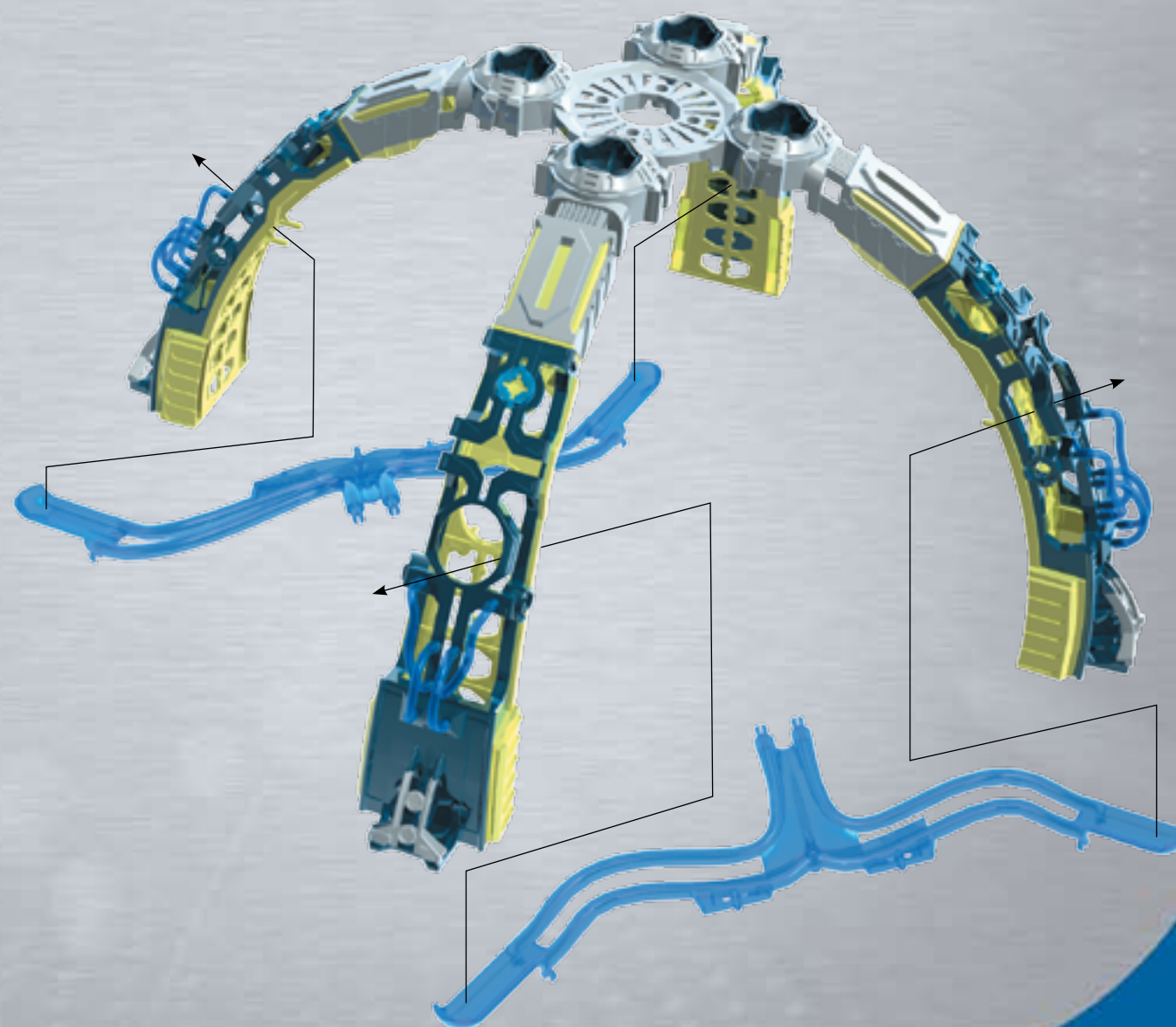
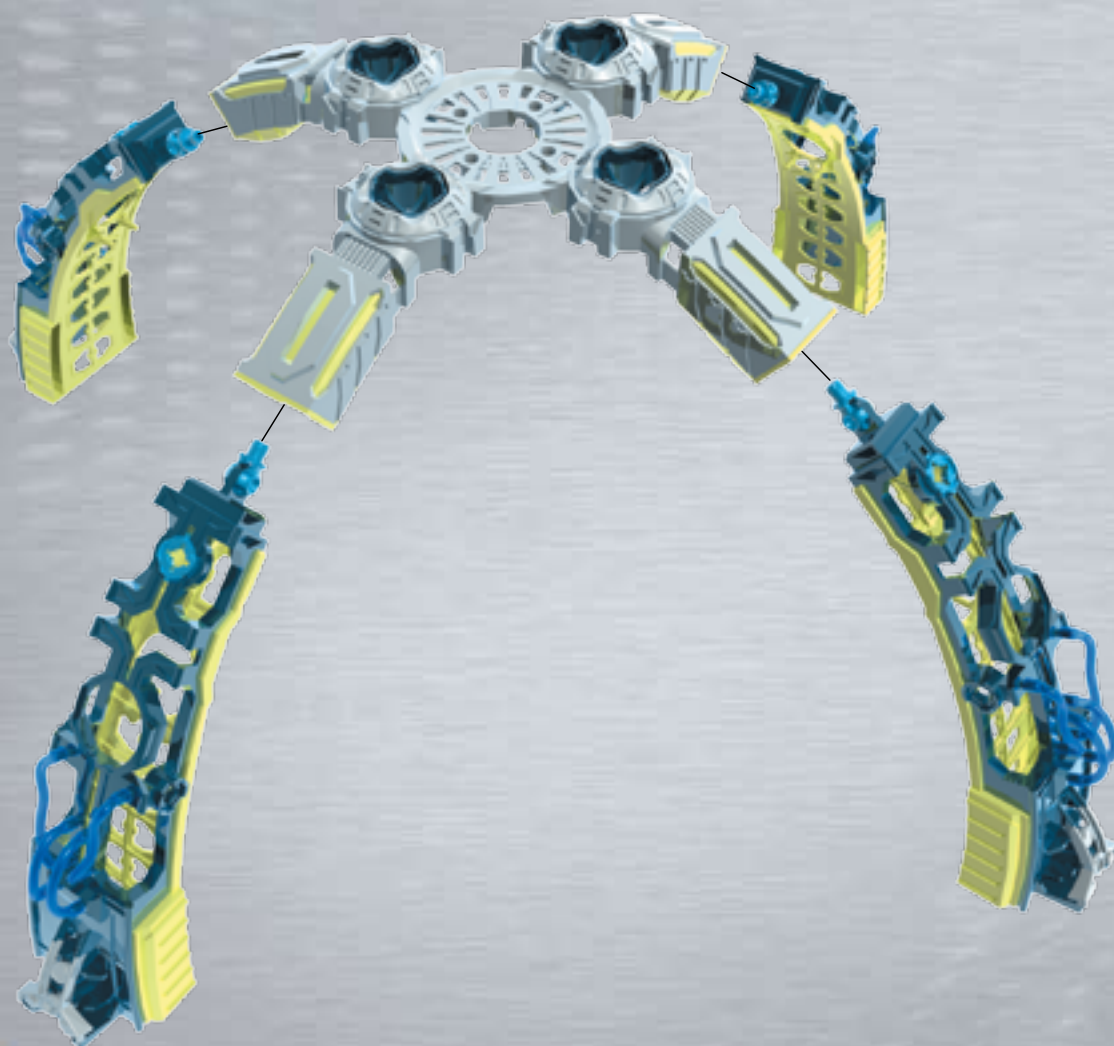

7

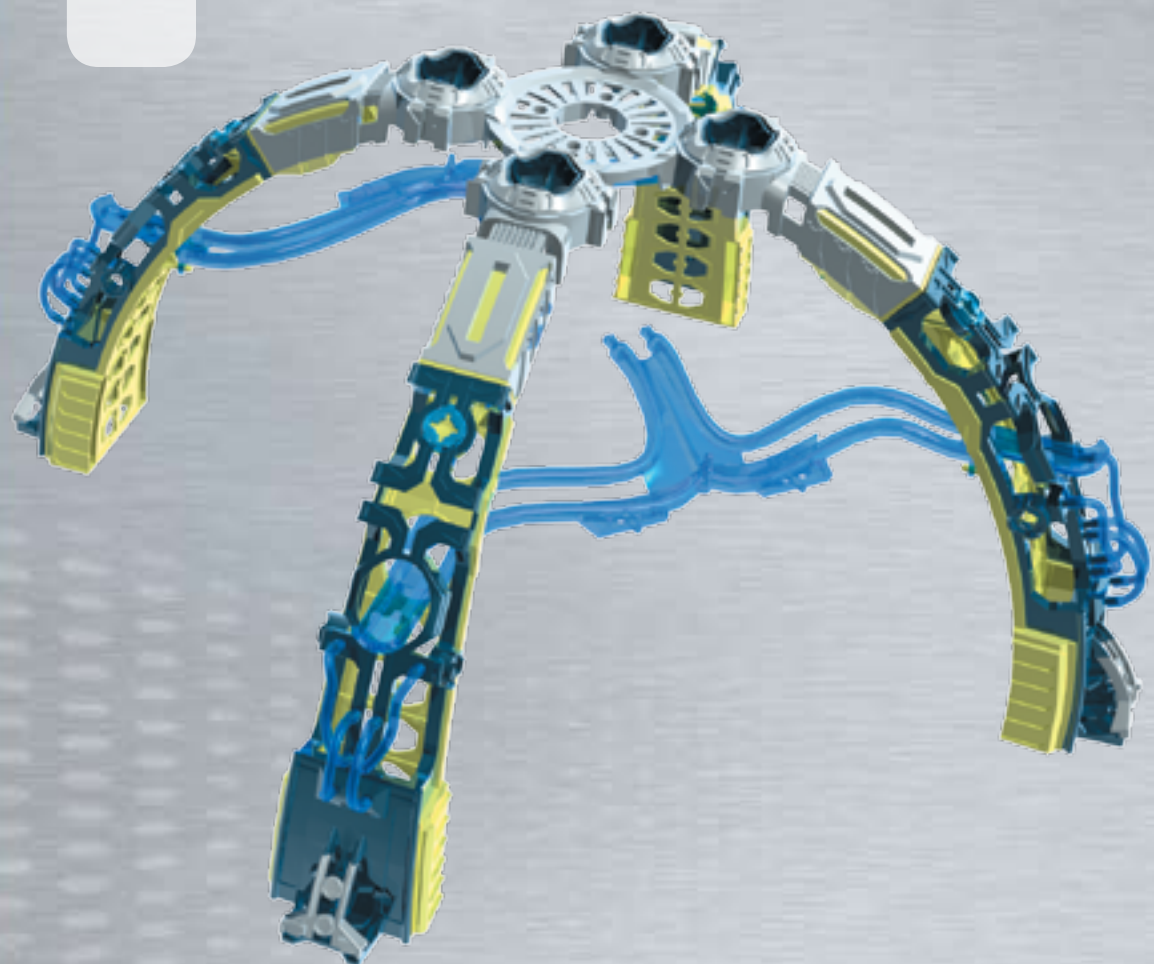

8

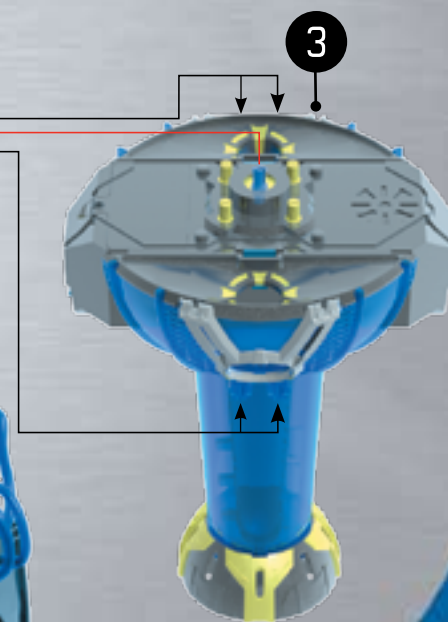
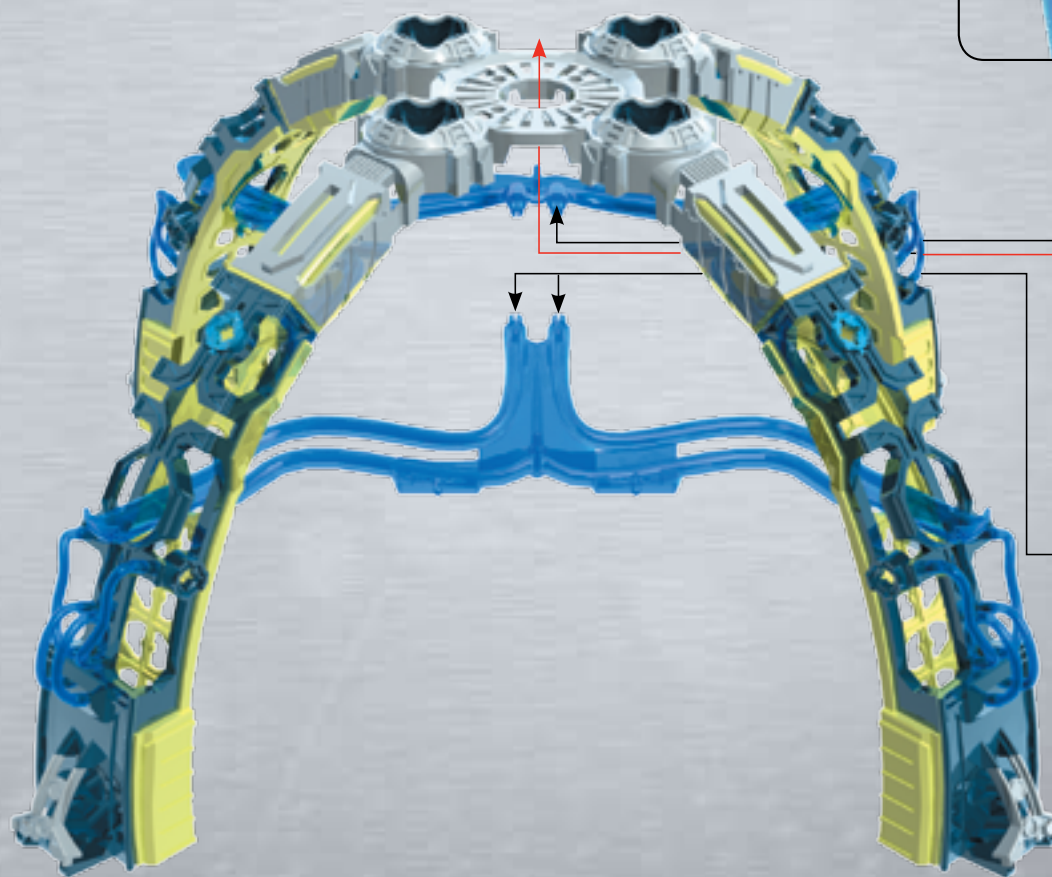

9



10

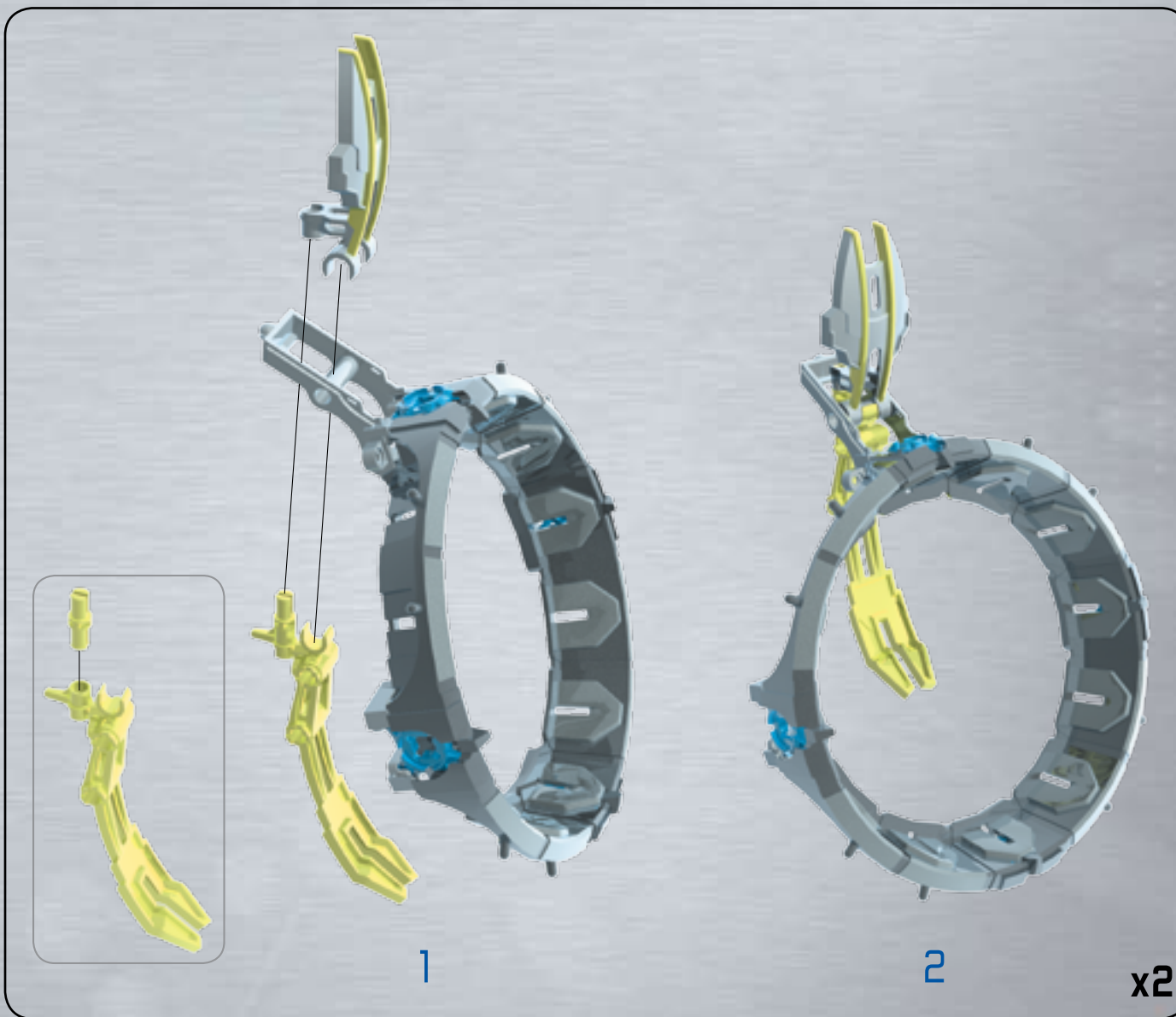

11

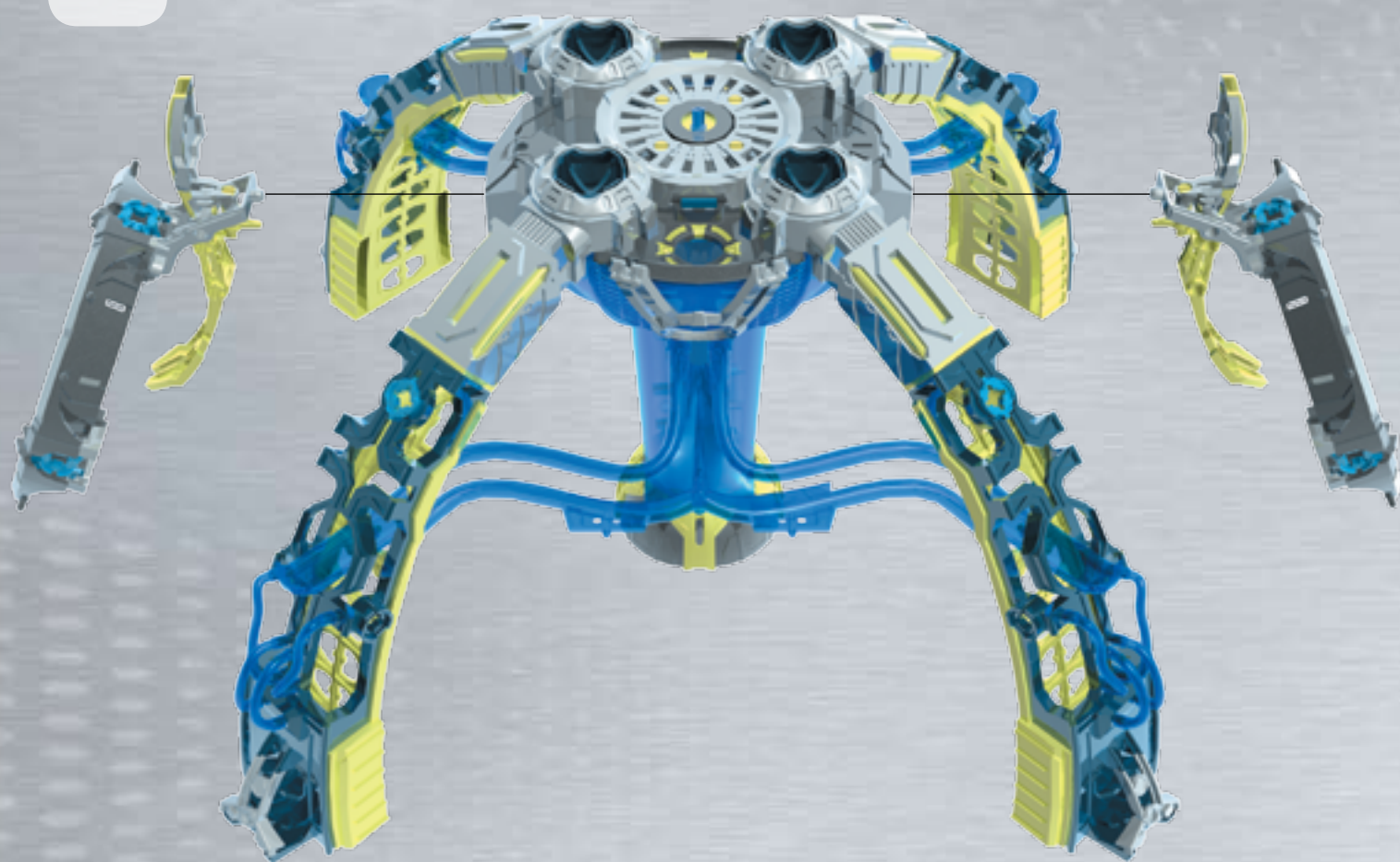

12

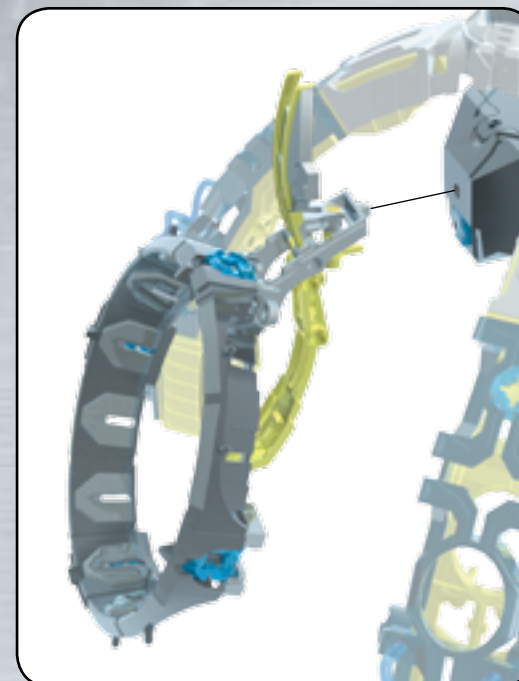

13

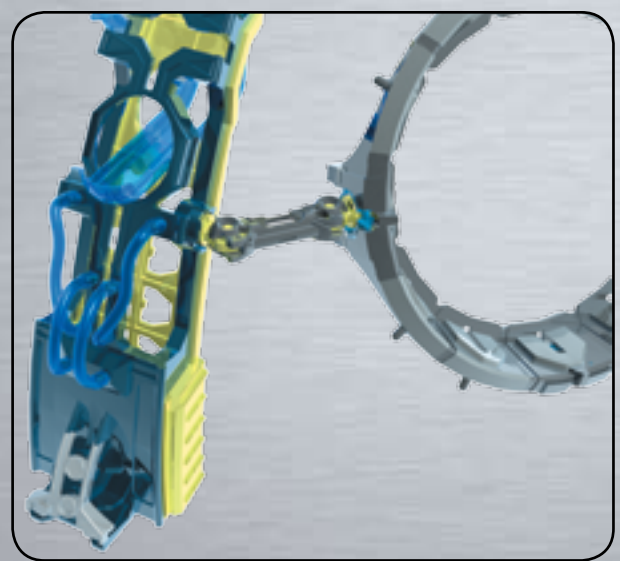
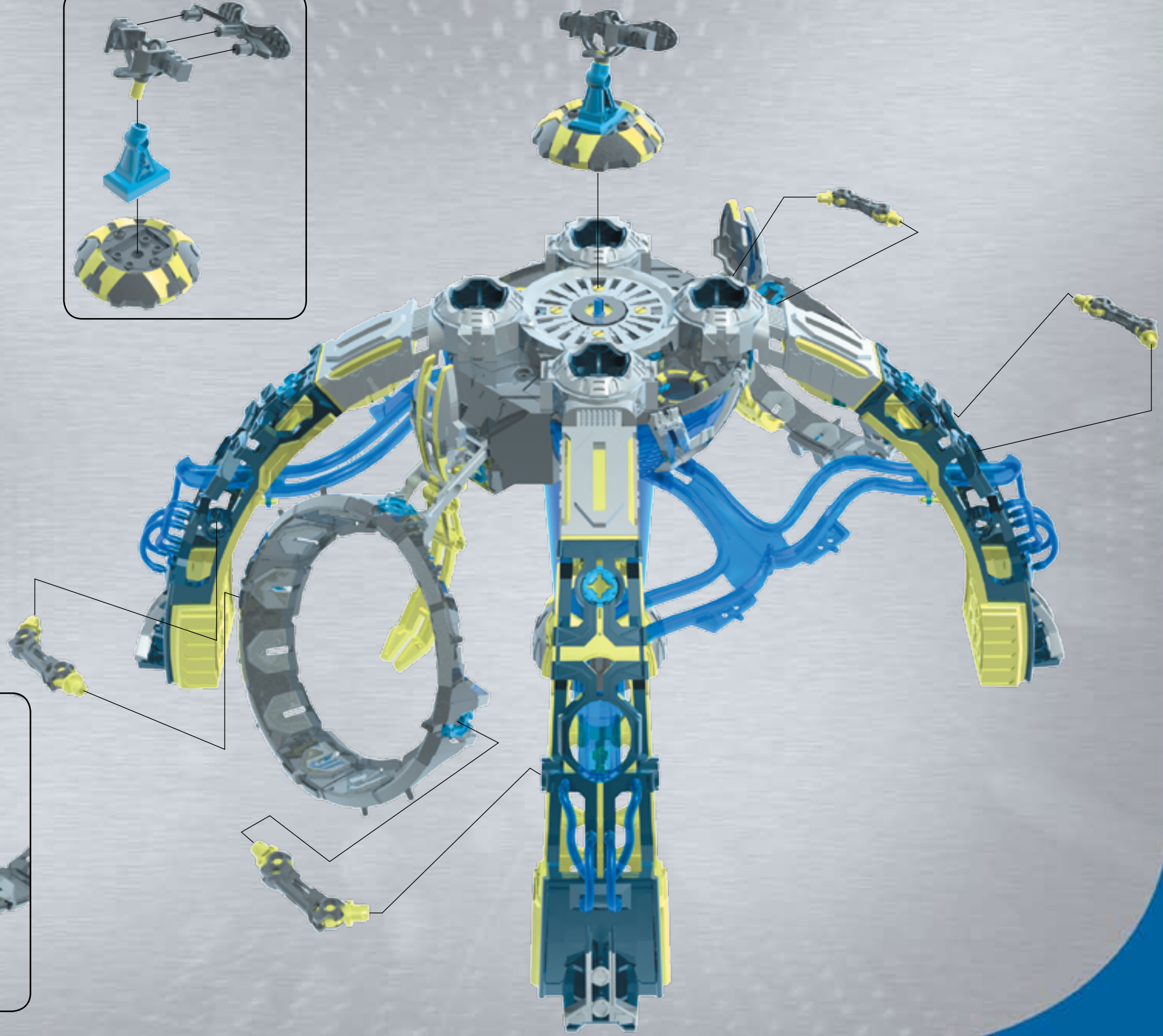
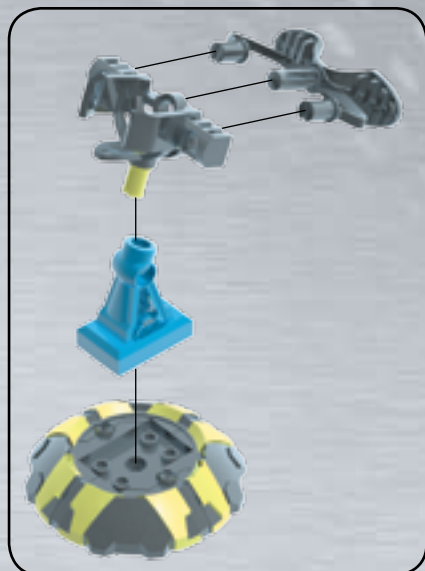

14

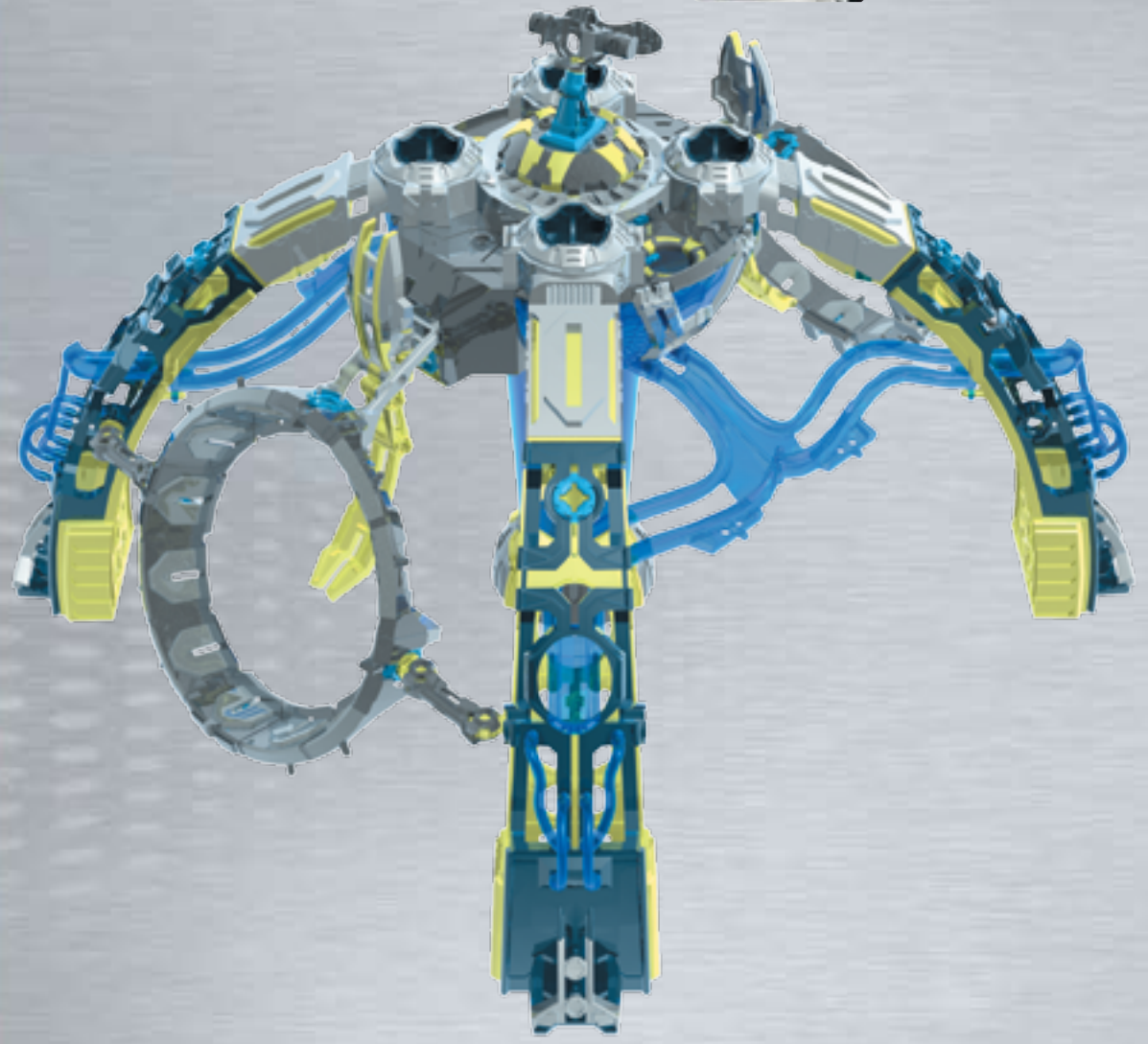

15

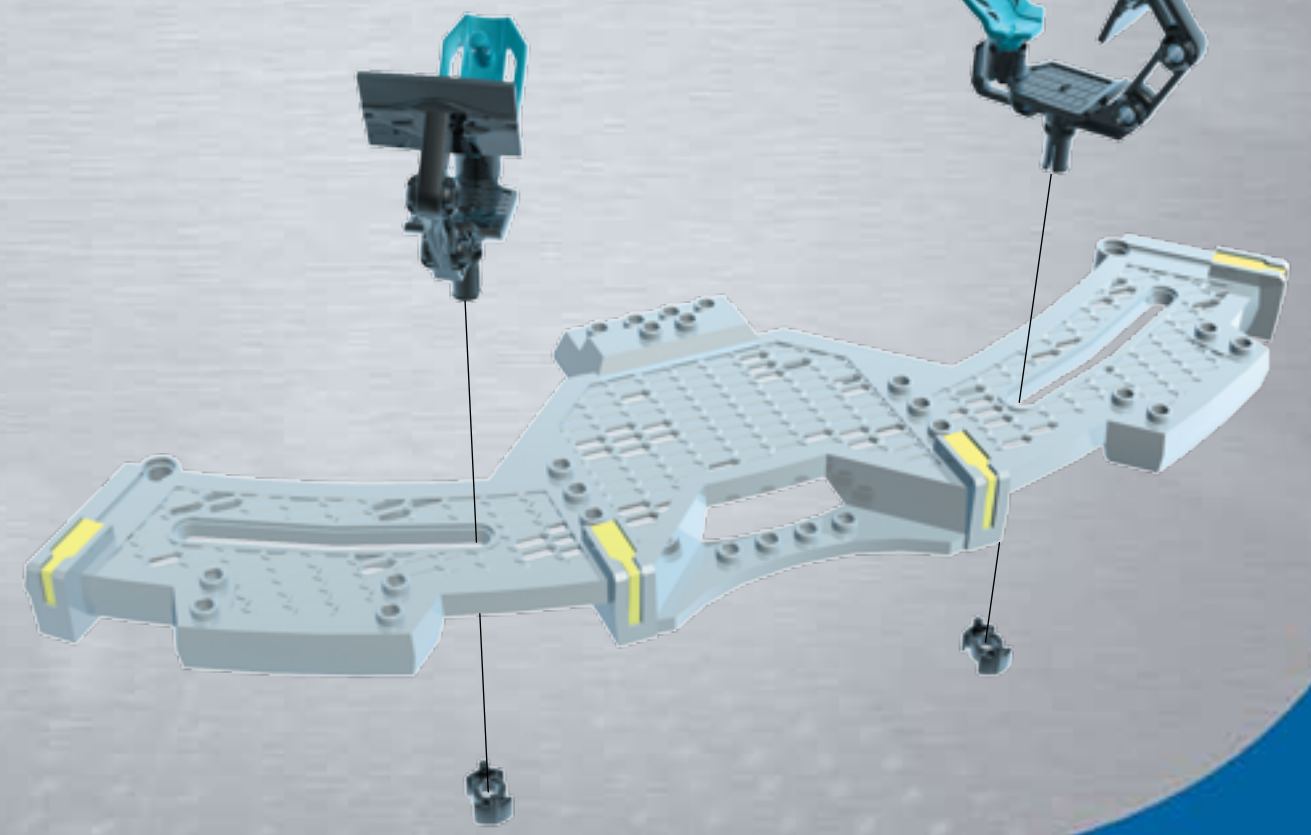
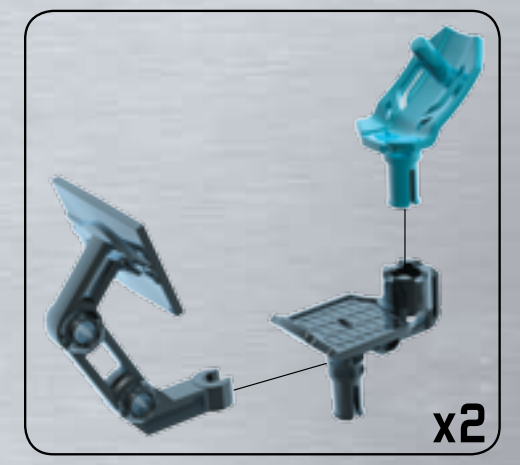
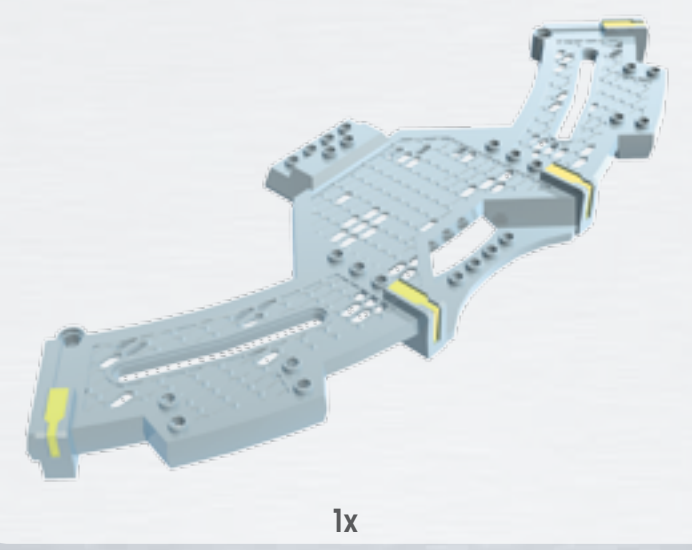

16

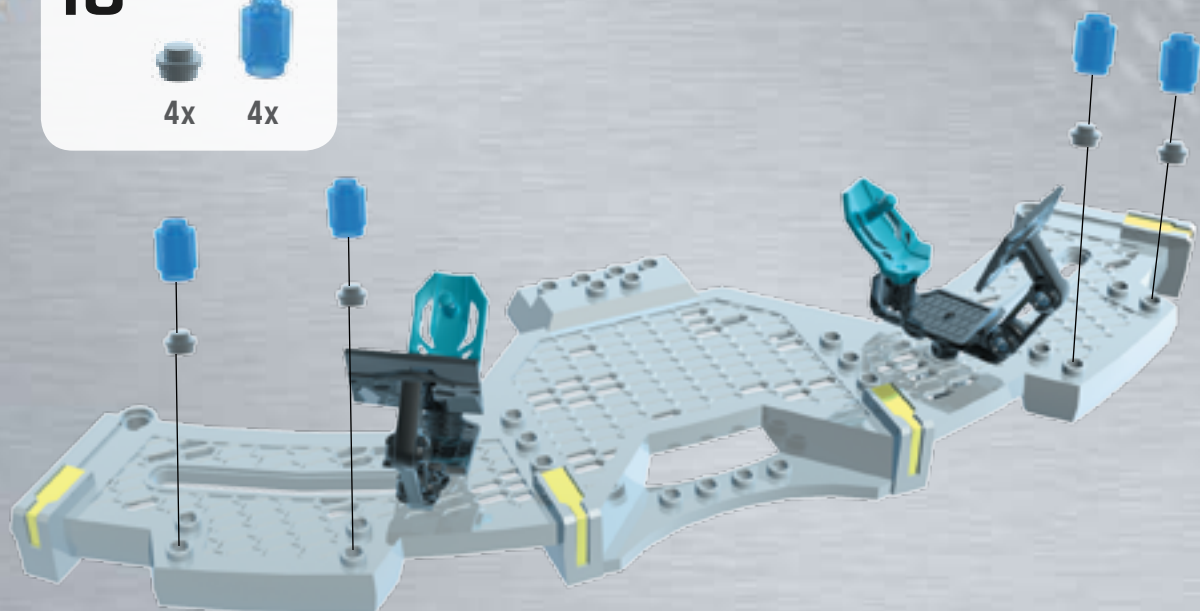

18

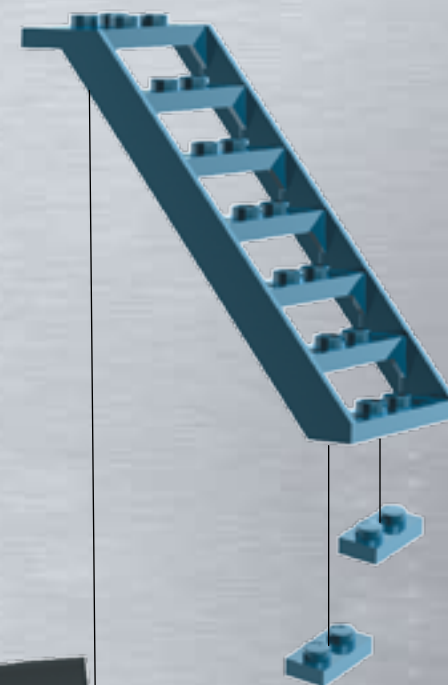
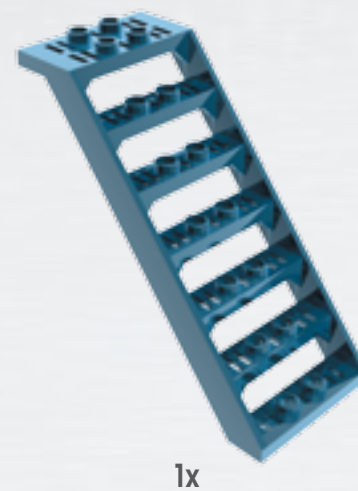

17

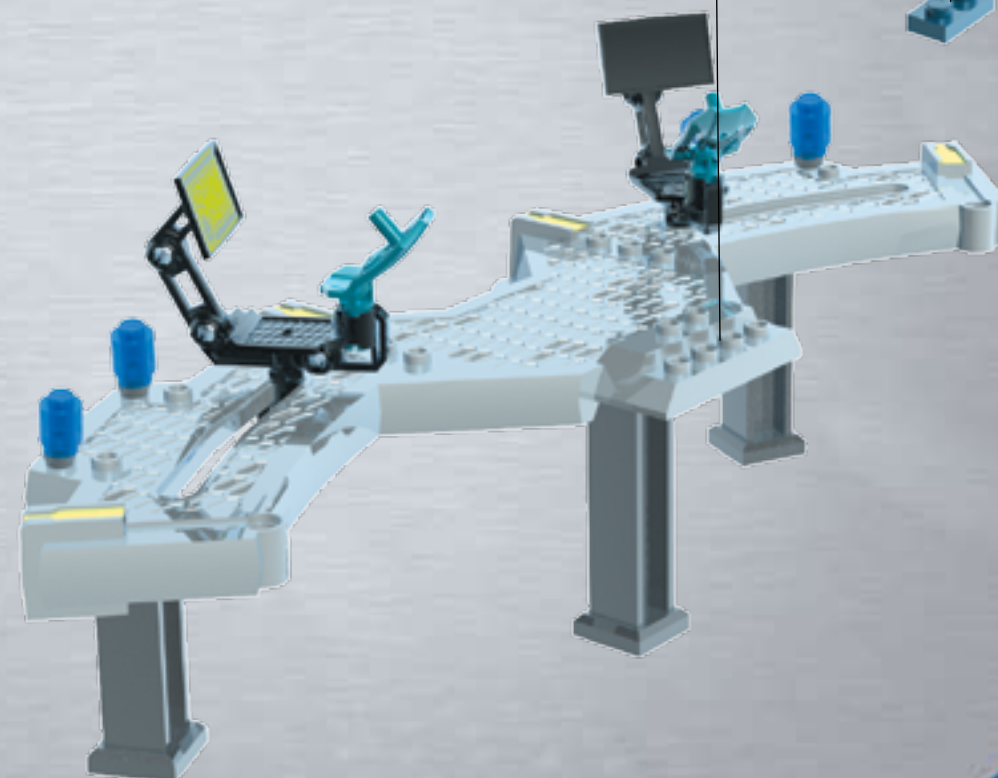
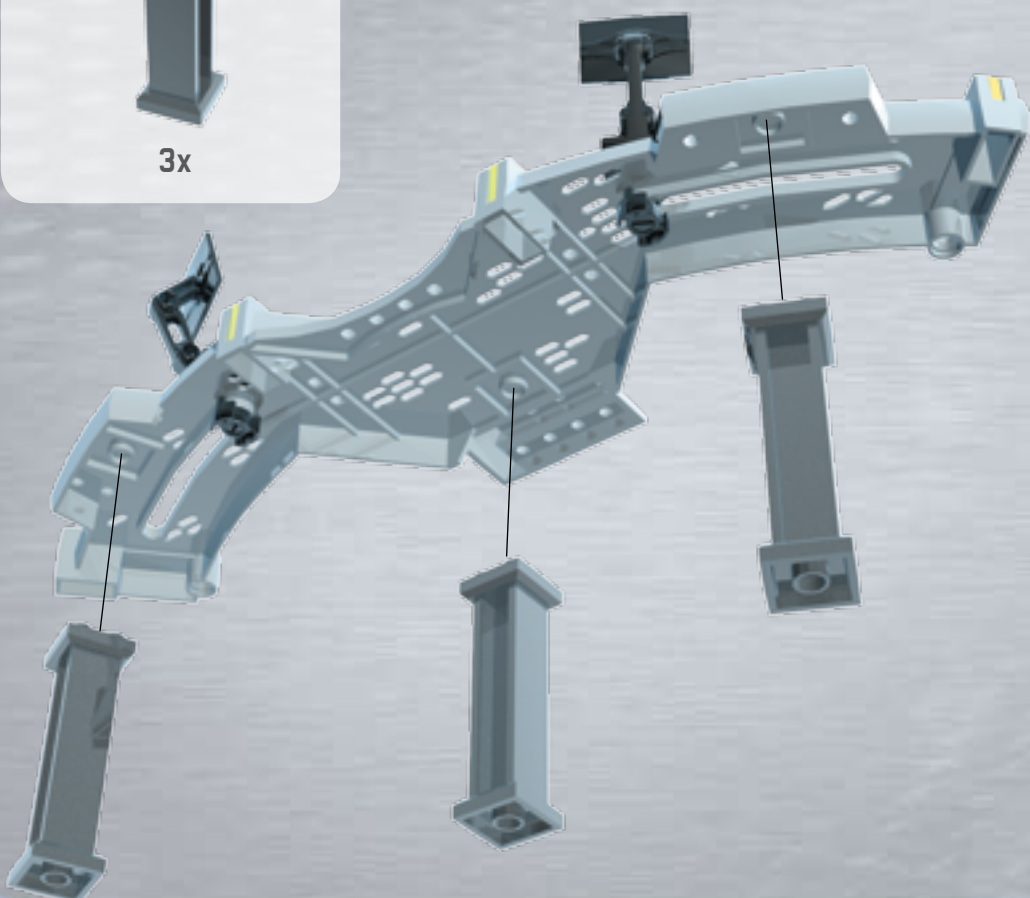

19



4x



2x

20

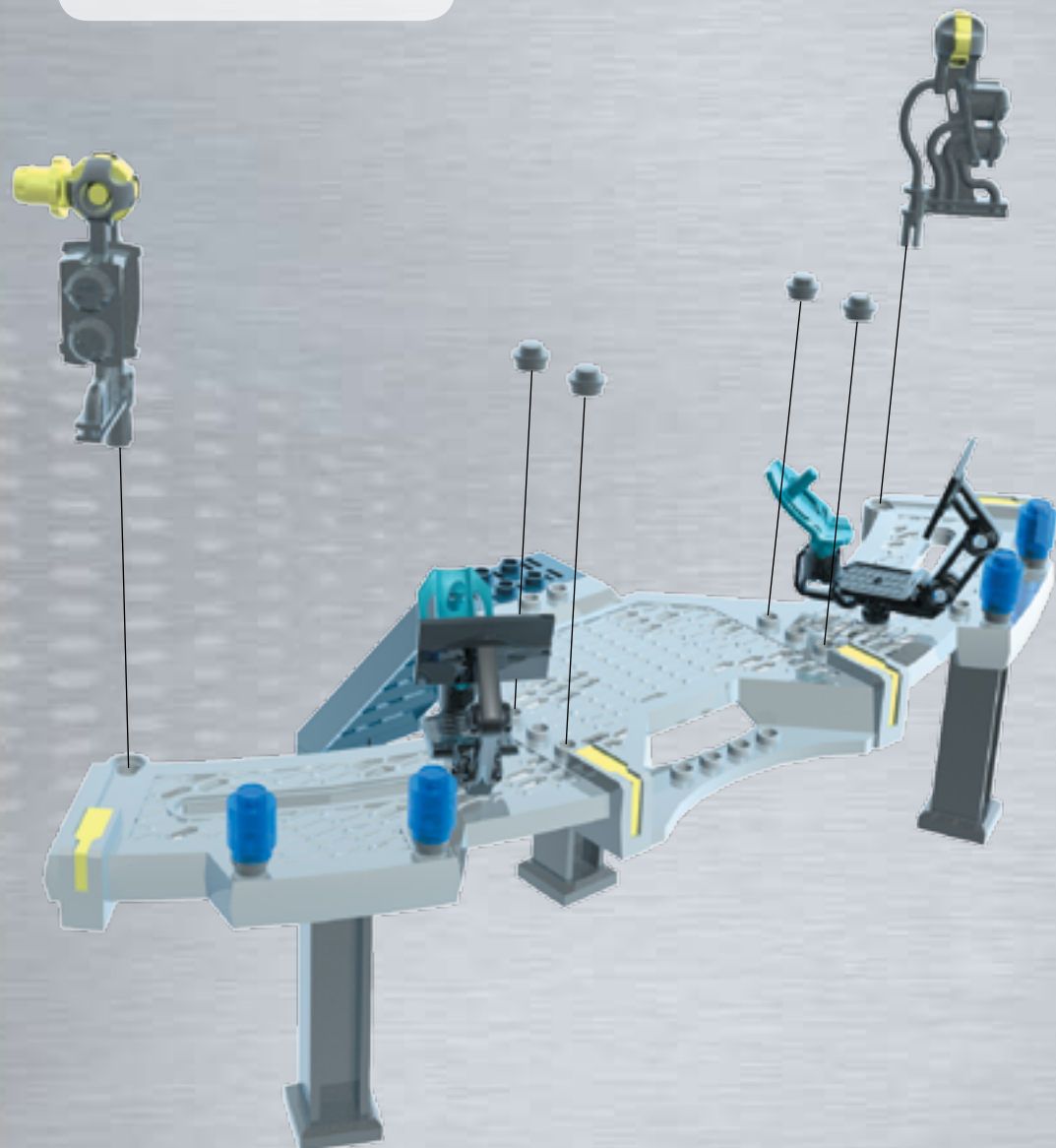

21



22



1x



1x



1x

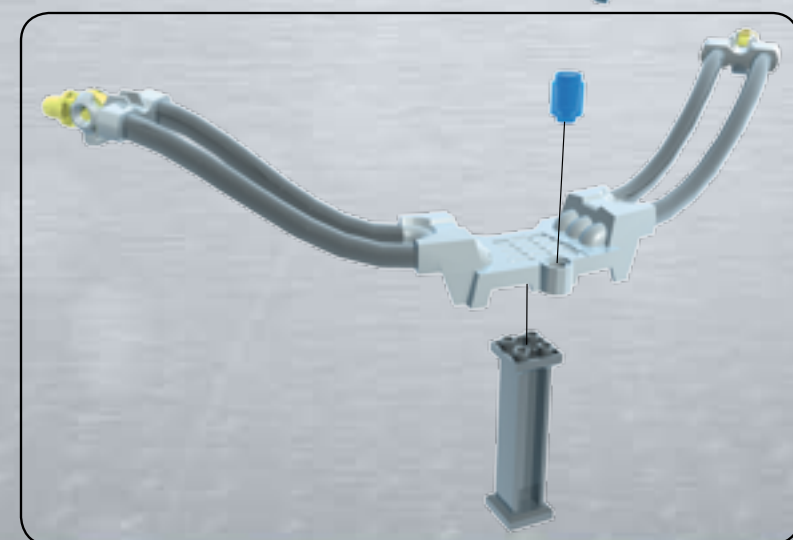
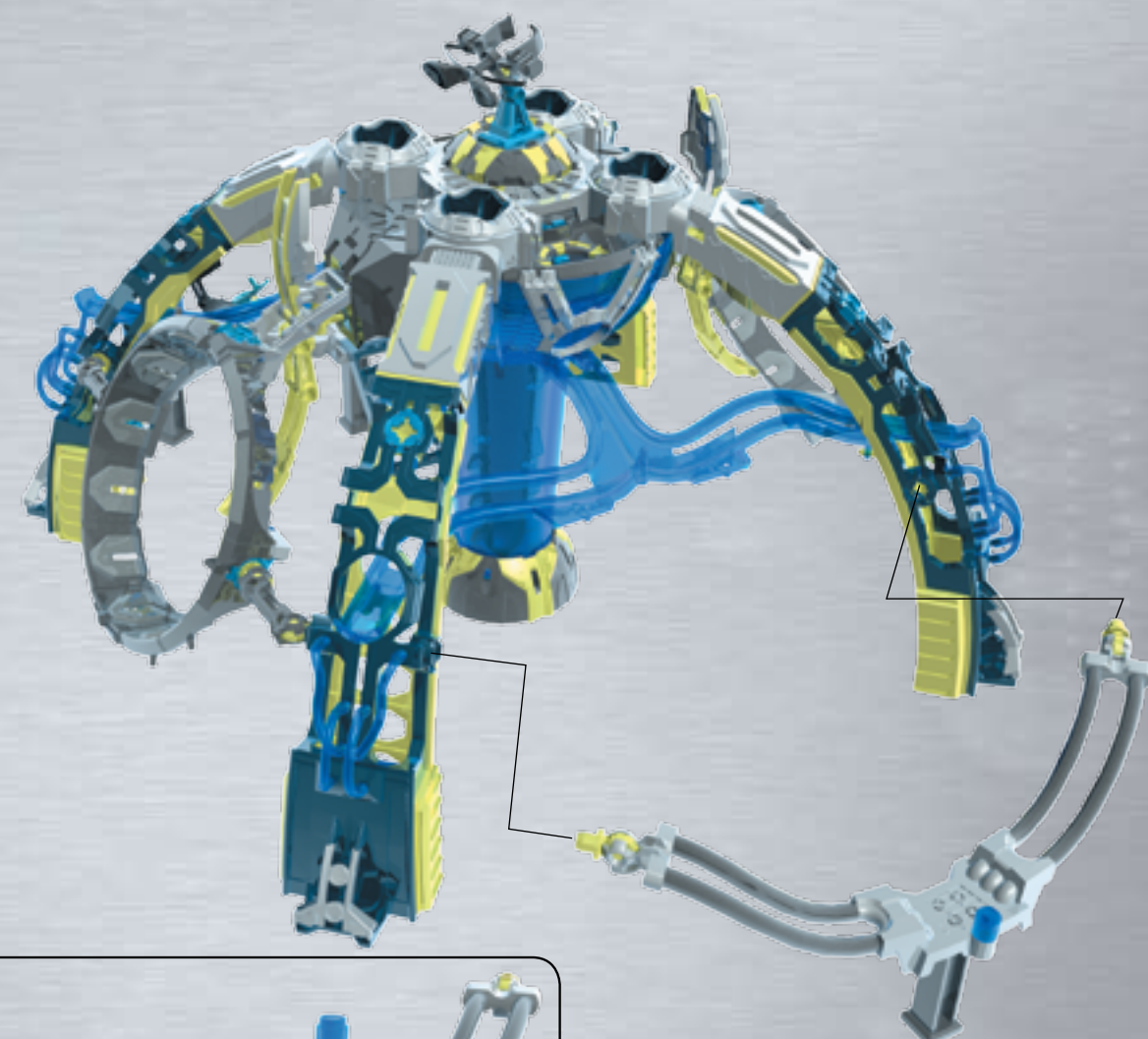

23



24

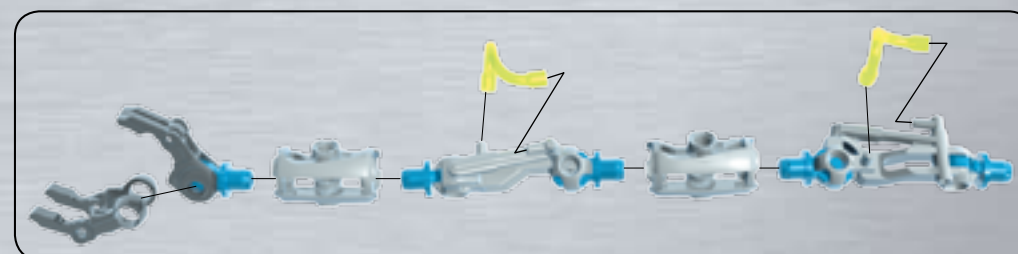

On / Off
Encender / Apagar
Marche / Arrêt
An / Aus
Acceso / Spento
Aan / Uit
Liga / Desliga

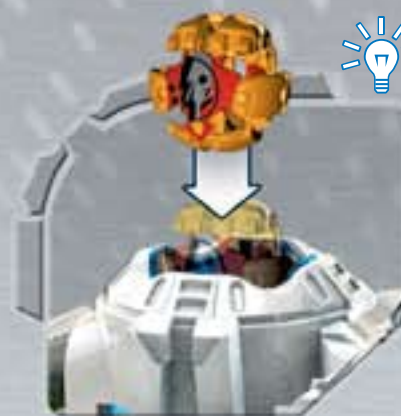
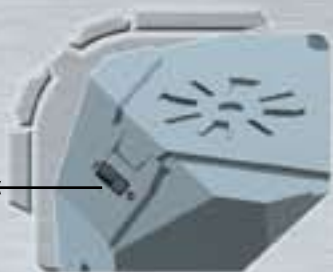

Hydrax Energy
Nêo Rejuvenation
Portals™

x4



Stratosphere
Hydrax Cannon
defense system™

Hydrogen Fusion Core™



Hydrax Energy Shifters
Rejuvenation Docks™

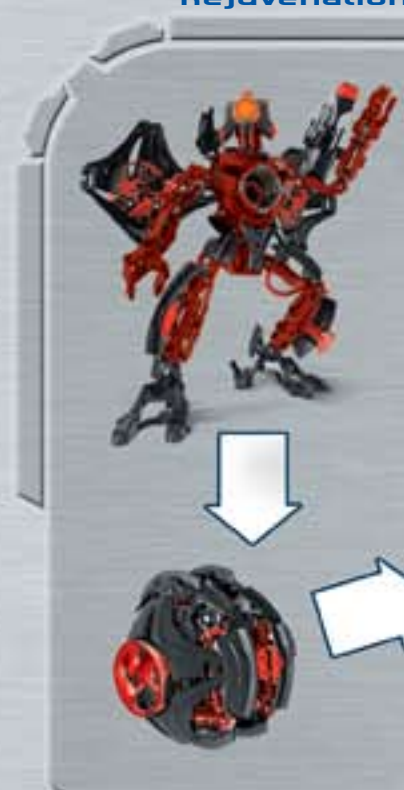

x2

Additional purchases required.
Se requieren compras adicionales.
Achats supplémentaires requis.
Zusatzkäufe erforderlich.
Vereist extra aankopen.
Acquisti supplementari necessari.
Compras adicionais são necessárias.





Nēo
Command
Console™

x2



Hydrax
Surveillance
Glider™



Nēo
Multifonction
Arm™

Hydrax Energy
balls chute™



x2

Includes 2 figures
Comprende 2 figurillas
Comprend 2 figurines
Umfasst 2 Figuren
Bevat 2 figuurtjes
Comprende 2 figurine
Inclui 2 figurinhas



HYDRAX :: ENERGY BASE™

NEO SHIFTERS

JOIN THE RESISTANCE



HYDRAX :: ENERGY BASE™

There stands a remote Hydrax Energy Base™ on Hydrax Tor™ that is still in operation, and the Templars™ and Paladins™ have taken up residence in the surrounding area. It is still pumping at great depths but it produces enough extra Hydrax™ energy to re-energize and empower whatever Néo Shifters™ faction gains control of it, in the short term and the long term - if they use it wisely!

La Hydrax Energy Base™ aislada, pero todavía en funcionamiento se encuentra en Hydrax Tor™, los Templars™ y los Paladins™ se han asentado en los alrededores. Sigue bombeando a gran profundidad, por lo que produce suficiente energía Hydrax para dar suministro a cualquier facción de Néo Shifters™ que la conquiste, a corto plazo y, si se utiliza con inteligencia, también a largo plazo.

L'Hydrax Energy Base™ isolée mais toujours active se trouve sur Hydrax Tor™ et les Templars™ et les Paladins™ se sont installés dans les environs. Elle effectue toujours des opérations de forage dans les profondeurs mais produit suffisamment d'énergie Hydrax™ supplémentaire pour redynamiser et permettre à n'importe quelle faction Néo Shifters™, à court et long termes, de contrôler cette énergie si ces derniers l'utilisent à bon escient!

Auf Hydrax Tor™ gibt es eine abgelegene Hydrax Energy Base™, die noch in Betrieb ist. Die Templars und Paladins haben ihr Lager unweit davon aufgeschlagen. Die Pumpe der Anlage läuft noch und generiert genügend zusätzliche Hydrax™-Energie, um die Neo Shifters™-Gruppe, die die Anlage unter ihre Kontrolle bringt, jetzt und auch in Zukunft mit Energie zu versorgen - sofern diese sparsam genutzt wird!

Op een afgelegen plek op Hydrax Tor™ bevindt zich een Hydrax Energy Base™ die nog steeds wordt gebruikt en de Templars™ en Paladins™ hebben zich in de buurt gevestigd. Er wordt nog steeds op grote diepte gepompt en de basis produceert voldoende extra Hydrax™-energie om de Néo Shifters™ die hier de controle over krijgen van nieuwe energie en krachten te voorzien. Als ze bovendien verstandig met deze energie omspringen, hebben ze genoeg voor lange tijd!

A Hydrax Tor™ si trova una Hydrax Energy Base™ ancora attiva e i Templars™ e i Paladins™ si sono stanziati nell'area circostante. La base effettua estrazioni a grandi profondità ma produce energia Hydrax™ sufficiente a sostenere qualsiasi fazione di Néo Shifters™ che ne assuma il controllo, a breve o lungo termine, se ne viene fatto un uso intelligente!

Em Hydrax Tor™, encontra-se uma central de energia Hydrax Energy Base™ ainda em funcionamento, os Templars™ e Paladins™ montaram os seus acampamentos nas cercanias. Através da extração de recursos das profundezas, produz energia Hydrax™ suficiente para satisfazer as necessidades (a curto e longo prazo) da facção de Néo Shifters™ que dela se apodere — se for utilizada com sensatez!

6308



6309



6302



TEMPLAR

6301



6317



6321



Split Shifter™
6337



WWW.NEOSHIFTERS.COM

Also available
También disponible
Également disponible
Ebenfalls erhältlich
Eveneens beschikbaar
Anche disponibile
Também disponível

6303



6320



6310



6318



6304



6311



PALADIN

All images shown for illustration purposes only. Product and color may vary. / Estas imágenes tienen exclusivamente carácter ilustrativo. El producto y los colores pueden variar. / Toutes les images sont fournies à titre d'illustration uniquement. Le produit et la couleur sont susceptibles de varier. / Alle Abbildungen dienen lediglich zu Illustrationszwecken. Produkt und Farbe können von der Abbildung abweichen. / Alle afbeeldingen zijn slechts ter illustratie. Product en kleur kunnen afwijken. / Le immagini sono usate solo a scopo illustrativo. Il prodotto e il colore potrebbero subire variazioni. / Imagens apresentadas para fins ilustrativos. Cores e produto podem ser diferentes dos apresentados.



© 2008, MEGA Brands Inc. ® and ™ denote trademarks of MEGA Brands Inc. This toy conforms to: Voluntary Product Standard F963 U.S., Canadian Hazardous Products Act, CEN Standards E.N. 71. Products and colors may vary. ® and ™ designan la marca registrada y la marca comercial de MEGA Brands Inc. Este juguete es de conformidad con: Voluntary Product Standard F963 U.S., Canadian Hazardous Products Act, CEN Standards E.N. 71. Las piezas y los colores pueden variar. ® et ™ désignent des marques de commerce de MEGA Brands Inc. Ce jouet est conforme aux: Voluntary Product Standard F963 U.S., Canadian Hazardous Products Act, CEN Standards E.N. 71. Les items et les couleurs peuvent varier. ® und ™ sind Markenzeichen der Firma MEGA Brands Inc. Dieses Spielzeug stimmt mit: Voluntary Product Standard F963 U.S., Canadian Hazardous Products Act, CEN Standards E.N. 71 überein. Produkte und Farben können unterschiedlich sein. ® et ™ duiden op handelsmerken van MEGA Brands Inc. Dit speelgoed voldoet aan: Voluntary Product Standard F963 U.S., Canadian Hazardous Products Act, CEN Standards E.N. 71. In producten en kleuren kan variatie optreden. ® e ™ indicano dei marchi depositati di MEGA Brands Inc. Questo giocattolo è conforme a: Voluntary Product Standard F963 U.S., Canadian Hazardous Products Act, CEN Standards E.N. 71. Prodotti e colori possono variare. ® e ™ denotam marcas registradas de MEGA Brands Inc. Este brinquedo conforma-se ao Produto Padrão Voluntário F963 EE.UU., Decreto Canadense de Produtos Perigosos, Padrões CEN, E.N. 71. Produtos e cores podem variar. Printed in China AD063151C