

TEMPLAR



NEO SHIFTERS

WWW.NEOSHIFTERS.COM

TRIFLEX TURBINE

6348

6x
AM09877ACX



17x
AM01793BRD



1x
AM09870MM



1x
AM09869MM



4x
AS063486



2x
AS063488



2x
AS063487



2x
AM09738MM



4x
AS063485

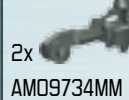

2x
AM09734MM



1x
AM15202MM

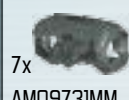

7x
AM09731MM



6x
AM09727MM



1x
AM15203MM



2x
AM09733MM



2x
AS0634814



2x
AS063484



2x
AS063483



2x
AS063482



2x
AS063481



2x
AS0634812

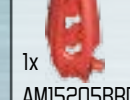

1x
AM15205BRD



6x
AS063489



1x
AM09871BRD



1x
AM09863BRD



1x
AM09864BRD



1x
AM09872BRD



1x
AM15204MM



2x
AM15239MM



2x
AS063487

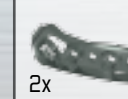

2x
AM15218MM



1x
AS0634835

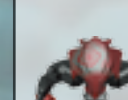

1x
AS0634838



1x
AS0634841

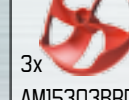

3x
AM15303BRD



1x
AS0630220

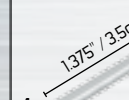

4x
AX063481ACX

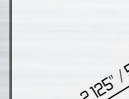

4x
AX063482ACX



1x
AS0634819



2x
AS063173



2x
AS0634816

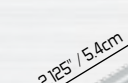
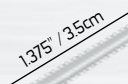

EN Please read these instructions carefully before first use and keep them for future reference. / **ES** Leer estas instrucciones cuidadosamente antes de la primera utilización y guardarlas para referencia futura. / **FR** Il est recommandé de lire attentivement ce feuillet avant la première utilisation et de le conserver pour référence future. / **DE** Die Gebrauchsanleitung bitte durchlesen und aufbewahren. / **NL** Wij raden u aan deze handleiding zorgvuldig te lezen en te bewaren voor eventuele raadpleging op een later tijdstip. / **IT** Leggere le istruzioni prima di cominciare ad usare il gioco e conservarle per referenze future. / **JA** Leia as instruções antes do primeiro uso e guarde-as para futura referência.

EN ⚠ **WARNING :**
CHOKING HAZARD. - Small parts.
Not for children under 3 years.

ES ⚠ **ADVERTENCIA :**
PELIGRO DE ASFIXIA. - Contiene piezas pequeñas.
No recomendado para niños menores de 3 años.

FR ⚠ **AVERTISSEMENT :**
RISQUE DE SUFFOCATION. - Présence de petits éléments.
Ne convient pas aux enfants de moins de 3 ans.

NL ⚠ **WAARSCHUWING :**
VERSTIKKINGSGEVAAR. - Enthält kleine Teile.
Nicht für Kinder unter 3 Jahren geeignet.

DA ⚠ **ADVARSEL :**
KVÆLNINGSFARE. - Indeholder smådele.
Ikke til børn under 3 år.

EL ⚠ **ΠΡΟΕΙΔΟΠΟΙΗΣΗ :**
ΚΙΝΔΥΝΟΣ ΠΝΙΞΙΜΑΤΟΣ. - Περιέχει μικρά αντικείμενα
Όχι για παιδιά κάτω των 3 ετών.

FI ⚠ **VAROITUS :**
TUKEHTUMISVAARA. - Sisältää pieniä osia.
Ei alle 3-vuotiaille lapsille.

IT ⚠ **ATTENZIONE :**
PERICOLO DI SOFFOCAMENTO. - Contiene piccole parti.
Non indicato per bambini sotto i 3 anni.

NO ⚠ **ADVARSEL :**
KVELNINGSFARE. - Inneholder små deler.
Kun for barn over 3 år.

PT ⚠ **ATENÇÃO :**
PERIGO DE ASFIXIA. - Contém peças pequenas.
Não é concebido para crianças de menos de 3 anos.

SV ⚠ **VARNING :**
KVÄVNINGSRISK. - Innehåller små delar.
Inte för barn under 3 år.

JA ⚠ **警告 :**
窒息の危険性 - 小さな部品が含まれています
3歳以下の子供には与えないで下さい。

ZH ⚠ **警告 :**
有窒息危險 - 包含有小部件
不适合3岁以下的小孩玩。

AR ⚠ **تحذير :**
خطر اختناق - قطع صغيرة.
غير صالحة للأطفال أقل من 3 سنوات.



EN CAUTION! Do not aim at eyes or face.
ES ¡ADVERTENCIA! NO dirigir nunca los proyectiles hacia los ojos o la cara.
FR ATTENTION! Ne pas viser les yeux ou le visage.
DE VORSICHT! Nicht auf das Gesicht oder die Augen richten.
NL LET OP: Niet op ogen of gezicht richten.
DA ADVARSEL! Peg ikke i retning af øjne eller ansigt.
EL ΠΡΟΣΟΧΗ! Να μην σκοπεύετε προς τα μάτια ή το πρόσωπο.
FI VARO! Älä tähtää silmiin tai kasvoihin.
IT Attenzione! Non puntare verso gli occhi o il viso.
NO FORSIKTIG! Sikt ikke mot øyne eller ansikt.
PT ATENÇÃO! Não apontar para os olhos ou o rosto.
SV VAR FÖRSIKTIG! Rikta inte med ögon eller ansikte.
JA 注意! 目や顔に使用しないで下さい。
ZH 警告! 不要对准眼睛或脸。
AR تنبيه! لا توجه للعينين أو الوجه

Use only the projectile included with this toy.
Utilizar solamente el proyectil incluido con el juguete.
Utiliser seulement le projectile fourni avec le jouet.
Nur das mit dem Spielzeug mitgelieferte Projektil verwenden.
Alleen het met het speelgoed bijgeleverde projectiel gebruiken.
Utilizzare soltanto il proiettile fornito con questo giocattolo.
Usar somente o projétil incluído com este brinquedo.
استخدم فقط القذيفة المرافقة لهذه اللعبة

5 toys in
juguetes en
jouets en
Spielzeuge in
speeltjes in
giocattoli in
brinquedos em

1



1



2



3



4



5



1

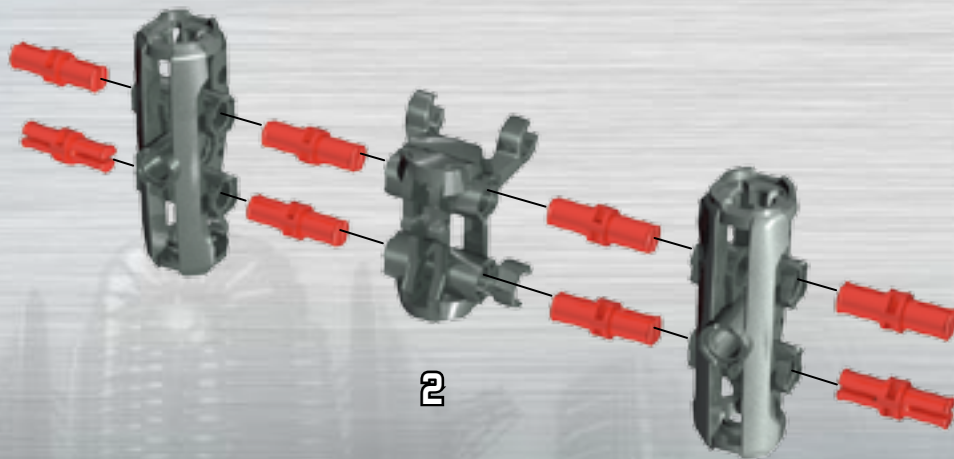
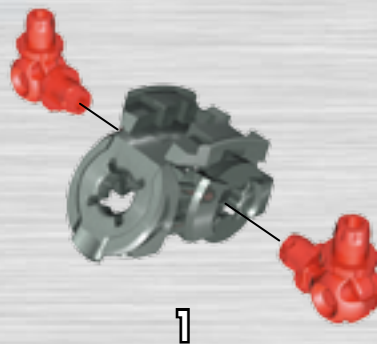

2



2.125" / 5.4cm

1x



1x



1



2

3



2.125" / 5.4cm

1x



1x

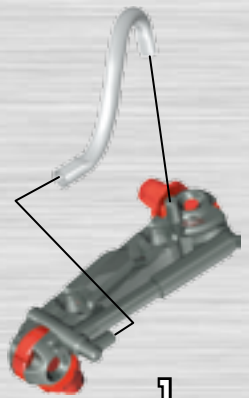

1

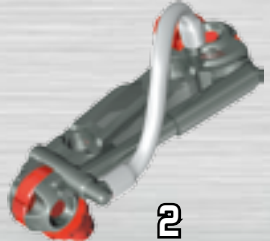

2

4



1x



1x

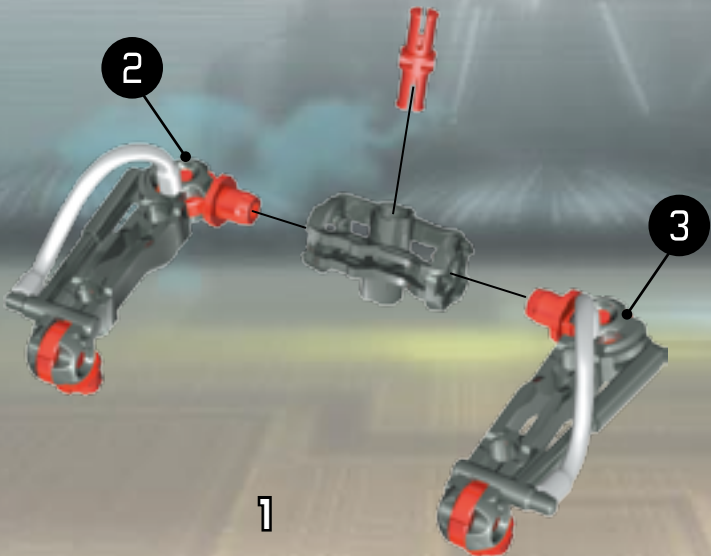

1

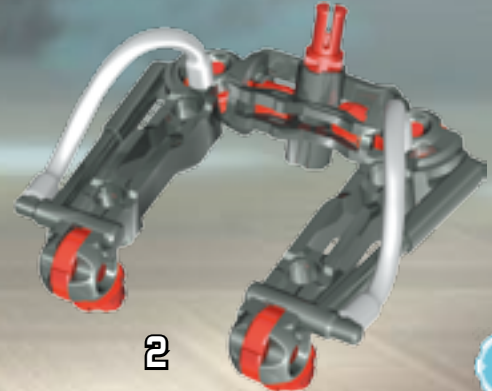

2

5

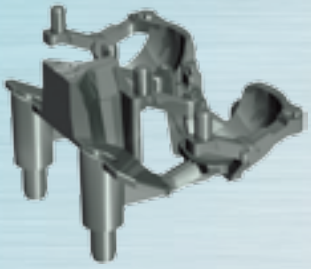

1x



1x



1x

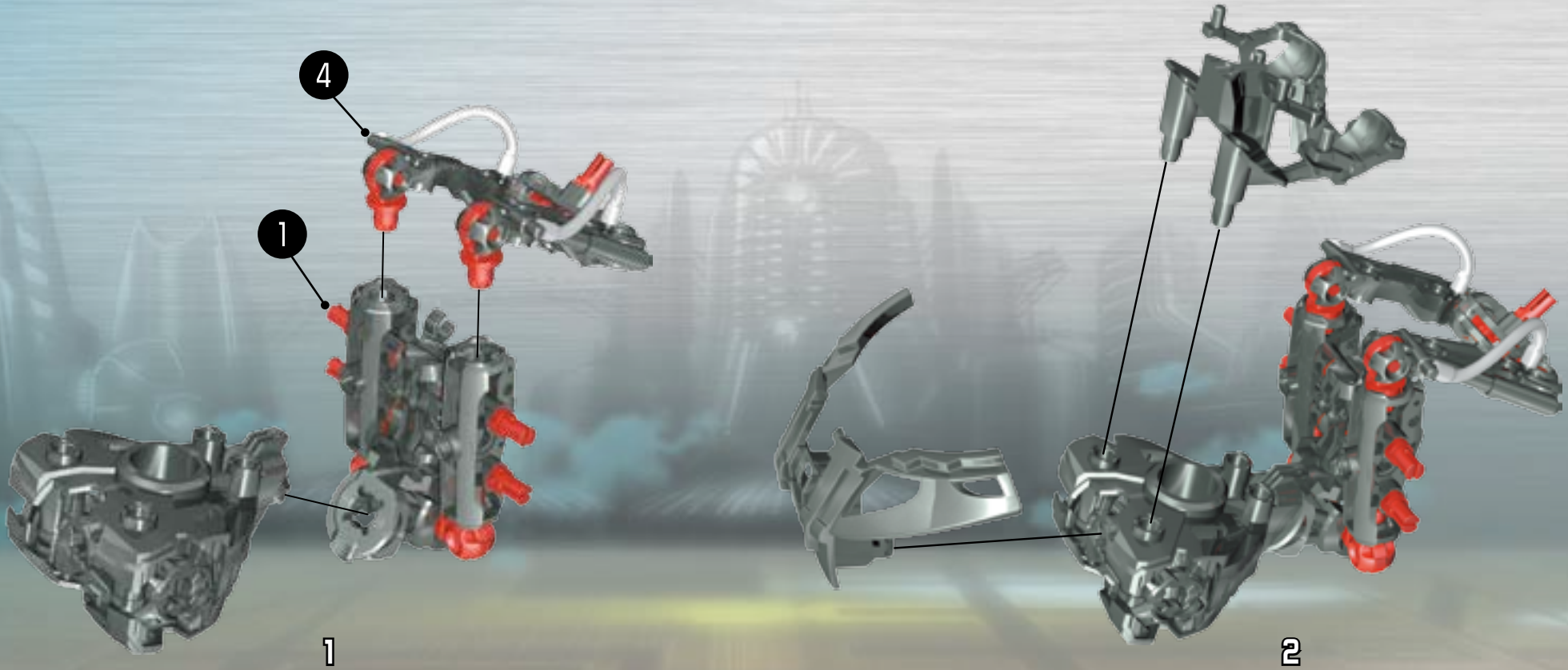

1

2

6



1x

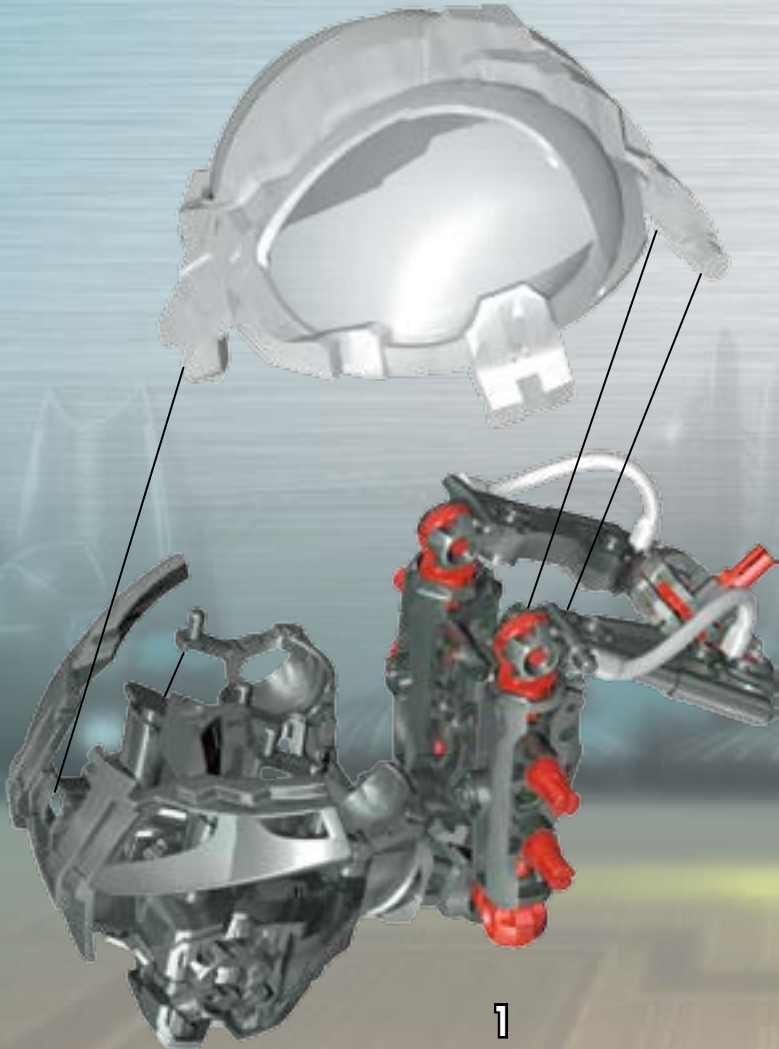

1

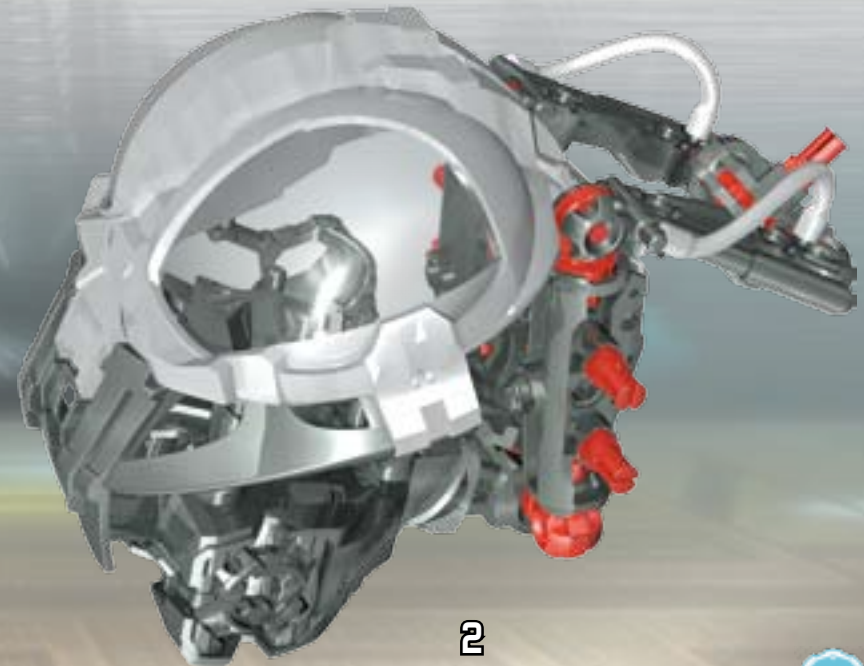

2

7



1x



1x



1x



1x

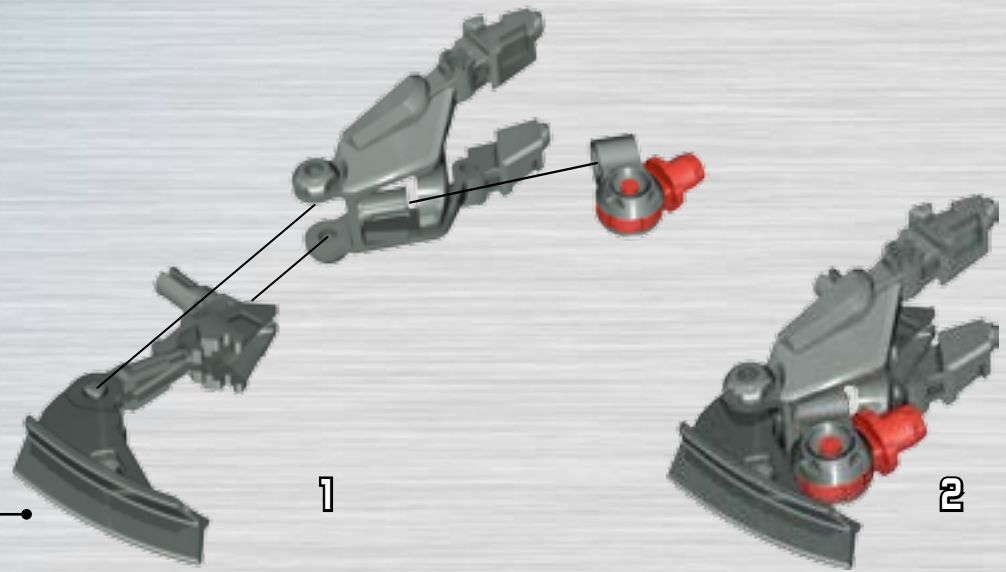

8



1x



1x



1x



1x

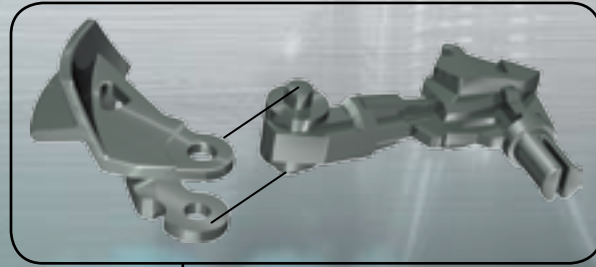

9

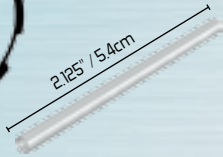
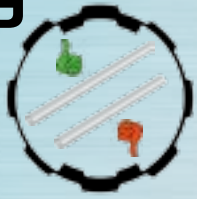

1x



1x



1x



1x



1x

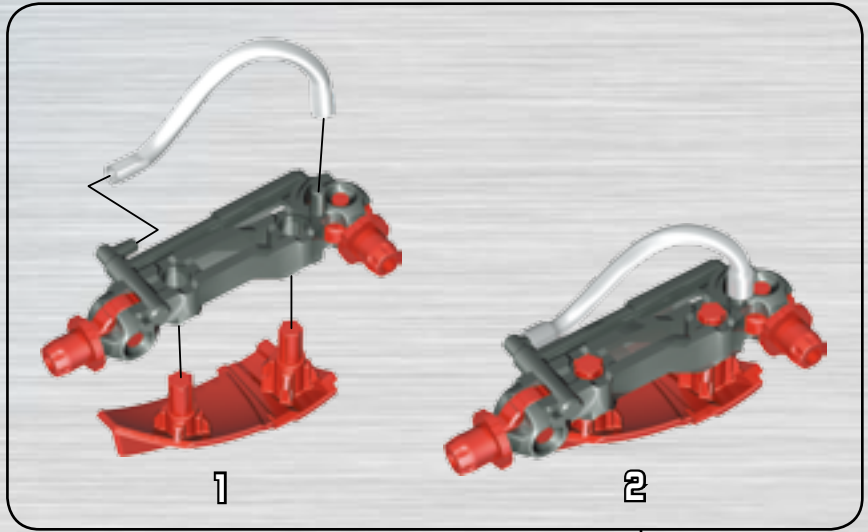

1

2

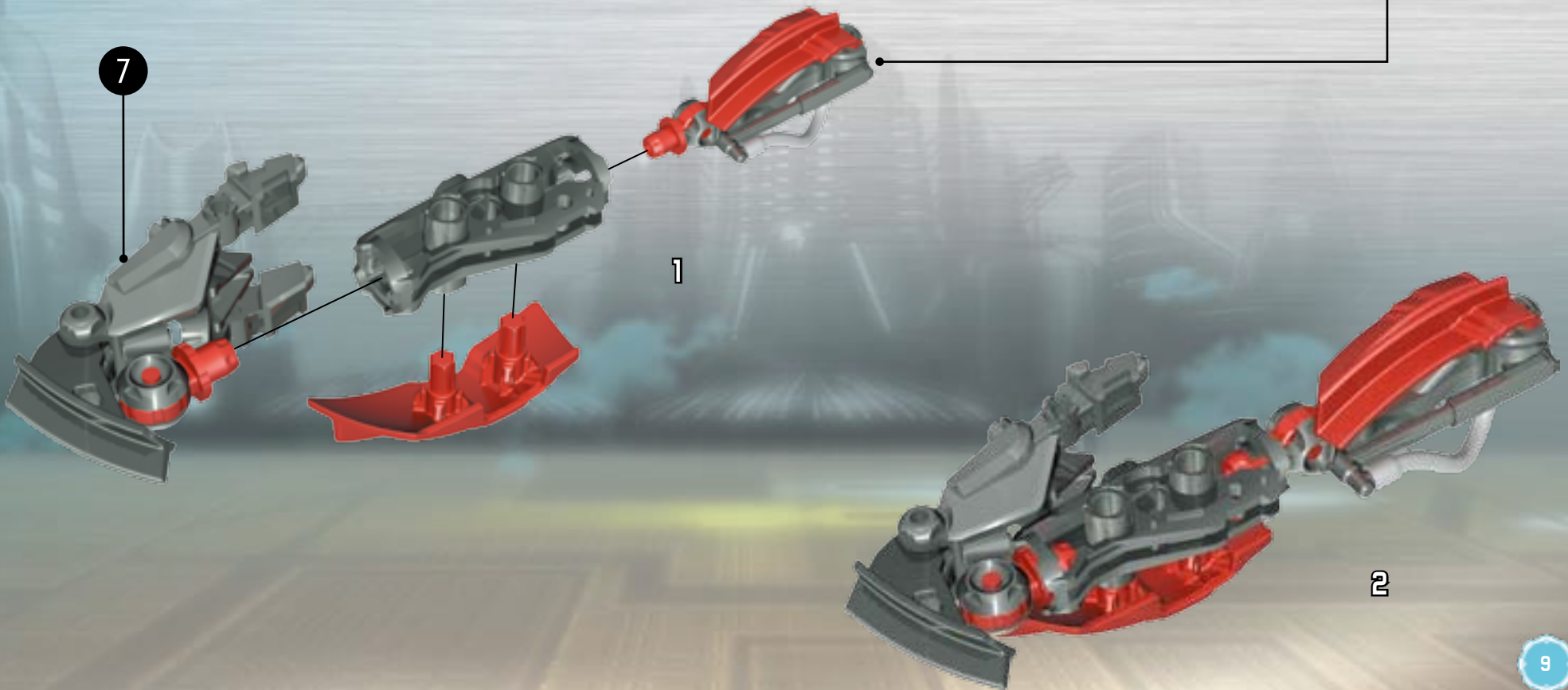

7

1

2

10

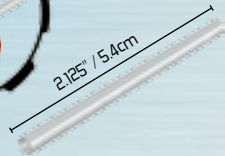

1x



1x



1x



1x



1x

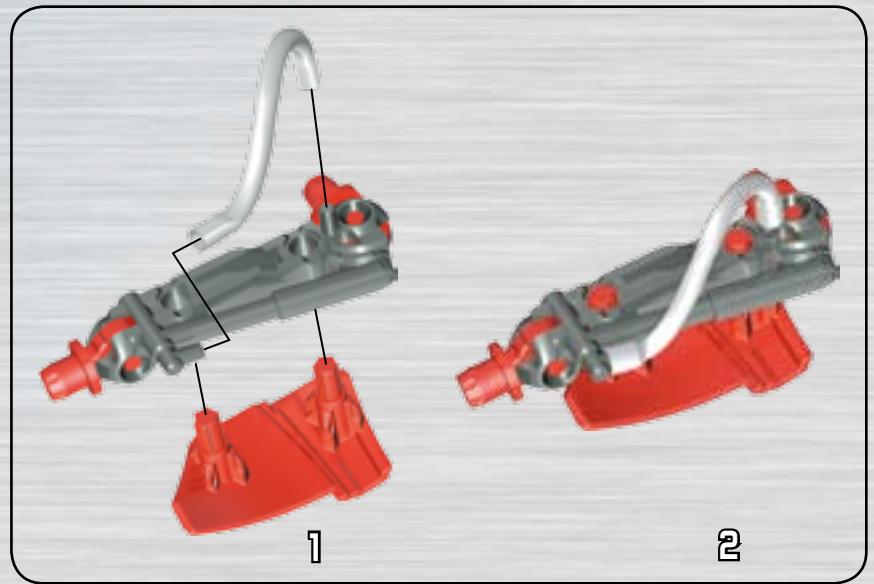

1

2

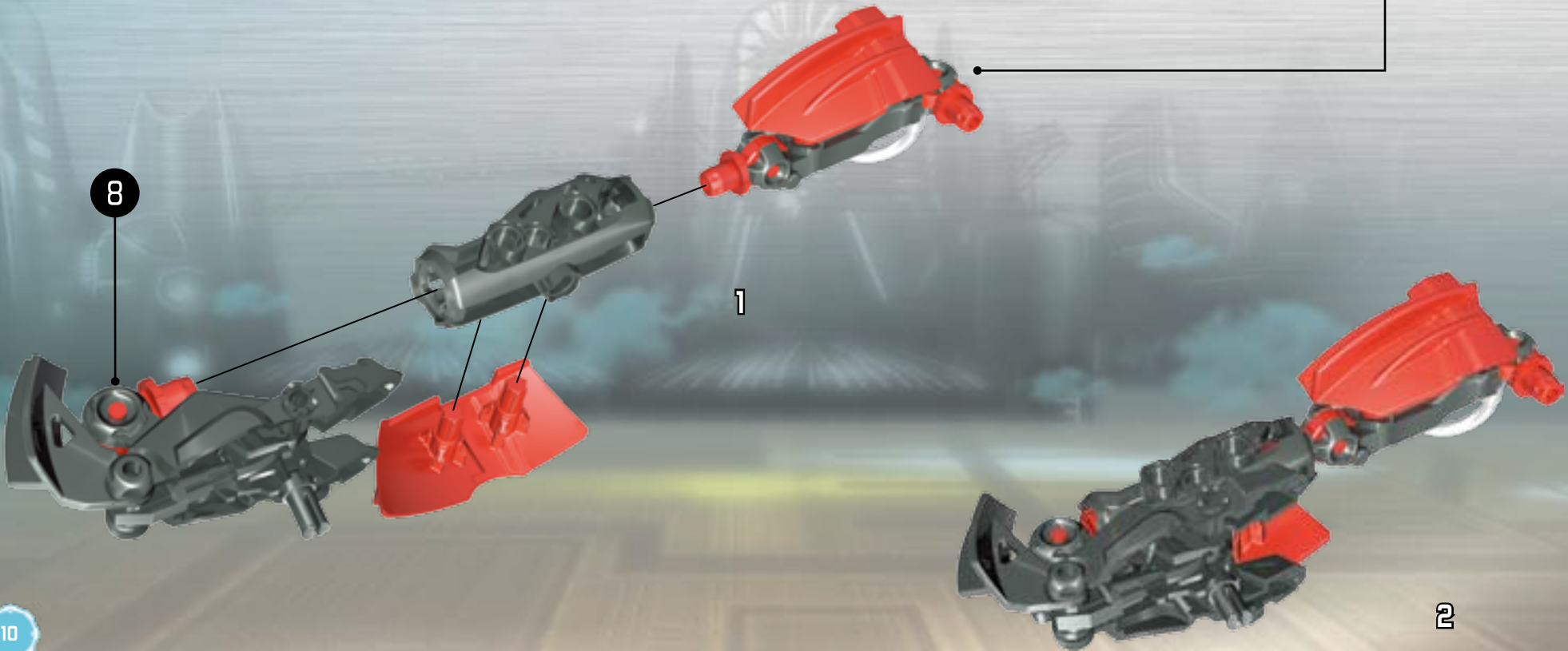

8

1

2

11

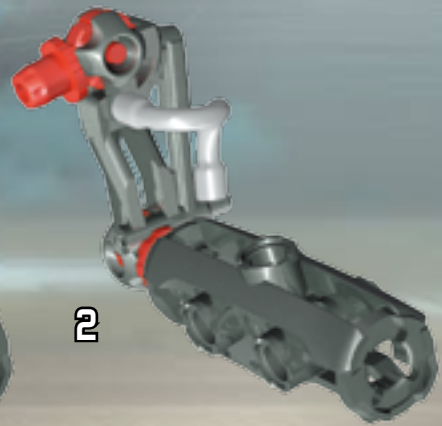
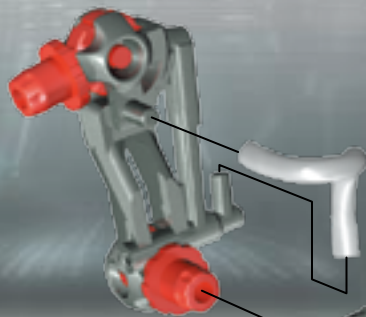
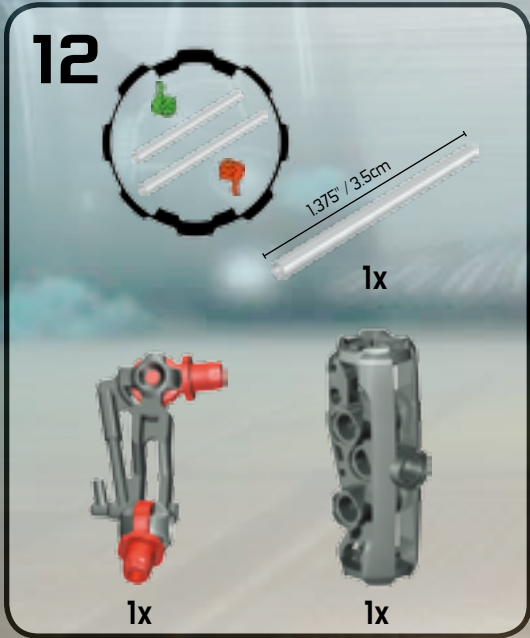
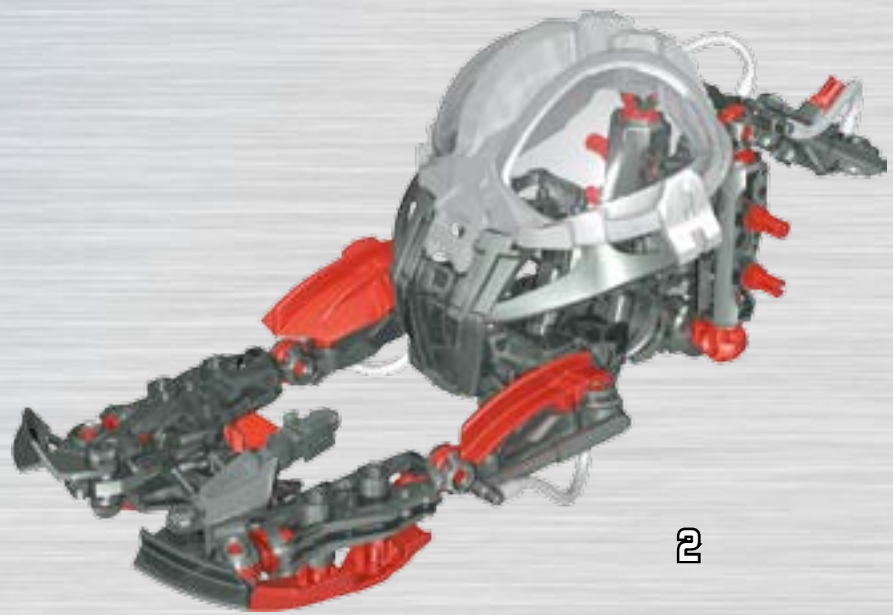
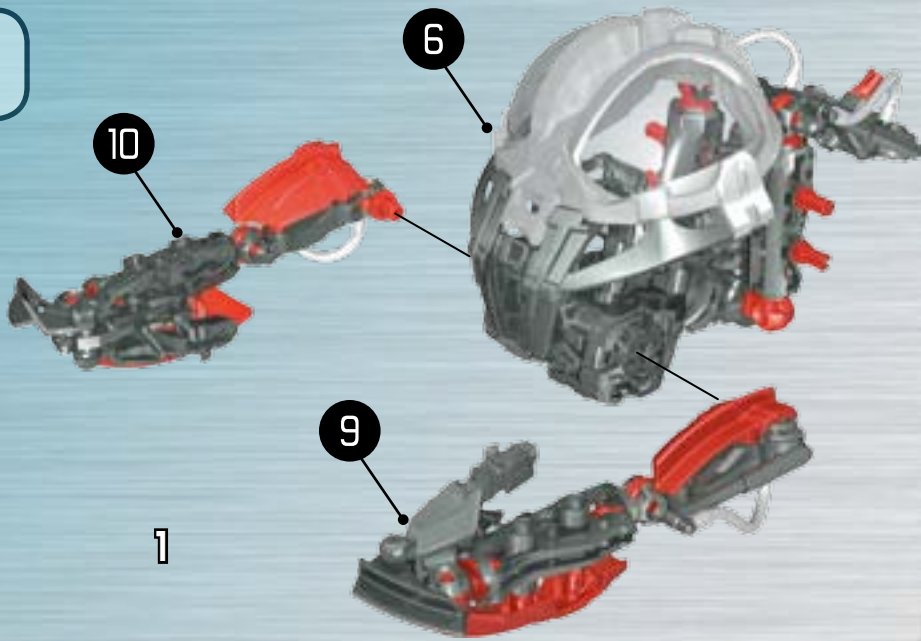

11

13



2x



1x

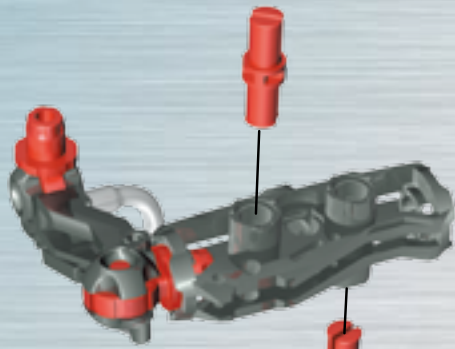

1



2

14



1x



1x



1x

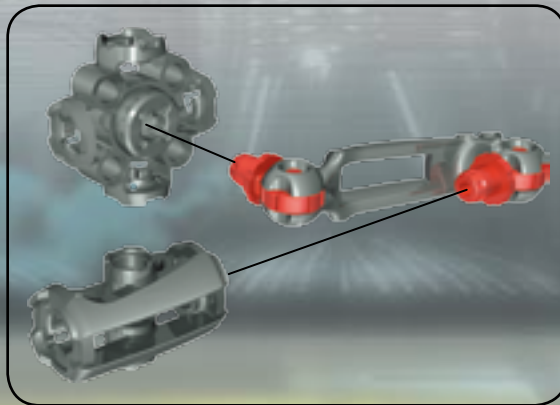

15



2x

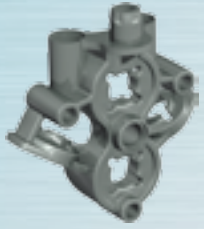

1x

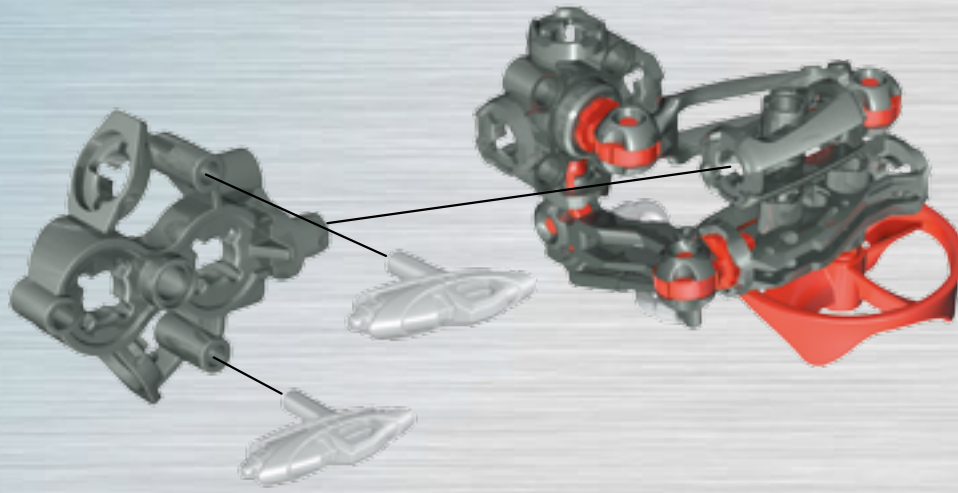

16



3x

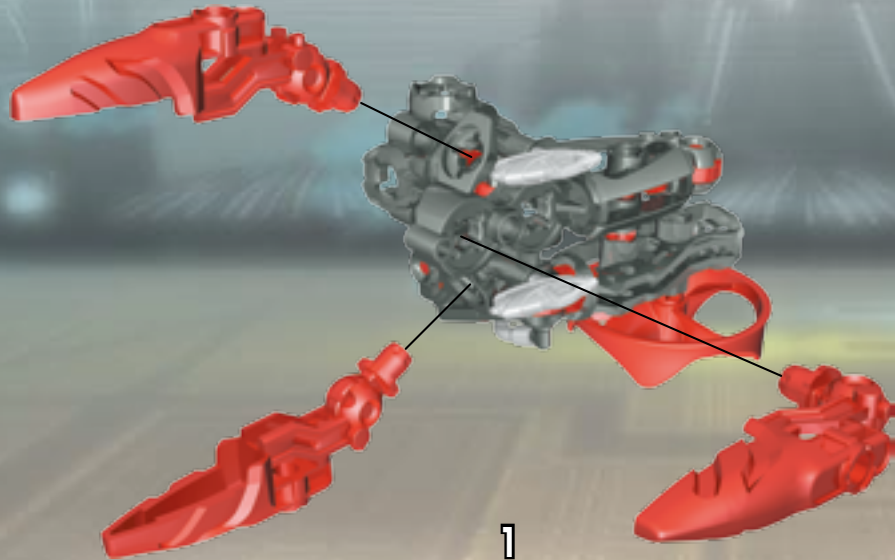

17

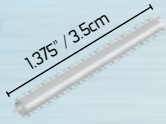

1x



1x



1x

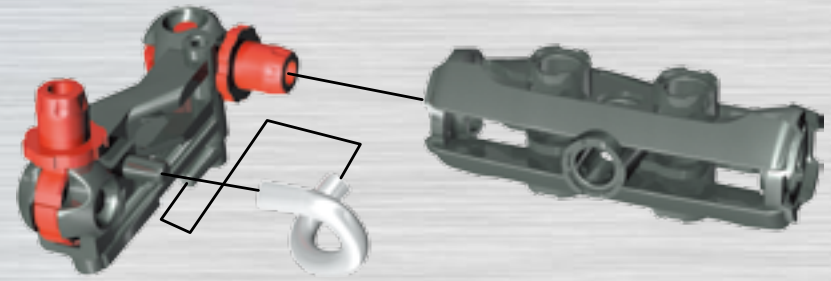

18



2x



1x

19



1x



1x



1x



1



2

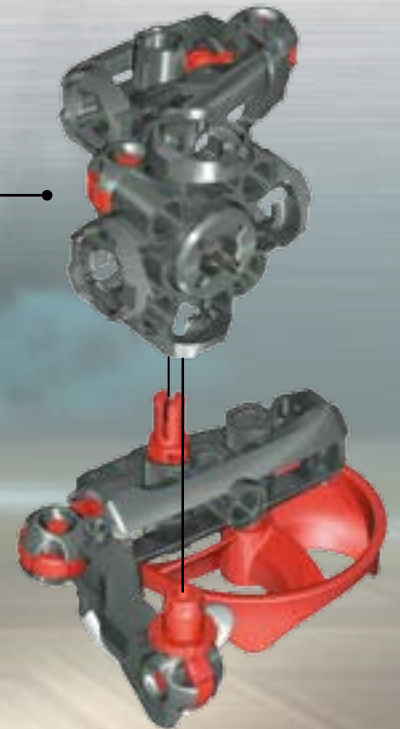
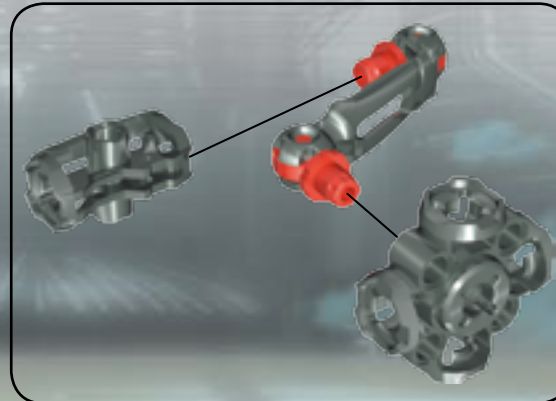

20



2x

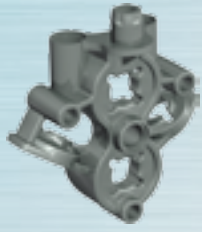

1x

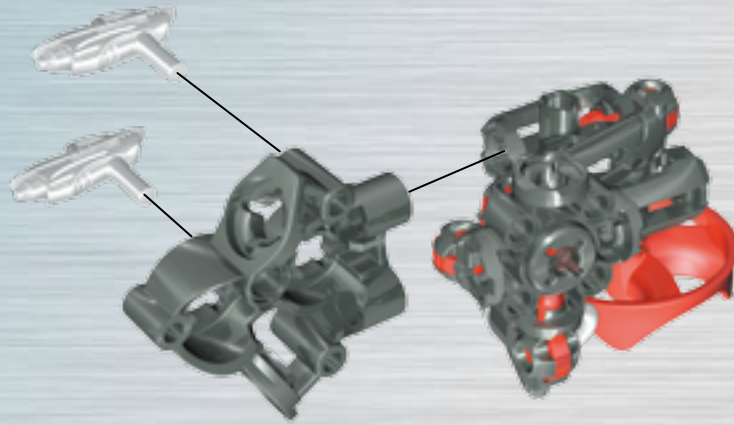

21



3x

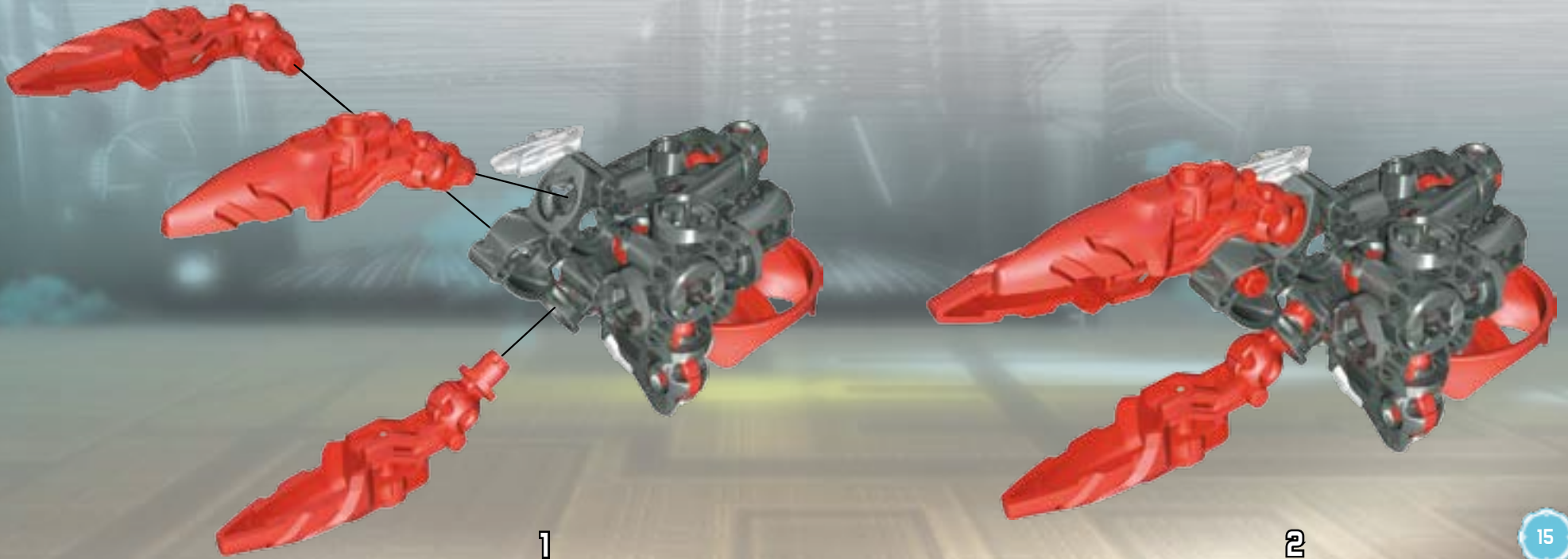

1

2

22



2x



2x



1x

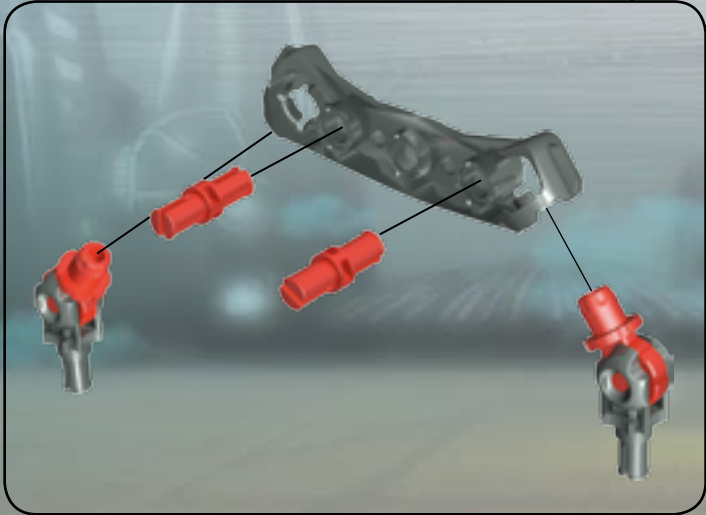
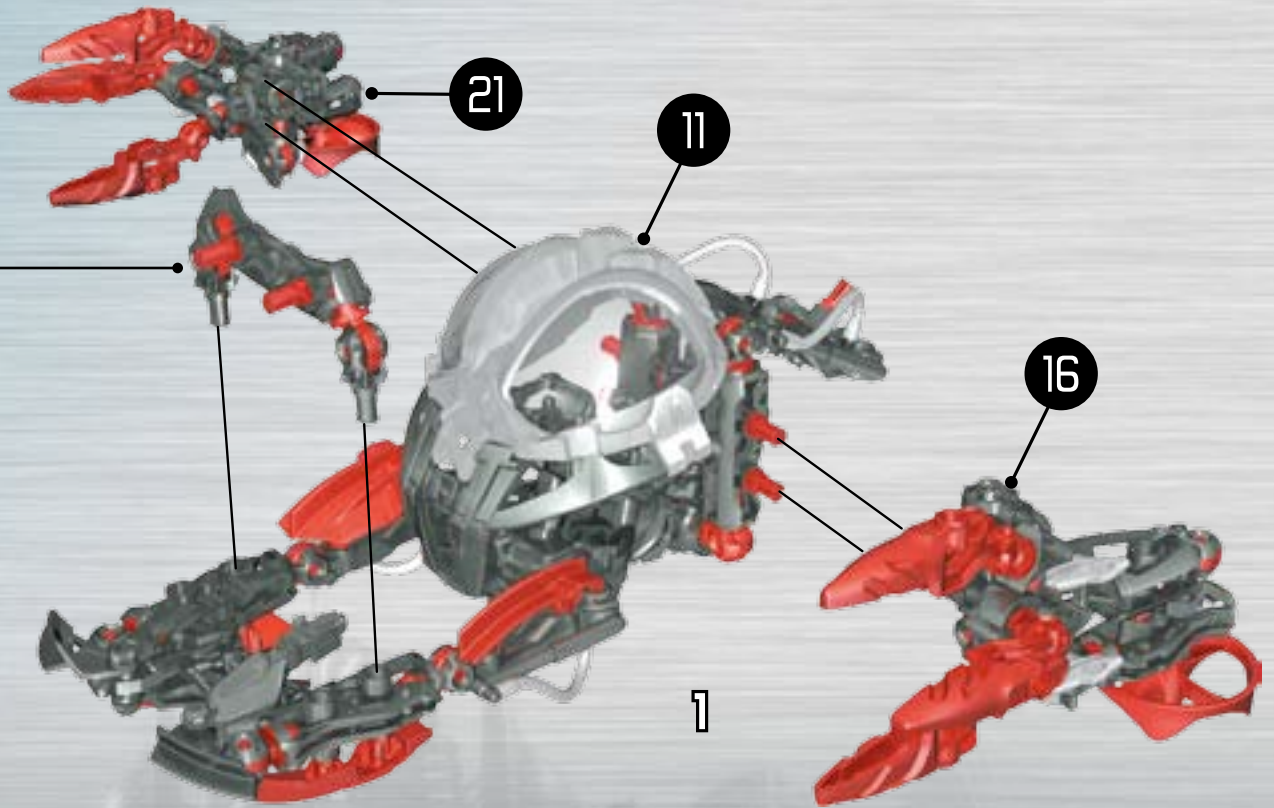

23



2x



1x



1x



1x



1x

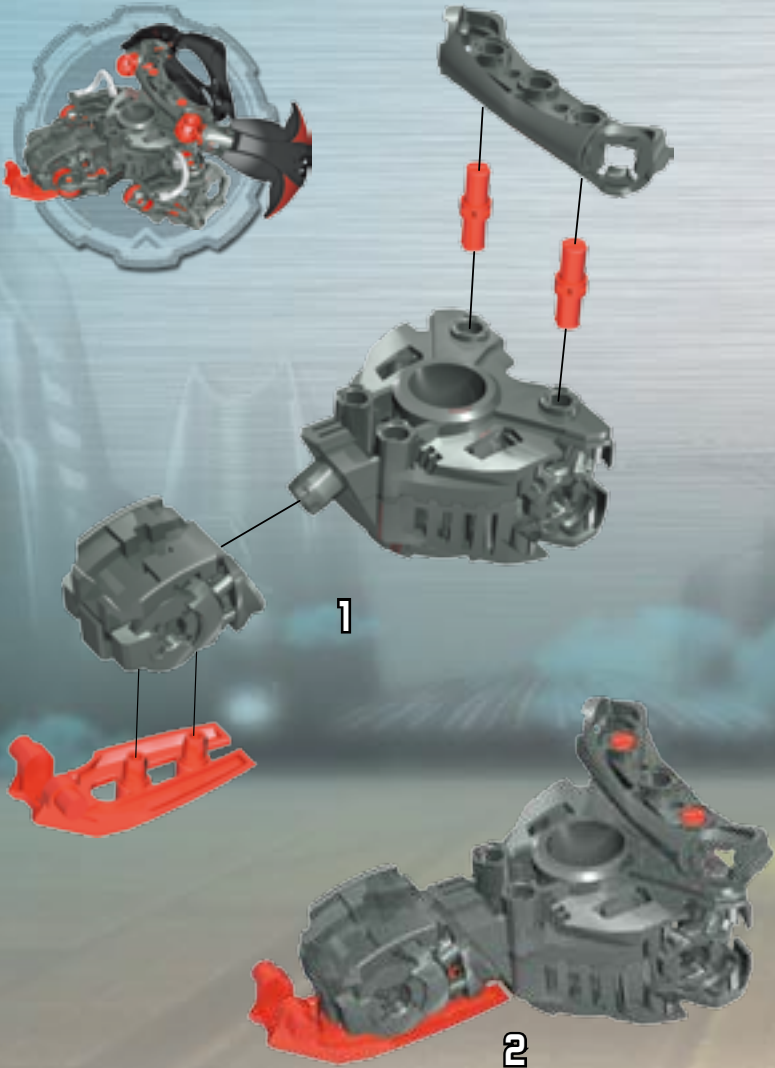

24



1x



1x



1x



25



1x



1x



1x

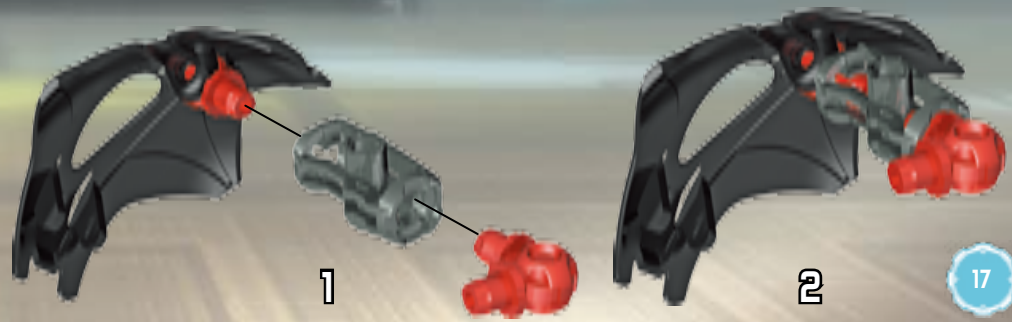

26

27

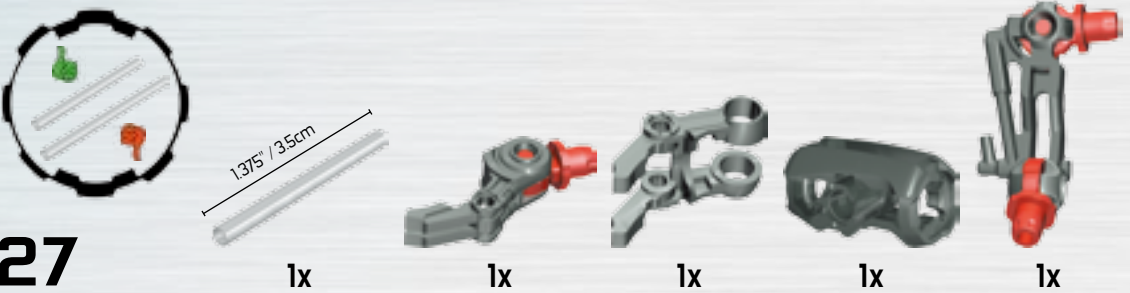

1x 1375 / 35cm

1x 1x 1x 1x 1x

Detailed description: This block contains a parts list for step 27. It features a circular inset showing a green Technic bush, a grey Technic axle, and a red Technic pin. To the right is a long grey Technic axle with a dimension line indicating a length of 1375 / 35cm. Further right are five individual parts, each labeled '1x': a grey Technic arm with a red pin, a grey Technic bracket with two holes, a grey Technic bush, a grey Technic bush with a red pin, and a grey Technic arm with a red pin.

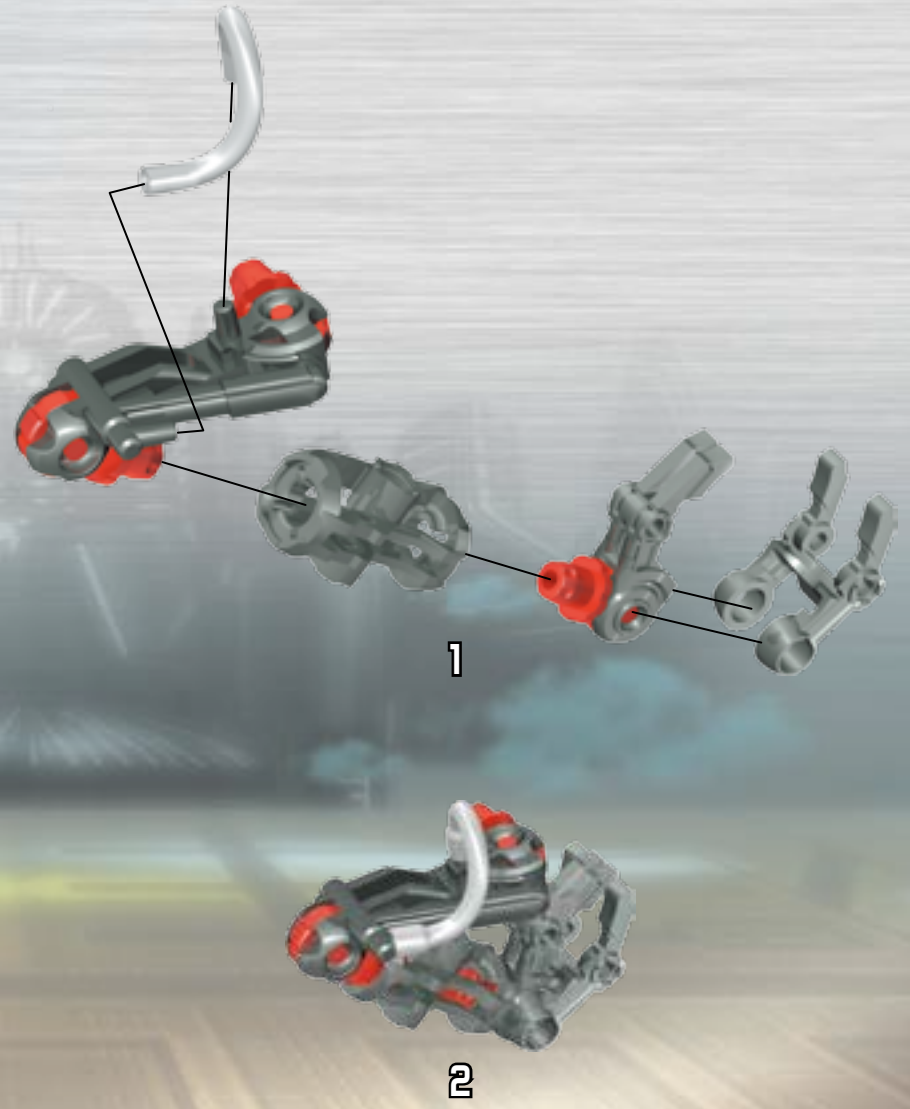

28



1x



1x



1x



1x



1x

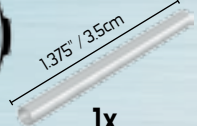

1x

29



2x

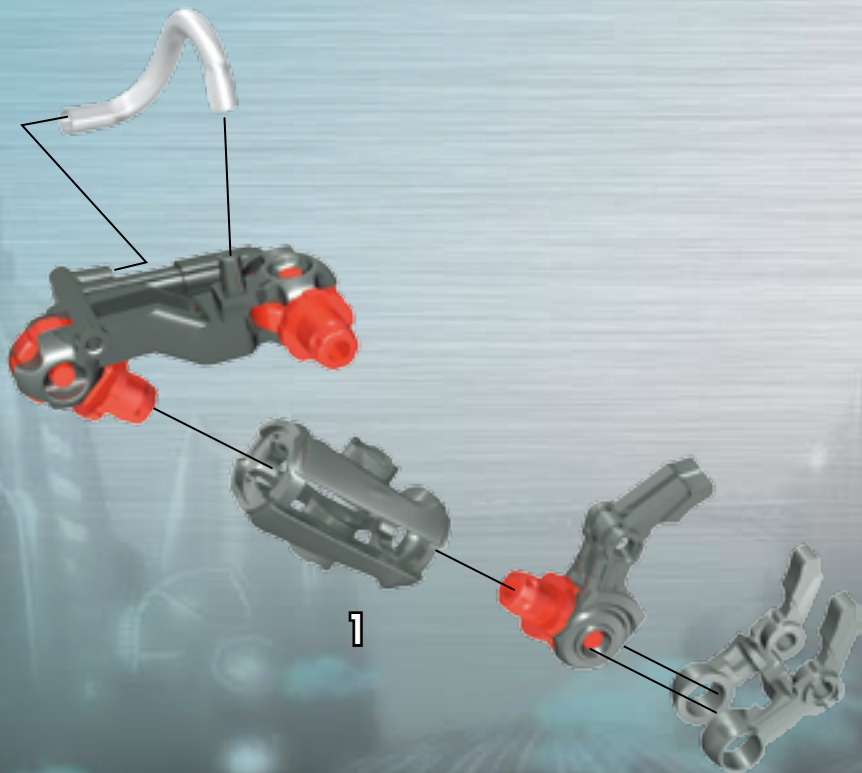

1

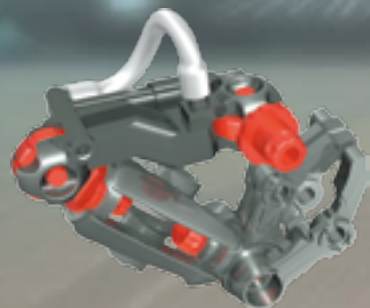

2



28

1

27



2

30



2x



1x



1x

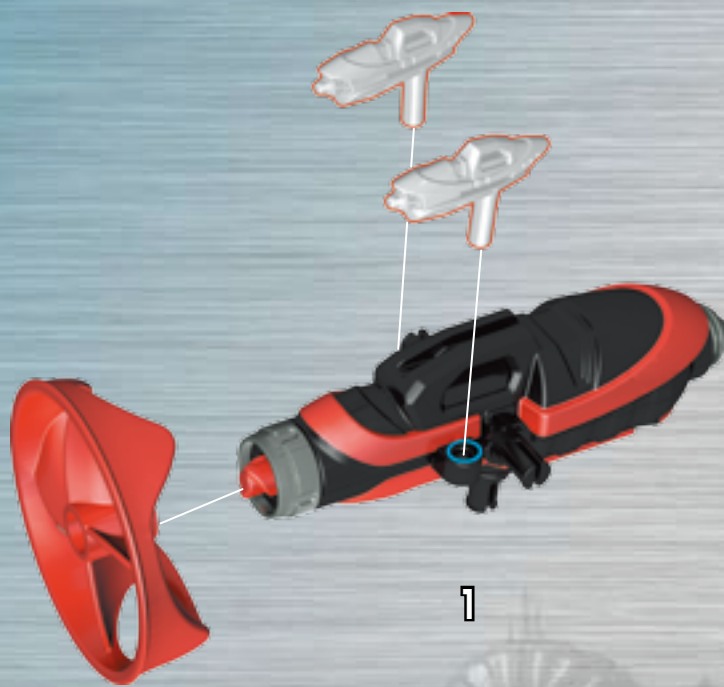

1



2



30

29

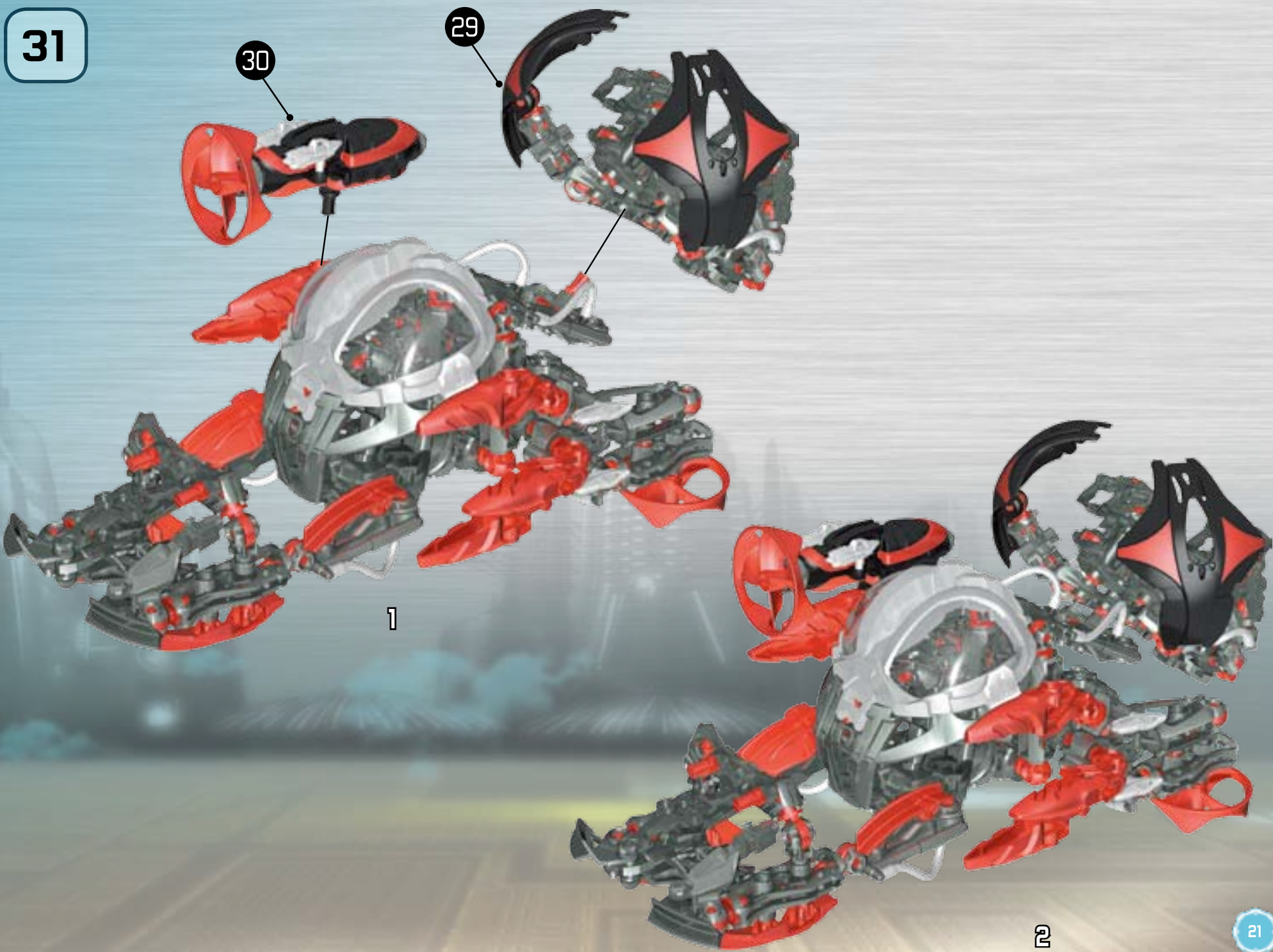

1

2

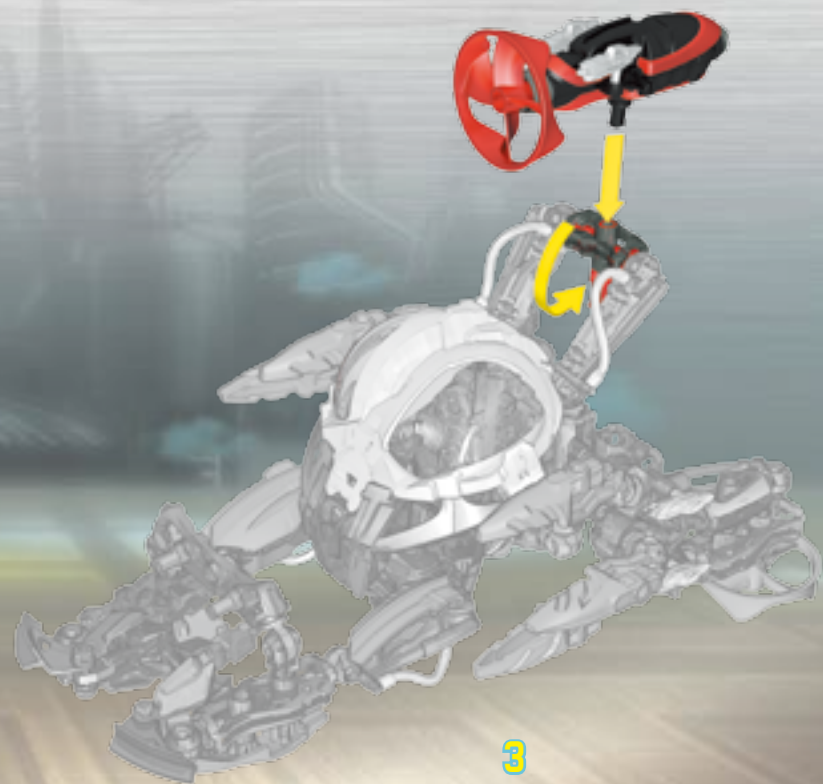
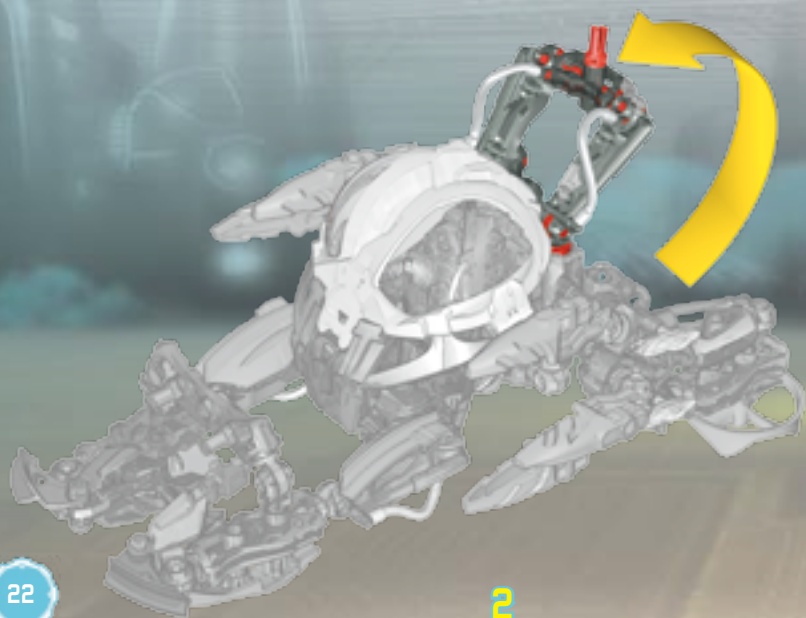
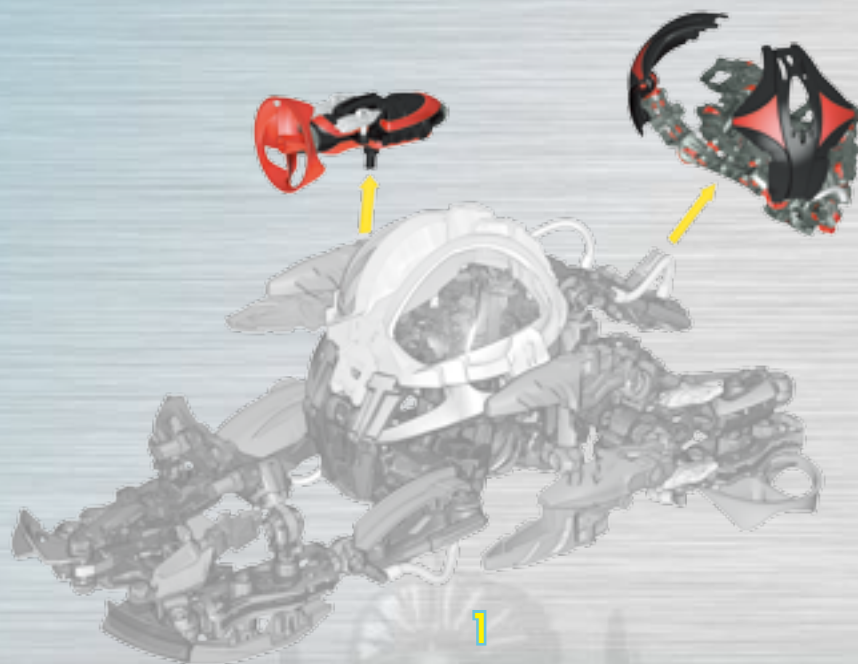



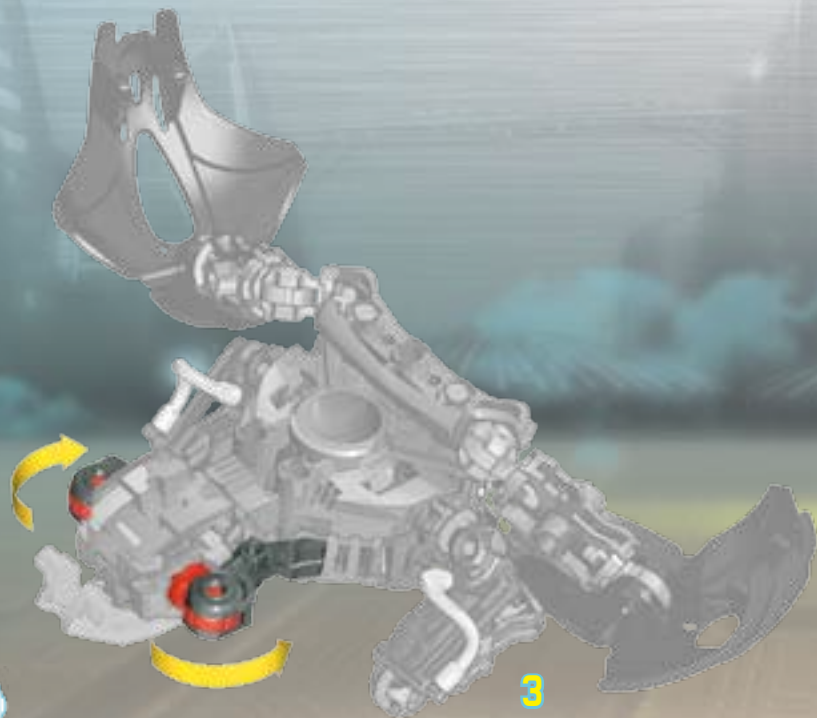
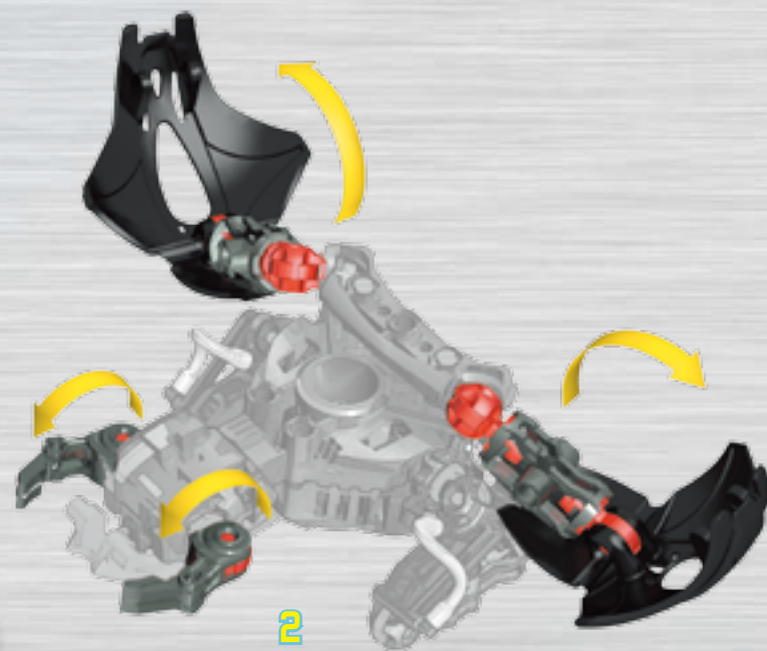



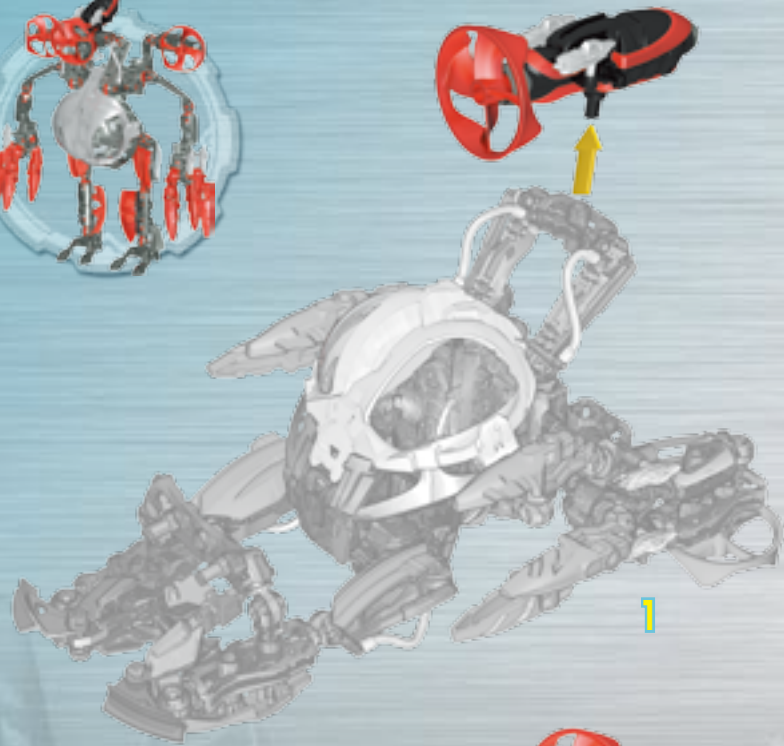

1

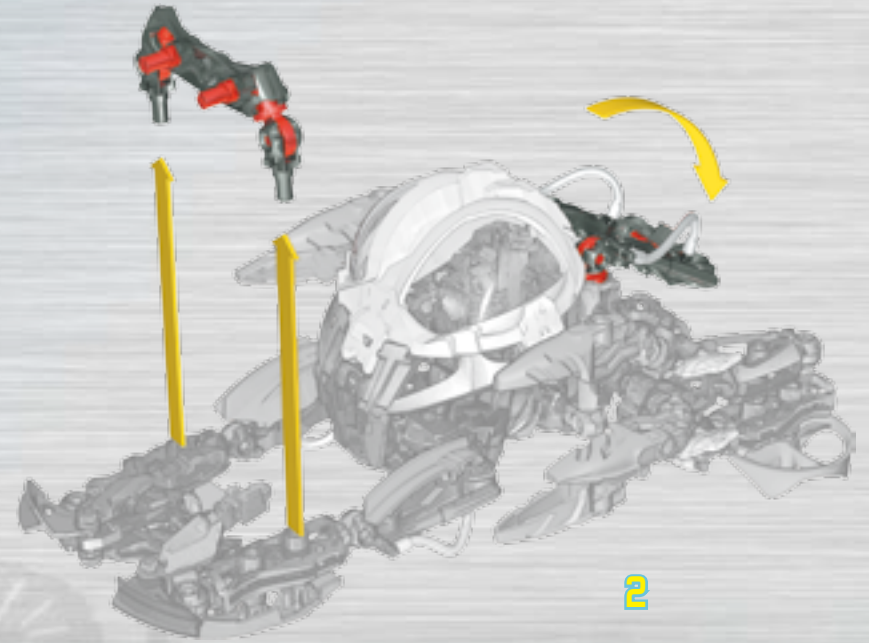

2

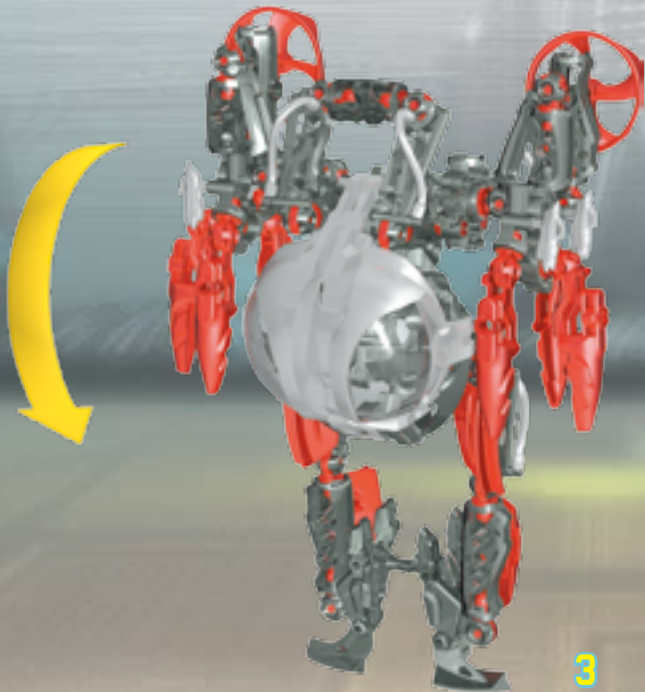

3



4

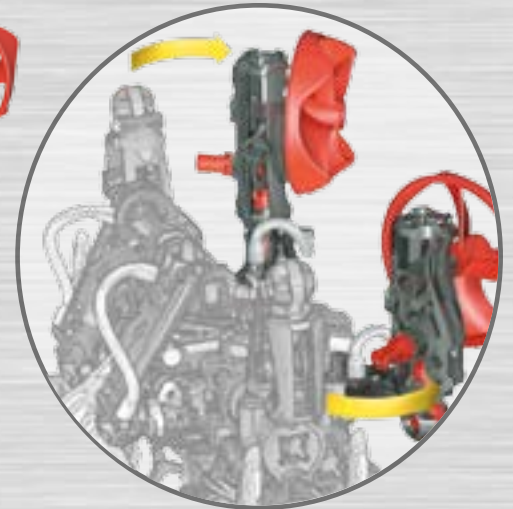
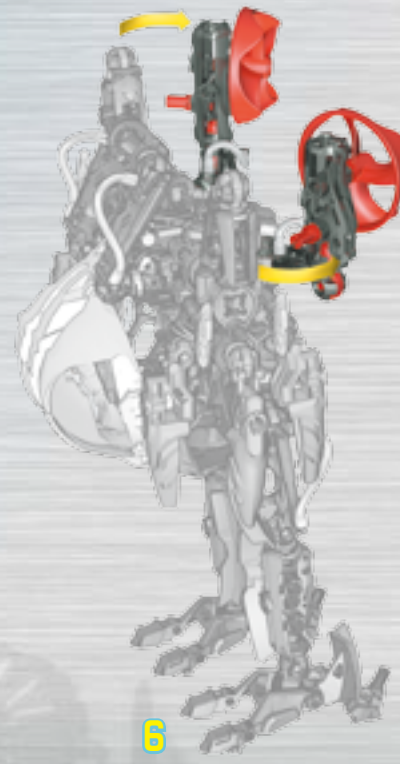

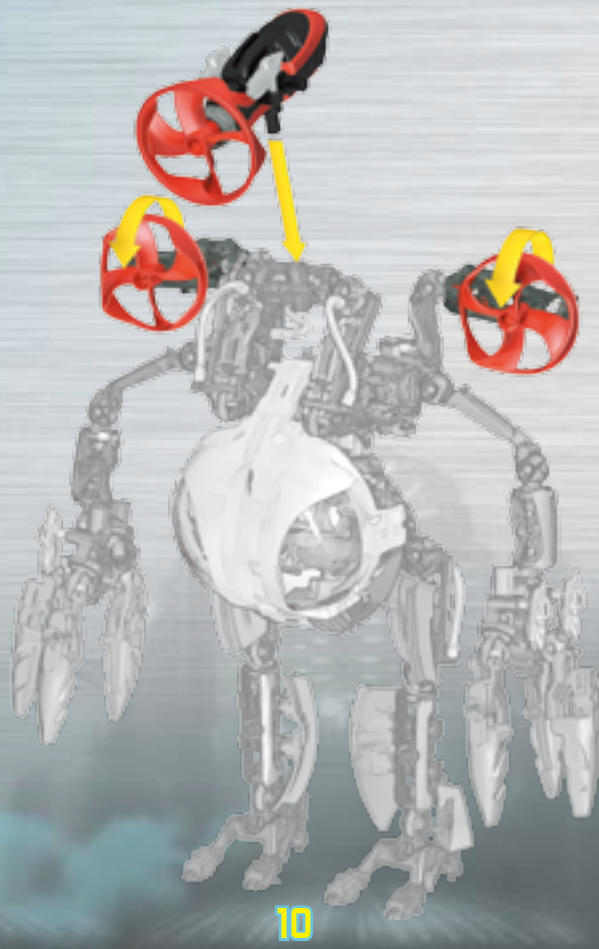
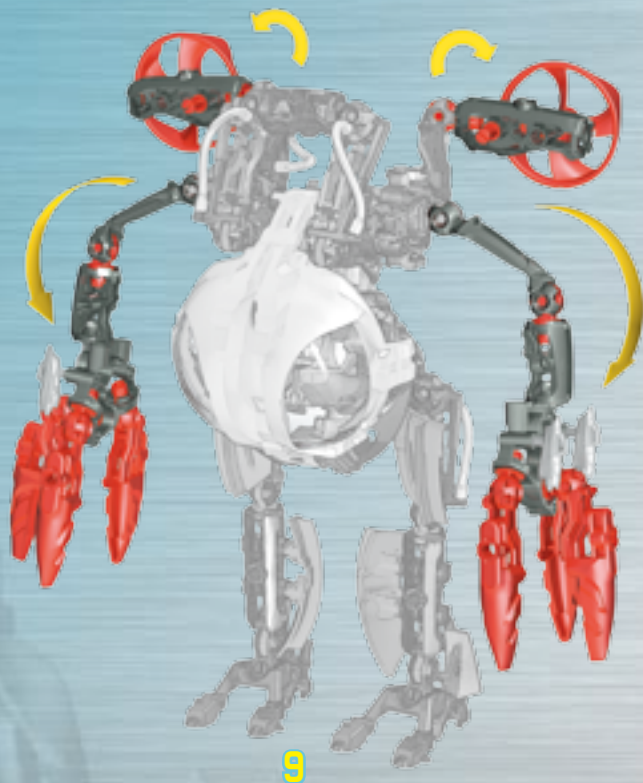



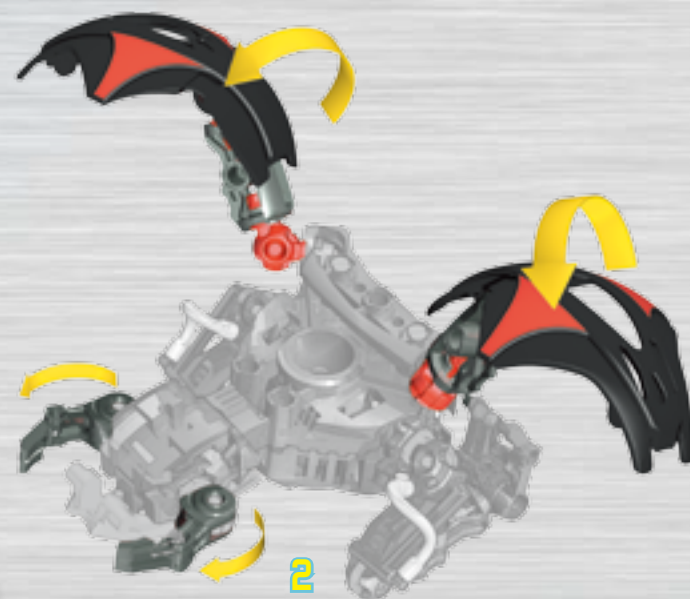
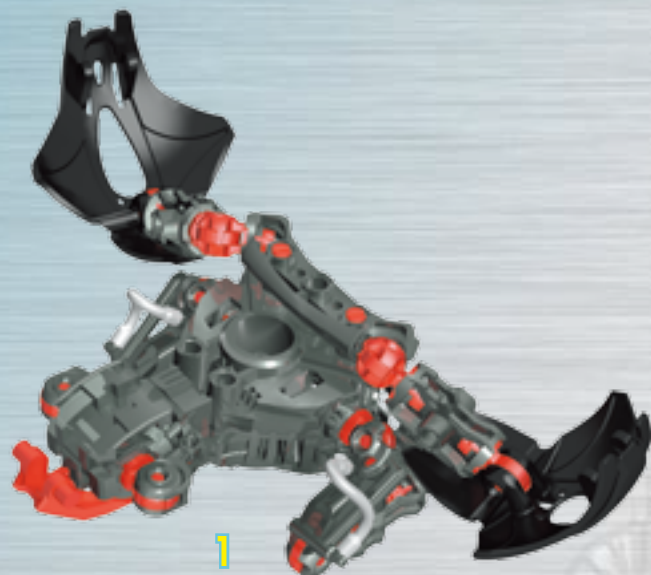



NEO SHIFTERS

3 exclusivos Neo warriors
 3 guerreros Neo exclusivos
 3 guerriers Neo exclusifs
 3 exclusivos Neo-rijders
 3 exclusivos Neo-rijders
 3 exclusivos Neo-rijders
 3 exclusivos Neo-rijders



5 toys in 1
 5 juguetes en 1
 5 jouets en 1
 5 speelzette in 1
 5 speelzette in 1
 5 giocattoli in 1
 5 brinquedos em 1

TEMPLAR



Also available
 También disponible
 Egalement disponible



6330



6328



6321



6333

6338

Ebenfalls erhältlich
 Egalement disponible
 Anche disponibile
 Também disponível



6325



6324



6333

PALADIN



Griffe
 Se transforme
 Se transforme
 Verwandelt sich
 Transformiert
 Si transforma
 Transforma-se



© 2008, MEGA Brands Inc.
 MEGA Brands Inc. and the MEGA Brands Inc. logo are registered trademarks of MEGA Brands Inc. / MEGA Brands Inc. y el logotipo MEGA Brands Inc. son marcas registradas de MEGA Brands Inc. / MEGA Brands Inc. et le logo de MEGA Brands Inc. sont des marques de commerce déposées de MEGA Brands Inc. / MEGA Brands Inc. und das MEGA Brands Inc.-Logo sind eingetragene Warenzeichen von MEGA Brands Inc. / MEGA Brands Inc. en het MEGA Brands Inc. logo zijn gedeponeerde handelsmerken van MEGA Brands Inc. / MEGA Brands Inc. ed il logo di MEGA Brands Inc. sono marchi di fabbrica di MEGA Brands Inc. / MEGA Brands Inc. e o logo MEGA Brands Inc. são marcas registradas de MEGA Brands Inc.
 Printed in China AD063481A

TRAXX TURBINE