



For On-line games go to:  
Para jogos em linea, visita:  
Pour les jeux en ligne, rendez-vous sur:  
Hier findest du Online-Spiele:  
Go voor online games naar:  
Per giocare online vai all'indirizzo:  
Para acederes a jogos em rede:  
[www.neoshifters.com](http://www.neoshifters.com)

Web code / Code Web  
Código web / Web-Kode  
Codice Web / Código Web



# NEO SHIFTERS



TEMPLAR™



6374 RANDIUS Ⓞ KA™

Radius<>Ka emerges from the cold ground, retracting his unscrupulous Telluric Shield, he blows up the gates of the rival's bunkers and unveils its lucrative plunder. Telluric Shield - sprays armor-piercing shrapnel to shred infantry or, alternately, form a single-targeted explosion to destroy heavy vehicles or perform demolition work.

Radius <> surge de la tierra fría desplegando su inescrupuloso Escudo Telúrico, que destruye las puertas de los búnkeres enemigos y revela sus ricos botines. El Escudo Telúrico puede destroz ar ejércitos con su metralleta, también generar grandes explosiones dirigidas para destruir vehículos pesados o provocar demoliciones.

Radius<>Ka surgit du sol froid en retirant son bouclier tellurique sans scrupules, il fait sauter la porte de l'abri fortifié du rival et dévoile son riche butin. Le bouclier tellurique répand des obus à balles perce-armure pour dépecer l'infanterie, ou alors, pour former une explosion à cible unique visant à détruire les véhicules lourds ou à exécuter des travaux de démolition.

Radius<>Ka kommt aus der kalten Erde, zieht seinen skrupel-losen Tellurischen Schild zurück und sprengt die Tore zum Bunker seines Rivalen. Dort findet er reiche Beute. Tellurischer Schild - sprüht panzerbrechendes Schrapnell gegen Infanterie oder erzeugt eine Einzelziel-Explosion, um schwere Fahrzeuge zu vernichten oder etwas zu demolieren.

"Radius<>Ka duikt op uit het niets en vanachter zijn niet-sontziende Telluric Shield blaast hij de poorten op van de schuilplaatsen van zijn rivaal zodat de kostbare buit voor het grijpen ligt. Telluric Shield - braakt pantserdoorborende kartetsgranaten uit om de oprukkende infanterie te vermorzelen of een geconcentreerde explosie te veroorzaken die zware voertuigen vernietigt of om ander vernielend werk te doen.

"Radius<>Ka emerge dal suolo ghiacciato ritraendo il suo corrotto Scudo Tellurico, fa esplodere i cancelli del bunker del rivale e ne scopre il ricco bottino. Scudo Tellurico - spara dei proiettili perforanti per massacrare la fanteria o, in alternativa, provoca una singola esplosione mirata per distruggere veicoli pesanti o per lavoro di demolizione"

"Radius<>Ka emerge do chão frio, encolhendo o seu Escudo Telúrico inescrupuloso, destrói os portões dos bunkers do rival e apresenta o seu lucrativo espólio. O Escudo Telúrico - lança granadas defensivas para a infantaria destruída ou, alternativamente, provoca uma explosão de alvo único para destruir veículos pesados ou realizar trabalho de demolição."

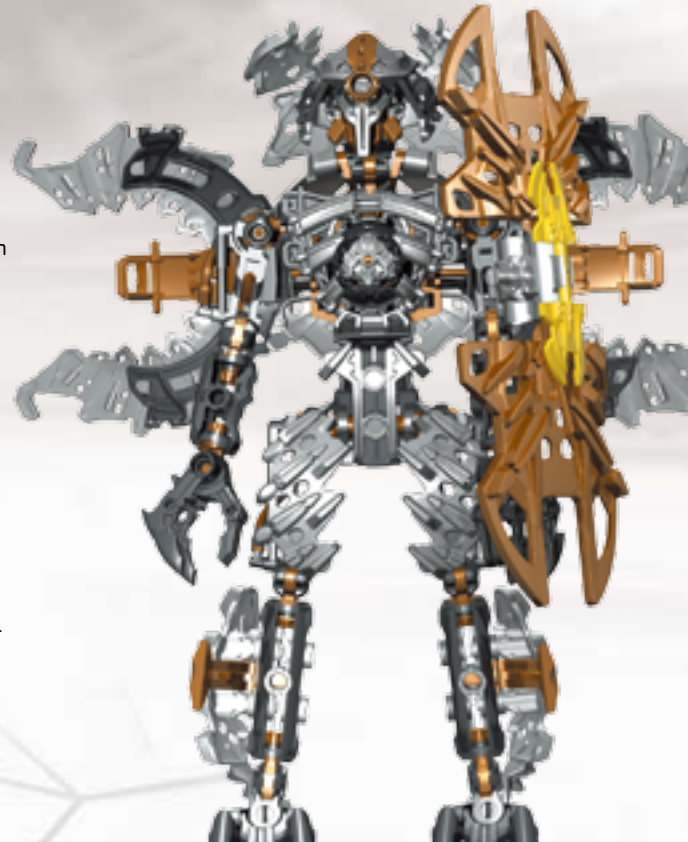

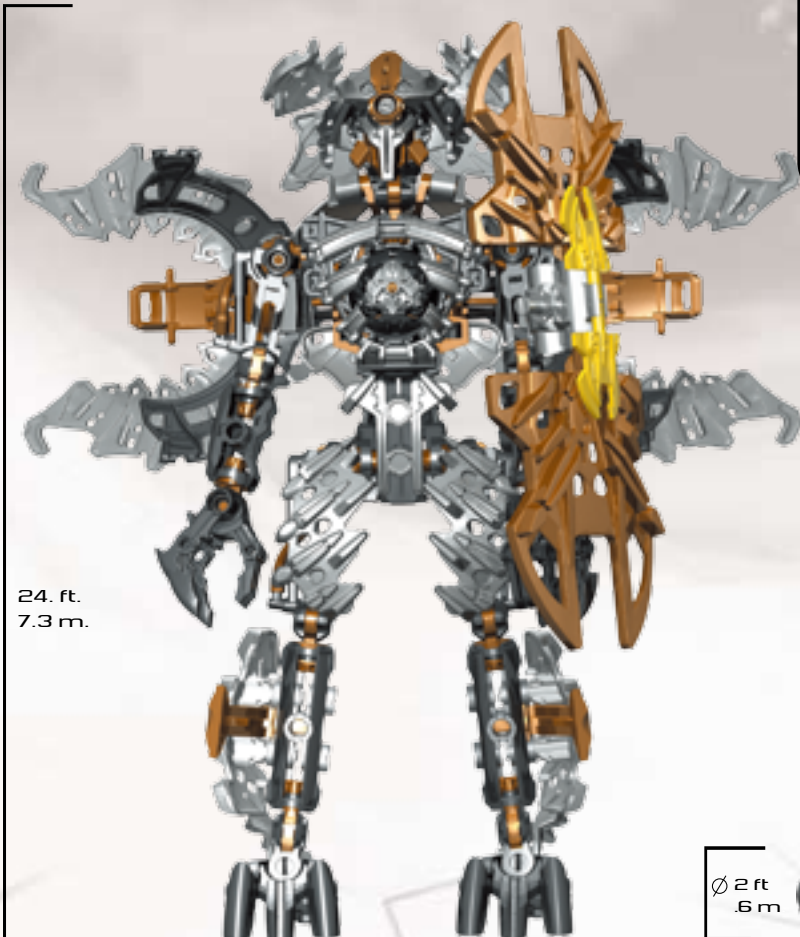

24. ft.  
7.3 m.



HYDRAX™

Hydrax™ Energy Level  
Nivel de energia Hydrax™  
Niveau d'énergie Hydrax™  
Hydrax™-Energiegrad  
Hydrax™ Krachtniveau  
Livello Energia Hydrax™  
Nivel de energia do Hydrax™



SKILL

Skill  
Técnica  
Technique  
Geschicklichkeit  
Bekwaamheid  
Specialità  
Habilidade



WEAPON

Weapon  
Arma  
Arme  
Waffe  
Wapen  
Arma  
Arma



DEFENSE

Defense  
Defensa  
Defense  
Verdediging  
Verdediging  
Difesa  
Defesa

4. ft.  
1.2 m.



6. ft.  
1.8 m.



∅ 11.3 ft.  
3.4 m.



∅ 2 ft.  
.6 m







1x  
AS063742



1x  
AS063743



1x  
AS063741D



1x  
AS063741



1x  
AM15372KJ



1x  
AM15373KJ



1x  
AM15378KJ



1x  
AM15377KJ



1x  
AM09808RJ



1x  
AS063741B



1x  
AS063746



2x  
AM09734KM



2x  
AM15368KM



2x  
AM15369KM



1x  
AM15370KJ



1x  
AM15371KJ



1x  
AS063747



1x  
AM15374I



1x  
AM15375KJ



1x  
AM15374KJ



2x  
AM16214R5



2x  
AS063744



2x  
AS063745



2x  
AM09806RJ



1x  
AM16213KJ



2x  
AM09727KM



2x  
AM09731KM



1x  
AS063749



2x  
AM15845RJ



2x  
AM16209RJ



1x  
AM15843KJ



1x  
AM15844KJ



1x  
AS063748



2x  
AM15384KM



1x  
AM15376KJ



1x  
AM09810RJ



2x  
AX063741



2x  
AX063742



1x  
AM09788RJ



1x  
AS0637416



SHIFT / TRANSFORMAR / TRANSFORMER /  
WANDELN / ÖMFORMEN / TRASFORMARE / MUDAR

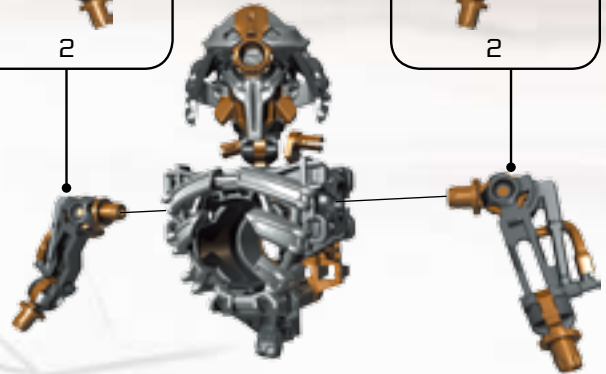
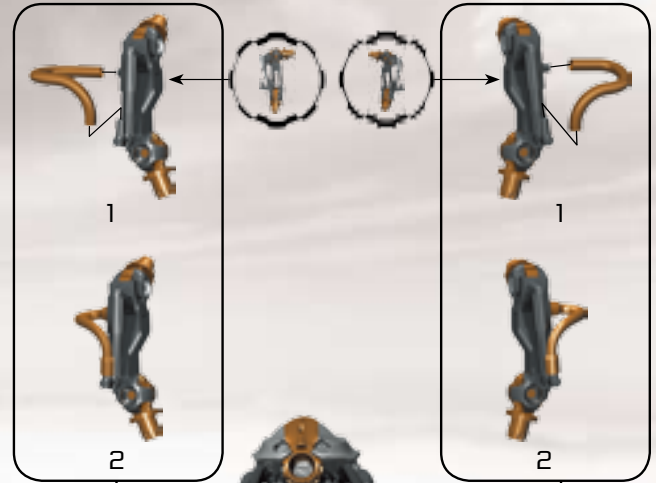
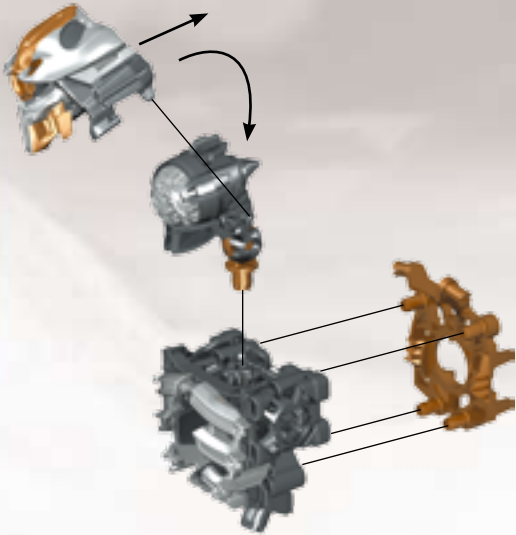
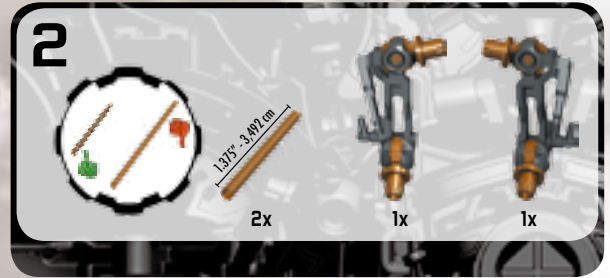
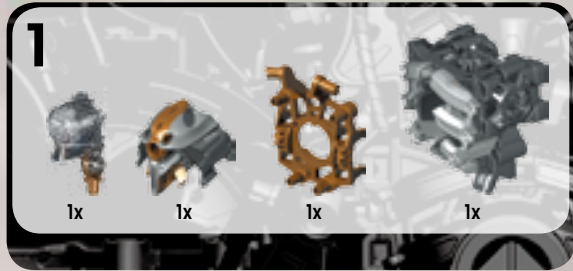

3



2x



2x



2x

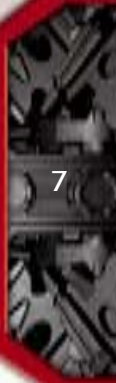
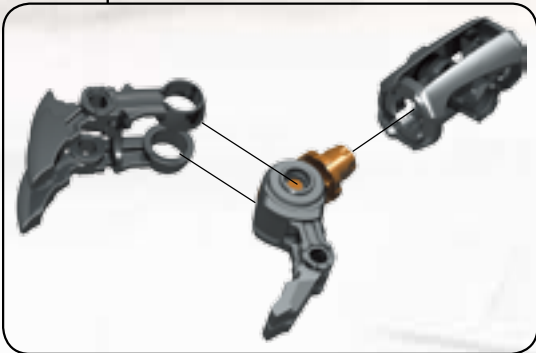
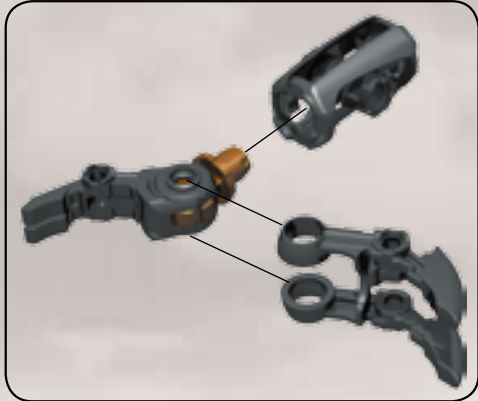

7



4



1x



1x



8

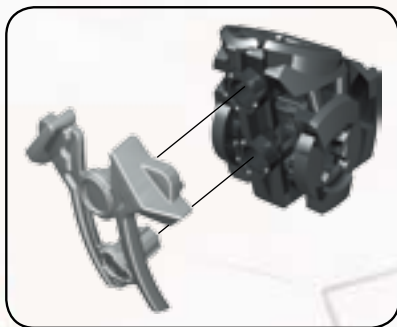



5



2x



1x



1x



1x



1x

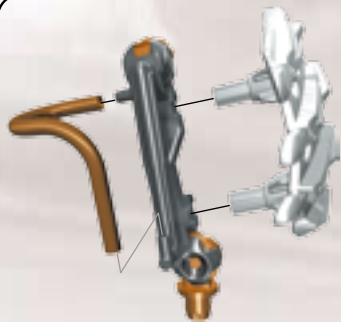

1



2

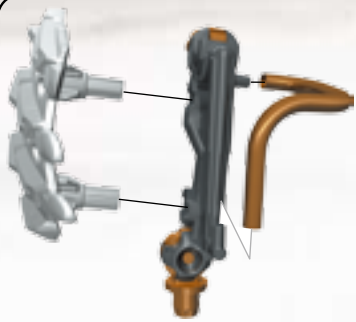

1



2

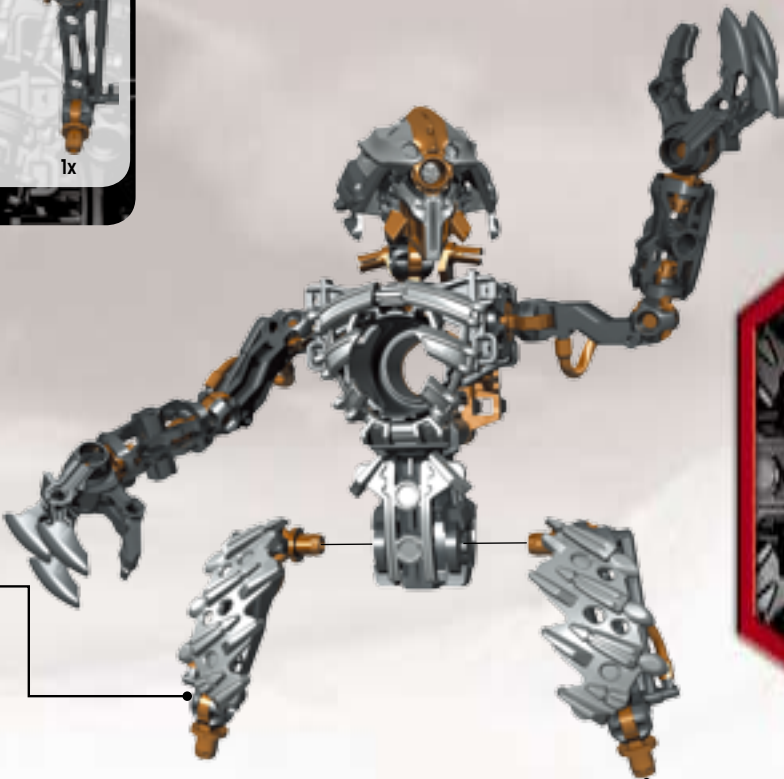

9

6



2x



2x



1x



1x



10

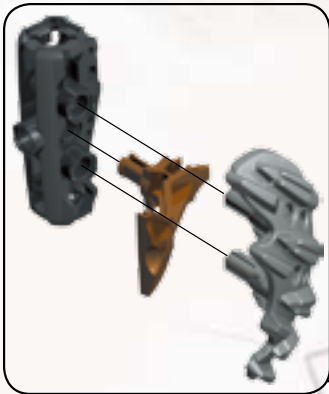
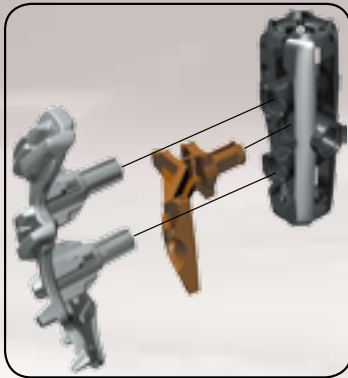

7

2x

1x

1x

2x

2x

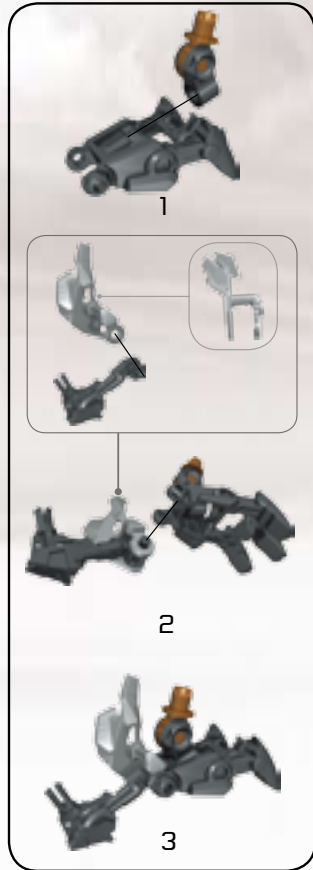



8

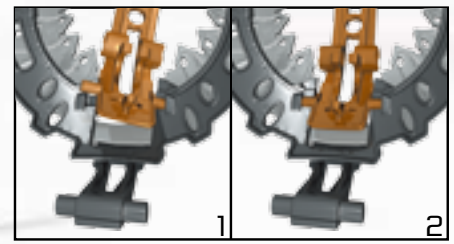
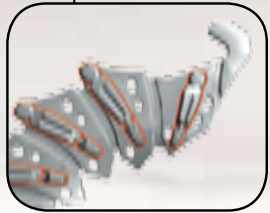
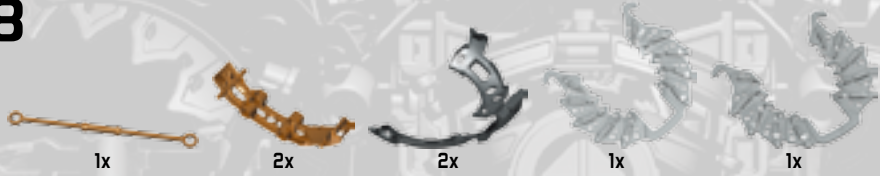

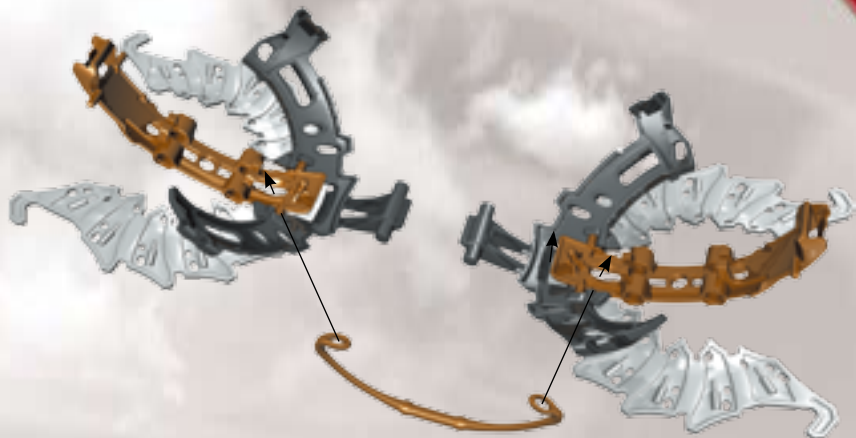

3

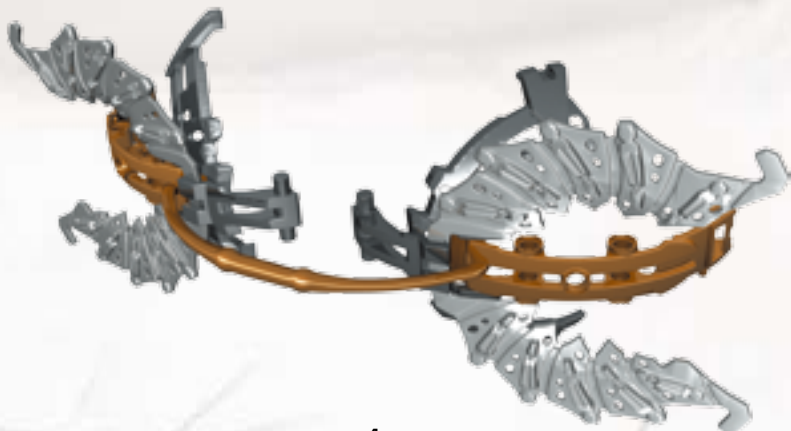

4



13

9



1x



10



14



- ⓘ Adult assistance may be required.
- ⓘ Puede ser necesaria la ayuda de un adulto.
- ⓘ L'assistance d'un adulte peut être requise.
- ⓘ Hilfe eines Erwachsenen kann erforderlich sein.
- ⓘ De hulp van een volwassene kan nodig zijn.
- ⓘ L'assistenza di un adulto può essere necessaria.
- ⓘ Assistència por um adulto poderá ser necessária.





12

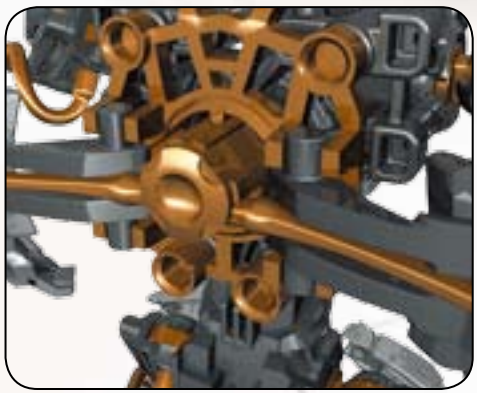
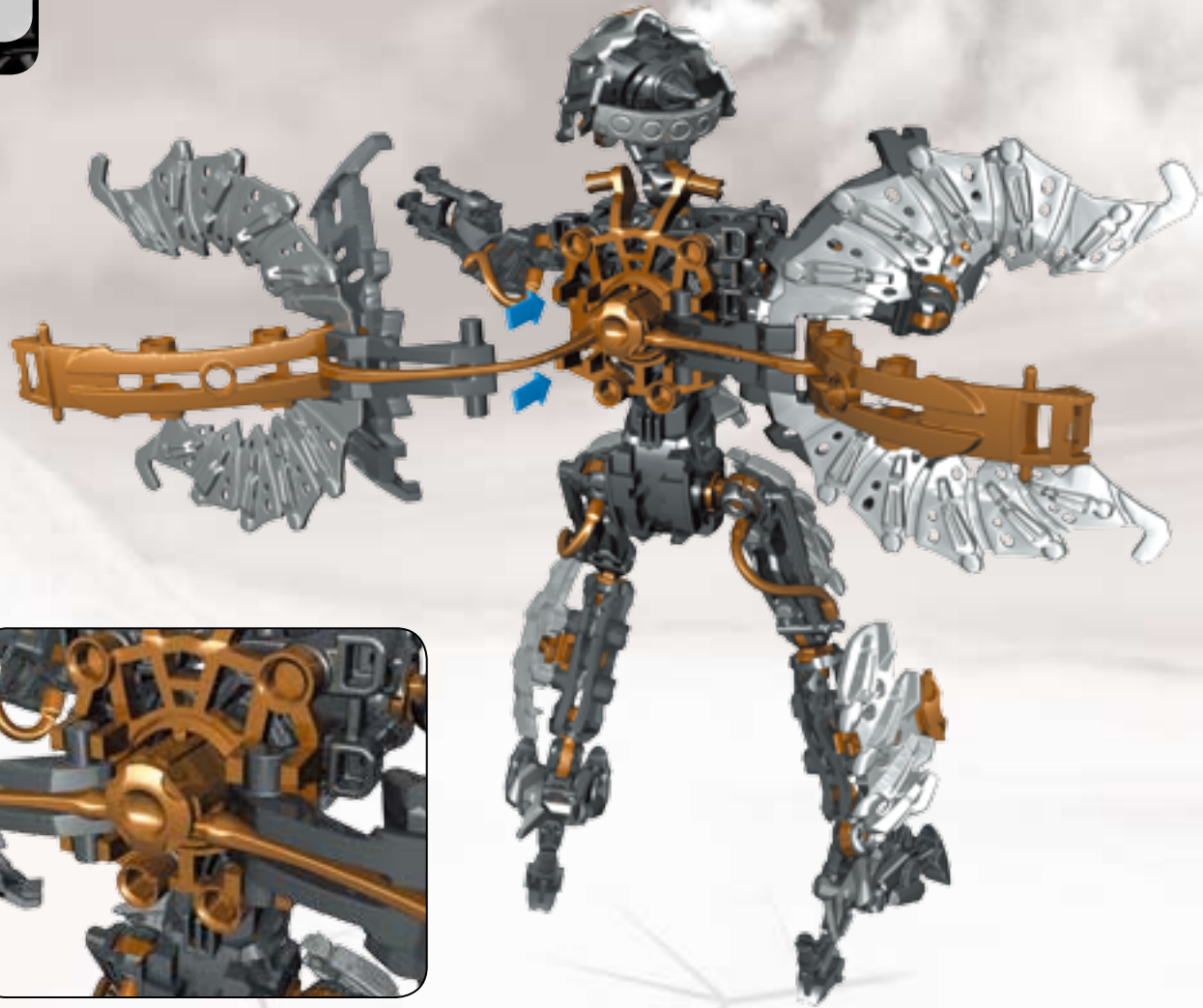

13



1x



1x



1x



1x



17



14



2x



1x



2x

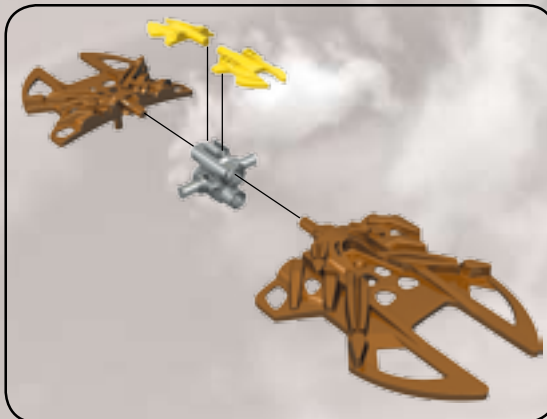

18

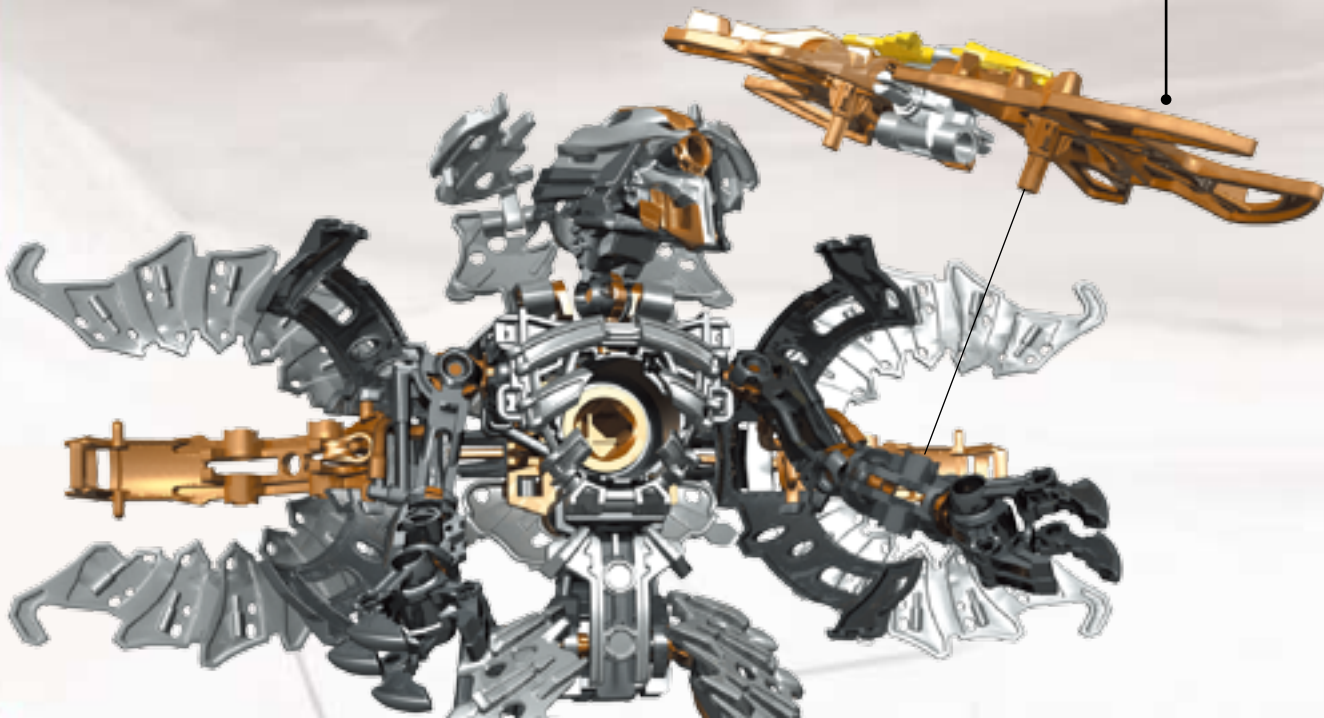

15

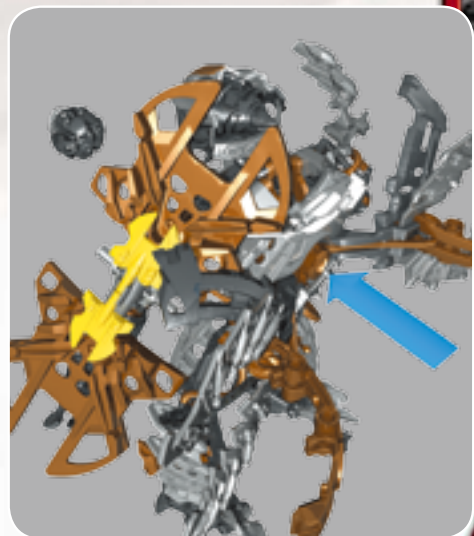

19



1

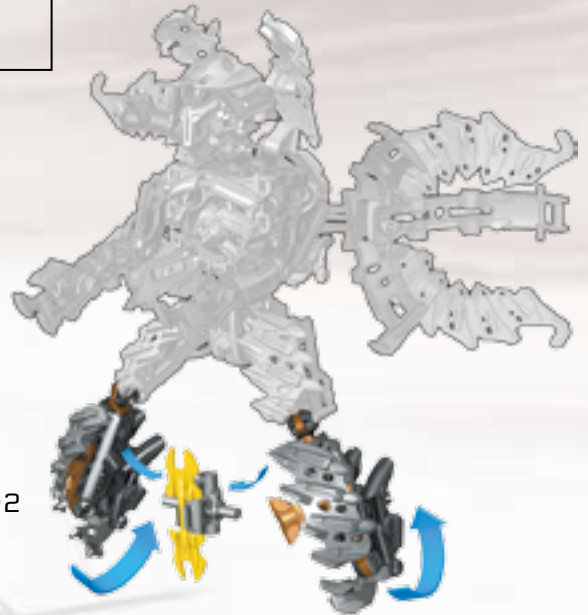

2

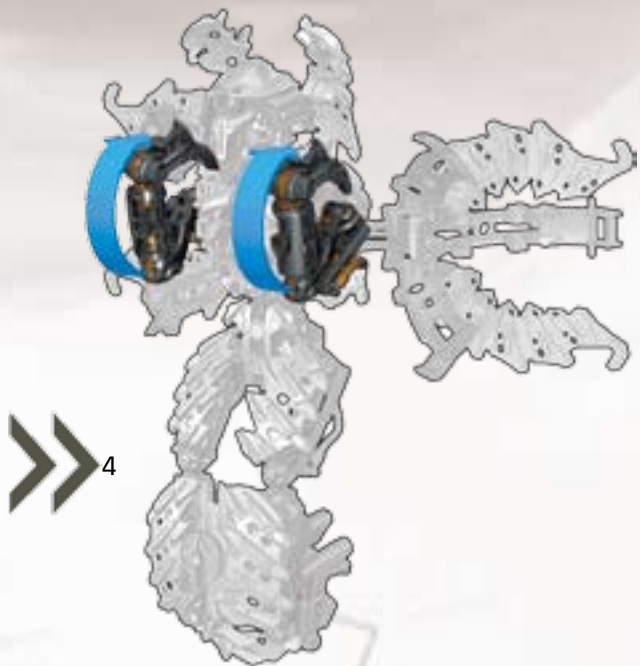
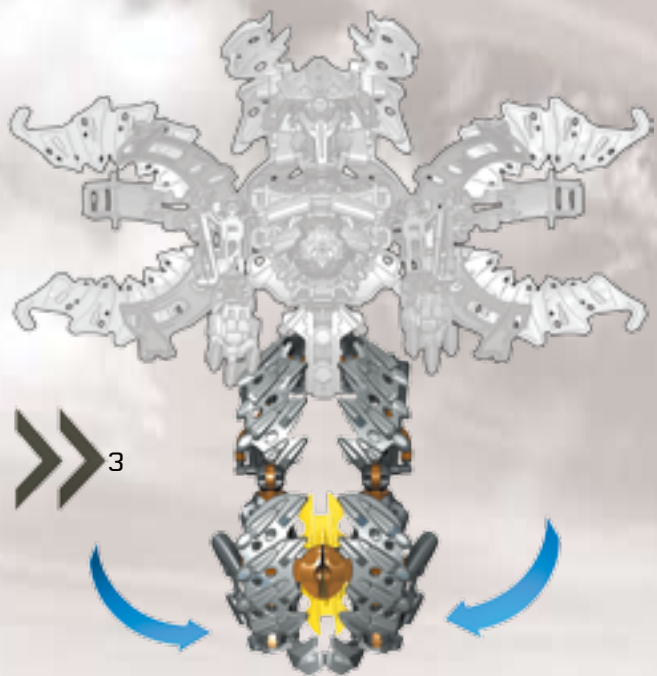





22

5

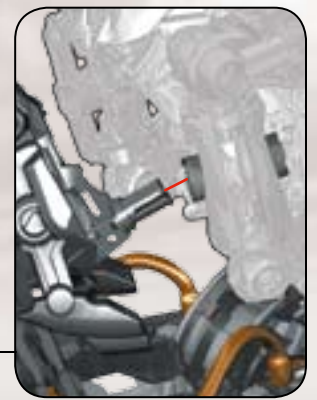
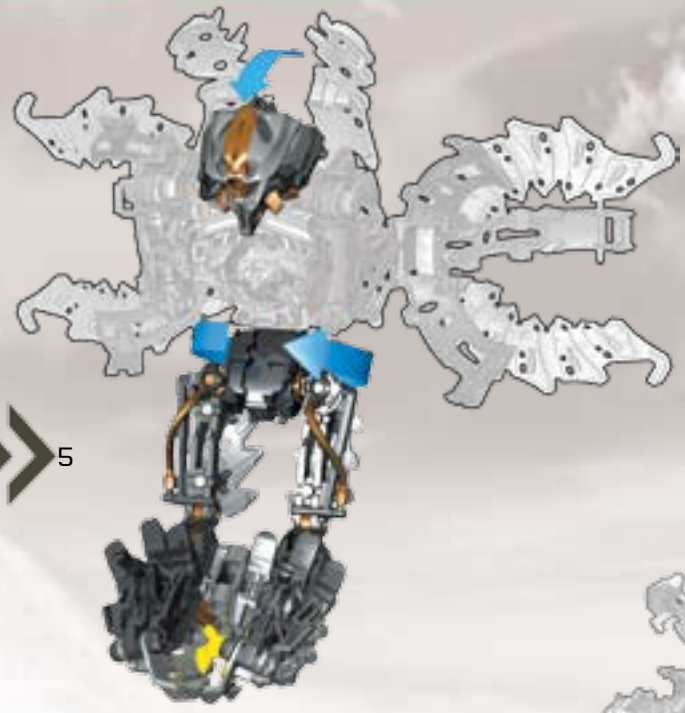

6

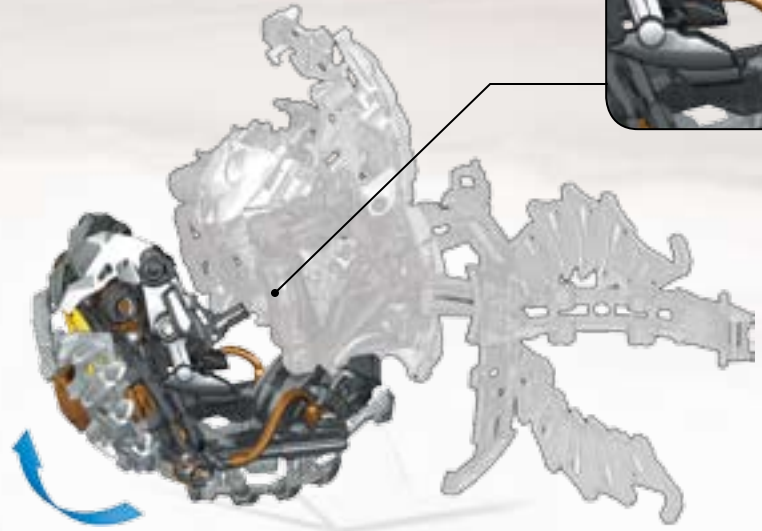

7



8

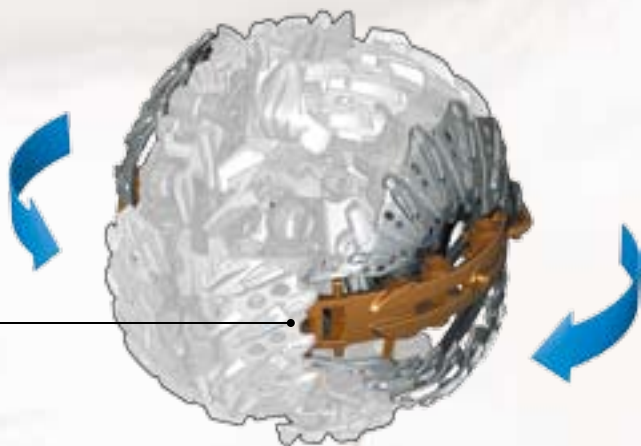
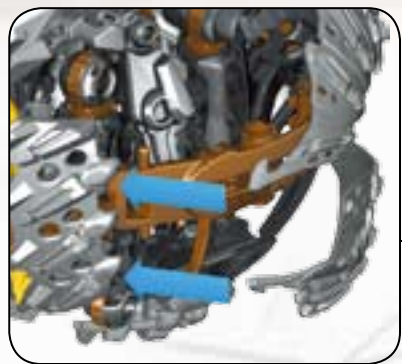

PLAY / JUGAR / JOUER / SPIELEN /  
SPELEN / GIOCARE / JOGAR

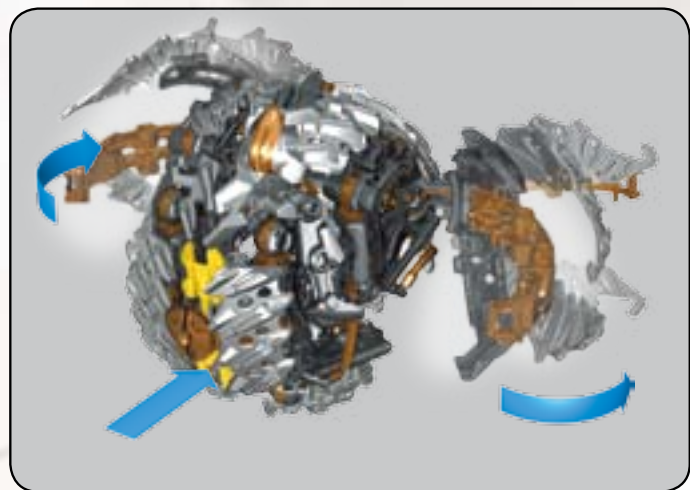

**COLLECT AND COMBINE WEAPONS! / ¡COLECCIONA Y COMBINA LAS DISTINTAS ARMAS! / COLLEZIONE ET COMBINE LES ARMES! / SAMMLE UND KOMBINIERE WAFFEN! / VERZAMEL EN COMBINEER WAPENS! / COLLEZIONA E ASSEMBLA LE ARMI! / COMBINA ARMAS!**

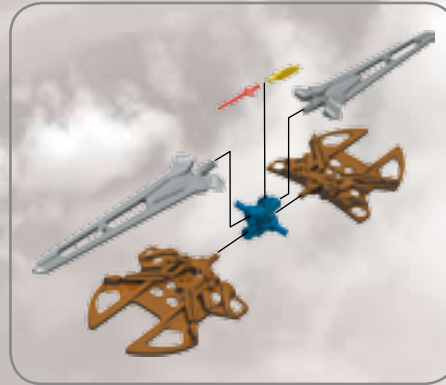

Additional purchases required to collect all elements shown. / Para coleccionar todos los elementos mostrados se precisa realizar unas compras adicionales. / Des achats additionnels sont nécessaires afin d'obtenir tous les articles de la collection illustrés. / Um alle dargestellten Elemente zu sammeln sind zusätzliche Käufe erforderlich. / Verdere aankopen zijn nodig om alle afgebeelde artikelen te verzamelen. / Acquisti supplementari necessari per collezionare tutti gli elementi illustrati. / Compras adicionais são necessárias para coleccionar todos os elementos exibidos.

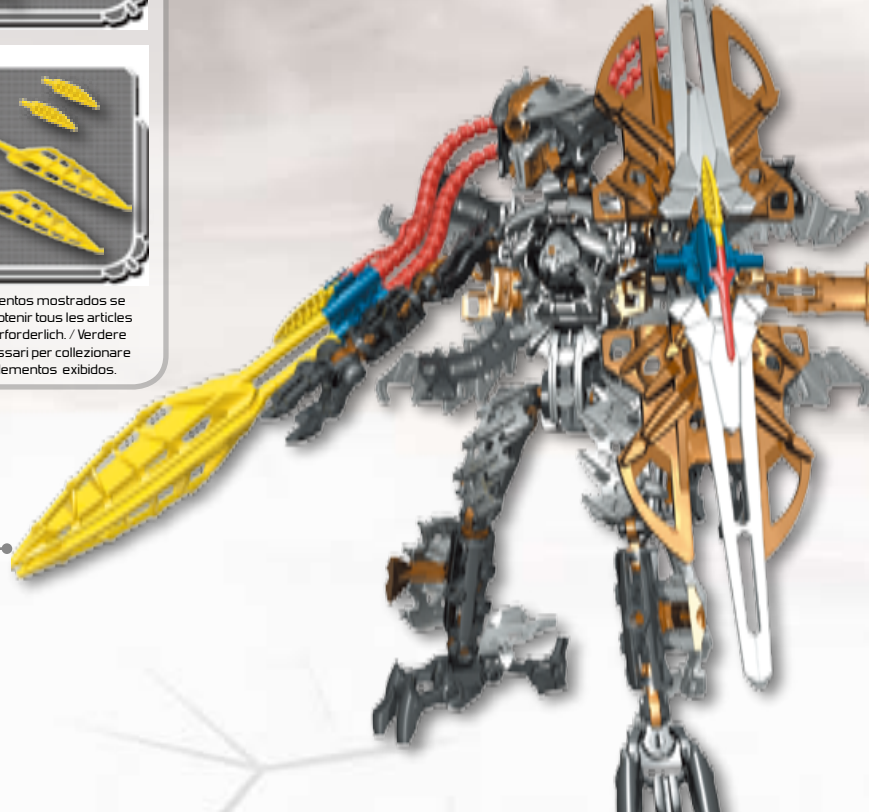
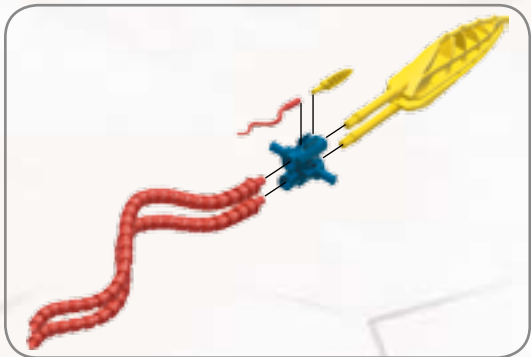



# NEO SHIFTERS



Battle Arena™



Critical Buffer™



Operation Hydraxx™



Perilous Assault™

FOR ONLINE GAMES GO TO:  
PARA JUEGOS EN LÍNEA, VISITA:  
POUR LES JEUX EN LIGNE, RENDEZ-VOUS SUR :  
HIER FINDEST DU ONLINE-SPIELE:  
GA VOOR ONLINE GAMES NAAR:  
PER GIOCARE ONLINE VAI ALL'INDIRIZZO:  
PARA ACEDERES A JOGOS EM REDE:

[WWW.NEOSHIFTERS.COM](http://WWW.NEOSHIFTERS.COM)

«E» Please read these instructions carefully before first use and keep them for future reference. / «E» Leer estas instrucciones cuidadosamente antes de la primera utilización y guardarlas para referencia futura. / «E» Il est recommandé de lire attentivement ce feuillet avant la première utilisation et de le conserver pour référence future. / «E» Die Gebrauchsanleitung bitte durchlesen und aufbewahren. / «E» Wij raden u aan deze handleiding zorgvuldig te lezen en te bewaren voor eventuele raadpleging op een later tijdstip. / «E» Leggere le istruzioni prima di cominciare ad usare il gioco e conservarle per referenze future. / «E» Leia as instruções antes do primeiro uso e guarde-as para futura referência.

**EN** ⚠ **WARNING :**  
**CHOKING HAZARD.** - Small parts.  
Not for children under 3 years.

**ES** ⚠ **ADVERTENCIA :**  
**PELIGRO DE ASFIXIA.** - Contiene piezas pequeñas.  
No recomendado para niños menores de 3 años.

**FR** ⚠ **AVERTISSEMENT :**  
**RISQUE DE SUFFOCATION.** - Présence de petits éléments.  
Ne convient pas aux enfants de moins de 3 ans.

**DE** ⚠ **WARNUNG :**  
**ERSTICKUNGSGEFAHR.** - Enthält kleine Teile.  
Nicht für Kinder unter 3 Jahren geeignet.

**NL** ⚠ **WAARSCHUWING :**  
**VERSTIKKINGSGEVAAR.** - Bevat kleine onderdelen.  
Niet geschikt voor kinderen onder de 3 jaar.

**DA** ⚠ **ADVARSEL :**  
**KVÆLNINGSFARE.** - Inneholder smådele.  
Ikke til børn under 3 år.

**EL** ⚠ **ΠΡΟΕΙΔΟΠΟΙΗΣΗ :**  
**ΚΙΝΔΥΝΟΣ ΠΝΙΞΙΜΑΤΟΣ.** - Περιέχει μικρά αντικείμενα.  
Όχι για παιδιά κάτω των 3 ετών.

**FI** ⚠ **VAROITUS :**  
**TUKENTUMISVAARA.** - Sisältää pieniä osia.  
Ei alle 3-vuotiaalle lapsille.

**IT** ⚠ **ATTENZIONE :**  
**PERICOLO DI SOFFOCAMENTO.** - Contiene piccole parti.  
Non indicato per bambini sotto i 3 anni.

**NO** ⚠ **ADVARSEL :**  
**KVELNINGSFARE.** - Inneholder små deler.  
Kun for barn over 3 år.

**PT** ⚠ **ATENÇÃO :**  
**PERIGO DE ASFIXIA.** - Contém peças pequenas.  
Não é concebido para crianças de menos de 3 anos.

**SV** ⚠ **VARNING :**  
**KVÄVNINGSRISK.** - Innehåller små delar.  
Inte för barn under 3 år.

**JA** ⚠ **警告 :**  
窒息の危険性 - 小さな部品が含まれています  
3歳以下の子供には与えないで下さい。

**ZH** ⚠ **警告 :**  
有窒息危險。 - 包含有小部件  
不适合3岁以下的小孩玩。

**AR** ⚠ **تحذير :**  
خطر اختناق - قطع صغيرة.  
غير صالحة للأطفال أقل من 3 سنوات.

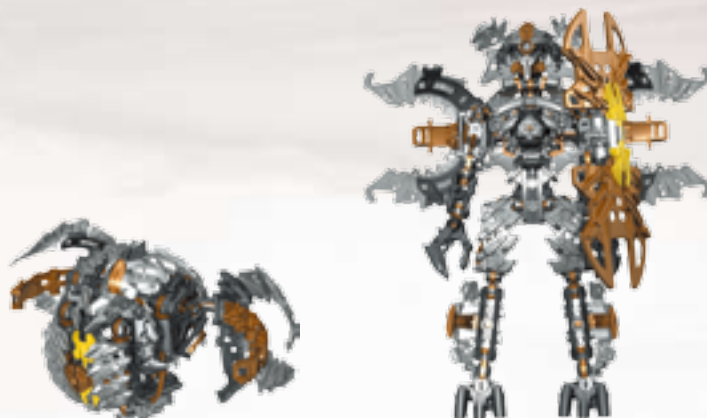

suggested storage position / posición recomendada para el almacenamiento del producto / position de rangement conseillée /  
empfohlene Aufbewahrung / aanbevolen manier van opbergen / posizione consigliata nei periodi di mancato utilizzo /  
posição sugerida para armazenamento







Telluric Shield  
Escudo Telluric  
Bouclier Tellurique  
Tellurischer Schild  
Telluric Shield  
Scudo Tellurico  
Escudo Tellurico



Shirts  
Se transforma  
Se transforme  
Verwandelt sich  
Transformeert  
Si trasforma  
Transforma-se



© 2008, MEGA Brands Inc. ® and ™ denote trademarks of MEGA Brands Inc. This toy conforms to: Voluntary Product Standard F963 U.S., Canadian Hazardous Products Act, CEN Standards E.N. 71. Products and colors may vary. ®  
 ® y ™ designan la marca registrada y la marca comercial de MEGA Brands Inc. Este juguete es de conformidad con: Voluntary Product Standard F963 U.S., Canadian Hazardous Products Act, CEN Standards E.N. 71. Las piezas y los colores pueden variar. ® ® et ™ désignent des marques de commerce de MEGA Brands Inc. Ce jouet est conforme aux: Voluntary Product Standard F963 U.S., Canadian Hazardous Products Act, CEN Standards E.N. 71. Les items et les couleurs peuvent varier. ® ® und ™ sind Markenzeichen der Firma MEGA Brands Inc. Dieses Spielzeug stimmt mit: Voluntary Product Standard F963 U.S., Canadian Hazardous Products Act, CEN Standards E.N. 71 überein. Produkte und Farben können unterschiedlich sein. ® ® en ™ duiden op handelsmerken van MEGA Brands Inc. Dit speelgoed voldoet aan: Voluntary Product Standard F963 U.S., Canadian Hazardous Products Act, CEN Standards E.N. 71. In producten en kleuren kan variatie optreden. ® ® e ™ indicano del marchio depositato di MEGA Brands Inc. Questo giocattolo è conforme a: Voluntary Product Standard F963 U.S., Canadian Hazardous Products Act, CEN Standards E.N. 71. Prodotti e colori possono variare. ® ® e ™ denotam marcas registradas de MEGA Brands Inc. Este brinquedo conforma-se ao Produto Padrão Voluntário F963 EE.UU., Decreto Canadense de Produtos Perigosos, Padrões CEN, E.N. 71. Produtos e cores podem variar.  
 Printed in China AD063741

WWW.NEOSHIFTERS.COM



6367



6377



6375



6376

También disponible / Equivalente disponible  
 Ebenfalls erhältlich / Eveneens beschikbaar  
 Anche disponibile / Também disponível