

MEGA  
BLOKS

# WARRIORS

FUTURE FORCE™

9521

U-122  
Striker™



**WARNING:**  
CHOKING HAZARD - Small Parts.  
Not for children under 3 years

Ages / Años / Âges

Pieces / Piezas / Pièces

7+

95





Color chart.

Charte de couleurs.

Cuadro cromático.

Quadro cromatico.

Färgtabell.

Kleurenkaart.

カラーチャート

色彩表



Active step / Étape active / Etapa activa / Azione attiva  
Aktivt skede / Actieve stap / アクティブなステップ / 積極步驟

Previous step / Étape précédente / Etapa precedente  
Azione precedente / Föregående skedet / Vorige stap  
前のステップ / 上一步驟



Adult assistance is required. / L'aide d'un adulte est requise. / Necesita ayuda de un adulto. / È necessario l'aiuto di un adulto. /  
Hjälp av en vuxen är nödvändigt. / Hulp van een volwassene is gewenst. / 大人の方が手伝ってあげる必要があります。 / 需要成年人協助

**WARNING:**

Choking hazard - Small parts.  
Not for children under 3 years.

**AVERTISSEMENT:**

Risque de suffocation. Ne convient pas à un enfant  
de moins de 3 ans - contient de petits éléments.

**ADVERTENCIA:**

Peligro de asfixia. No recomendado para niños  
menores de 3 años - contiene piezas pequeñas.

**AVVERTENZA:**

Rischio di soffocamento. Non adatta ad un bambino  
di età minore ai 36 mesi. Contiene parti piccole - non  
ingerire.

**WARNING:**

Risk for kvävning. Ikke egnet til barn under  
3 år - inneholder smådeler.

**WAARSCHUWING:**

Stikgevaar. Niet geschikt voor kinderen onder  
3 jaar - i.v.m. kleine onderdelen.

**注意:**

飲み込むと危険です。  
小さいパーツがあるので、  
3才以下の幼児には  
与えないでください。

不适于三岁以下儿童。



1



2



3



4

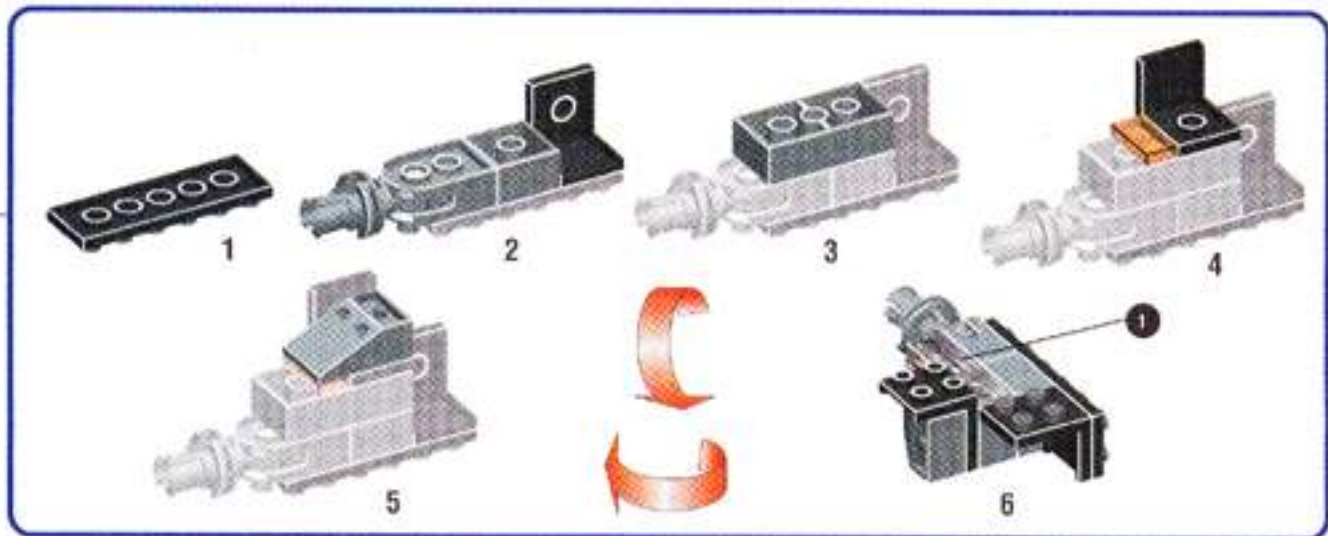





Active step / Étape active / Etapa activa / Azione attiva  
Aktivt skede / Actieve stap / アクティブなステップ / 積極步驟

Previous step / Étape précédente / Etapa precedente  
Azione precedente / Föregående skedet / Vorige stap  
前のステップ / 上一步驟

5

6



7

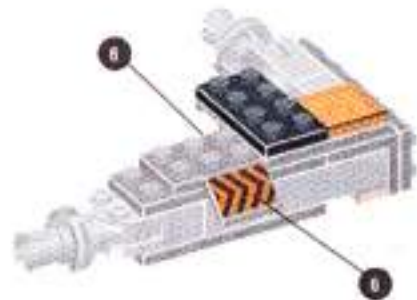

8



9

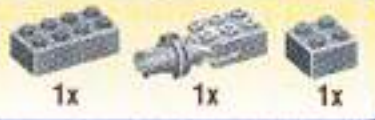

10

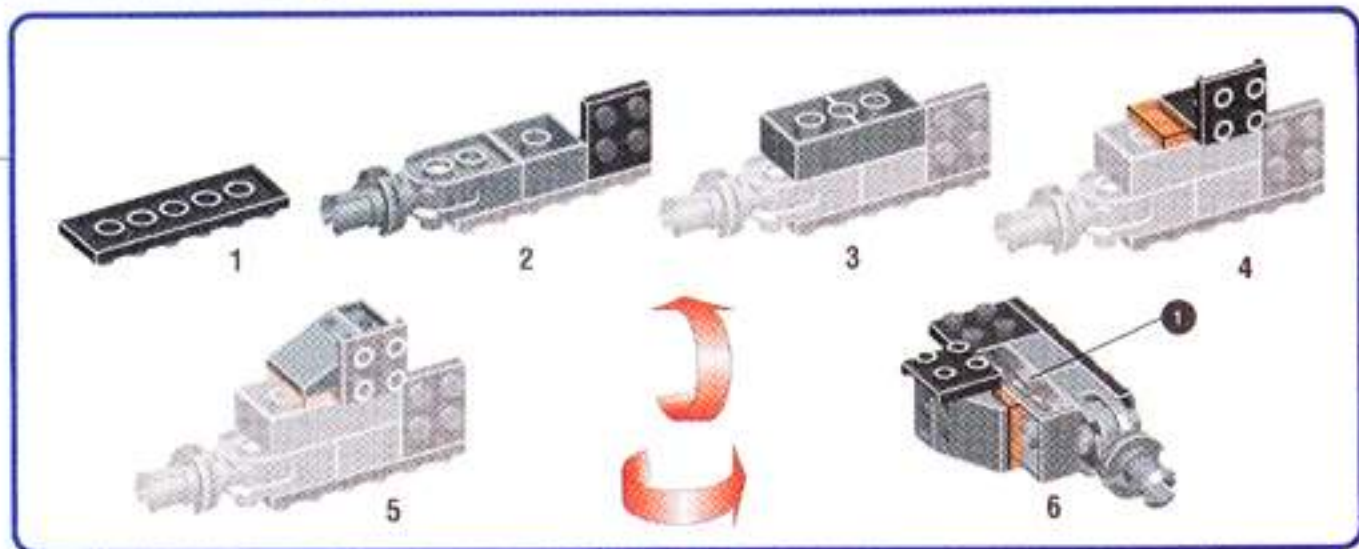

11



12



13

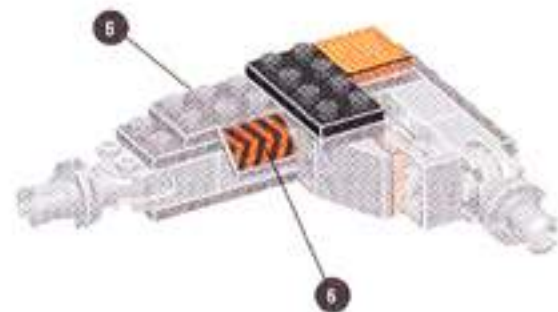





Active step / Étape active / Etapa activa / Azione attiva  
Aktivt skede / Actieve stap / アクティブなステップ / 積極步驟

Previous step / Étape précédente / Etapa precedente  
Azione precedente / Føregående skedet / Vorige stap  
前のステップ / 上一步驟

14



15



16



17



18



19



4 1x



20



2 2x 5 2x

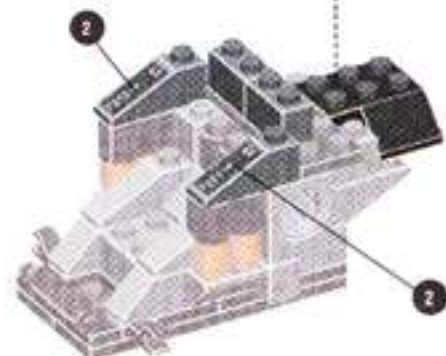
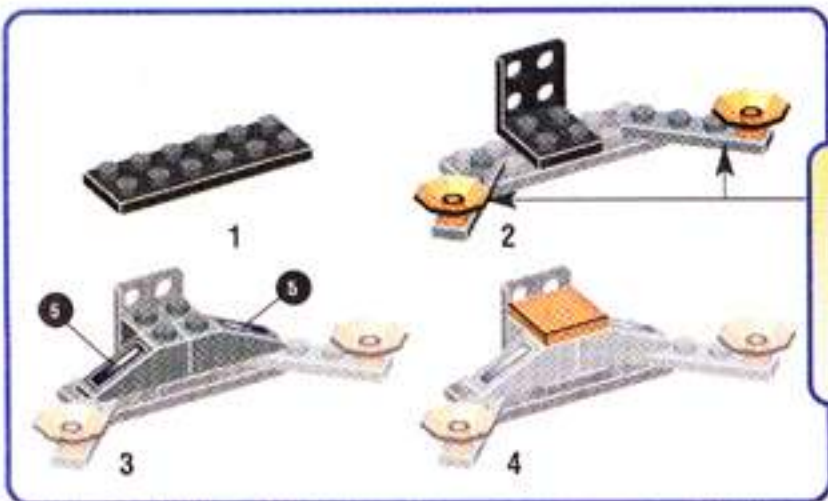





Active step / Étape active / Etapa activa / Azione attiva  
Aktivt skede / Actieve stap / アクティブなステップ / 積極步驟

Previous step / Étape précédente / Etapa precedente  
Azione precedente / Föregående skedet / Vorige stap  
前のステップ / 上一步驟

21



1x

4x

1x

22



1x

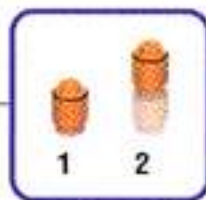

1

2

2x

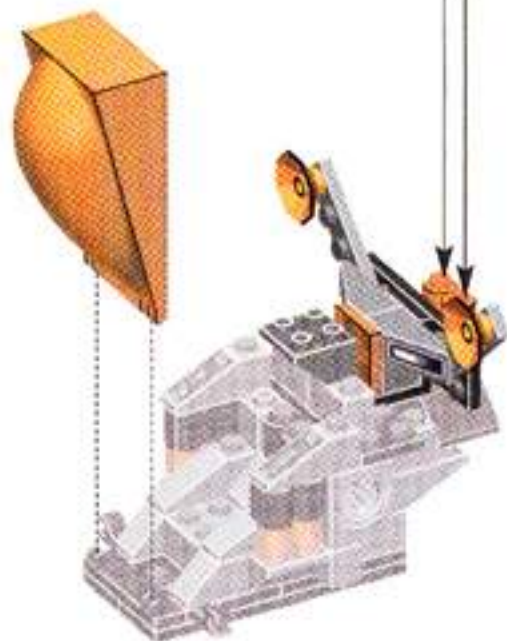



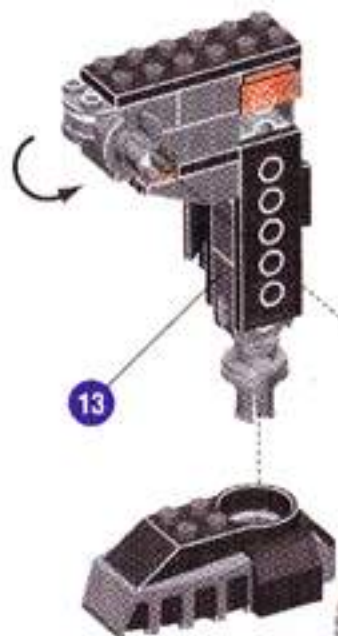

13

23



2x



7

24



1x



1x



1x



2x

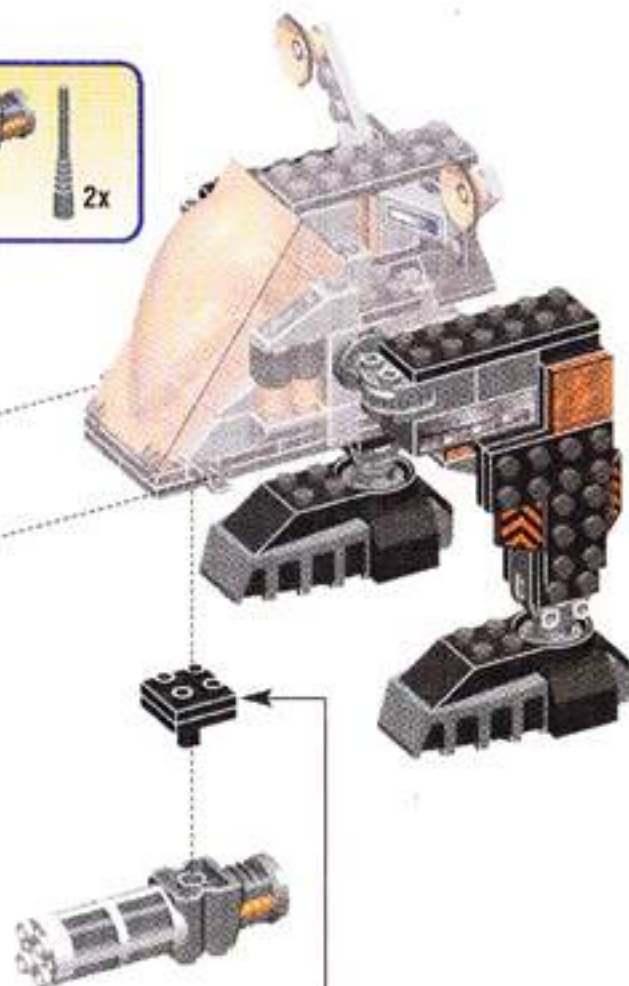

1



2



3



Active step / Étape active / Etapa activa / Azione attiva  
Aktivt skede / Actieve stap / アクティブなステップ / 積極步驟

Previous step / Étape précédente / Etapa precedente  
Azione precedente / Föregående skedet / Vorige stap  
前のステップ / 上一步驟

25

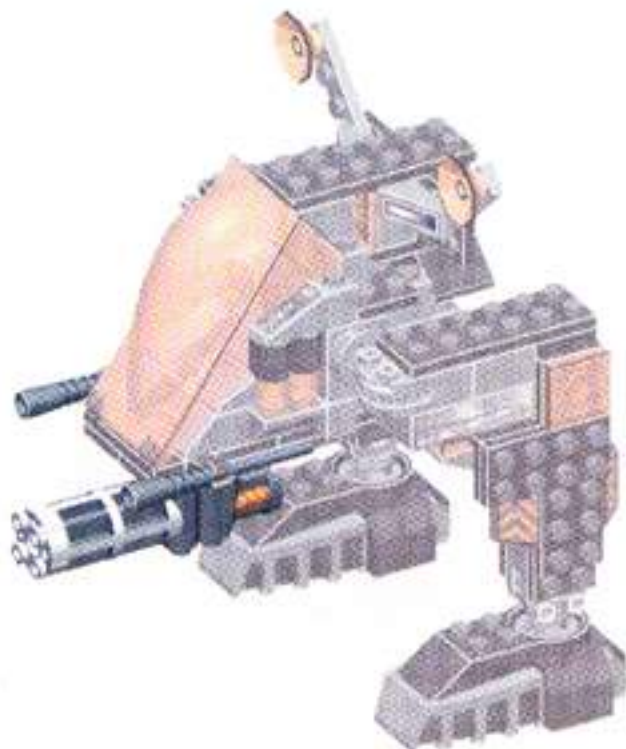





**A**

*Paint drying time: 3 hours.  
Tiempo de secado: 3 horas.  
Temps de séchage: 3 heures.*

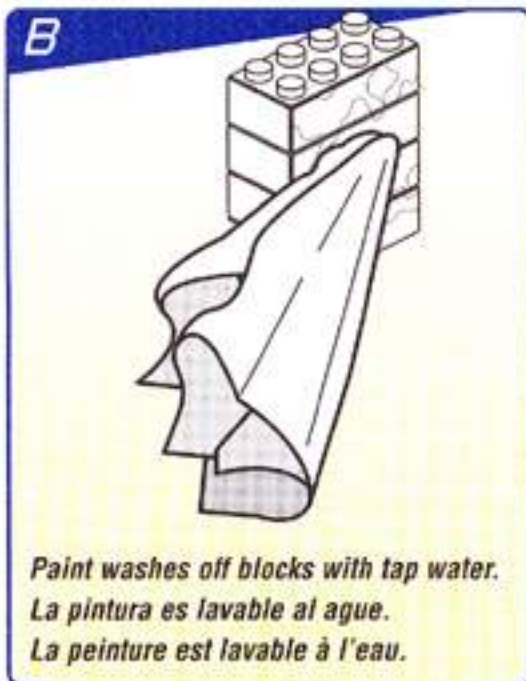

**B**

*Paint washes off blocks with tap water.  
La pintura es lavable al agua.  
La peinture est lavable à l'eau.*



**C**

*Dry paint can also be peeled off blocks or scraped off with the included block remover.*

*La pintura se puede quitar rascandola con el «saca-bloques».*

*La peinture peut être pelée ou grattée à l'aide du «retire-bloc».*



**D**

*Use the block remover for disassembling.  
Utilizar el saca-bloques para facilitar el desmontaje.  
Utiliser le «retire-bloc» pour faciliter le désassemblage.*

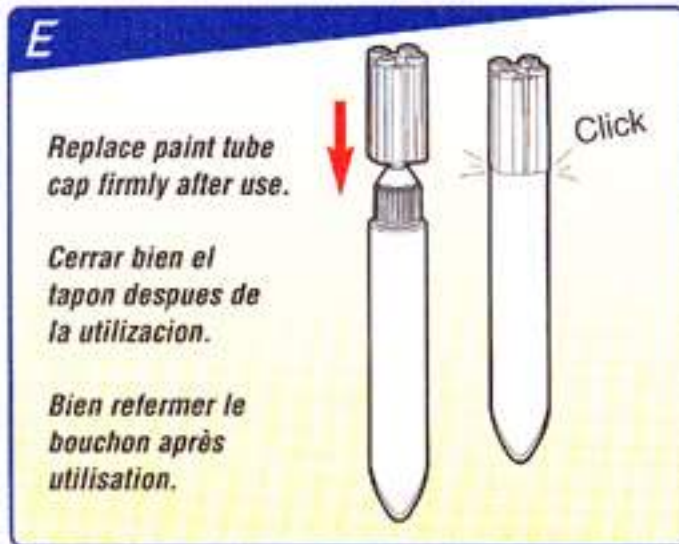

**E**

*Replace paint tube cap firmly after use.*

*Cerrar bien el tapon despues de la utilizacion.*

*Bien refermer le bouchon après utilisation.*



**F**

**CAUTION ATENCION ATTENTION**

*Paint may stain fabric and clothing.  
La pintura puede manchar los tejidos y la ropa.  
La peinture peut tacher les tissus et les vêtements.*



MEGA  
BLOKS

# WARRIORS

FUTURE FORCE™

9521

U-240

Assault  
+ 3 recon drones

9528

U-122

Striker™

9521

J-227

Quadwalker  
+ 3 recon drones

9527

D-105

Sandstorm™

9519

Ritvik

© 2001, RITVIK HOLDINGS INC.  
PRINTED IN CANADA D095211

Collect them all

Colecciónalos todos

Collectionne-les tous