

**MEGA  
BLOKS**

# WARRIORS

## FUTURE FORCE™

9527



**J-227**  
Quadwalker™  
+ 3 recon drones

**⚠ WARNING:**  
CHOKING HAZARD - Small Parts.  
Not for children under 3 years

Ages / Años / Âges

Pieces / Piezas / Pièces

**7+**

**375**

*Missiles really fire!*

*¡Los misiles se disparan de verdad!*

*Tirez réellement les missiles!*

Color chart.

Charte de couleurs.

Cuadro cromático.

Quadro cromatico.

Färgtabell.

Kleurenkaart.

カラーチャート

色彩表

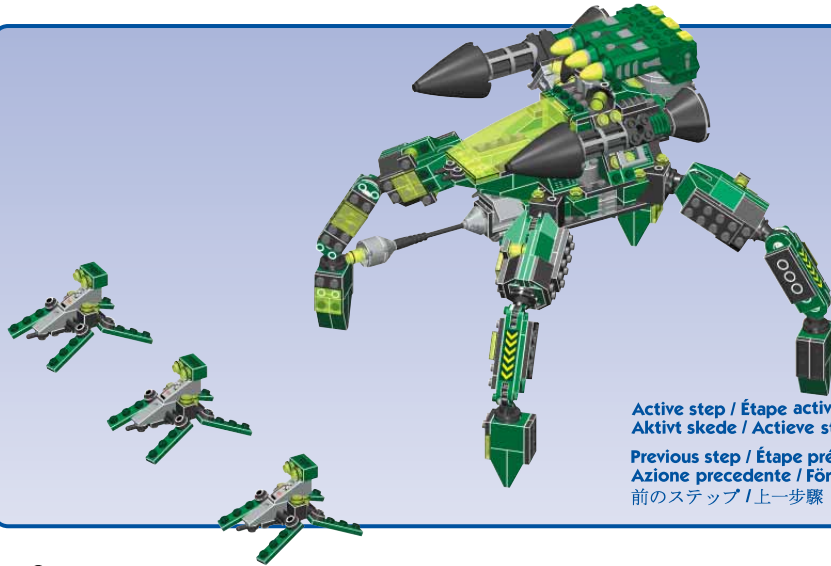

Active step / Étape active / Etapa activa / Azione attiva  
Aktivt skede / Actieve stap / アクティブなステップ / 積極步驟  
Previous step / Étape précédente / Etapa precedente  
Azione precedente / Föregående skedet / Vorige stap  
前のステップ / 上一步驟

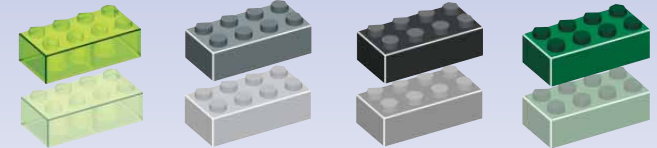

Adult assistance is required. / L'aide d'un adulte est requise. / Necesita ayuda de un adulto. / È necessario l'aiuto di un adulto. /  
Hjälp av en vuxen är nödvändigt. / Hulp van een volwassene is gewenst. / 大人の方が手伝ってあげる必要があります。 / 需要成年人協助

**WARNING:**  
Choking hazard— Small parts.  
Not for children under 3 years.

**AVERTISSEMENT:**  
Risque de suffocation. Ne convient pas à un enfant  
de moins de 3 ans - contient de petits éléments.

**ADVERTENCIA:**  
Peligro de asfixia. No recomendado para niños  
menores de 3 años-contiene piezas pequeñas.

**AVVERTENZA:**  
Rischio di soffocamento. Non adatta ad un bambino  
di età minore ai 36 mesi. Contiene parti piccole - non  
ingerire.

**WARNING:**  
Risk for kvävning. Ikke egnet til barn under  
3 år - inneholder smådeler.

**WAARSCHUWING:**  
Stikgevaar. Niet geschikt voor kinderen onder  
3 jaar - i.v.m. kleine onderdelen.

**注意:**  
飲み込むと危険です。  
小さいパーツがあるので、  
3才以下の幼児には  
与えないでください。



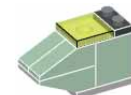
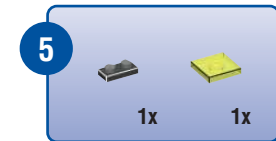
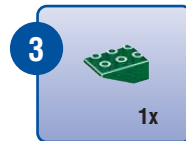
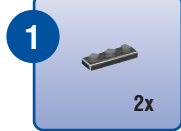

⚠️ 不适宜三岁以下儿童。



**6**  1x





**7**  1x  1x

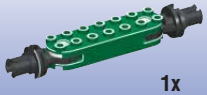

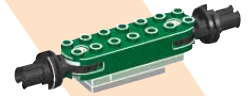
**8**  1x



**9**  1x  1x



**10**  1x

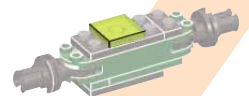

**11**  1x



**12**  1x  1x

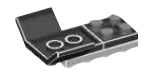



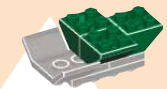

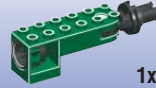
**13**  3x







**14**  1x





**15**  2x  2x

**16**  1x  2x

**17**  1x  2x

**18**  2x  1x

 1  
 2

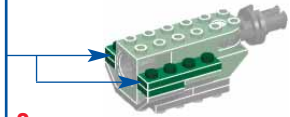

2x

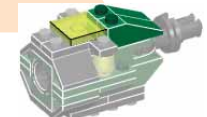



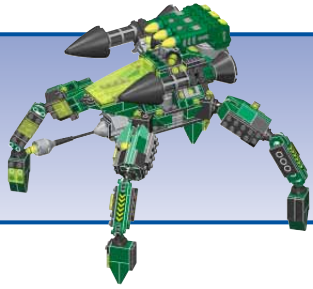

Active step / Étape active / Etapa activa / Azione attiva  
 Aktivt skede / Actieve stap / アクティブなステップ / 積極步驟

Previous step / Étape précédente / Etapa precedente  
 Azione precedente / Föregående skedet / Vorige stap  
 前のステップ / 上一步驟

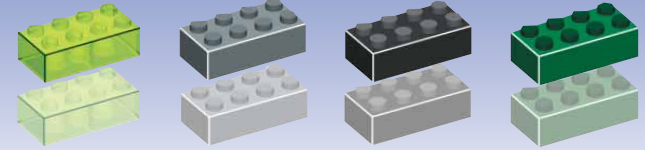

19

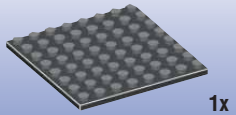

1x

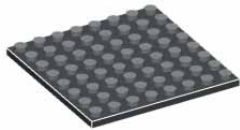

20



6x

2x

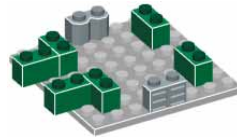

21



2x

4x

1x

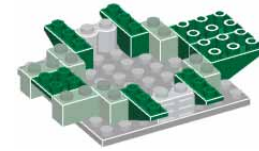

22

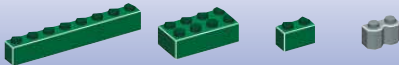

2x

1x

2x

2x

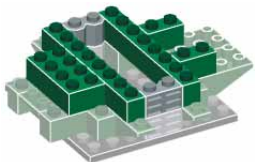

23



2x

4x

2x



24



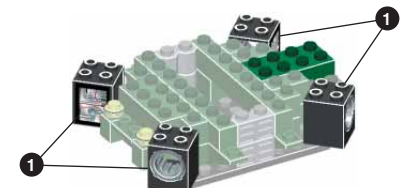

4x

1x

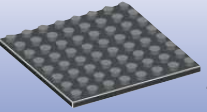





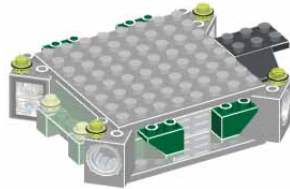

**25**  1x







**26**  4x  1x  4x

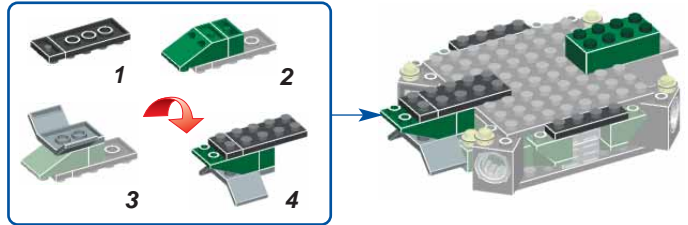



**27**  1x  2x  1x  1x  1x  1x  1x



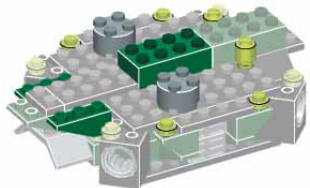

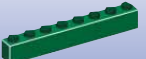

**28**  2x  4x  1x  2x  2x



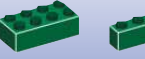



**29**  2x  5x  1x

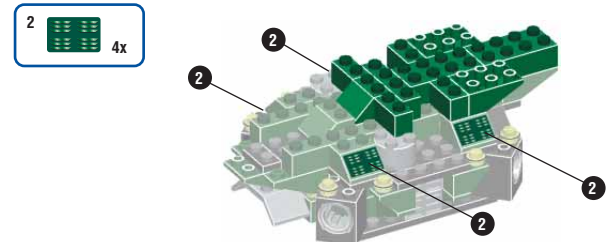





**30**  2x  1x  2x  4x  1x

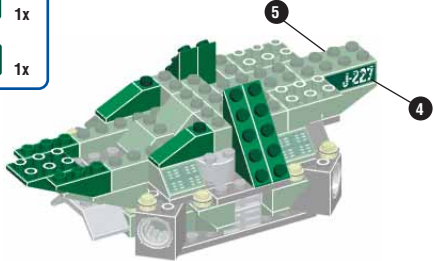







**31**  1x  2x  2x  4x

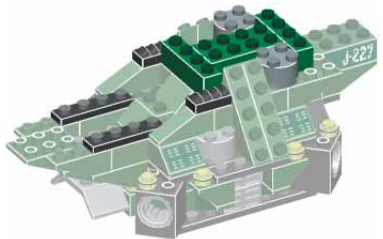

4  1x  
5  1x

**32**  2x  1x  2x  2x  2x



**33**  2x  2x  2x  2x  1x

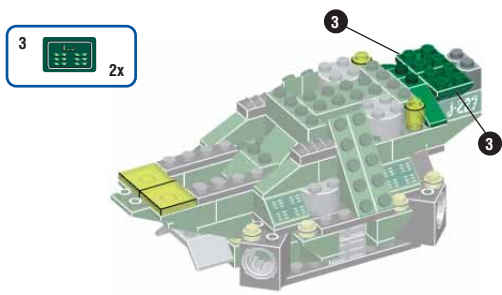

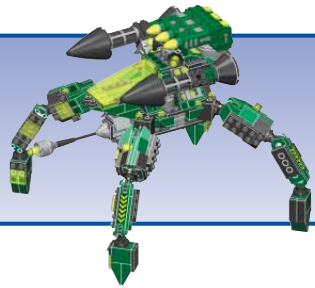

Active step / Étape active / Etapa activa / Azione attiva  
 Aktivt skede / Actieve stap / アクティブなステップ / 積極步驟

Previous step / Étape précédente / Etapa precedente  
 Azione precedente / Föregående skedet / Vorige stap  
 前のステップ / 上一步驟

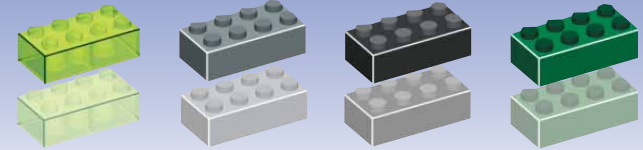

34

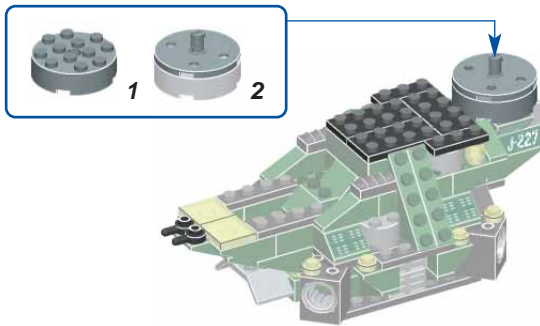

36

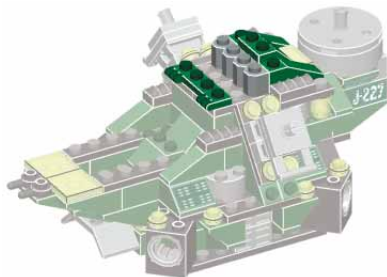

35

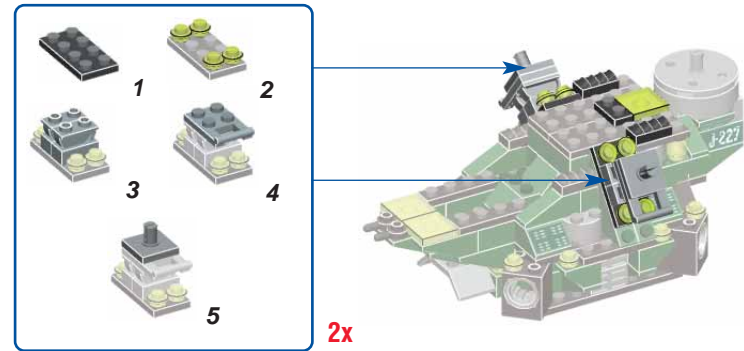
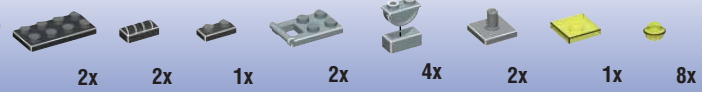

37

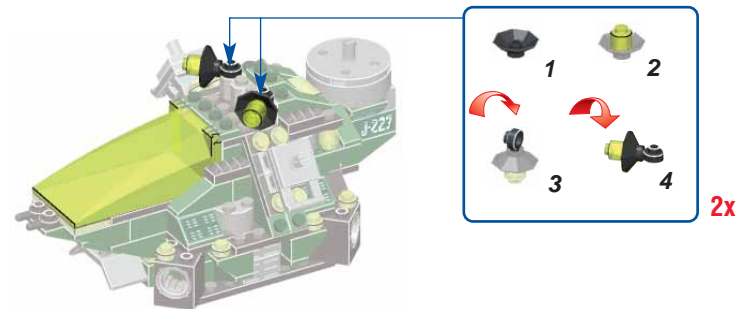
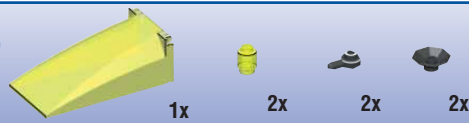

38

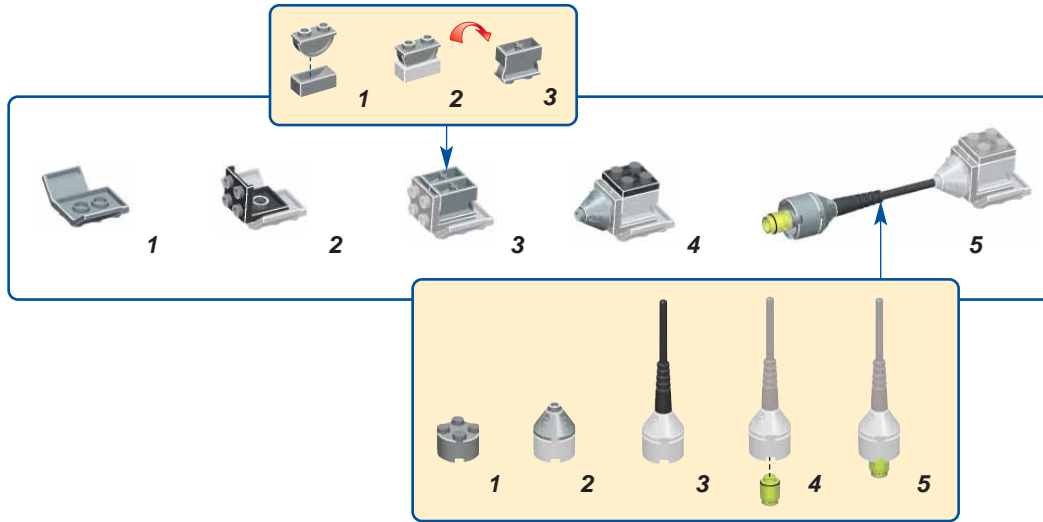

39

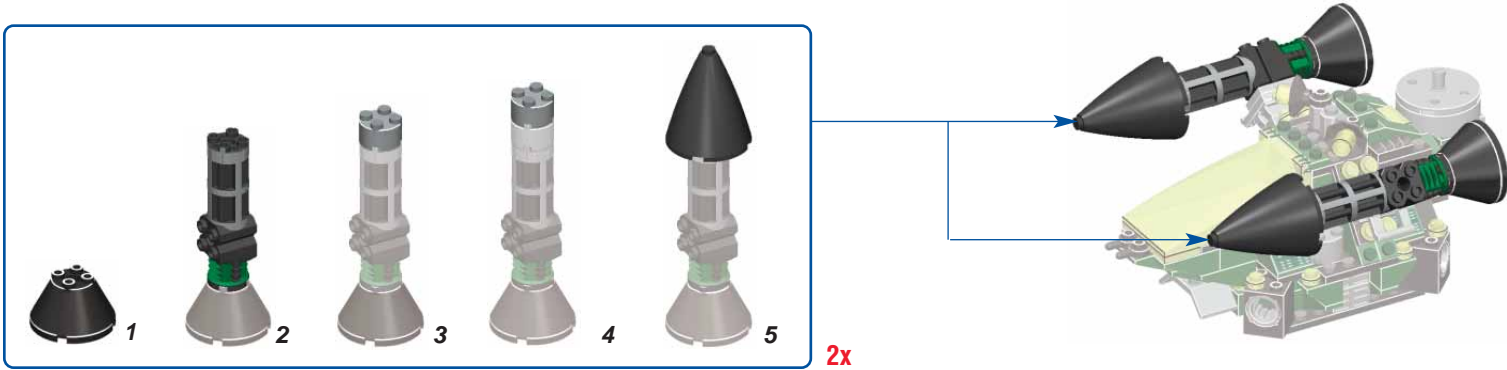

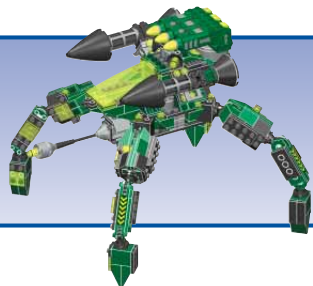

Active step / Étape active / Etapa activa / Azione attiva  
Aktivt skede / Actieve stap / アクティブなステップ / 積極步驟

Previous step / Étape précédente / Etapa precedente  
Azione precedente / Föregående skedet / Vorige stap  
前のステップ / 上一步驟

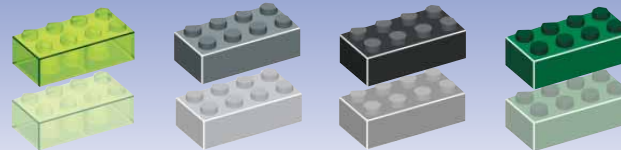

40



3x

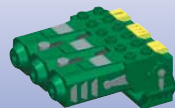

1x

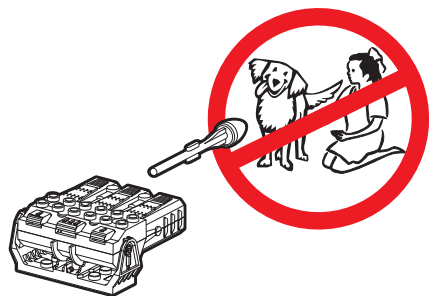
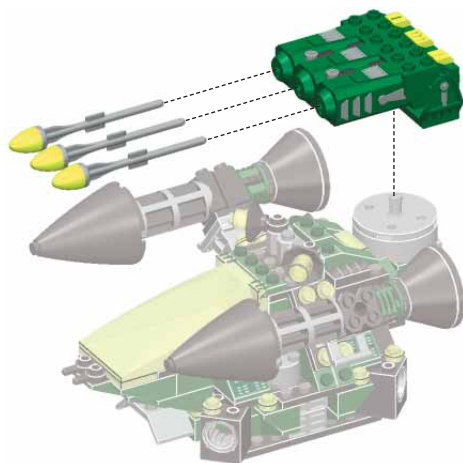

41

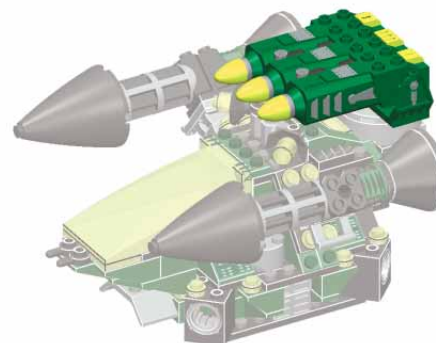



42

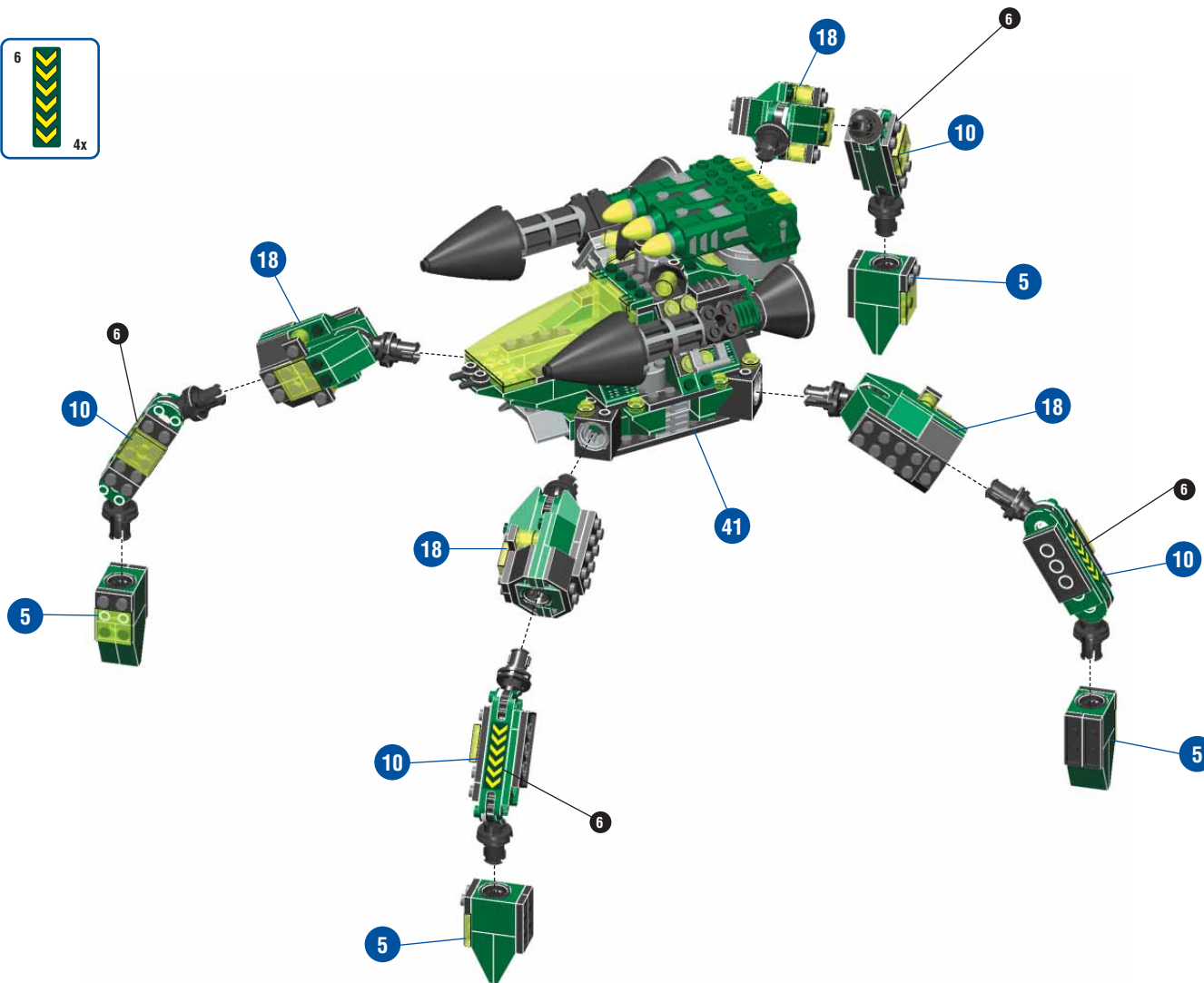

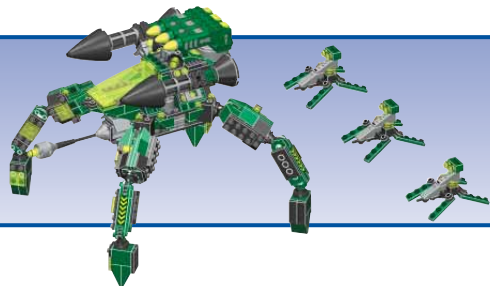

Active step / Étape active / Etapa activa / Azione attiva  
Aktivt skede / Actieve stap / アクティブなステップ / 積極步驟

Previous step / Étape précédente / Etapa precedente  
Azione precedente / Föregående skedet / Vorige stap  
前のステップ / 上一步驟

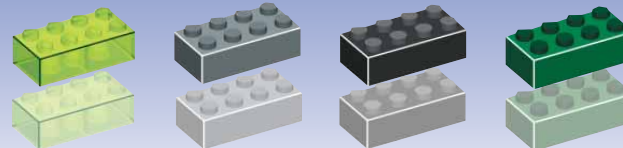

43

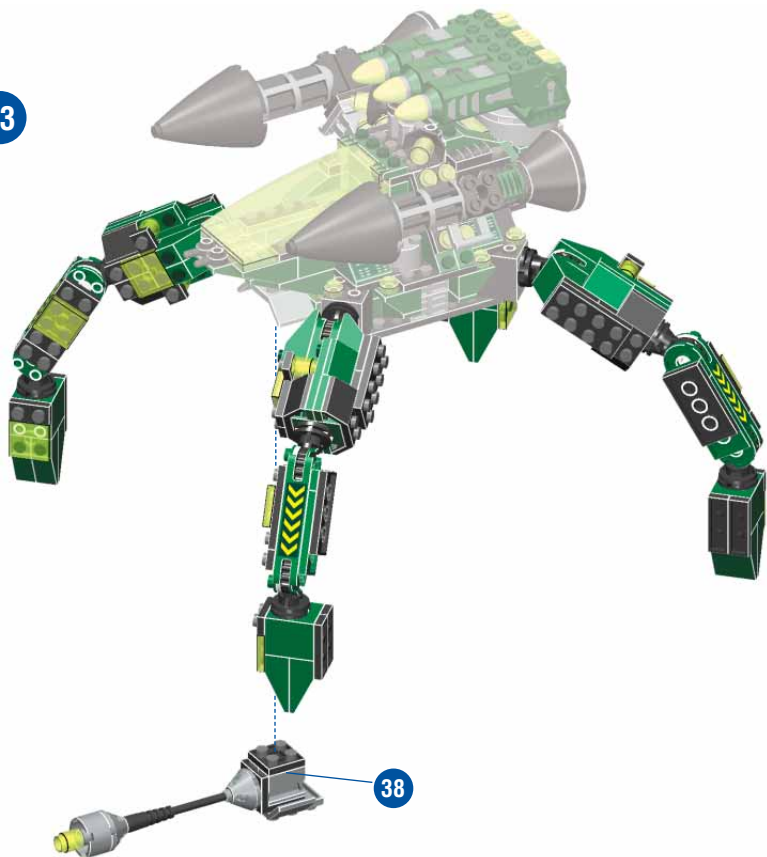

44

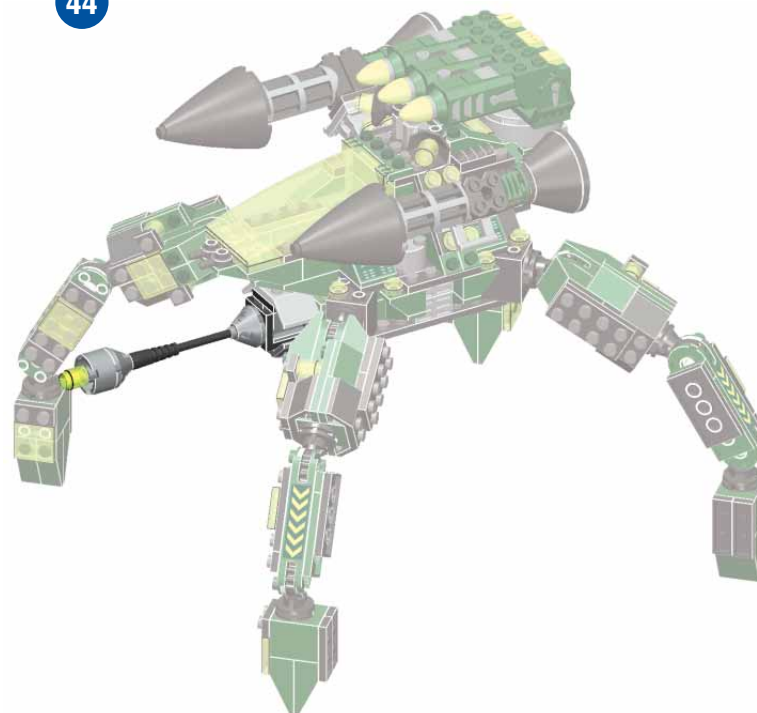

45

- 12x 
- 3x 
- 15x 
- 15x 
- 3x 
- 3x 
- 6x 
- 3x 

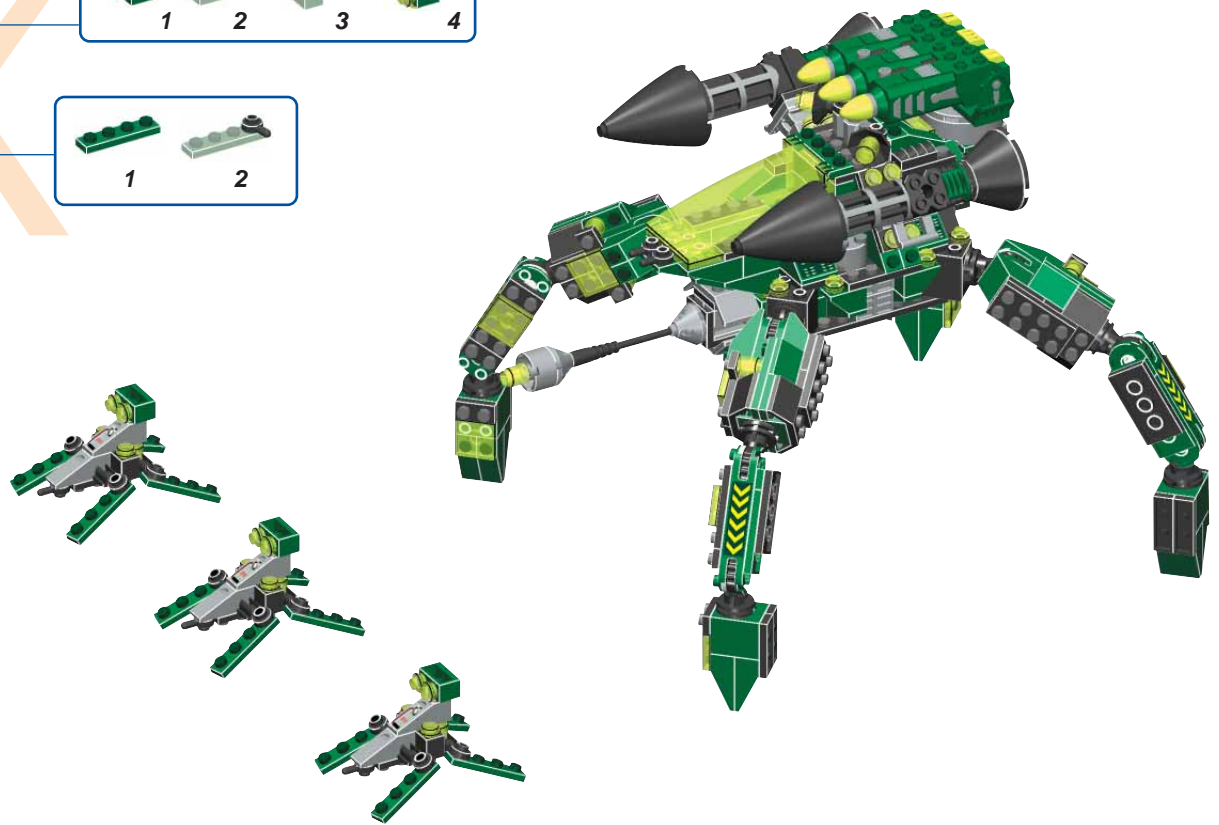
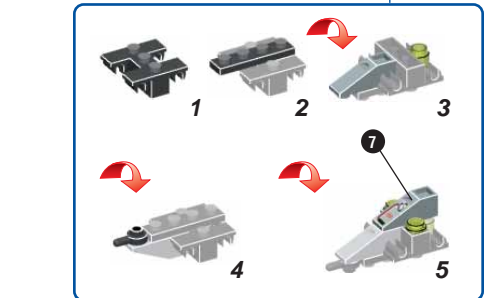
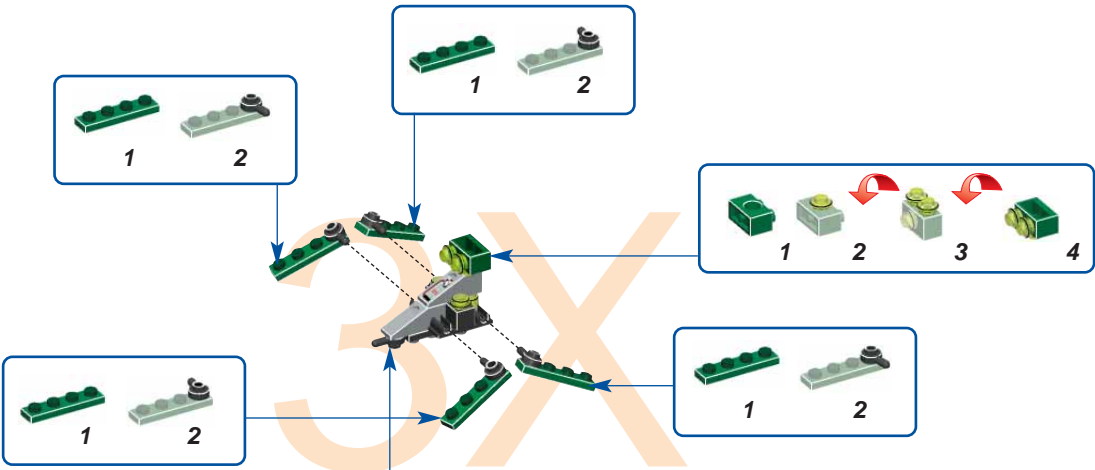
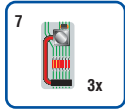

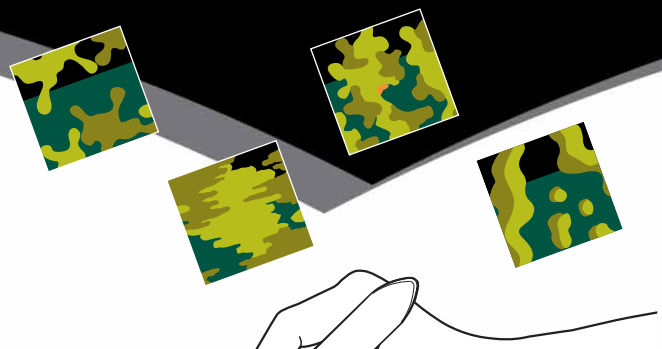

**A**

Paint drying time: 3 hours.  
 Tiempo de secado: 3 horas.  
 Temps de séchage: 3 heures.

**B**

Paint washes off blocks with tap water.  
 La pintura es lavable al agua.  
 La peinture est lavable à l'eau.

**C**

Dry paint can also be peeled off blocks or scraped off with the included block remover.  
 La pintura se puede quitar rascandola con el «saca-bloques».  
 La peinture peut être pelée ou grattée à l'aide du «retire-bloc».

**D**

Replace paint tube cap firmly after use.  
 Cerrar bien el tapon despues de la utilizacion.  
 Bien refermer le bouchon après utilisation.

**E**

Use the block remover for disassembling.  
 Utilizar el saca-bloques para facilitar el desmontaje.  
 Utiliser le «retire-bloc» pour faciliter le désassemblage.

**F**

**CAUTION ATENCION ATTENTION**  
 Paint may stain fabric and clothing.  
 La pintura puede manchar los tejidos y la ropa.  
 La peinture peut tacher les tissus et les vêtements.

**G**

To avoid injury, never launch projectiles in the direction of people or animals.  
 No tirar o apuntar nunca en direccion o cerca de personas o animales.  
 Ne jamais viser ou tirer les projectiles en direction ou près de gens ou d'animaux.

**H**

Use only MEGA BLOKS® projectiles.  
 Utilizar solamente con los proyectiles MEGA BLOKS®.  
 Utiliser seulement avec les projectiles MEGA BLOKS®.