

MEGA
BLOKS

HALO



97003

Snowbound: UNSC Rockethog • Snowbound: CENU Lanzador de cohetes •
Snowbound : Rockethog du CSNU • Snowbound: RVN Rockethog • Snowbound: RVN-racketwagen •
Snowbound: CSNU Rockethog • Snowbound: CENU Lançador de foguetes

Snowbound: UNSC Rockethog

Choose your side and fight for control of Snowbound with the Versus: Snowbound: Rockethog by Mega Bloks! Out on a routine patrol around High Base on their Arctic Rockethog, Blue Team's UNSC Spartans spot a Red Team Covenant Elite Combat racing towards them on a Covenant Ghost! Blue Team hits the accelerator and targets the Elite with their rocket turret just as Red Team opens fire with his Ghost's plasma cannons!

Snowbound: CENU Lanzador de cohetes

Elige tu bando y lucha por el control de Snowbound con el Versus: Snowbound: iRockethog de Mega Bloks! ¡Fuera en un patrullaje rutinario alrededor de la base de altura en su Arctic Rockethog, el Equipo Azul de los Spartans localiza al Equipo Rojo Elite acelerando hacia ellos en un Covenant Ghost! ¡El Equipo Azul pisa el acelerador y apunta a Elite con su torreta cohete justo cuando el Equipo Rojo abre fuego con sus cañones de plasma medianos Ghosts!

Snowbound : Rockethog du CSNU

Choisissez votre allégeance et combattez afin de contrôler Snowbound avec l'ensemble Versus : Rockethog Snowbound de Mega Bloks! Lors d'une patrouille de routine autour de la base surélevée à bord de leur Rockethog arctique, les Spartans de l'équipe bleu détectent un Élite de l'équipe rouge filant tout droit vers eux à bord d'un Ghost du Covenant! L'équipe bleu enfonce l'accélérateur et place l'Élite dans la mire de sa tourelle lance-roquettes alors que l'équipe rouge fait feu à l'aide des canons au plasma moyens de son Ghost!

Snowbound: RVN Rockethog

Entscheide dich für eine Seite und kämpfe um die Kontrolle über Snowbound mit deinem Gegner: Snowbound: Rockethog von Mega Bloks! Auf einem Routine-Rundgang rund um das arktische Rockethog entdecken die Spartans vom Blauen Team eine Einheit des Roten Teams, die auf sie zu rasen in einem Covenant Ghost. Das Blaue Team tritt auf das Gaspedal und zielt mit ihrem Rakettenturm genau in dem Moment auf die Einheit des Roten Teams, als das Rote Team mit den mittleren Plasma-Kanonen des Ghost das Feuer eröffnet!

Snowbound: RVN-racketwagen

Bepaal aan welke kant je staat en vecht voor de controle over Snowbound met je tegenstander: Snowbound: Rockethog van Mega Bloks! Tijdens een routinepatrouille op hun arctische Rockethog rond het basiskamp zien Spartans van het blauwe team een Elite van het rode team die op hen af komt stuiven op een Covenant Ghost! Het blauwe team versnelt en richt zijn geschutkoepel op de Elite precies op het moment dat het rode team het vuur opent met de plasmakanonnen van zijn Ghost!

Snowbound: CSNU Rockethog

Scegli da quale parte stare e combatti per il controllo dello Snowbound con Versus: Snowbound: Rockethog di Mega Bloks! Fuori per il consueto giro di perlustrazione intorno alla High Base sul loro Rockethog Artico, gli Spartan della Squadra Blu individuano un Elite della Squadra Rossa che si avvicina a grande velocità su di un Covenant Ghost! La Squadra Blu preme sull'acceleratore e puntano la loro torretta lancia missili verso l'Elite proprio nel momento in cui la Squadra Rossa apre il fuoco con i cannoni al plasma a gittata media del Ghost!

Snowbound: CENU Lançador de foguetes

Escolha o seu lado e lutar pelo controle de Snowbound com a Versus: Snowbound: Rockethog pela Mega Bloks! Fora em uma patrulha de rotina em torno da Alta Base em seu Rockethog do Ártico, os Spartans do equipe azul detectar uma corrida do Elite do equipe vermelho em relação a eles em um fantasma Covenant! O equipe azul atinge o acelerador e tem como alvo o Elite com a sua torre de foguetes, assim como o equipe vermelho abre fogo com canhões médios de plasma dos seus fantasmas!



**MEGA
BLOKS**

HALO



Register for the Halo Bloks Brigade!
Apuntate a la brigada Halo Bloks!
Enrolez-vous dans la Brigade Halo Bloks!
Registrierte dich für die Halo-Bloks Brigade! • Schrijf je in voor de Halo Bloks Brigade!
Effetua la registrazione per la Brigata dei Blok Halo! • Regista-te para a Brigada Halo Bloks!

halo.megabloks.com



2X
MAI13MM



IX
MAO2250IMM



4X
MAI5484MM



2X
MAO1748MM



2X
MAI6954MM



2X
MAI133MM



2X
MAO903MM

3X
MAO4429MM



IX
MAO9023MM



4X
AMO4218MM



IX
AMO8482MM



2X
AMO9106MM



IX
MAO3772MM



IX
MAO3873MM



IX
MO3873W



3X
MAO9593MM

3X
MAO2250ISX



IX
AMO33245X



IX
AMO33235X



IX
AMO44335X



IX
AMO44345X



2X
AMI7119SX



IX
AMO84095X



IX
MAO9493MM



IX
AMI6660MM



IX
MAI480MM

5X
MAO3328AKQ



6X
MAI5258AKQ



2X
MAI086AKQ



6X
MAO9393AKQ



4X
MAO2250IAKQ



4X
MAO3019AKQ



2X
MAI322AKQ



4X
MAI54AKQ



IX
AMI7073AKQ



IX
AMI7074AKQ



2X
AMI9488AKQ

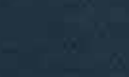

2X
AMO9487AKQ

IX
AS96805II



3X
MAO9493AKQ



IX
MAO4497AKQ



IX
AMO7225AKQ



IX
AMO7224AKQ



IX
AMI6630AKQ



IX
AMI6629AKQ



2X
MAO7475AKQ



IX
AS968059



4X
MAO9292AKQ



IX
AMI6660AKQ



IX
AMI7018MM



IX
MAO9198MM



2X
AMO9835MM



4X
AS968012



IX
MAO3773MM



IX
AMI7019MM



IX
AMI6636MM



2X
MAI6636MM



IX
MAI47MM



IX
AMI6968MM



IX
AMI6967MM



2X
AMI6964MM



IX
AMI7017MM



IX
AS968053



8X
AMI7115F



IX
AMO2767F



IX
MAO9393F



3X
MAO2250IF



4X
MAI417F



IX
AMO2768F

2X
MO9393X

6X
MA09393BYE

IX
MA03019F

IX
MA03773F

IX
AM09106F

6X
MA1154F

3X
MA09493BYE

6X
MA09493F

2X
MA09033BYE

4X
AS96805IO

8X
AM1714F

IX
MA09292F

2X
MA1480F

2X
AM17055F

IX
AM02237F

2X
MA10233BYE

IX
MA08483F

2X
MA09923F

2X
MA1172F

XBOX 360 343 INDUSTRIES

© 2012 MICROSOFT CORPORATION. ALL RIGHTS RESERVED. MICROSOFT, 343 INDUSTRIES, THE 343 INDUSTRIES LOGO, HALO, THE HALO LOGO, XBOX, XBOX 360, AND THE XBOX LOGOS, ARE TRADEMARKS OF THE MICROSOFT GROUP OF COMPANIES.



IX
AS9706504

2X
AS9706501

IX
AS9682308

2X
AM17035MM

IX
L968053



- EN Please read these instructions carefully before first use and keep them for future reference.
- ES Leer estas instrucciones cuidadosamente antes de la primera utilización y guardarlas para referencia futura.
- FR Il est recommandé de lire attentivement ce feuillet avant la première utilisation et de le conserver pour référence future.
- DE Die Gebrauchsanleitung bitte durchlesen und aufbewahren.
- NL Wij raden u aan deze handleiding zorgvuldig te lezen en te bewaren voor eventuele raadpleging op een later tijdstip.
- DA Vær venlig at læse disse instruktioner omhyggeligt inden ibrugtaget og opbevar dem til fremtidigt brug.
- EL Διαβάστε αυτές τις οδηγίες προσεκτικά πριν χρησιμοποιήσετε το προϊόν για πρώτη φορά και φυλάξτε τις για μελλοντική αναφορά.
- FI Lue nämä ohjeet huolellisesti ennen ensimmäistä käyttöä ja säilytä ne myöhempää tarvetta varten.
- IT Leggere le istruzioni prima di cominciare ad usare il gioco e conservarle per reference future.
- NO Les disse instruksjonene nøye før første gangs bruk, og ta vare på dem for fremtidige oppslag.
- PT Leia as instruções antes do primeiro uso e guarde-as para futura referência.
- SV Läs noggrant igenom dessa instruktioner innan du använder produkten för första gången och spara dem för ev. framtida frågor.
- JA 初めてご使用になる前に、この説明書をよくお読みください。また、本書は将来いつでも参照できるように保管してください。
- ZH 请在初次使用前仔细阅读这些指示，并保留它们以便未来参考。
- AR يرجى قراءة هذه التعليمات بدقة قبل البدء بالاستعمال والاحتفاظ بها كمرجع للمستقل.

EN ⚠ WARNING :
CHOKING HAZARD. - Small parts.
Toy contains a small ball.
Not for children under 3 years.

ES ⚠ ADVERTENCIA :
RIESGO DE ASFIXIA. - Contiene piezas pequeñas.
El juguete contiene una bola pequeña.
No recomendado para niños menores de 3 años.

FR ⚠ ATTENTION :
DANGER D'ÉTOUFFEMENT. - Présence de petits éléments.
Le jouet contient une petite balle.
Ne convient pas aux enfants de moins de 3 ans.

DE ⚠ ACHTUNG :
ERSTICKUNGSGEFAHR. - Enthält kleine Teile.
Ein kleiner Ball ist im Spielzeug inbegriffen.
Nicht für Kinder unter 3 Jahren geeignet.

NL ⚠ WAARSCHUWING :
VERSTIKKINGSGEVAAR. - Bevat kleine onderdelen.
Speelgoed bevat een klein balletje.
Niet geschikt voor kinderen onder de 3 jaar.

DA ⚠ ADVARSEL :
FARE FOR KVÆLNING. - Indeholder smådele.
Legetøjet indeholder en lille bold.
Ikke til børn under 3 år.

EL ⚠ ΠΡΟΕΙΔΟΠΟΙΗΣΗ :
ΚΙΝΔΥΝΟΣ ΠΝΙΓΜΟΥ. - Περιέχει μικρά αντικείμενα.
Το παιχνίδι περιέχει ένα μπαλάκι.
Όχι για παιδιά κάτω των 3 ετών.

FI ⚠ VAROITUS :
TUKEHTUMISVAARA. - Sisältää pieniä osia.
Lelun sisältyy pieni pallo.
Ei alle 3-vuotiaalle lapsille.

IT ⚠ AVVERTENZA :
PERICOLO DI SOFFOCAMENTO. - Contiene piccole parti.
Il giocattolo comprende una pallina.
Non indicato per bambini sotto i 3 anni.

NO ⚠ ADVARSEL :
KVELNINGSFARE. - Inneholder små deler.
Leketøy inneholder en liten ball.
Kun for barn over 3 år.

PT ⚠ ATENÇÃO :
PERIGO DE ASFIXIA. - Contém peças pequenas.
O brinquedo contém uma pequena bola.
Não é concebido para crianças de menos de 3 anos.

SV ⚠ VARNING :
KVÄVNINGSRISK. - Innehåller små delar.
Leksaken innehåller en liten boll.
Inte för barn under 3 år.

JA ⚠ 警告:
のどにつまる危険 小さな部品が含まれています
小さな玉が含まれています。
3歳以下の子供には与えないで下さい。

ZH ⚠ 警告:
噎住危险 包含有小部件
此玩具含有一个球。
不适合3岁以下的幼儿玩。

AR ⚠ تحذير :
خطر الاختناق - قطع صغيرة
تحتوي اللعبة على كرة صغيرة.
غير صالحة للأطفال أقل من 3 سنوات.



Get the free mobile app for your phone
<http://gettag.mobi>



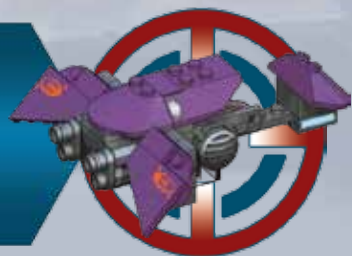

1

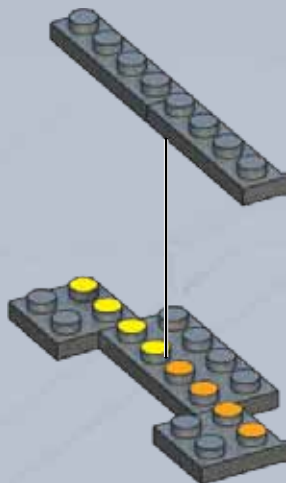

1

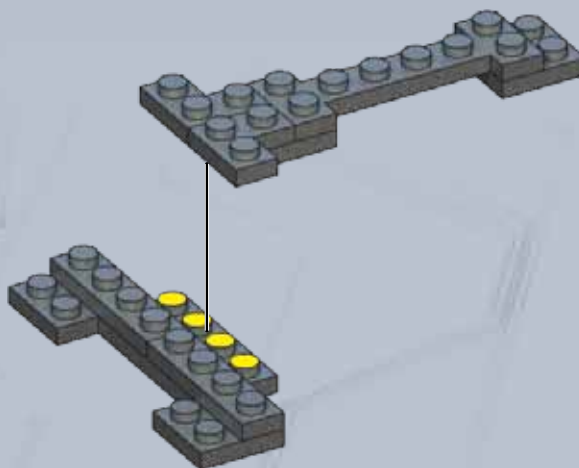

2

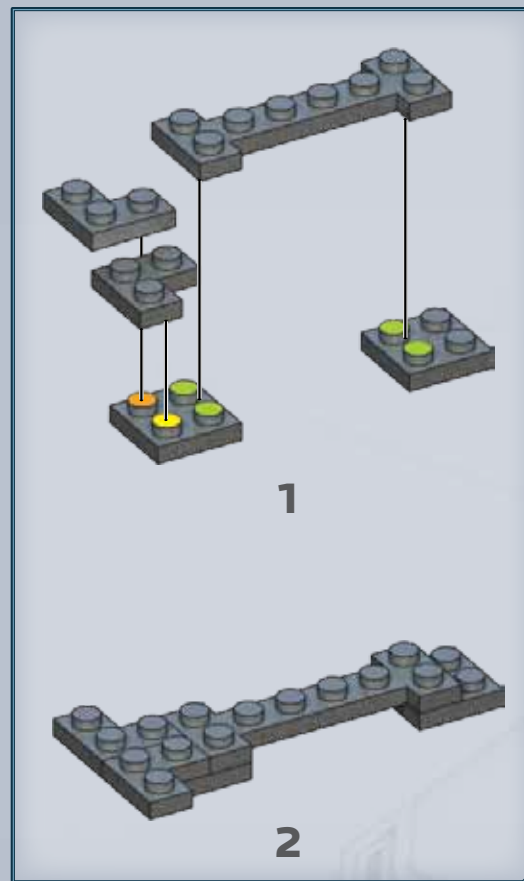

1

2

2

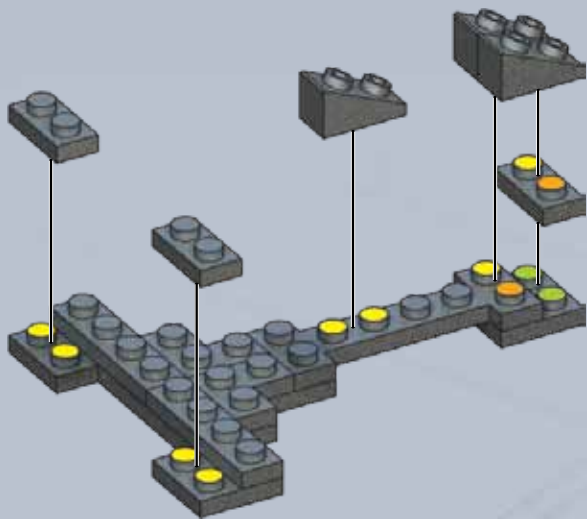

3

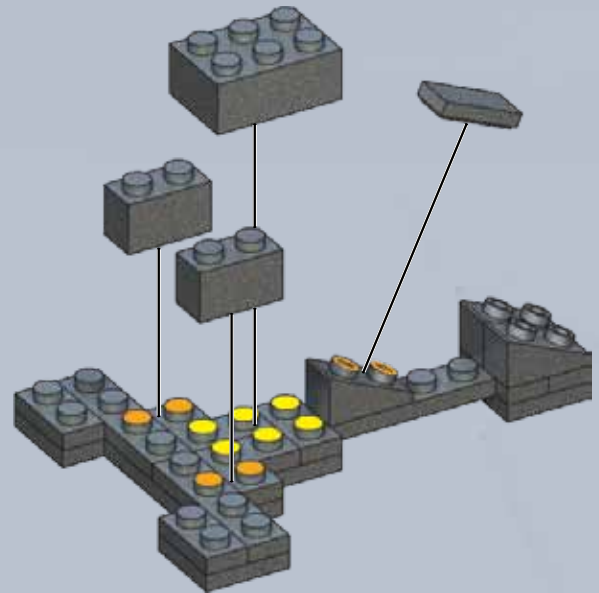

7

4

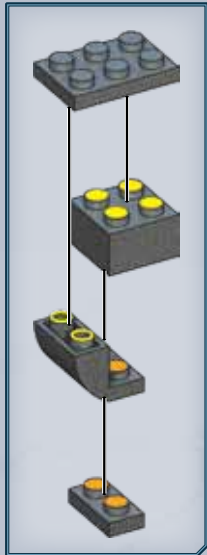
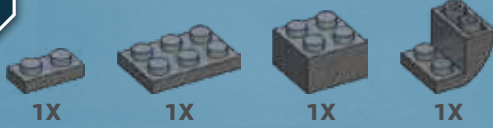

13 14 22

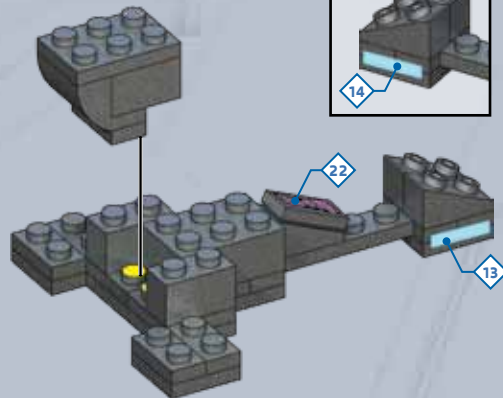

5

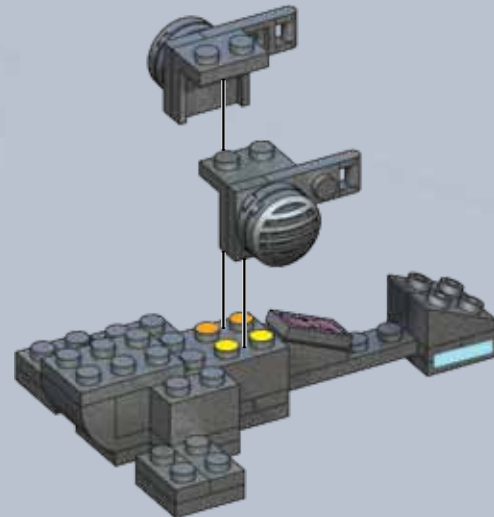
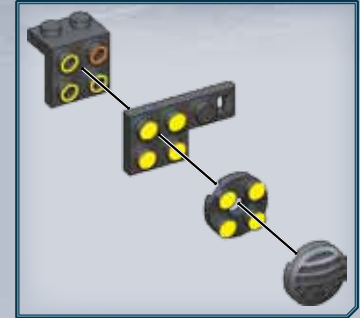
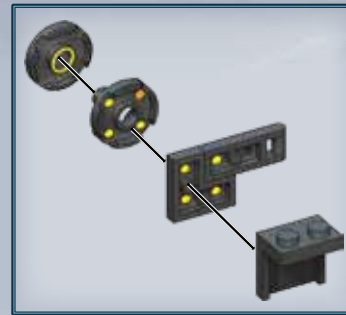

8

6



2X



1X



1X

7



2X



4X



2X



2X

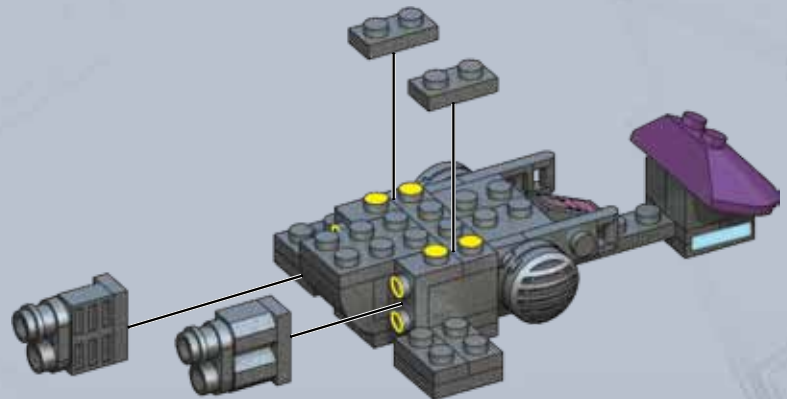
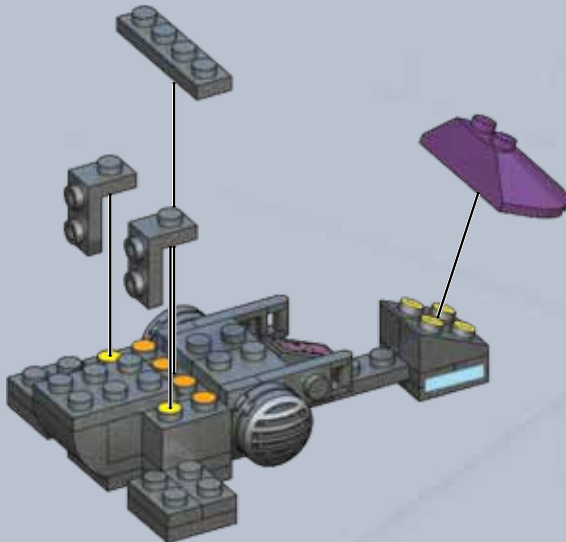
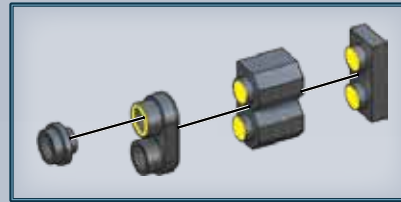
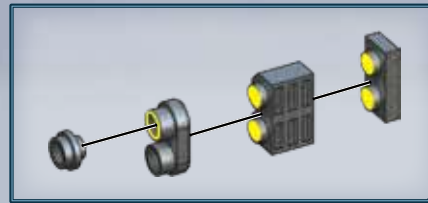

9

8

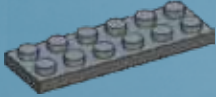

1X



4X

9



2X



1X



1X



2X



1X



1X

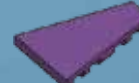

1X

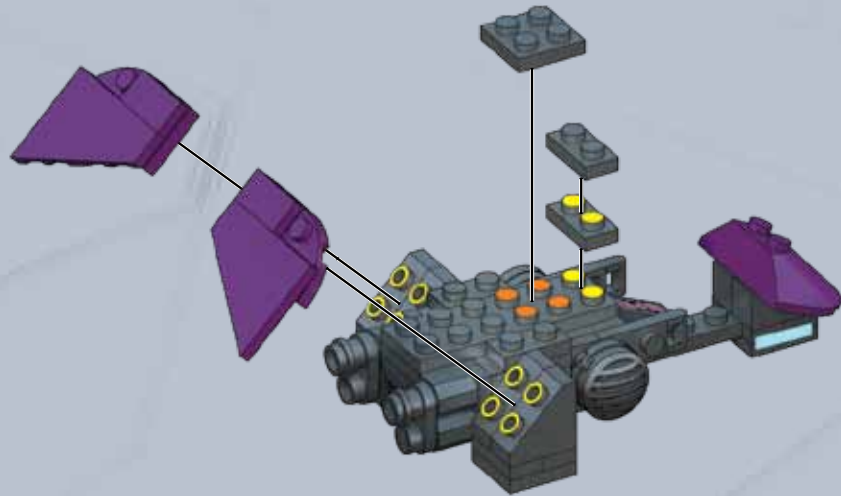
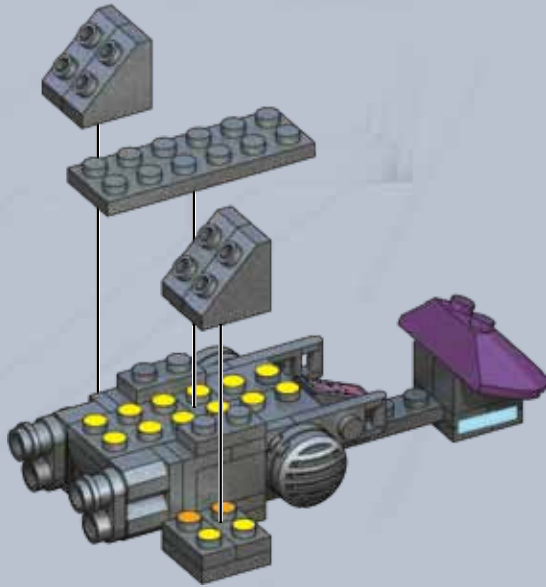
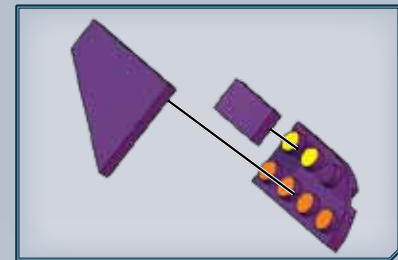
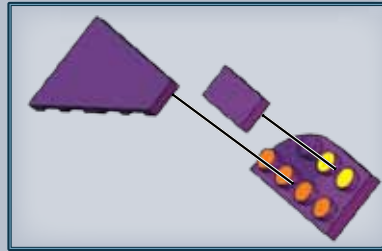

10

10

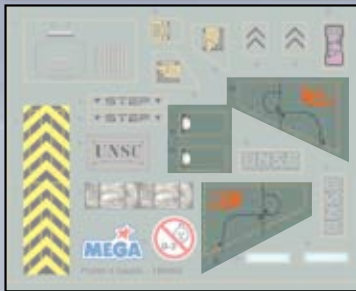

8 9 12 15

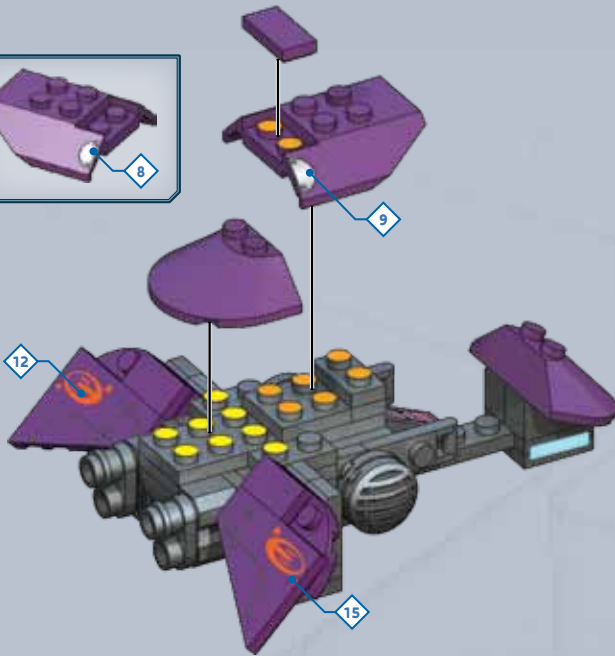

11

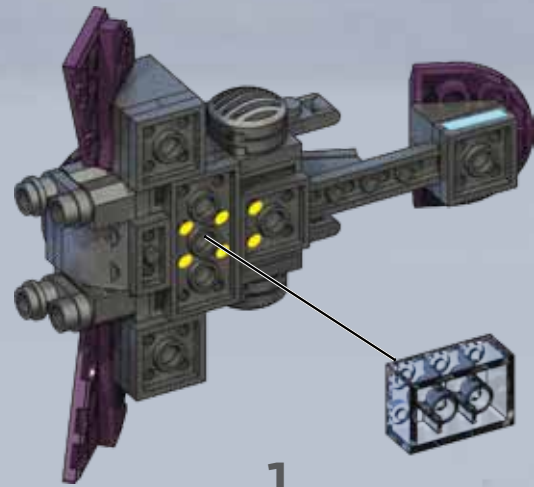

1

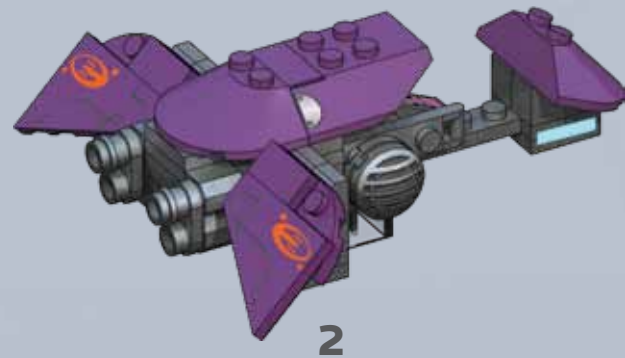

2



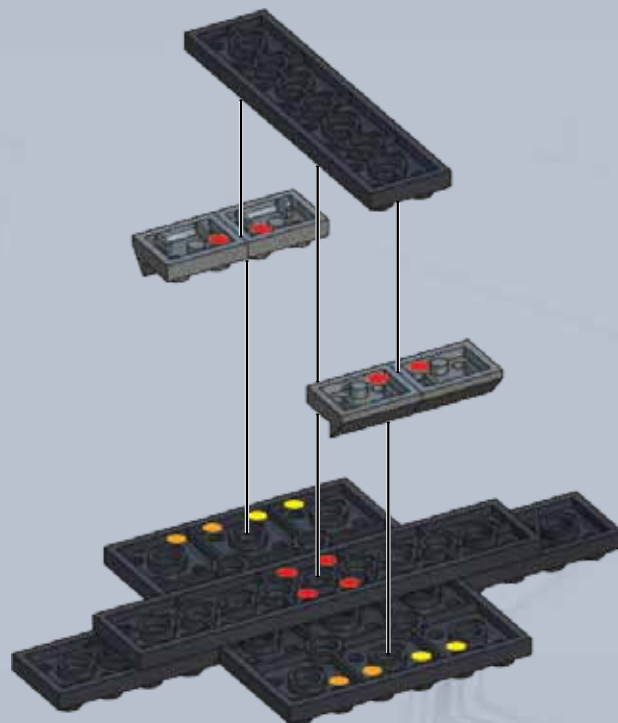
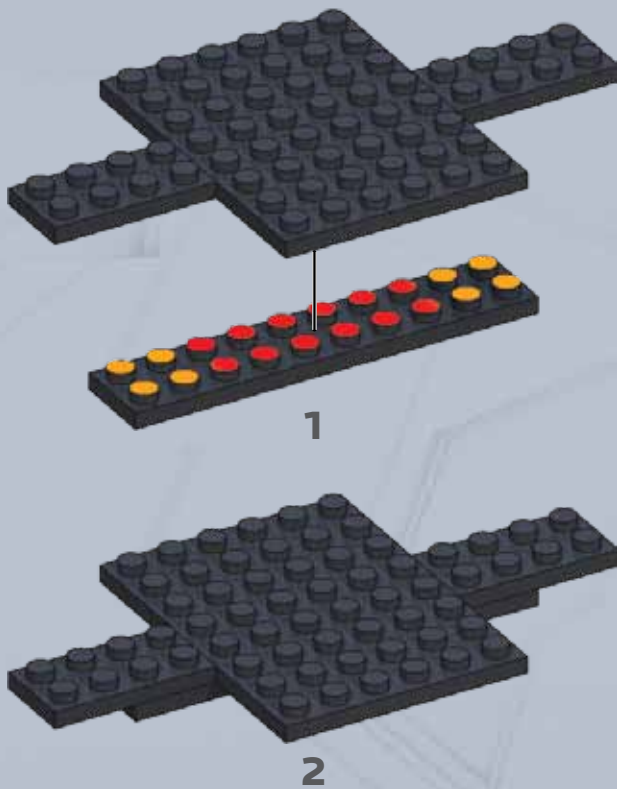
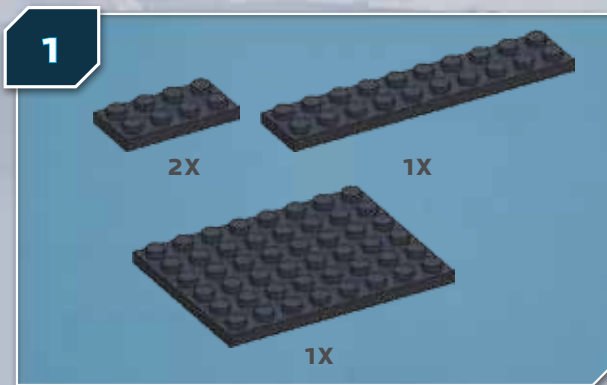

3

6X

2X

Place temporary pieces.
 Colocar las piezas provisionales.
 Installer les pièces temporaires.
 Provisorische Teile einsetzen.
 Instaleer de tijdelijke onderdelen.
 Piazzare i pezzi temporanei.
 Colocar peças temporárias.

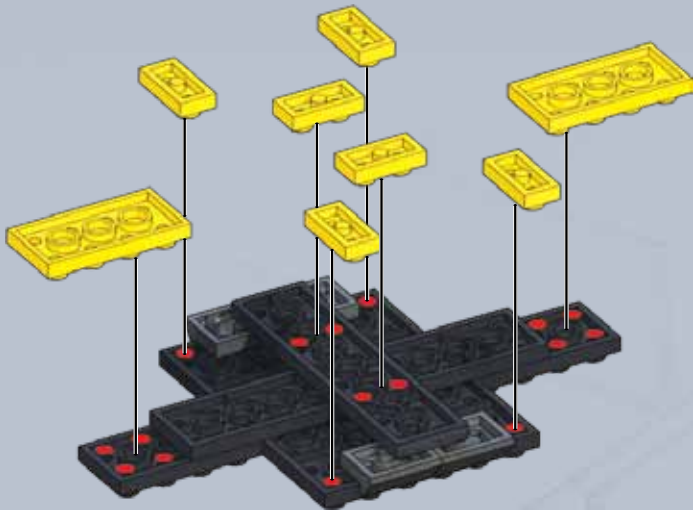
**4**

1X

2X

2X

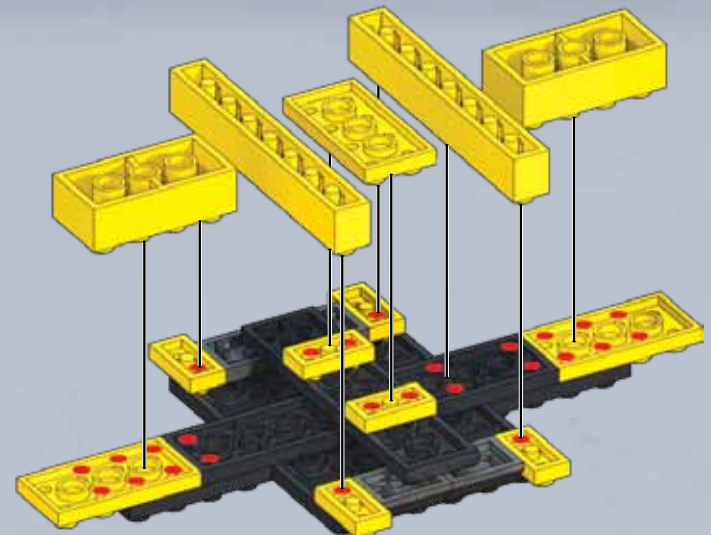

1

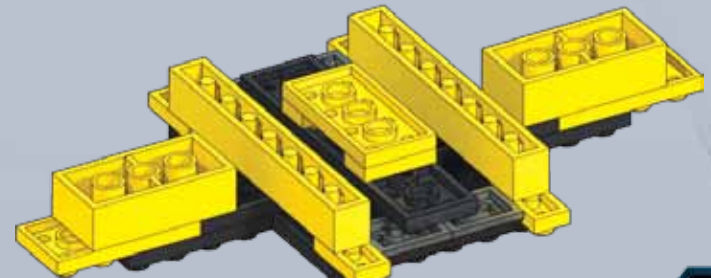

2

13

5



1X



1X

6



4X



3

3

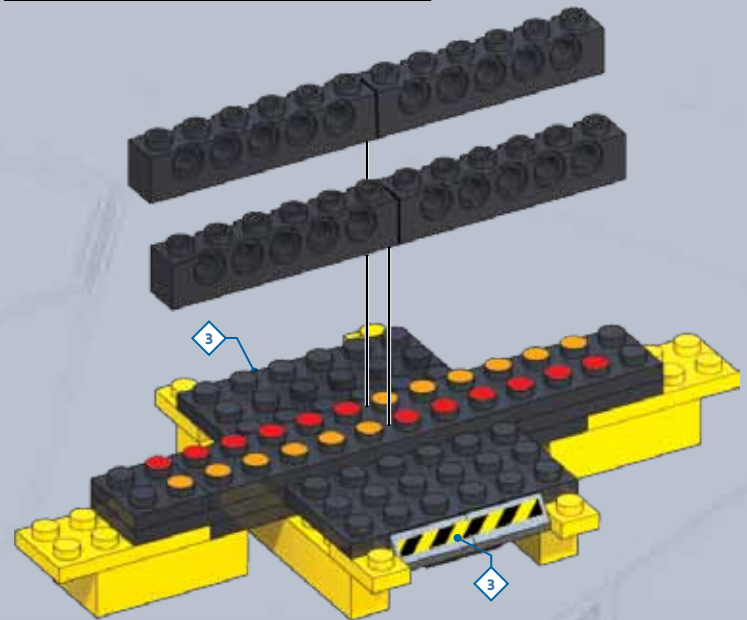
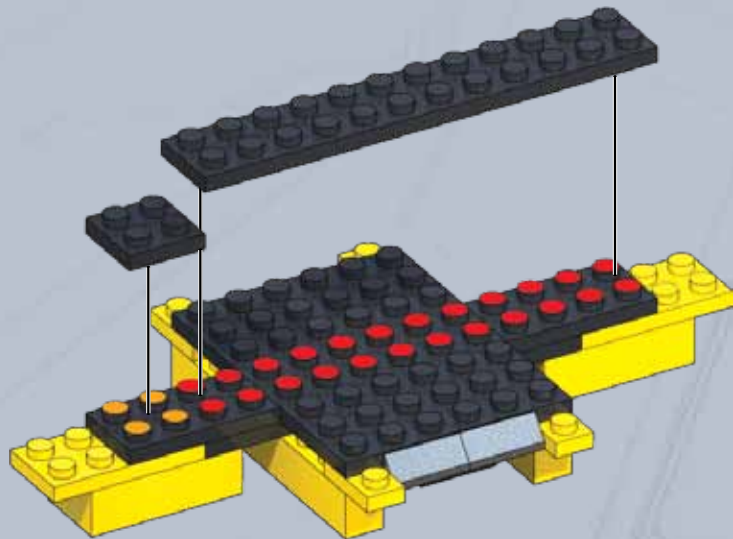

7

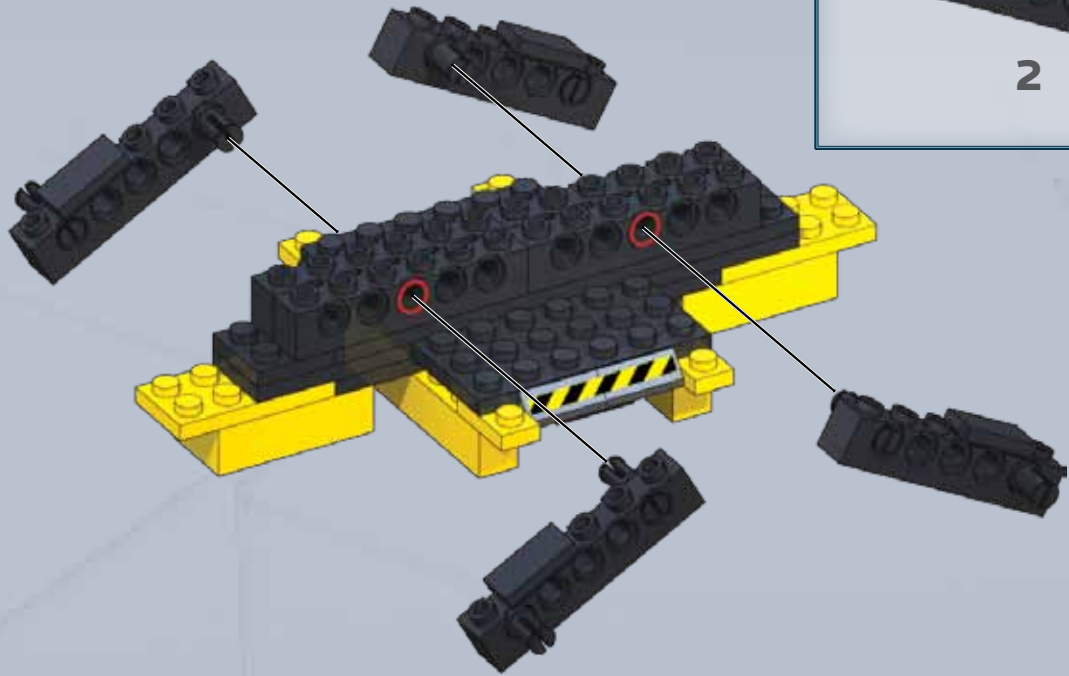

15

8

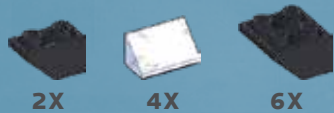

9

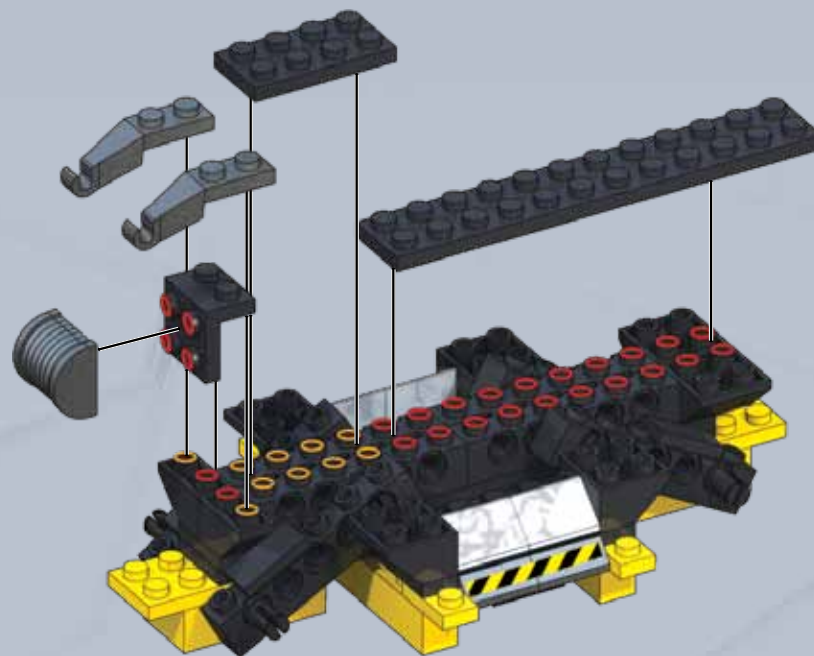
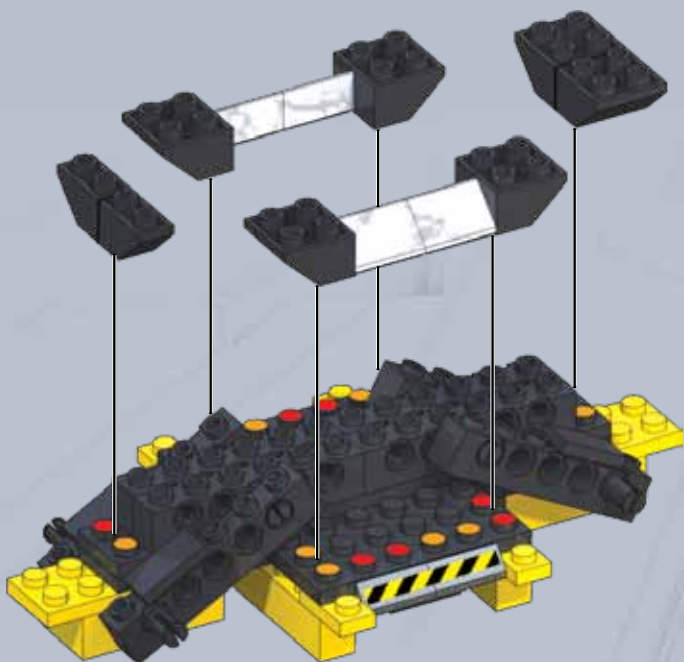

10

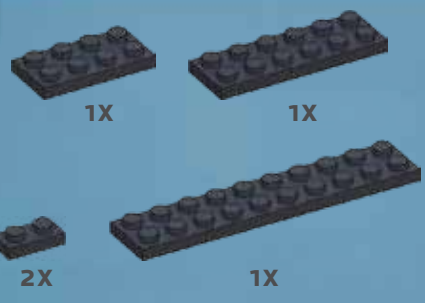

11

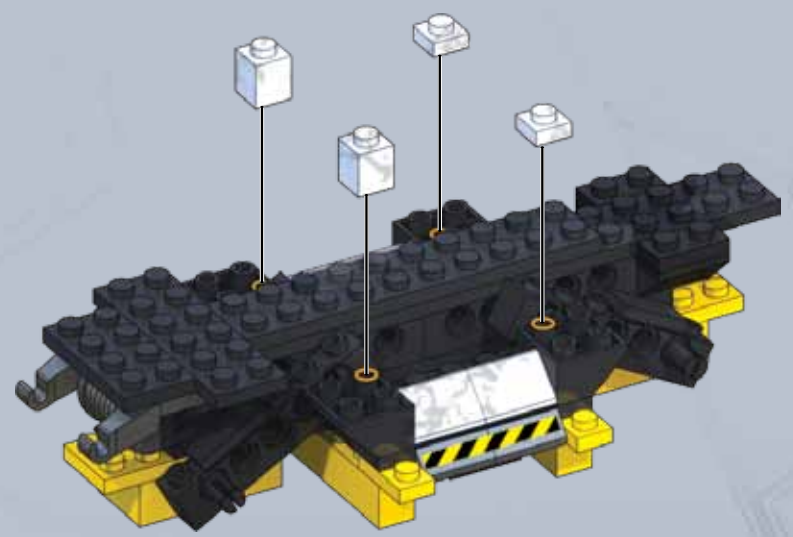
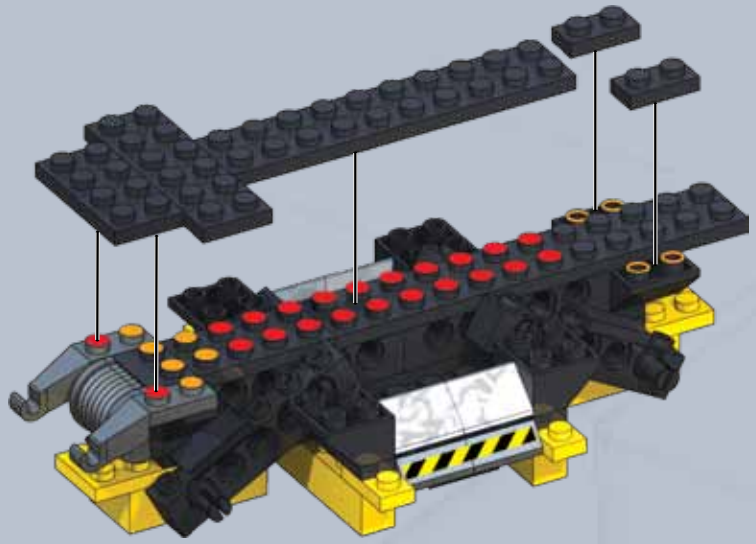

17

12



4X



2X

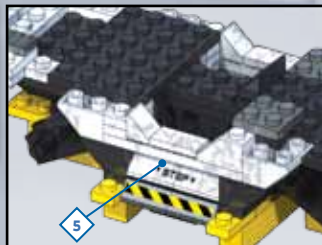

5

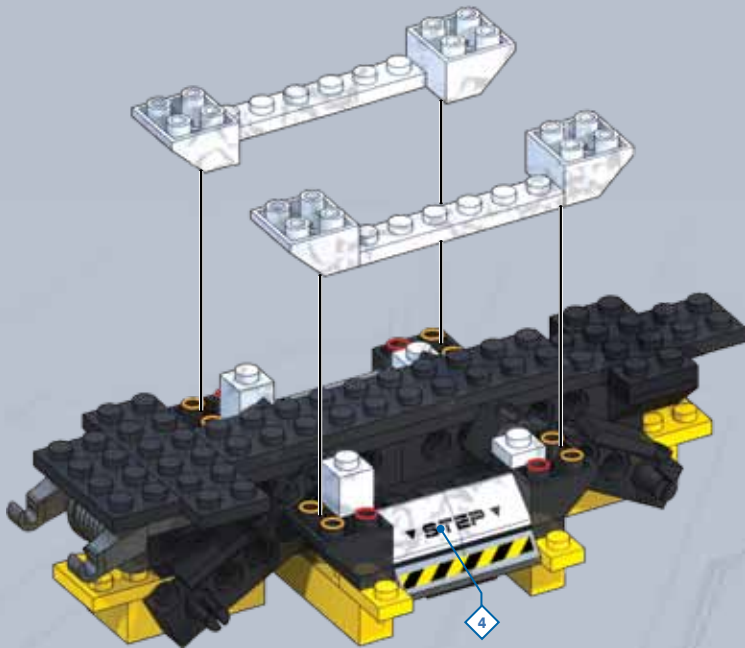

4

13



2X



2X



4X



2X

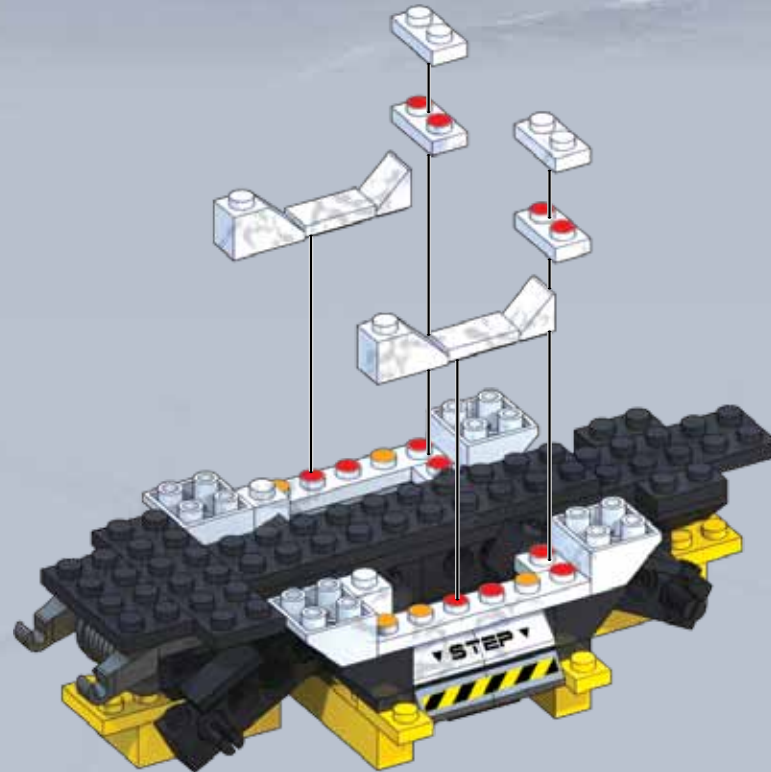

18

4 5



14



1



2

19

15

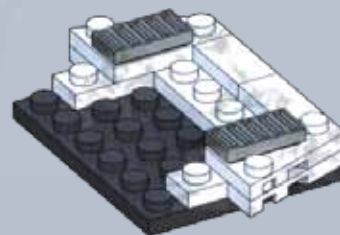
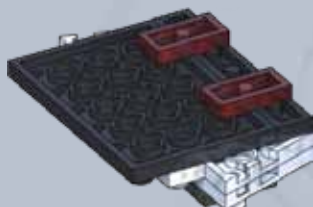
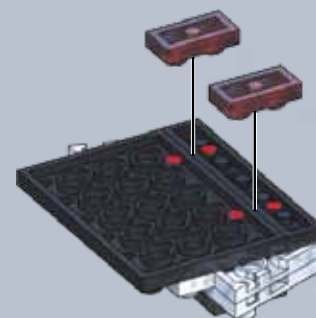
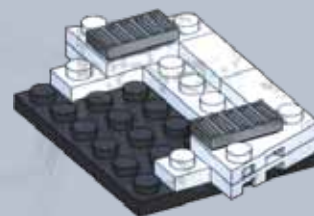
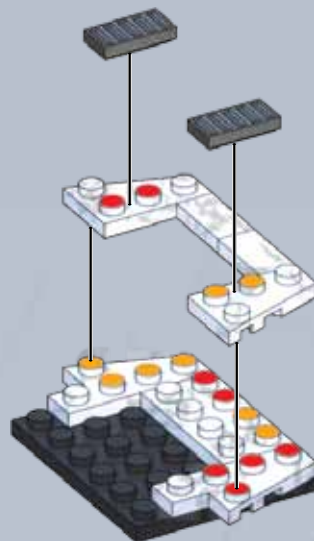
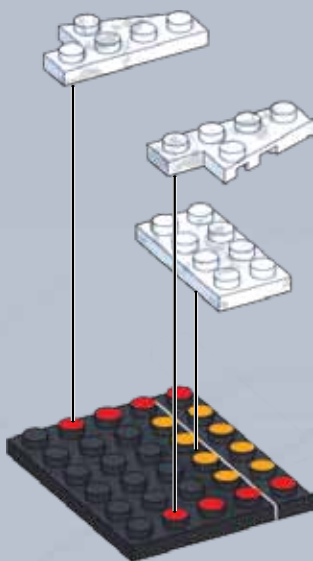

20

16

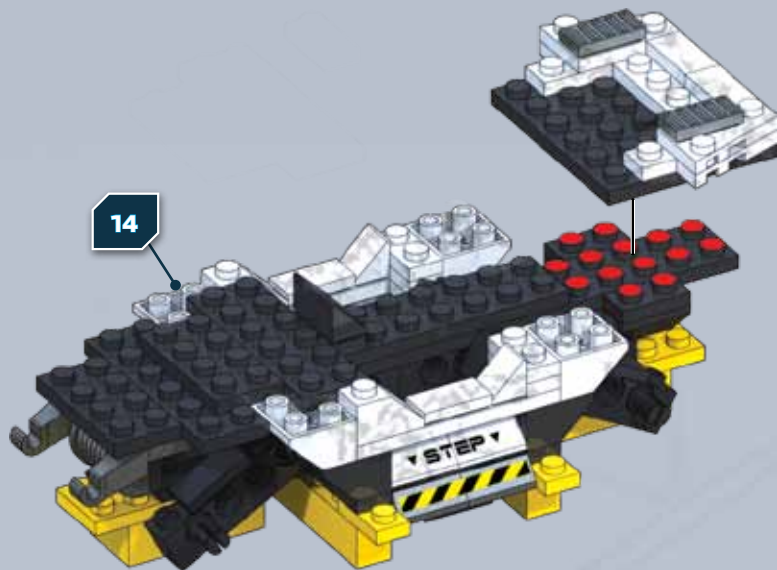

14

17



2X

1X

1X

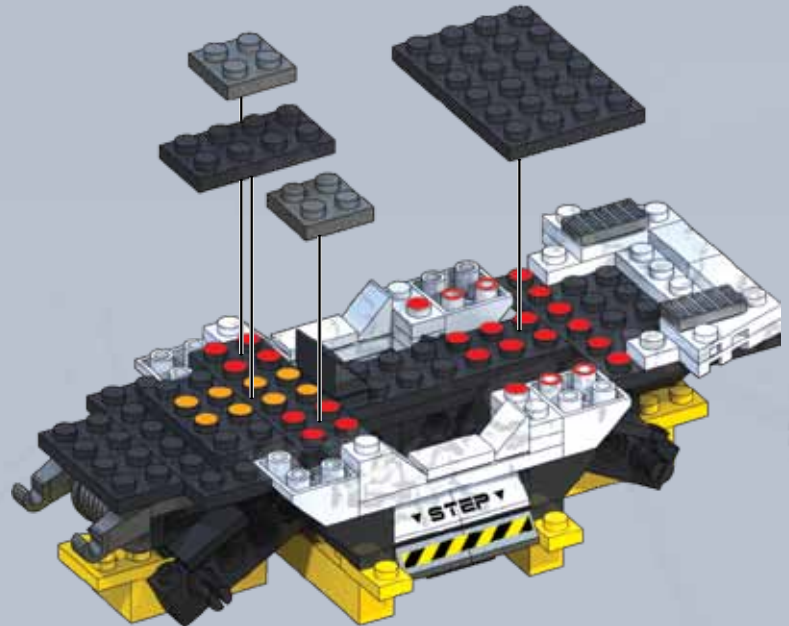

21

18



1X

2X

2X

19



1X



1X



1X



1X



1X

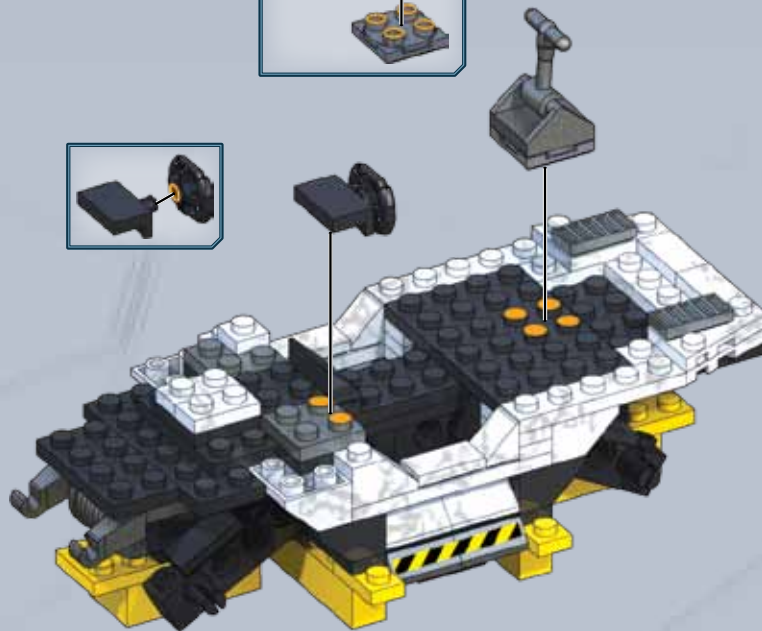
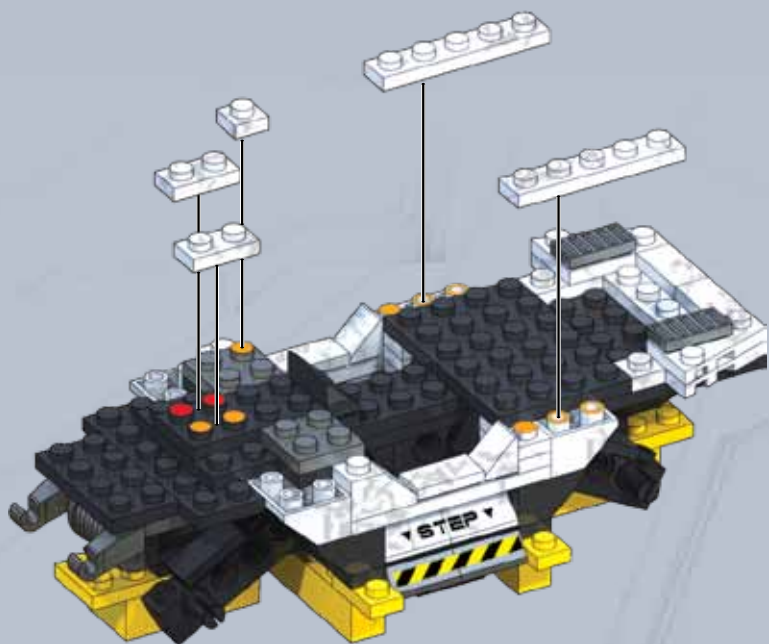

22

20

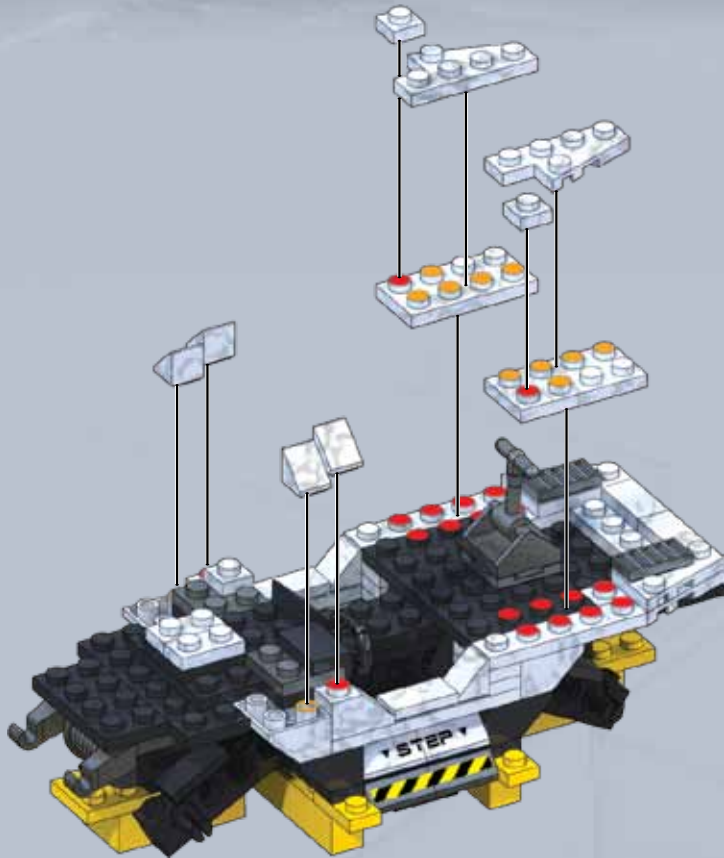

21

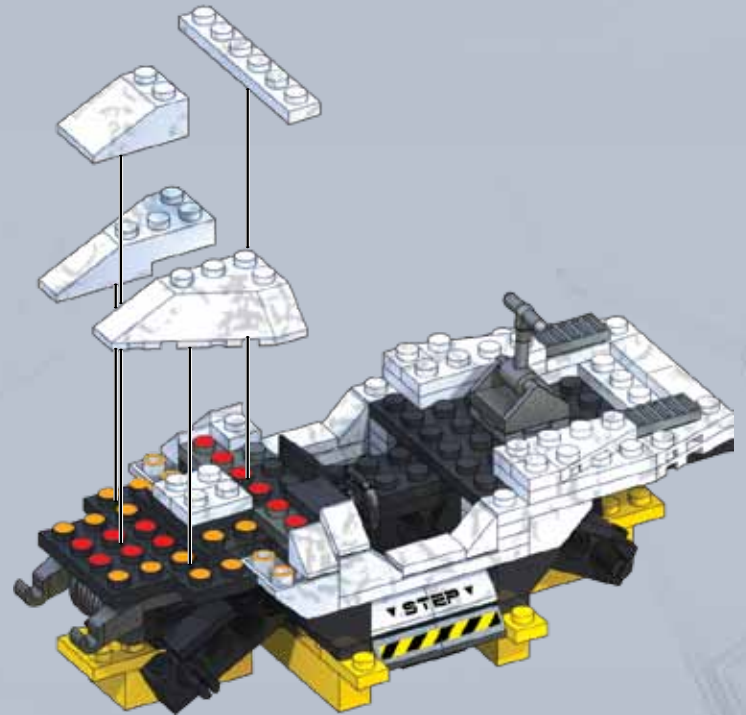
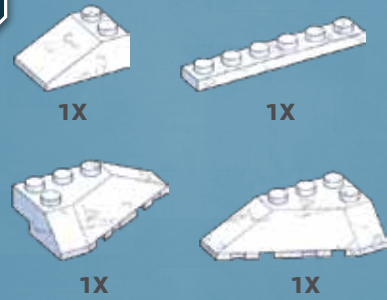

23

22

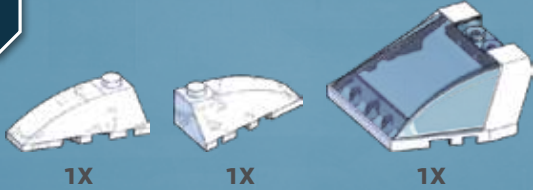

1X

1X

1X

23



1X



1X



1X



1X

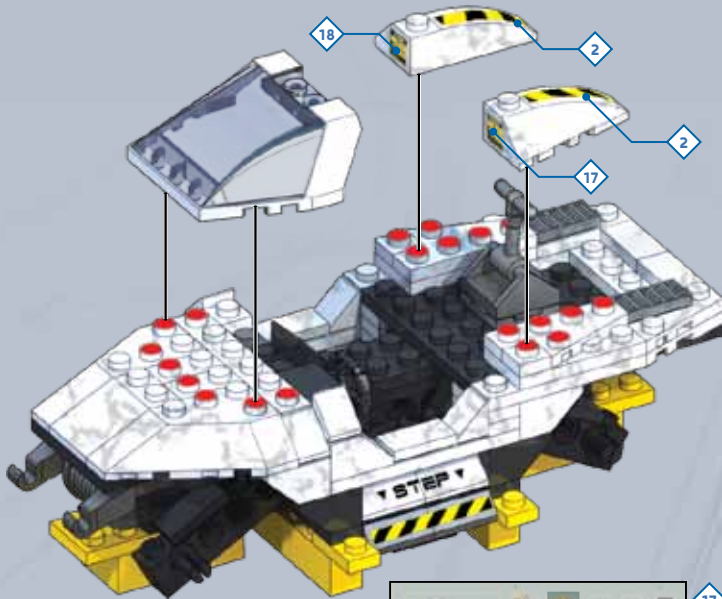

17 2
18 2

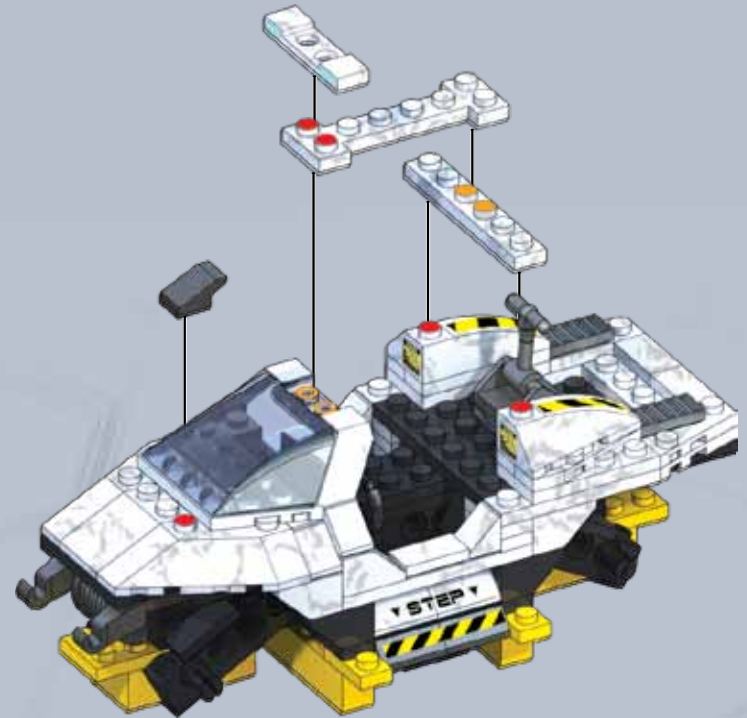

24

24



4X

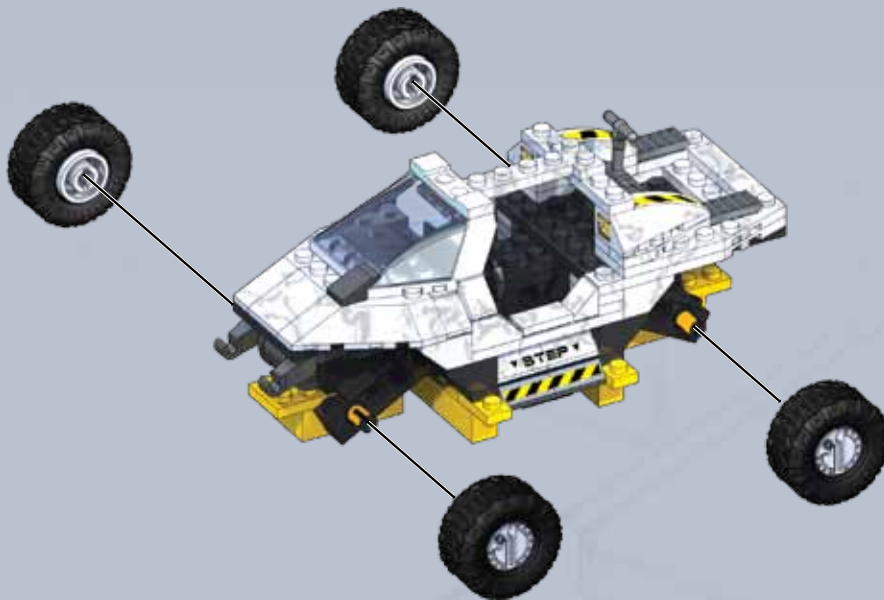

25

Remove temporary pieces.
Retirar las piezas provisionales.
Enlever les pièces temporaires.
Provisorische Teile entfernen.
Verwijder de tijdelijke onderdelen.
Rimuovere i pezzi temporanei.
Retirar peças temporárias.

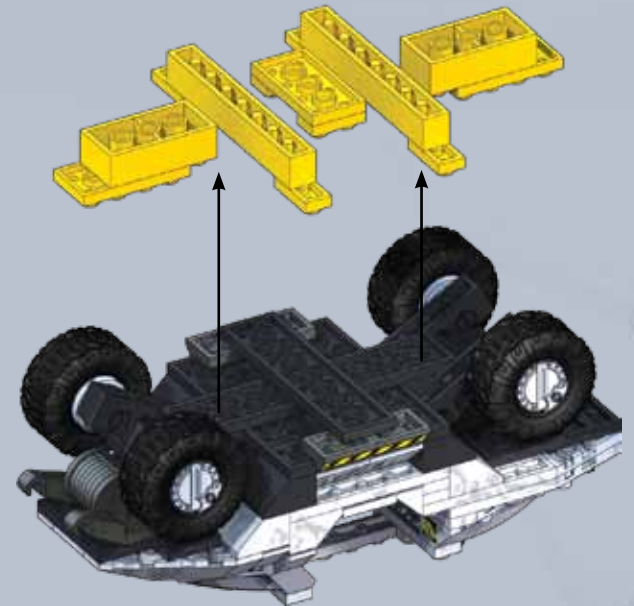

25

26

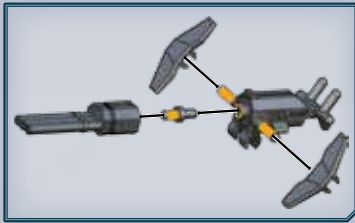
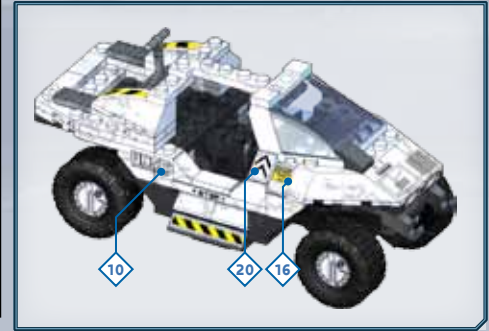
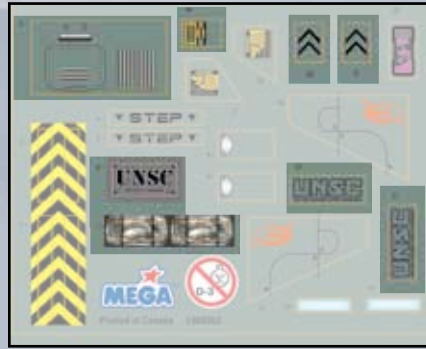
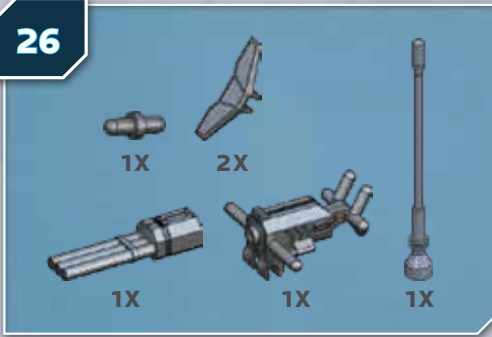

1



2

26



SNOWBOUND: UNSC ROCKETHOG

Choose your side and fight for control of Snowbound with the Versus: Snowbound: Rockethog by Mega Bloks! Out on a routine patrol around High Base on their Arctic Rockethog, Blue Team's UNSC Spartans spot a Red Team Covenant Elite Combat racing towards them on a Covenant Ghost. Blue Team hits the accelerator and targets the Elite with their rocket burn! Just as Red Team opens fire with his Ghost's plasma cannons!

Snowbound: CENU Lanzador de cohetes

Elige tu bando y lucha por el control de Snowbound con el Versus: Snowbound: Rockethog de Mega Bloks! (Fuera en un patrullaje rutinario alrededor de la base de altura en su Arctic Rockethog, el Equipo Azul de los Spartans localiza al Equipo Rojo Elite acelerando hacia ellos en un Covenant Ghost.) El Equipo Azul pisa el acelerador y apunta a Elite con su torreta cohete justo cuando el Equipo Rojo abre fuego con sus cañones de plasma medianos Ghosts!

Snowbound: Rockethog du CSNU

Choisissez votre allégeance et combattez afin de contrôler Snowbound avec l'ensemble Versus: Rockethog Snowbound de Mega Bloks! Lors d'une patrouille de routine autour de la base surélevée à bord de leur Rockethog arctique, les Spartans de l'équipe bleu détectent un Elite de l'équipe rouge filant tout droit vers eux à bord d'un Ghost du Covenant! L'équipe bleu enfonce l'accélérateur et place l'Elite dans la mire de sa tourelle lance-roquettes alors que l'équipe rouge fait feu à l'aide des canons au plasma moyens de son Ghost!

Snowbound: RVN Rockethog

Entscheide dich für eine Seite und kämpfe um die Kontrolle über Snowbound mit deinem Gegner: Snowbound: Rockethog von Mega Bloks! Auf einem Routine-Rundgang rund um das arktische Rockethog entdecken die Spartans vom Blauen Team eine Einheit des Roten Teams, die auf sie zu rasen in einem Covenant Ghost. Das Blaue Team tritt auf das Gaspedal und zielt mit ihrem Raketenrum genau in dem Moment auf die Einheit des Roten Teams, als das Rote Team mit den mittleren Plasma-Kanonen des Ghost das Feuer eröffnet!

Snowbound: RVN-raketwagen

Bepaal aan welke kant je staat en vecht voor de controle over Snowbound met je tegenstander: Snowbound: Rockethog van Mega Bloks! Tijdens een routinepatrouille op hun arctische Rockethog rond het basiskamp zien Spartans van het blauwe team een Elite van het rode team die op hen af komt stuiven op een Covenant Ghost! Het blauwe team versnelt en richt zijn geschutkoepel op de Elite precies op het moment dat het rode team het vuur opent met de plasmakanonnen van zijn Ghost!

Snowbound: CSNU Rockethog

Scegli da quale parte stare e combatti per il controllo dello Snowbound con Versus: Snowbound: Rockethog di Mega Bloks! Fuori per il consueto giro di perlustrazione intorno alla High Base sul loro Rockethog Artico, gli Spartans della Squadra Blu individuano un Elite della Squadra Rossa che si avvicina a grande velocità su di un Covenant Ghost! La Squadra Blu preme sull'acceleratore e puntano la loro torretta lancia missili verso l'Elite proprio nel momento in cui la Squadra Rossa apre il fuoco con i cannoni al plasma a gittata media del Ghost!

Snowbound: CENU Lançador de foguetes

Escolha o seu lado e lutar pelo controle de Snowbound com a Versus: Snowbound: Rockethog pela Mega Bloks! Fora em uma patrulha de rotina em torno da Alta Base em seu Rockethog do Ártico, os Spartans do equipe azul detectar uma corrida de Elite do equipe vermelho em relação a eles em um fantasma Covenant! O equipe azul atinge o acelerador e tem como alvo o Elite com a sua torre de foguetes, assim como o equipe vermelho abre fogo com canhões médios de plasma dos seus fantasmas!



MEGABLOKS CAMO EFFECT EFFECTO CAMO MEGABLOKS EFFET CAMO MEGABLOKS

MEGABLOKS CAMO EFFECT!
MEGABLOKS CAMO EFFECT!
EFFET CAMO MEGABLOKS!
EFFET CAMO MEGABLOKS!



UNSC INTEL



Collect them all! - ¡Colecciónalos todos! - Collectionne-les tous!
Hol sie dir alle! - Verzamel ze allemaal! - Collezionali tutti! - Coleccione todos eles!



UNSC SPARTAN

UNSC Spartan
Spartiate du CSNU
UNSC-Spartaner
VN Spartan
Spartano UNSC
Espartano da UNSC



COVENANT ELITE COMBAT

Elite de Combate
Elite de combat
Elite-Kampfeinheit
Gevechtseleite
Combate Elite
Elite da combattimento



97065



97043



97069



©2012, MEGA Brands Inc.
© & ™ MEGA Brands Inc.

Printed in Canada D970031A