

**MEGA
BLOKS**

HALO



97016

UNSC Rhino • Rhino UNSC • Rhino du CSNU
RVN Rhino • UNSC Rhino-gevechtsvliegtuig • Rhino del CENU • Rhino CENU

ORBITAL BANSHEE BLITZ

UNSC Rhino

As the Covenant hide out in an old Forerunner structure, the massive UNSC Rhino tank is called in to eliminate the base and keep the ancient technology out of enemy hands. The UNSC Rhino is a massive 6-tread artillery tank armed with the prototype Zeus 320 mm Cannon that rotates a full 360 degrees, and capable of a lock-down mode to aid in long range bombardment.

Rhino del CENU

Al esconderse en el Covenant en una estructura Forerunner, llaman al tanque masivo Rhino del CENU para eliminar la base y mantener la tecnología antigua fuera de las manos del enemigo. El Rhino del CENU es un tanque masivo armado de artillería de 6 bandas de rodamiento con el prototipo de cañón Zeus 320 mm que rota 360 grados completos y capaz de un modo de cierre para ayudar en un bombardeo de largo alcance.

Rhino du CSNU

Pendant que les forces du Covenant se cachent à l'intérieur d'une vieille structure Forerunner, l'énorme char d'assaut Rhino du CSNU se charge de détruire la base et de s'assurer que ces technologies anciennes ne tombent pas entre les mains de l'ennemi. Le Rhino du CSNU est un char d'assaut gigantesque à 6 chenilles armé du prototype de canon Zeus 320 mm pouvant tourner sur 360 degrés et capable de passer en mode stationnaire pour effectuer des bombardements de longue portée.

RVN Rhino

Während der Covenant sich in einer alten Vorläuferstruktur versteckt, wird der massive RVN-Rhino-Panzer gerufen, um die Basis zu beseitigen und dem Feind die alte Technologie aus den Händen zu nehmen. Der RVN Rhino ist ein massiver 6-kettiger Artilleriepanzer, ausgerüstet mit dem Prototyp der Zeus 320 mm Kanone, die um volle 360 Grad drehbar ist und mit einem Sperrmodus ausgestattet ist, um beim Langstrecken-Bombardement Unterstützung zu leisten.

RVN Rhino

Omdat de Covenant zich in een oude Forerunner-installatie heeft verschanst, wordt de hulp van de enorme RVN Rhino-tank ingeroepen om de basis te vernietigen en de oude technologie uit vijandelijke handen te houden. De RVN Rhino is een indrukwekkende artillerietank op rupsbanden die is uitgerust met een Zeus 320mm Cannon dat 360 graden kan draaien en kan worden vastgezet voor lange-afstandsbombardementen.

Rhino CSNU

Mentre il Covenant è nascosto in una struttura Forerunner, il massiccio carro armato CSNU Rhino è chiamato per eliminare la base e tenere l'antica tecnologia al riparo dalle mani del nemico. L'CSNU Rhino è un enorme carro armato con artiglieria a 6 fila armato con il cannone prototipo Zeus 320-mm, capace di una rotazione completa di 360 gradi, e in grado di operare in modalità bloccata per offrire supporto nei bombardamenti a lungo raggio.

Rhino CENU

Como o esconderijo do Covenant em uma estrutura Forerunner antiga, o enorme tanque Rhino do UNSC é chamado para eliminar a base e manter a antiga tecnologia longe das mãos do inimigo. O Rhino do CENU é um enorme tanque de artilharia de 6 esteiras com o protótipo do canhão Zeus 320 mm que gira 360 graus e que é capaz operar em modo de alerta máximo para auxiliar bombardeios de longo alcance.



**MEGA
BLOKS**

HALO



Register for the Halo Bloks Brigade!
Apuntate a la brigada Halo Bloks!
Enrolez-vous dans la Brigade Halo Bloks!
Registrierte dich für die Halo-Bloks Brigade!
Schrijf je in voor de Halo Bloks Brigade!
Effetua la registrazione per la Brigata dei Blok Halo!
Regista-te para a Brigada Halo Bloks!

halo.megabloks.com

2x AMI7003HJ
 8x AMI7003F
 8x MAO3328F
 8x MAO3328APD
 2x MAI140APD
 3x AMO884IW
 2x AMI7062W
 1x MI312W
 1x MI140W
 8x AMI8623F
 6x AMI7018MM
 4x MAI5258APD
 2x AMO8412HJ
 1x MAO910F
 10x MAI086APD
 4x AMI72090MM
 4x AMI7201APD
 2x AMI7506W
 12x AMI7506F

2x MAO9198F
 2x MAO2250IALG
 4x MAO2250IAPD
 1x MAO7590MM
 2x MAO9393F
 55x MAO9393APD
 2x MAO9393ALG
 2x AMI8756APD
 2x AMI8221F
 2x AMI6680ALG
 2x AMI8666APD
 2x AMI8665APD
 8x MAO3019F
 4x MAO3019APD
 2x AMI6679APD
 4x AMI7128APD
 12x MAO4430APD
 10x MAO4430ALG
 2x MAI322APD
 2x MAI417APD
 8x MAO9013APD
 1x AM72014APD

2x AMI7502APD
 6x MAI133APD
 2x AMI8220F
 22x MAI5484APD
 2x AMI7153APD
 1x AMI9380F
 4x AMI8543F
 1x MAO948APD
 2x MAO948ALG
 33x MAO3773APD
 5x MAI146ALG
 4x AMI7057W
 2x AMI8266F
 1x MAI320F
 1x AMO4217F
 4x AMI9647APD
 2x MAI154APD
 4x MAI0273ALG
 14x MAO9023APD

1x AMI8671APD
 18x AMO2783APD
 1x AM72016F
 1x AM72015F
 6x AM72088APD
 6x AMI7285APD
 14x MAI141APD
 12x MAI314APD
 1x AMI7074APD
 1x AMI7073APD
 1x AMI7074F
 1x AMI7073F
 1x MAO3772F
 28x MAO3772APD
 2x MAI418APD
 6x AMI6384APD
 2x MAO4497APD
 11x MAO3873APD

4x AMI9775F
 4x AMO9838APD
 2x AMO9838ALG
 4x MAO9593F
 27x MAO9593APD
 1x MAI390APD
 2x MAI389APD
 1x AMI8229APD
 1x AMI8228APD
 2x AMO9488APD
 2x AMO9487APD
 1x AMO9488F
 1x AMO9487F
 12x AMI6959APD
 1x AMO4433ALG
 1x AMO4434ALG
 1x AMO9493AKE

55x MAO9493APD
 19x MAI087APD
 1x AMI7503APD
 1x MAO4497F
 1x AMI8625APD
 1x AMI8624APD
 2x AMI8613APD
 2x AMI8612APD
 19x MAO9033APD
 4x MAO7475APD
 1x AMI8598F
 6x A59701603
 2x AMI7606APD
 2x AMI7607APD

2x AMO3307RL
 1x AMI6640HJ
 2x AMI6640F
 18x AMO1317AGV
 6x MAO9292APD
 2x AMI8292APD
 1x AMI6976APD
 1x AMI6962APD
 1x AMO4244APD
 2x AMO7019APD
 4x AMI8777ALG
 1x AMI6331F
 31x MAI480APD
 7x MAI313APD

3x AMI7055APD
 6x AMO4983APD
 10x MAO8483APD
 2x MAI0233APD
 3x AMO4984APD
 3x AMO4985APD
 12x MAI172APD
 2x AMI6648ALG
 2x AMI6647ALG
 1x AMI7600ALG
 1x AMI7599ALG

1x AMI5514F
 2x AM72013F
 2x AMI7049KN
 2x AM72089MM
 2x AMO9922F
 3x AMO3770APD
 3x AMO3771APD
 1x AMI8782APD
 1x AMI8783APD
 2x AMO7646APD
 2x AMI7845APD

- 1x AMI7151MM
- 1x AMI7152MM
- 1x AS9694703
- 1x AS9694705
- 1x AM72012MM
- 1x AM72249MM
- 1x AMI6700F
- 1x AMI7622F
- 1x AMI69815X
- 1x AMI8884WH
- 1x AMI88035X
- 1x L97016I

- 1x AMI81505X
- 2x AMI78705X
- 1x AS9701604
- 1x AS9701605
- 1x AS9701606
- 1x AS9701607
- 2x AS9701602
- 1x AS9697102
- 1x AS9701601

- 1x AMO9323HJ
- 1x AMI5476APD
- 1x AMI8566APD
- 1x AMI8845AKE
- 1x AMI8882AKE
- 6x AMI6646F
- 3x AMI7504APD
- 3x AMI7505APD

ARMORY ARMERIA ARMURERIE

KAMPFAUSRÜSTUNG / WAPENUITRUSTING
ARSENALE / ARMARIA

Scout Spartan Recon

BUILD & CREA Y CONSTRUIT
CUSTOMIZE PERSONALIZA ET PERSONNALISE
BAUEN UND INDIVIDUELL GESTALTEN / BOUWEN EN AANPASSEN
CONSTRUIRE E PERSONALIZZA / CONSTRUIRE E PERSONALIZA

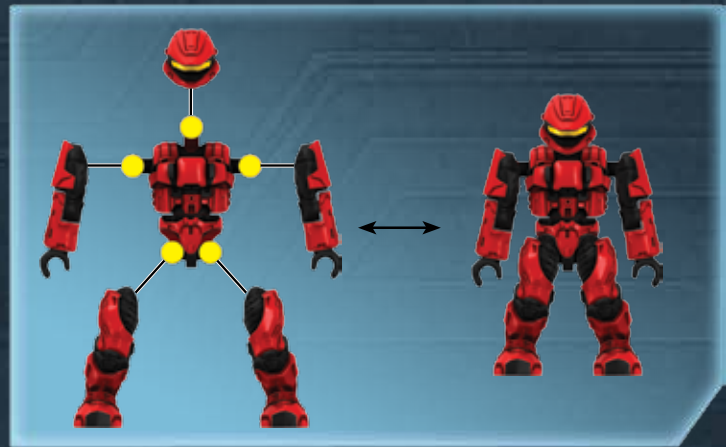

- EN Please read these instructions carefully before first use and keep them for future reference.
- ES Leer estas instrucciones cuidadosamente antes de la primera utilización y guardarlas para referencia futura.
- FR Il est recommandé de lire attentivement ce feuillet avant la première utilisation et de le conserver pour référence future.
- DE Die Gebrauchsanleitung bitte durchlesen und aufbewahren.
- NL Wij raden u aan deze handleiding zorgvuldig te lezen en te bewaren voor eventuele raadpleging op een later tijdstip.
- DA Vær venlig at læse disse instruktioner omhyggeligt inden ibrugtagning og opbevar dem til fremtidigt brug.
- EL Διαβάστε αυτές τις οδηγίες προσεκτικά πριν χρησιμοποιήσετε το προϊόν για πρώτη φορά και φυλάξτε τις για μελλοντική αναφορά.
- FI Lue nämä ohjeet huolellisesti ennen ensimmäistä käyttöä ja säilytä ne myöhempää tarvetta varten.
- IT Leggere le istruzioni prima di cominciare ad usare il gioco e conservarle per referenze future.
- NO Les disse instruksjonene nøye før første gangs bruk, og ta vare på dem for fremtidige oppslag.
- PT Leia as instruções antes do primeiro uso e guarde-as para futura referência.
- SV Läs noggrant igenom dessa instruktioner innan du använder produkten för första gången och spara dem för ev. framtida frågor.
- JA 初めてご使用になる前に、この説明書をよくお読みください。また、本書は将来いつでも参照できるように保管してください。
- ZH 请在初次使用前仔细阅读这些指示，并保留它们以便未来参考。
- AR يرجى قراءة هذه التعليمات بدقة قبل البدء بالاستعمال والاحتفاظ بها كمرجع للمستقبل

- EN ⚠️ WARNING: CHOKING HAZARD. - Small parts. Toy contains a small ball. Not for children under 3 years.
- ES ⚠️ ADVERTENCIA: RIESGO DE ASFIXIA. - Contiene piezas pequeñas. El juguete contiene una bola pequeña. No recomendado para niños menores de 3 años.
- FR ⚠️ ATTENTION: DANGER D'ÉTOUFFEMENT. - Présence de petits éléments. Le jouet contient une petite balle. Ne convient pas aux enfants de moins de 3 ans.
- DE ⚠️ ACHTUNG: ERSTICKUNGSGEFAHR. - Enthält kleine Teile. Ein kleiner Ball ist im Spielzeug inbegriffen. Nicht für Kinder unter 3 Jahren geeignet.
- NL ⚠️ WAARSCHUWING: VERSTIKKINGSGEVAAR. - Bevat kleine onderdelen. Speelgoed bevat een klein balletje. Niet geschikt voor kinderen onder de 3 jaar.
- DA ⚠️ ADVARSEL: FARE FOR KVÆLNING. - Indeholder smådele. Legetøjet indeholder en lille bold. Ikke til børn under 3 år.
- EL ⚠️ ΠΡΟΕΙΔΟΠΟΙΗΣΗ: ΚΙΝΔΥΝΟΣ ΠΝΙΓΜΟΥ. - Περιέχει μικρά αντικείμενα. Το παιχνίδι περιέχει ένα μολύβκι. Όχι για παιδιά κάτω των 3 ετών.
- FI ⚠️ VAROITUS: TUKEHTUMISVAARA. - Sisältää pieniä osia. Lelun sisältyy pieni pallo. Ei alle 3-vuotiaille lapsille.
- IT ⚠️ AVVERTENZA: PERICOLO DI SOFFOCAMENTO. - Contiene piccole parti. Il giocattolo comprende una pallina. Non indicato per bambini sotto i 3 anni.
- NO ⚠️ ADVARSEL: KVÆLNINGSFARE. - Inneholder små deler. Leketøyet inneholder en liten ball. Kun for barn over 3 år.
- PT ⚠️ ATENÇÃO: PERIGO DE ASFIXIA. - Contém peças pequenas. O brinquedo contém uma pequena bola. Não é concebido para crianças de menos de 3 anos.
- SV ⚠️ VARNING: KVÄVNINGSRISK. - Innehåller små delar. Leksaken innehåller en liten boll. Inte för barn under 3 år.
- JA ⚠️ 警告: のどにつまる危険。小さな部品が含まれています。小さな玉が含まれています。3歳以下の子供には与えないで下さい。
- ZH ⚠️ 警告: 窒息危险。包含有小部件。此玩具含有一个球。不适合3岁以下的小孩玩。
- AR ⚠️ تحذير: خطر الاختناق - قطع صغيرة. تحتوي اللعبة على كرة صغيرة. غير صالحة للأطفال أقل من 3 سنوات.

Get the free mobile app for your phone
<http://gettag.mobi>

© 2012 MICROSOFT CORPORATION. ALL RIGHTS RESERVED. MICROSOFT, 343 INDUSTRIES, THE 343 INDUSTRIES LOGO, HALO, THE HALO LOGO, XBOX, XBOX 360, AND THE XBOX LOGOS, ARE TRADEMARKS OF THE MICROSOFT GROUP OF COMPANIES.

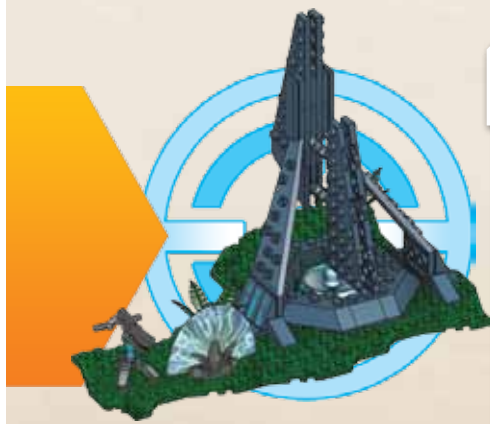

1

- 2X [Grey 1x2 Technic Plate]
- 1X [Green Fern]
- 1X [Green 1x4 Technic Plate]
- 2X [Grey 1x2 Technic Plate]
- 1X [Green 1x4 Technic Plate]
- 1X [Green 1x2 Technic Plate]



2

- 2X [Grey 1x2 Technic Plate]
- 1X [Grey 1x2 Technic Plate]
- 2X [Grey 1x2 Technic Plate]
- 1X [Blue and Silver Fan]

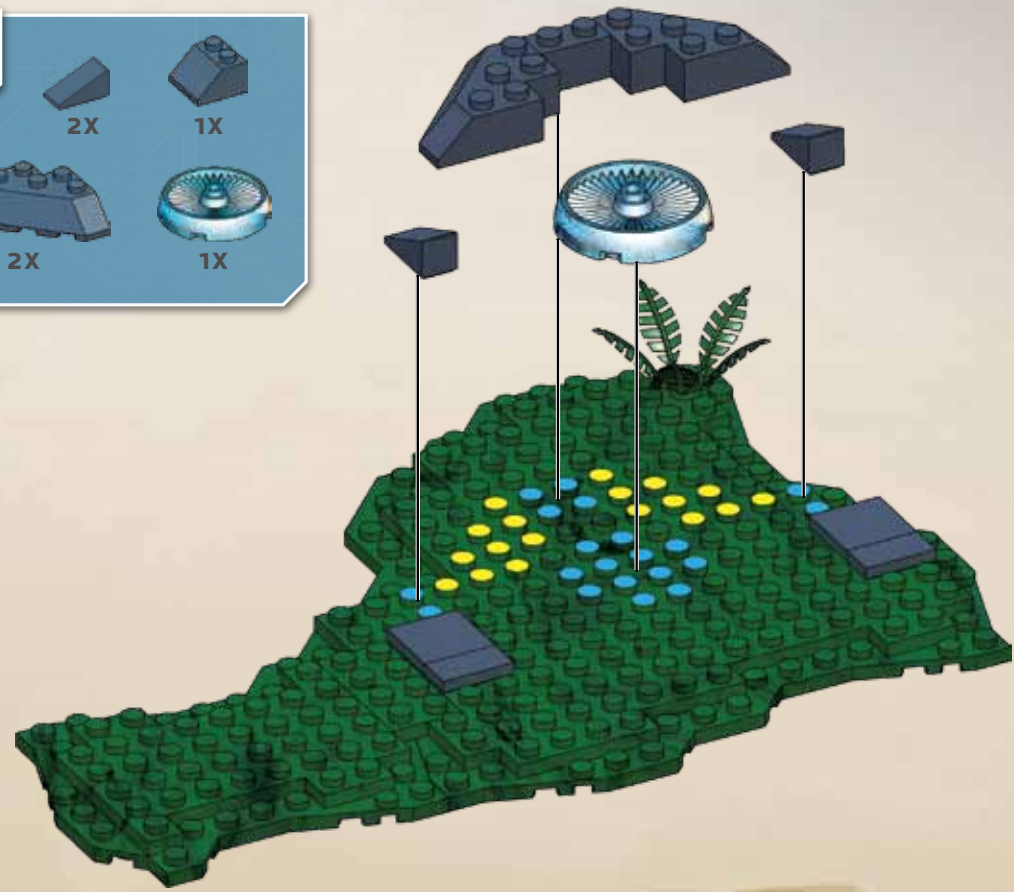

3

- 2X [Grey 1x2 Technic Plate]
- 3X [Grey 1x2 Technic Plate]
- 2X [Grey 1x2 Technic Plate]



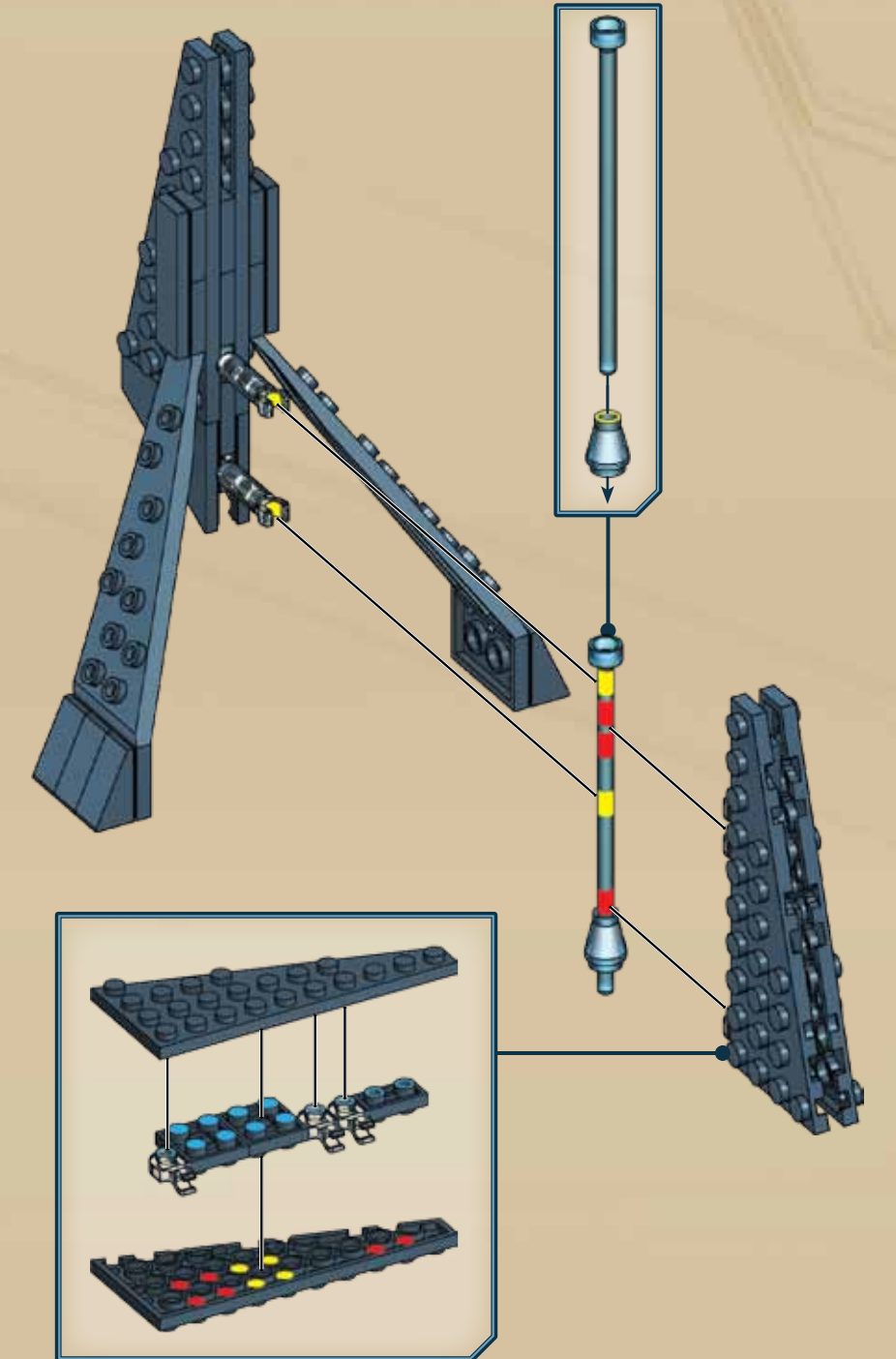
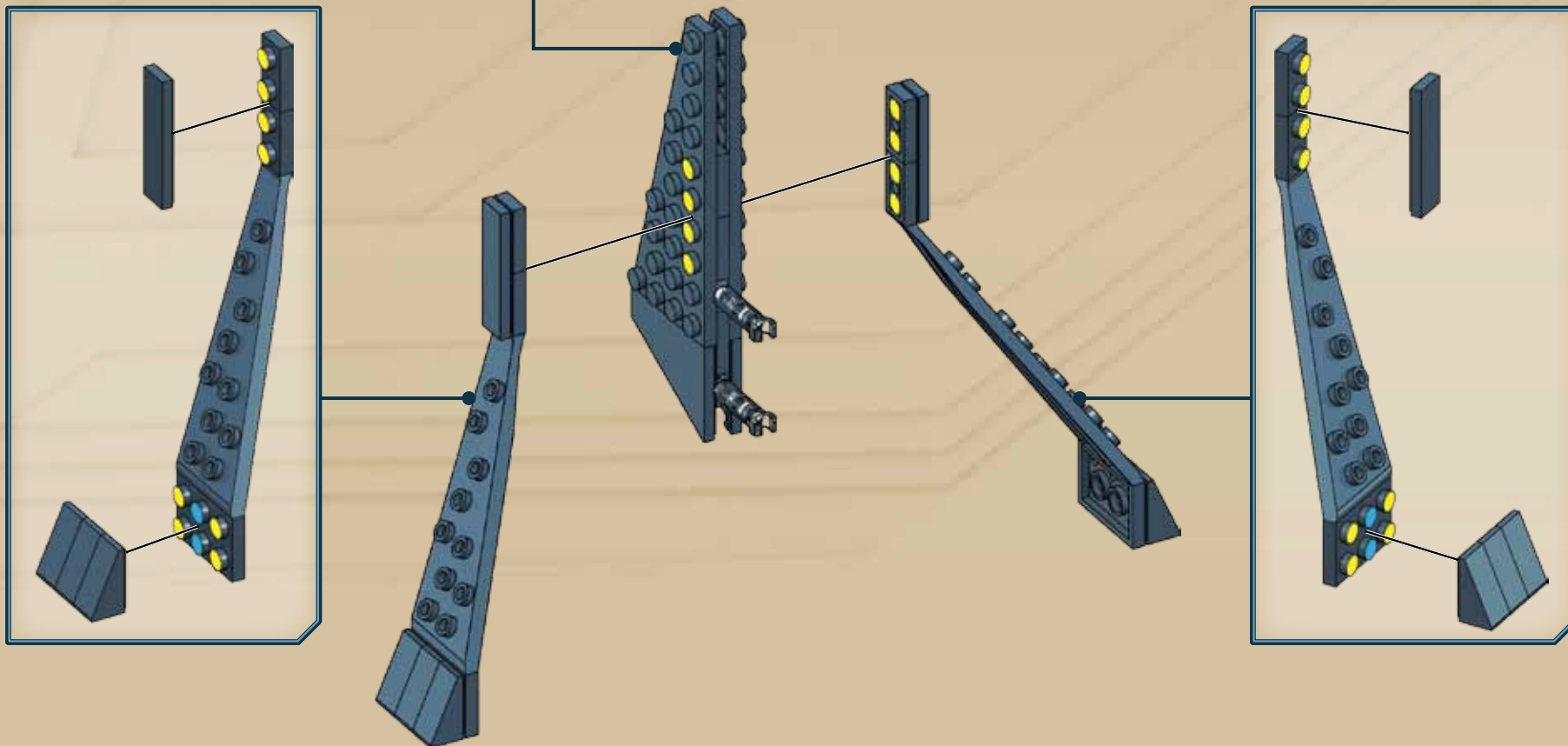
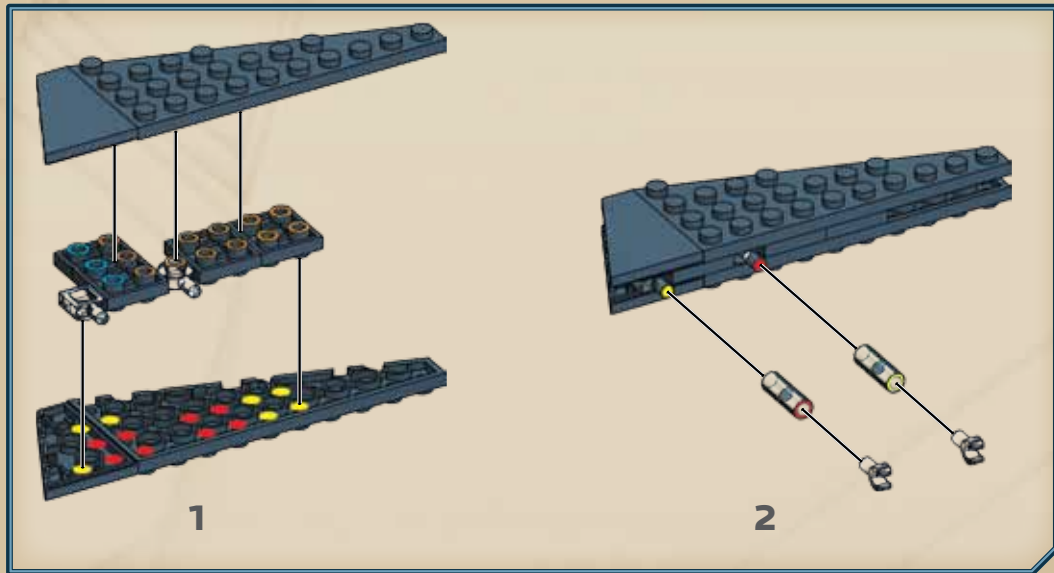
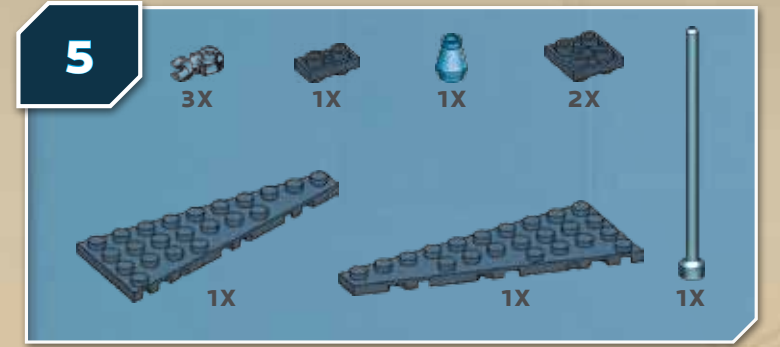
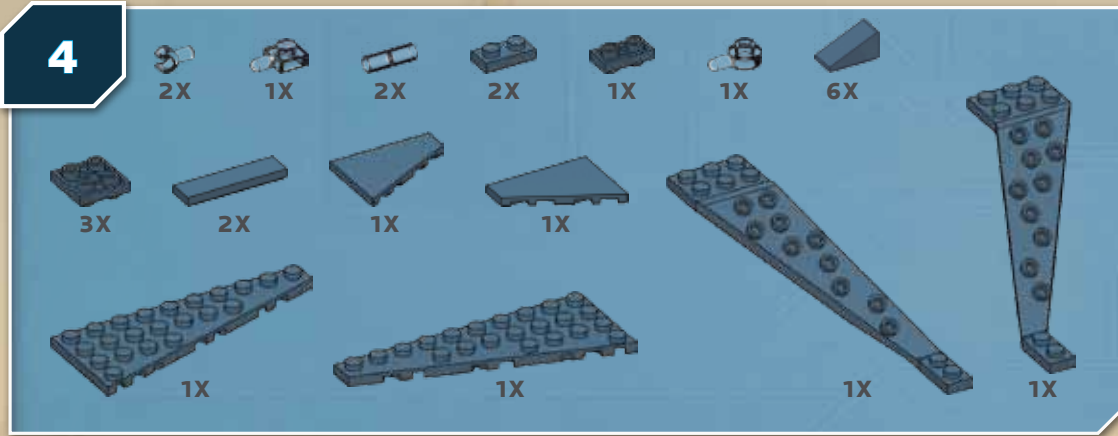

6

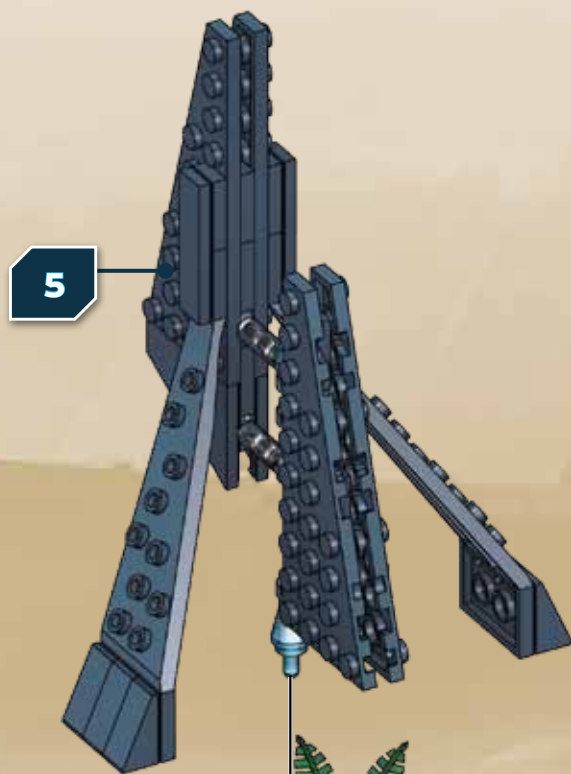

3



7



1

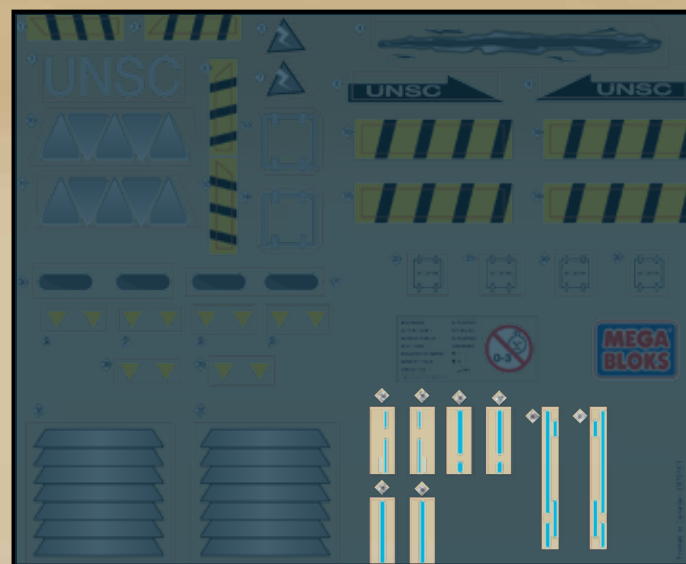

34 35 36 37
38 39 40 41

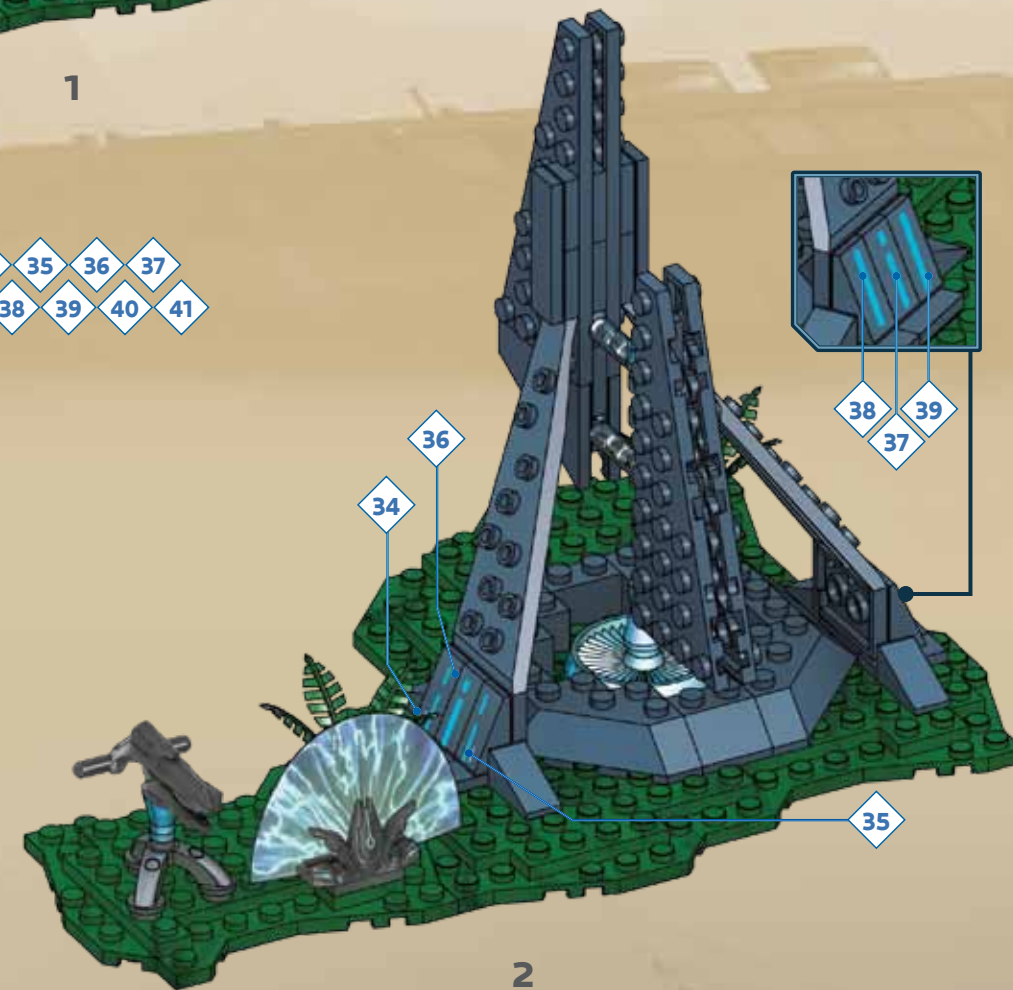

2



1

3X 1X 1X

1X

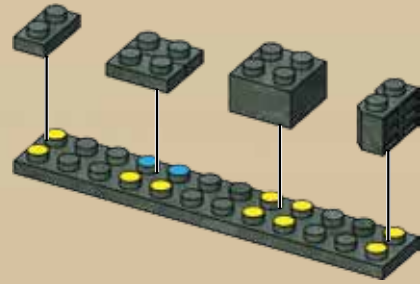

2

1X 1X 3X

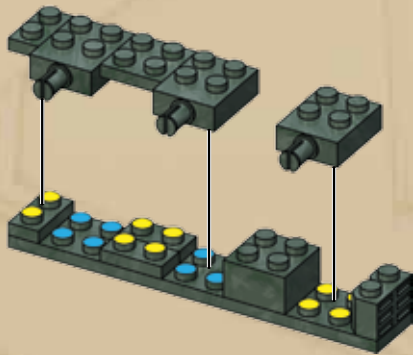

3

1X 1X

1X 1X

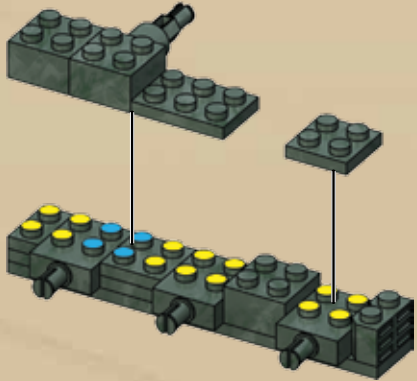

4

2X 1X

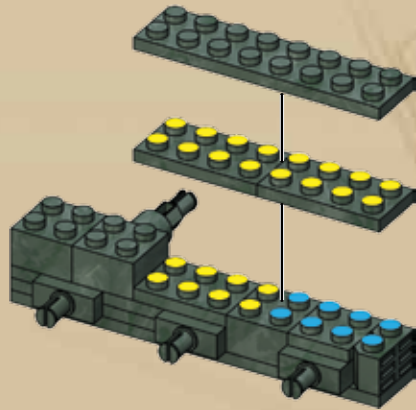

5

2X

1X

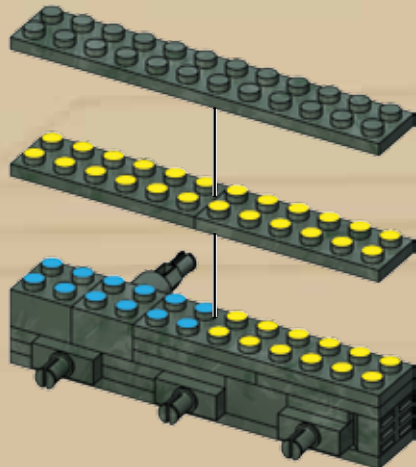

6

3X

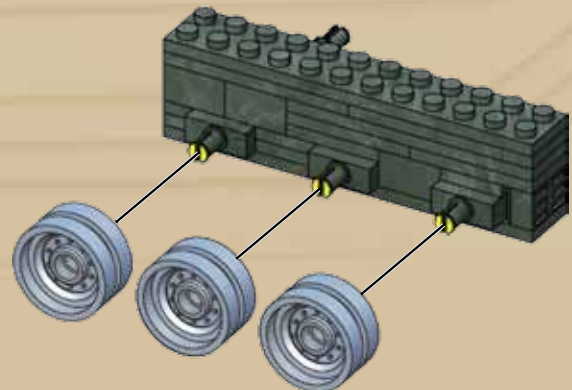

7

1X

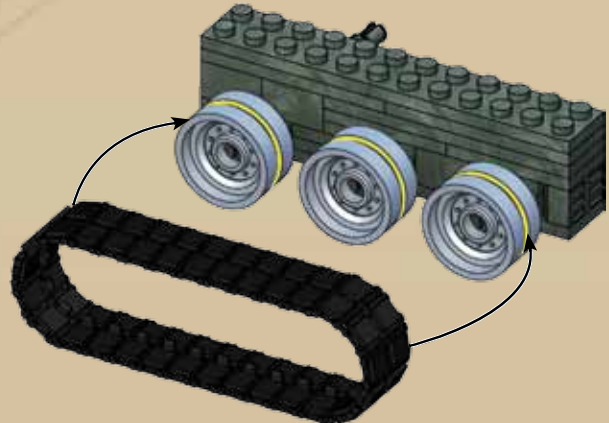

8

1X

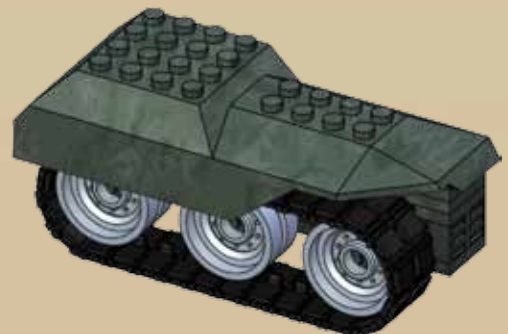
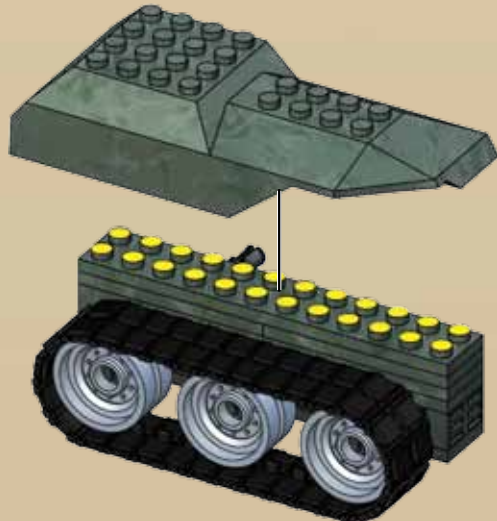

1

2

9

- 4X [Pin]
- 2X [Technic Axle]
- 4X [Technic Pin]
- 4X [Technic Pin]
- 6X [Technic Pin]
- 4X [Technic Pin]
- 2X [Technic Pin]
- 1X [Technic Axle]
- 1X [Technic Beam]
- 1X [Technic Plate]

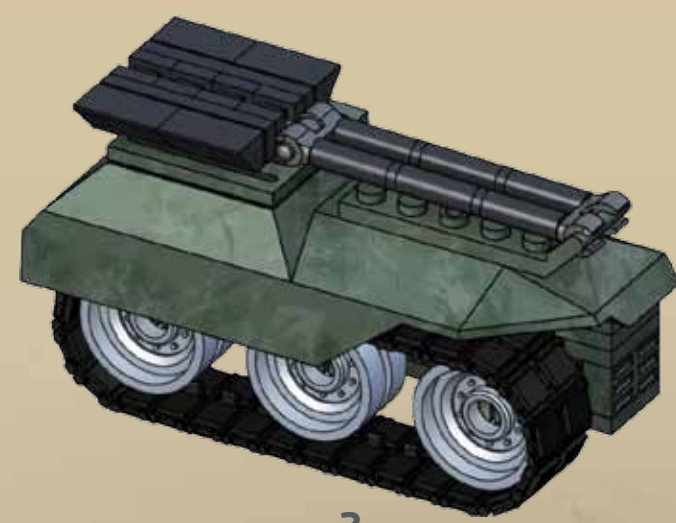
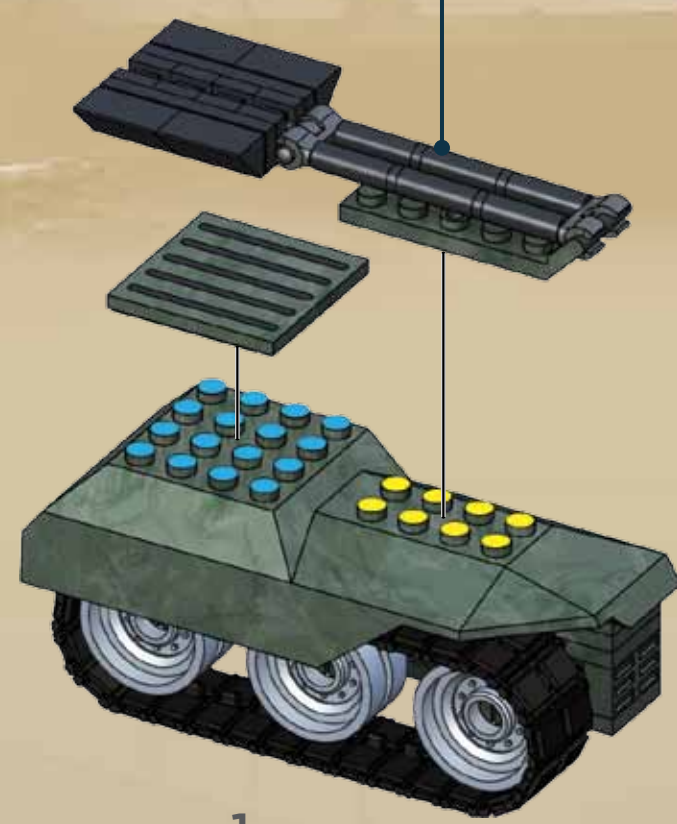
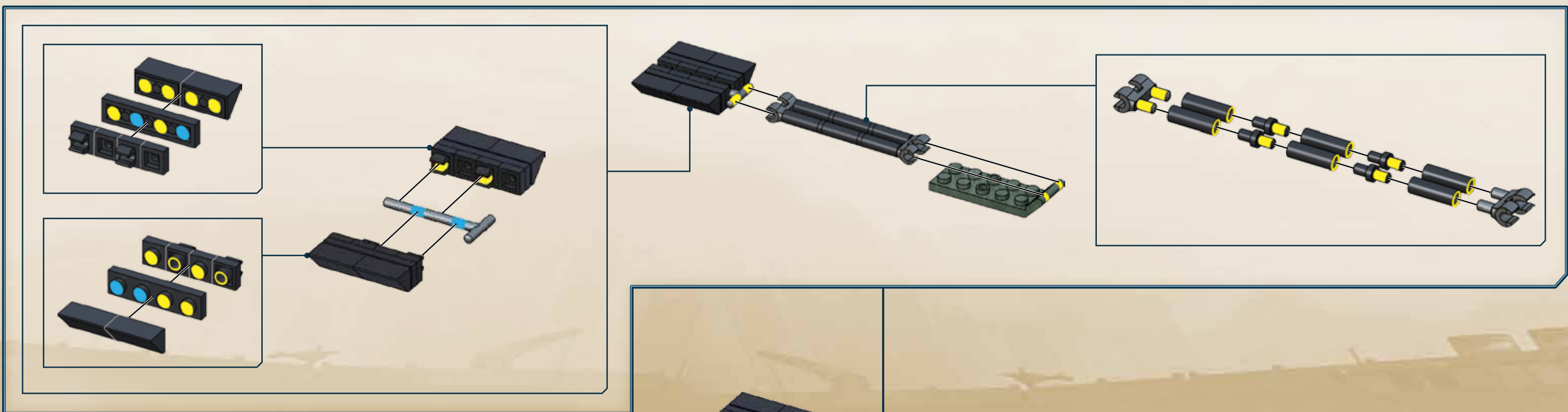



10

3X 1X 1X

1X

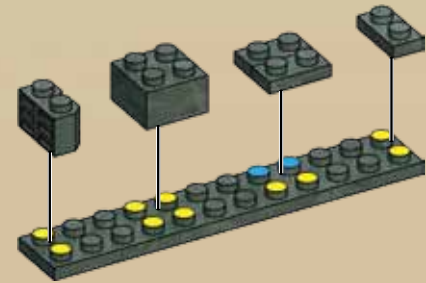

11

1X 1X 3X

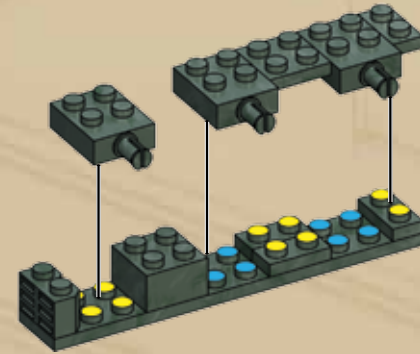

12

1X 1X

1X 1X

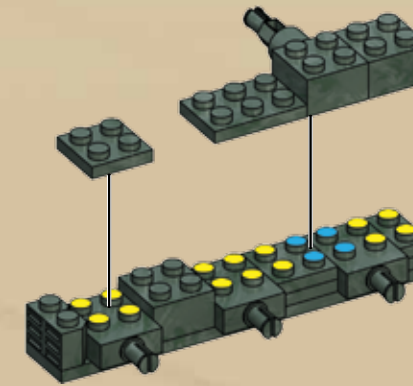

13

2X

1X

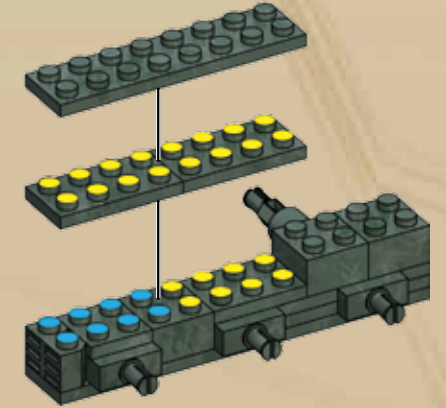

14

2X

1X

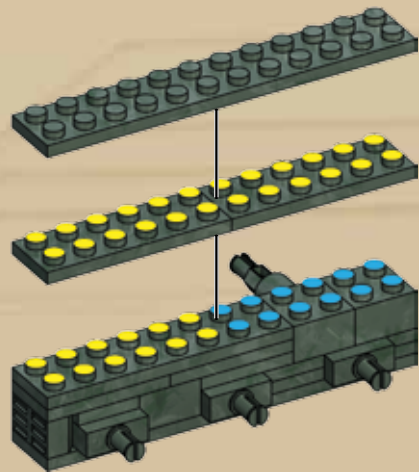

15

3X

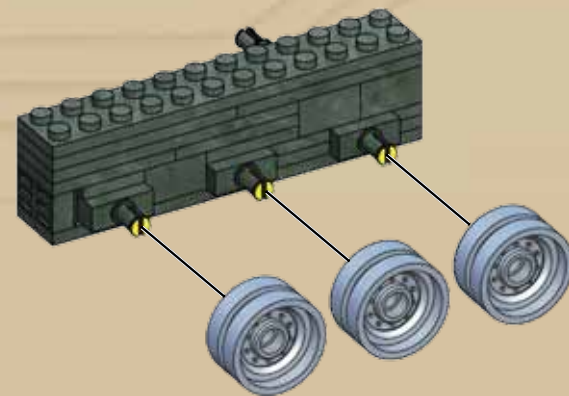

16

1X

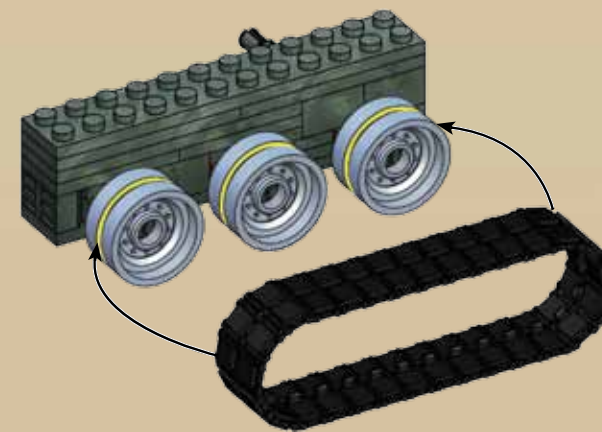

17

1X



18

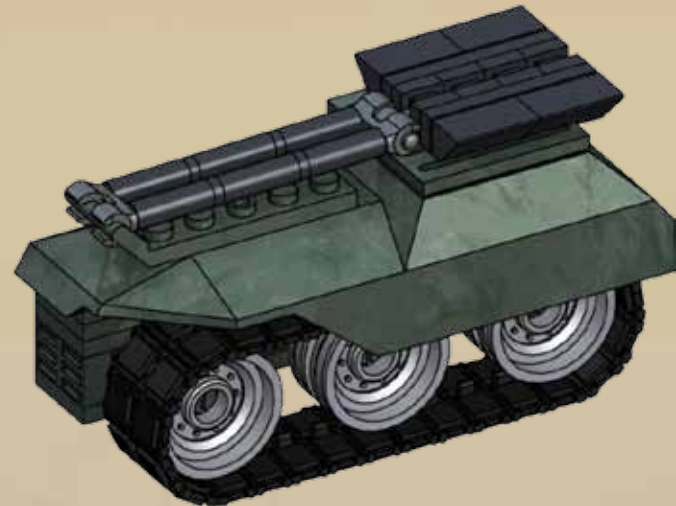
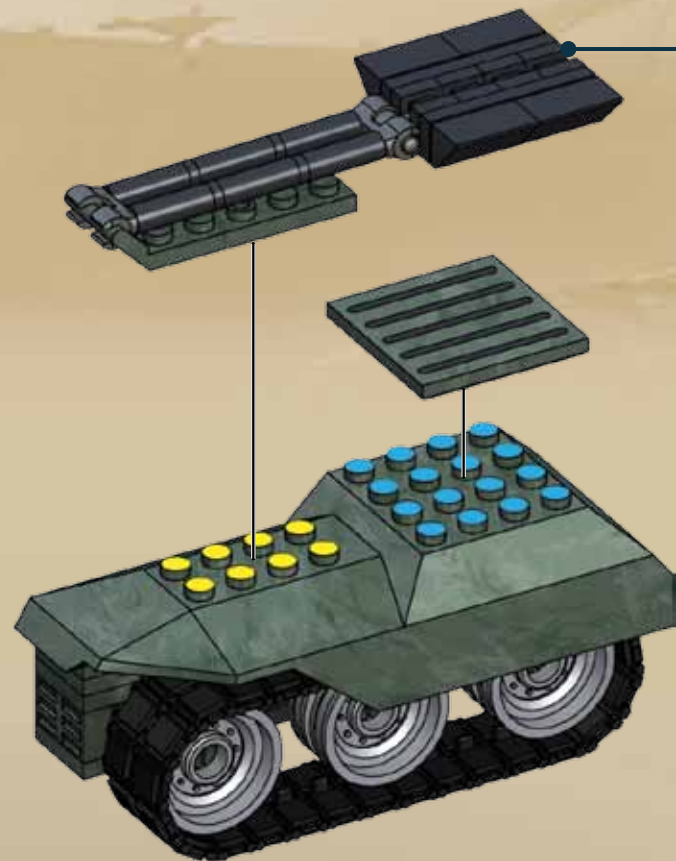
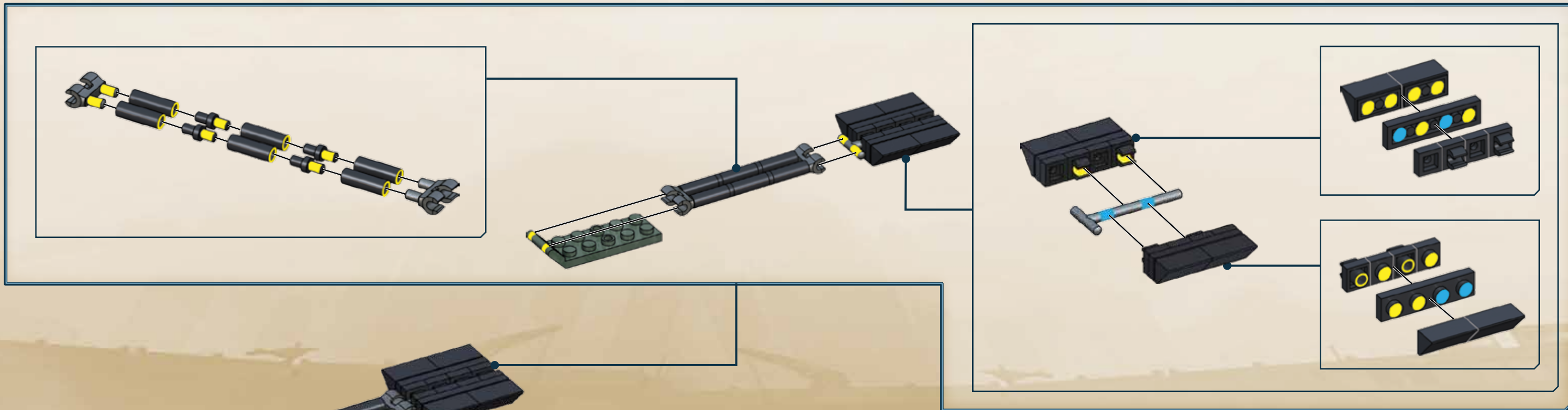



19

3X 1X 1X

1X

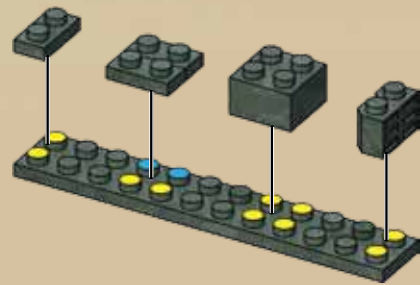

20

1X 1X 3X

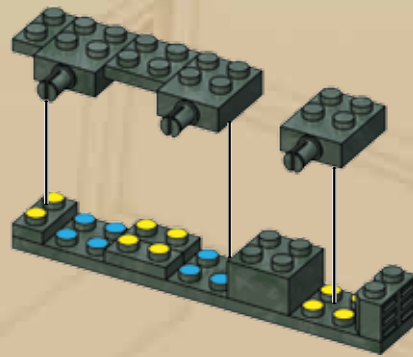

21

1X 1X

1X 1X

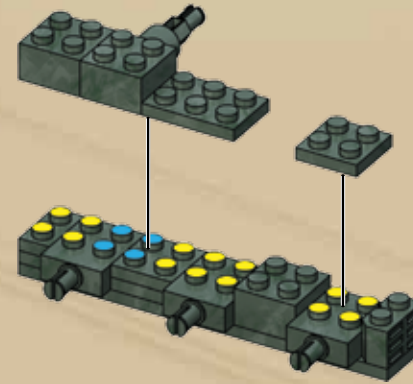

22

2X

1X

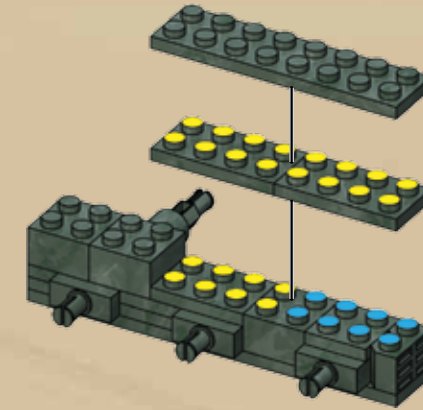

23

2X

1X

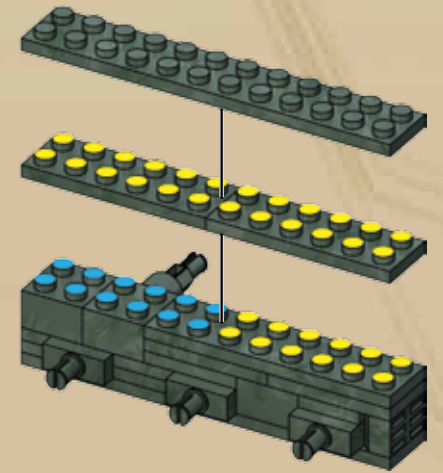

24

3X

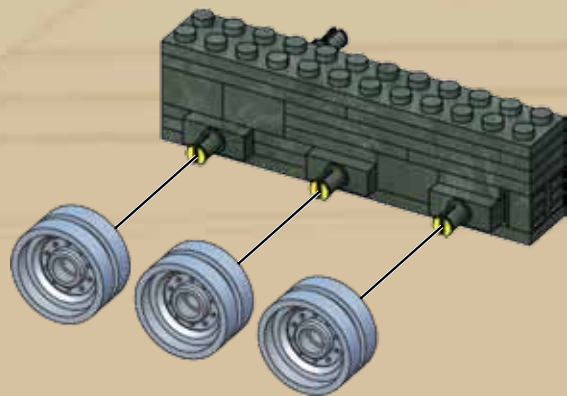

25

1X

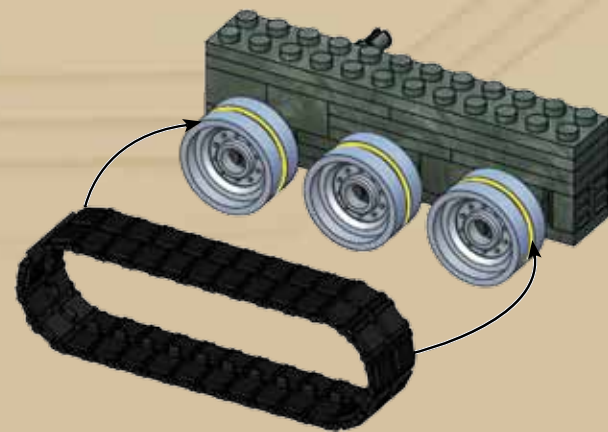

26

1X

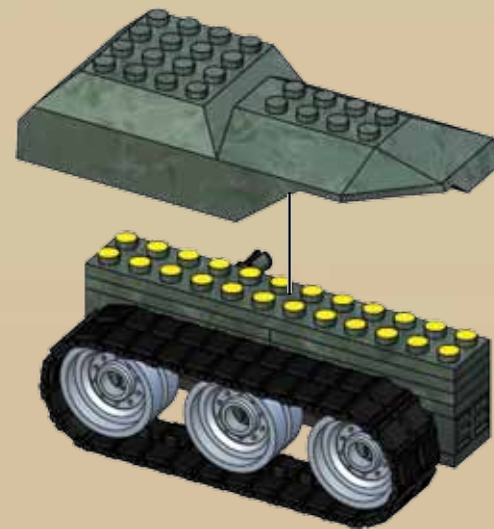

27

1X

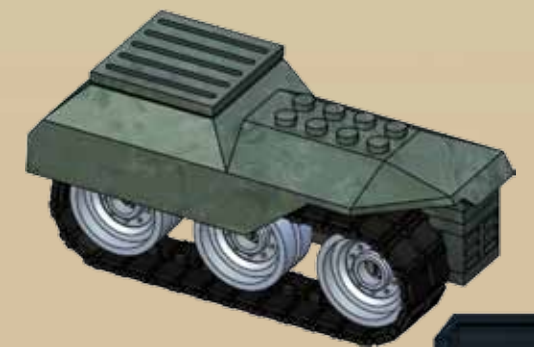
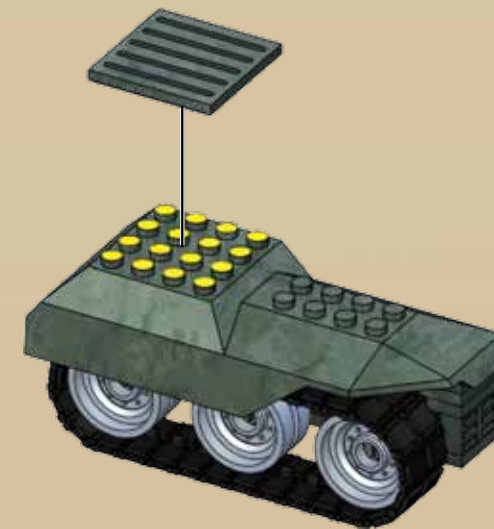



28

3X 1X 1X

1X

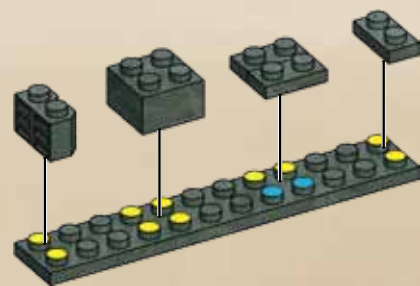

29

1X 1X 3X

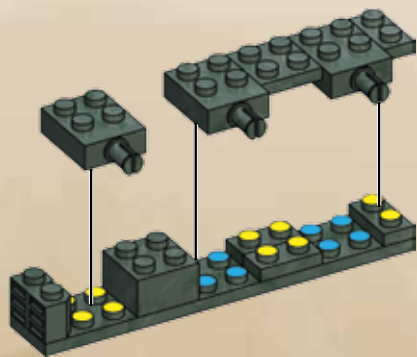

30

1X 1X

1X 1X

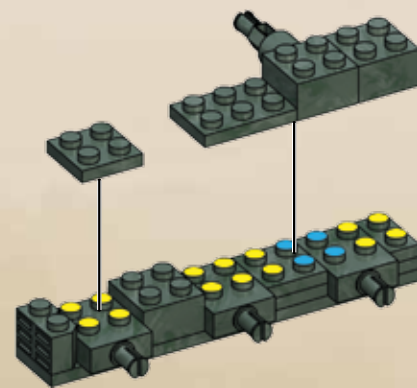

31

2X

1X

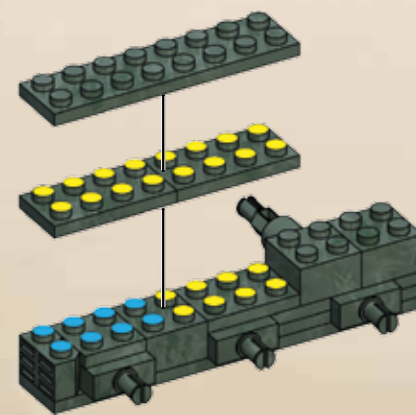

32

2X

1X

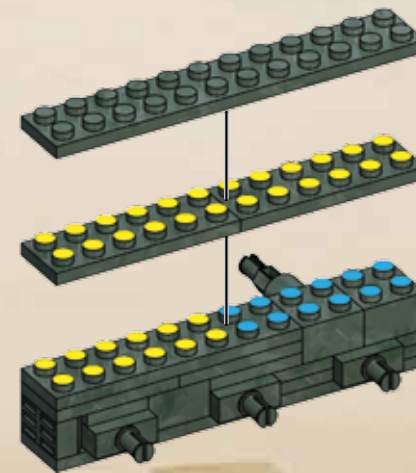

33

3X

34

1X

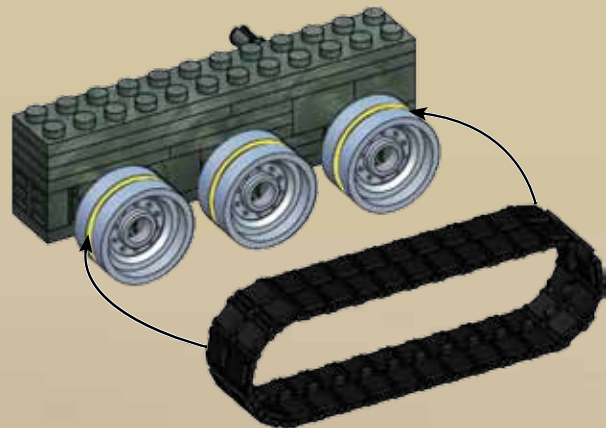

35

1X

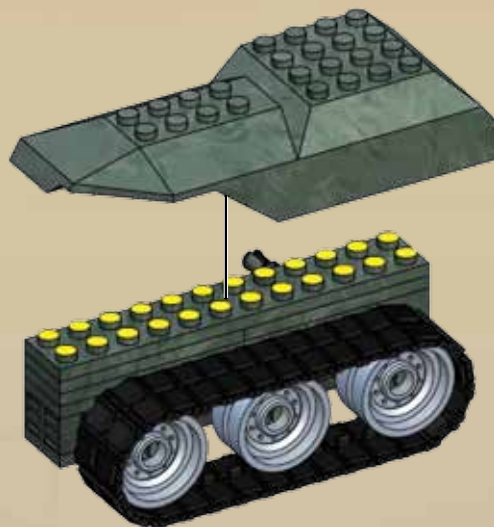

36

1X

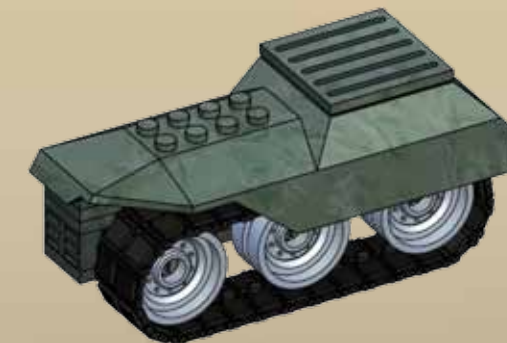
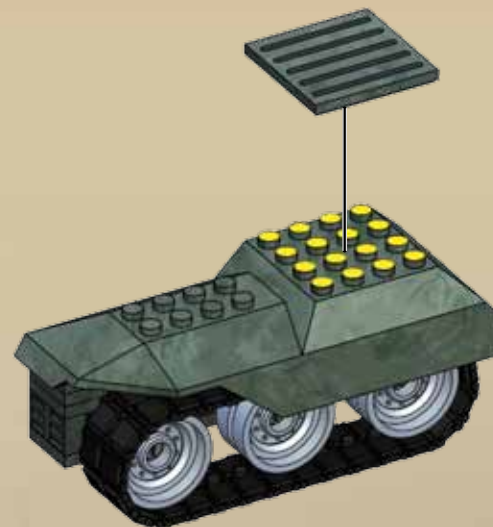



37

3X 1X 1X

1X

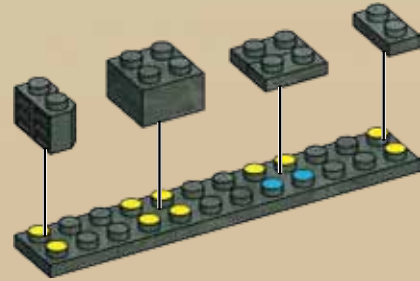

38

1X 1X 3X

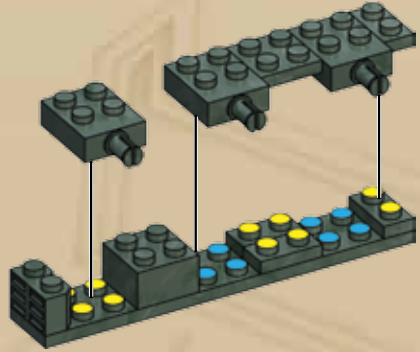

39

1X 1X

1X 1X

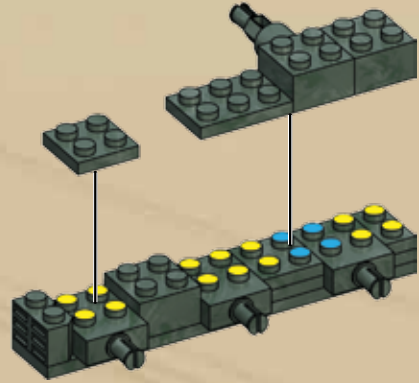

40

2X

1X

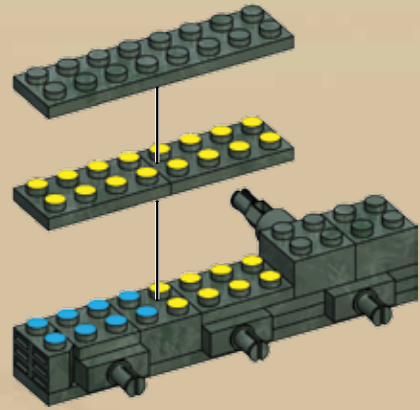

41

2X

1X

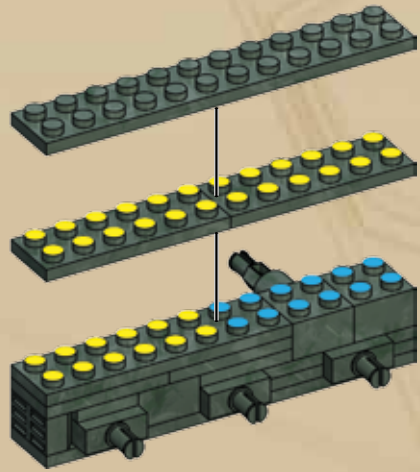

42

3X

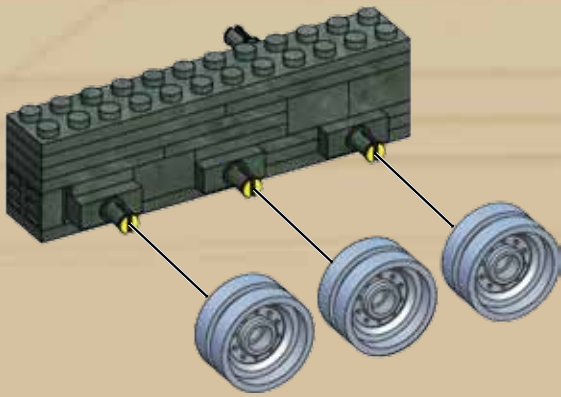

43

1X

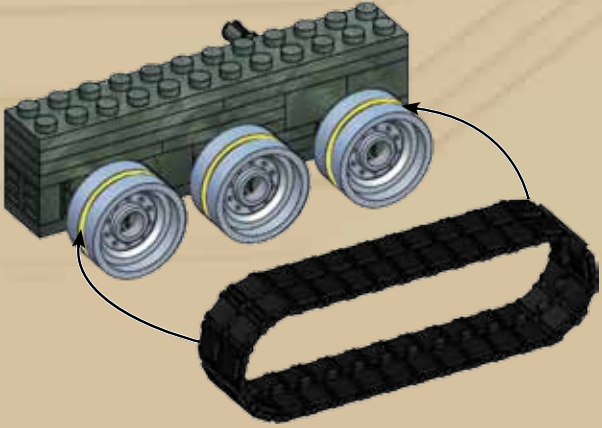

44

1X

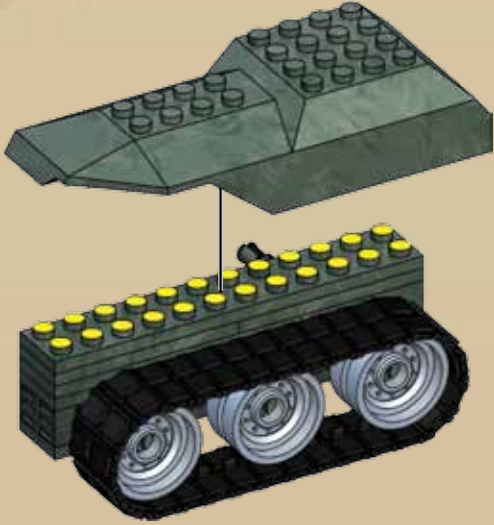

45

1X

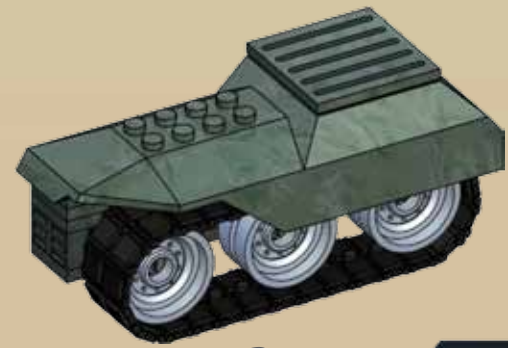
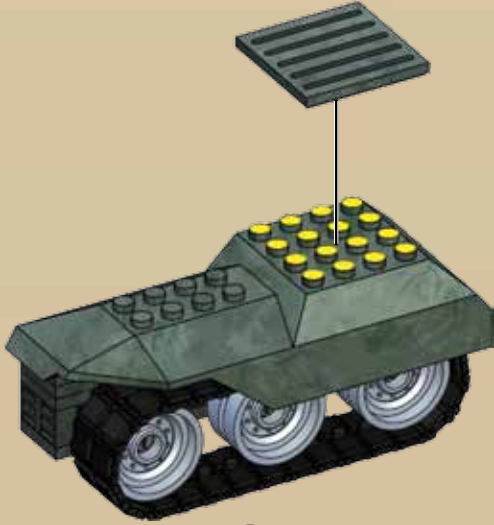

1

2



46

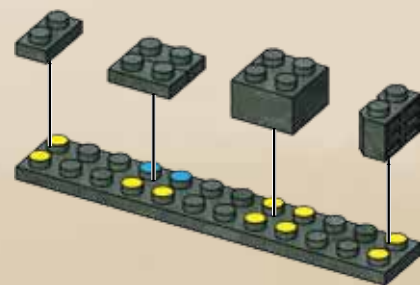
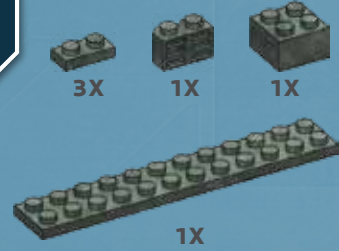

47

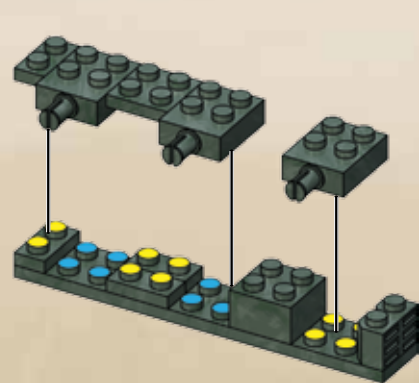

48

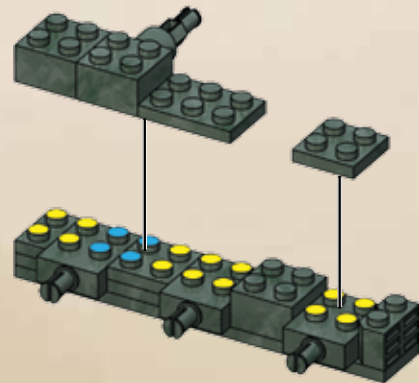

49

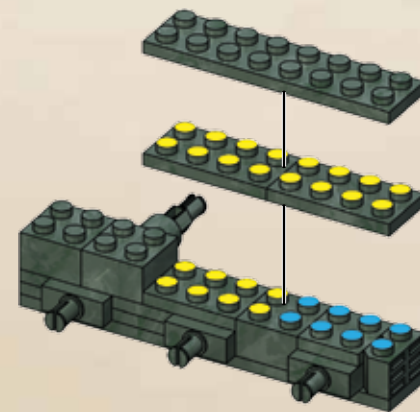

50

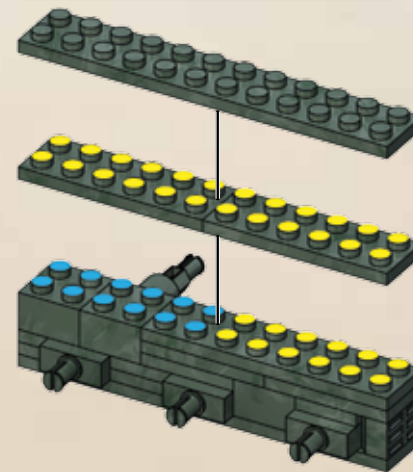

51

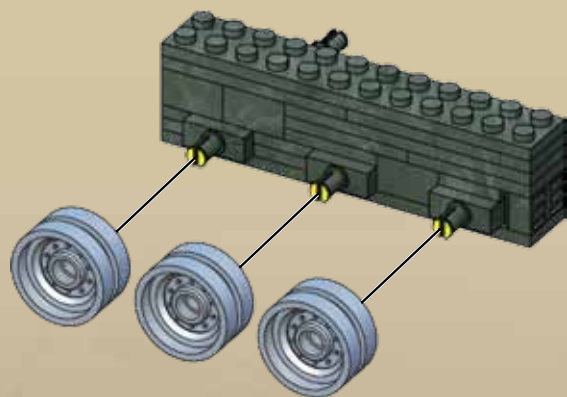

52

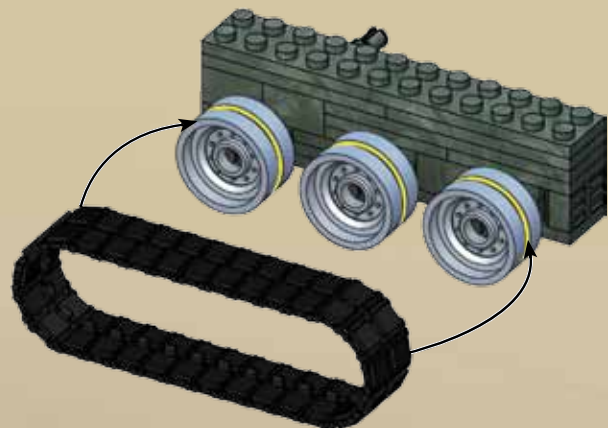

53

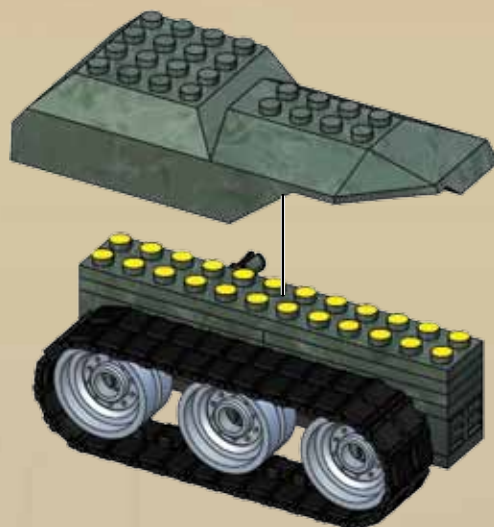
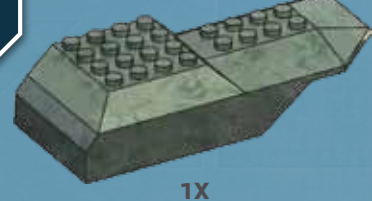

54

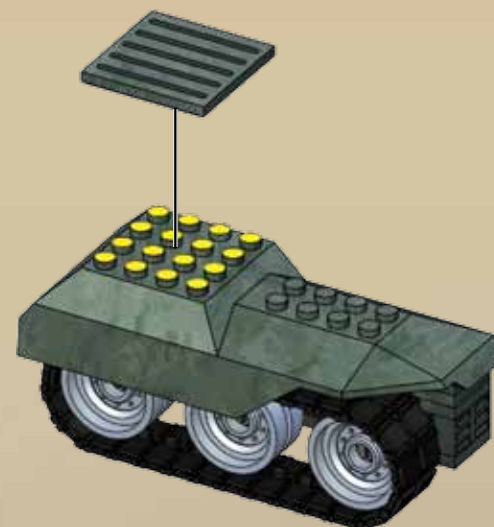
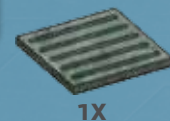

1

2



55

2X 2X 1X

1X 1X

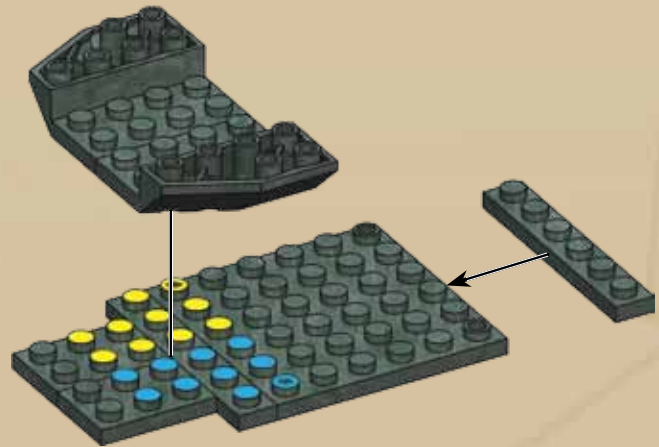

56

2X 4X

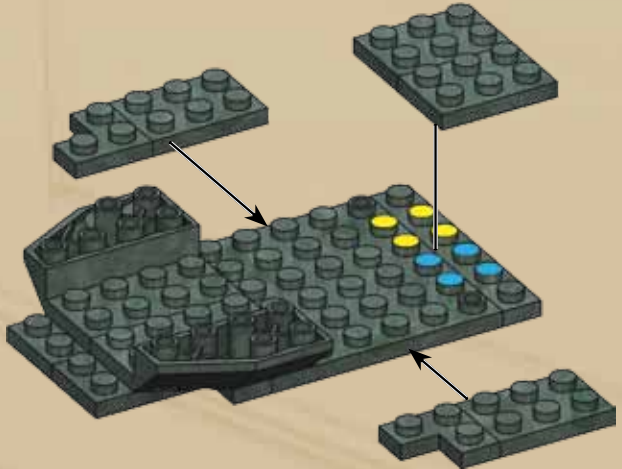

57

2X 2X

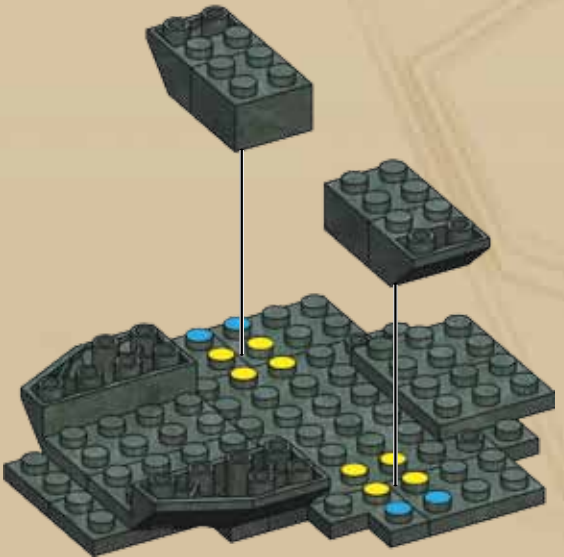

58

2X 1X 1X

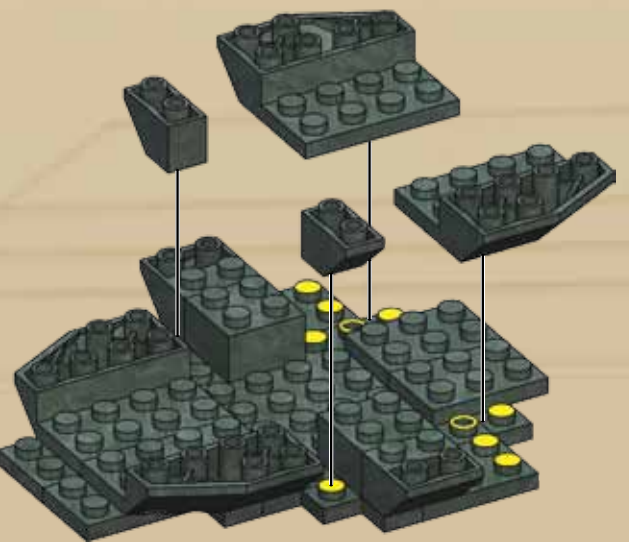

59

2X 1X 1X

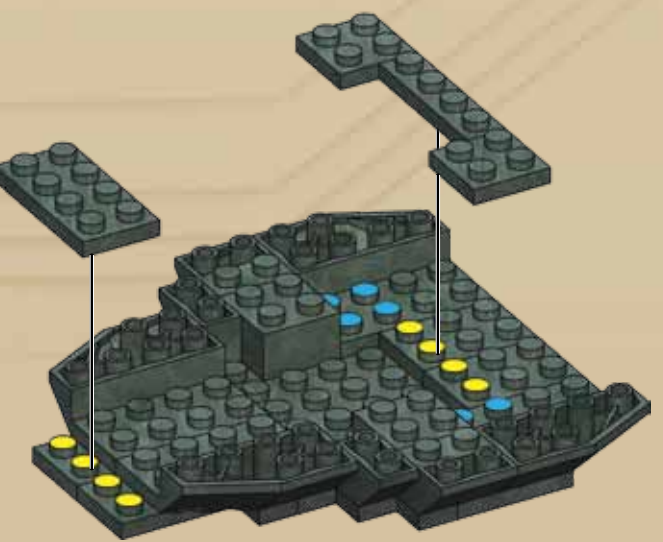

60

2X 5X 2X 2X

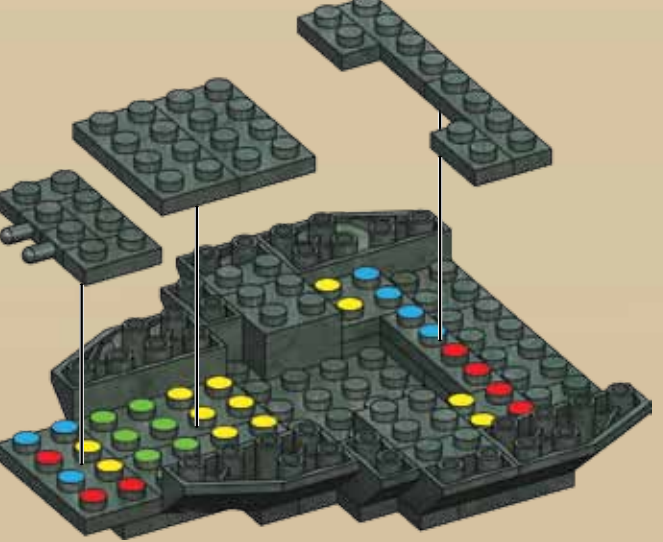

61

2X 1X

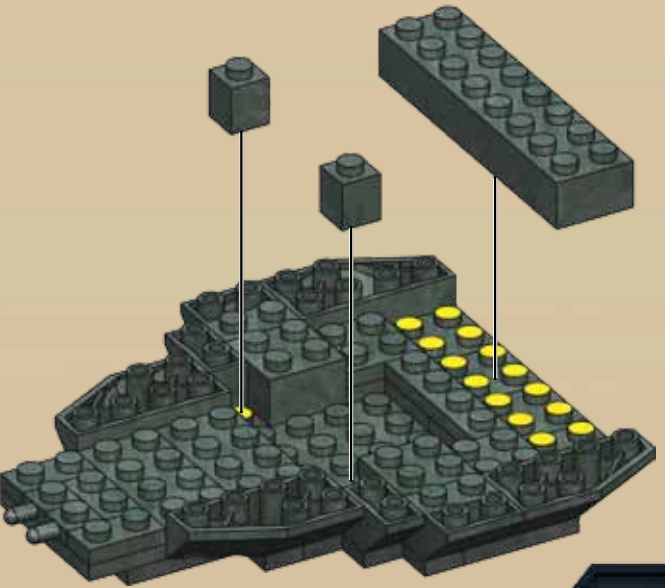

62

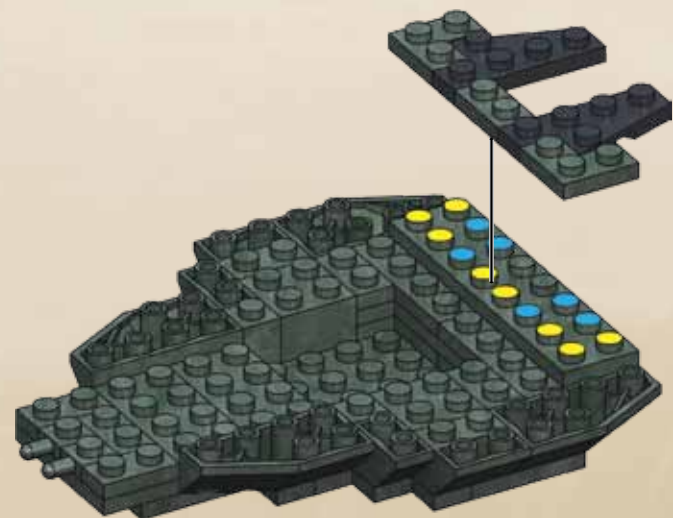

63



64

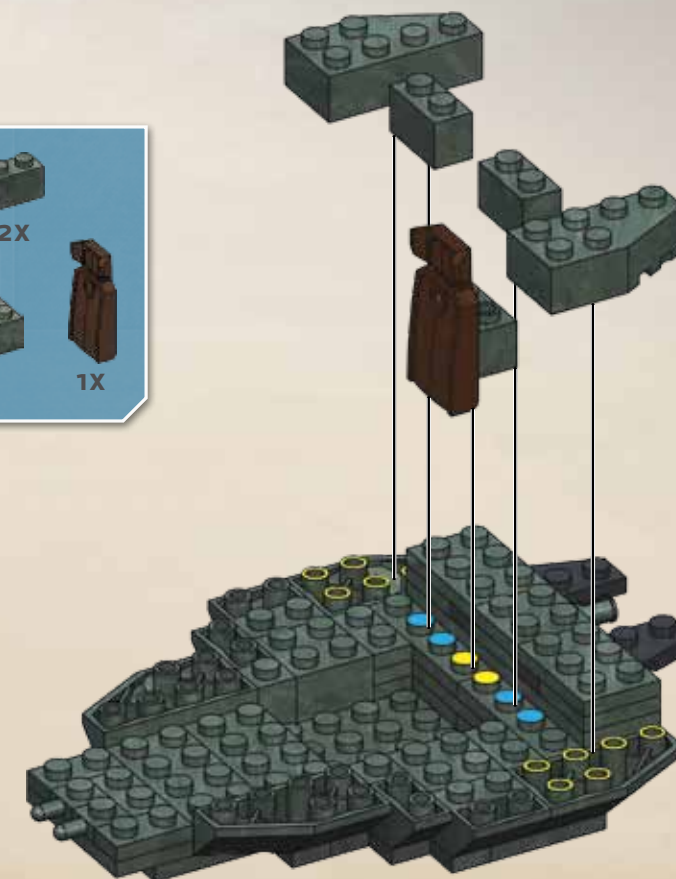
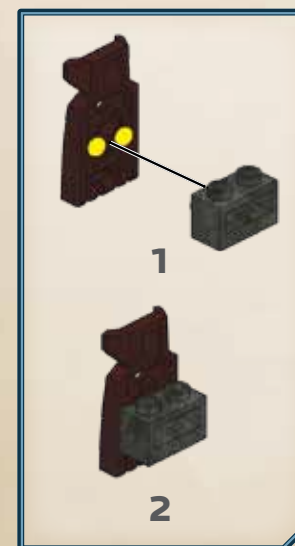

65

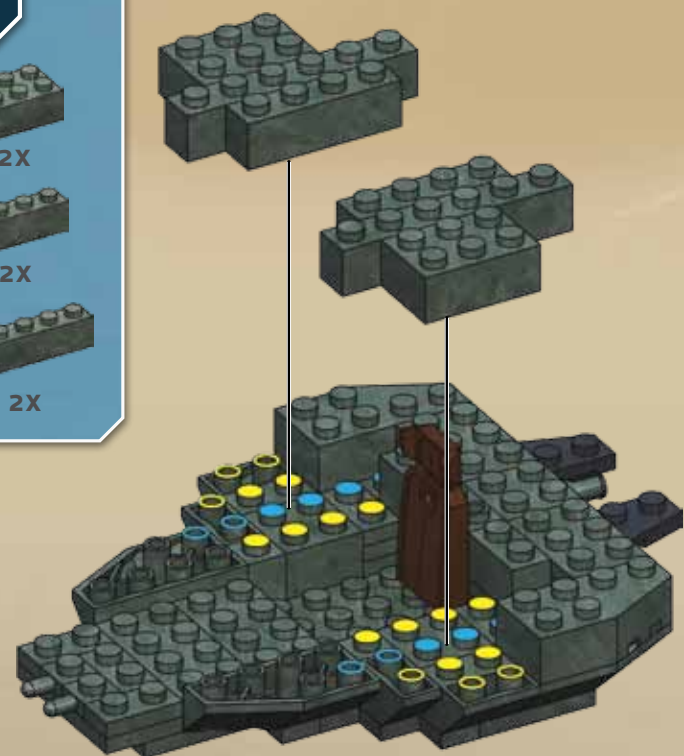
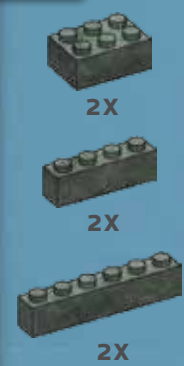

66



67



- 68**
- 2X [1x1 grey brick]
 - 2X [1x2 grey brick]
 - 1X [1x1 grey brick]
 - 1X [1x2 grey brick]
 - 1X [1x3 grey brick]
 - 2X [1x1 grey brick]
 - 2X [1x2 grey brick]
 - 2X [1x3 grey brick]

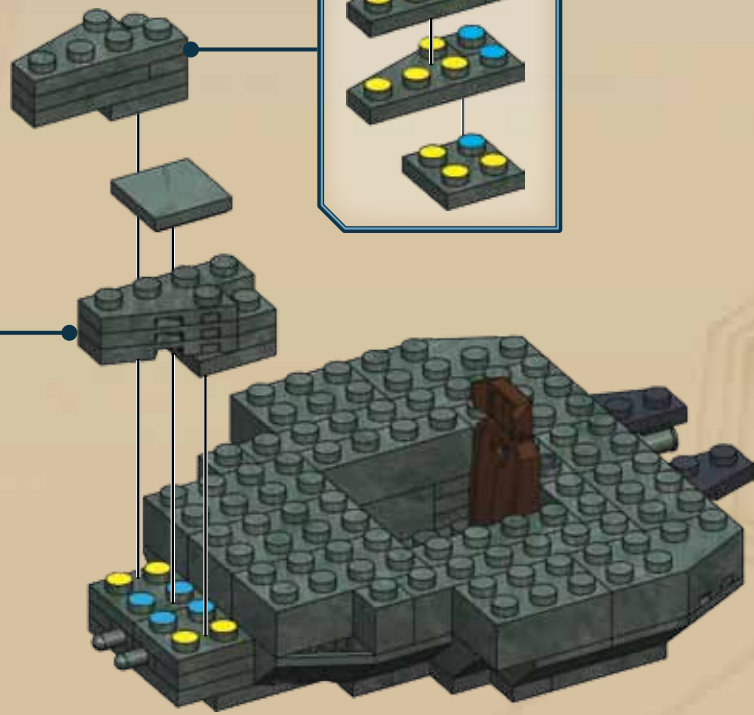
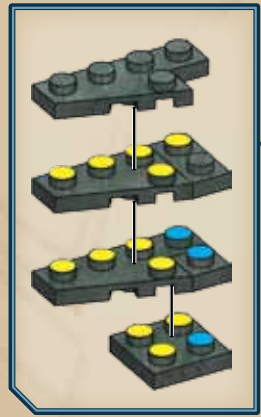

- 69**
- 2X [1x1 grey brick]
 - 2X [1x2 grey brick]
 - 2X [1x3 grey brick]



- 70**
- 2X [1x1 grey brick]
 - 5X [1x2 grey brick]

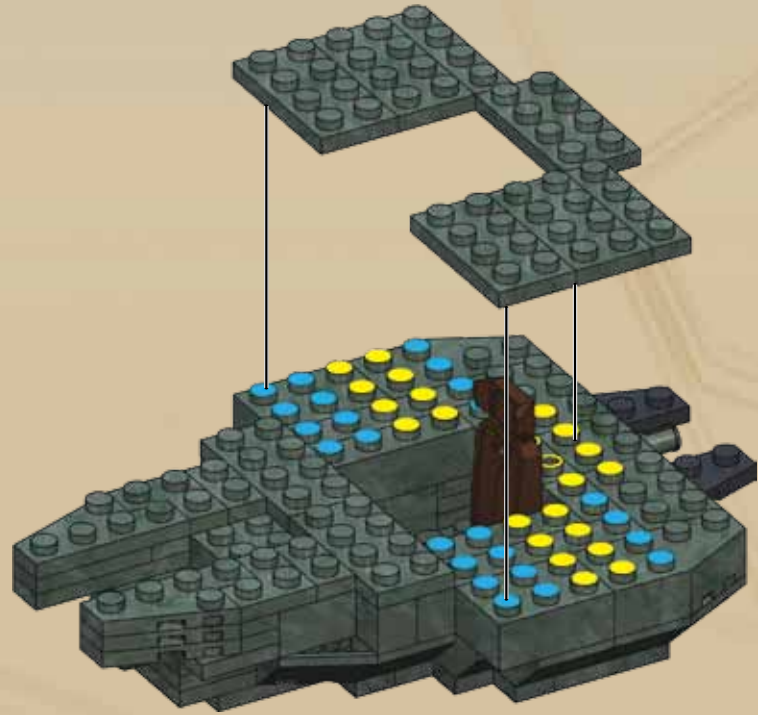

- 71**
- 2X [1x1 grey brick]
 - 1X [1x2 grey brick]
 - 1X [1x3 grey brick]
 - 2X [1x4 grey brick]

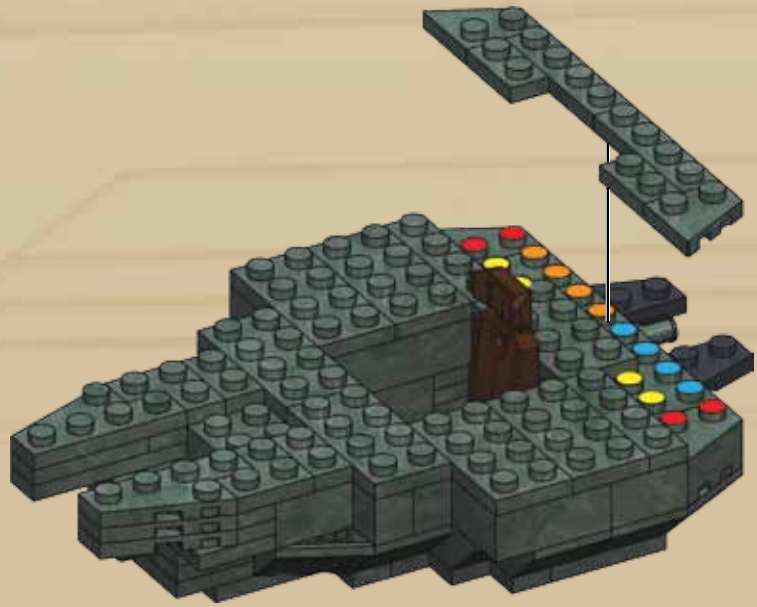

- 72**
- 1X [1x1 grey brick]
 - 1X [1x2 grey brick]
 - 2X [1x3 grey brick]

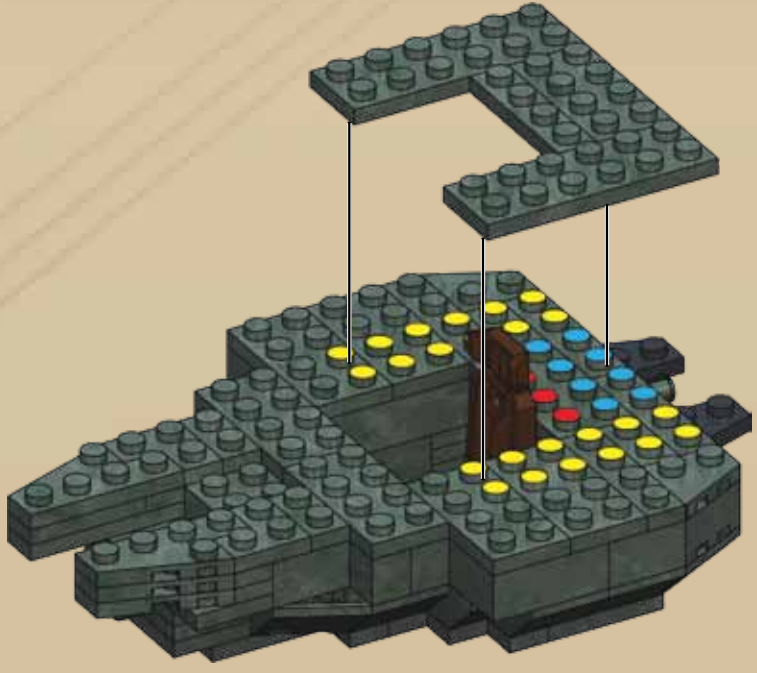

- 73**
- 1X [1x1 grey brick]
 - 1X [1x2 grey brick]
 - 2X [1x3 grey brick]



74

- 1X
- 1X
- 2X
- 2X

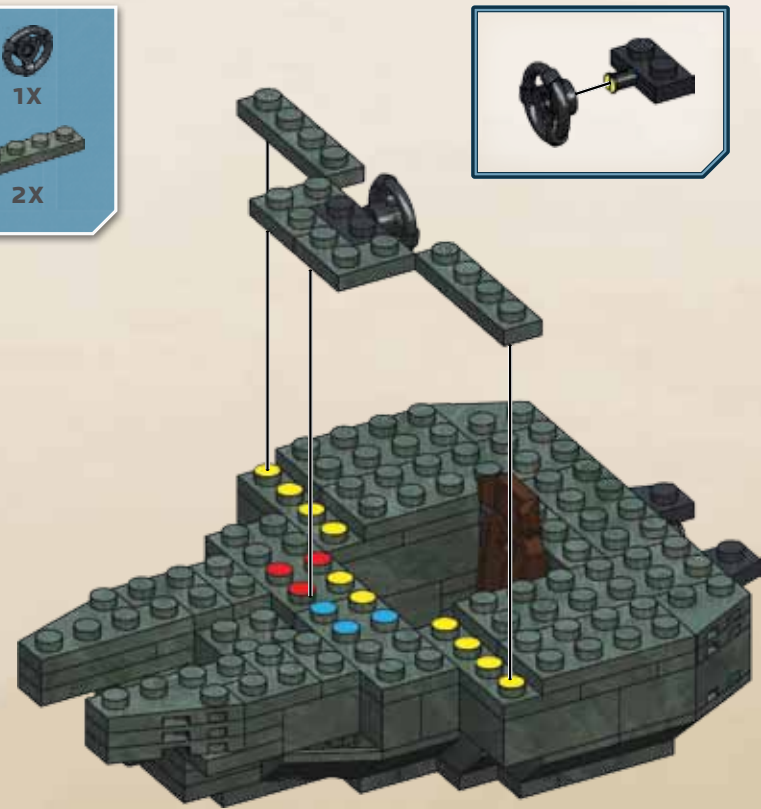

75

- 4X
- 4X
- 2X
- 2X

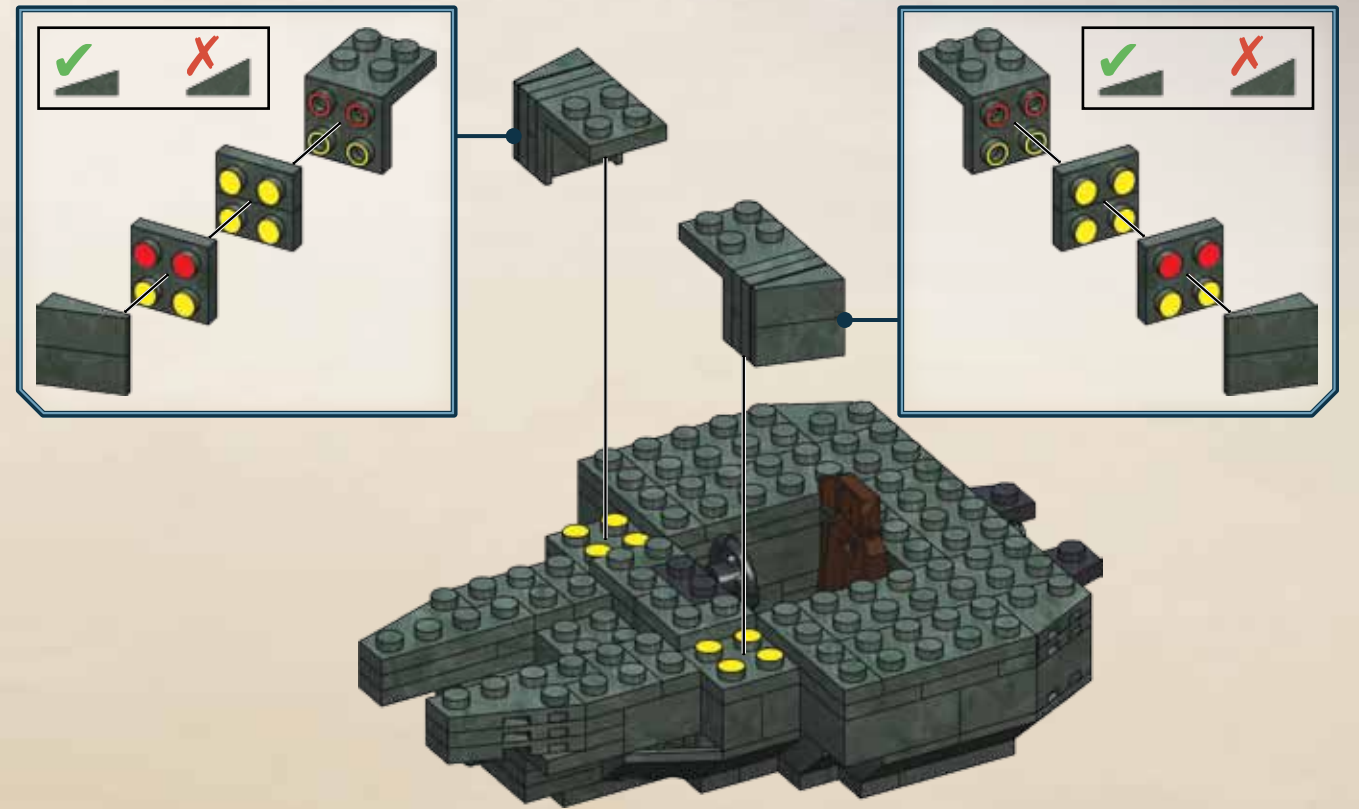

76

- 4X
- 2X
- 4X
- 4X

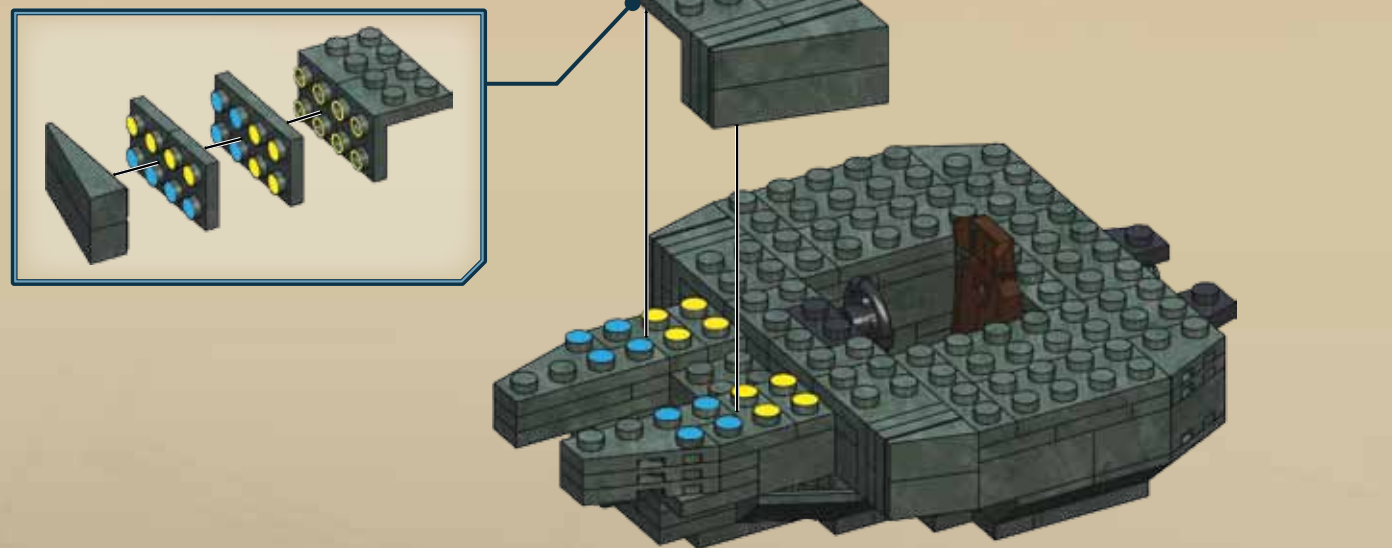

77

- 1X

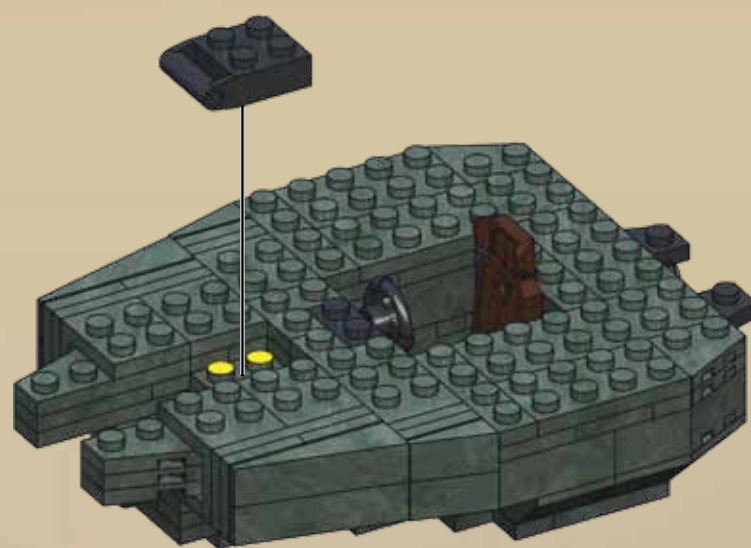

78

- 2X
- 2X
- 2X

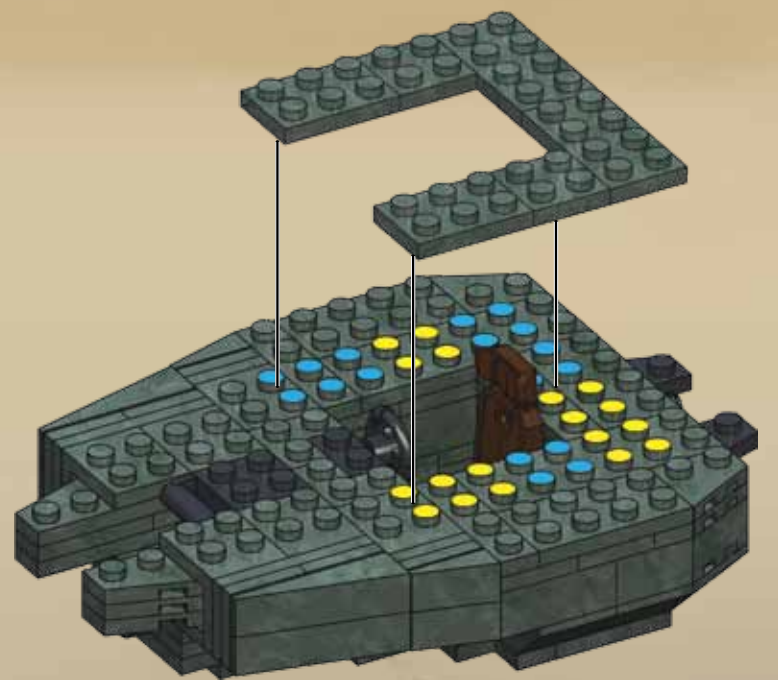

79

2X 2X 1X 2X



80

1X 2X 1X 1X

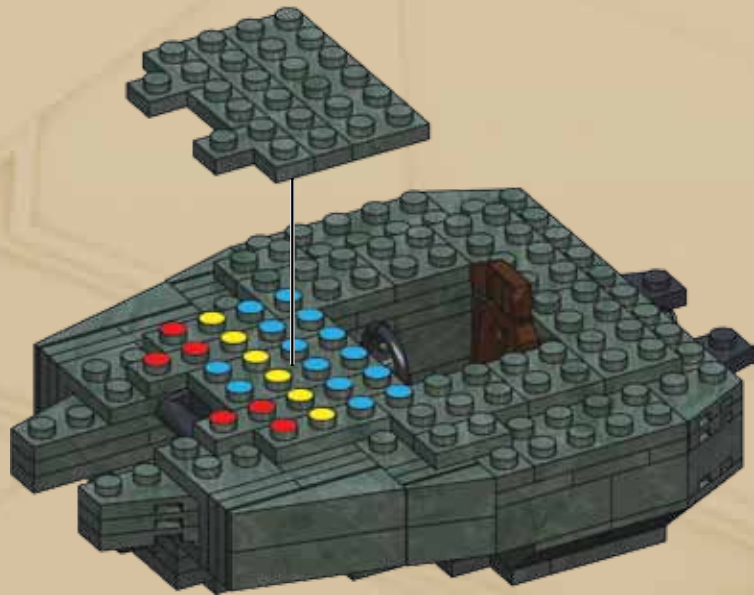

81

2X 2X 3X

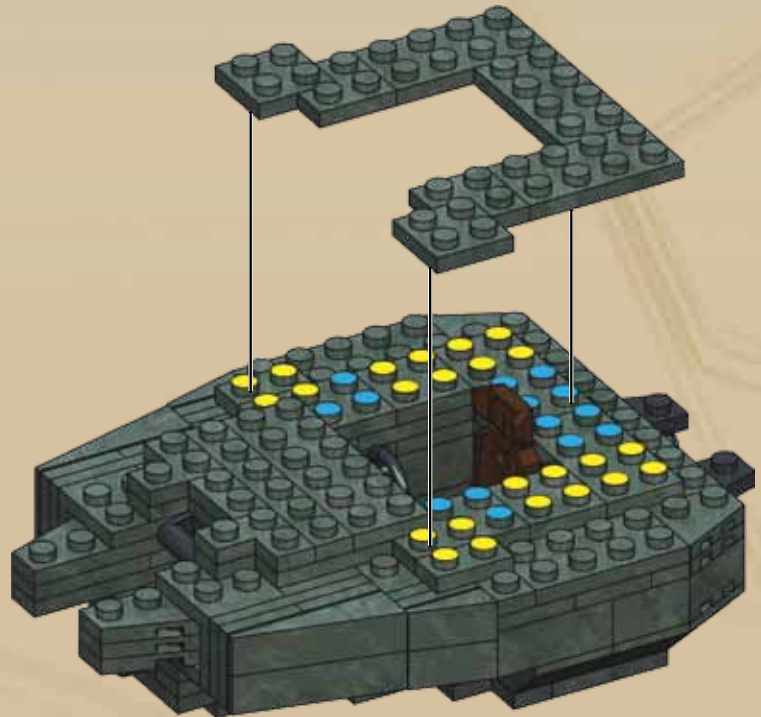

82

1X 1X 1X 1X



83

2X 2X 2X 1X

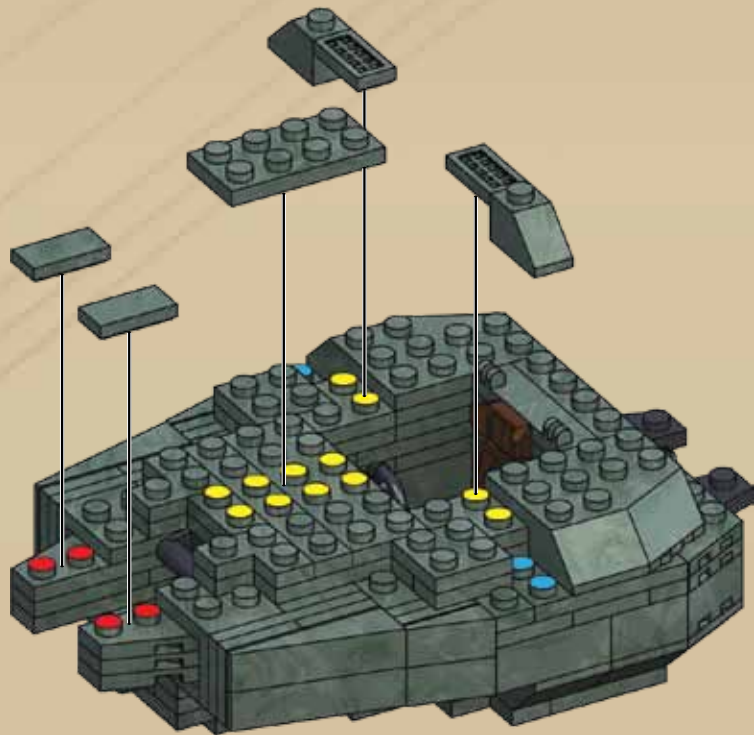

84

1X 1X



85

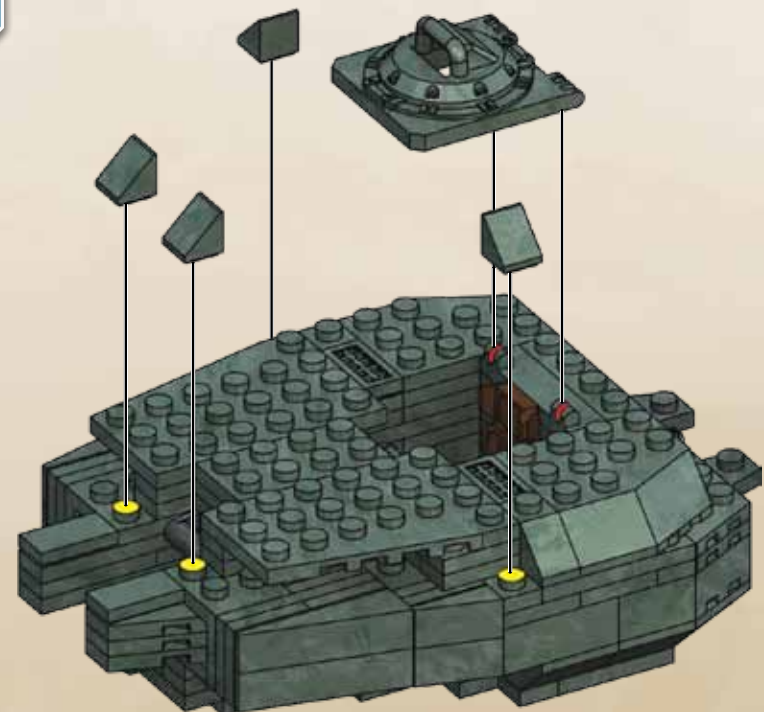



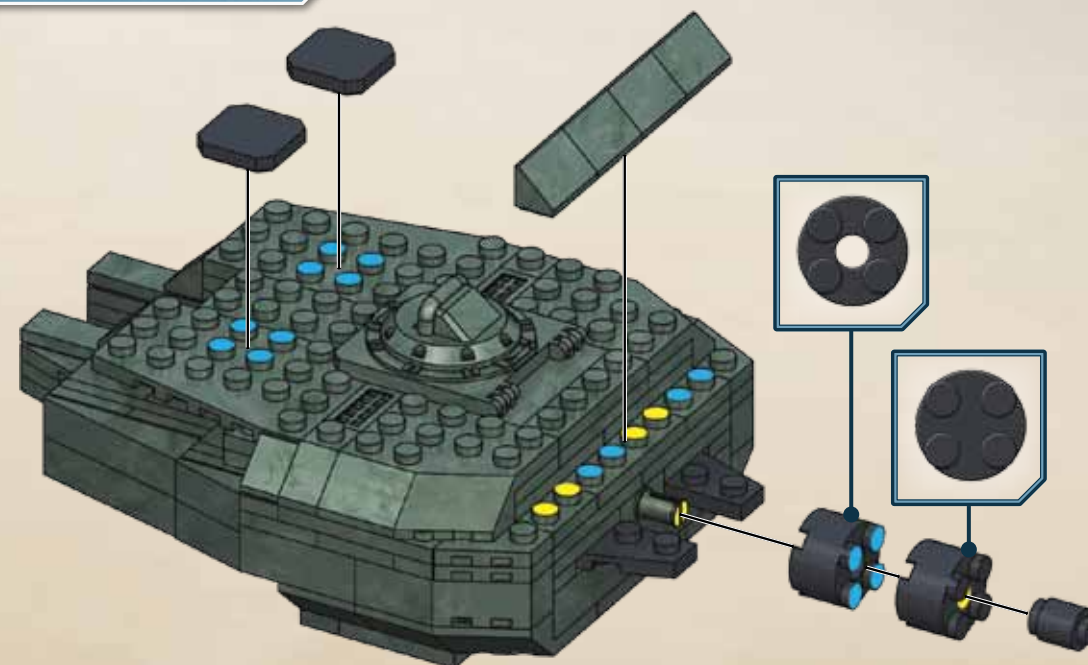



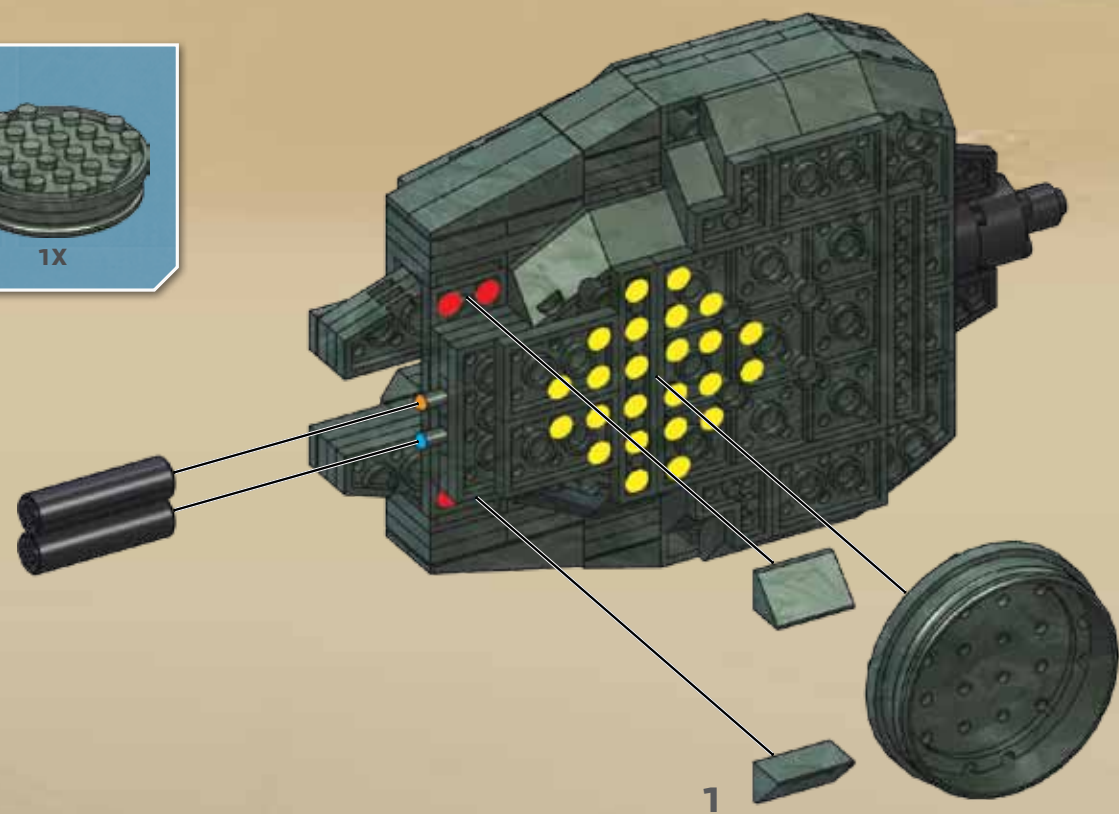
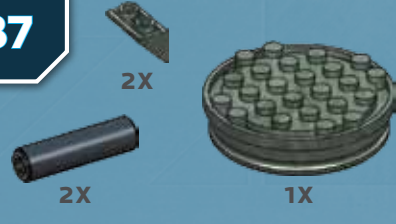



86



87



- 
1X
- 
1X
- 
1X
- 
4X
- 
1X
- 
1X
- 
1X
- 
2X
- 
2X
- 
1X
- 
1X

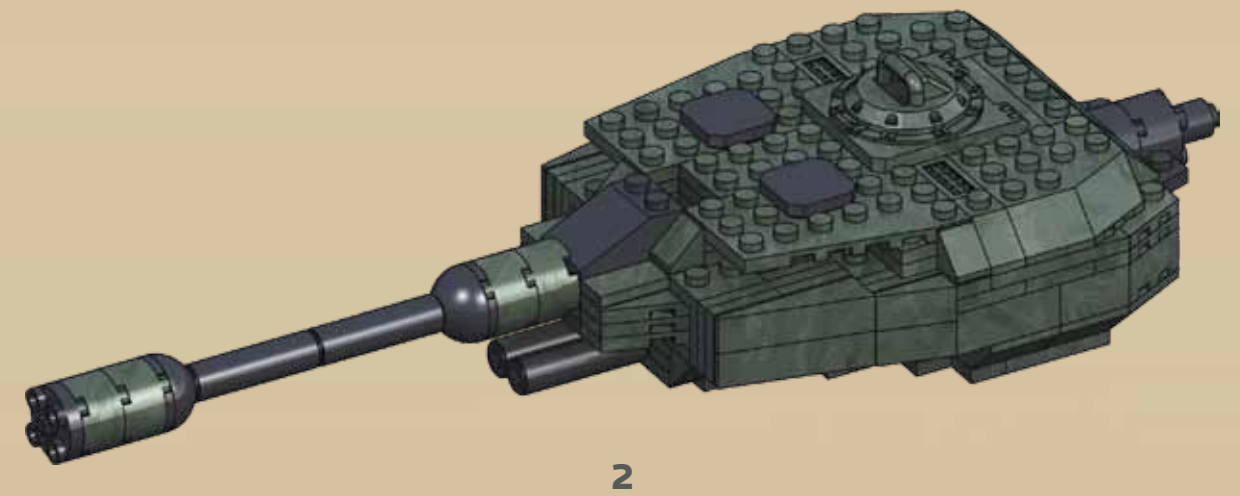
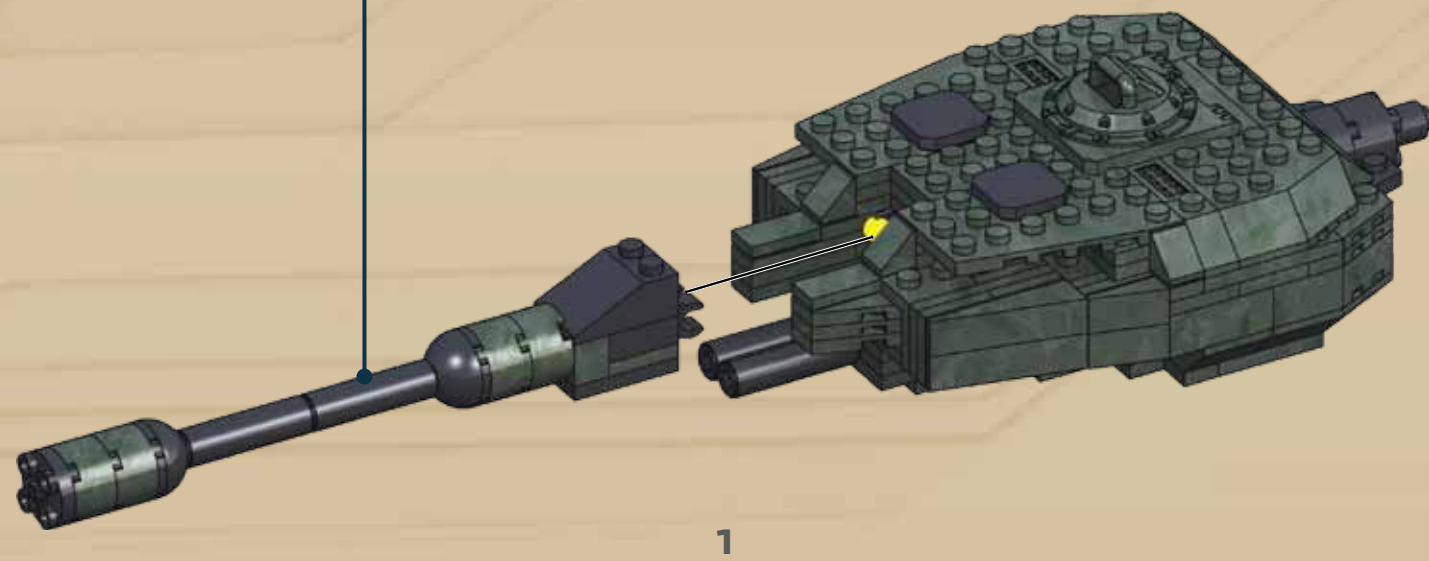
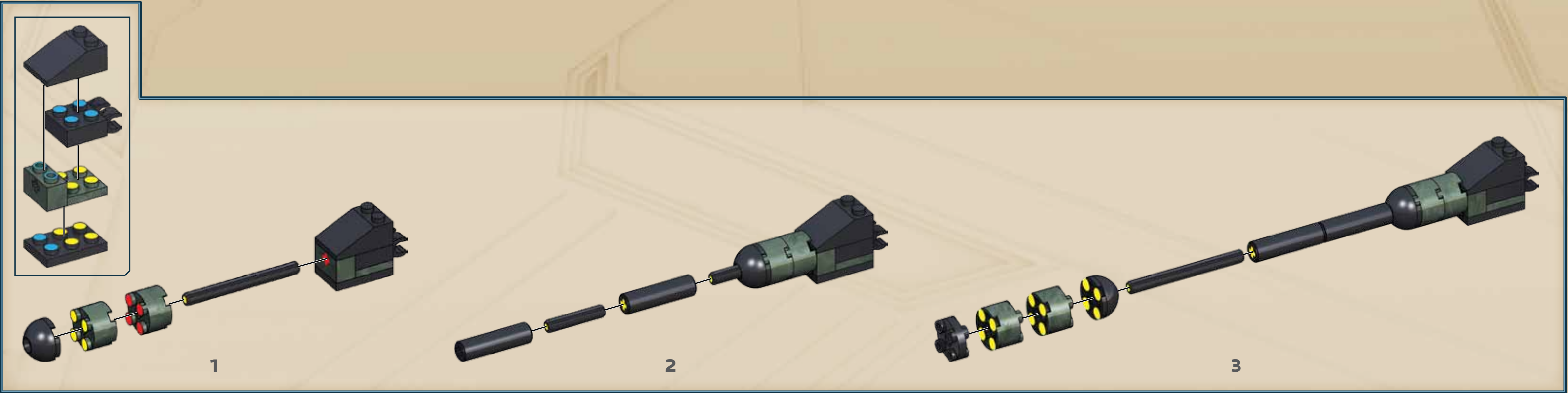

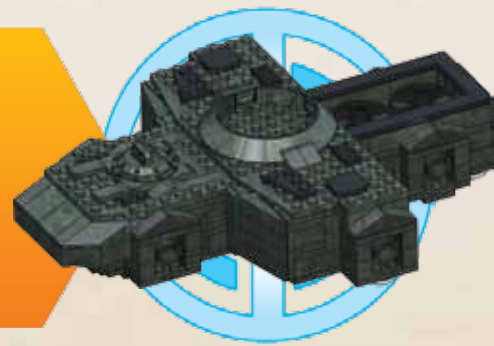

89

- 1X 1x4 dark grey plate
- 1X 1x8 dark grey plate
- 1X 1x2 dark grey plate
- 2X 1x2 dark grey plate
- 2X 1x3 dark grey plate
- 2X 1x4 dark grey plate

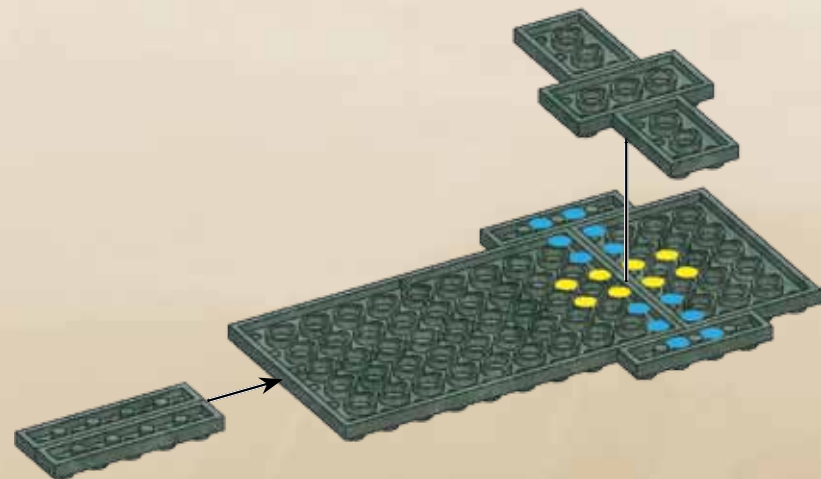

90

- 2X 1x4 dark grey plate
- 2X 1x8 dark grey plate

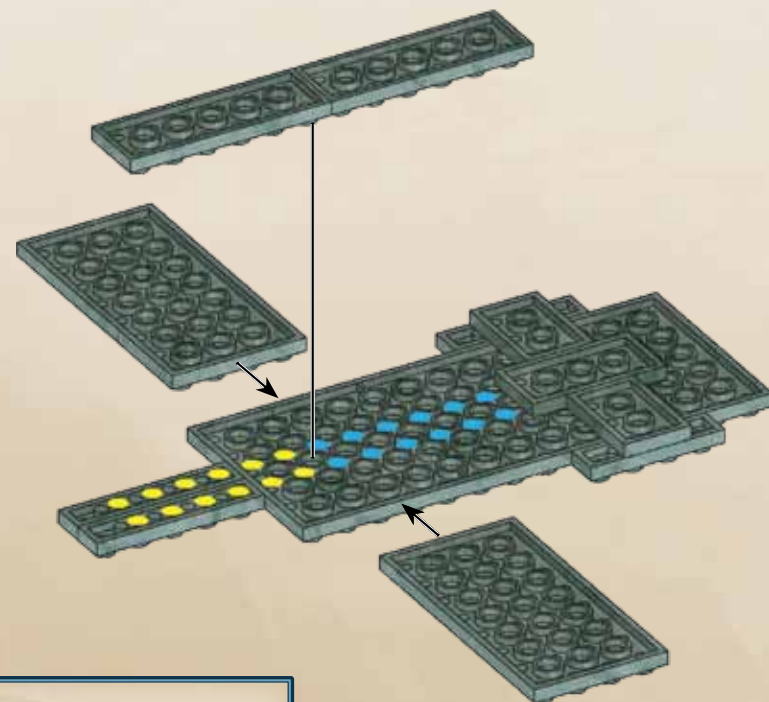

91

- 2X 1x8 dark grey plate

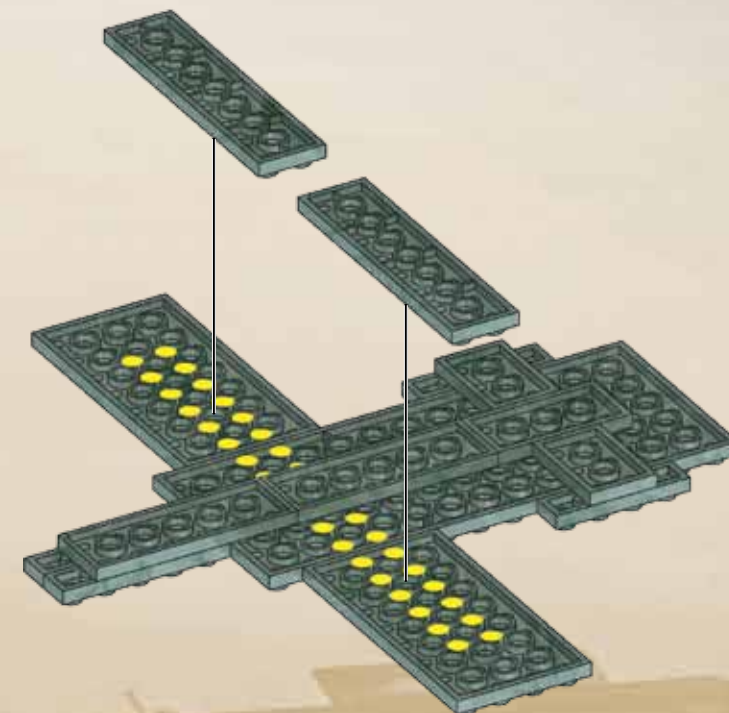

92

- 1X 1x2 dark grey plate
- 1X 1x4 dark grey plate
- 4X 1x4 dark grey plate
- 1X 1x8 dark grey plate
- 1X 1x8 dark grey plate

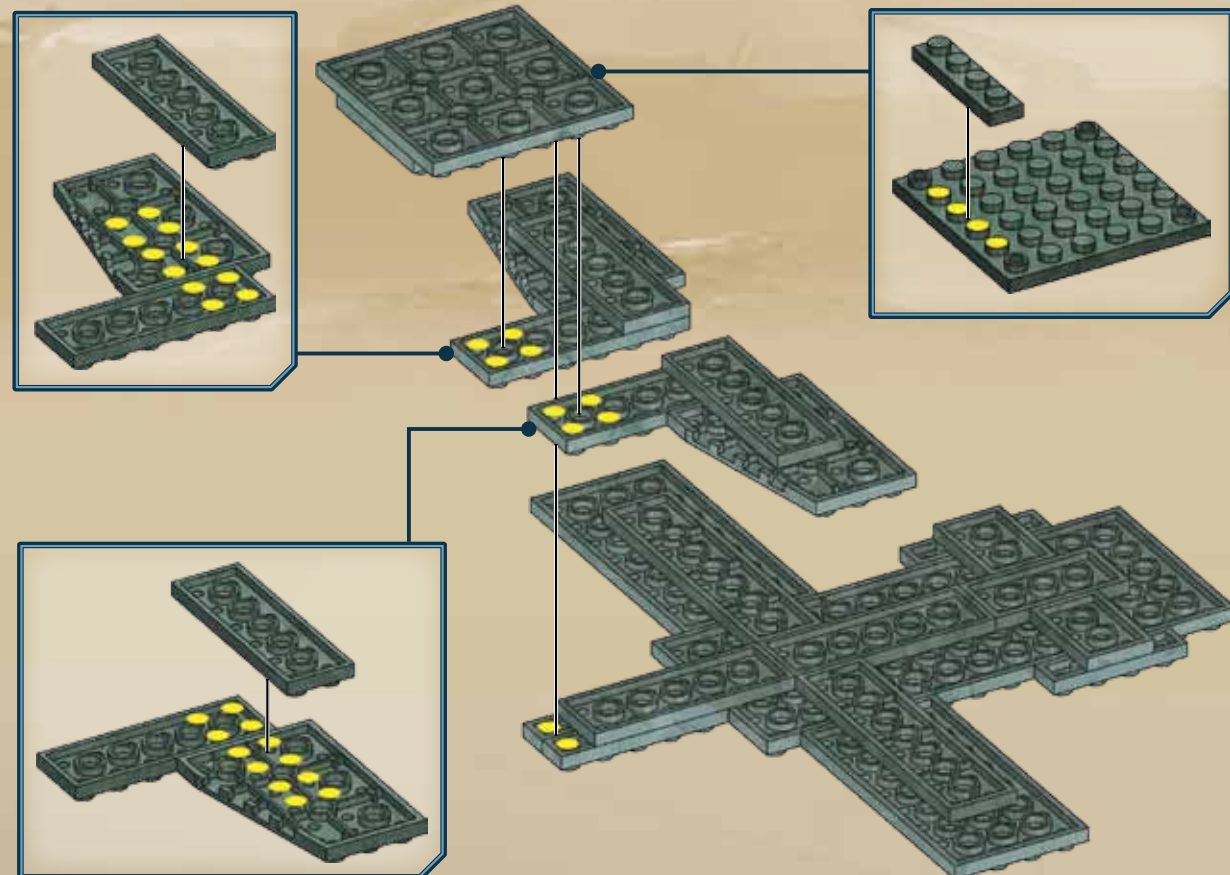

1

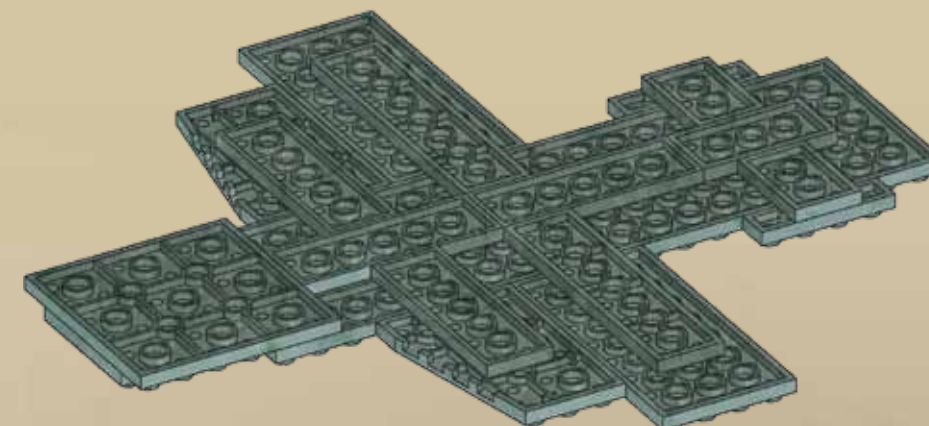

2

93

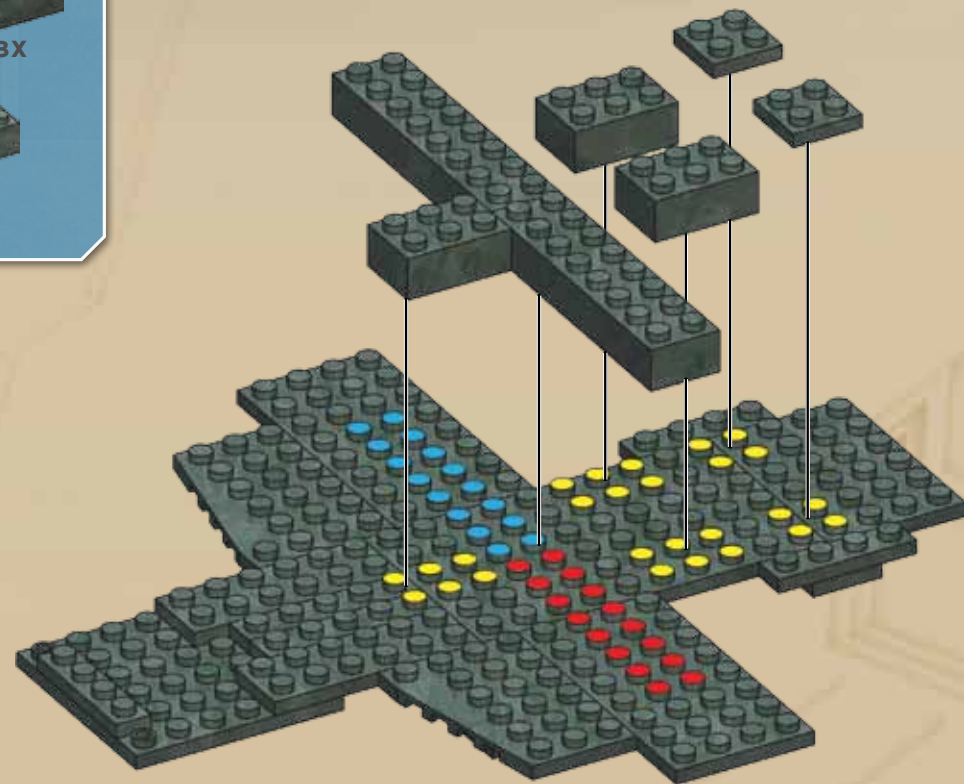

94

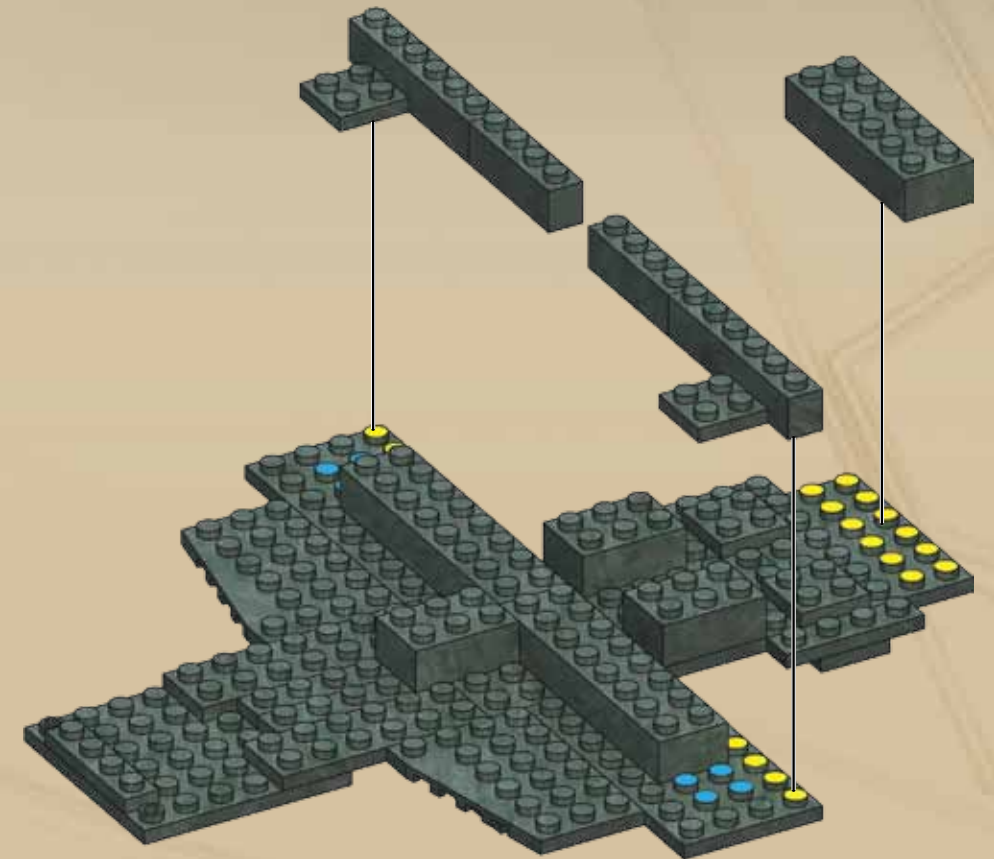
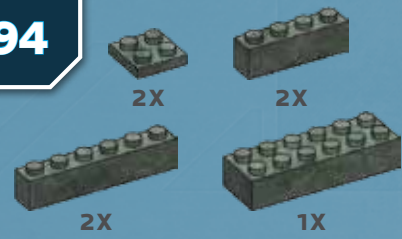

95

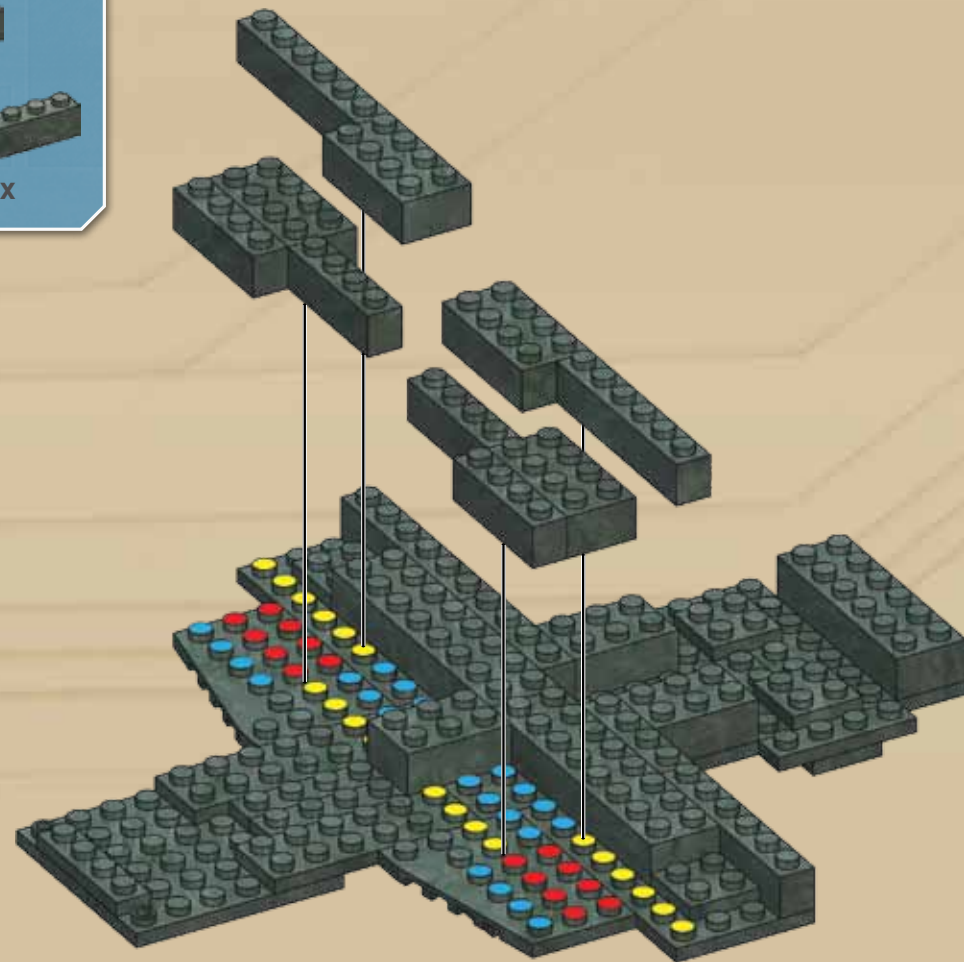
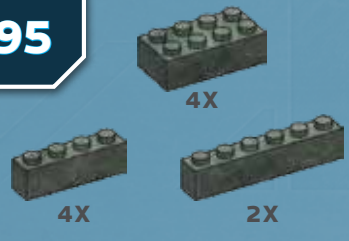

96

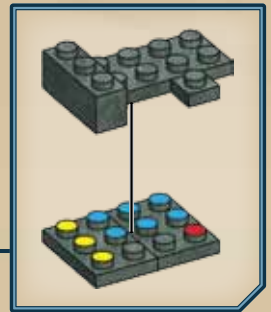
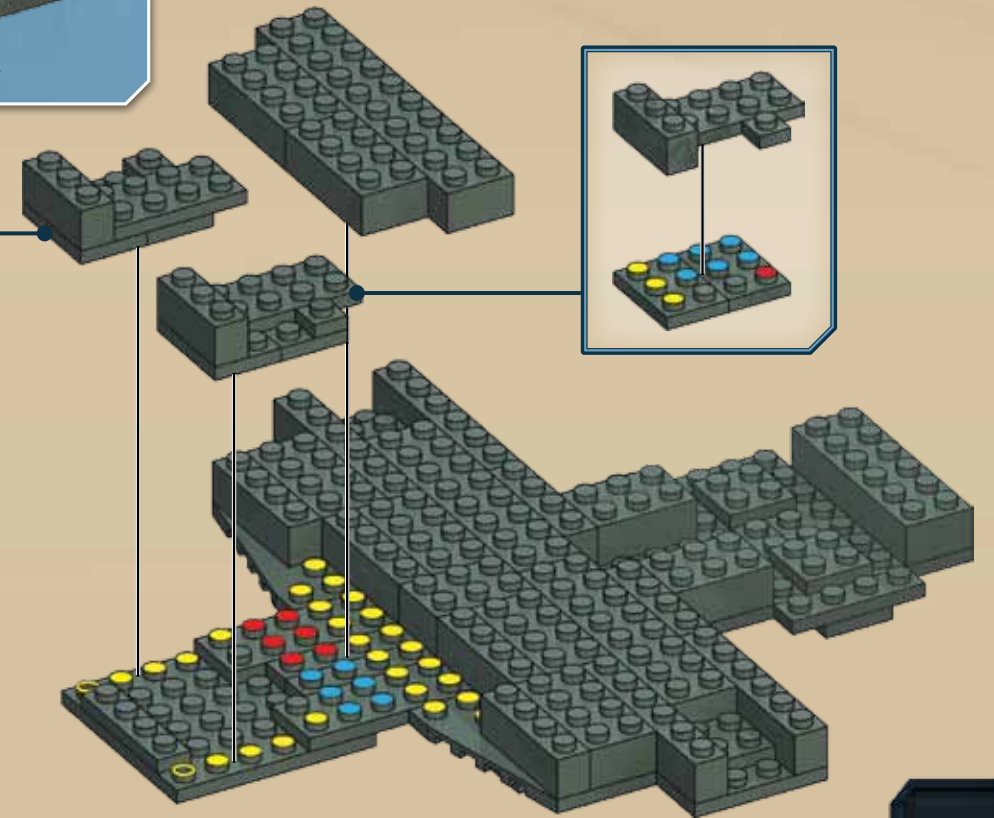
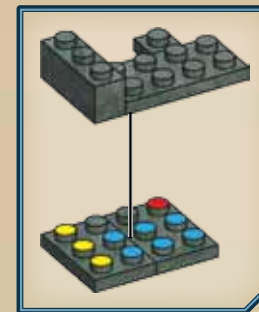

97

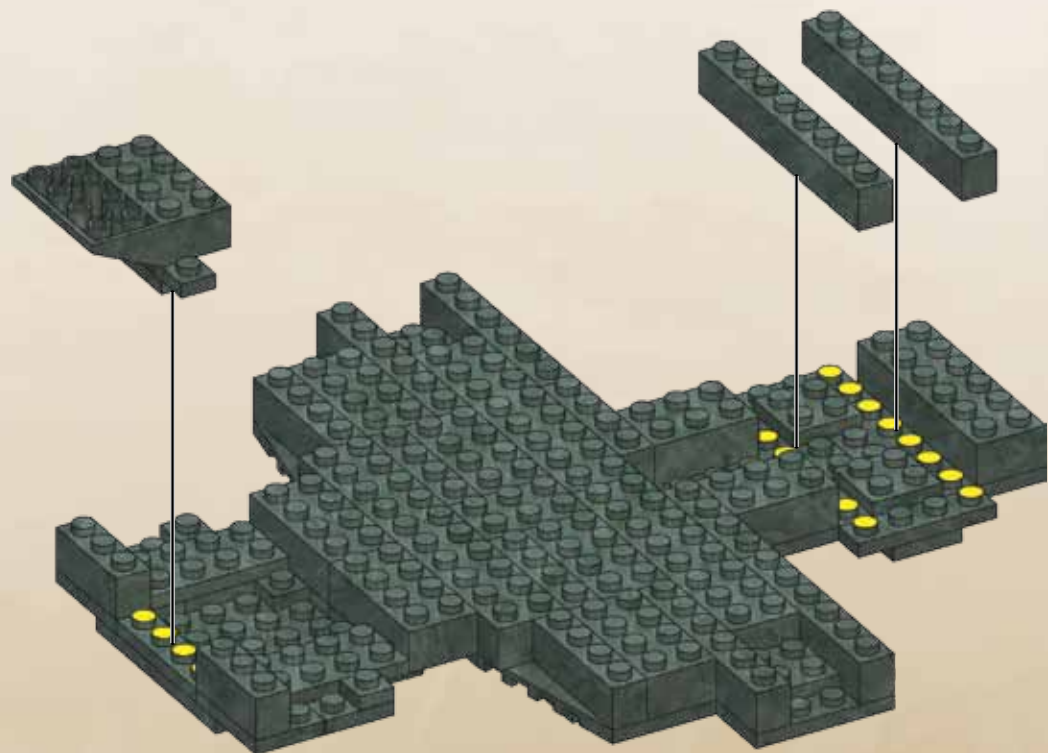
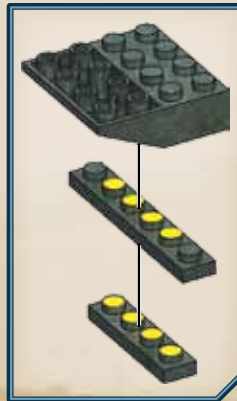
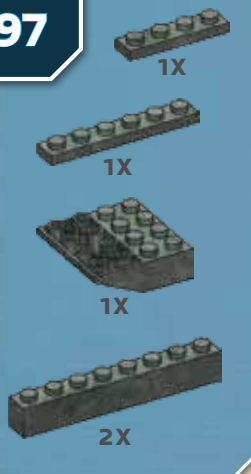

98

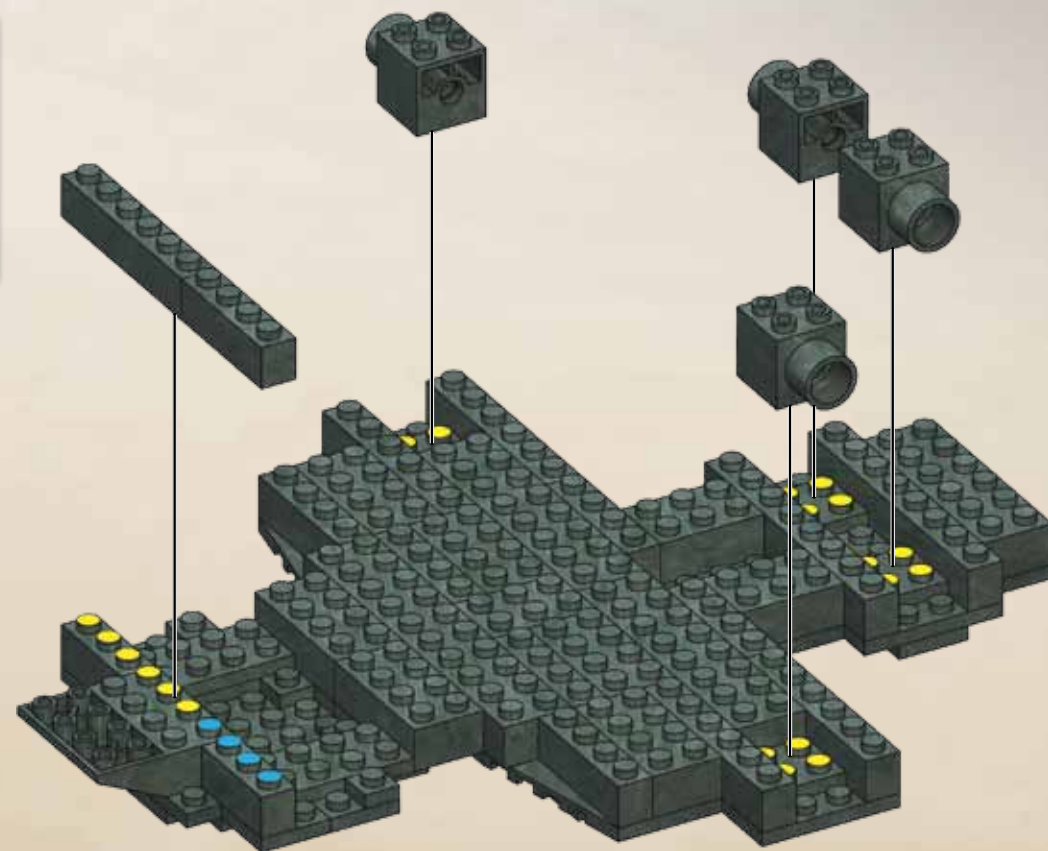
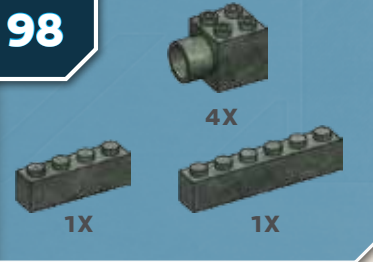

99



100

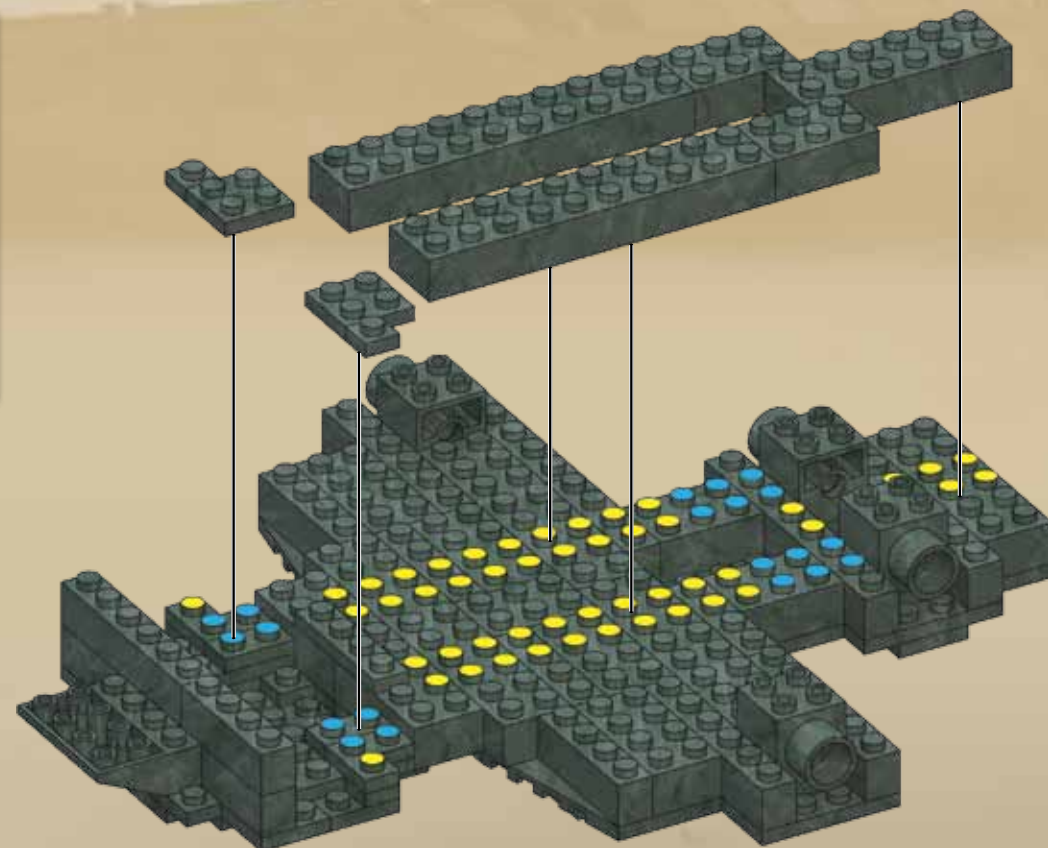
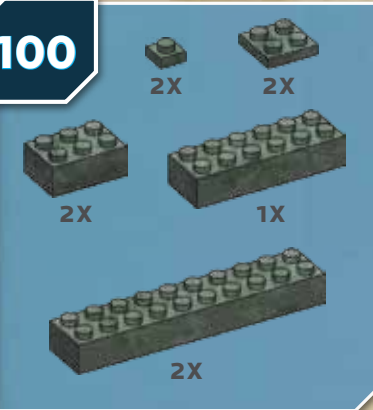

101

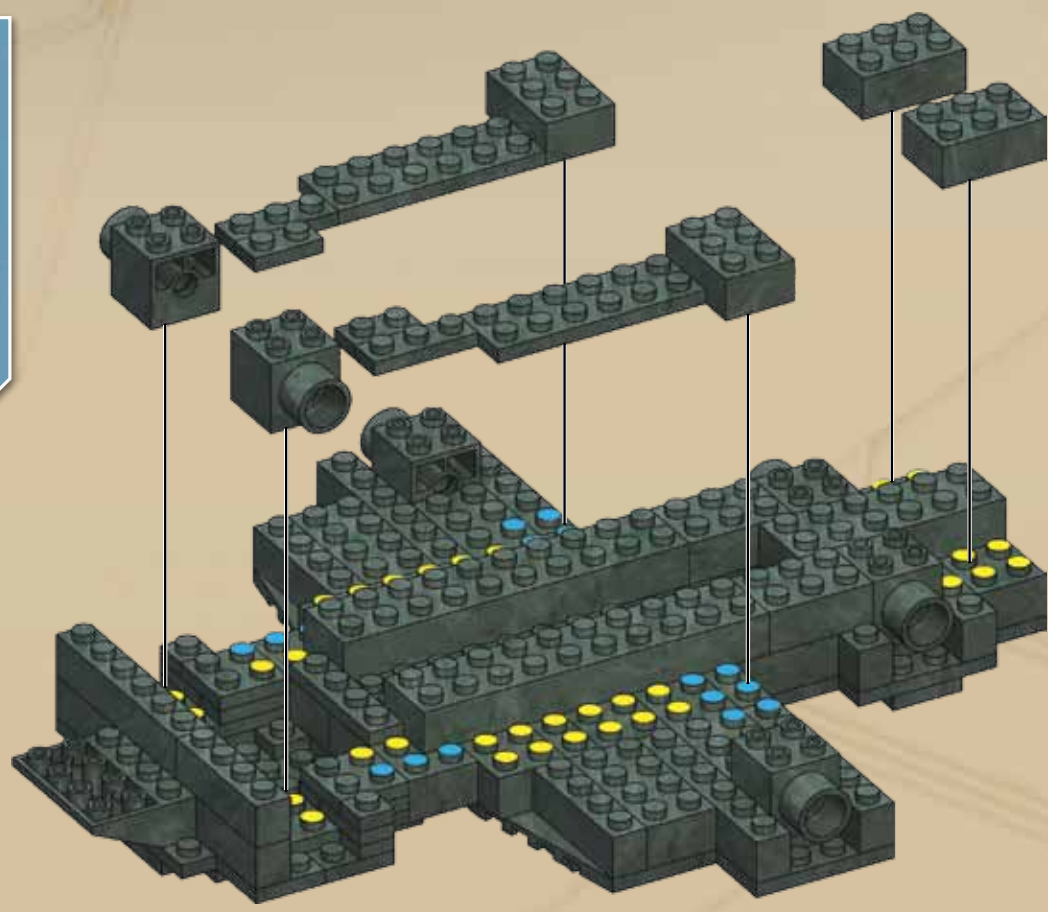

102

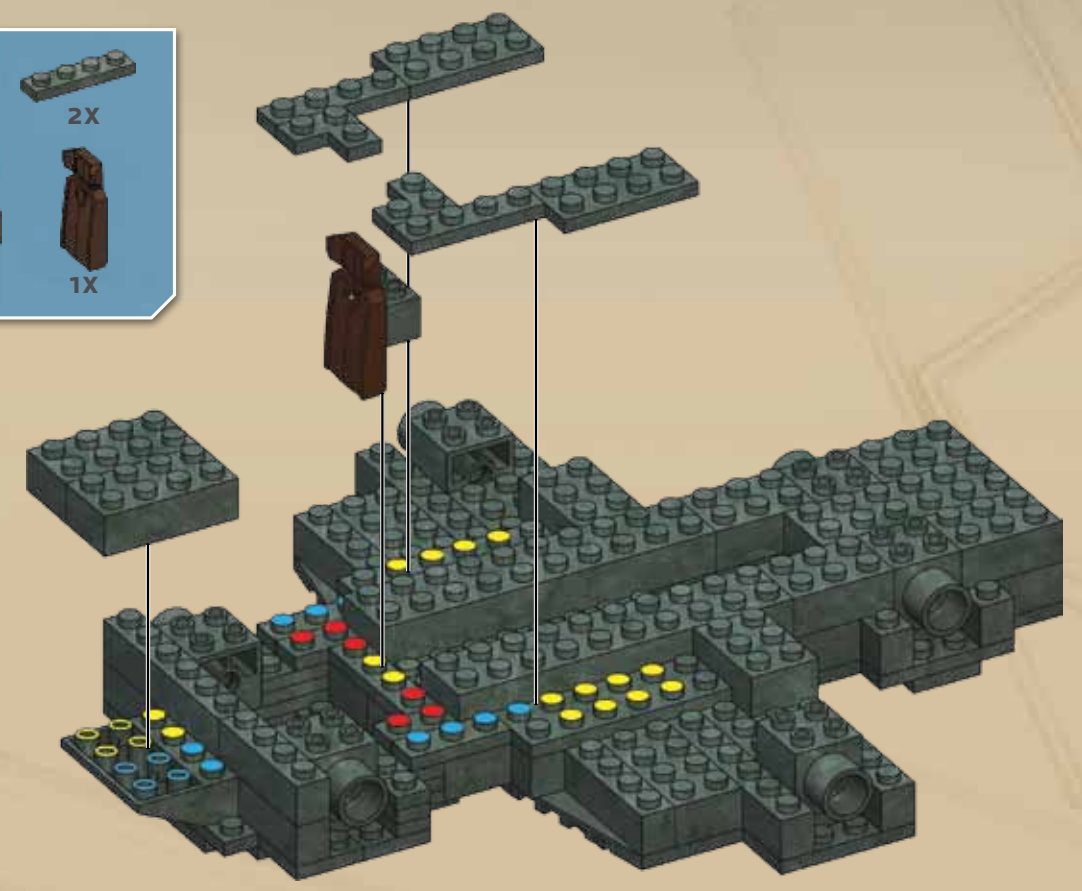
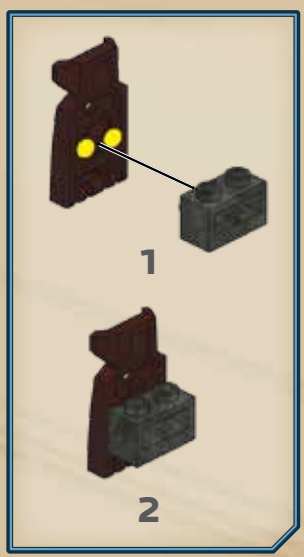

103



104

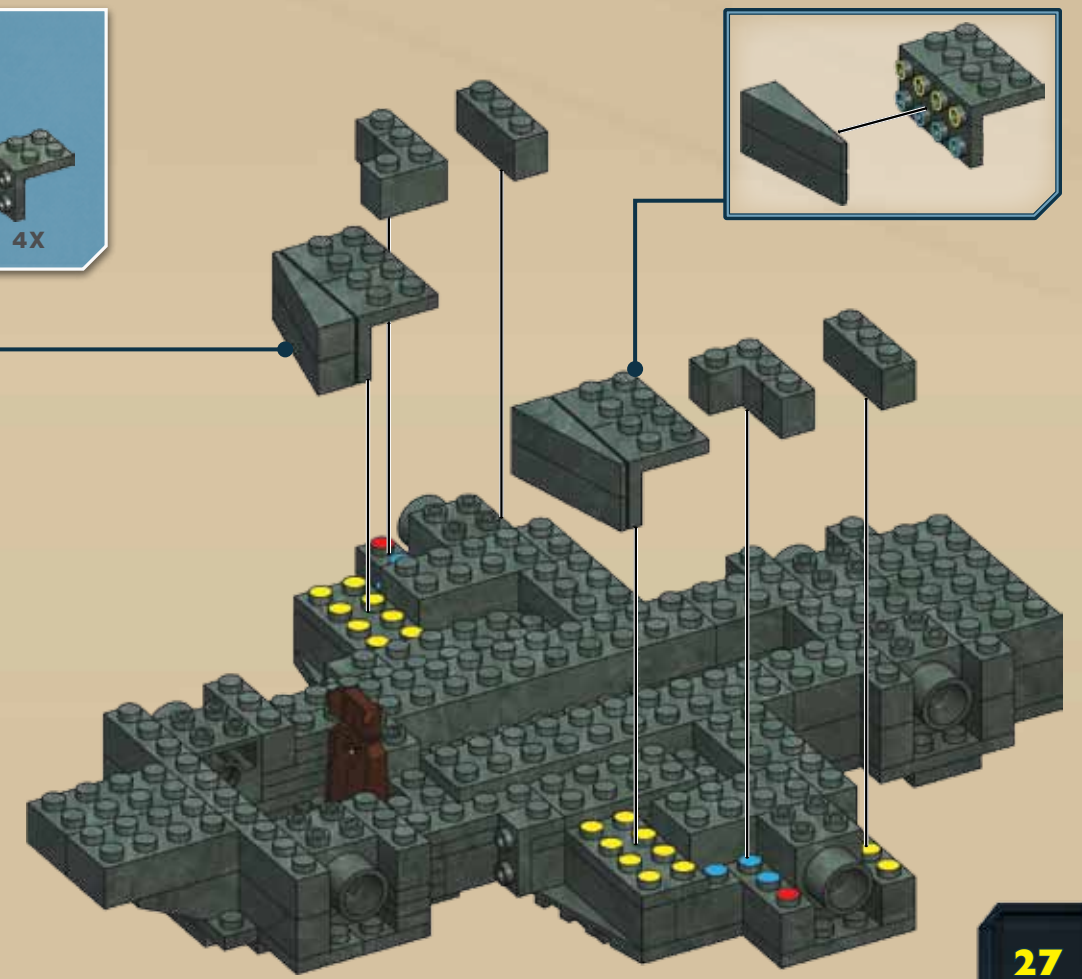
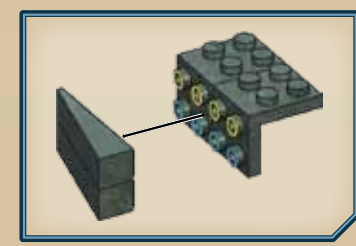

105

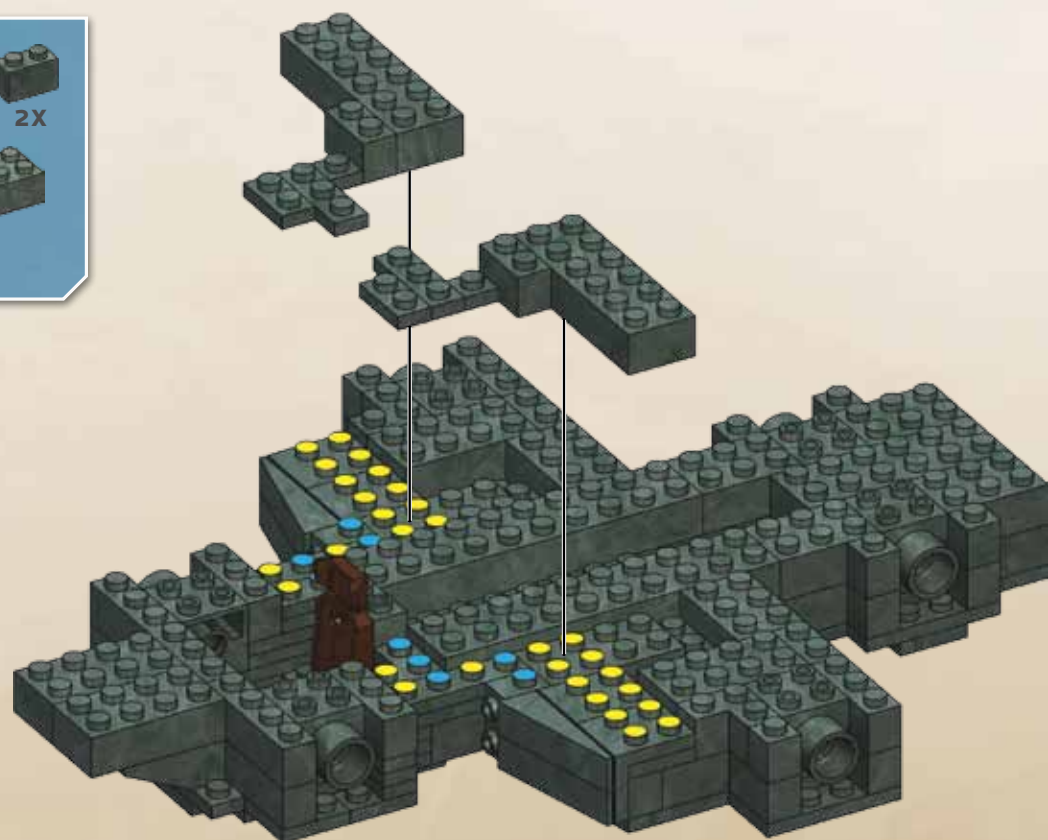

106

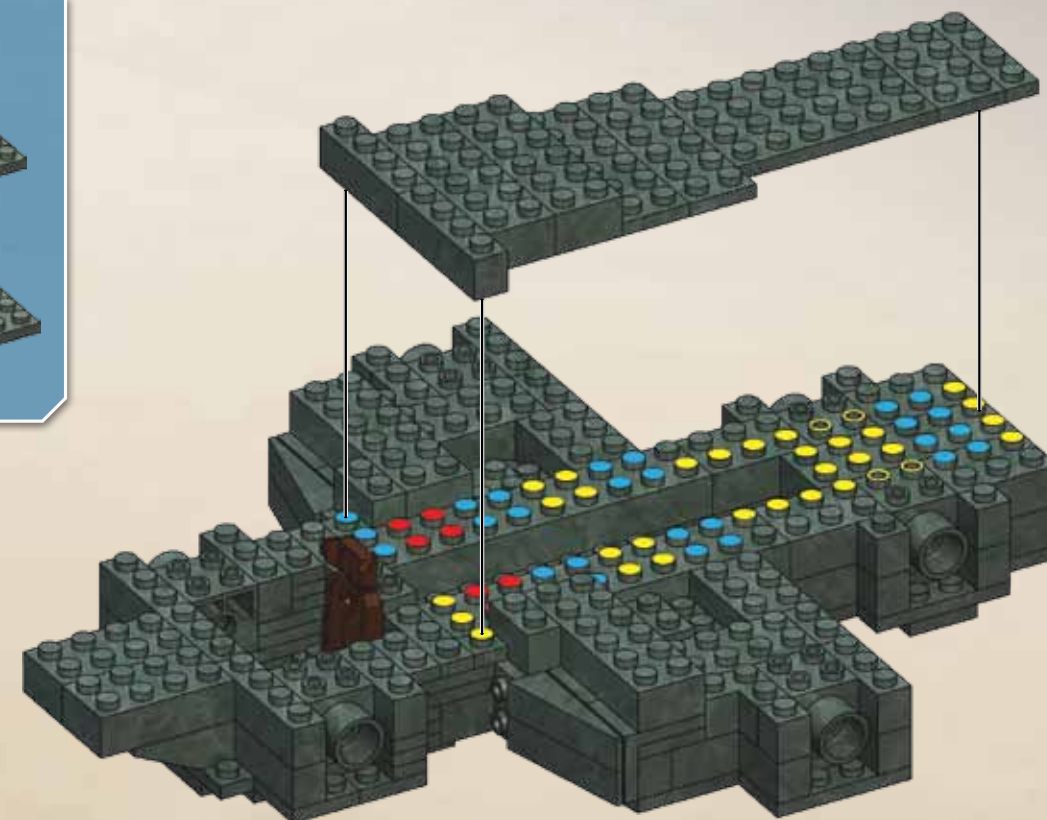
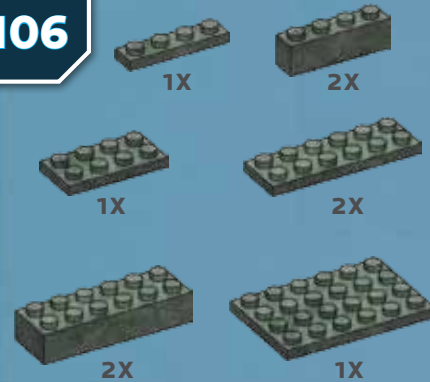

107



108



109

- 2X
- 1X
- 3X
- 2X
- 2X

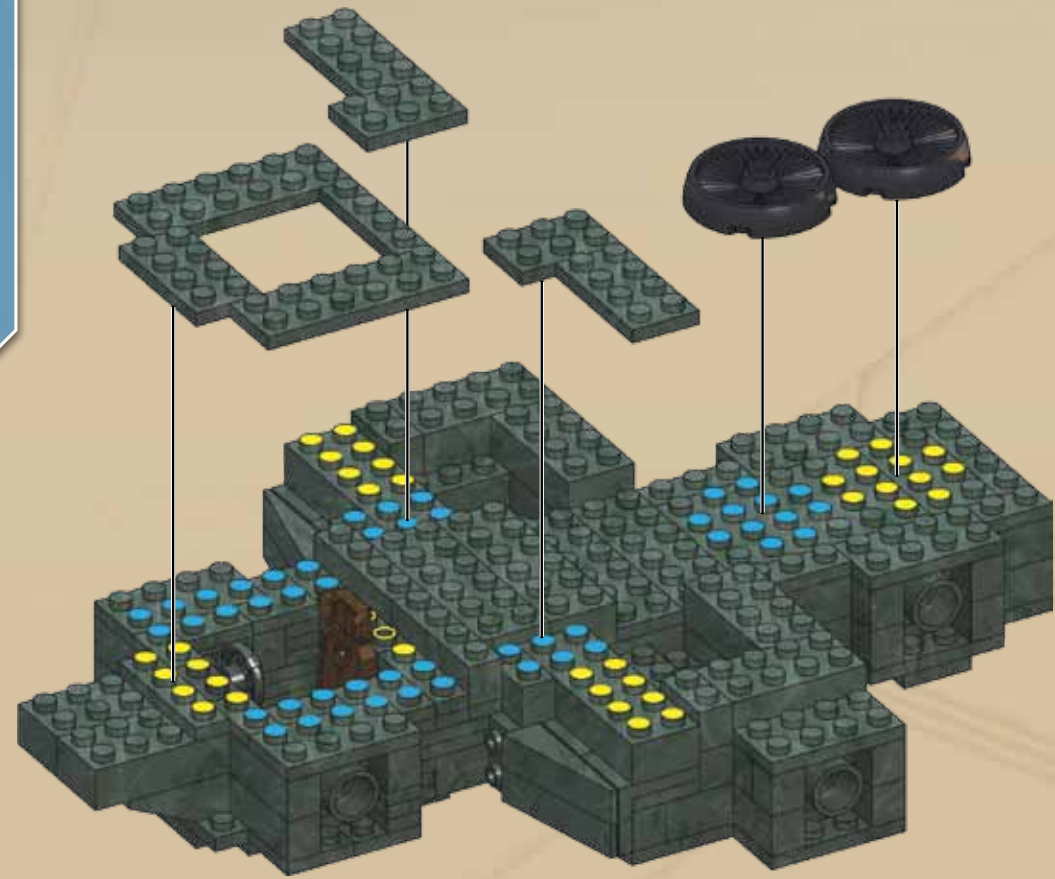

110

- 4X
- 1X
- 6X
- 2X
- 2X

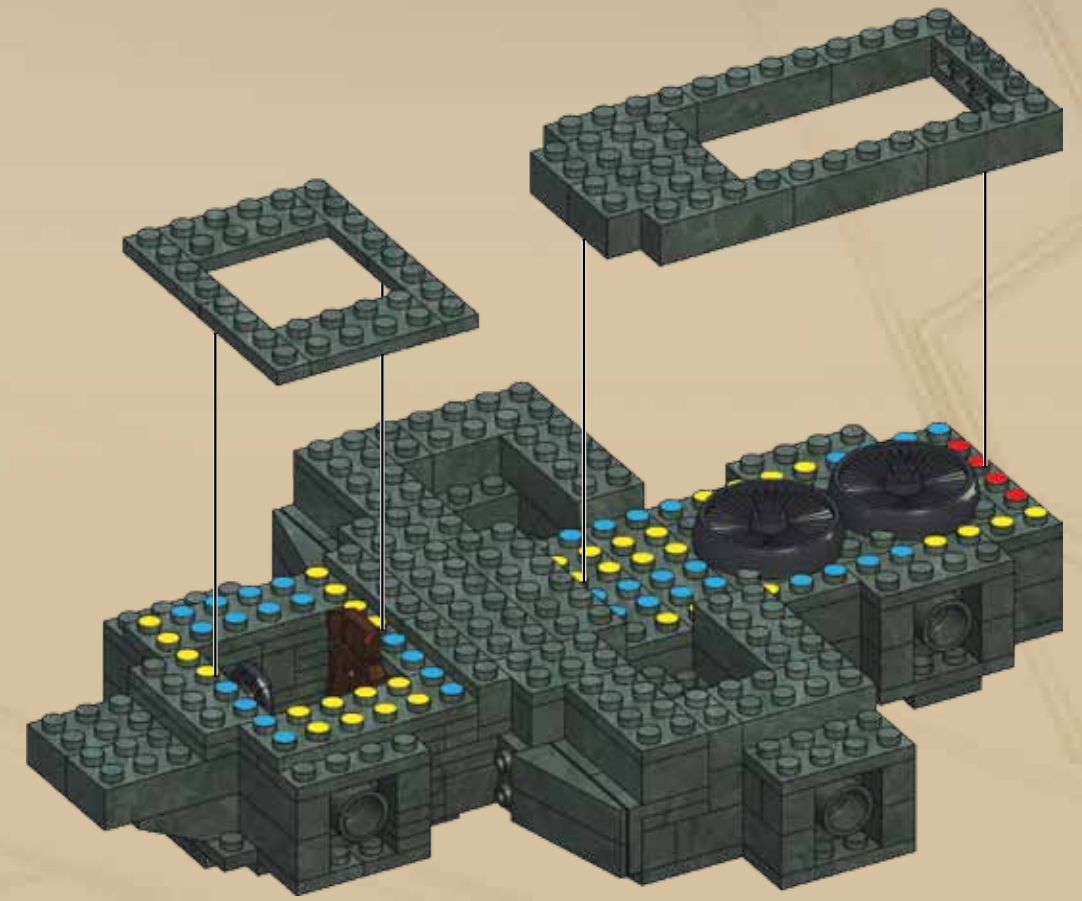

111

- 4X
- 1X
- 2X
- 2X
- 2X
- 1X

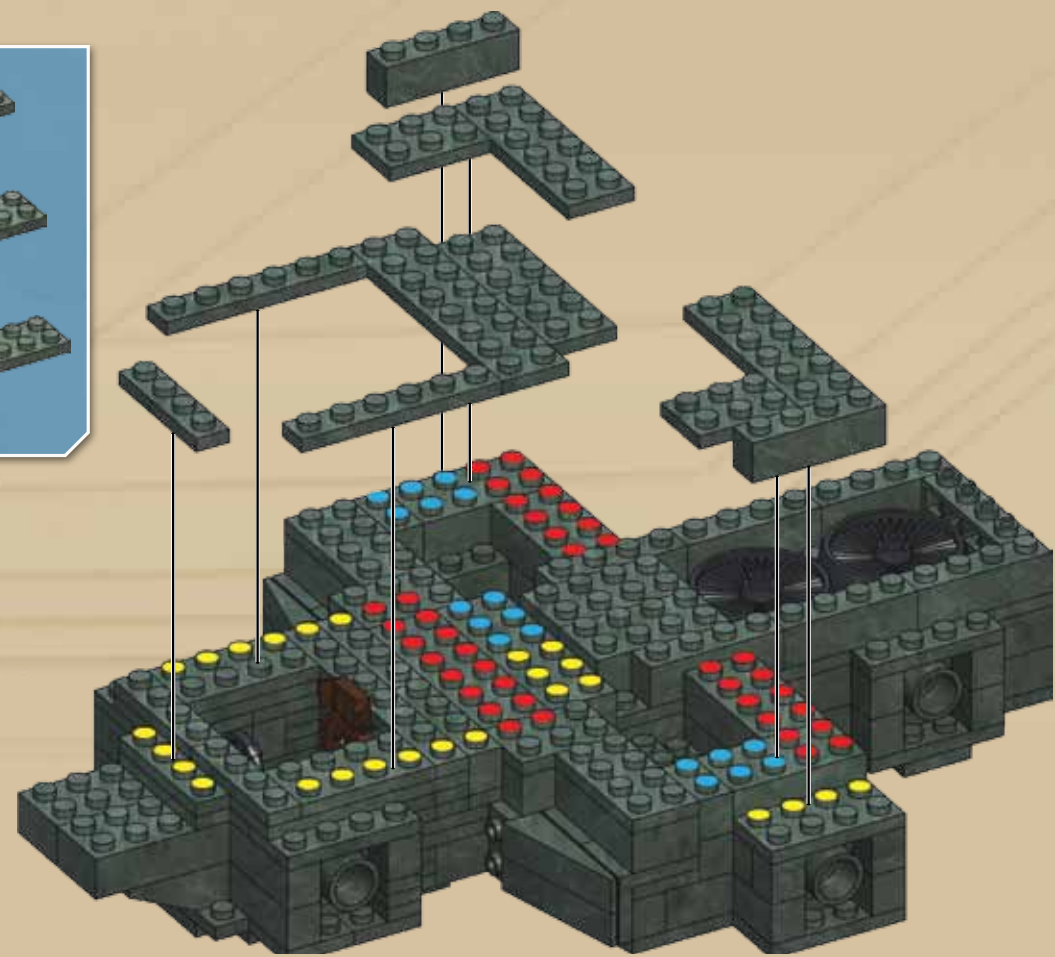

112

- 2X
- 2X
- 2X
- 1X
- 1X
- 2X
- 1X

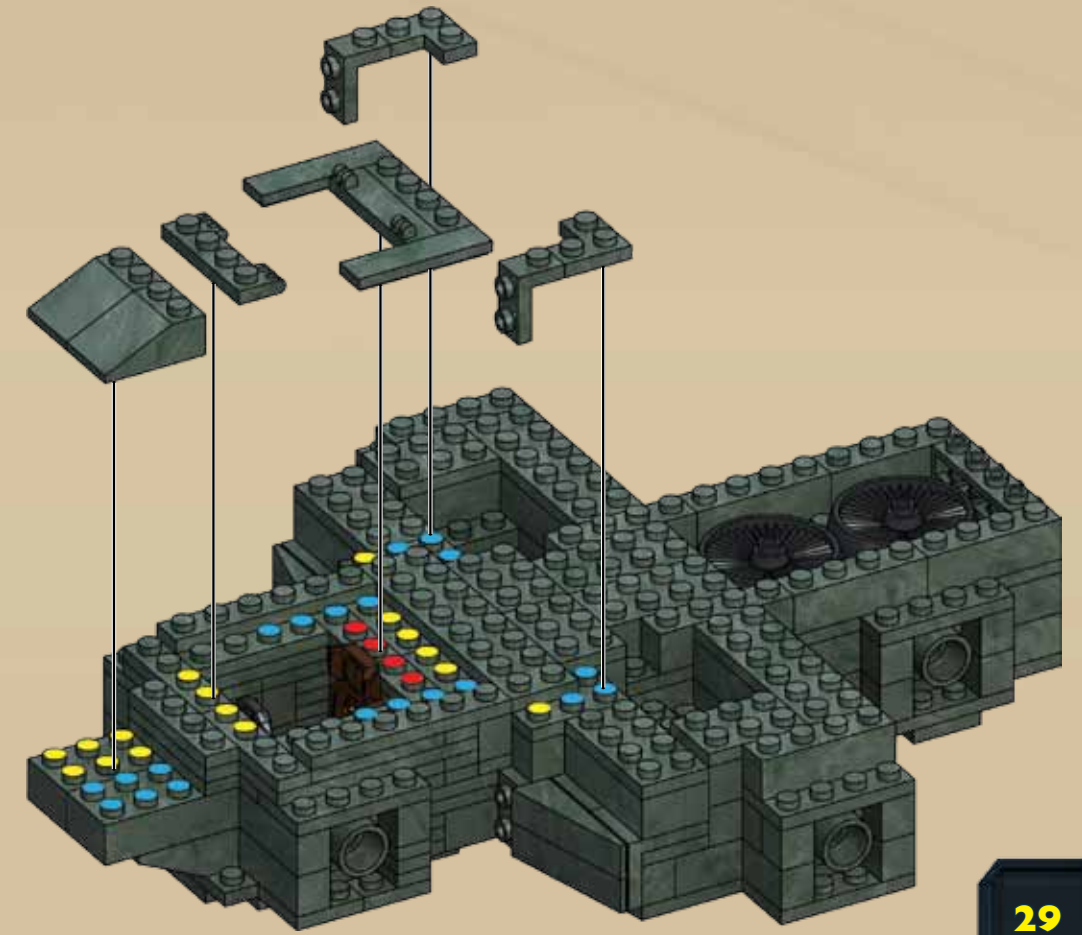

113

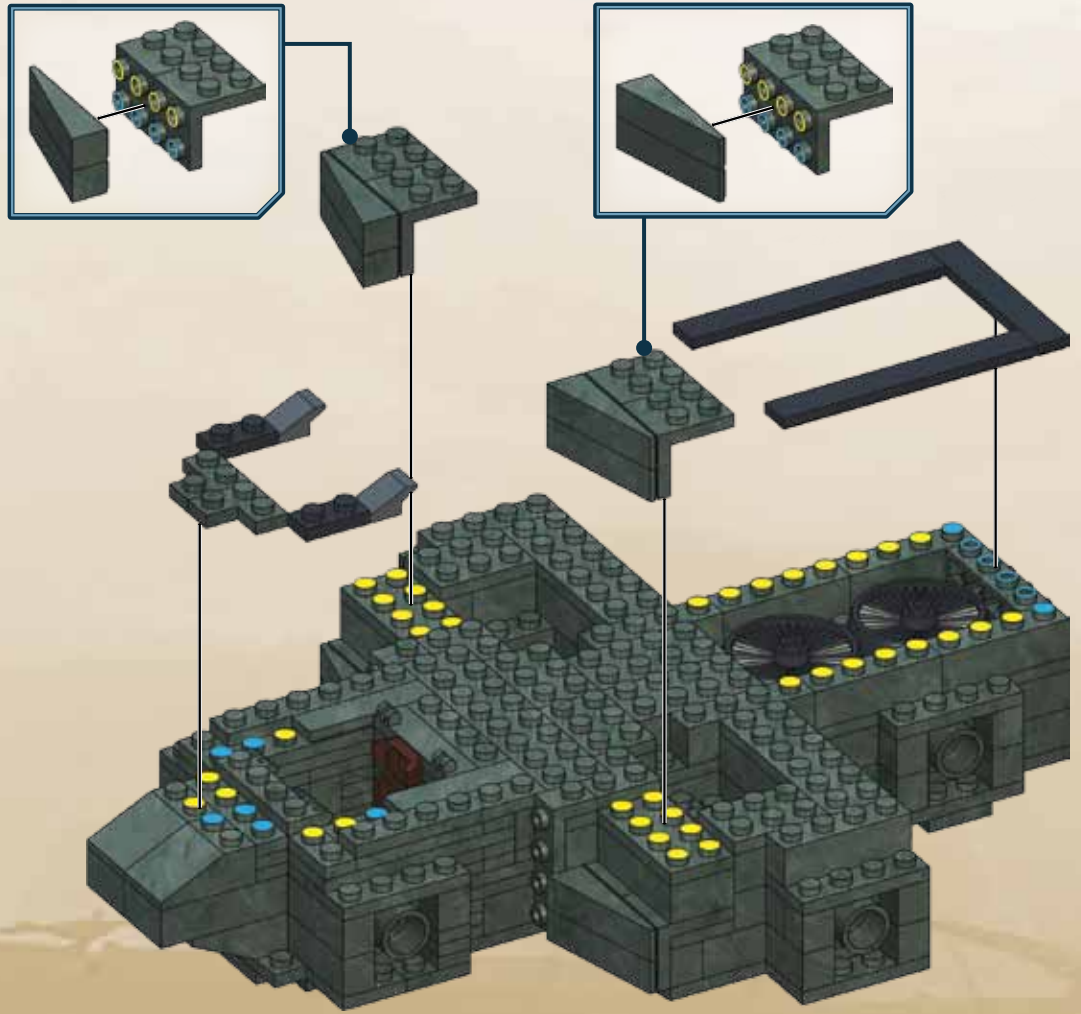
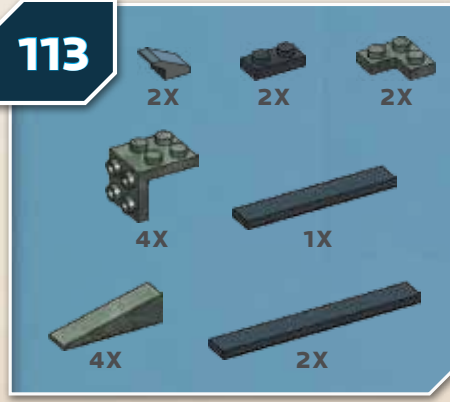

114

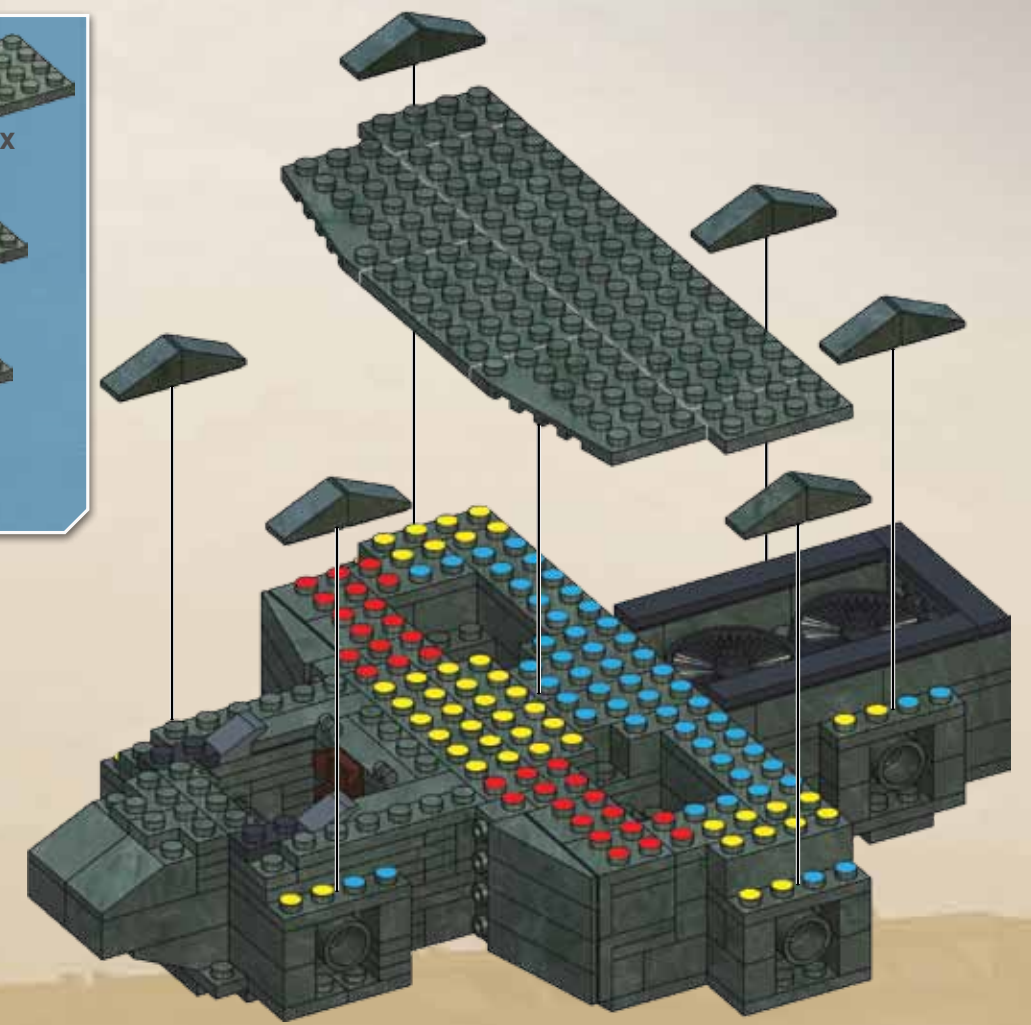
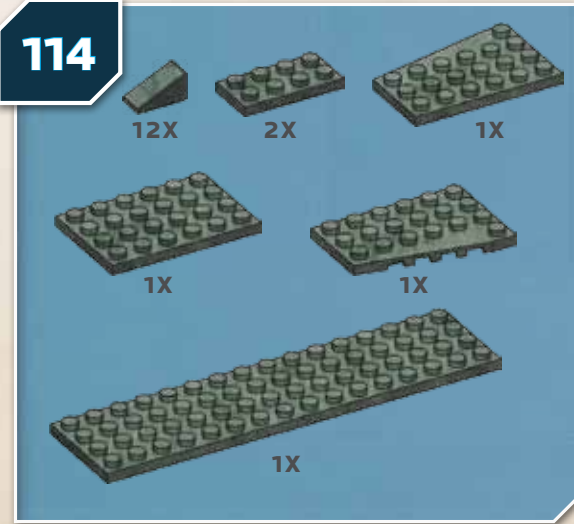

115

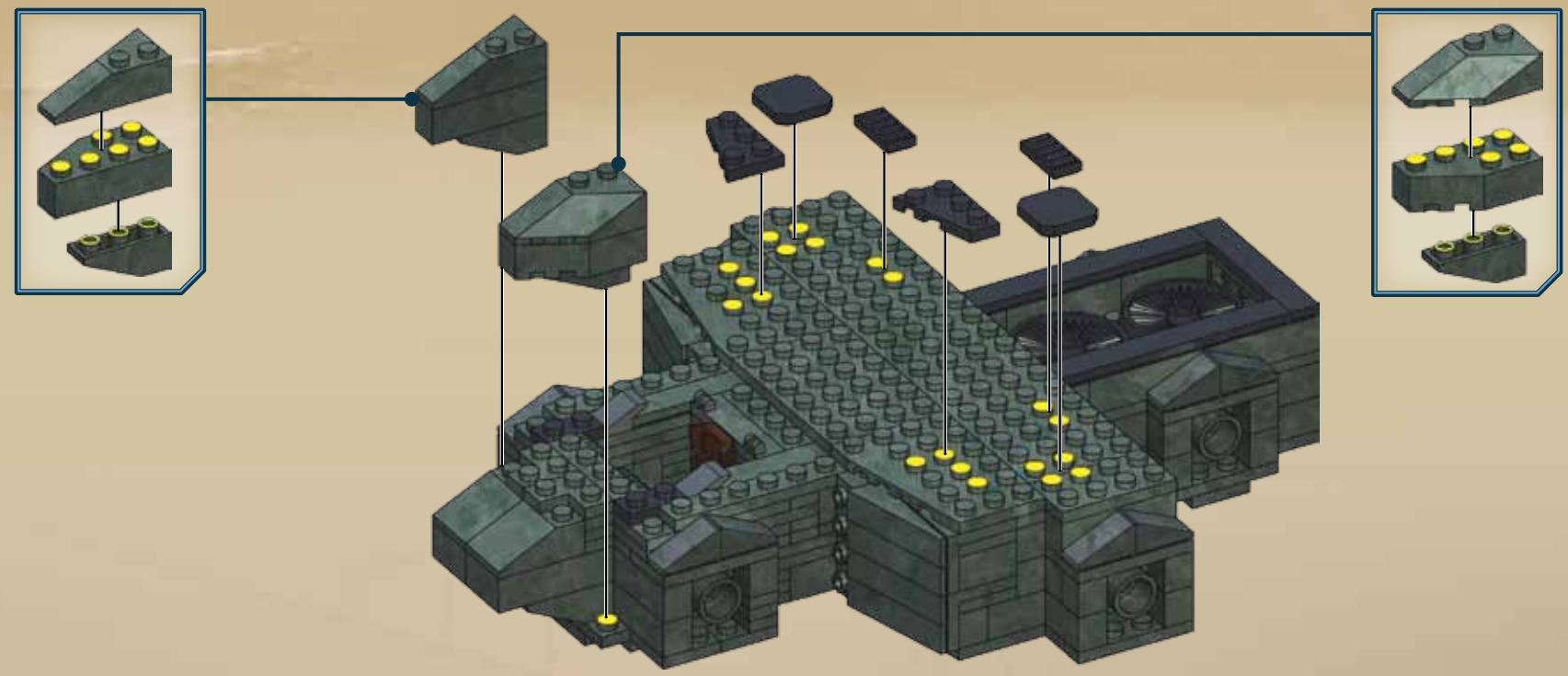

116

2X

1X 1X

1X



117

4X 1X



118

2X

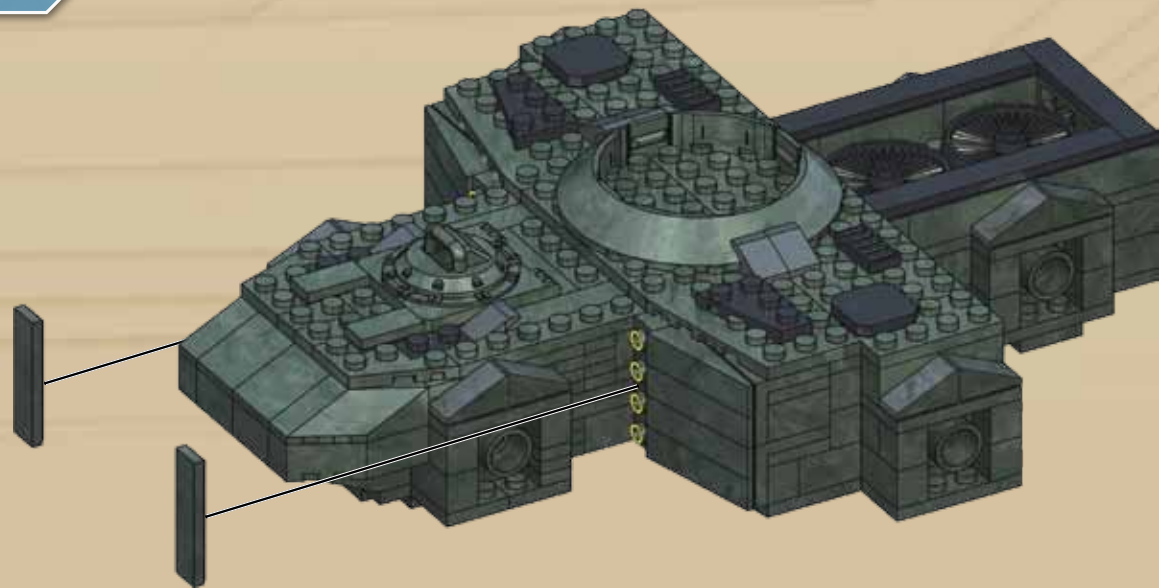

119

1X

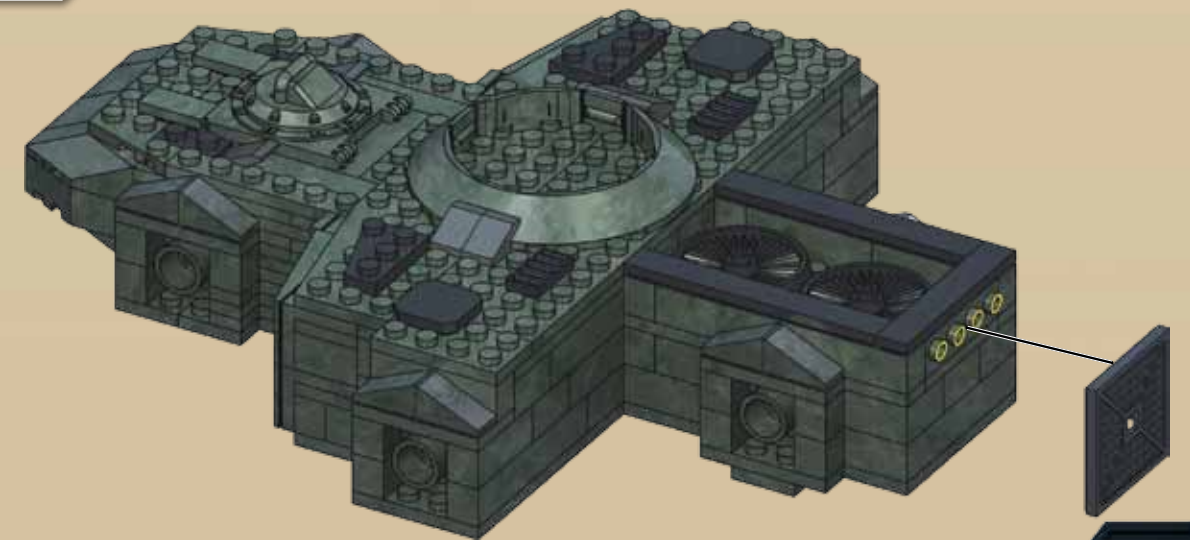



123

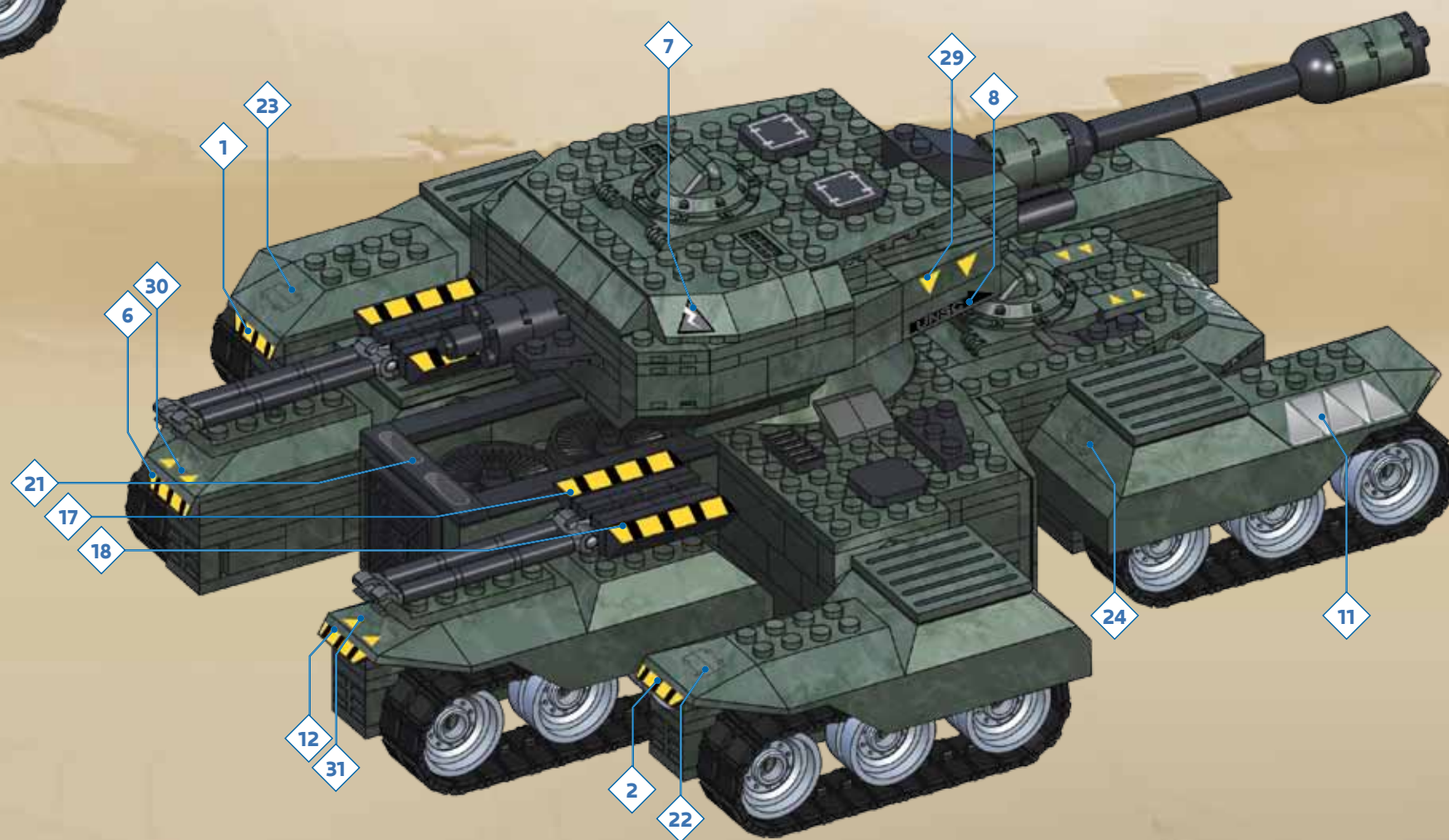
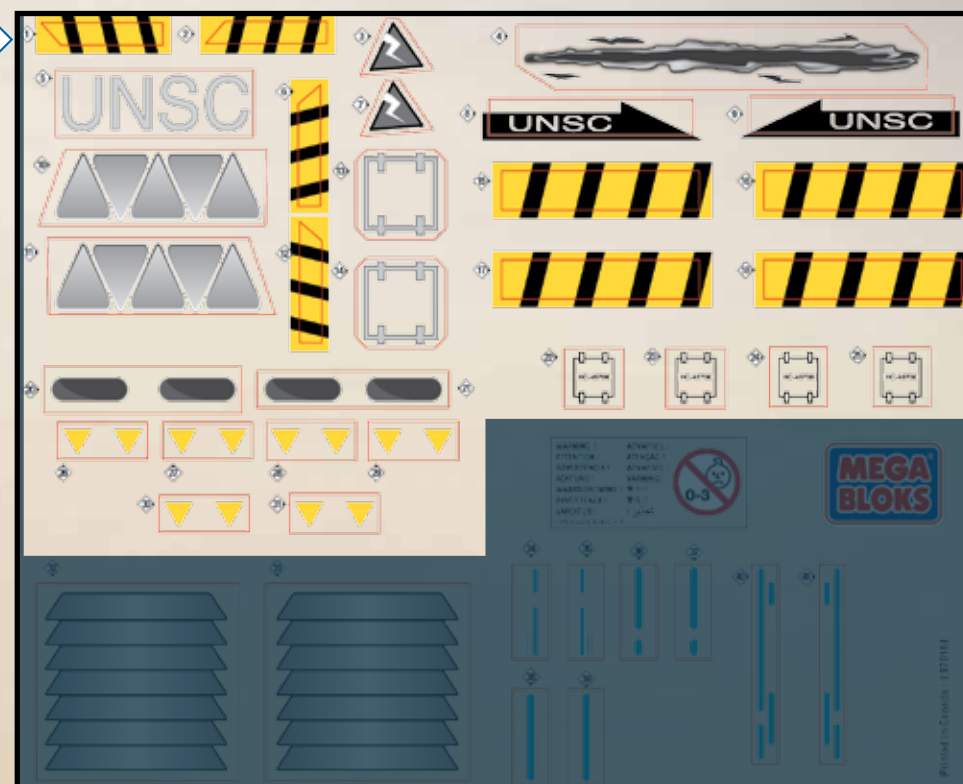
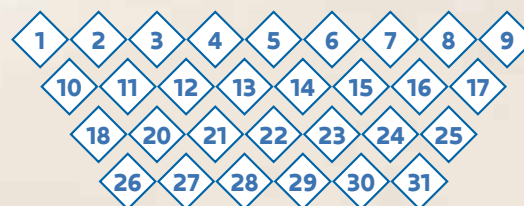
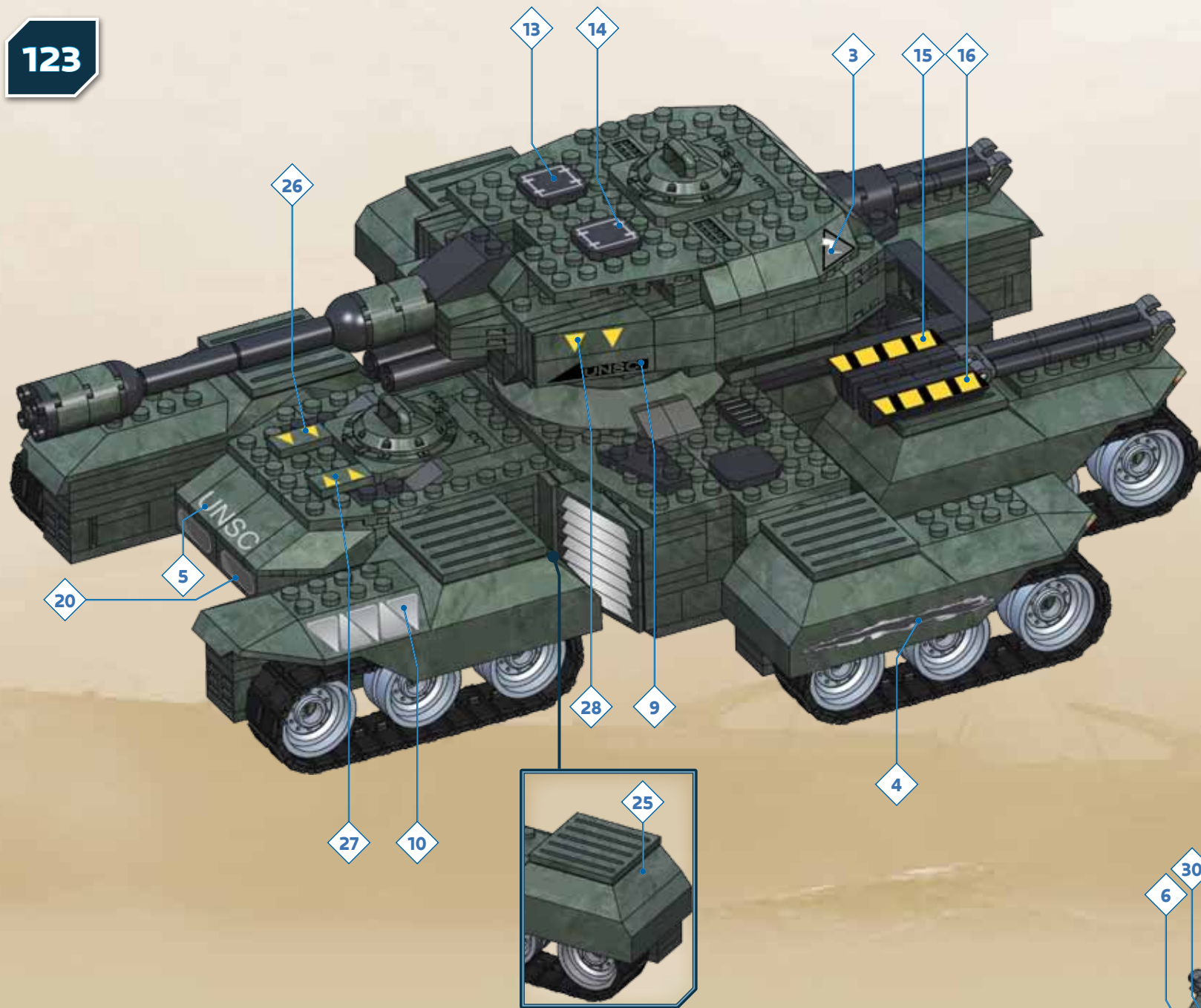

HALO

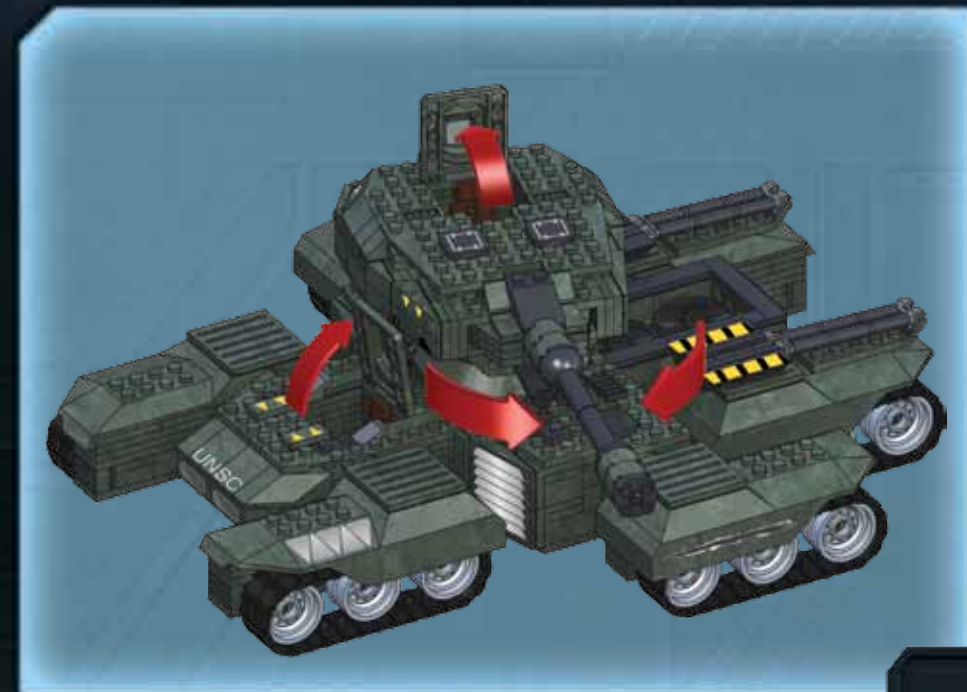
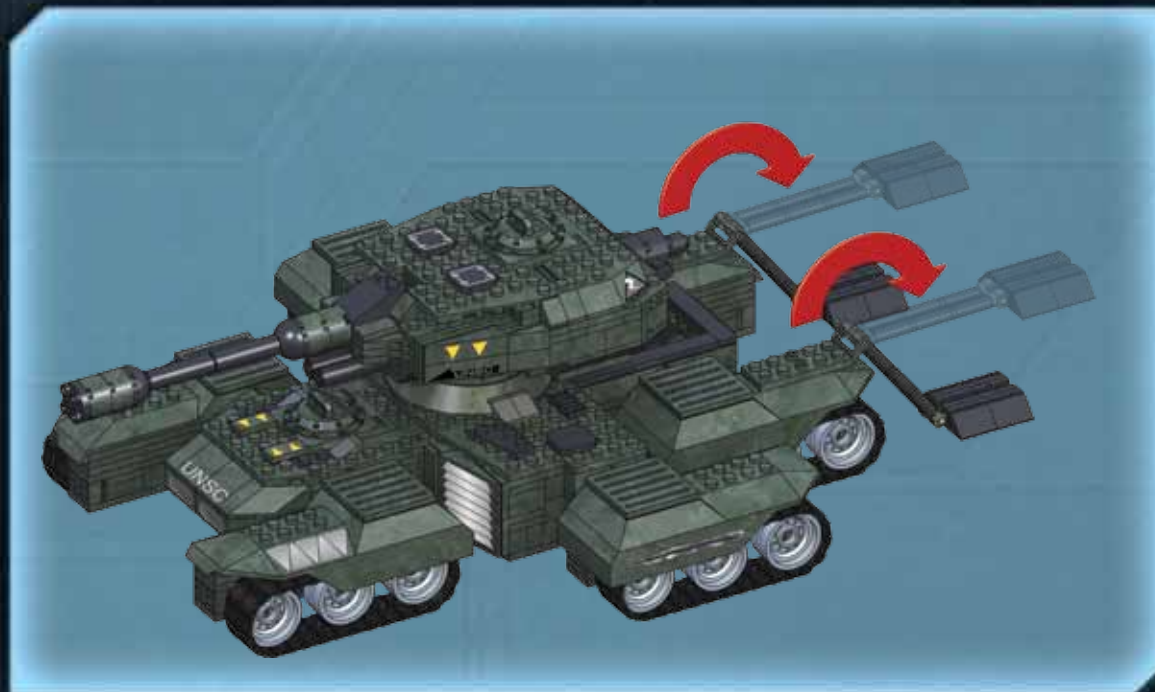

HALO

UNSC RHINO

As the Covenant hide out in an old Forerunner structure, the massive UNSC Rhino tank is called in to eliminate the base and keep the ancient technology out of enemy hands. The UNSC Rhino is a massive 6-tread artillery tank armed with the prototype Zeus 320 mm Cannon that rotates a full 360 degrees, and capable of a lock-down mode to aid in long range bombardment.

Rhino del CENU

Al esconderse los Covenantes en una antigua estructura Forerunner, llaman al masivo tanque Rhino del CENU para eliminar la base y mantener la tecnología antigua fuera de las manos del enemigo. El Rhino del CENU es un tanque masivo de artillería de 6 bandas de rodamiento armado con el prototipo de cañón Zeus 320mm que gira 360 grados completos y es capaz de un modo bloqueado para ayudar en bombardeos de largo alcance.

Rhino du CSNU

Pendant que les forces du Covenant se cachent à l'intérieur d'une vieille structure Forerunner, l'énorme char d'assaut Rhino du CSNU se charge de détruire la base et de s'assurer que ces technologies anciennes ne tombent pas entre les mains de l'ennemi. Le Rhino du CSNU est un char d'assaut gigantesque à 6 chenilles armé du prototype de canon Zeus 320 mm pouvant tourner sur 360 degrés et capable de passer en mode stationnaire pour effectuer des bombardements de longue portée.

RVN Rhino

Während der Covenant sich in einer alten Vorläuferstruktur versteckt, wird der massive RVN-Rhino-Panzer gerufen, um die Basis zu beseitigen und dem Feind die alte Technologie aus den Händen zu nehmen. Der RVN Rhino ist ein massiver 6-kettiger Artilleriepanzer, ausgerüstet mit dem Prototyp der Zeus 320 mm Kanone, die um volle 360 Grad drehbar ist und mit einem Sperrmodus ausgestattet ist, um beim Langstrecken-Bombardement Unterstützung zu leisten.

Rhino Rhino

Omdat de Covenant zich in een oude Forerunner-installatie heeft verschanst, wordt de hulp van de enorme RVN Rhino-tank ingeroepen om de basis te vernietigen en de oude technologie uit vijandelijke handen te houden. De RVN Rhino is een indrukwekkende artillerietank op rupsbanden die is uitgerust met een Zeus 320mm Cannon dat 360 graden kan draaien en kan worden vastgezet voor lange-afstandsbombardementen.

Rhino CSNU

Mentre il Covenant è nascosto in una struttura Forerunner, il massiccio carro armato CSNU Rhino è chiamato per eliminare la base e tenere l'antica tecnologia al riparo dalle mani del nemico. L'CSNU Rhino è un enorme carro armato con artiglieria a 6 file armato con il cannone prototipo Zeus 320-mm, capace di una rotazione completa di 360 gradi, e in grado di operare in modalità bloccata per offrire supporto nei bombardamenti a lungo raggio.

Rhino CENU

Como os Covenantes se escondem em uma antiga estrutura Forerunner, o enorme tanque Rhino do CENU é chamado para eliminar a base e manter a antiga tecnologia longe das mãos do inimigo. O Rhino do CENU é um enorme tanque de artilharia de 6 esteiras armado com o canhão prototipo Zeus 320mm que gira 360 graus e que é capaz de operar em modo travado para auxiliar bombardeios de longo alcance.

MEGABLOKS CAMO EFFECT
EFFECTO CAMO MEGABLOKS
EFFET CAMO MEGABLOKS
 MEGABLOKS CAMO EFFECT
 MEGABLOKS CAMO EFFECT
 EFFETTO CAMO MEGABLOKS
 EFFETTO CAMO MEGABLOKS



UNSC SCOUT SPARTAN
 Scout Spartan UNSC
 Spartan éclaireur de l'UNSC
 RVN Scout Spartan
 UNSC Scout Spartan
 Scout Spartan del CENU
 Spartan Scout CENU

UNSC MARINE
 Marine CENU
 Marine de l'CSNU
 RVN Marine
 RVN-marinier
 Infante de marina del CSNU
 Fuzileiro da CENU

COVENANT SPECIAL OPS GRUNT
 Grunt operaciones especiales
 Grunt des opérations spéciales
 Covenant Soldat für Spezialoperationen
 Covenant Special Ops
 Operazioni speciali Covenant
 Operações especiais Covenant

Collect them all! - ¡Colecciónalos todos! - Collectionne-les tous!
 Hol sie dir alle! - Verzamel ze allemaal! - Collezionali tutti! - Colecione todos eles!

