

**MEGA
BLOKS**

HALO



97072

**Covert Ops: UNSC Wolverine • Covert Ops: Wolverine del CENU • Opérations secrètes: Wolverine du CSNU
Covert Ops: Wolverine CSNU • Covert Ops:CENU Wolverine • Verborgene Ops:RVN-Wolverine • Covert Ops: RVN-wolverine**

Covert Ops: UNSC Wolverine

The Covert Ops Wolverine is a highly maneuverable anti-air vehicle that combines the M260 Multiple Launch Rocket System with IR signature reduction and limited Active Camo technology. This technology allows the Covert Ops Wolverine and Hazop Spartan to ambush enemy targets undetected.

Covert Ops: CENU Wolverine

El Covert Ops Wolverine es un vehículo antiaéreo muy fácil de manejar que combina el sistema de lanzamiento de múltiples cohetes M260 con la reducción de la firma IR y la tecnología limitada de Camuflaje Activo. Esta tecnología le permite al Covert Ops Wolverine y al Hazop Spartan emboscar a los blancos enemigos sin ser detectados.

Opérations secrètes: Wolverine du CSNU

Le Wolverine Covert Ops est un véhicule antiaérien très agile combinant le système lance-roquettes M260, une signature IR réduite et la technologie de camouflage actif limité. Cette technologie permet au Wolverine Covert Ops et au Spartan Hazop de s'attaquer aux cibles ennemies sans être détectés.

Verborgene Ops:RVN-Wolverine

Der Verborgene Ops-Wolverine ist ein äußerst wendiges Anti-Luft-Fahrzeug, welches das M260 Mehrfachstart-Raketensystem mit der IR Signatur-Reduktion und begrenzter Aktiver Camo- Technologie kombiniert. Diese Technologie erlaubt es Verborgene Ops-Wolverine und Hazop Spartan, unerkant und aus dem Hinterhalt feindliche Ziele anzugreifen.

Covert Ops: RVN-wolverine

De Covert Ops Wolverine is een makkelijk te besturen luchtafweervoertuig en combineert het meervoudige M260-raketlanceersysteem met infrarood signatuurreductie en actieve- camouflagetechnologie. Met deze technologie kunnen de Covert Ops Wolverine en Hazop Spartan onopgemerkt vijandelijke doelen aanvallen.

Covert Ops: Wolverine CSNU

Il Covert Ops Wolverine è un veicolo anti-aereo ad alta manovrabilità che unisce il Sistema Lanciarazzi Multiplo M260 alla tecnologia di riduzione della segnatura IR e di limitata mimetizzazione attiva. Questa tecnologia permette al Covert Ops Wolverine e all'Hazop Spartan di tendere un'imboscata agli obiettivi nemici senza essere rilevati.

Covert Ops:CENU Wolverine

O Covert Ops Wolverine é um veículo antiaéreo altamente manobrável que combina o Sistema de Lançamento de Foguetes Múltiplos M260 com a redução de assinatura IR e tecnologia limitada Camuflagem Ativo. Esta tecnologia permite que o Covert Ops Wolverine e o Hazop Spartan façam emboscadas a alvos inimigos enquanto não detectados.



**MEGA
BLOKS**

HALO



Register for the Halo Bloks Brigade!
Apuntate a la brigada Halo Bloks!
Enrolez-vous dans la Brigade Halo Bloks!
Registrierte dich für die Halo-Bloks Brigade! • Schrijf je in voor de Halo Bloks Brigade!
Effetua la registrazione per la Brigata dei Blok Halo! • Regista-te para a Brigada Halo Bloks!

halo.megabloks.com

1x M1113ZD
2x AM18560F
2x AM01855F
6x MA03328F
6x MA03328ALH
5x AM17127ALH
2x AM16980F
2x MA17506F
2x MA15258ALH
1x MA1312ALH
2x MA1140F
2x MA1086ALH
2x AM16303F
2x AM17129ALH
2x AM17130ALH
2x MA04428F
8x MA04428ALH
2x AM17018F
2x AM11161F

2x AM11162F
9x MA09198F
2x MO22502X
2x MA022501F
2x MO22502ZD
10x MA022501ALH
1x MA07590ALH
1x MA09393ALH
5x MA09393F
5x AM17128ALH
2x MA04430F
12x MA04430ALH
2x AM16954F
2x AM16975F
3x AM09835ALH
5x AM18549ALH
3x AM09835F
1x MA03019F
2x MA1417F

2x MA1133F
2x MA09013F
2x MA15484F
4x MA1154F
1x AM02151AMC
3x MA03773F
2x MA03773ALH
2x AS9707202
4x MA0948ALH
2x MA18329ALH
2x MA18328ALH
8x AM02783F
3x MA1141F
6x MA09023F
4x MA1323ALH
2x AM17070F

2x MA1154ALH
2x MA1314F
10x MA1314ALH
4x MA03772F
4x MA03772ALH
2x MA04497ALH
12x MA09593ALH
1x MA1390ALH
1x AM09921ALH
2x AM16959F
8x MA09593F
2x MA01087ALH
4x MA01087F
6x MA09493F
9x MA09493ALH

3x MA09033F
2x AS9683317
6x MA09033ALH
2x AM16977MM
4x AM0317MM
1x AM15479ALH
1x AM15478ALH
1x AM16630ALH
2x AM16962ALH
2x AM16976ALH
2x AS9707207

1x AM16629ALH
1x AS9707205
1x AM03089F
1x MA1346F
2x MA09292F
7x MA1480ALH
9x MA1480F
1x MA1313F
1x AM04983ALH
8x AS9707204
4x MA08483ALH
1x AM03015F

1x AM07646F
1x MA09923ALH
1x MA09923F
3x AM04985F
4x MA1172F
1x AM09924F
1x AM18556ALH
2x AM16646F
1x S11163F



ix
L97072I

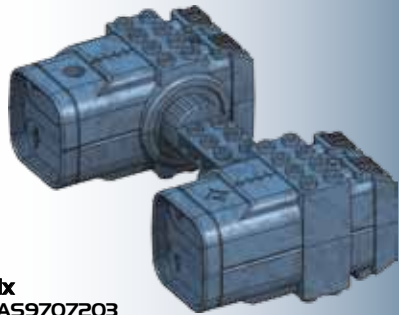

ix
AS9707203



ix
AM18222F



ix
AM18539F



ix
AS970720I

- EN Please read these instructions carefully before first use and keep them for future reference.
- ES Leer estas instrucciones cuidadosamente antes de la primera utilización y guardarlas para referencia futura.
- FR Il est recommandé de lire attentivement ce feuillet avant la première utilisation et de le conserver pour référence future.
- DE Die Gebrauchsanleitung bitte durchlesen und aufbewahren.
- NL Wij raden u aan deze handleiding zorgvuldig te lezen en te bewaren voor eventuele raadpleging op een later tijdstip.
- DA Vær venlig at læse disse instruktioner omhyggeligt inden ibrugtagning og opbevar dem til fremtidigt brug.
- EL Διαβάστε αυτές τις οδηγίες προσεκτικά πριν χρησιμοποιήσετε το προϊόν για πρώτη φορά και φυλάξτε τις για μελλοντική αναφορά.
- FI Lue nämä ohjeet huolellisesti ennen ensimmäistä käyttöä ja säilytä ne myöhempää tarvetta varten.
- IT Leggere le istruzioni prima di cominciare ad usare il gioco e conservarle per referenze future.
- NO Les disse instruksjonene nøye før første gangs bruk, og ta vare på dem for fremtidige oppslag.
- PT Leia as instruções antes do primeiro uso e guarde-as para futura referência.
- SV Läs noggrant igenom dessa instruktioner innan du använder produkten för första gången och spara dem för ev. framtida frågor.
- JA 初めてご使用になる前に、この説明書をよくお読みください。また、本書は将来いつでも参照できるように保管してください。
- ZH 请在初次使用前仔细阅读这些指示，并保留它们以便未来参考。
- AR يرجى قراءة هذه التعليمات بدقة قبل البدء بالاستعمال والاحتفاظ بها كمرجع للمستقبل.

- EN ⚠ WARNING :
CHOKING HAZARD. - Small parts.
Not for children under 3 years.
- ES ⚠ ADVERTENCIA :
RIESGO DE ASFIXIA. - Contiene piezas pequeñas.
No recomendado para niños menores de 3 años.
- FR ⚠ ATTENTION :
DANGER D'ÉTOUFFEMENT. - Présence de petits éléments.
Ne convient pas aux enfants de moins de 3 ans.
- DE ⚠ WARNUNG :
ERSTICKUNGSGEFAHR. - Enthält kleine Teile.
Nicht für Kinder unter 3 Jahren geeignet.
- NL ⚠ WAARSCHUWING :
VERSTIKKINGSGEVAAR. - Bevat kleine onderdelen.
Niet geschikt voor kinderen onder de 3 jaar.
- DA ⚠ ADVARSEL :
FARE FOR KVÆLNING. - Indeholder smådele.
Ikke til børn under 3 år.
- EL ⚠ ΠΡΟΕΙΔΟΠΟΙΗΣΗ :
ΚΙΝΔΥΝΟΣ ΠΝΙΓΜΟΥ. - Περιέχει μικρά αντικείμενα
Όχι για παιδιά κάτω των 3 ετών.
- FI ⚠ VAROITUS :
TUKEHTUMISVAARA. - Sisältää pieniä osia.
Ei alle 3-vuotiaille lapsille.
- IT ⚠ ATTENZIONE :
PERICOLO DI SOFFOCAMENTO. - Contiene piccole parti.
Non indicato per bambini sotto i 3 anni.

- NO ⚠ ADVARSEL :
KVELNINGSFARE. - Inneholder små deler.
Kun for barn over 3 år.
- PT ⚠ ATENÇÃO :
PERIGO DE ASFIXIA. - Contém peças pequenas.
Não é concebido para crianças de menos de 3 anos.
- SV ⚠ VARNING :
KVÄVNINGSRISK. - Innehåller små delar.
Inte för barn under 3 år.
- JA ⚠ 警告 :
のどにつまる危険 小さな部品が含まれています
3歳以下の子供には与えないで下さい。
- ZH ⚠ 警告 :
噎住危险。包含有小部件
不适合3岁以下的小孩玩。

AR ⚠ تحذير :
خطر الاختناق - قطع صغيرة.
غير صالحة للأطفال أقل من 3 سنوات.



© 2012 MICROSOFT CORPORATION. ALL RIGHTS RESERVED.
MICROSOFT, 343 INDUSTRIES, THE 343 INDUSTRIES LOGO, HALO,
THE HALO LOGO, XBOX, XBOX 360, AND THE XBOX LOGOS, ARE
TRADEMARKS OF THE MICROSOFT GROUP OF COMPANIES.

WARNING ! ACHTUNG ! VAROITUS ! ATENÇÃO ! 警告 !
ATTENTION ! WAARSCHUWING ! ΠΡΟΕΙΔΟΠΟΙΗΣΗ ! ADVARSEL ! 警告 !
ADVERTENCIA ! AVVERTENZA ! ADVARSEL ! VARNING ! تحذير !

0-3





1

2X 3X 4X

1 2 3

2

2X 2X 1X 1X

3

2X 1X 1X

4



6X

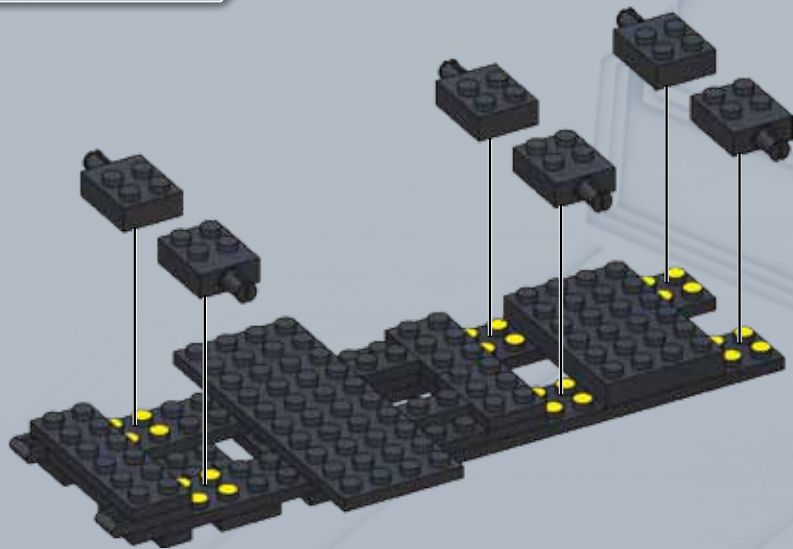

5



3X



2X



1X



1X

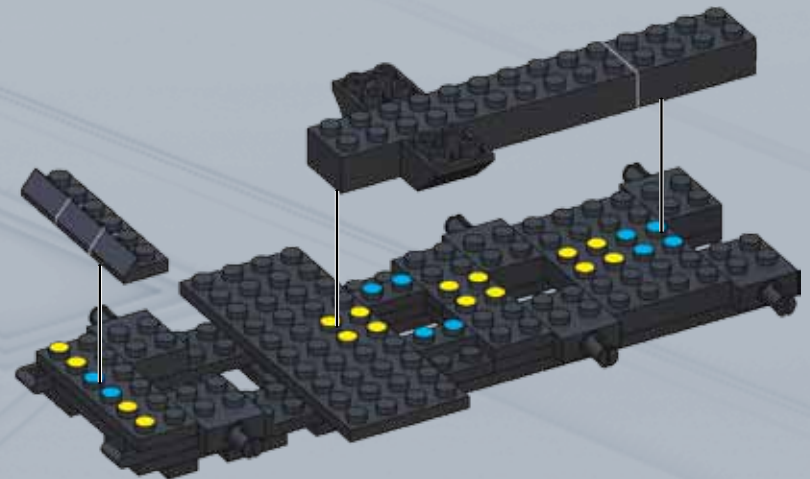

6



2X



2X



2X



2X



7

7

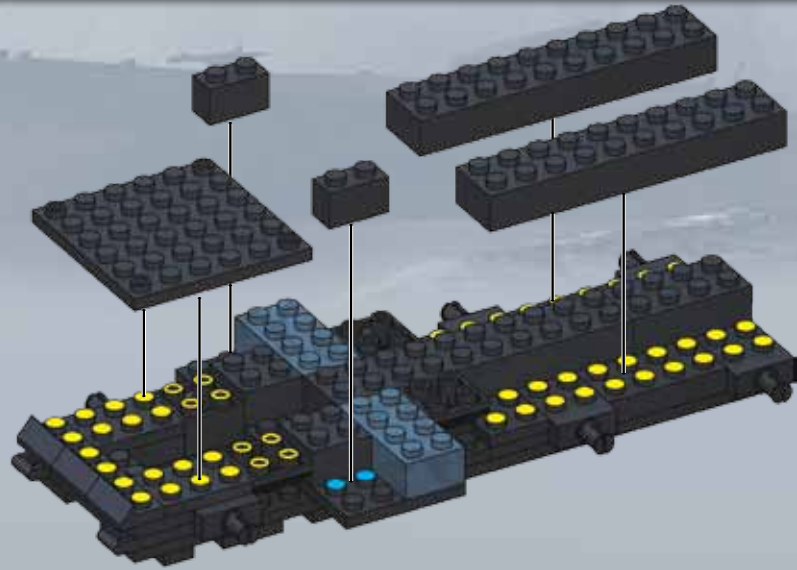
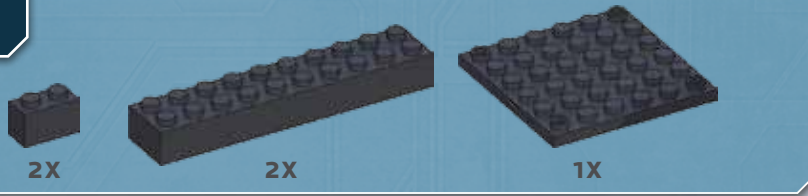

8

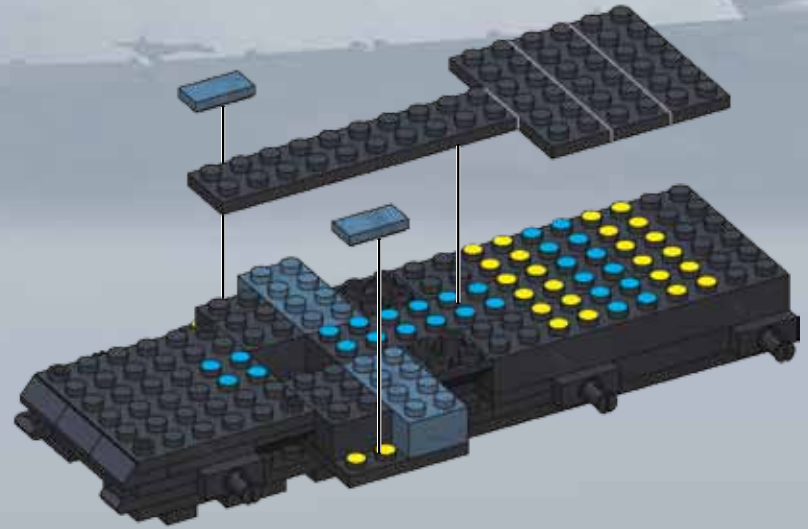

9

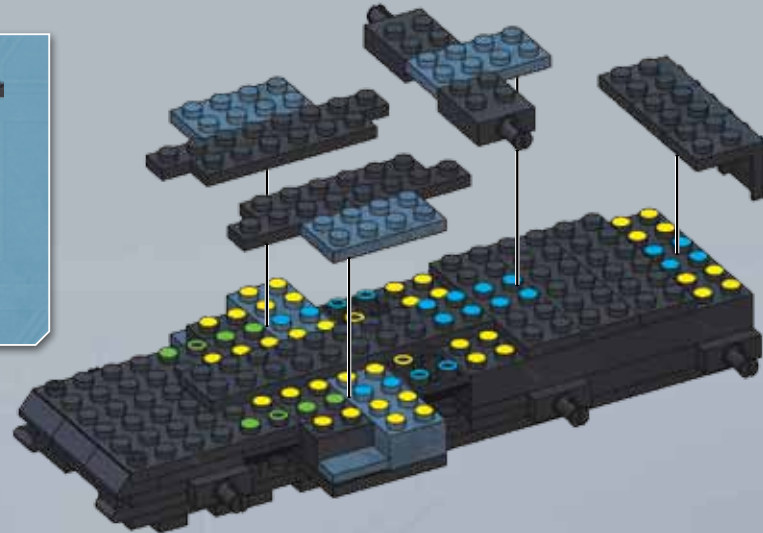

10

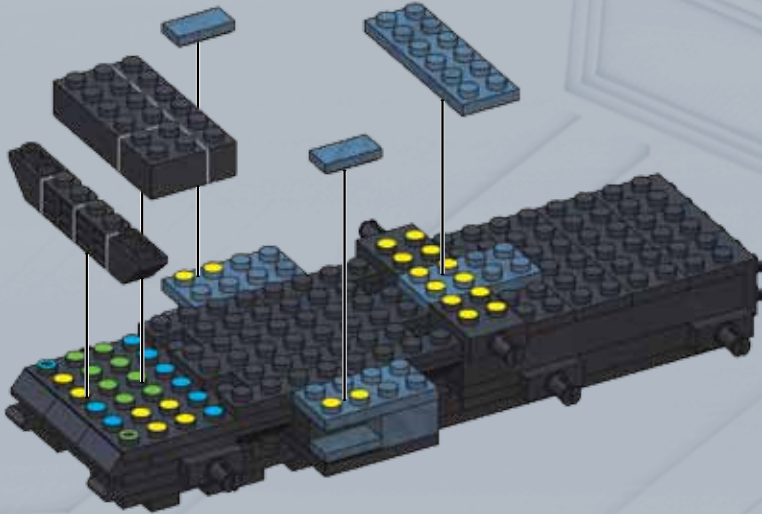
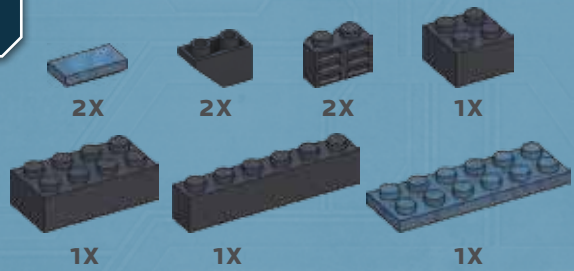

11

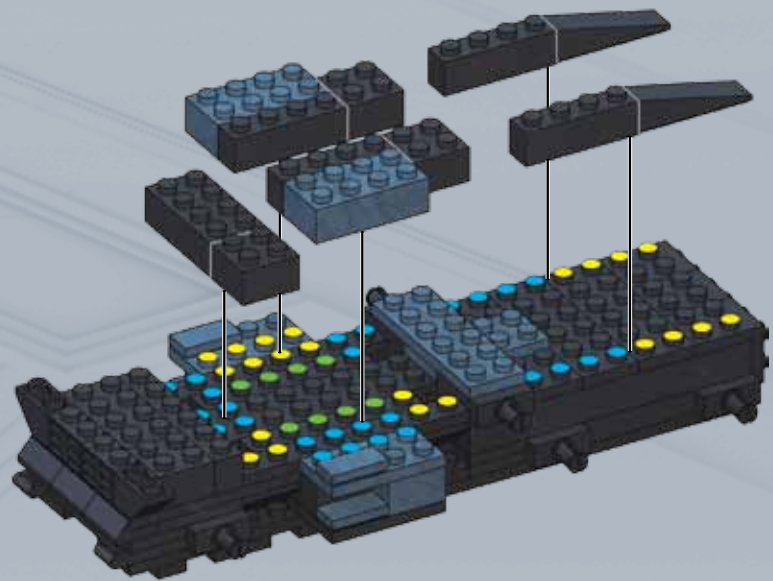

12

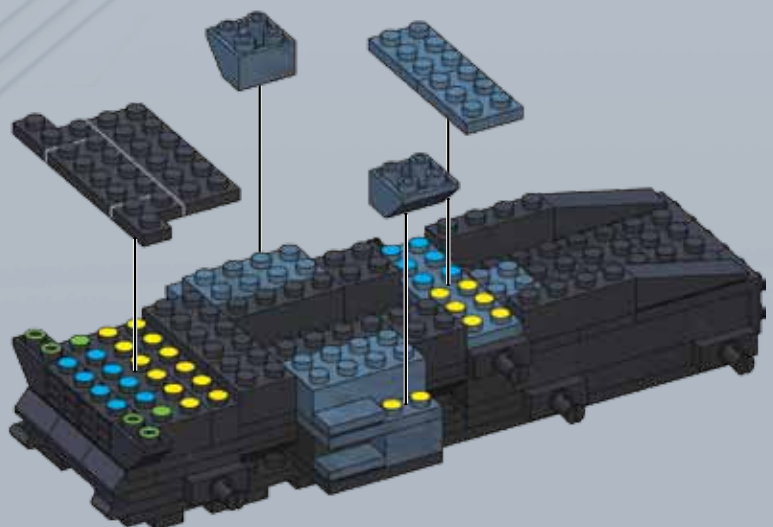

13



14



15

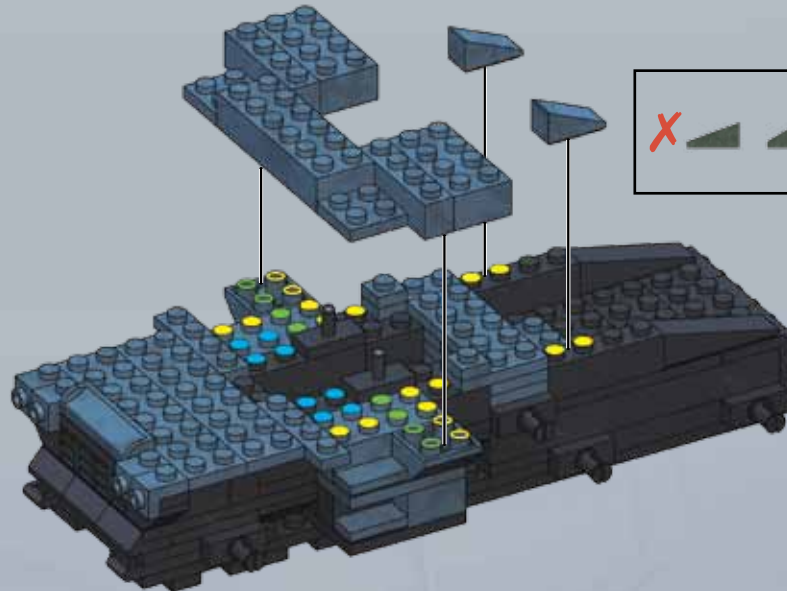

16

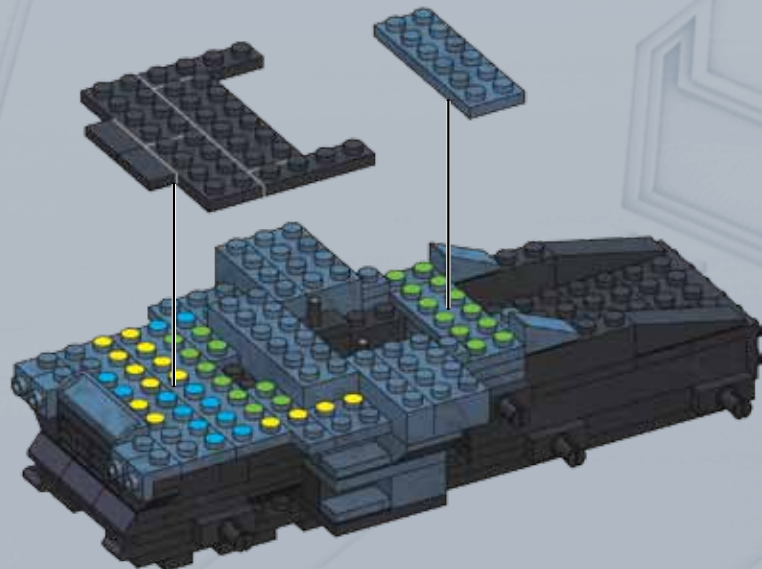

17

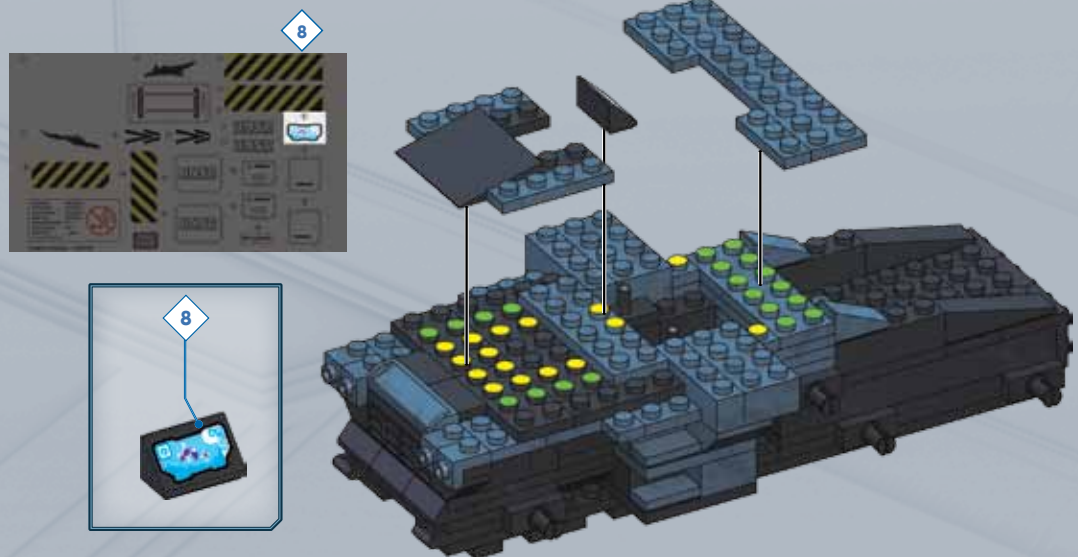

18

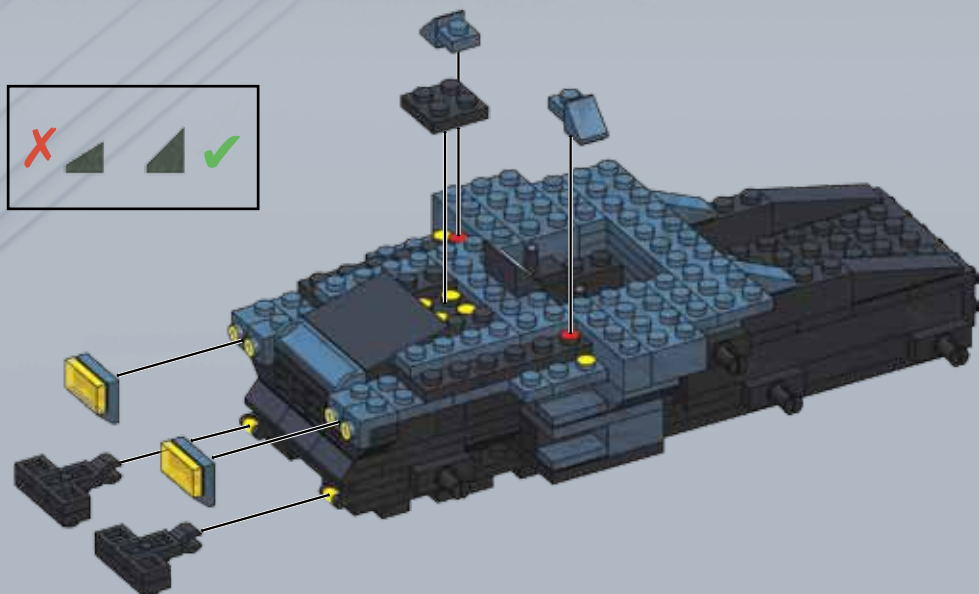
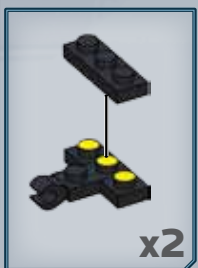

19

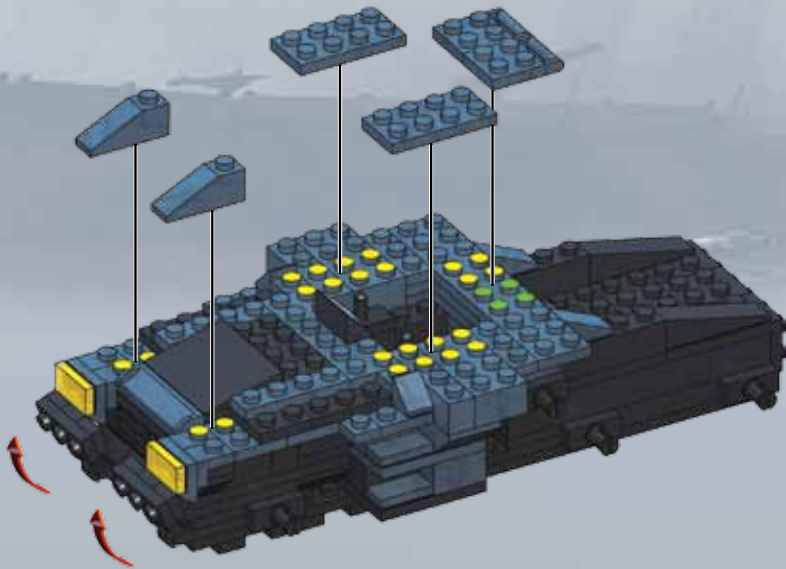

20

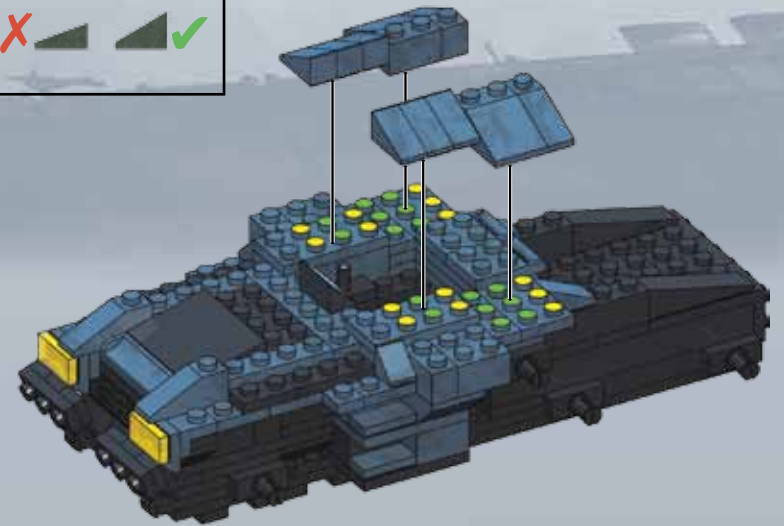

21



22

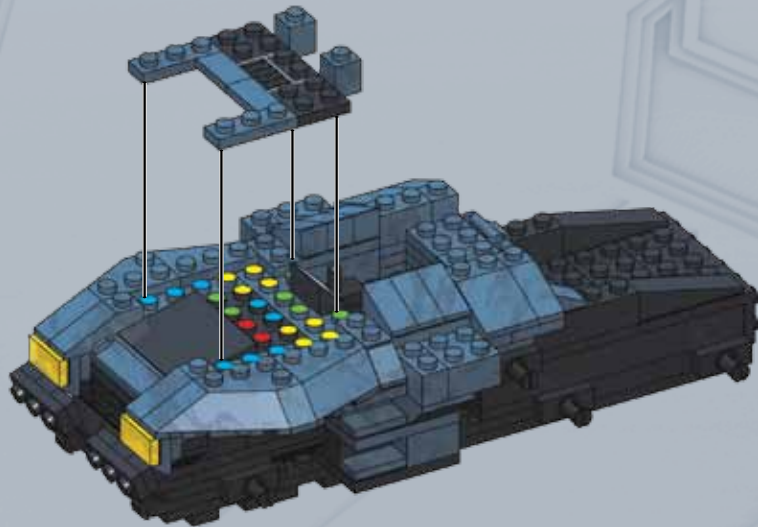

23

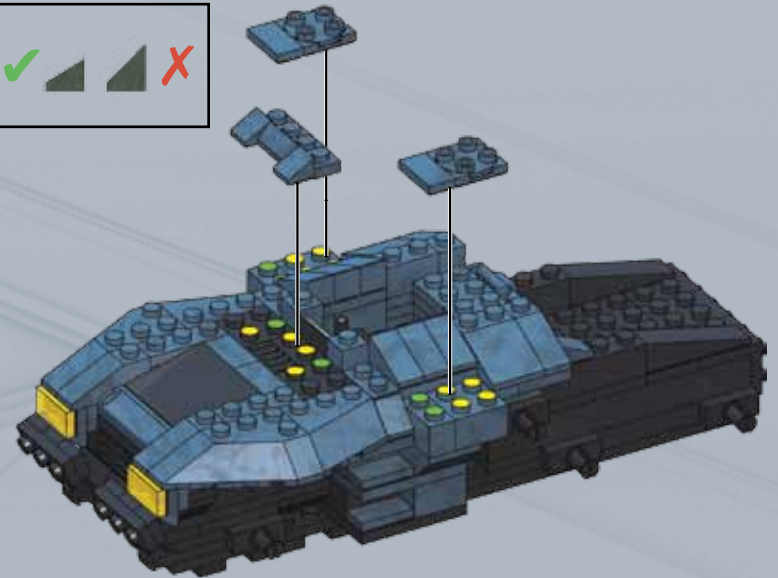

24

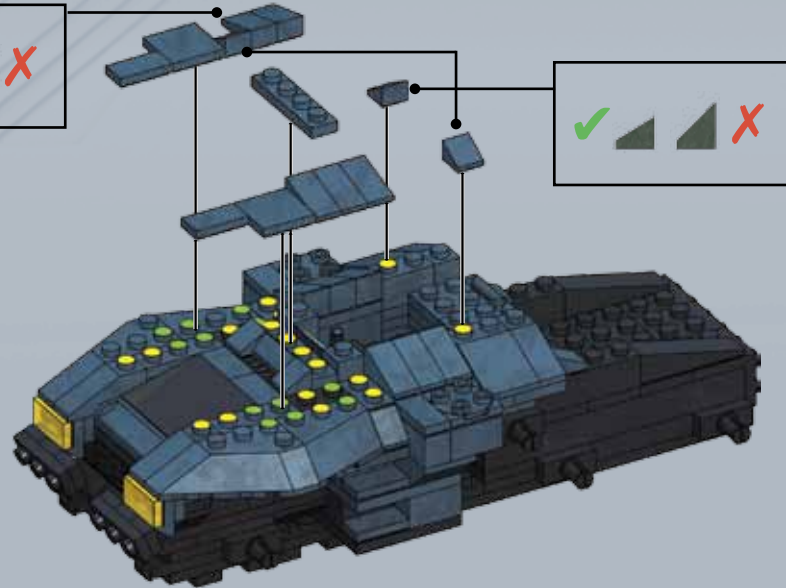

25

- 1X Yellow Pin
- 2X Black Pin
- 1X Grey Pin
- 1X Grey 1x4 Technic Brick
- 1X Grey 1x4 Technic Brick with Pin
- 1X Grey 1x4 Technic Brick with Pin
- 4X Grey 1x4 Technic Brick with Pin
- 2X Grey 1x4 Technic Brick with Pin
- 1X Grey 1x4 Technic Brick with Pin
- 3X Grey 1x4 Technic Brick with Pin
- 1X Grey 1x4 Technic Brick with Pin
- 1X Grey 1x4 Technic Brick with Pin
- 1X Grey Cable

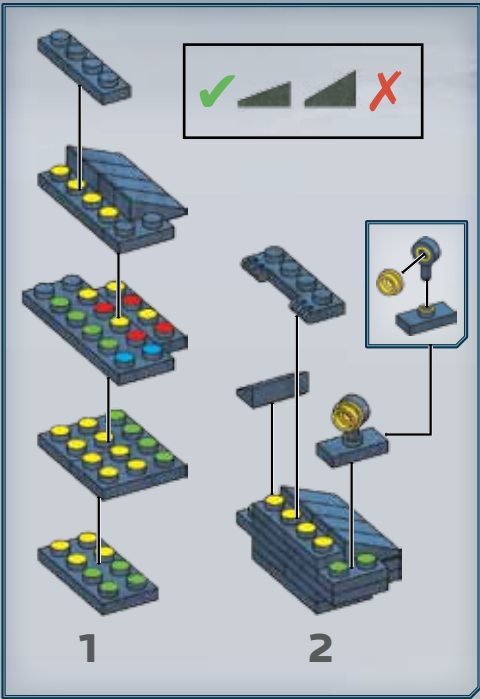

26

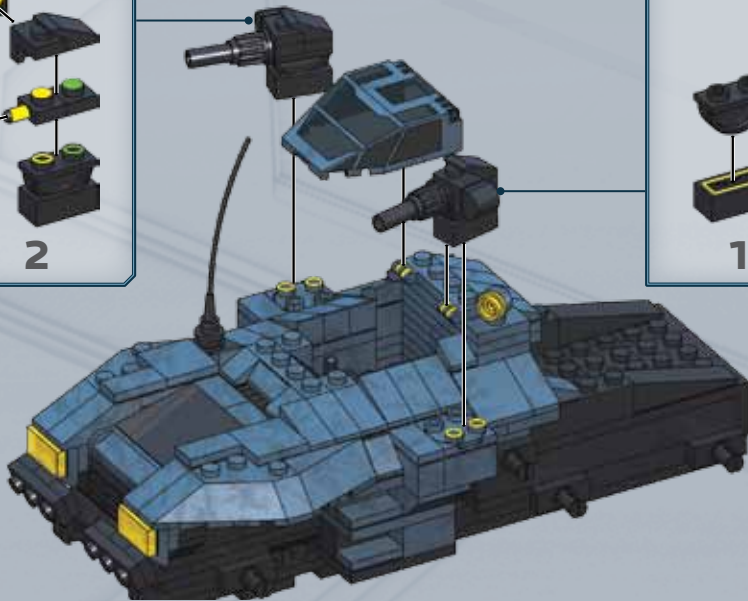
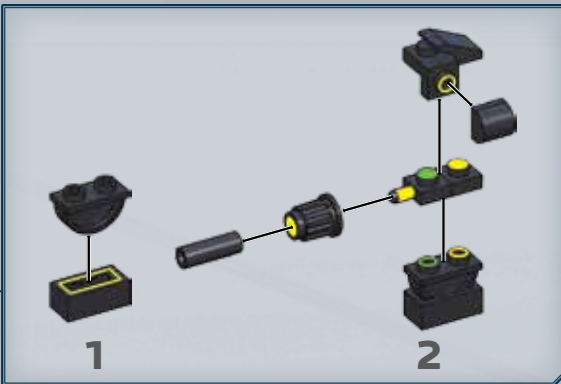
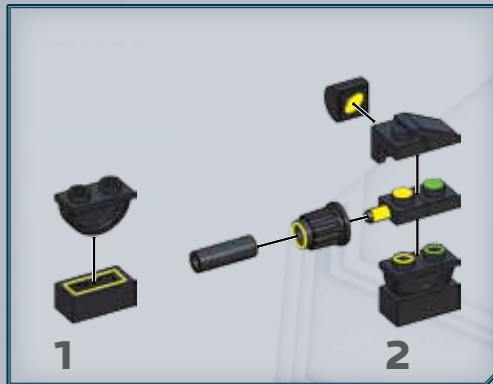

27

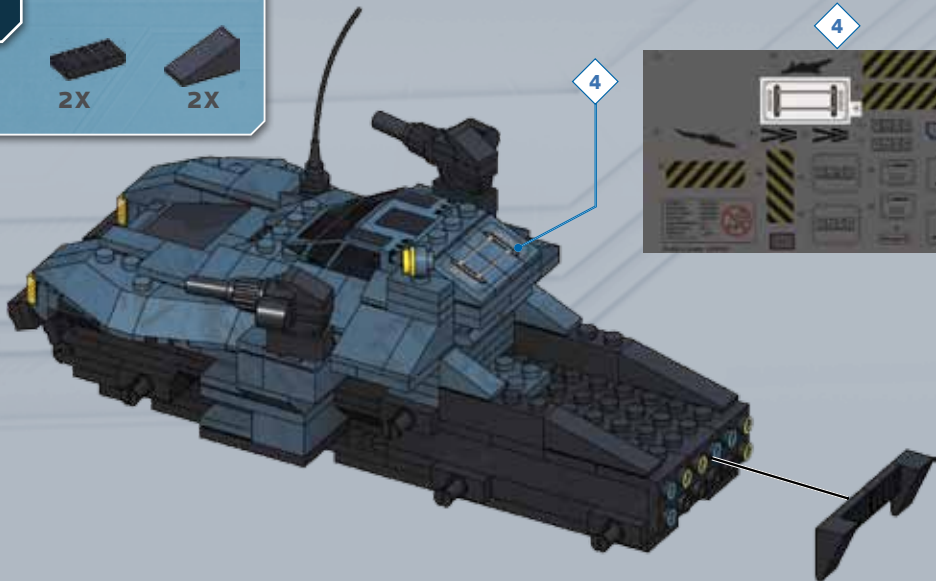

1

2

28

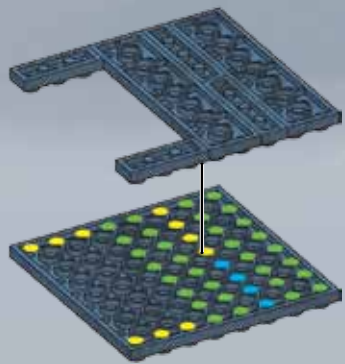
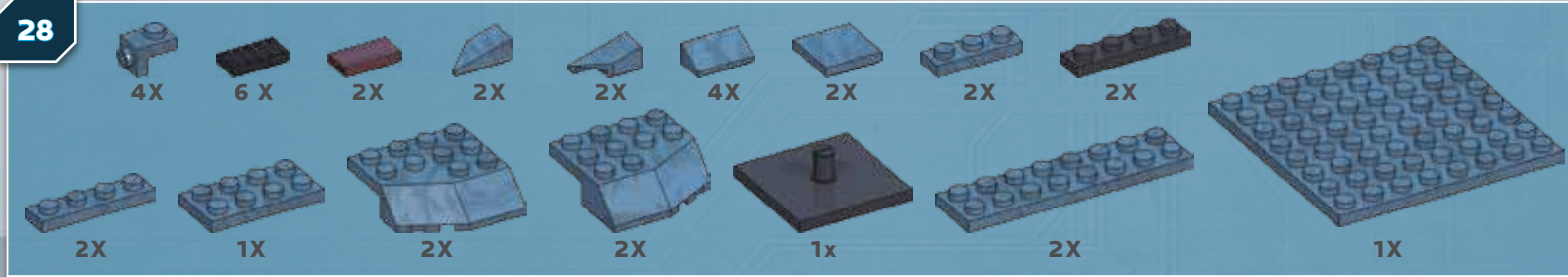

1

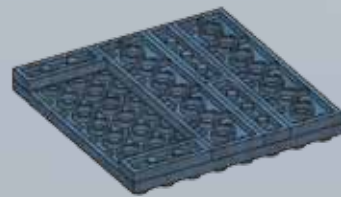

2

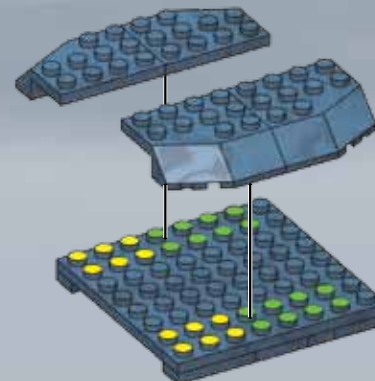

3



4

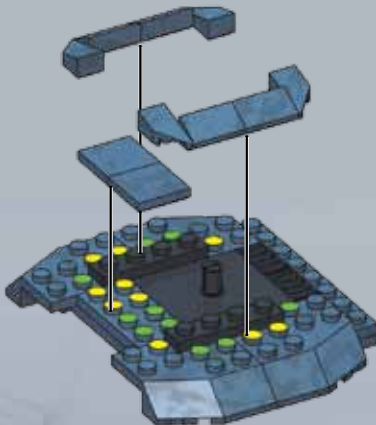

5

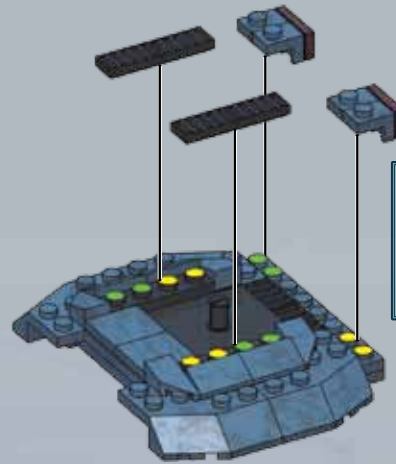

6

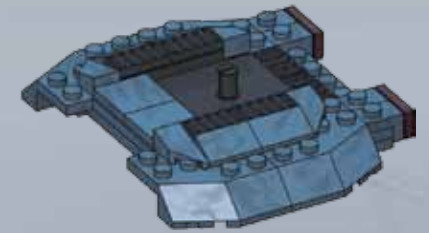

7

29

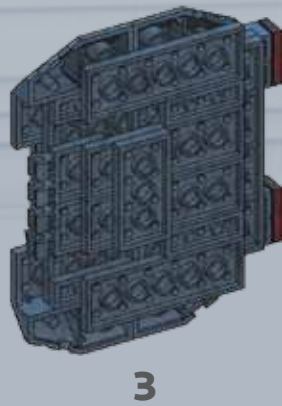
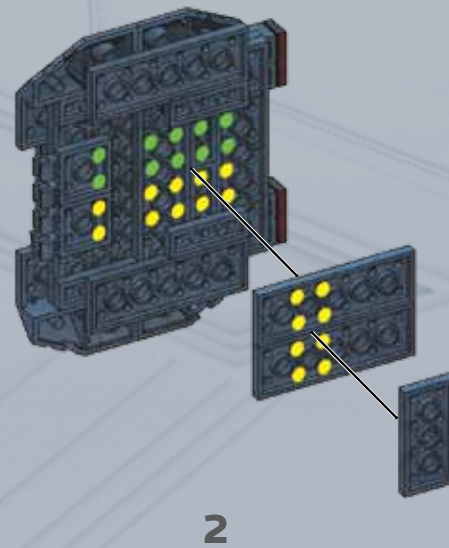
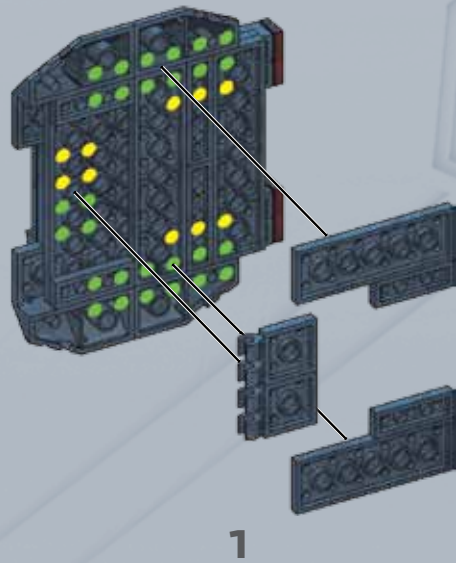

30

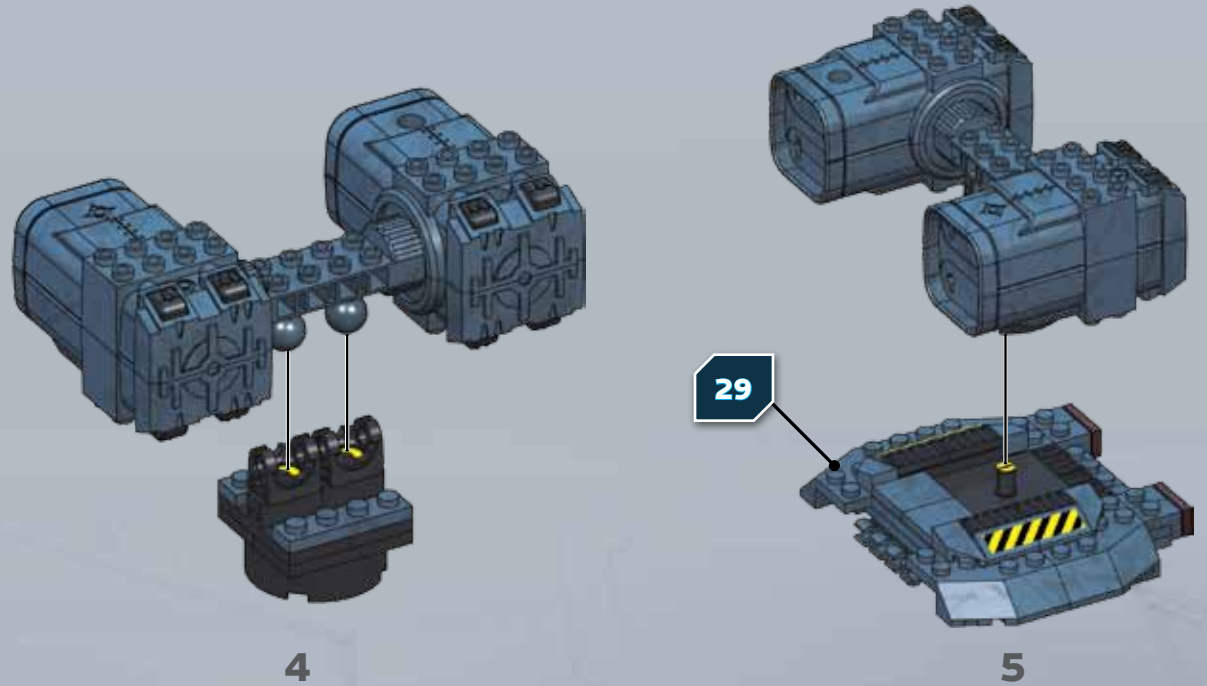
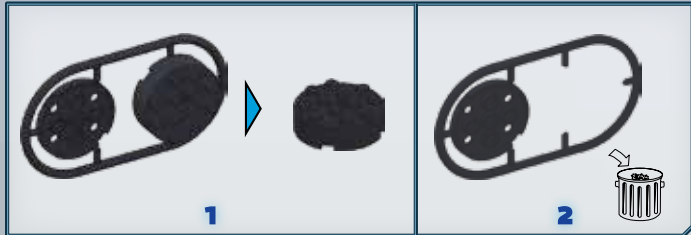
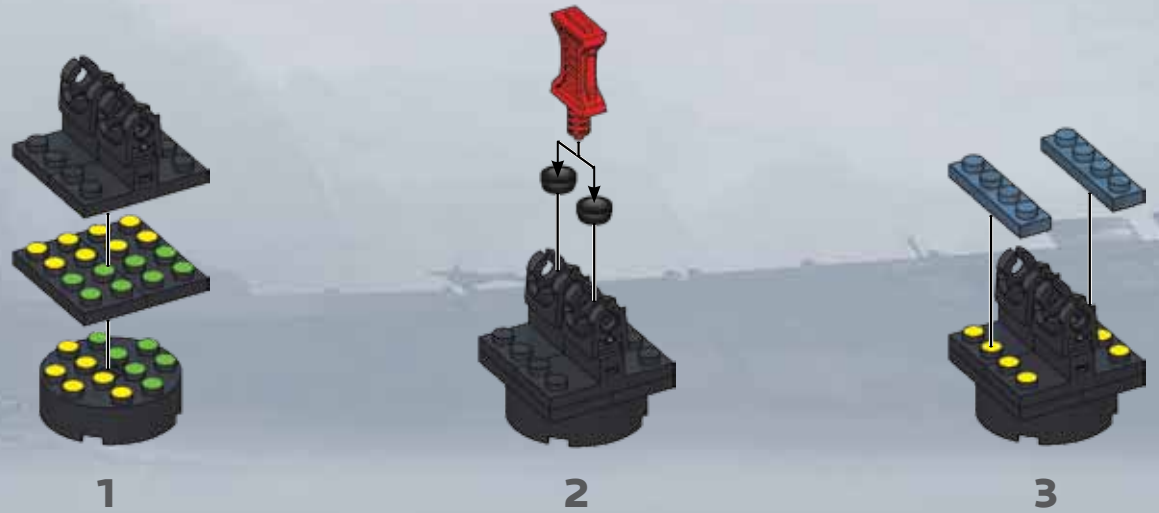
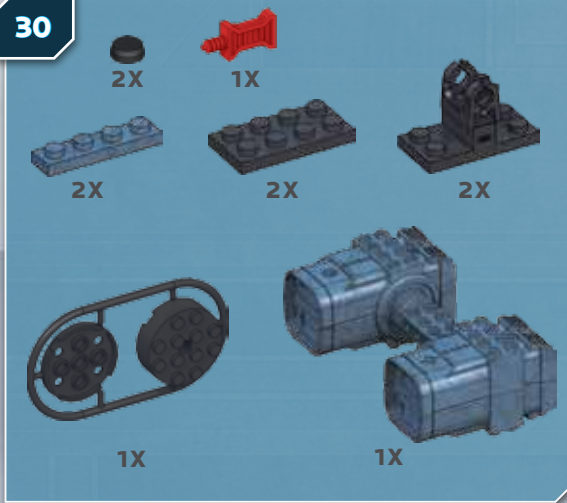

- EN** WARNING: Contains sharp points. Adult assembly required.
- ES** ADVERTENCIA: Contiene puntas muy agudas. Debe ser ensamblado por un adulto.
- FR** MISE EN GARDE: Contient des pièces à bout pointu. L'assemblage doit être fait par un adulte.
- DE** ACHTUNG: Enthält scharfe Kanten. Muss von Erwachsenen zusammengebaut werden.
- NL** WAARSCHUWING: Bevat scherpe punten. Vereist montage door volwassene.
- DA** ADVARSEL: Indeholder skarpe spidser. Montering af en voksen er obligatorisk.
- EL** ΠΡΟΕΙΔΟΠΟΙΗΣΗ: Περιέχει αιχμηρά σημεία. Απαιτείται σύνδεση από ενήλικους.
- FI** VAROITUS: Sisältää teräviä osia. Kokoamiseen tarvitaan aikuinen.
- IT** ATTENZIONE: Contiene punte affilate. Deve essere montato da un adulto.
- NO** ADVARSEL: Spisse deler. Må settes sammen av voksne.
- PT** ADVERTENCIA: Contém pontas agudas. Requer montagem por adultos.
- SV** VARNING: Innehåller vassa spetsar. Bör monteras av en vuxen.
- JA** 警告: 先の尖ったものが含まれています。組立は大人がしてください。
- ZH** 警告: 含有尖刺。需由成人組裝。
- AR** تحذير: تحتوي على حواف حادة. يلزم أن يتم التجميع بمعرفة شخص بالغ.

31

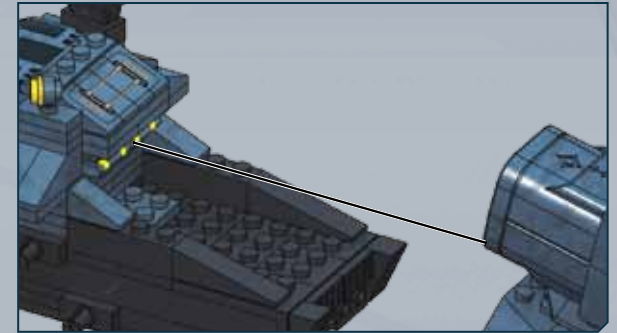

27



32



2X

4X

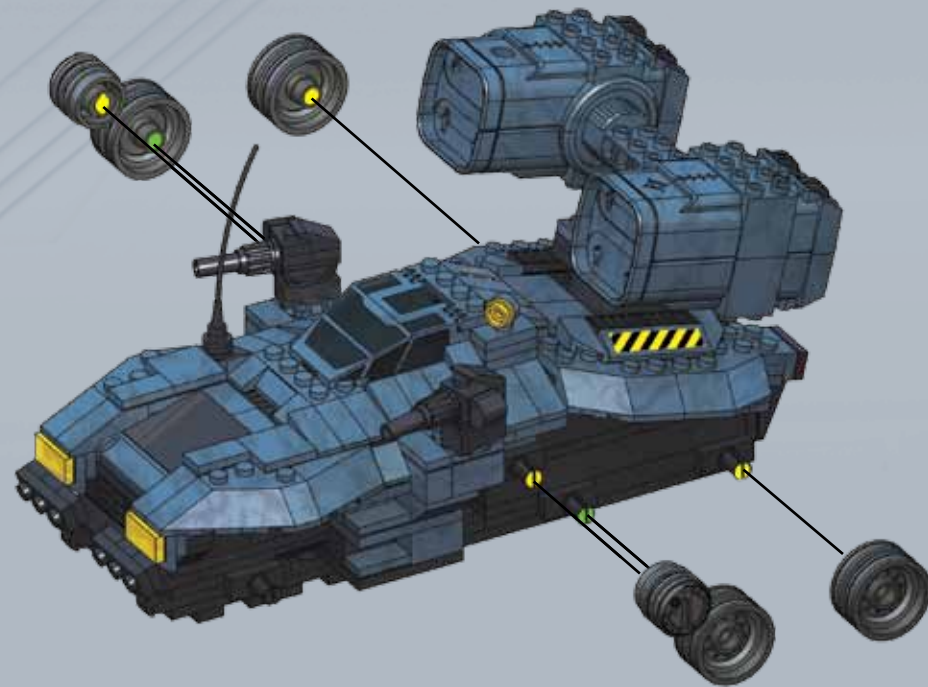

19

32



2X



2X



32



8X

click

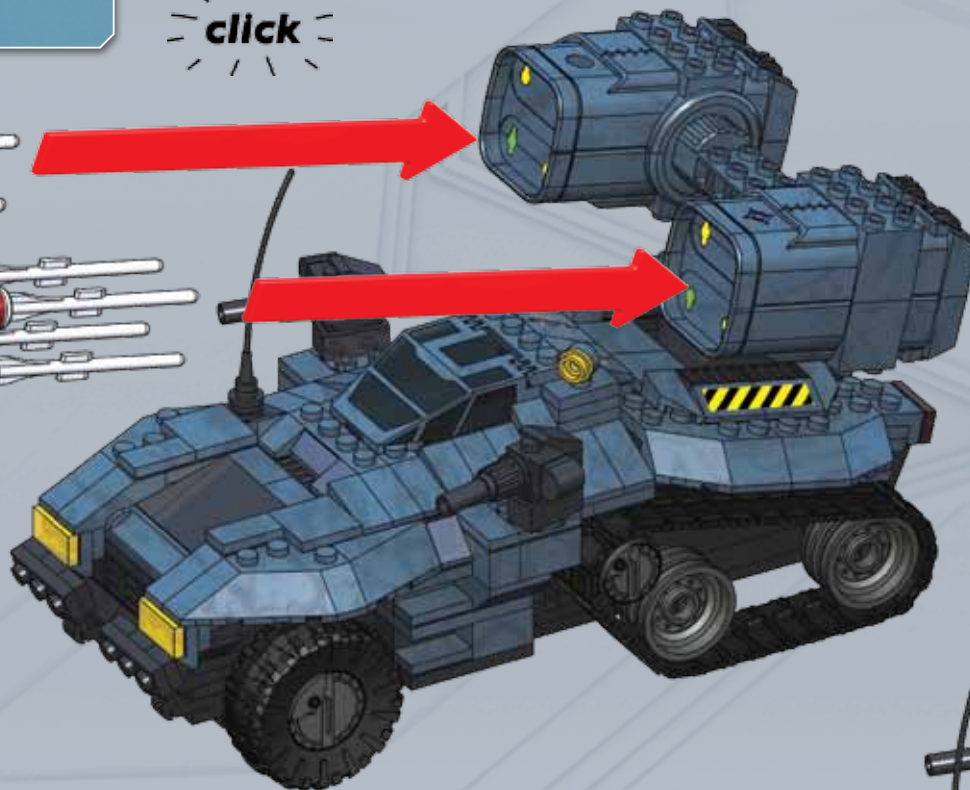
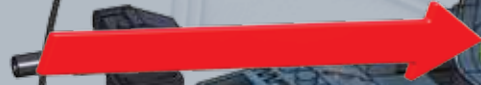
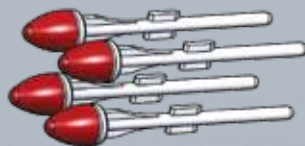
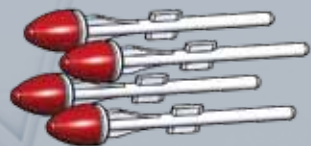

1



2

21



- EN CAUTION ! Do not aim at eyes or face.
- ES ¡ ADVERTENCIA ! NO dirigir nunca los proyectiles hacia los ojos o la cara.
- FR ATTENTION ! Ne pas viser les yeux ou le visage.
- DE VORSICHT ! Nicht auf das Gesicht oder die Augen richten.
- NL LET OP ! Niet op ogen of gezicht richten.
- DA ADVARSEL ! Peg ikke i retning af øjne eller ansigt.
- EL ΠΡΟΣΟΧΗ ! Να μην σκοπεύετε προς τα μάτια ή το πρόσωπο.
- FI VARO ! Älä tähtää silmiin tai kasvoihin.
- IT Attenzione ! Non puntare verso gli occhi o il viso.
- NO FORSIKTIG ! Sikt ikke mot øyne eller ansikt.
- PT ATENÇÃO ! Não apontar para os olhos ou o rosto.
- SV VAR FÖRSIKTIG ! Rikta inte med ögon eller ansikte.
- JA 注意！目や顔に使用しないで下さい。
- ZH 警告！不要对准眼睛或脸。
- AR تنبيه ! لا توجه للعينين أو الوجه

Use only the projectiles included with this toy.
 Utilizar solamente los proyectiles incluidos con el juguete.
 Utiliser seulement les projectiles fournis avec le jouet.
 Nur die mit dem Spielzeug mitgelieferten Projektile verwenden.
 Alleen de met het speelgoed bijgeleverde projectielen gebruiken.
 Utilizzare soltanto i proiettili forniti con questo giocattolo.
 Usar somente os projéteis incluídos com este brinquedo.
 استخدم فقط القذيفة المرافقة لهذه اللعبة

COVERT OPS: UNSC WOLVERINE

The Covert Ops Wolverine is a highly maneuverable anti-air vehicle that combines the M260 Multiple Launch Rocket System with IR signature reduction and limited Active Camo technology. This technology allows the Covert Ops Wolverine and Hazop Spartan to ambush enemy targets undetected.

Covert Ops: CENU Wolverine

El Covert Ops Wolverine es un vehículo anti-aéreo muy fácil de manejar que combina el sistema de lanzamiento de múltiples cohetes M260 con la reducción de la firma IR y la tecnología limitada de Camuflaje Activo. Esta tecnología le permite al Covert Ops Wolverine y al Hazop Spartan emboscar a los blancos enemigos sin ser detectados.

Opérations secrètes: Wolverine du CSNU

Le Wolverine Covert Ops est un véhicule anti-aérien très agile combinant le système lance-roquettes M260, une signature IR réduite et la technologie de camouflage actif limité. Cette technologie permet au Wolverine Covert Ops et au Spartan Hazop de s'attaquer aux cibles ennemies sans être détectés.

Verborgene Ops:RVN-Wolverine

Der Verborgene Ops-Wolverine ist ein äußerst wendiges Anti-Luft-Fahrzeug, welches das M260 Mehrfachstart-Raketensystem mit der IR Signatur-Reduktion und begrenzter Aktiver Camo-Technologie kombiniert. Diese Technologie erlaubt es Verborgene Ops-Wolverine und Hazop Spartan, unerkannt und aus dem Hinterhalt feindliche Ziele anzugreifen.

Covert Ops: RVN-wolverine

De Covert Ops Wolverine is een makkelijk te besturen luchtvaartuig en combineert het meervoudige M260 raketlanceersysteem met infrarood signatuurreductie en actieve-camuflage-technologie. Met deze technologie kunnen de Covert Ops Wolverine en Hazop Spartan onopgemerkt vijandelijke doelen aanvallen.

Covert Ops: Wolverine CSNU

Il Covert Ops Wolverine è un veicolo anti-aereo ad alta manovrabilità che unisce il Sistema Lanciarazzi Multiplo M260 alla tecnologia di riduzione della segnatura IR e di limitata mimetizzazione attiva. Questa tecnologia permette al Covert Ops Wolverine e all'Hazop Spartan di tendere un'imboscata agli obiettivi nemici senza essere rilevati.

Covert Ops:CENU Wolverine

O Covert Ops Wolverine é um veículo anti-aéreo altamente manobrável que combina o Sistema de Lançamento de Foguetes Múltiplos M260 com a redução de assinatura IR e tecnologia limitada Camuflagem Ativa. Esta tecnologia permite que o Covert Ops Wolverine e o Hazop Spartan façam emboscadas a alvos inimigos enquanto não detectados.



UNSC SPARTAN HAZOP

- Spartan Hazop del CENU
- Spartan Hazop du CSNU
- RVN Hazop Spartan
- RVN Hazop Spartan
- Spartan Hazop CSNU
- Hazop Spartan do CENU

8 LAUNCHERS!
18 LANZADORES!
8 LANCE-MISSILES!
8 STAKTERS!
8 LANCEBIBELSLANES!
8 LANCINGHELD!
8 LANCINGHELD!



COVERT OPS CAMO BLOK!
BLOK CAMO COVERT OPS!
BLOK CAMOUFLAGE DES
OPERATIONS SECRETES!
VERBORGENE OPS CAMO BLOK!
COVERT OPS-CAMOUFLAGEBLOK!
CAMO BLOK COVERT OPS!
COVERT OPS CAMO BLOK!



UNSC INTEL



Collect them all! - ¡Colecciónalos todos! - Collectionne-les tous!
Moi sie dir alle! - Verzamel ze allemaal! - Collezionali tutti! - Colecciona todos etes!



97071

97070



© 2012, MEGA Brands Inc.
© and ™ denote trademarks of MEGA Brands Inc. Printed in Canada D970721A