



# LOADER



**! WARNING:**  
CHOKING HAZARD - Small Parts.  
Not for children under 3 years

**MEGA BLOKS** AGES/ANOS  
**7+**



Color chart.

Charte de couleurs.

Cuadro cromático.

Diagramma colorimetrico.

Färgtabell.

Kleurkaart.

カラーチャート

彩圖



Active step / Étape active / Etapa activa / Istruzione attuale  
Aktiv skede / Folgende stap / 次 の 部 品 の 取 付 順

Previous step / Étape précédente / Etapa precedente / Istruzione precedente  
Følgende skede / Yorige stap / 前 の 部 品 の 取 付 順



Adult assistance is required. / L'aide d'un adulte est requise. / Necesita ayuda de un adulto. / L'aiuto di un adulto è richiesto. /  
Hjälp av en vuxen är nödvändigt. / Hulp van volwassenen is gewenst. / 大人の助けが必要です。 / معونة البالغين مطلوبة / 小童伴有窒息危险。

**WARNING:**

Choking hazard - Small parts.  
Not for children under 3 years.

**AVERTISSEMENT:**

Risque de suffocation. Ne convient pas à un enfant de moins de 3 ans - contient de petits éléments.

**ADVERTENCIA:**

Peligro de asfixia. No recomendado para niños menores de 3 años - contiene piezas pequeñas.

**AVVERTENZA:**

Rischio di soffocamento. Non adatta ad un bambino di età minore ai 36 mesi. Contiene parti piccole - non ingerire.

**WARNING:**

Risk for kvävning. Ikke egnet til barn under 3 år - inneholder smådelar.

**WAARSCHUWING:**

Stikgevaar. Niet geschikt voor kinderen onder 3 jaar - i.v.m. kleine onderdelen.

**注意:**

飲み込まないでください。  
小さい部品があるため、  
3歳以下の幼児には  
与えないでください。

⚠️ 不適于三岁以下儿童。

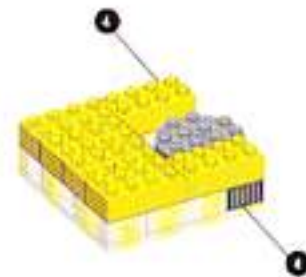
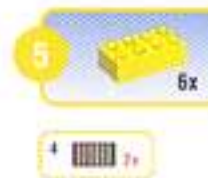
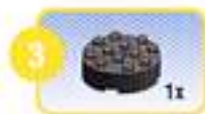
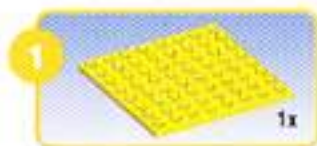

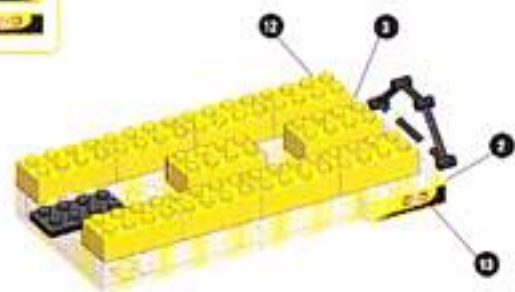
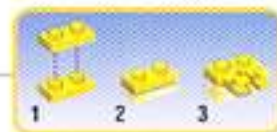
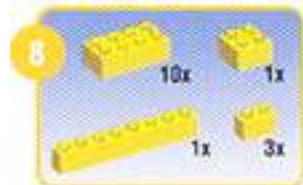
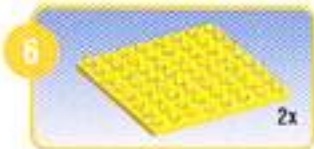

11

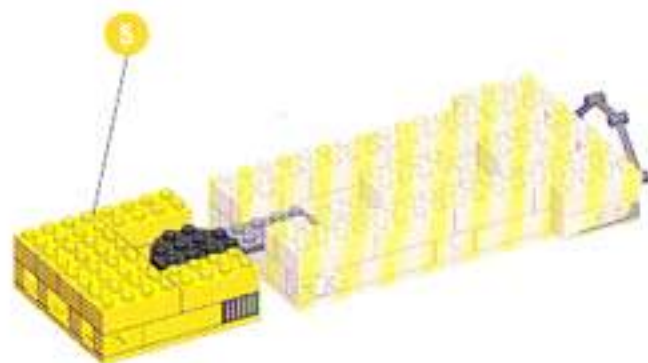



Active step / Étape active / Etapa activa / Istruzione attuale  
 Aktiv skede / Folgende stap / 現在の手順 / 現段階

Previous step / Étape précédente / Etapa precedente / Istruzione precedente  
 Föregående skede / Vorige stap / 以前の手順 / 前段階

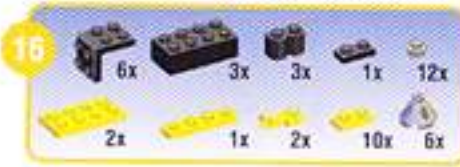
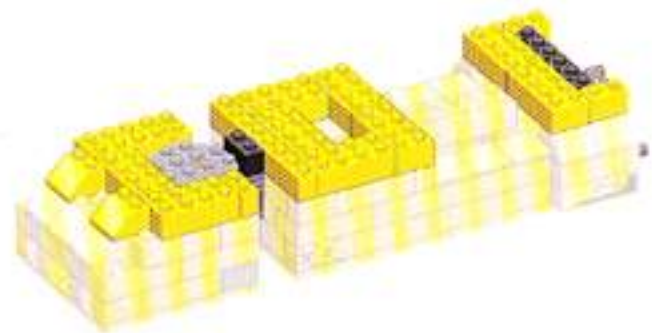
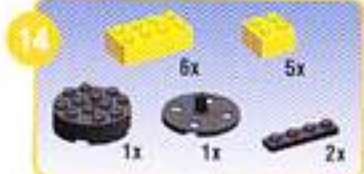
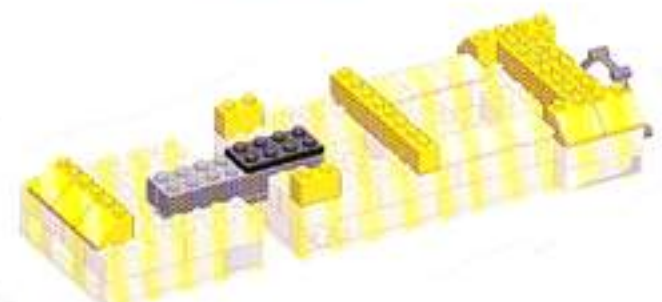
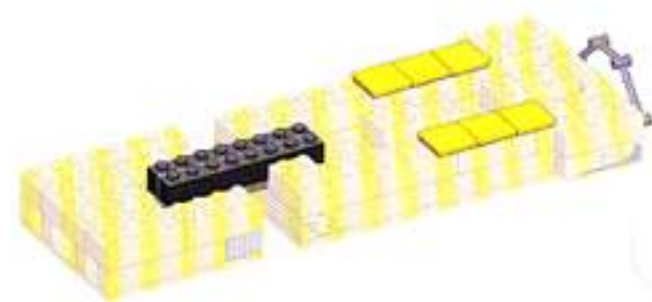

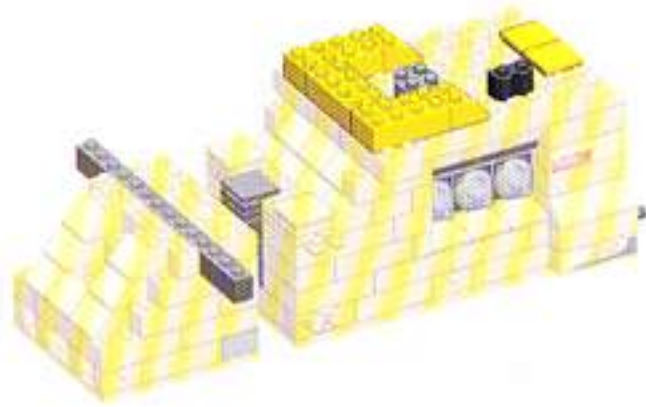
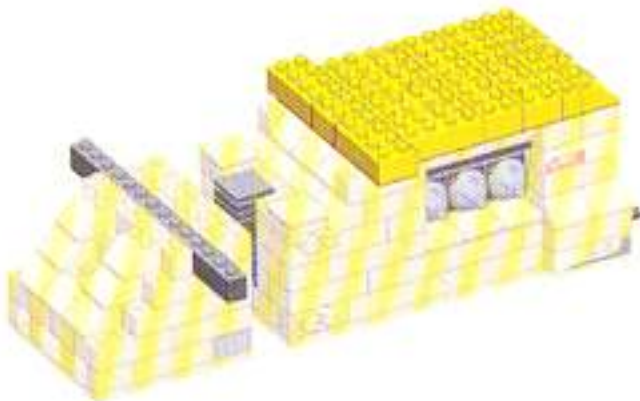
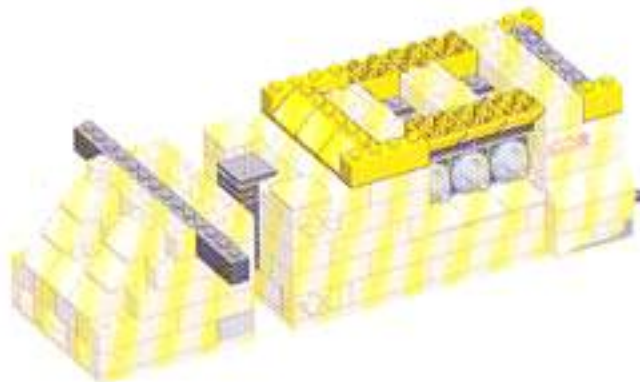
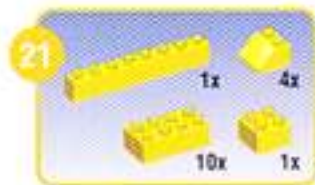
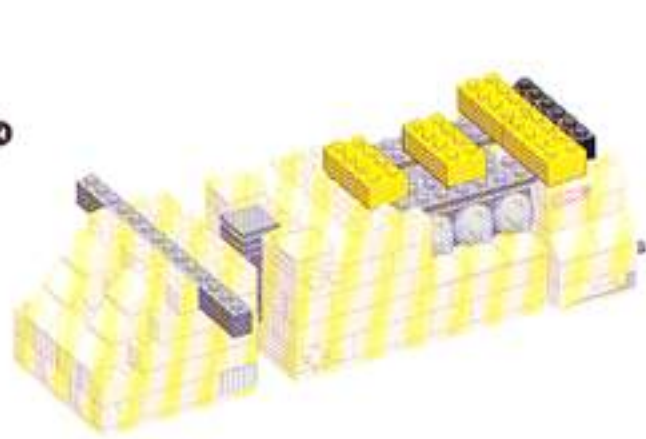
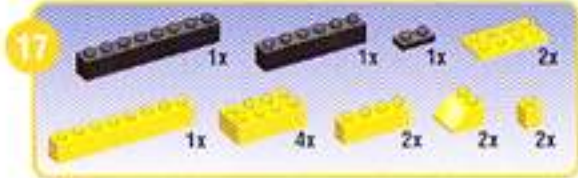



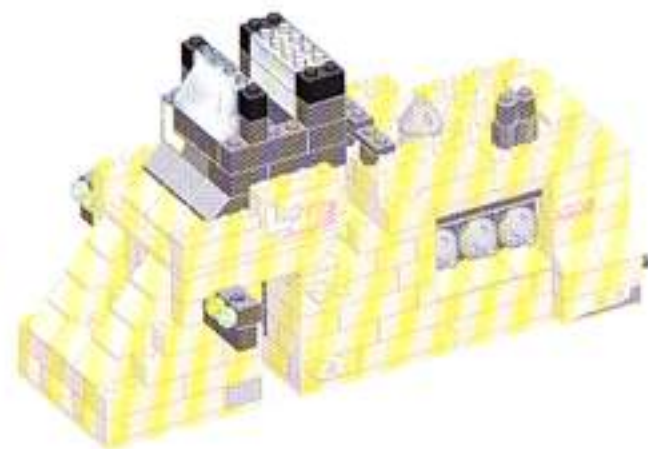
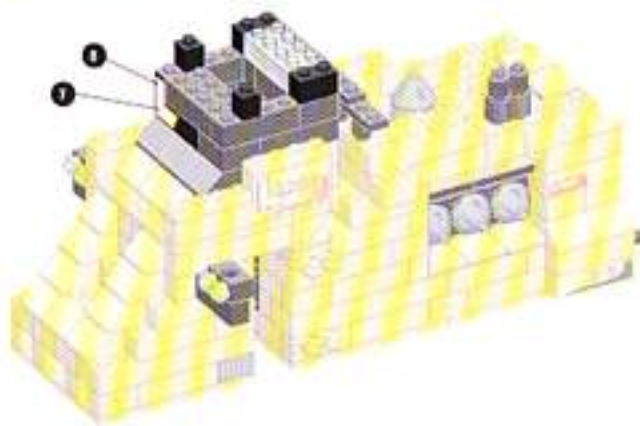
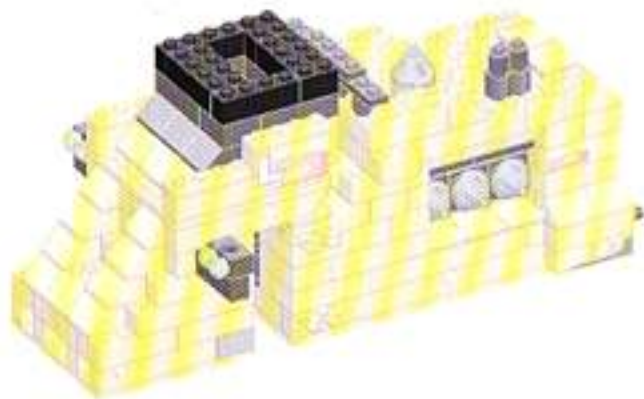
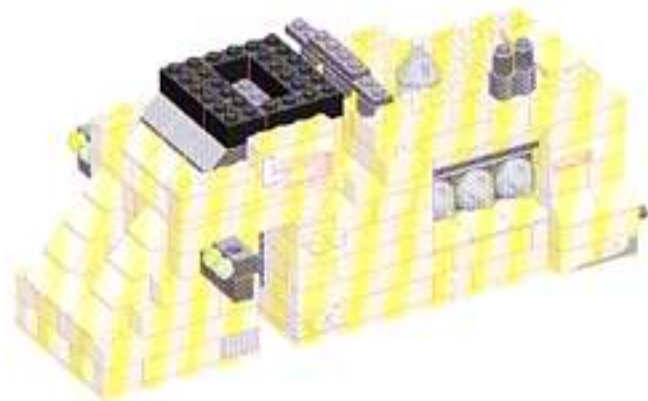
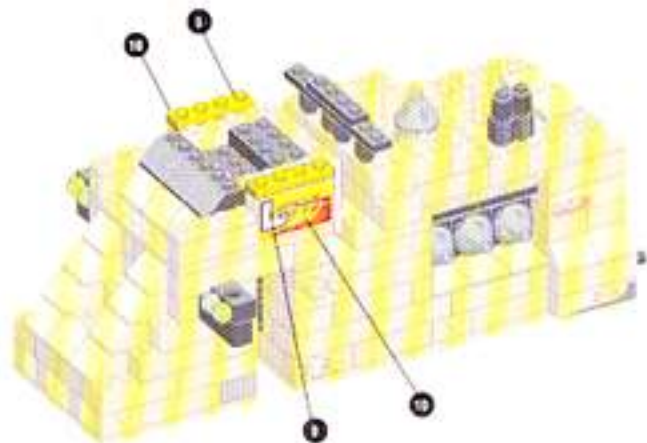
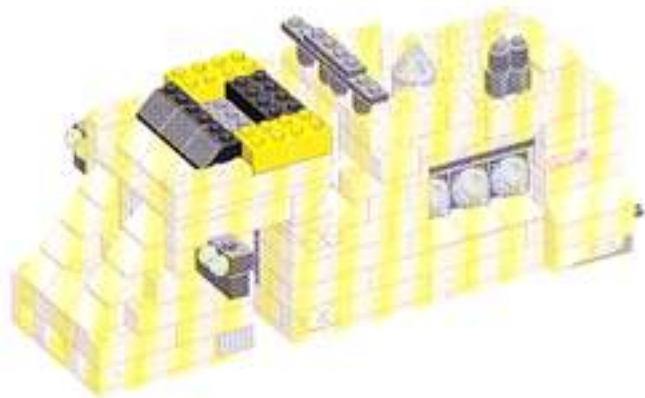



Active step / Étape active / Etapa activa / Istruzione attuale  
 Aktiv skede / Folgende stap / 元元步非端 / 元元步

Previous step / Étape précédente / Etapa precedente / Istruzione precedente  
 Føregående skede / Vorige stap / 元元步非端 / 元元步



33



34



35



36





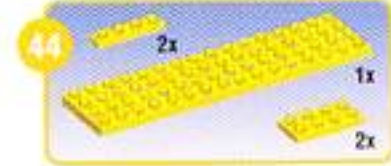
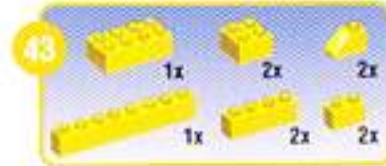
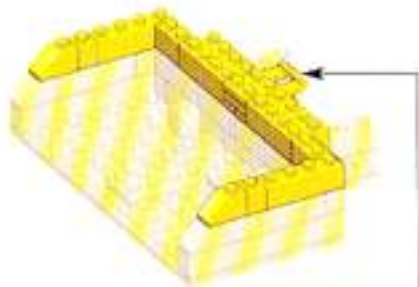
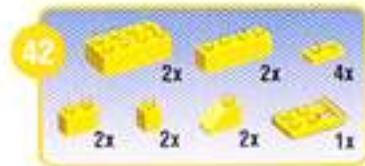
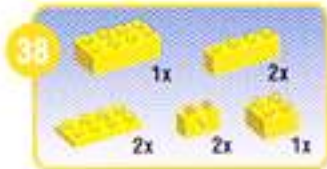



Active step / Étape active / Etapa activa / Istruzione attuale  
 Aktiv skede / Folgende stap / 后续的步骤 / 后续步骤

Previous step / Étape précédente / Etapa precedente / Istruzione precedente  
 Föregående skede / Yorige stap / 前面的步骤 / 前面的步骤



45

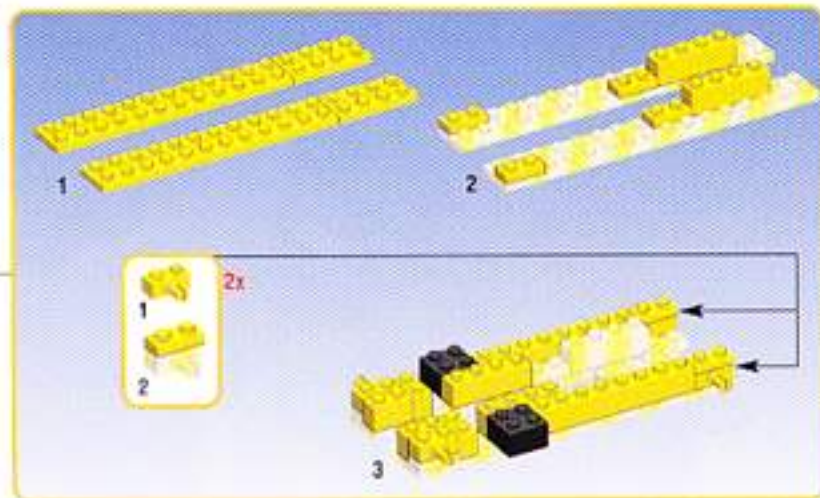

46



47

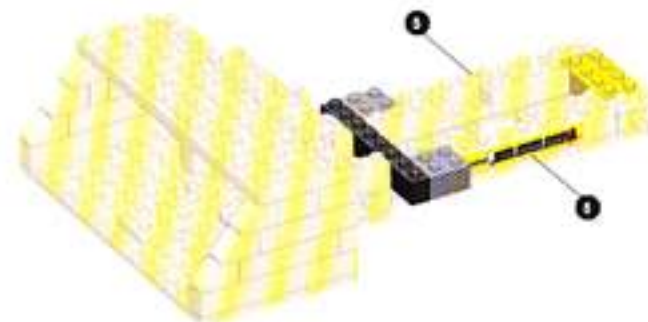
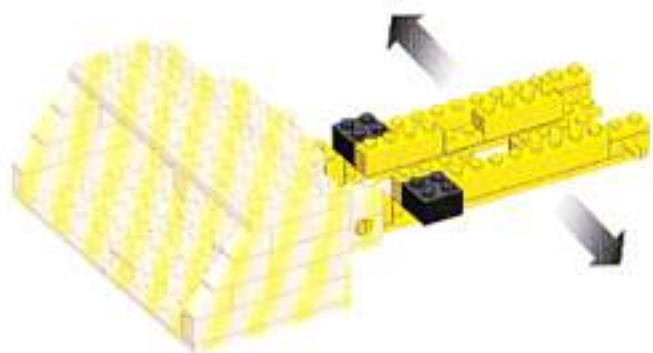

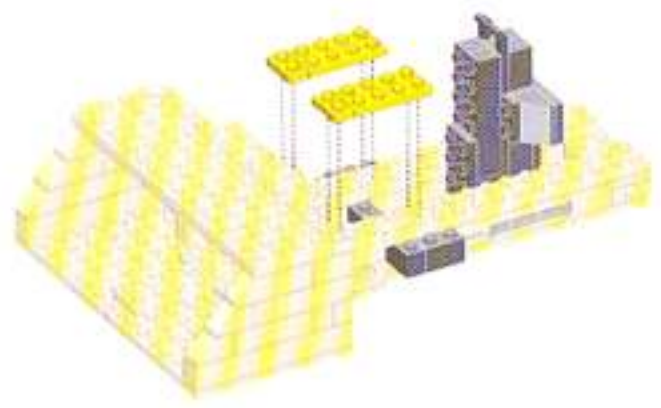
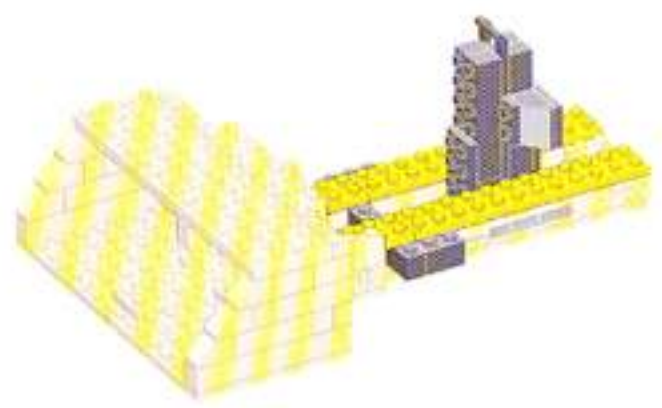
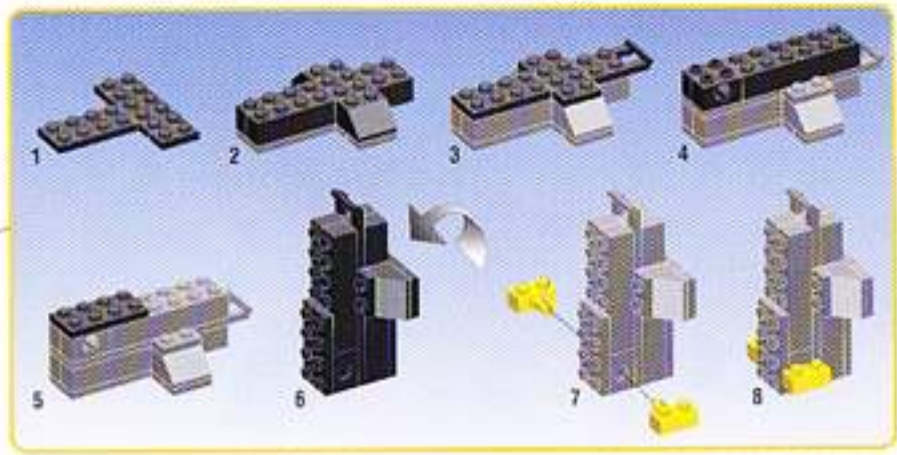
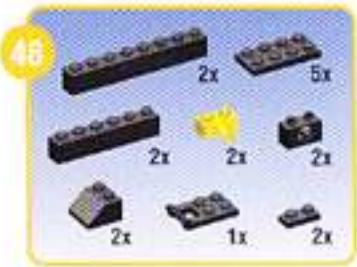



Active step / Étape active / Etapa activa / Istruzione attuale  
Aktiv skede / Folgende stap / 現在進行中 / 現段階

Previous step / Étape précédente / Etapa precedente / Istruzione precedente  
Föregående skede / Vorige stap / 以前進行中 / 前段階



52 4x

53 2x

54

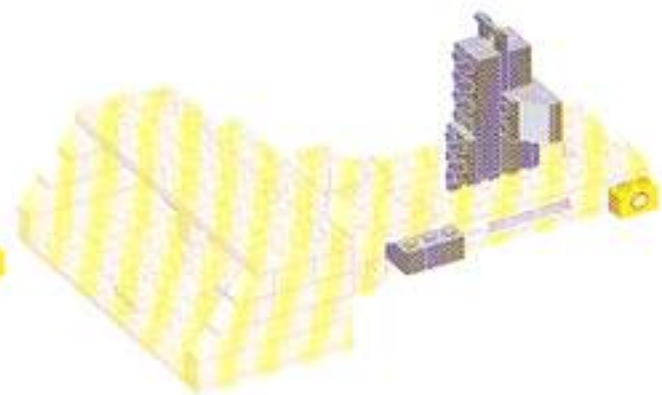
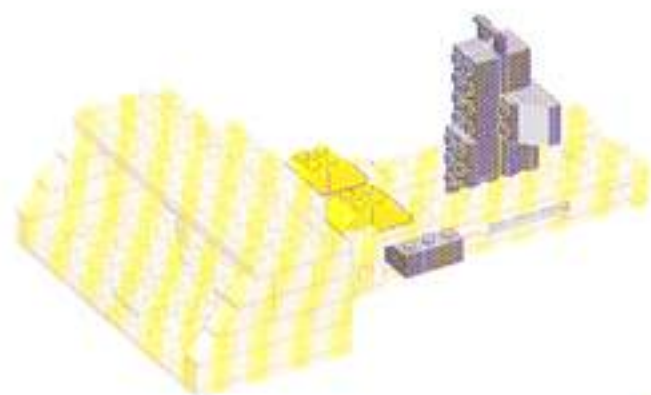

55

56

56 2x

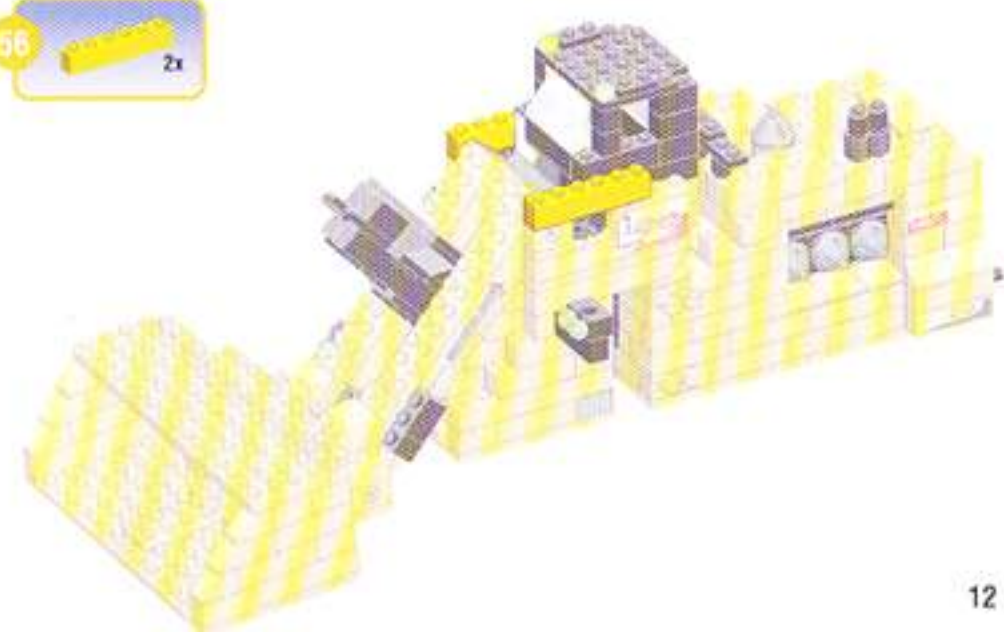
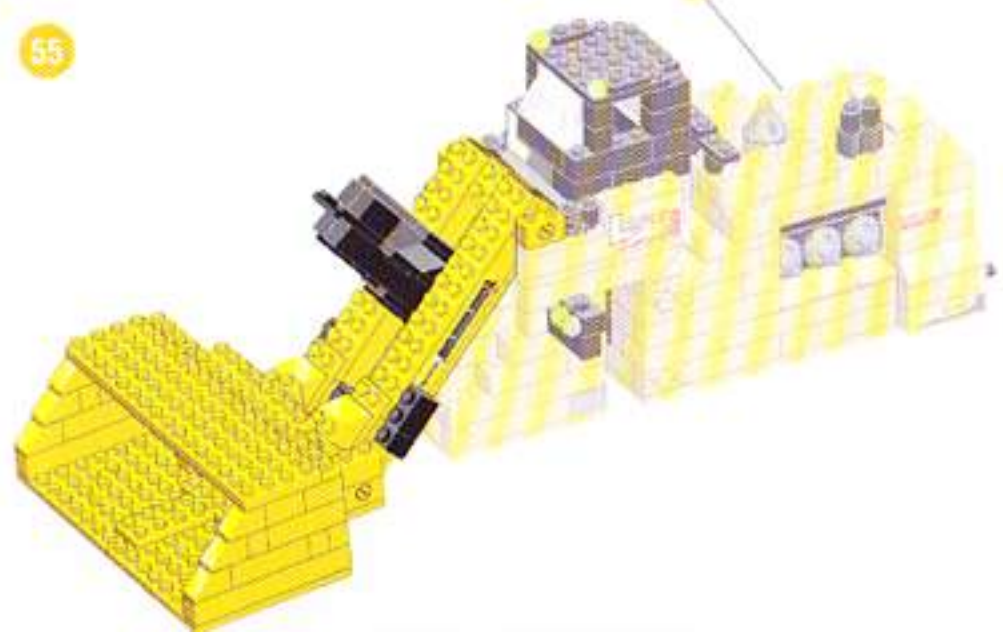

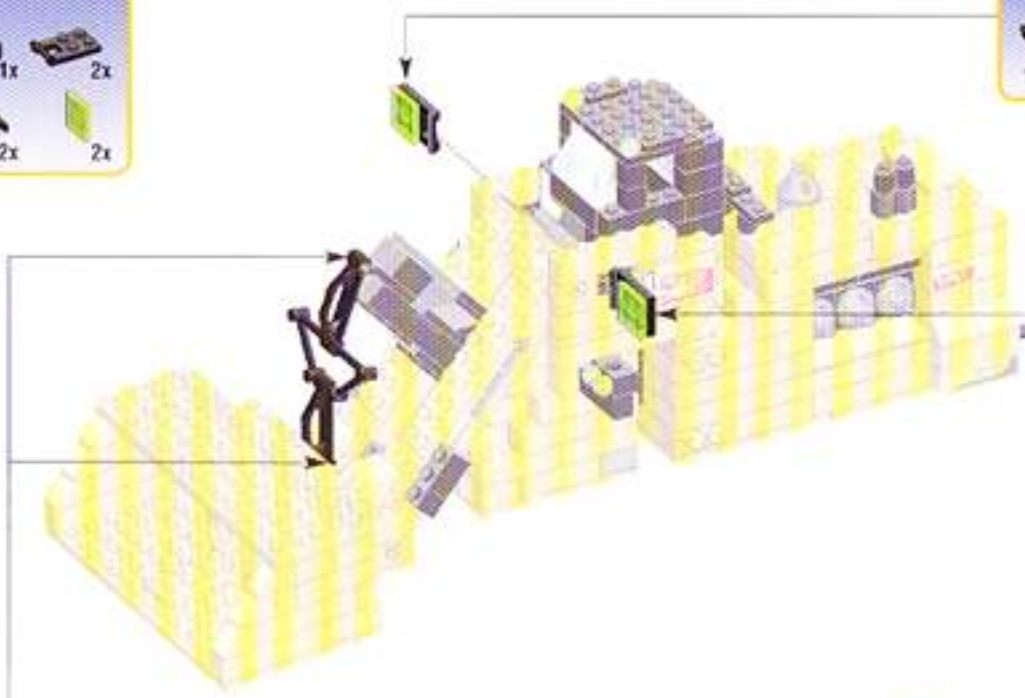

58

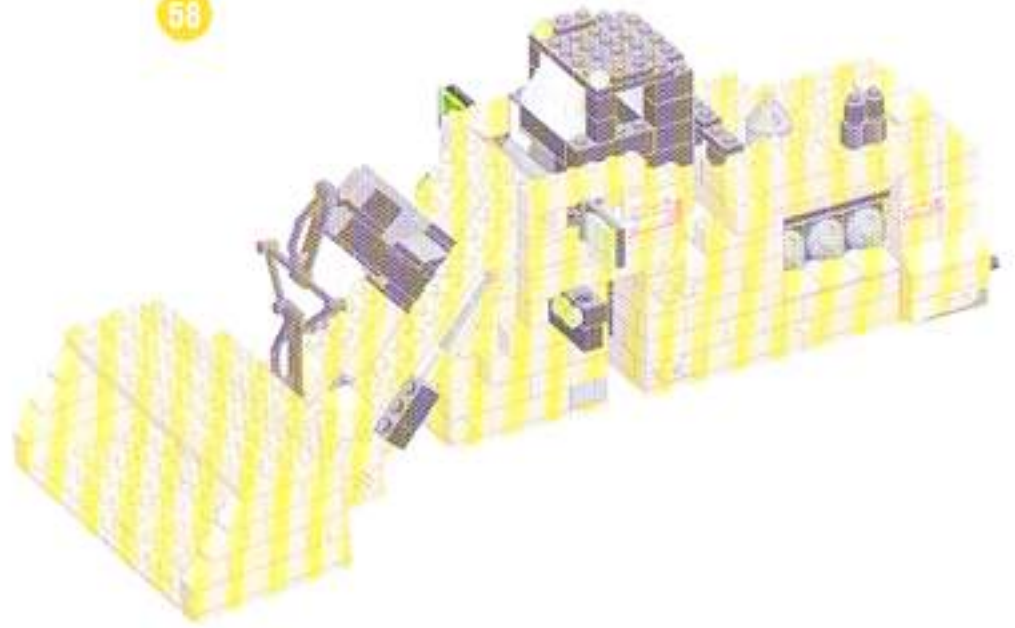



Active step / Étape active / Etapa activa / Istruzione attuale  
Aktiv skede / Folgende stap / 完成这一步 / 现阶段

Previous step / Étape précédente / Etapa precedente / Istruzione precedente  
Föregående skede / Vorige stap / 从前的步骤 / 前阶段



58

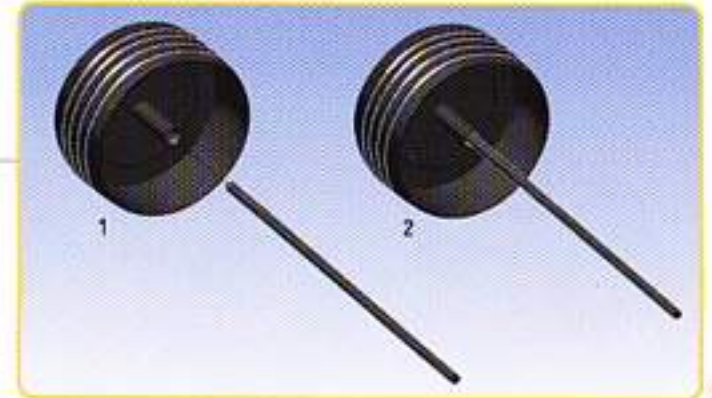
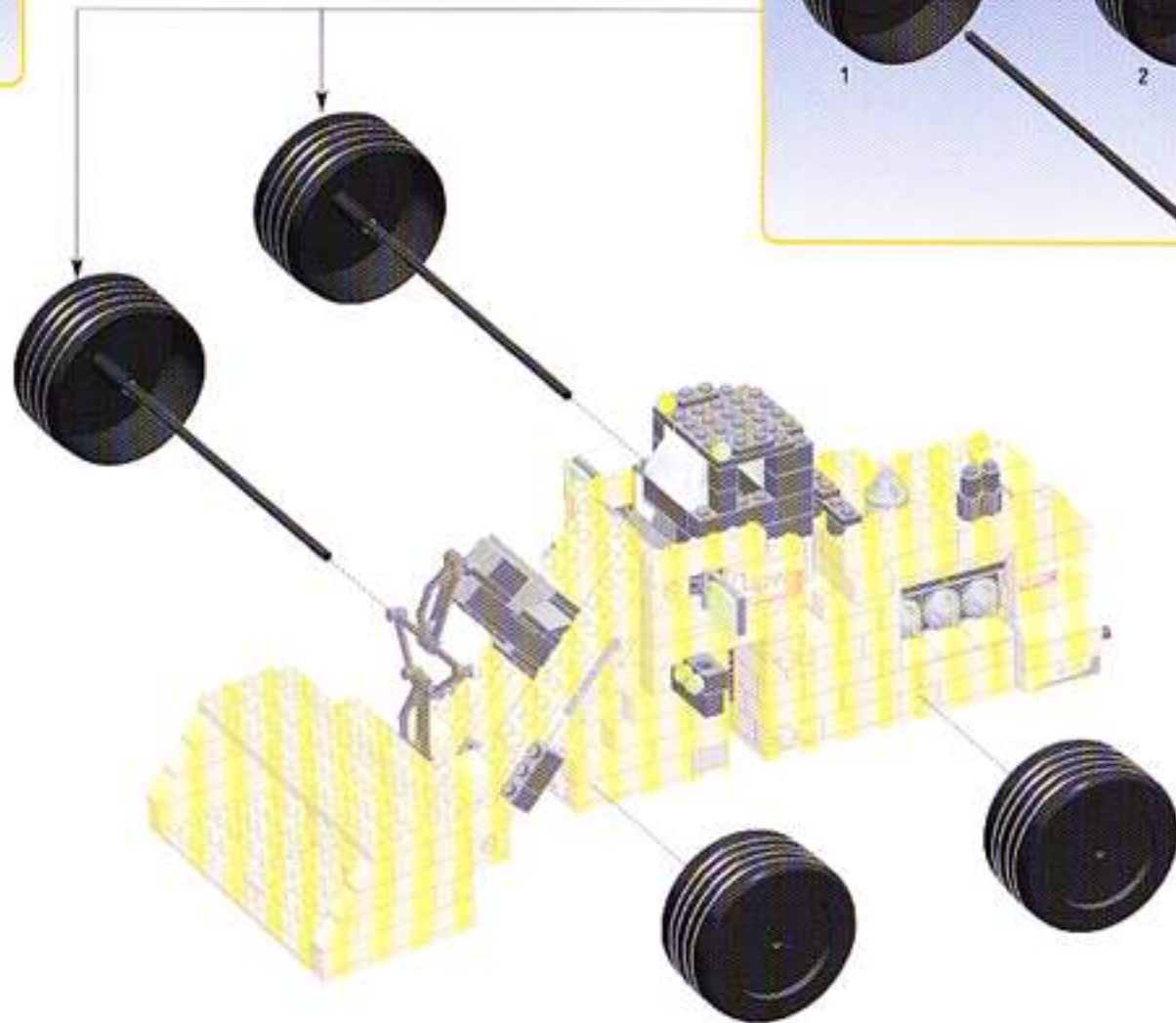

2x

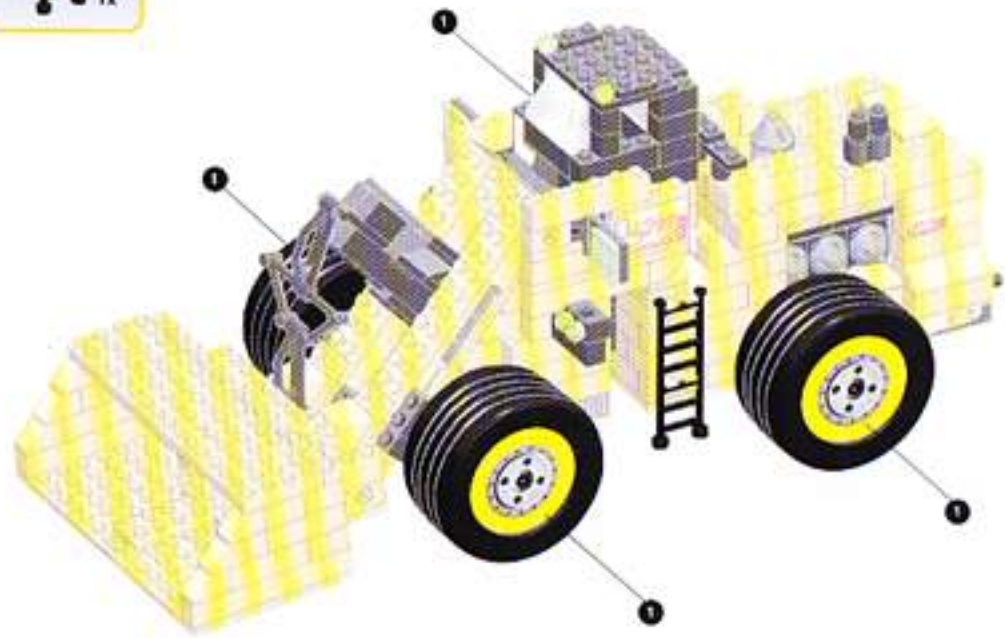



# LOADER



Rocks not included  
 Roches non incluses  
 Rocas no incluidas

**Ritvik**

© 2000, RITVIK HOLDINGS INC.  
 PRINTED IN CANADA D97152

**MEGA  
 BLOKS**  
**.COM**



# DUMP TRUCK



Rocks not included  
Roches non incluses  
Rocas no incluidas



**MEGA BLOKS** AGES/AÑOS  
**7+**

**! WARNING:**  
CHOKING HAZARD - Small Parts.  
Not for children under 3 years



Color chart.

Charte de couleurs.

Cuadro cromático.

Diagramma colorimetrico.

Färgtabell.

Kleurkaart.

カラーチャート

彩圖



Active step / Étape active / Etapa activa / Istruzione attuale  
Aktiv skede / Volgende stap / 次のステップ / 現段階

Previous step / Étape précédente / Etapa precedente / Istruzione precedente  
Føregående skede / Vorige stap / 次のステップ / 前段階



Adult assistance is required. / L'aide d'un adulte est requise. / Necesita ayuda de un adulto. / L'aiuto di un adulto è richiesto. / Hjælp af en voksen er nødvendigt. / Hulp van volwassenen is gewenst. / 大人の助けが必要です。 / 大人の助けが必要です。 / 注意：有窒息危险。

**! WARNING:**

Choking hazard - Small parts.  
Not for children under 3 years.

**! AVERTISSEMENT:**

Risque de suffocation. Ne convient pas à un enfant de moins de 3 ans - contient de petits éléments.

**! ADVERTENCIA:**

Peligro de asfixia. No recomendado para niños menores de 3 años - contiene piezas pequeñas.

**! AVVERTENZA:**

Rischio di soffocamento. Non adatta ad un bambino di età minore ai 36 mesi. Contiene parti piccole - non ingerire.

**! WARNING:**

Risk for kvävning. Ikke egnet til barn under 3 år - inneholder smådelar.

**! WAARSCHUWING:**

Stikgevaar. Niet geschikt voor kinderen onder 3 jaar - i.v.m. kleine onderdelen.

**! 注意:**

窒息の危険があります。  
3歳以下の幼児には  
与えないでください。

! 不适于三岁以下儿童。

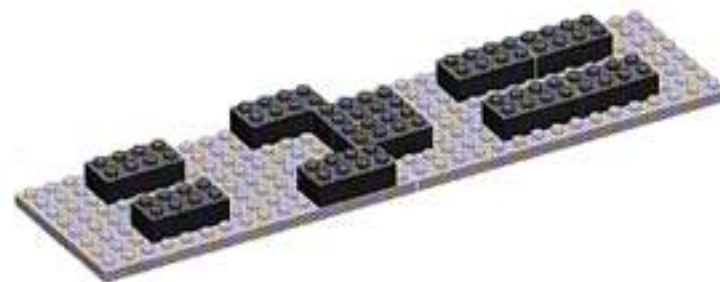
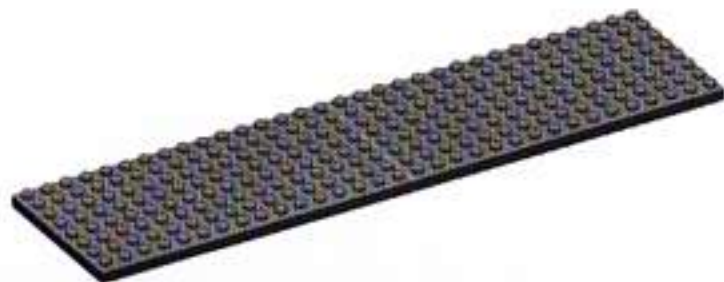
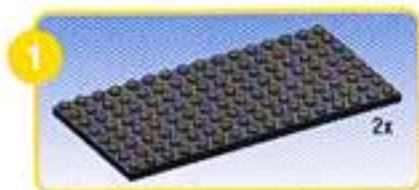

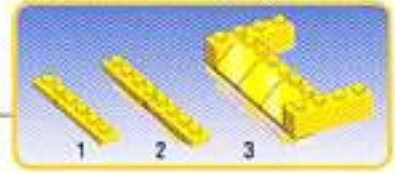
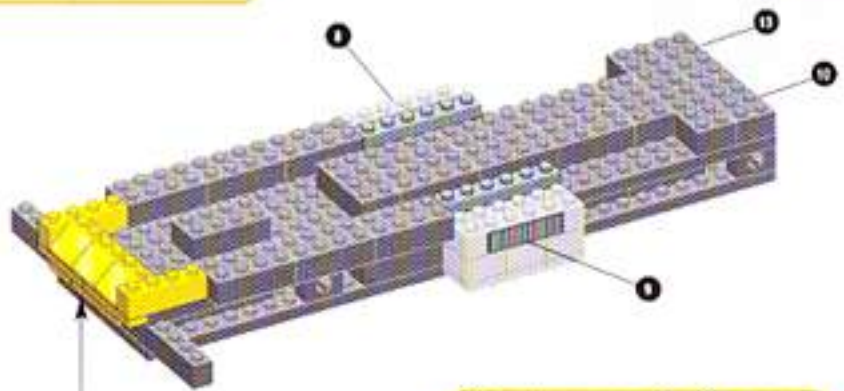
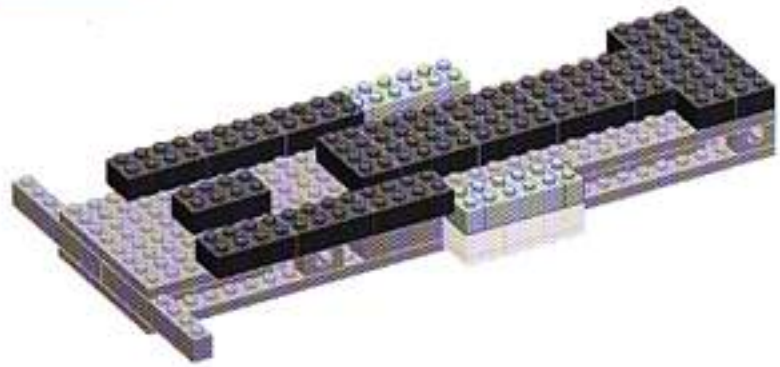
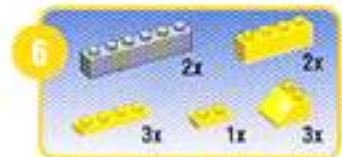
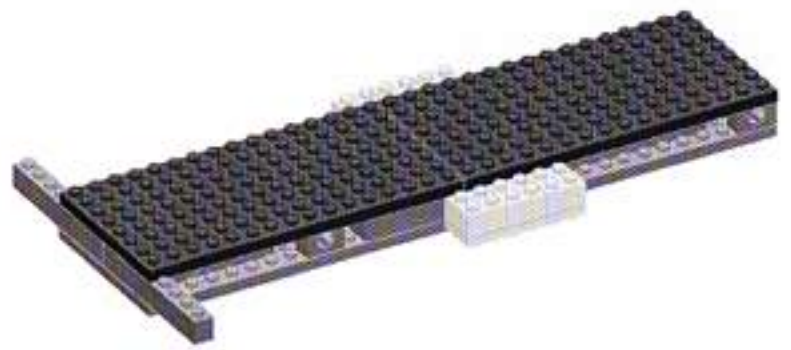
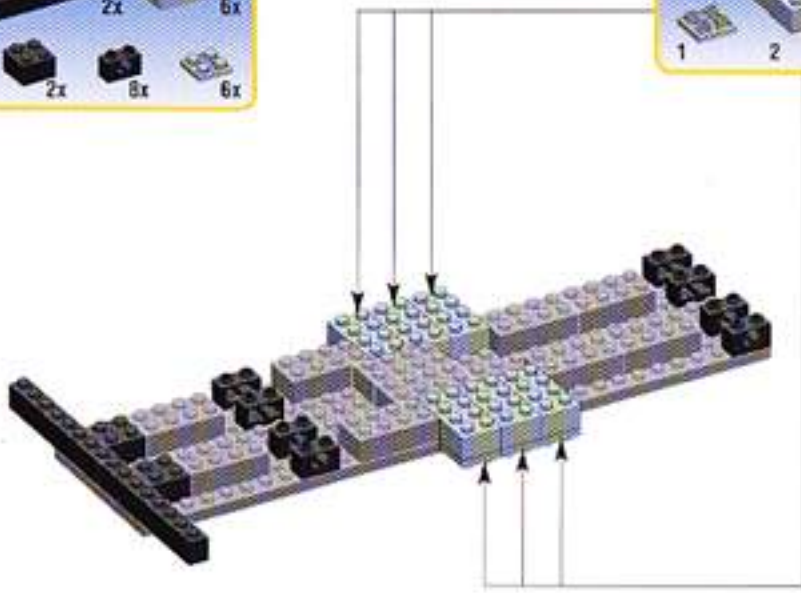



Active step / Étape active / Etapa activa / Istruzione attuale  
Aktiv skede / Folgende stap / 現在のステップ / 現段階

Previous step / Étape précédente / Etapa precedente / Istruzione precedente  
Föregående skede / Vorige stap / 以前のステップ / 前段階

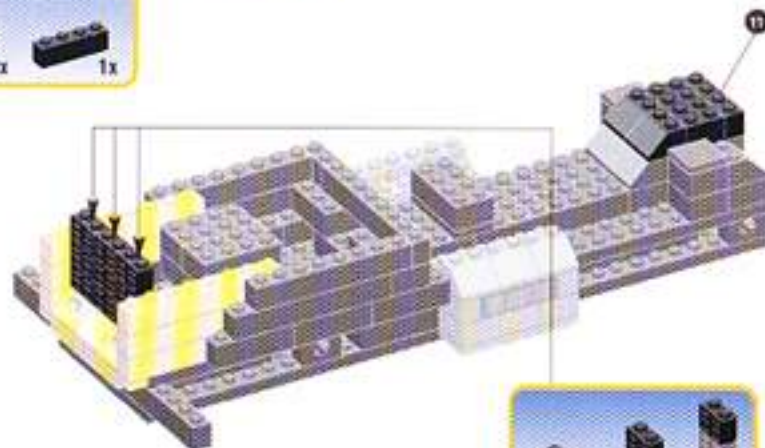
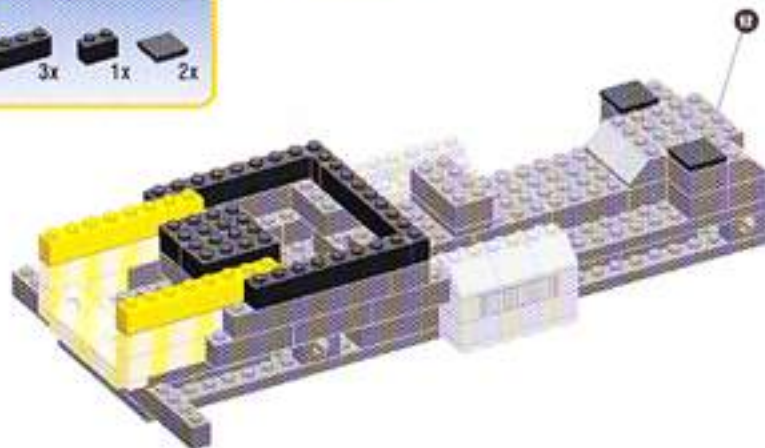
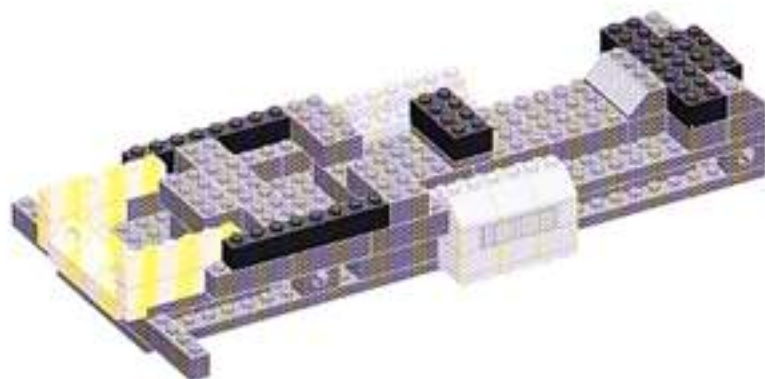
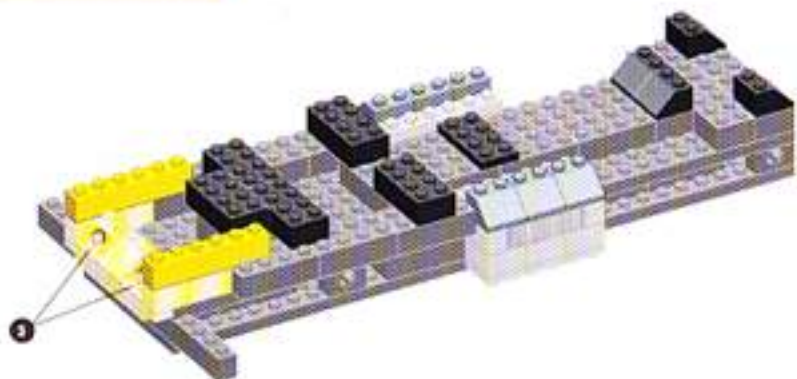

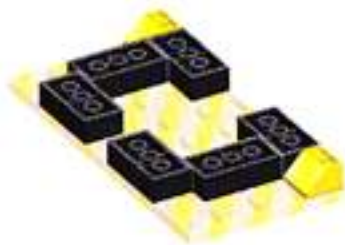
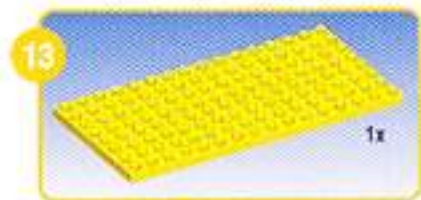
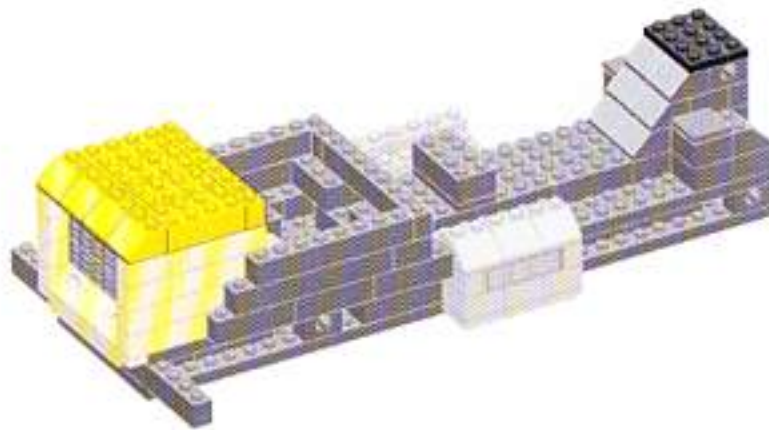
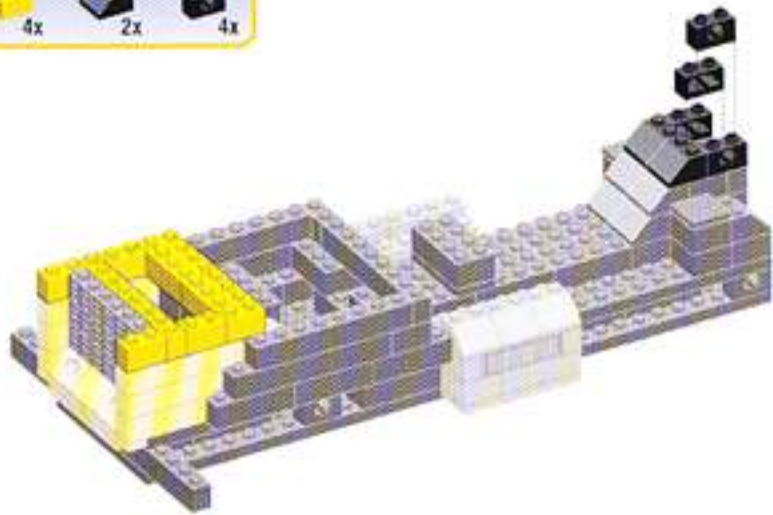

15





Active step / Étape active / Etapa activa / Istruzione attuale  
 Aktiv skede / Folgende stap / 此步为多步 / 此段为

Previous step / Étape précédente / Etapa precedente / Istruzione precedente  
 Föregående skede / Yorige stap / 从前的步骤 / 前段为

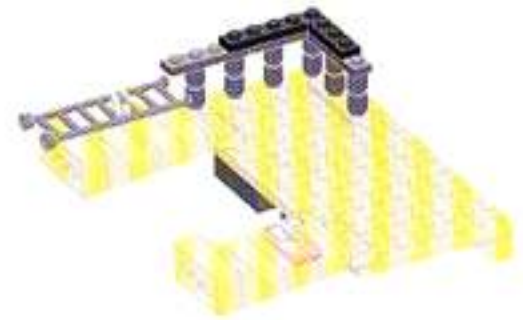
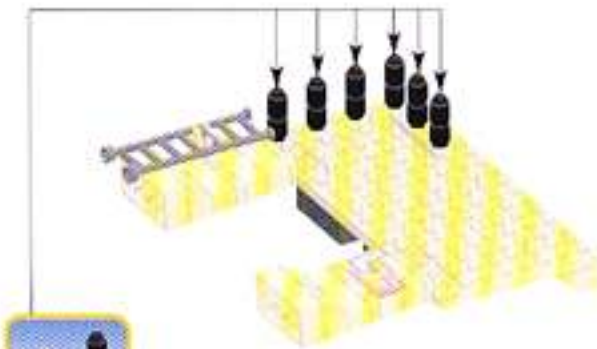
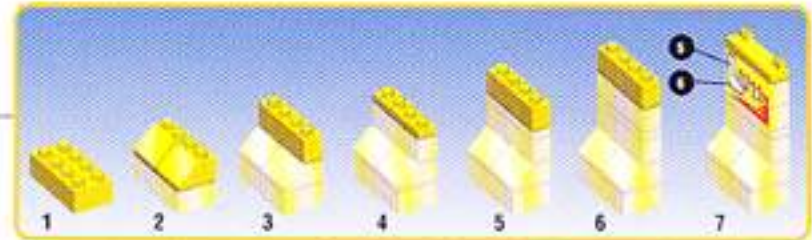
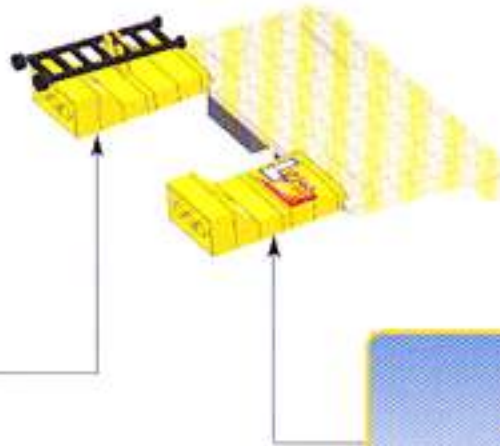
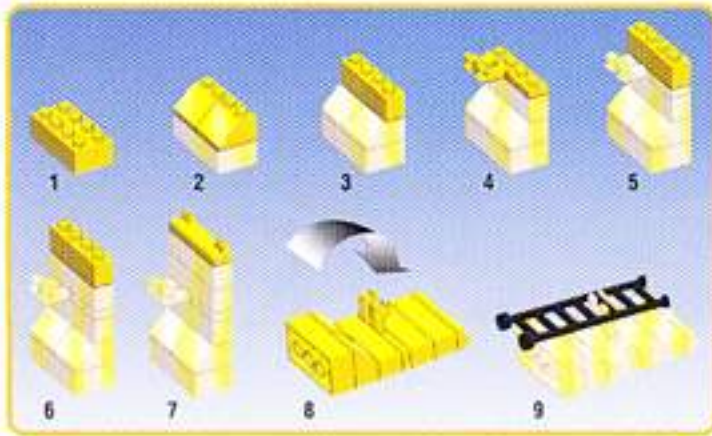
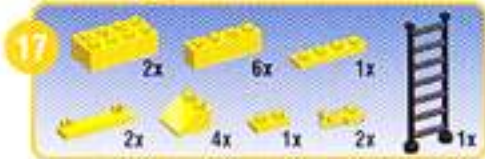

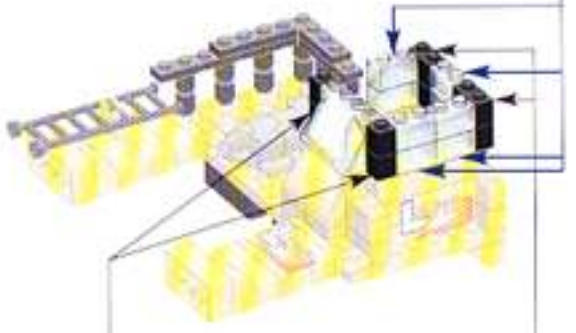
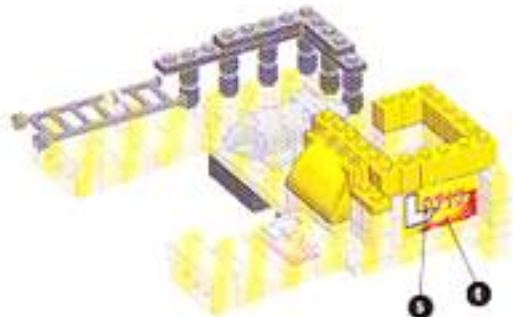
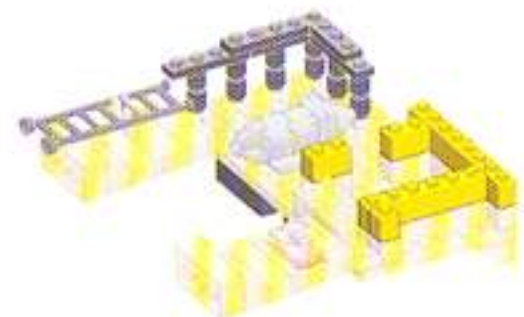
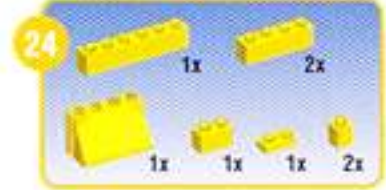
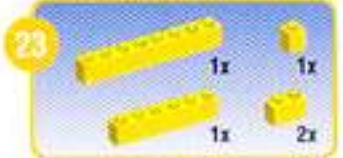
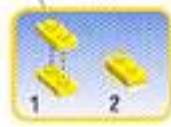
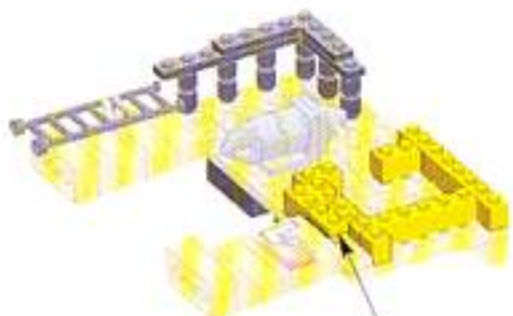
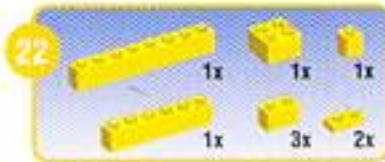



Active step / Étape active / Etapa activa / Istruzione attuale  
 Aktiv skede / Folgende stap / 現任的步驟 / 現段階

Previous step / Étape précédente / Etapa precedente / Istruzione precedente  
 Föregående skede / Vorige stap / 前面的步驟 / 前段階



26



27

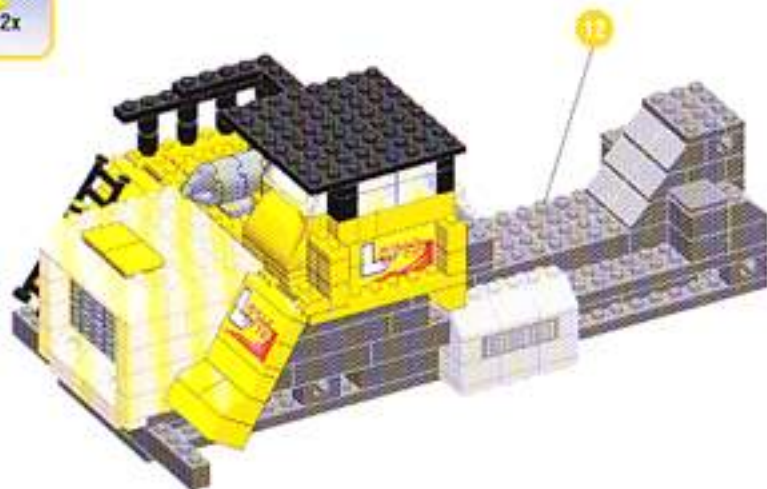
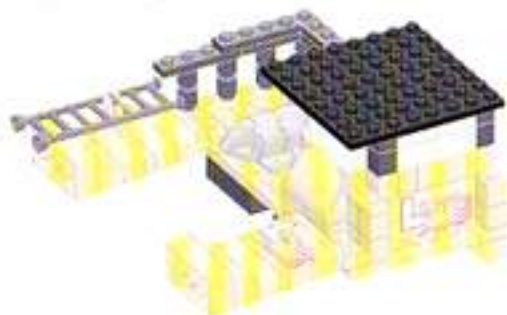

28



29



2x



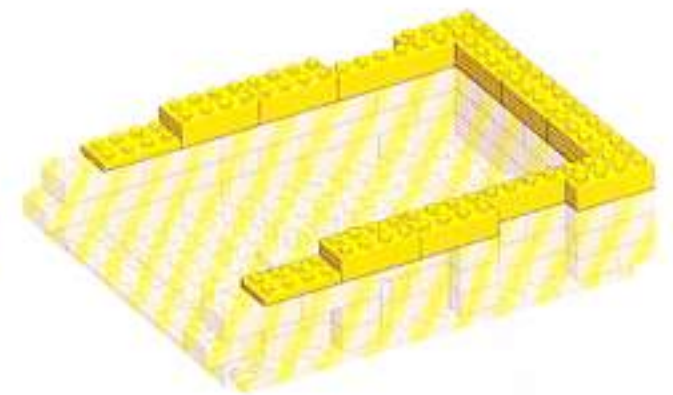
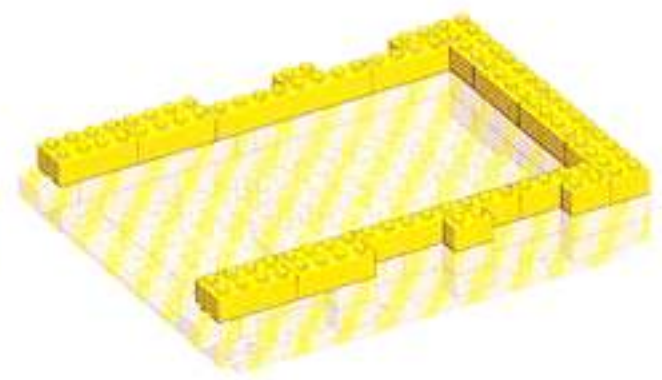
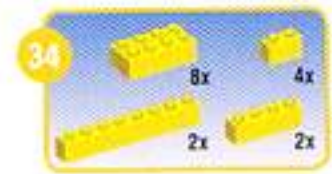
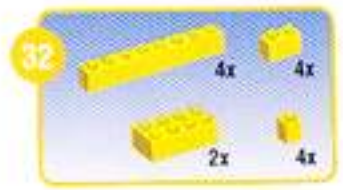
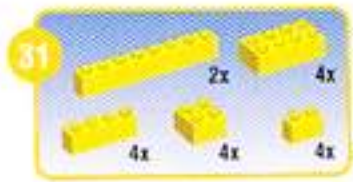



Active step / Étape active / Etapa activa / Istruzione attuale  
Aktiv skede / Folgende stap / 完成此步骤 / 完成阶段

Previous step / Étape précédente / Etapa precedente / Istruzione precedente  
Føregående skede / Vorige stap / 完成前步骤 / 前阶段

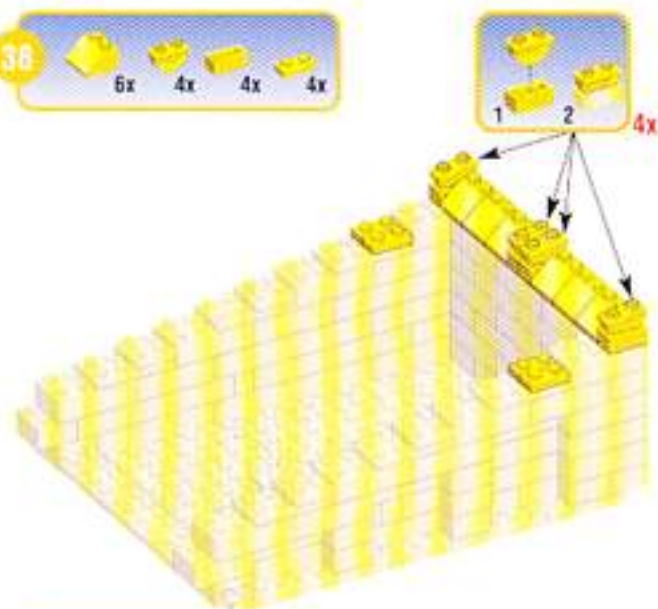
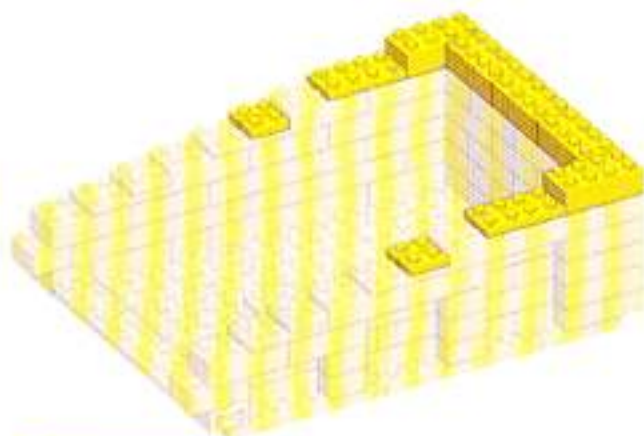
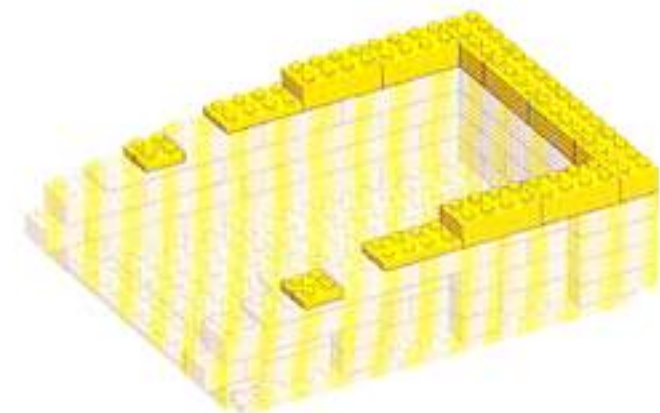

42



43

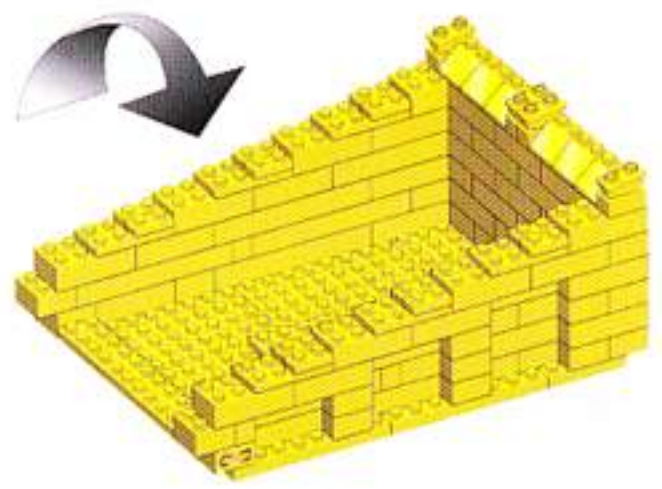

44

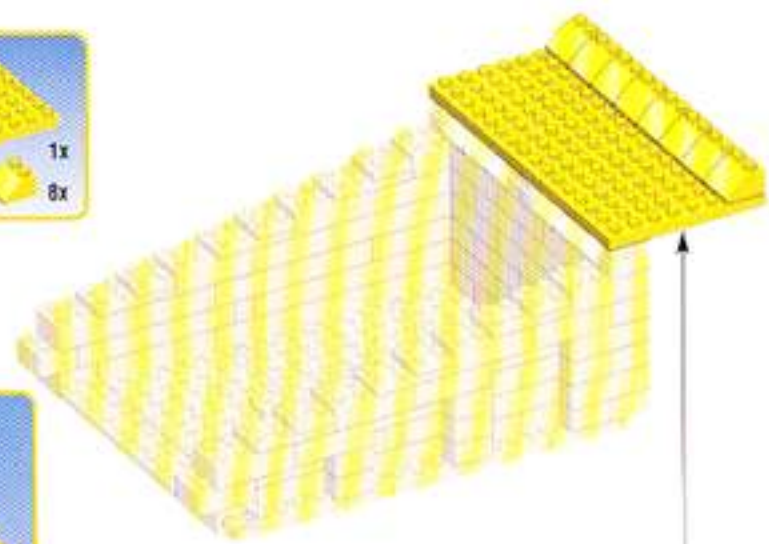

45

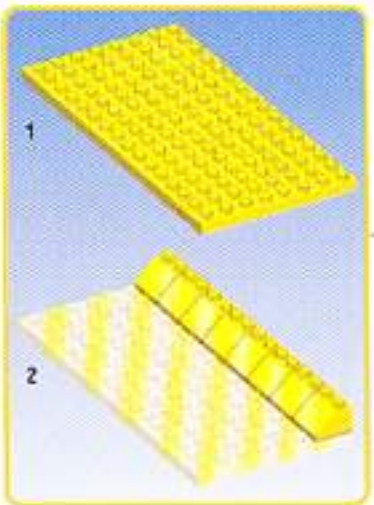
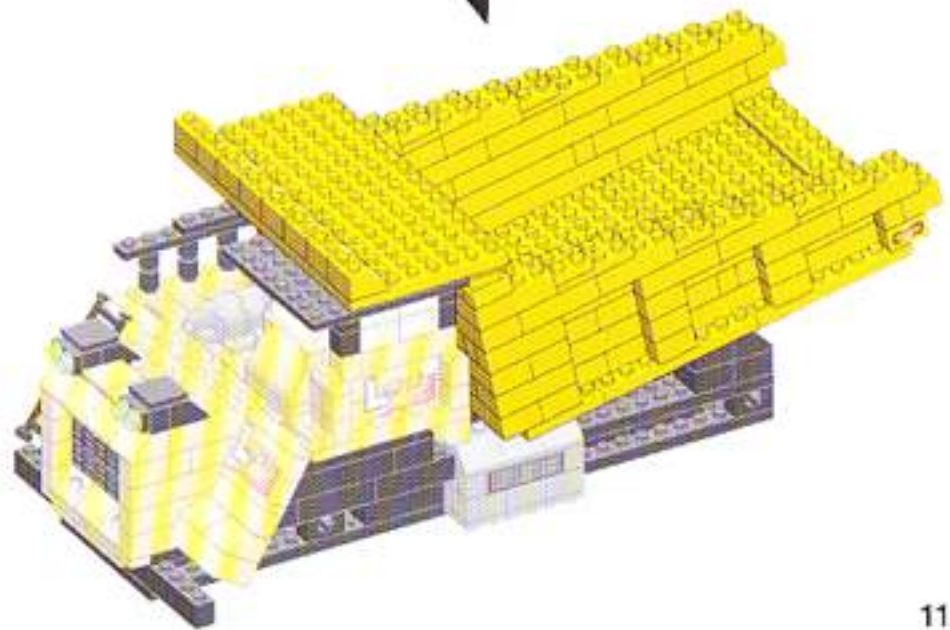



Active step / Étape active / Etapa activa / Istruzione attuale  
Aktiv skede / Folgende stap / 正在的步骤 / 正在进行

Previous step / Étape précédente / Etapa precedente / Istruzione precedente / Föregående skede / Vorige stap / 从前的步骤 / 前段路



46

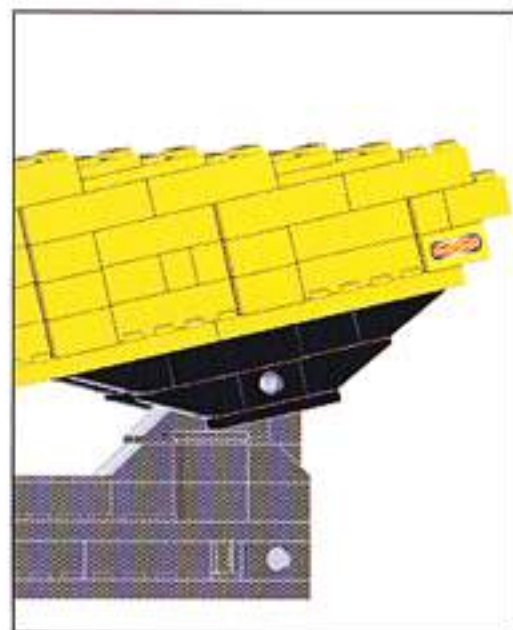
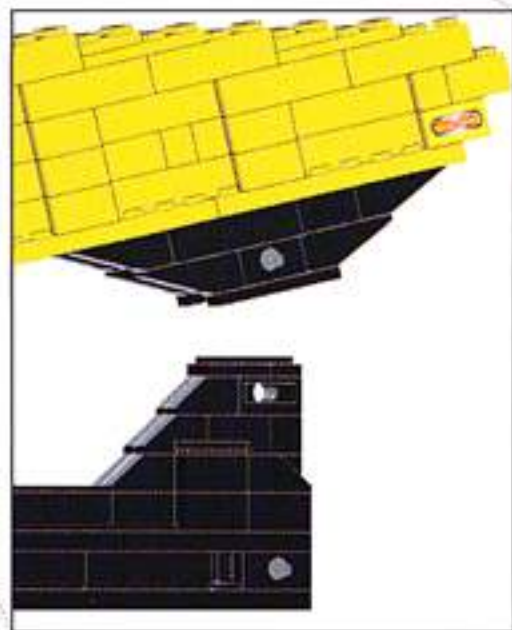
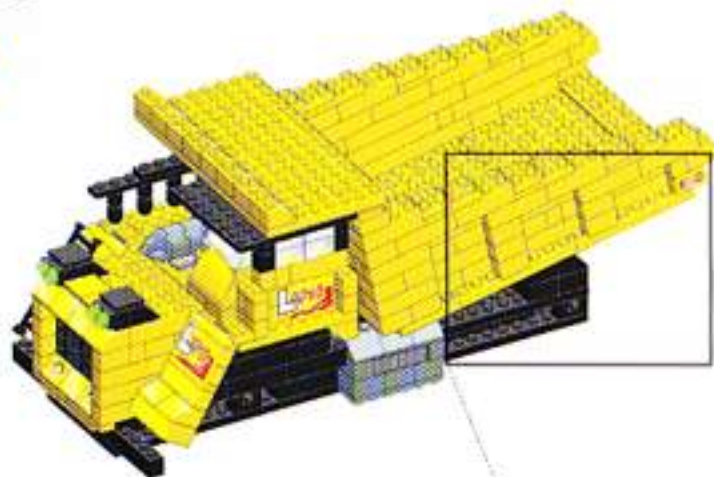

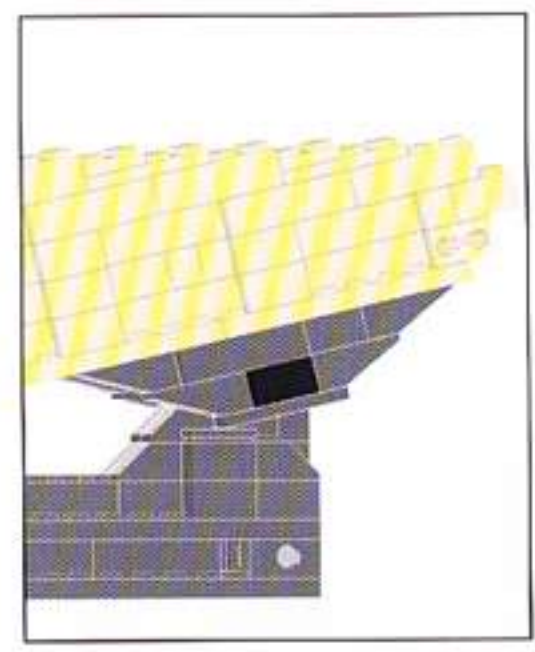
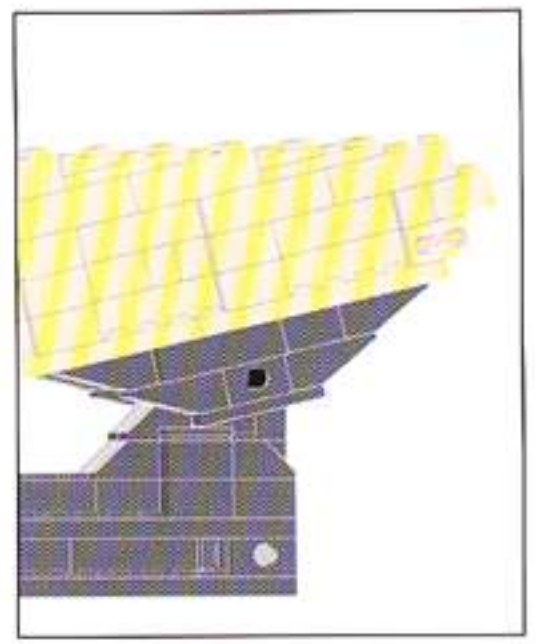
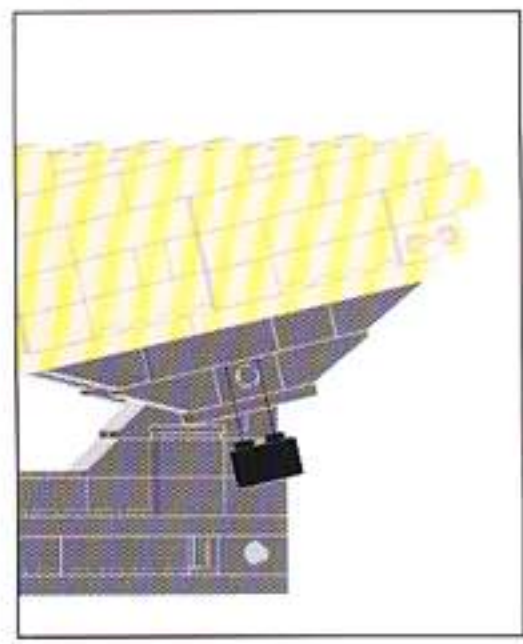
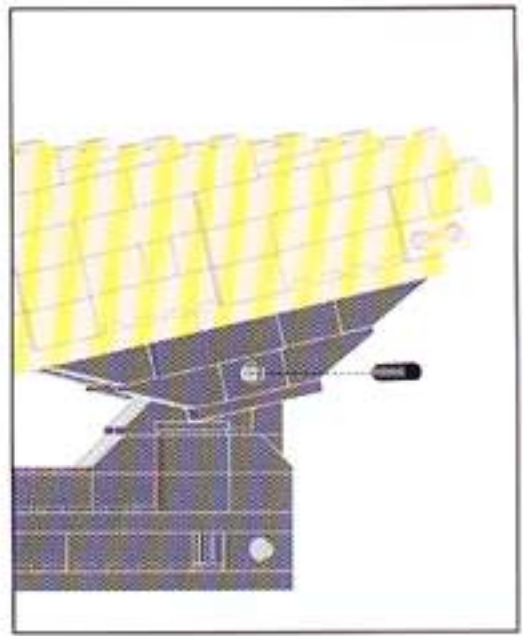



Active step / Étape active / Etapa activa / Istruzione attuale  
Aktiv skede / Folgende stap / 现在的步骤 / 现阶段

Previous step / Étape précédente / Etapa precedente / Istruzione precedente / Föregående skede / Vorige stap / 以前的步骤 / 前阶段



51

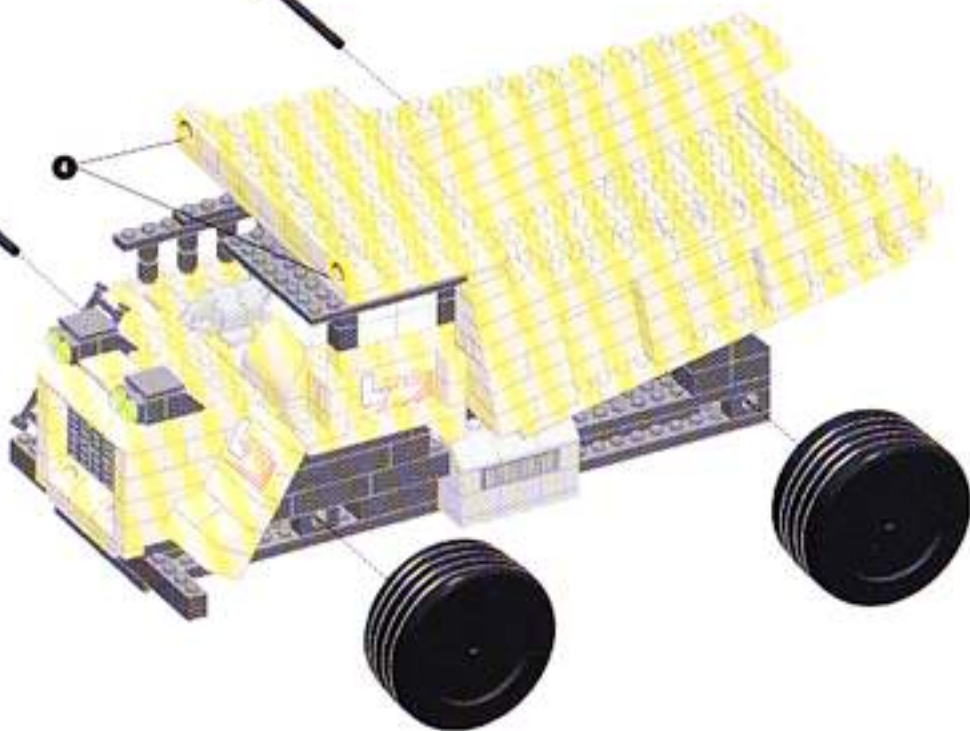

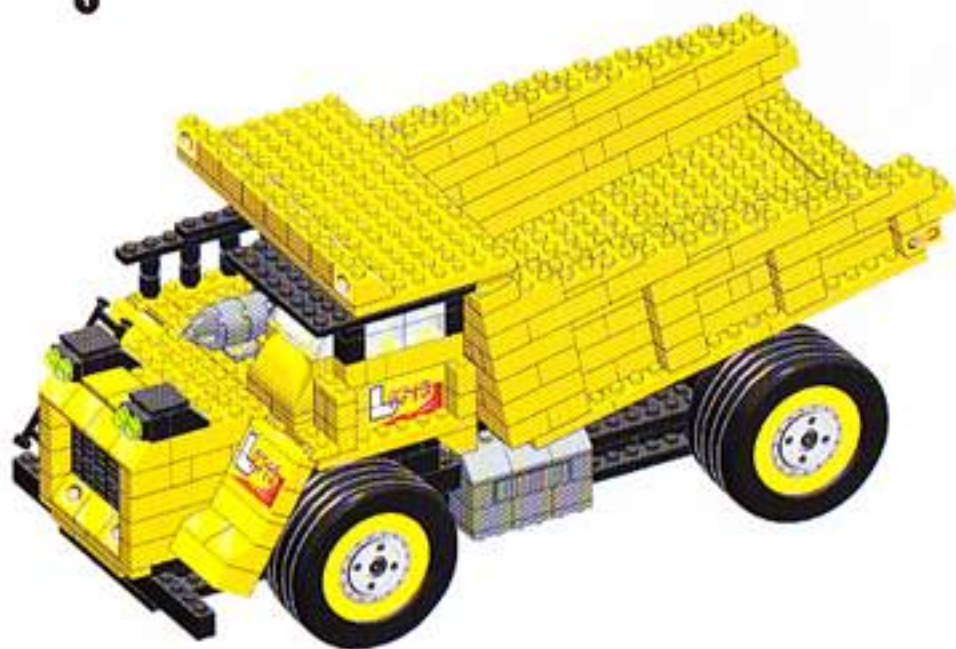
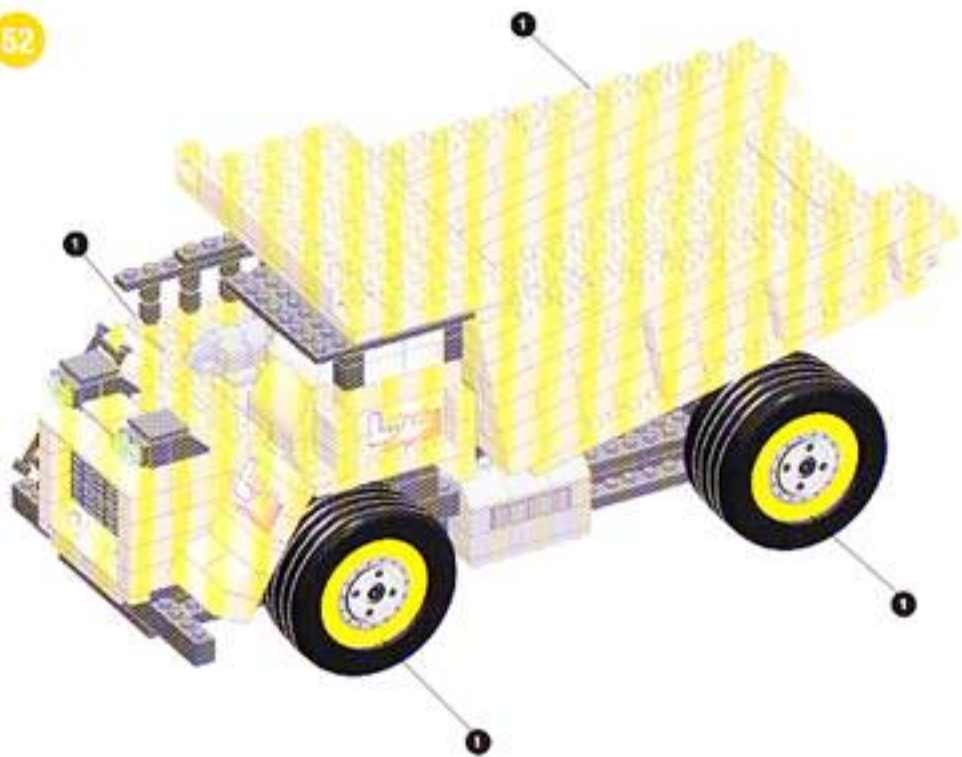



# DUMP TRUCK

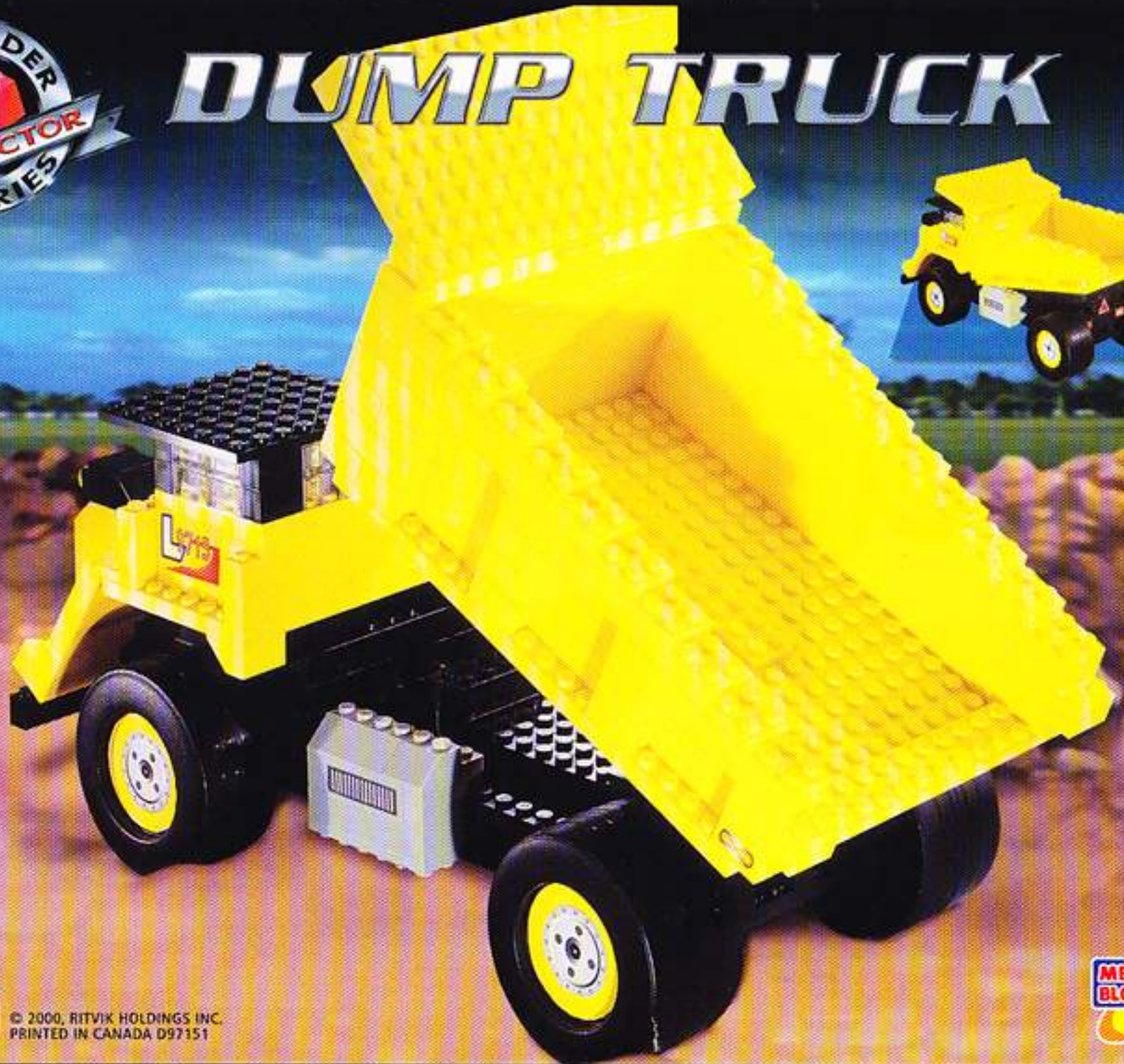

**Ritvik**

© 2000, RITVIK HOLDINGS INC.  
PRINTED IN CANADA D97151

