

BLUE THUNDER™

9743



MEGA BLOKS AGES/AÑOS
7+

⚠ WARNING:
CHOKING HAZARD - Small Parts.
Not for children under 3 years



Color chart.
 Charte de couleurs.
 Cuadro cromático.
 Diagramma colorimetrico.

Färgtabell.
 Kleurkaart.
 カラーチャート
 彩圖



Active step / Étape active / Etapa activa / Istruzione attuale
 Aktiv skede / Folgende stap / 現在の段階 / 現段階

Previous step / Étape précédente / Etapa precedente / Istruzione precedente
 Foregående skede / Vorige stap / 以前の段階 / 前段階



Adult assistance is required. / L'aide d'un adulte est requise. / Necesita ayuda de un adulto. / L'aiuto di un adulto è richiesto. / Hjælp af en voksen er nødvendigt. / Hulp van volwassenen is gewenst. / 大人の援助が必要です。 / مطلوب المساعدة من الكبار. / 小零件有窒息危險。

WARNING:
 Choking hazard - Small parts.
 Not for children under 3 years.

AVERTISSEMENT:
 Risque de suffocation. Ne convient pas à un enfant de moins de 3 ans - contient de petits éléments.

ADVERTENCIA:
 Peligro de asfixia. No recomendado para niños menores de 3 años - contiene piezas pequeñas.

AVVERTENZA:
 Rischio di soffocamento. Non adatta ad un bambino di età minore ai 36 mesi. Contiene parti piccole - non ingerire.

WARNING:
 Risk for kvävning. Ikke egnet til barn under 3 år - inneholder smådeler.

WAARSCHUWING:
 Stikgevaar. Niet geschikt voor kinderen onder 3 jaar - i.v.m. kleine onderdelen.

注意:
 飲み込むと危険です。
 小さいパーツがあるため、
 3歳以下の幼児には
 与えないでください。
 不适合于三岁以下儿童。

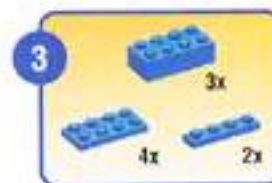
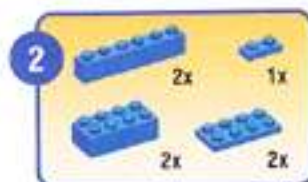

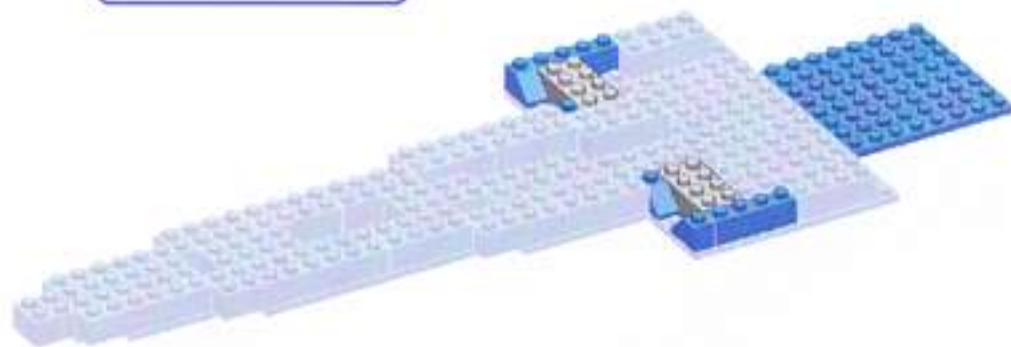
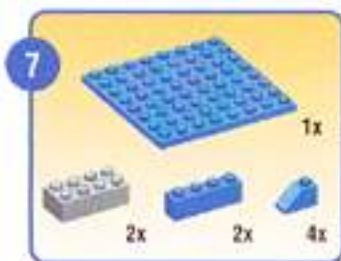
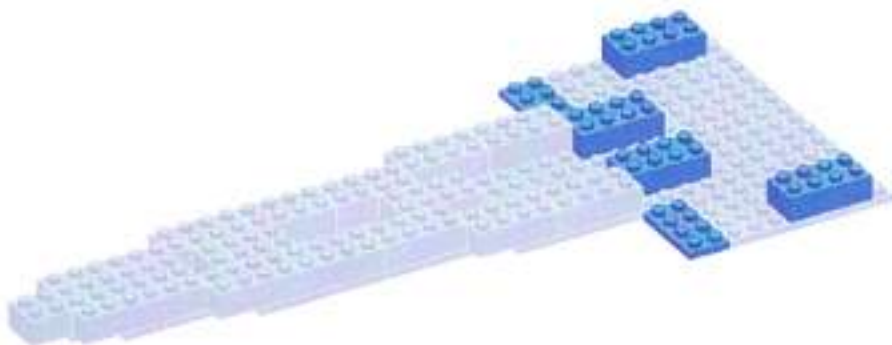



Active step / Étape active / Etapa activa /
Istruzione attuale / Aktiv skede /
Folgende stap / 次なるステップ / 次段階

Previous step / Étape précédente / Etapa precedente /
Istruzione precedente / Foregående skede /
Vorige stap / 前のステップ / 前段階

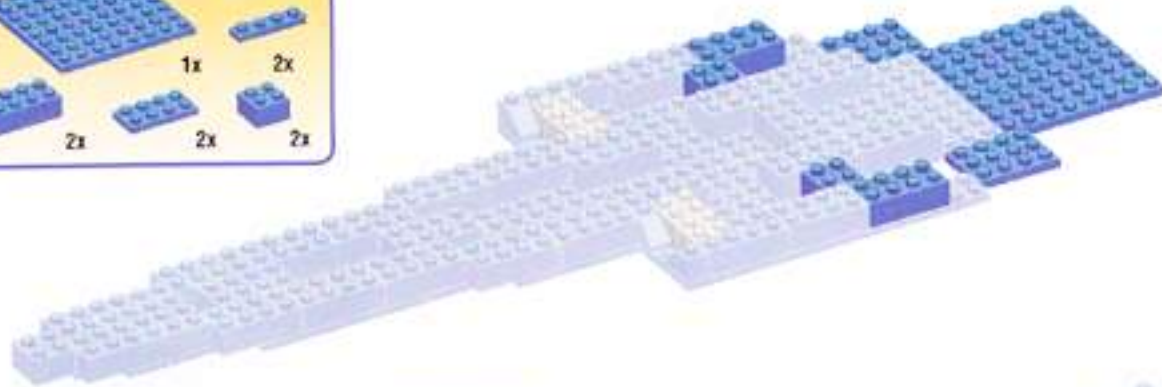
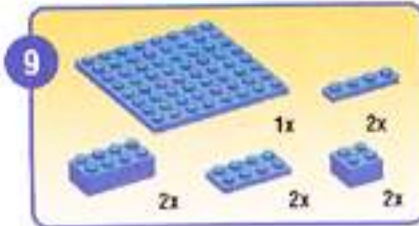
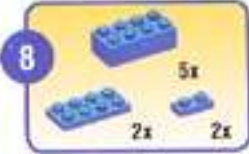

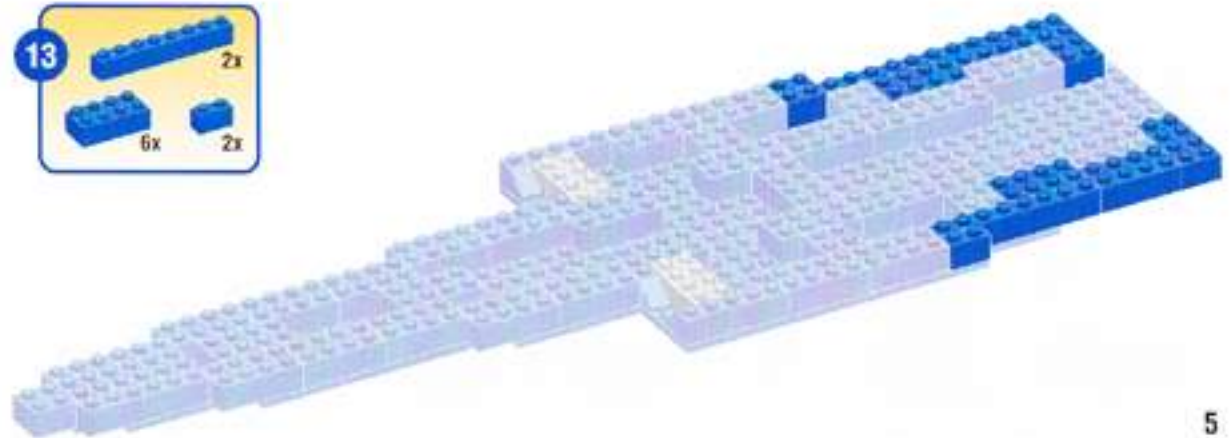
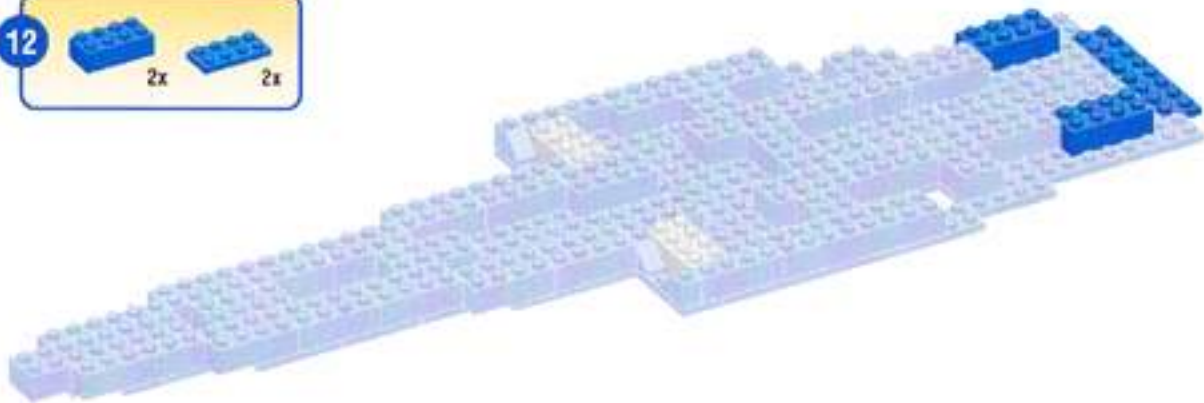
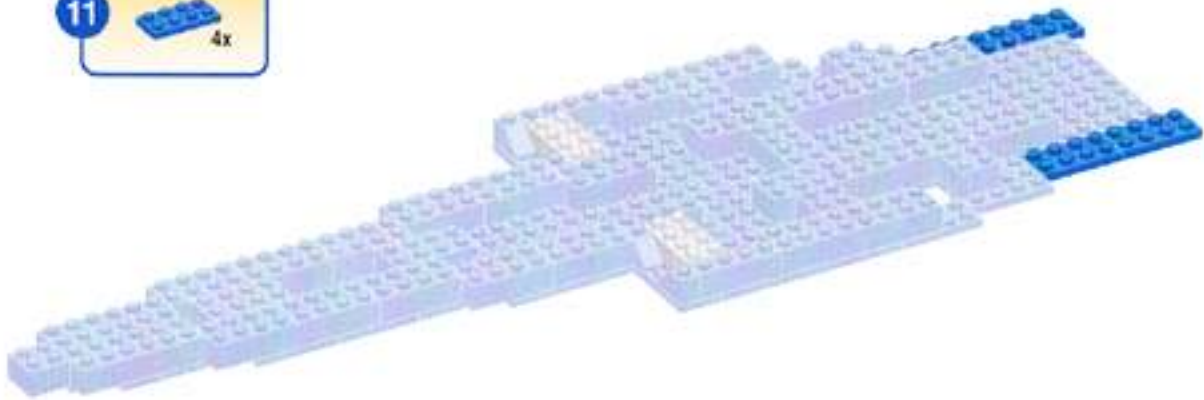



Active step / Étape active / Etapa activa /
Istruzione attuale / Aktiv skede /
Følgende st \ddot{a} p / 次のステップ / 次段階

Previous step / Étape précédente / Etapa
precedente / Istruzione precedente /
Føregående skede / Yorige st \ddot{a} p / 前段階



14



2x

1x



15

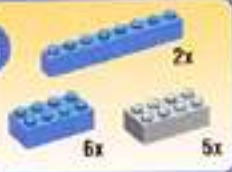

2x

6x

5x

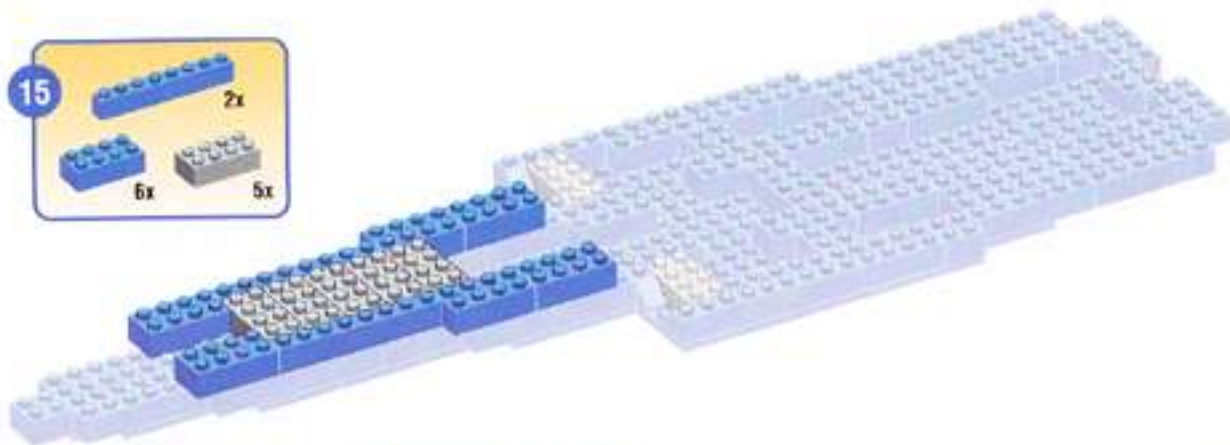

16

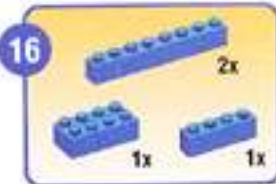

2x

1x

1x



17

- 2x (Blue 1x5 Technic Beam)
- 2x (Grey 1x2 Technic Brick with Pin)
- 5x (Blue 1x3 Technic Beam)
- 8x (Grey 1x3 Technic Brick with Pin)
- 2x (Blue 1x2 Technic Beam)
- 2x (Grey 1x2 Technic Brick with Pin)

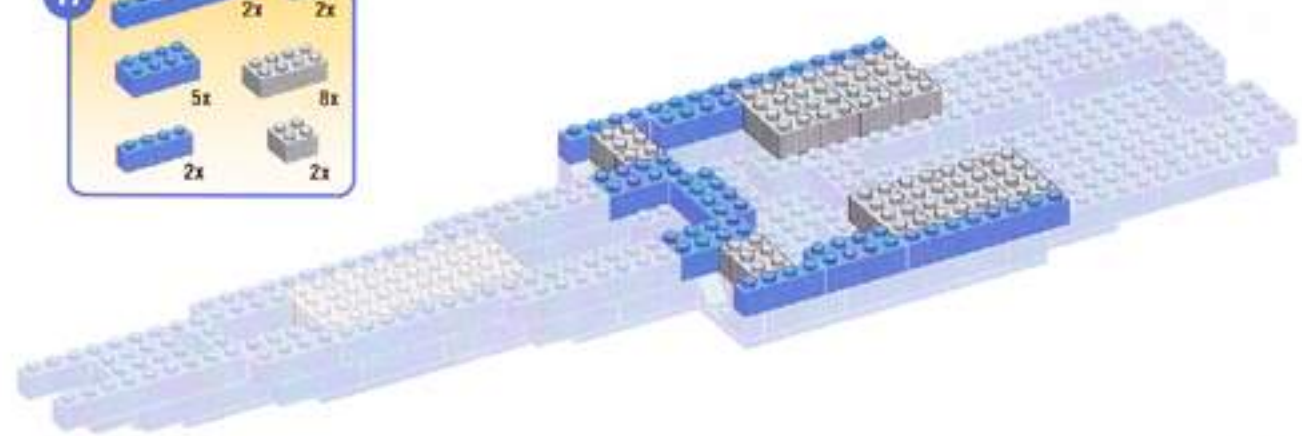

18

- 14x (Blue 1x4 Technic Beam)

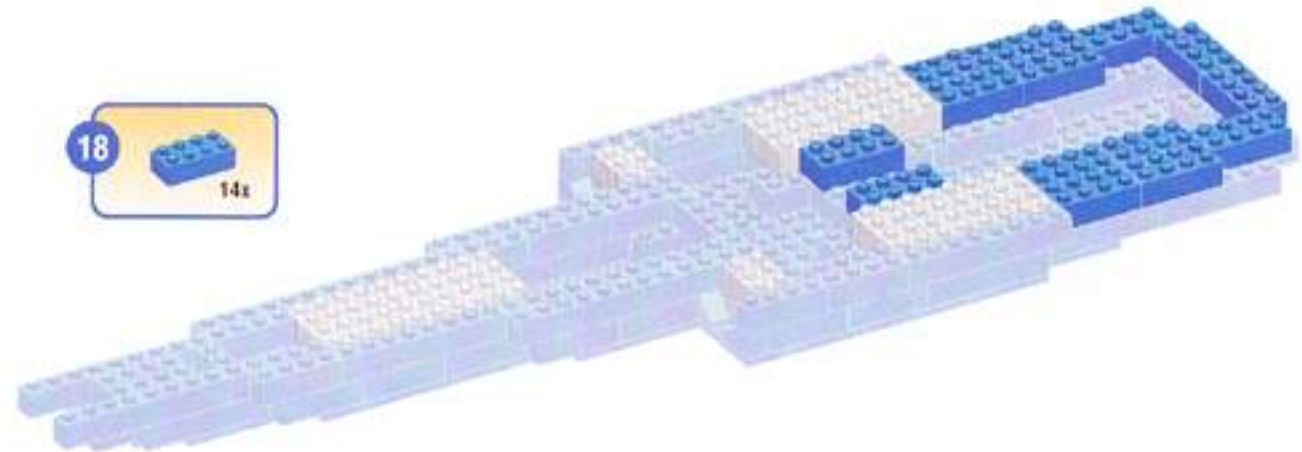

19

- 12x (Blue 1x12 Technic Beam)
- 2x (Blue 1x3 Technic Beam)
- 1x (Grey 1x3 Technic Brick with Pin)

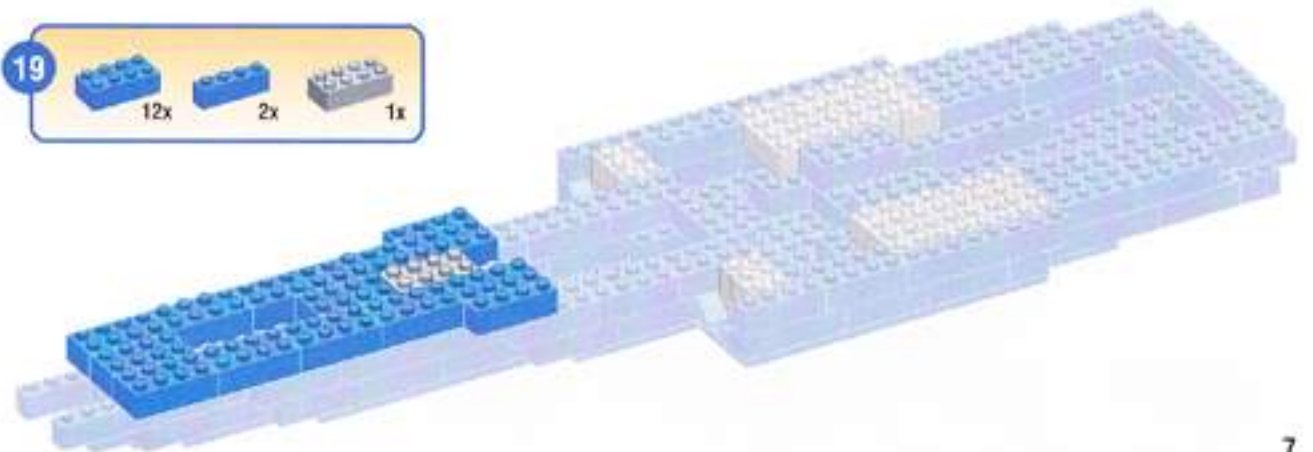



Active step / Étape active / Etapa activa /
Istruzione attuale / Aktiv skede /
Folgende stap / 次のステップ / 次段階

Previous step / Étape précédente / Etapa
precedente / Istruzione precedente /
Föregående skede / Vorige stap / 前段階

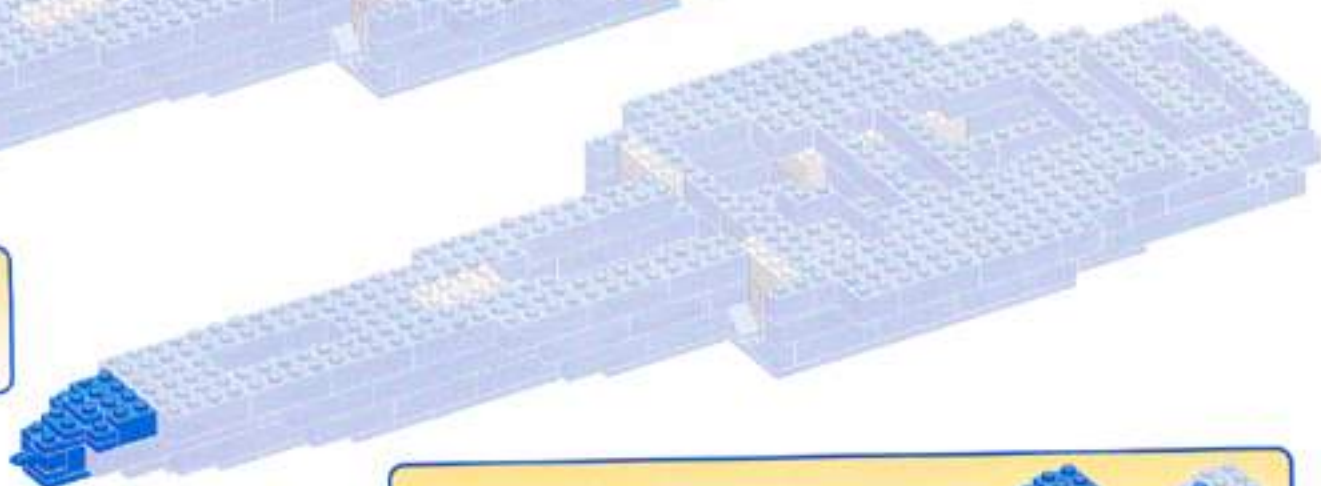
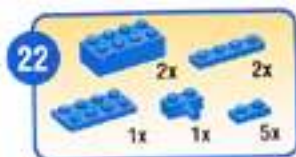
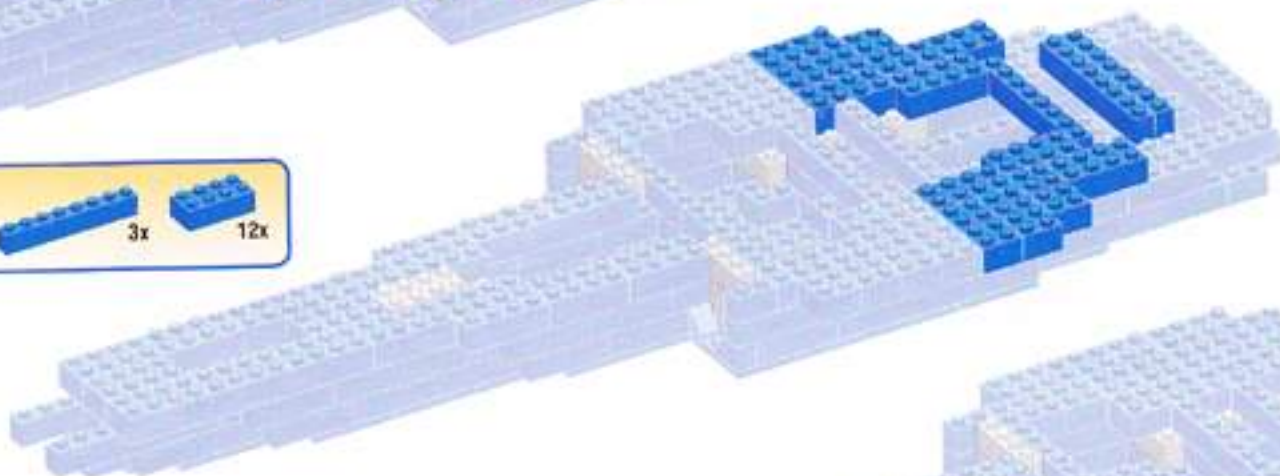
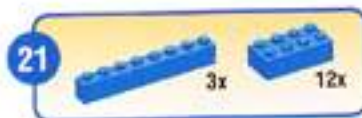
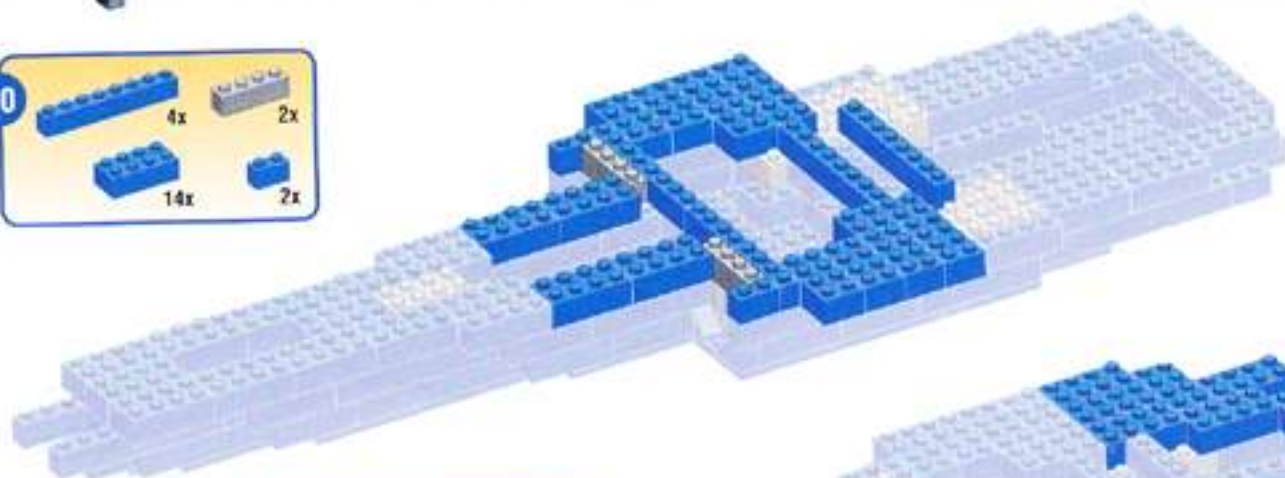
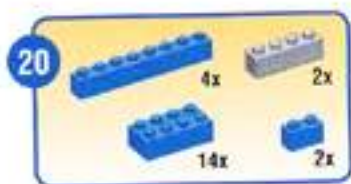

23

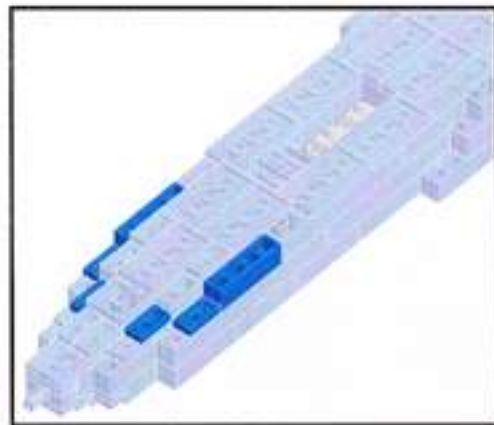
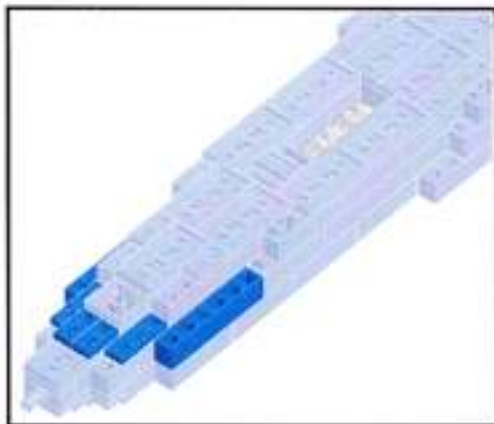
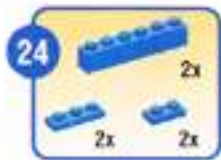
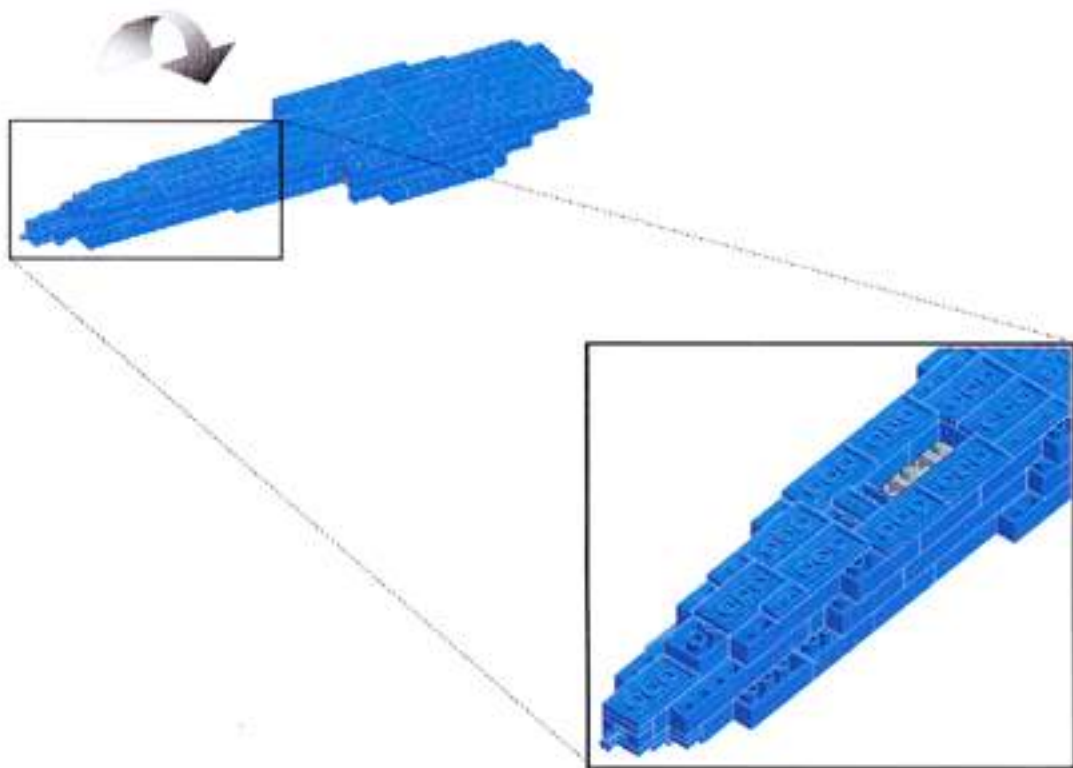



Active step / Étape active / Etapa activa /
Istruzione attuale / Aktiv skede /
Følgende st \ddot{a} p / 10, 11, 12, 13, 14, 15, 16

Previous step / Étape précédente / Etapa
precedente / Istruzione precedente /
Føregående skede / Yorige st \ddot{a} p / 1, 2, 3, 4, 5, 6, 7, 8, 9



26

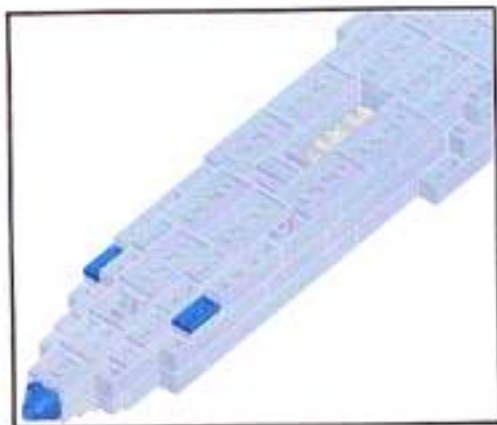

27

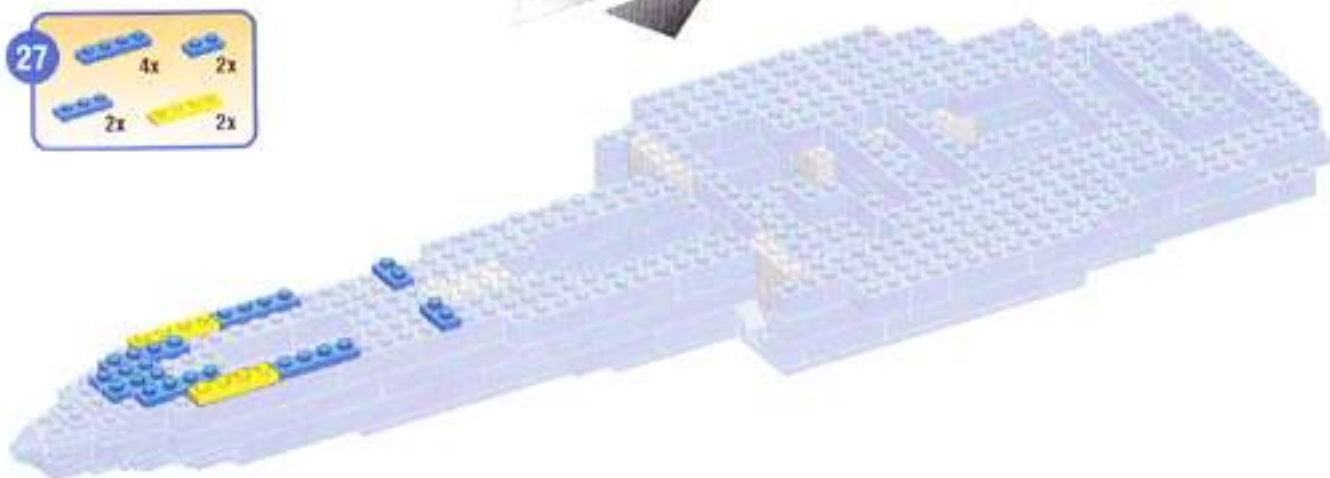
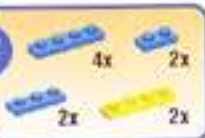

28

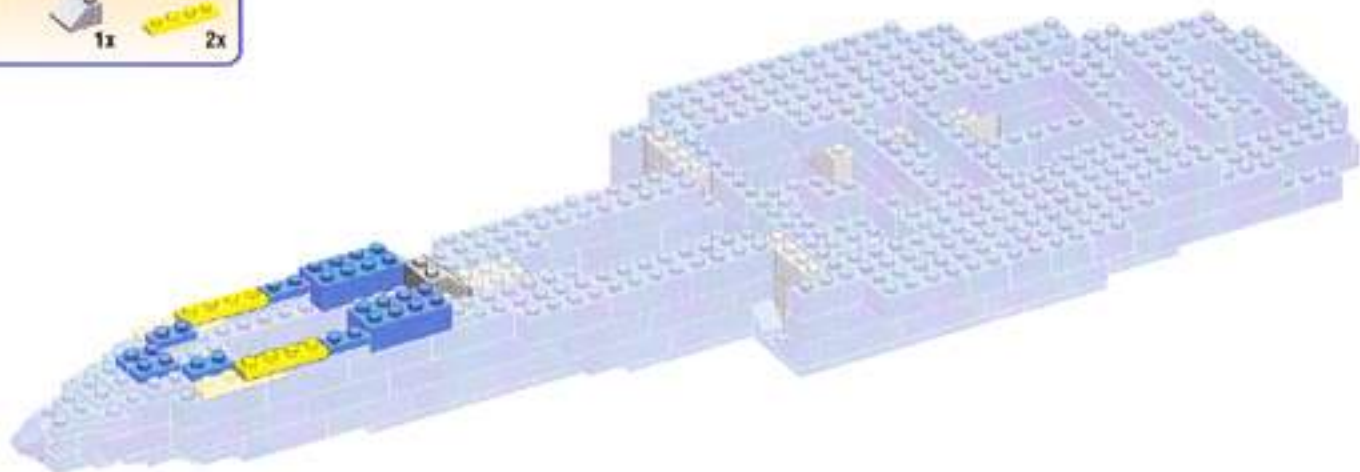

29

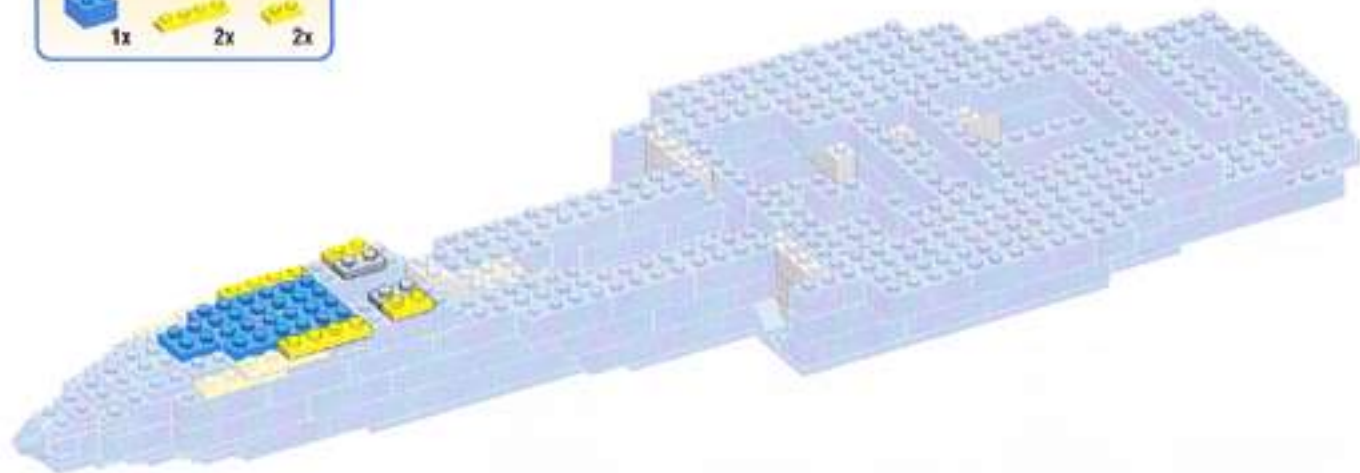
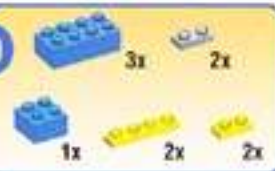



Active step / Étape active / Etapa activa /
Istruzione attuale / Aktiv skede /
Folgende stap / 此為目前步驟 / 現段階

Previous step / Étape précédente / Etapa
precedente / Istruzione precedente /
Föregående skede / Vorige stap / 此為前一步驟 / 前段階



30

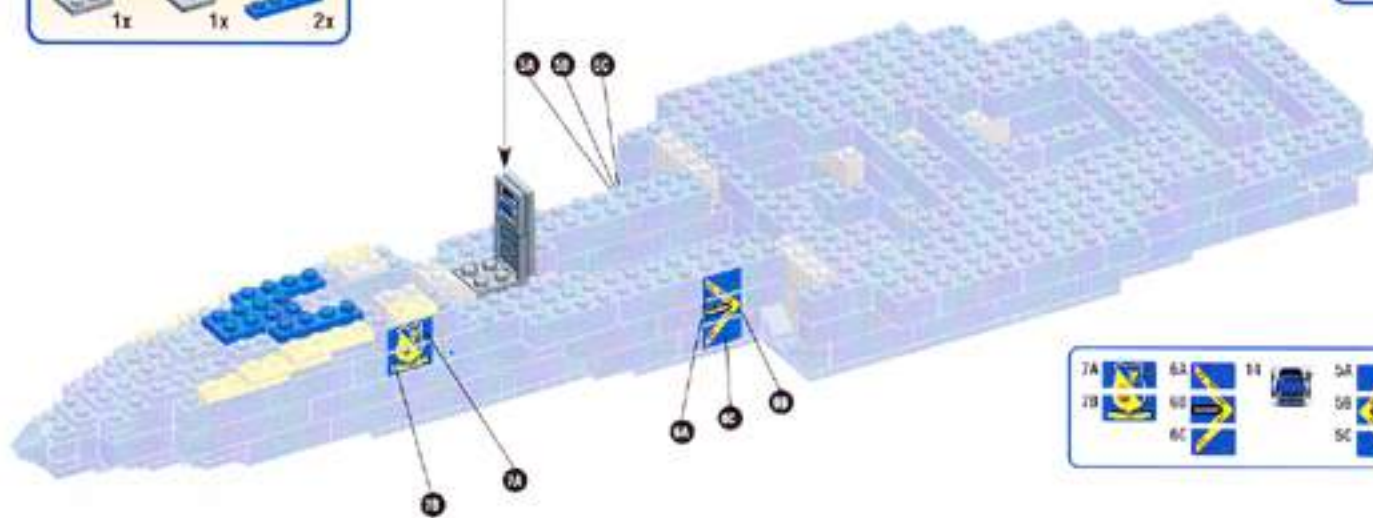
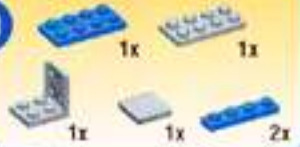

31

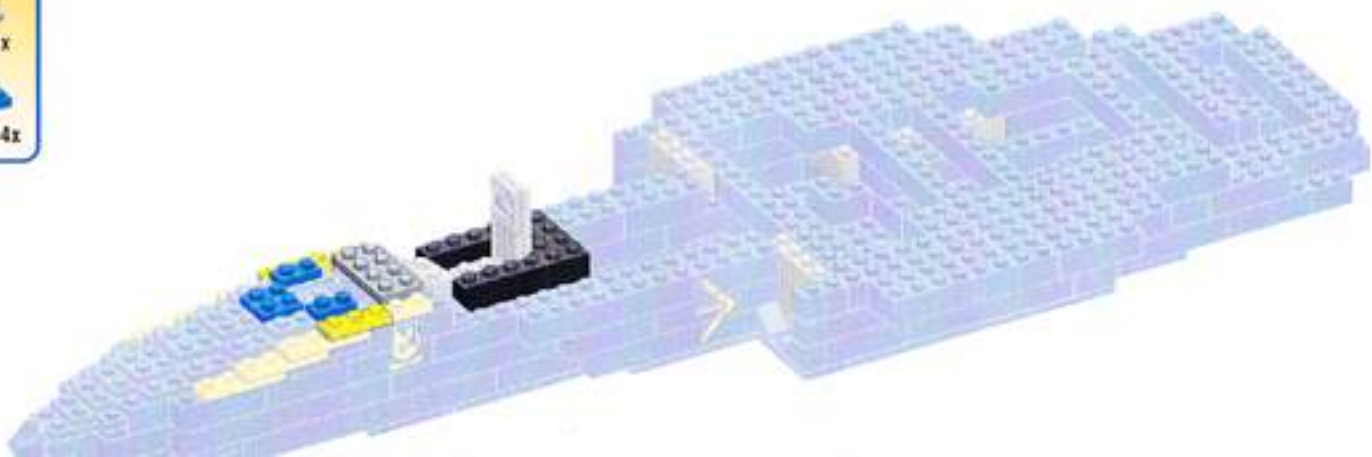
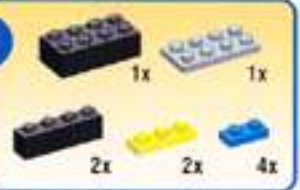

32

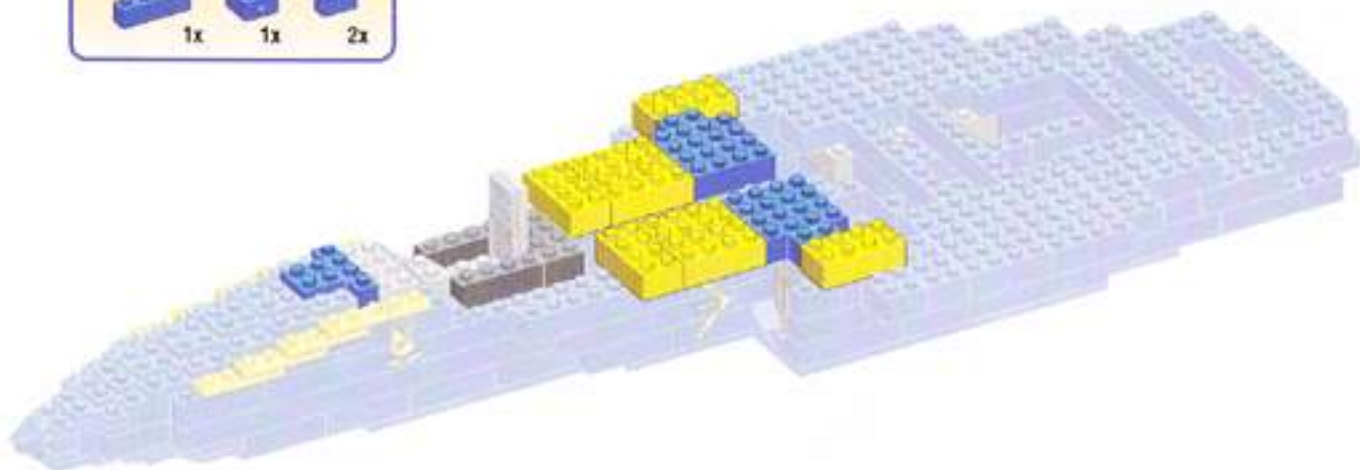

33

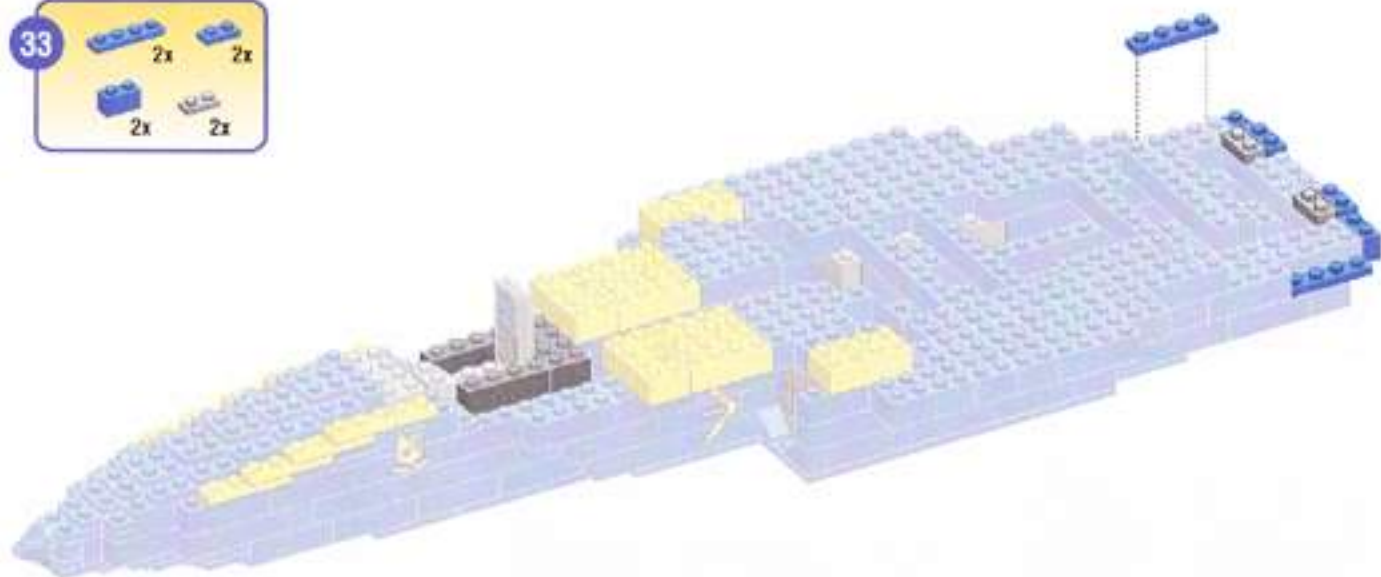



Active step / Étape active / Etapa activa /
Istruzione attuale / Aktiv skede /
Følgende steg / 次のステップ / 次段階

Previous step / Étape précédente / Etapa precedente /
Istruzione precedente / Istruzione precedente /
Føregående skede / Yöriye steg / 次のステップ / 前段階



34

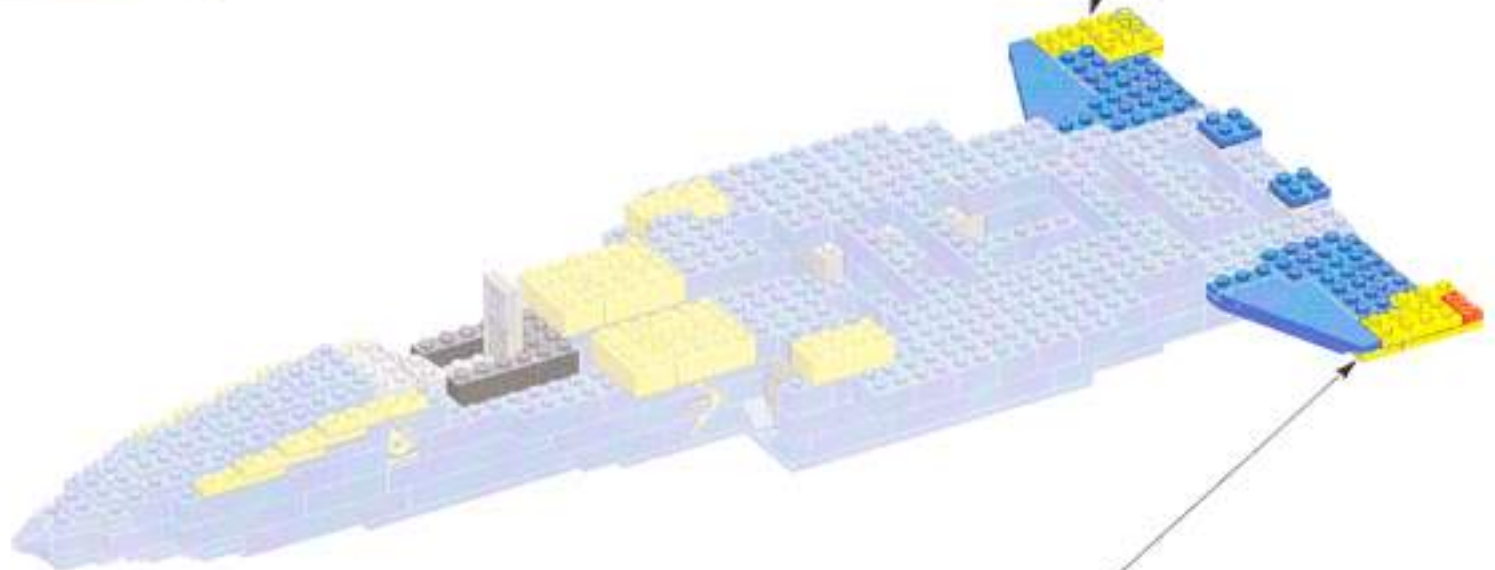
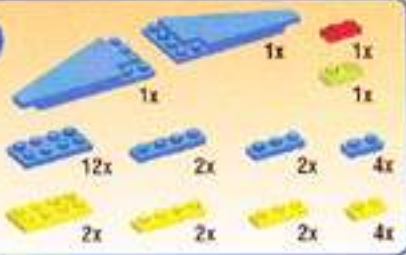

35

5x 2x

2x 1x

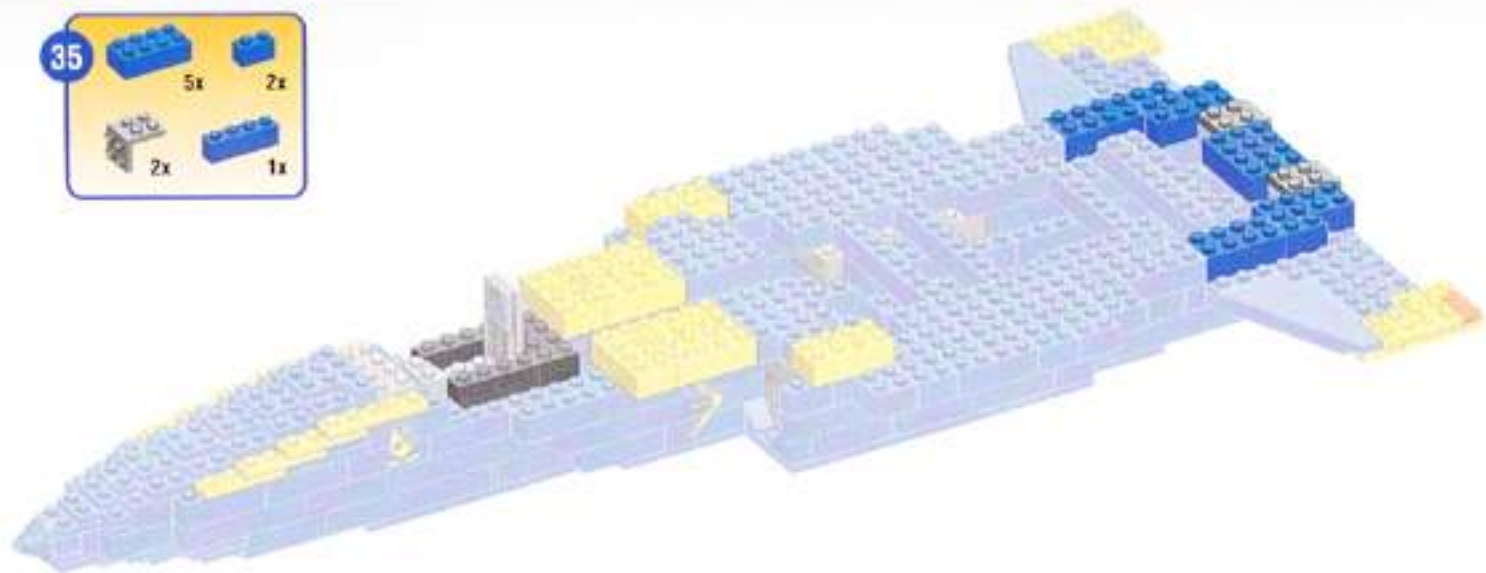

36

3x

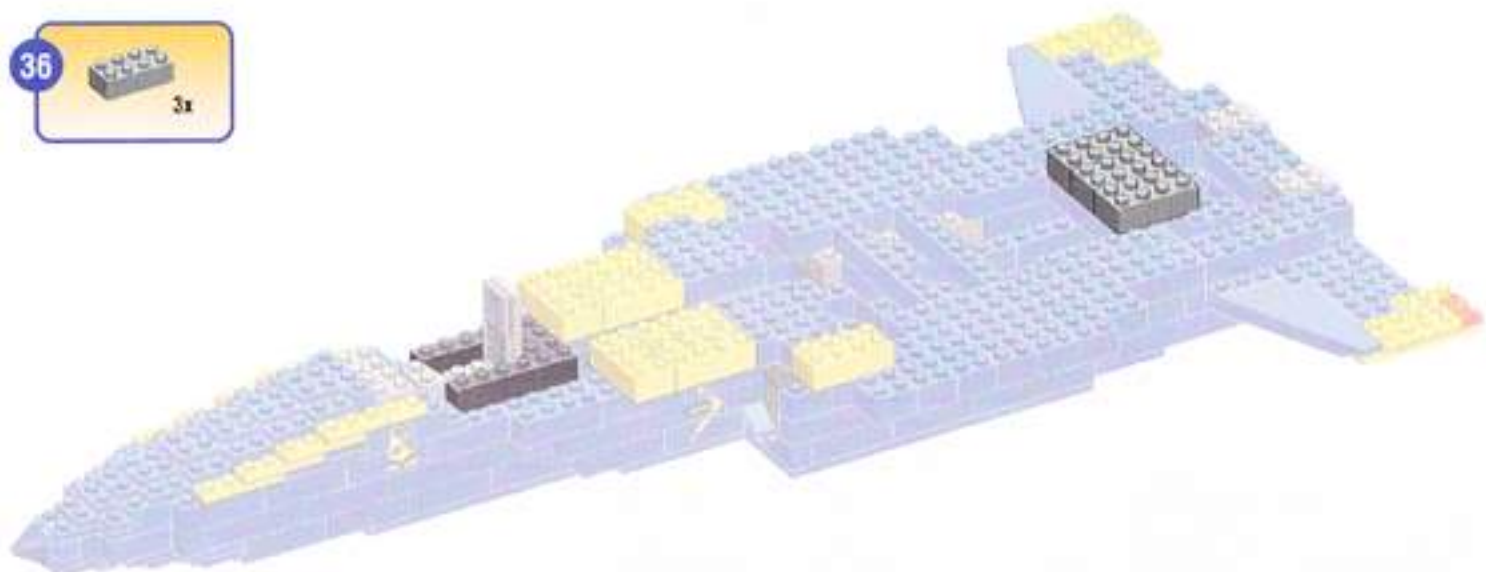



Active step / Étape active / Etapa activa /
Istruzione attuale / Aktiv skede /
Folgende step / 次のステップ / 次段階

Previous step / Étape précédente / Etapa
precedente / Istruzione precedente /
Föregående skede / Yorige stap / 前段階



37

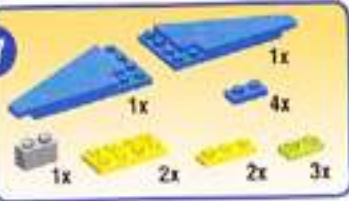

1

2

3

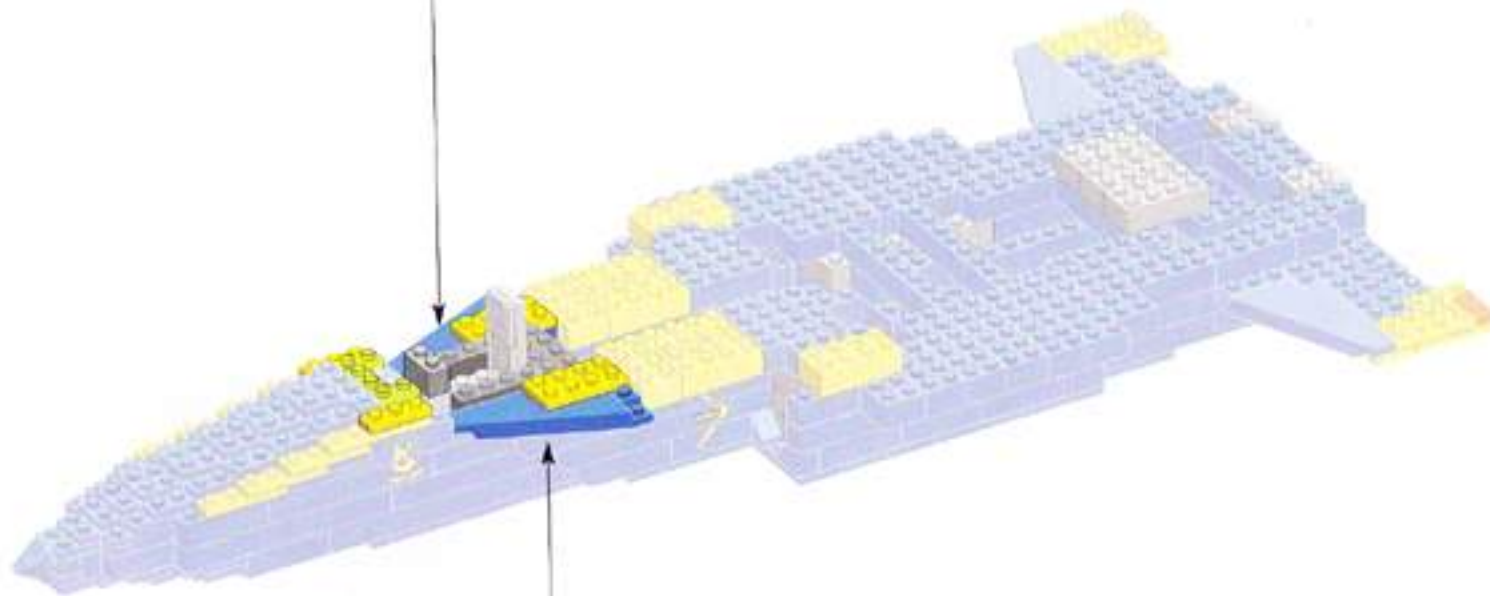

1

2

3

38

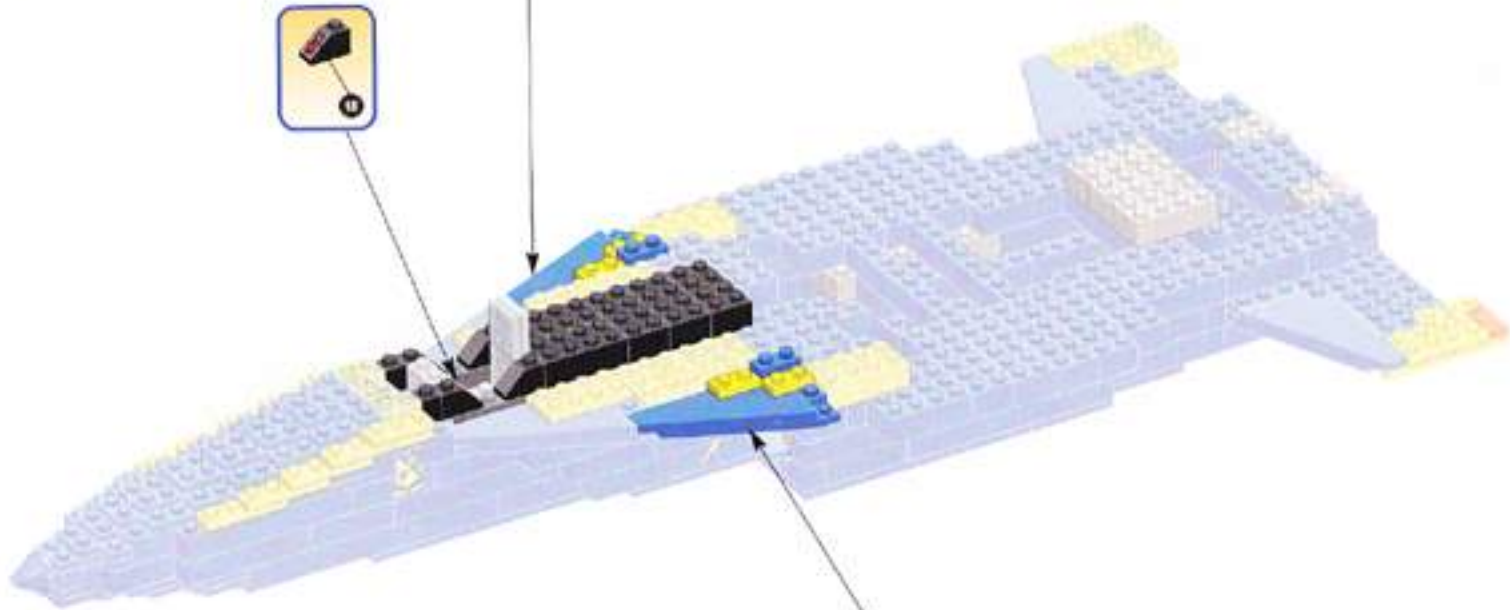
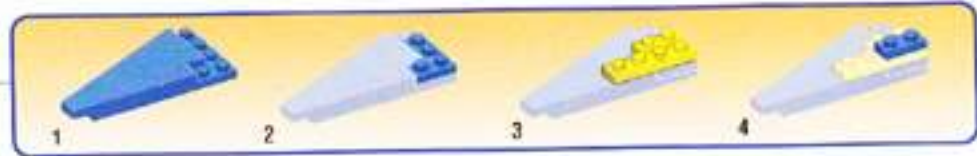



Active step / Étape active / Etapa activa /
Istruzione attuale / Aktiv skede /
Folgende stap / 次のステップ / 次段階

Previous step / Étape précédente / Etapa
precedente / Istruzione precedente /
Föregående skede / Vorige stap / 前のステップ / 前段階



39

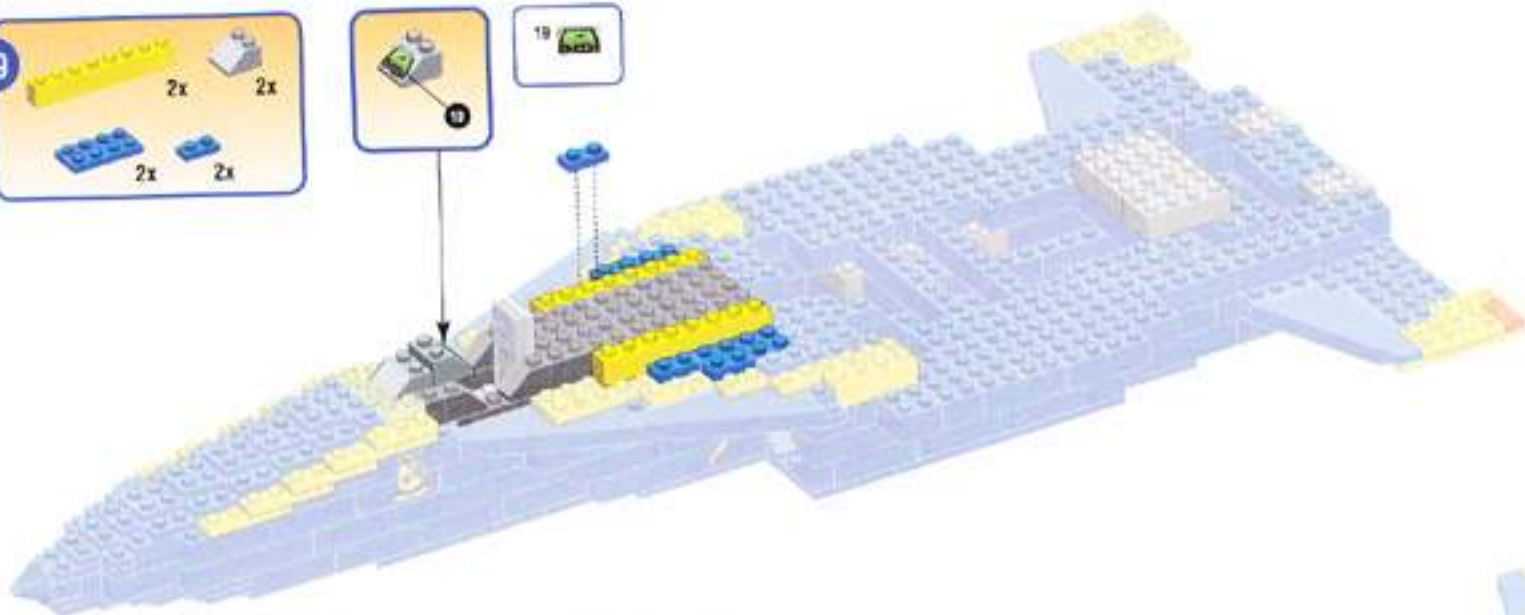

40

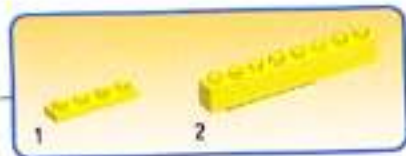
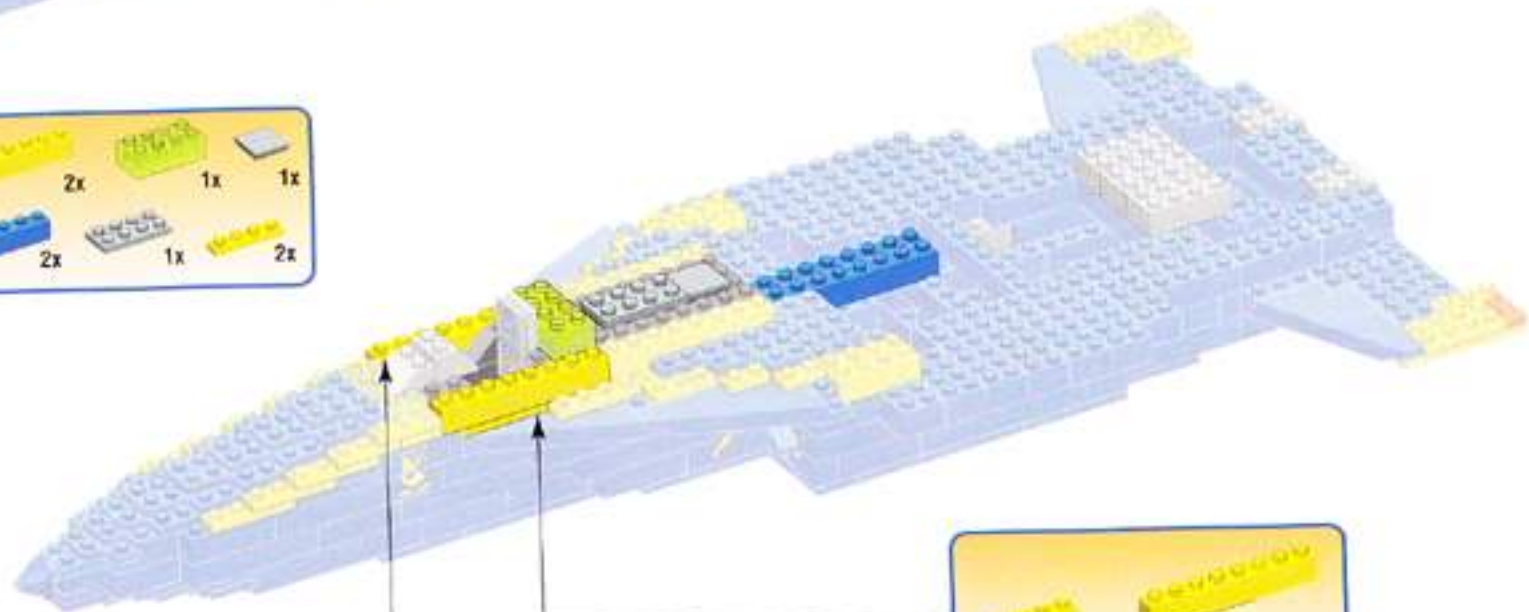
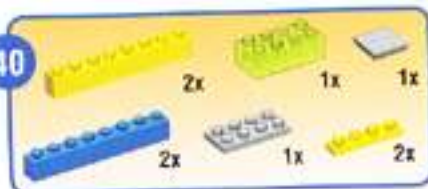

41



12x

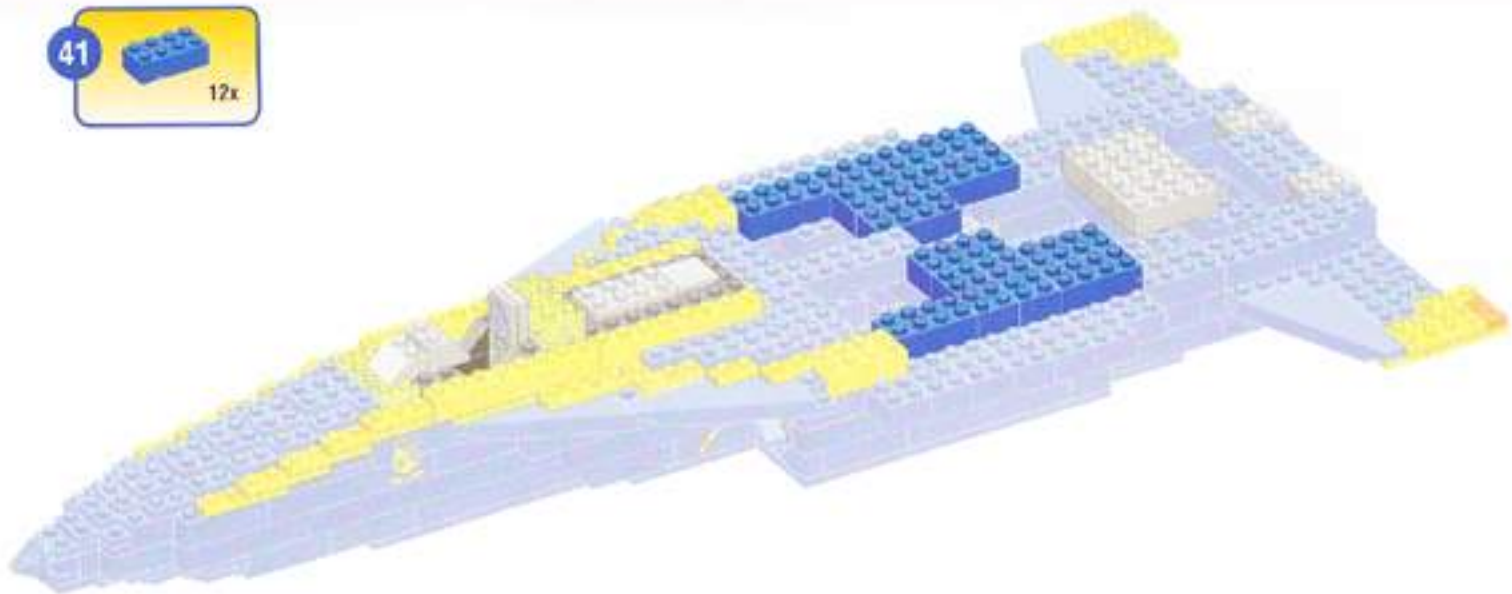

42



7x



6x



2x



8x



8x

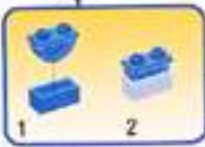
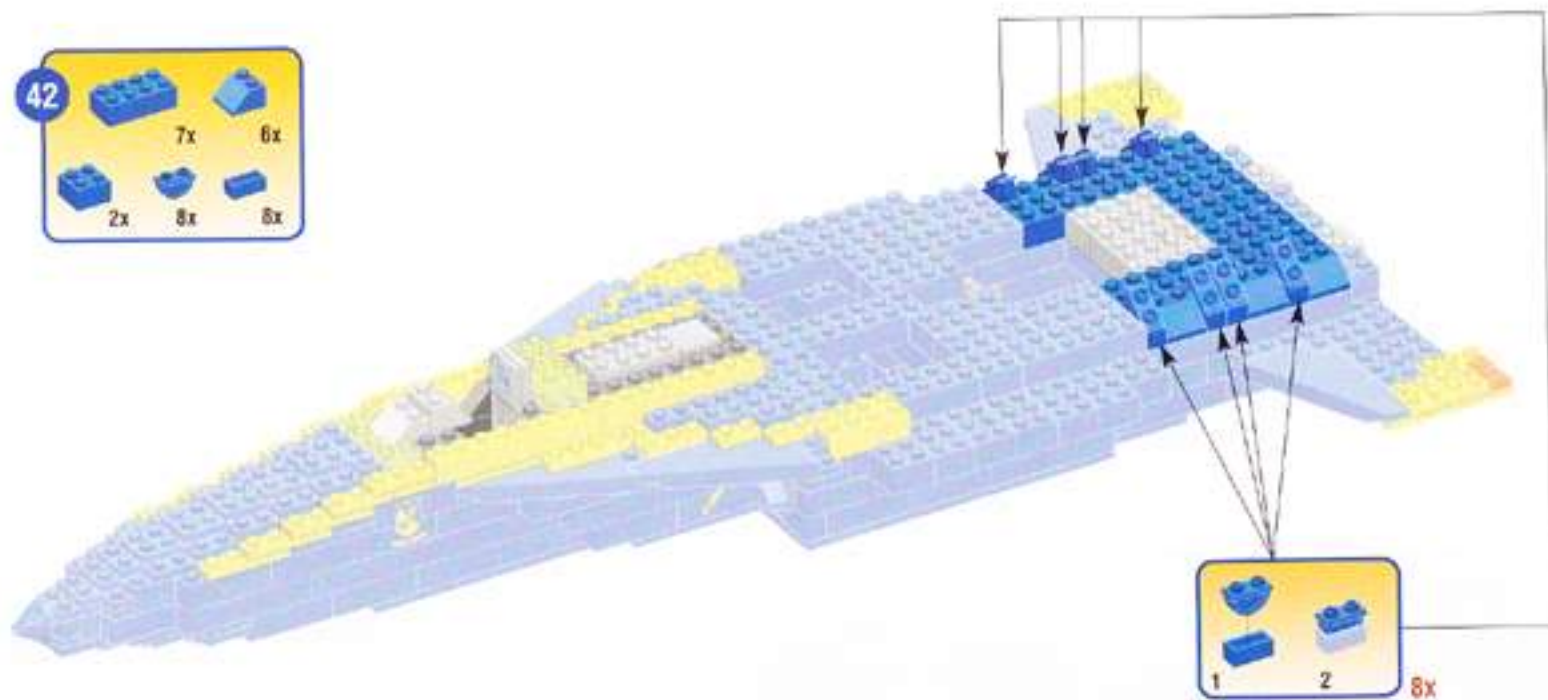

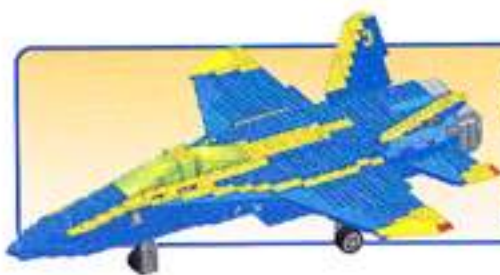

Active step / Étape active / Etapa activa /
Istruzione attuale / Aktiv skede /
Folgende stap / 現在の工程 / 現段階

Previous step / Étape précédente / Etapa
precedente / Istruzione precedente /
Föregående skede / Vorige stap / 以前の工程 / 前段階



43

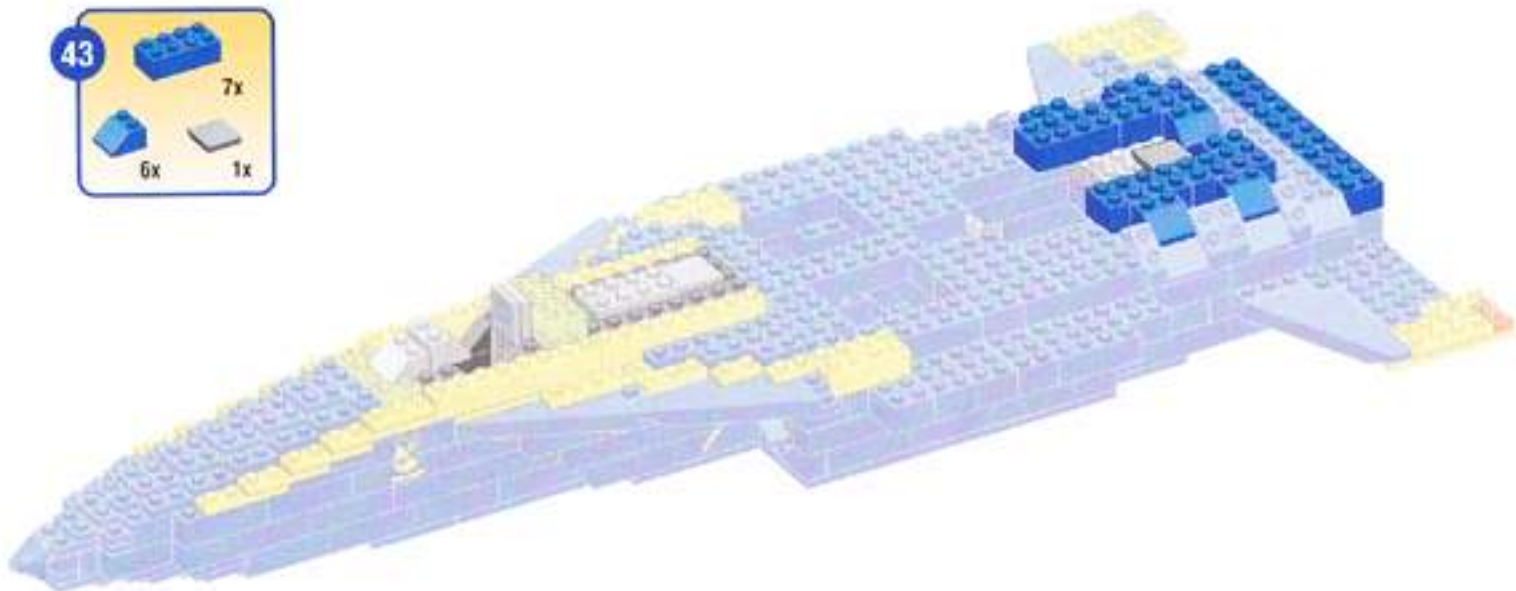

44

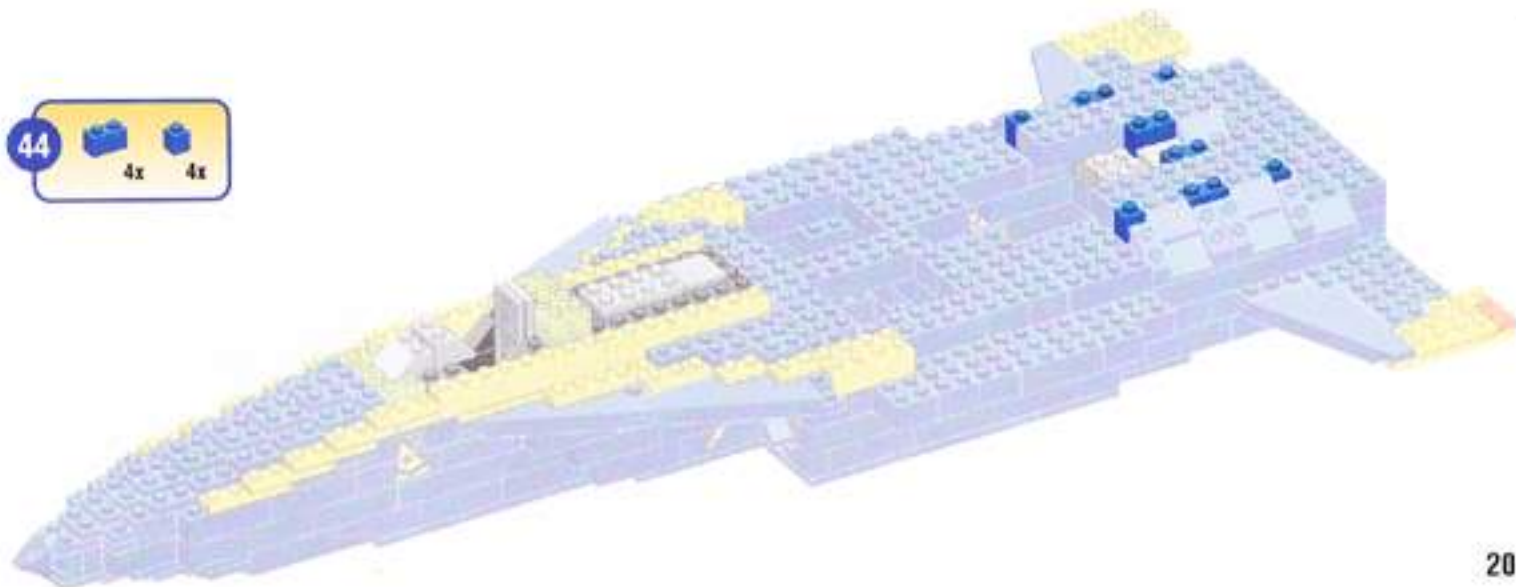

45



2x



8x

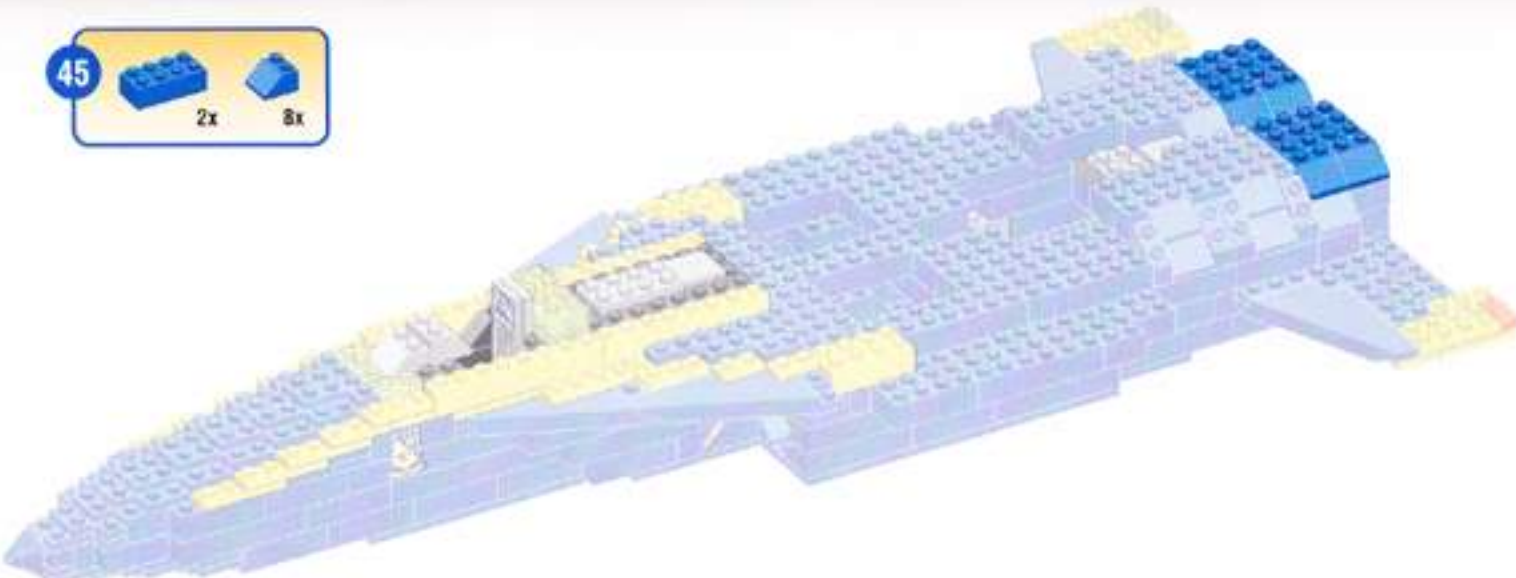

46



4x

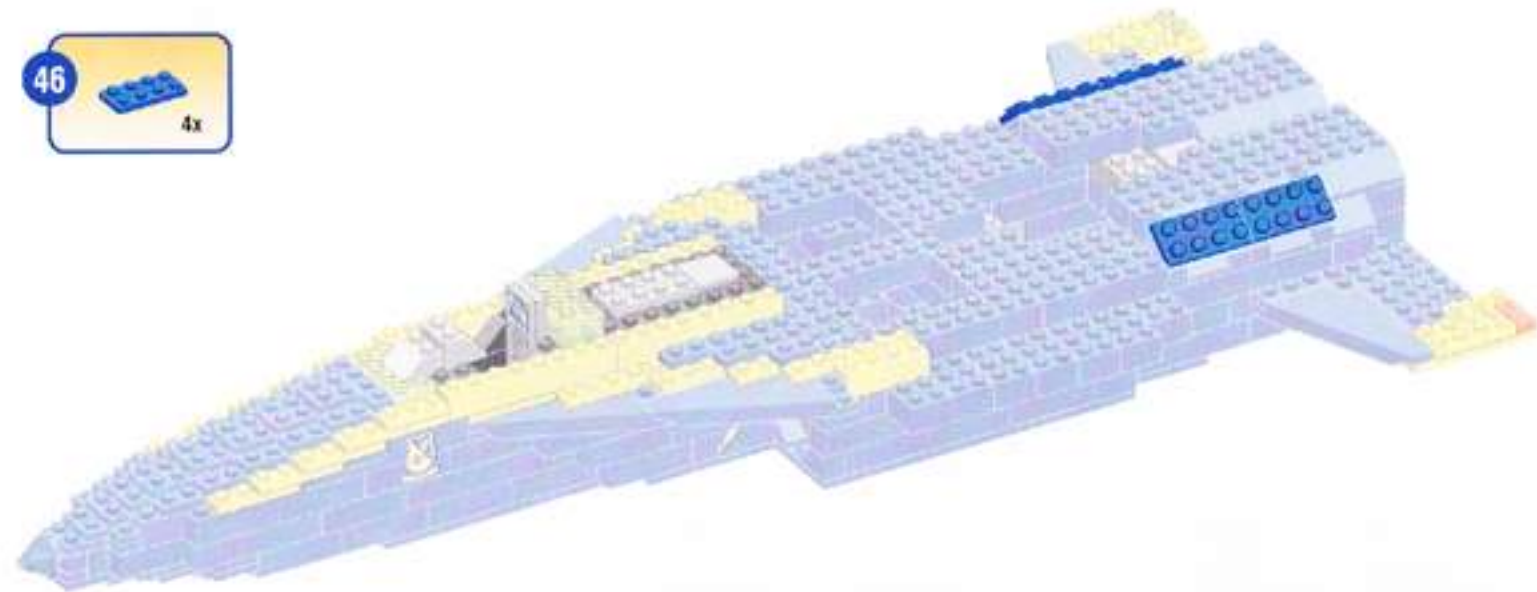



Active step / Étape active / Etapa activa /
Istruzione attuale / Aktiv skede /
Folgende stap / 此步为步骤 / 此段为

Previous step / Étape précédente / Etapa
precedente / Istruzione precedente /
Föregående skede / Yorige stap / 此步为前段 / 前段为



47



8x

2x

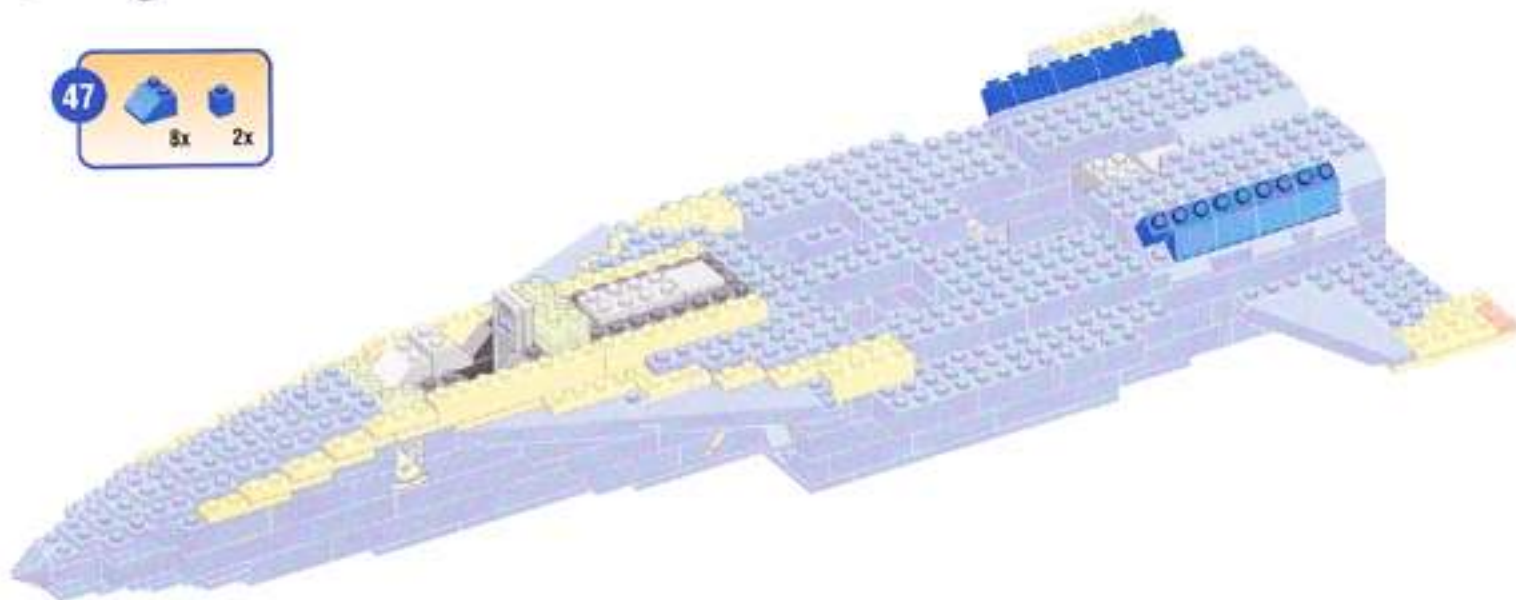

48

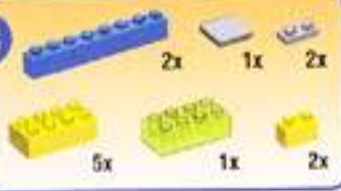

2x

1x

2x

5x

1x

2x

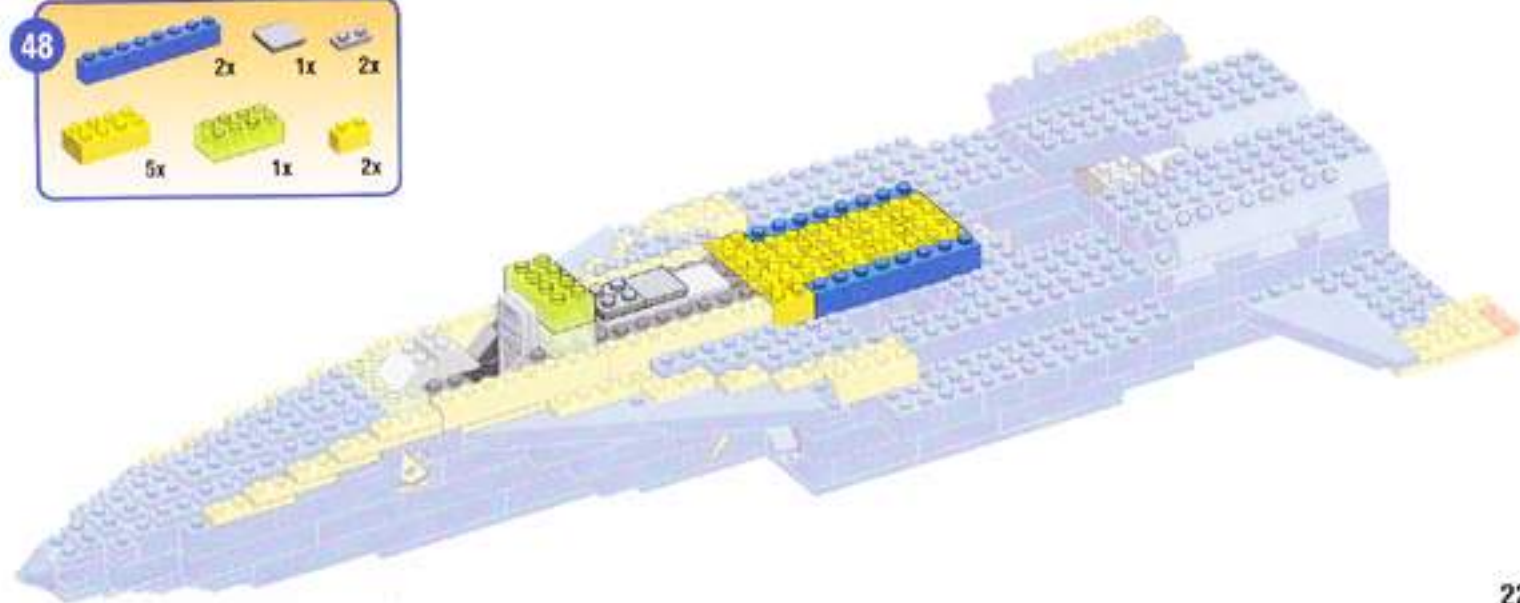

49

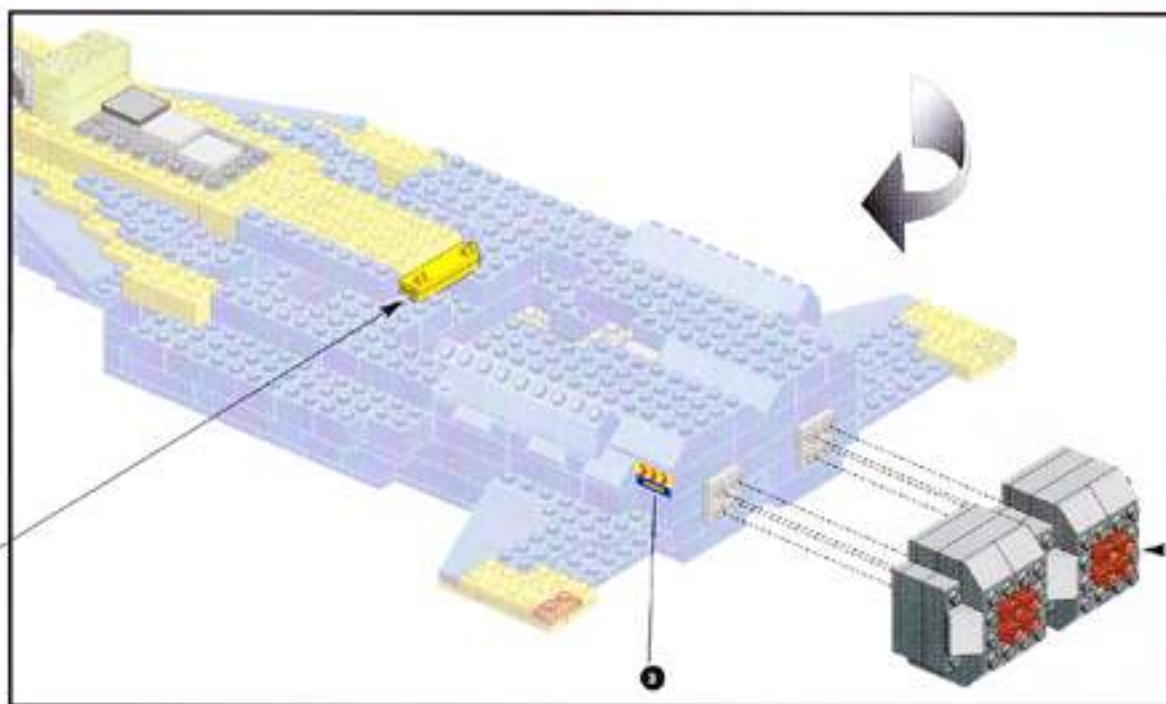
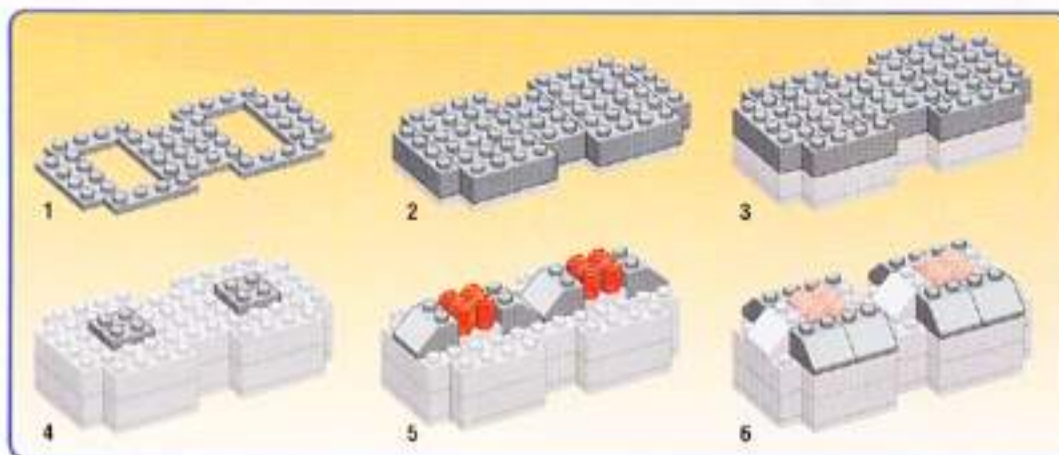
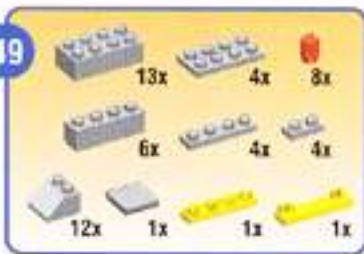



Active step / Étape active / Etapa activa /
Istruzione attuale / Aktiv skede /
Folgende stap / 現在のステップ / 現段階

Previous step / Étape précédente / Etapa
precedente / Istruzione precedente /
Føregående skede / Vorige stap / 前のステップ / 前段階



50

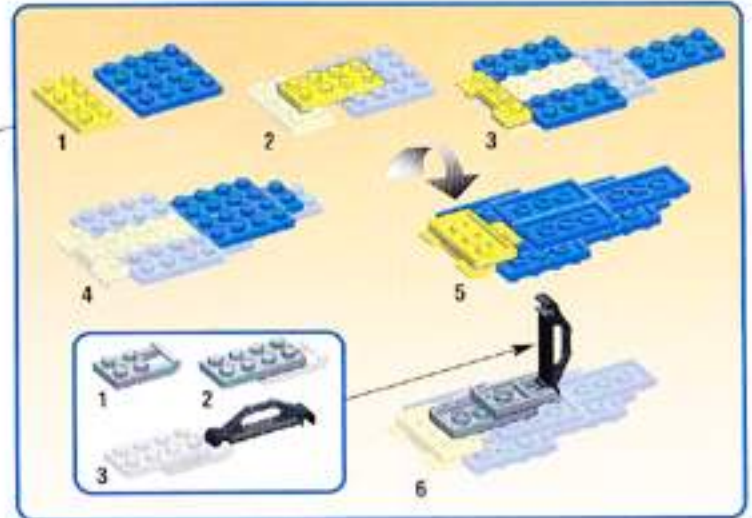
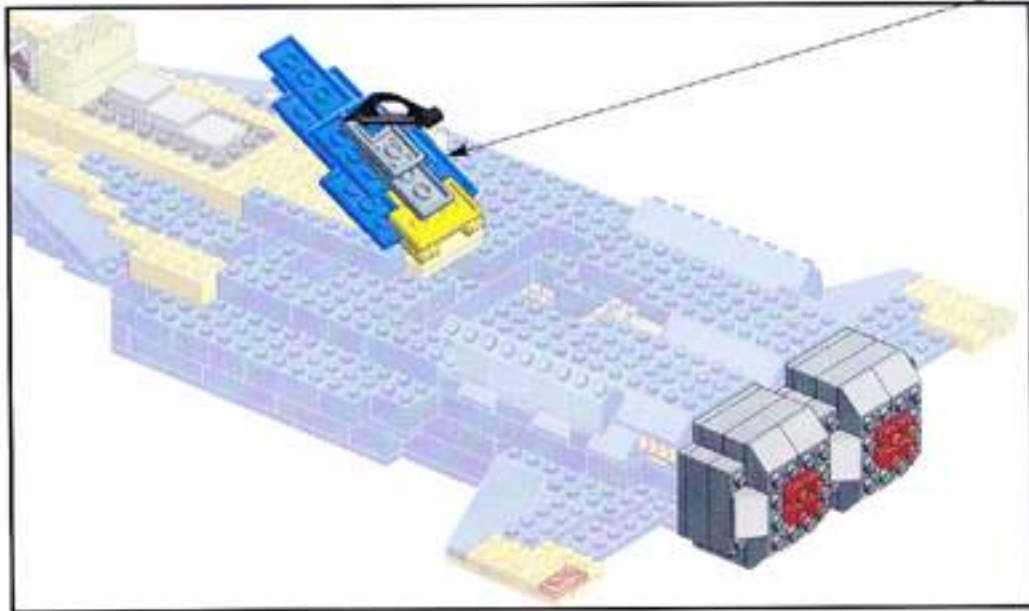

51

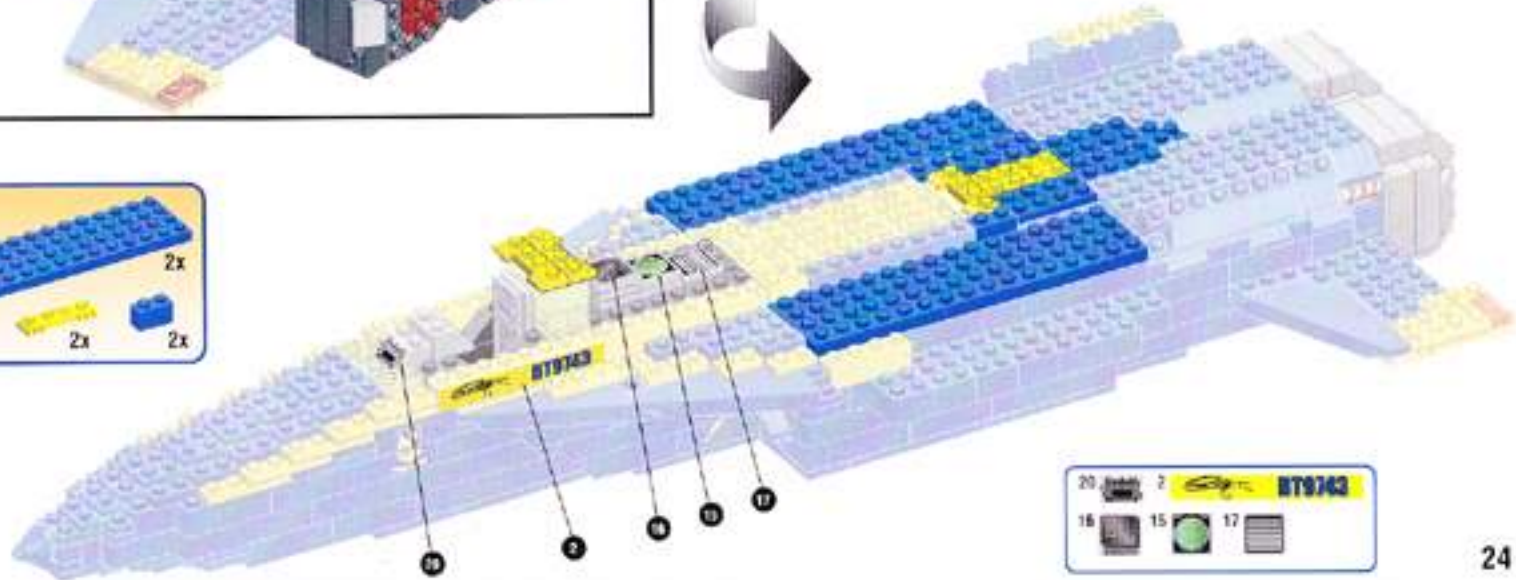
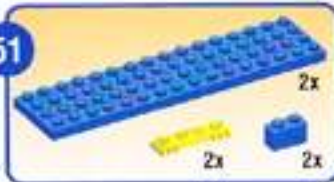

52

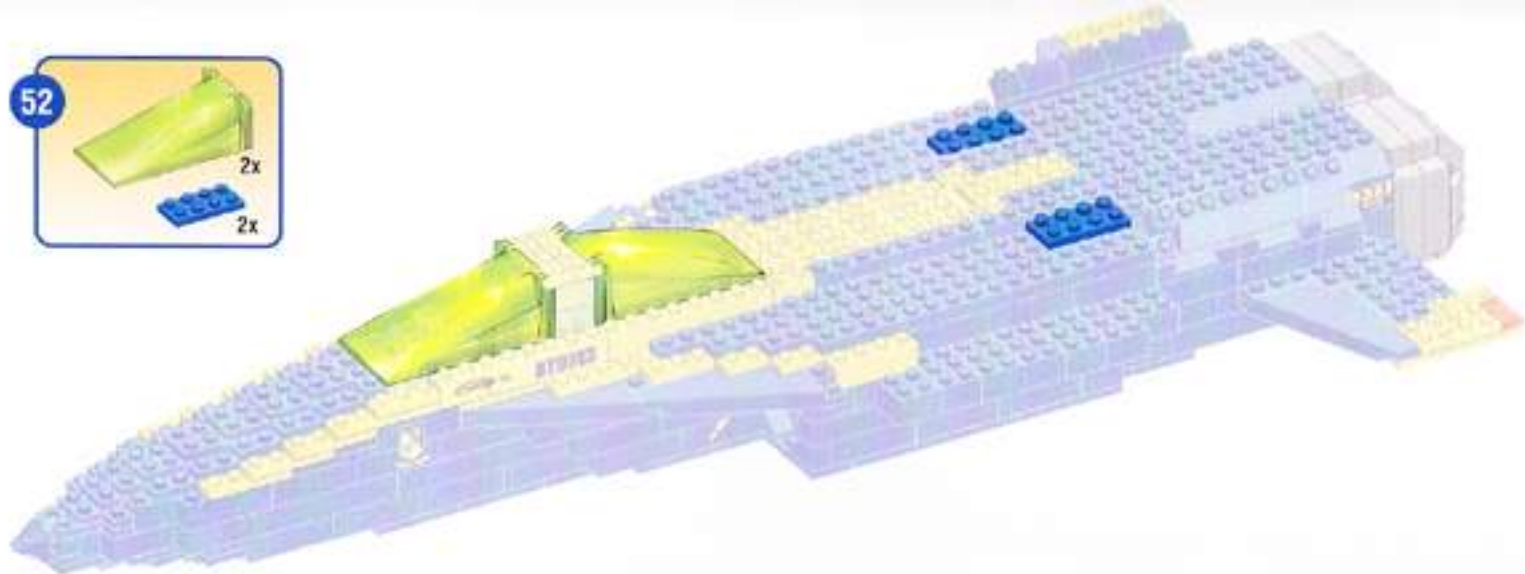

53

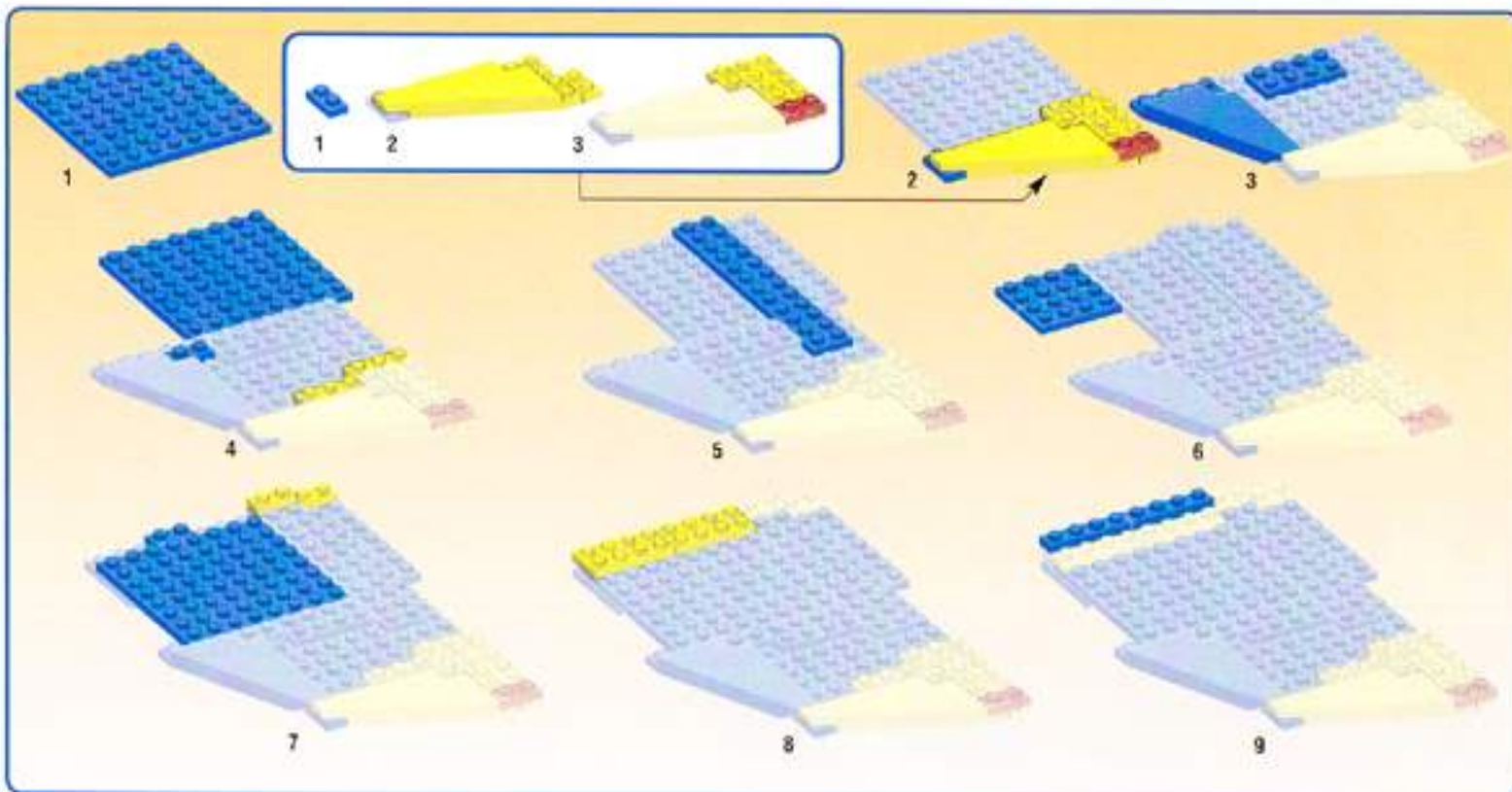



Active step / Étape active / Etapa activa /
Istruzione attuale / Aktiv skede /
Følgende steg / 此步为步骤 / 此步骤

Previous step / Étape précédente / Etapa
precedente / Istruzione precedente /
Føregående skede / Forrige steg / 前步骤



54

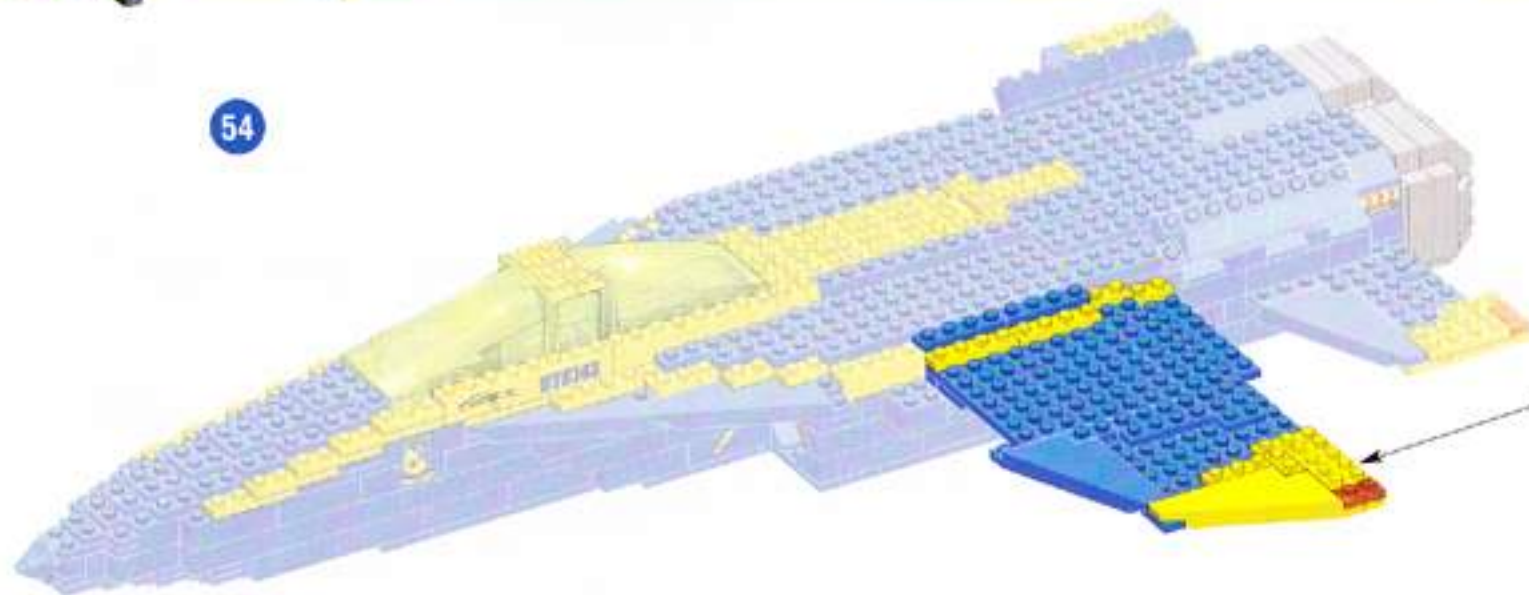

53





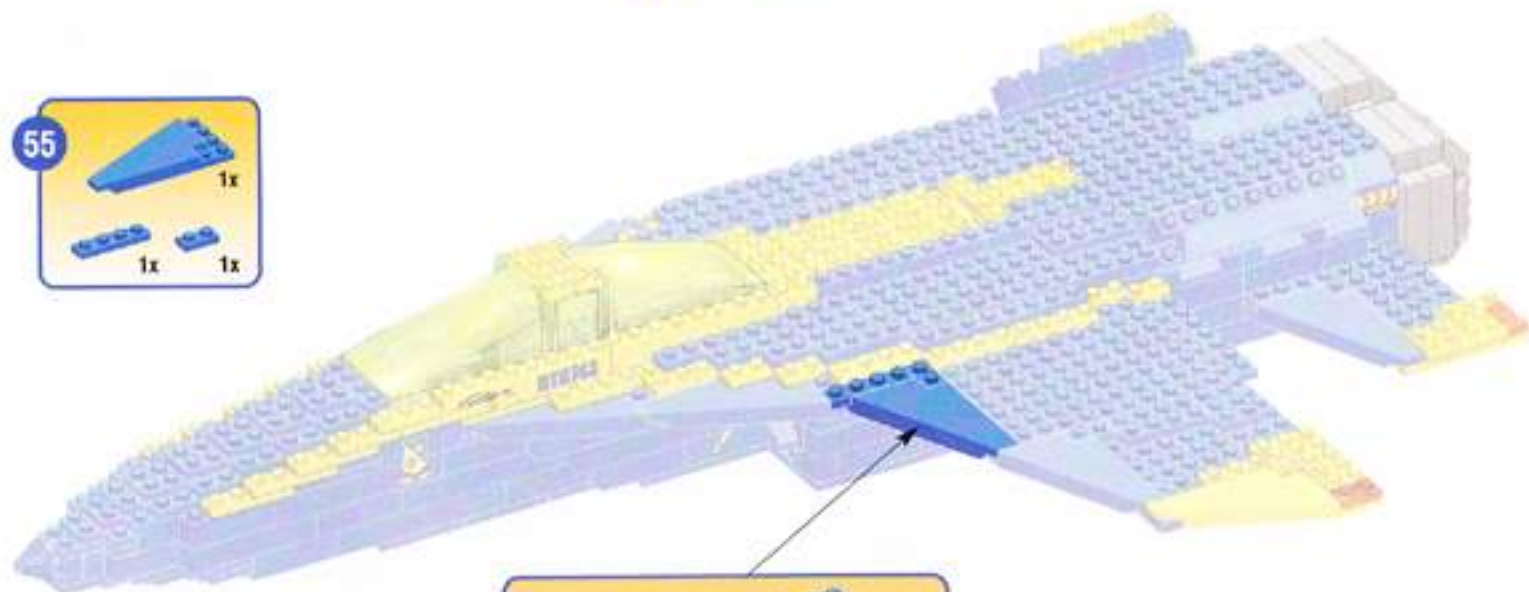







55

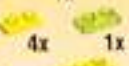

1

2

56

-  3x
-  1x
-  4x
-  1x
-  1x
-  3x
-  1x
-  3x
-  2x
-  2x
-  3x





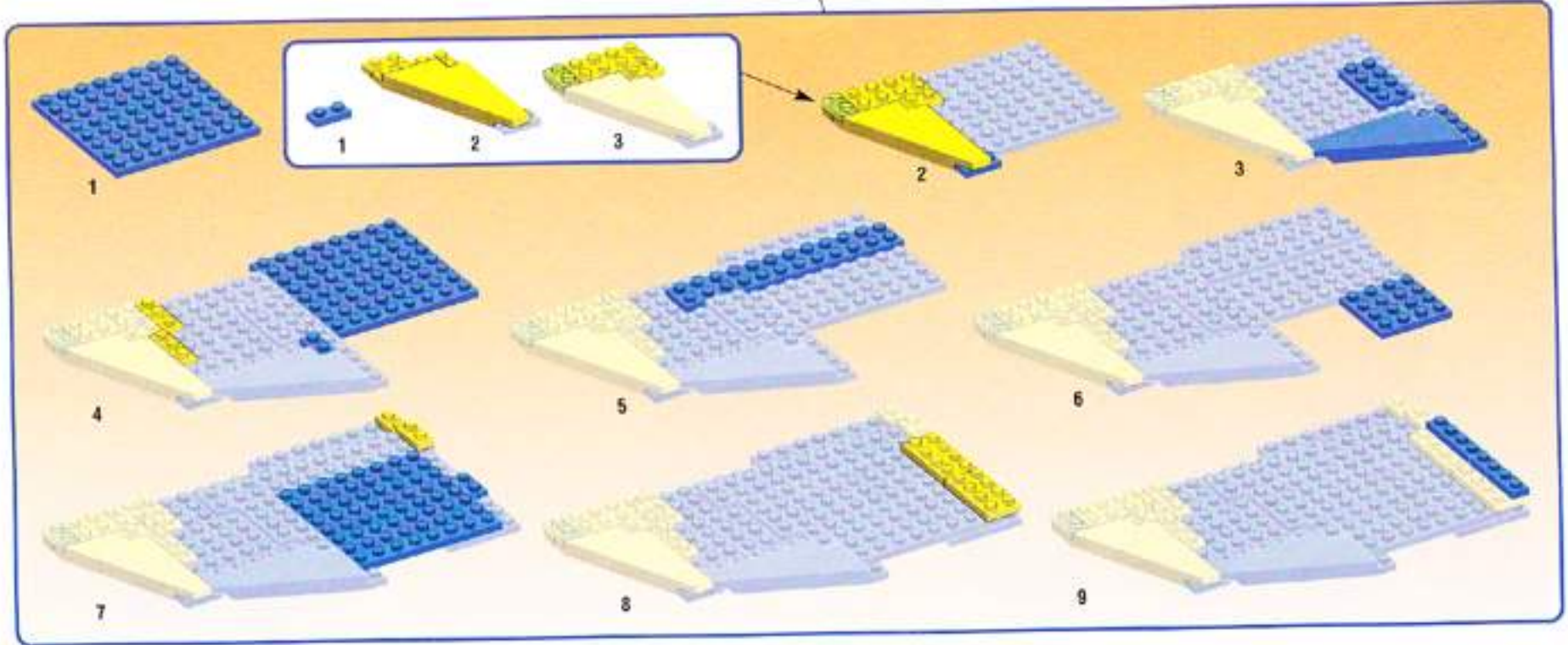
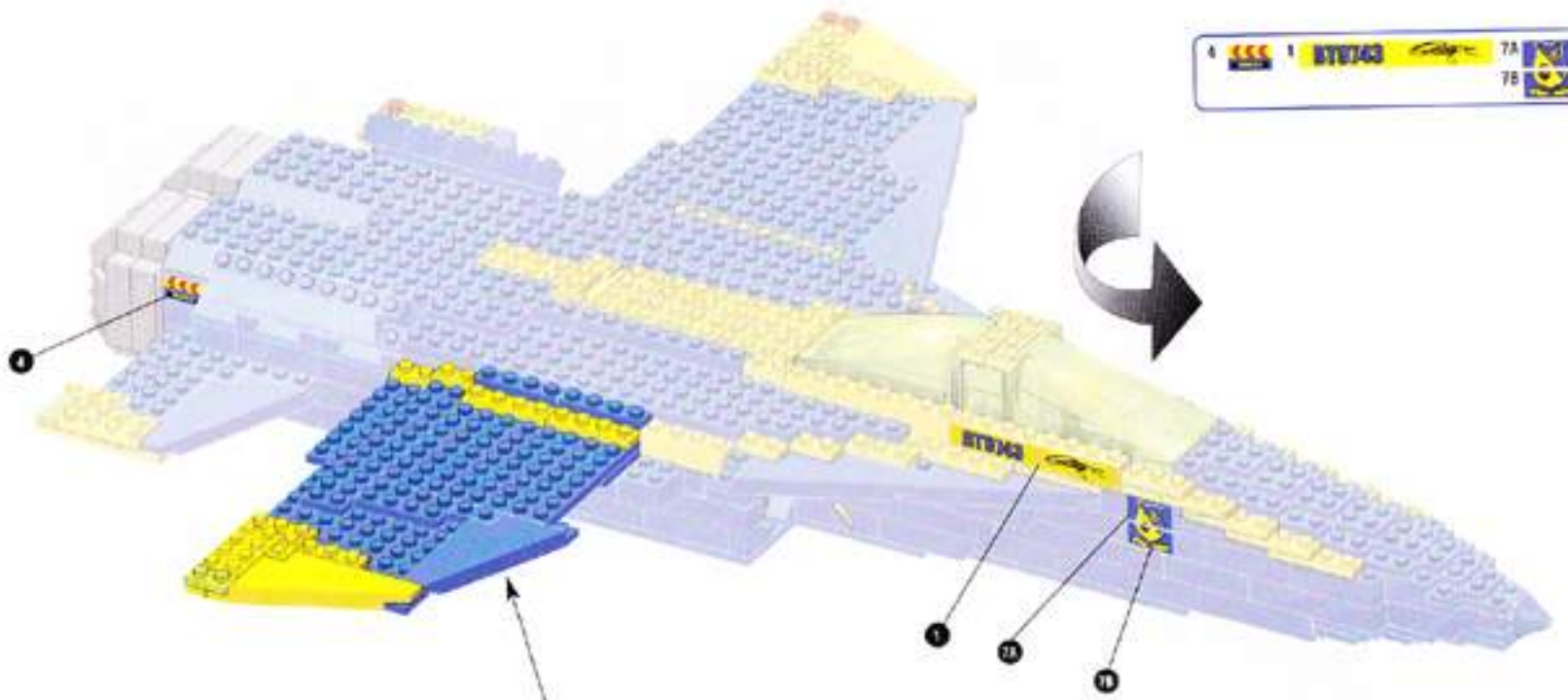



Active step / Étape active / Etapa activa /
Istruzione attuale / Aktiv skede /
Folgende stap / 此為第 57 步 / 此為第 57 步

Previous step / Étape précédente / Etapa precedente /
Istruzione precedente / Föregående skede /
Vorige stap / 此為第 56 步 / 此為第 56 步



57

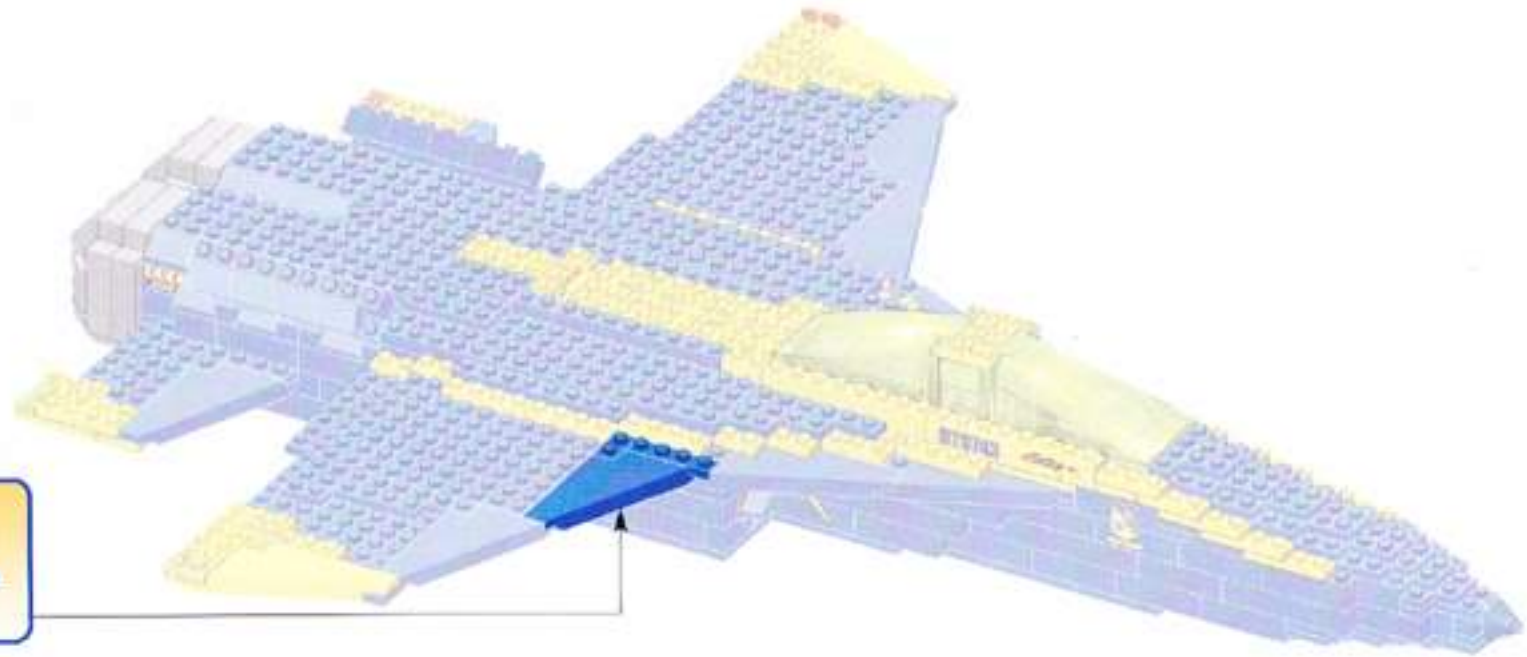
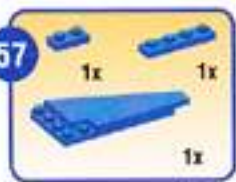

58

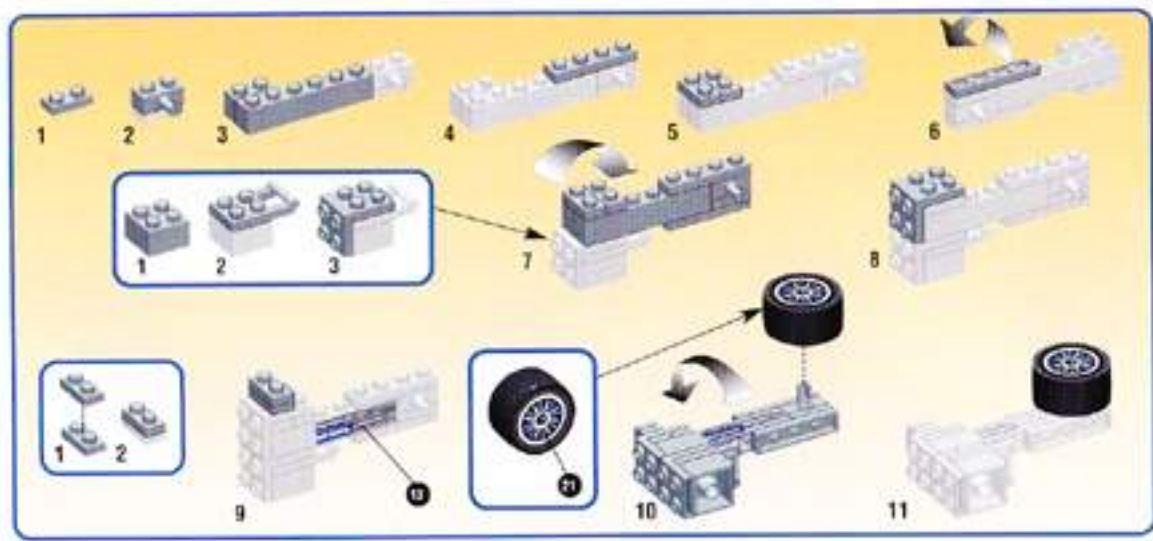

59

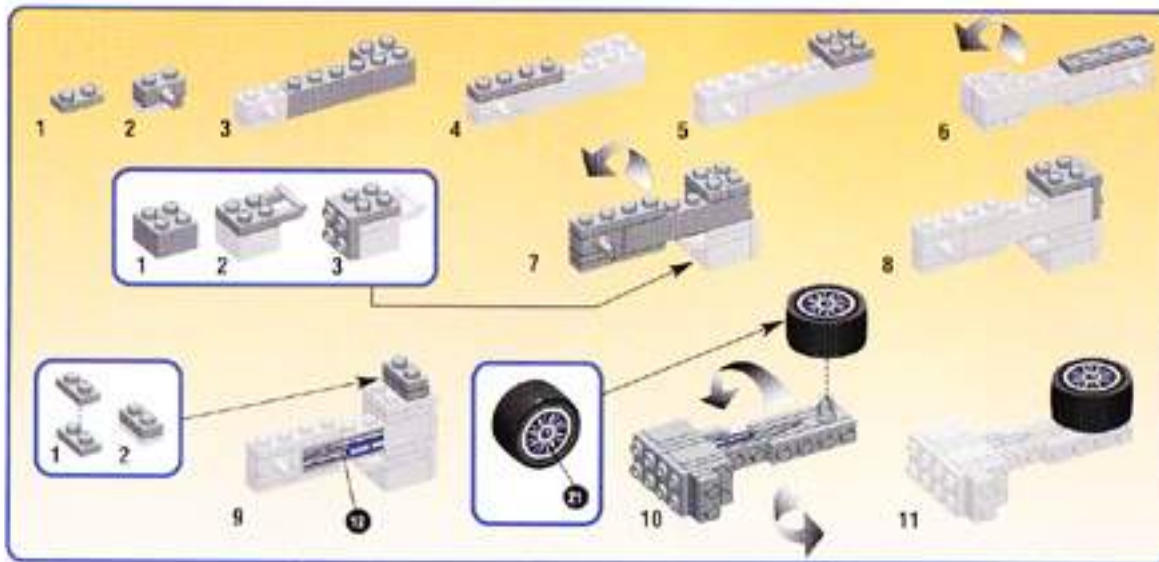

60

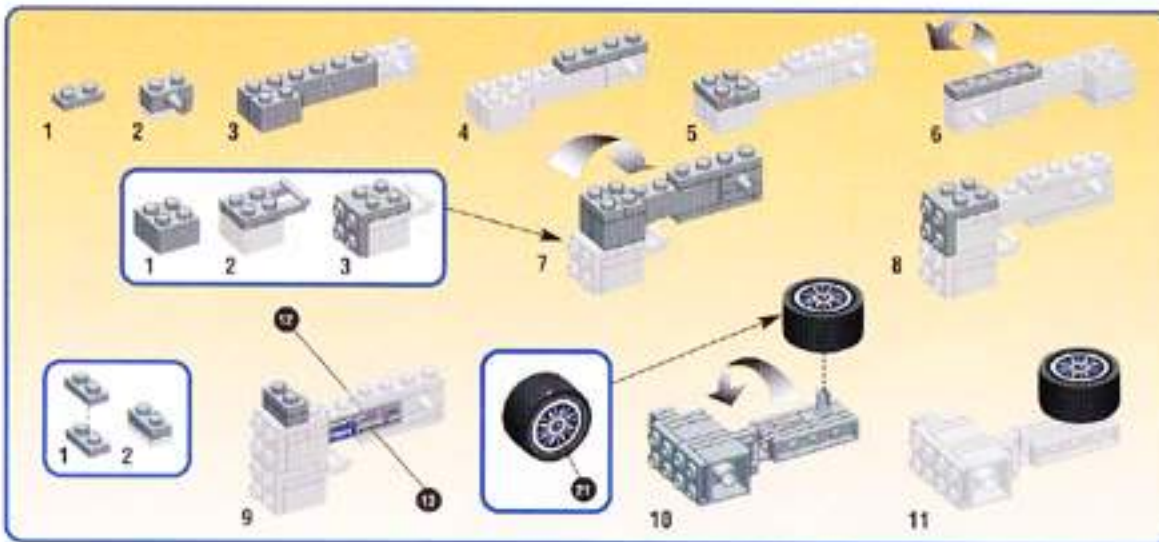



Active step / Étape active / Etapa activa /
Istruzione attuale / Aktiv skede /
Folgende stap / 次のステップ / 次段段

Previous step / Étape précédente / Etapa
precedente / Istruzione precedente /
Føregående skede / Vorige stap / 前のステップ / 前段段



61

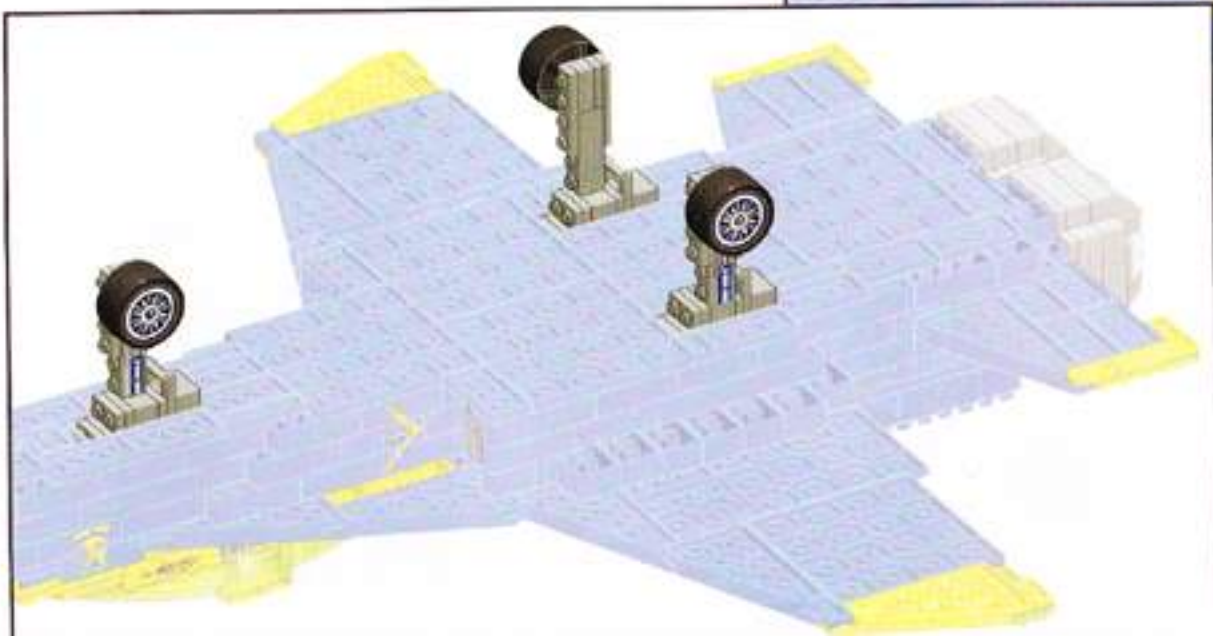
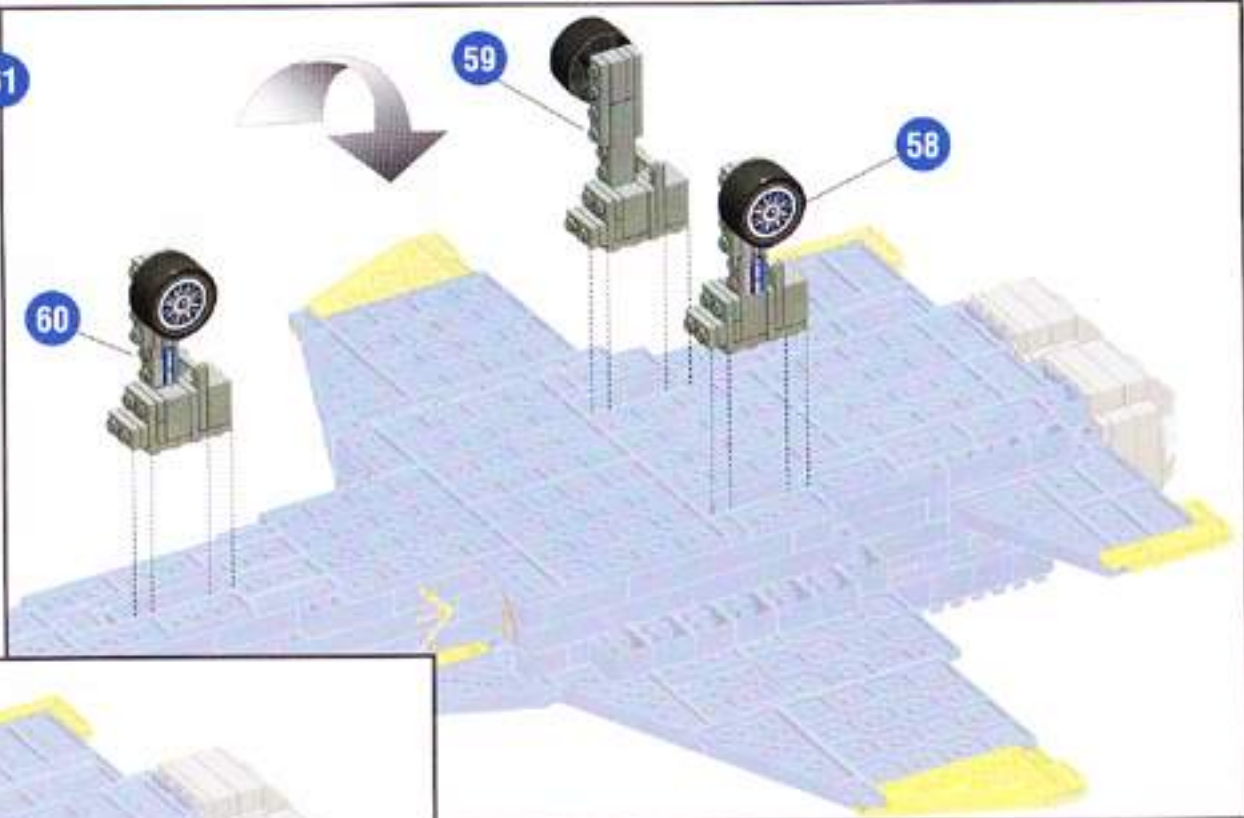

- 62
- 2x (Blue 1x3 Technic Brick)
 - 6x (Blue 1x2 Technic Brick)
 - 2x (Blue 1x1 Technic Brick)
 - 2x (Blue 1x2 Technic Brick)
 - 4x (Blue 1x1 Technic Brick)
 - 6x (Blue 1x1 Technic Brick)
 - 4x (Yellow 1x2 Technic Brick)
 - 4x (Yellow 1x1 Technic Brick)
 - 4x (Yellow 1x2 Technic Brick)
 - 2x (Yellow 1x1 Technic Brick)
 - 4x (Yellow 1x1 Technic Brick)

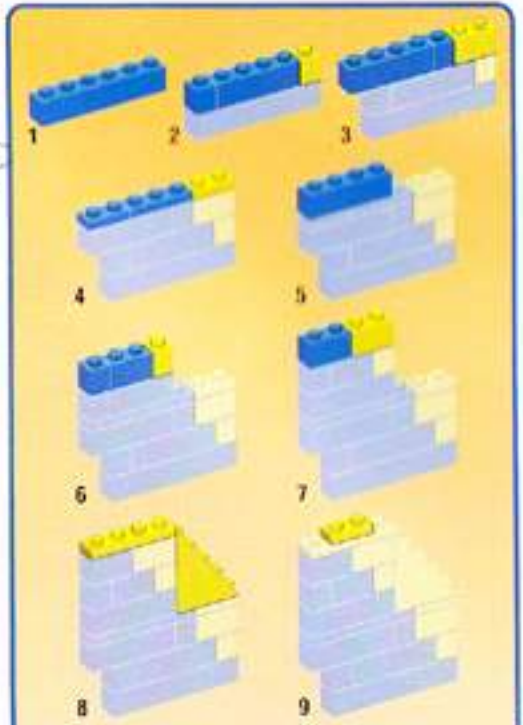
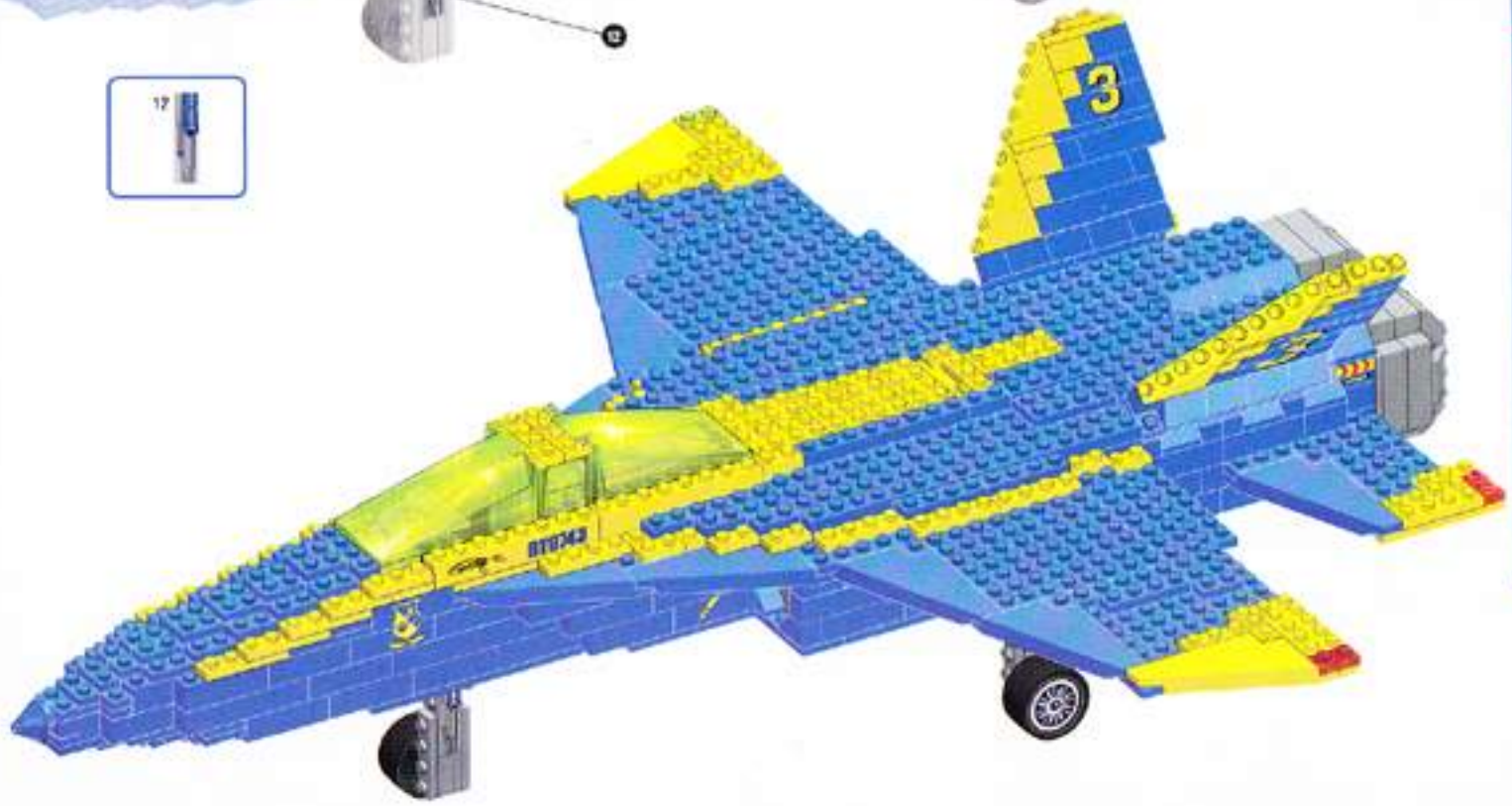
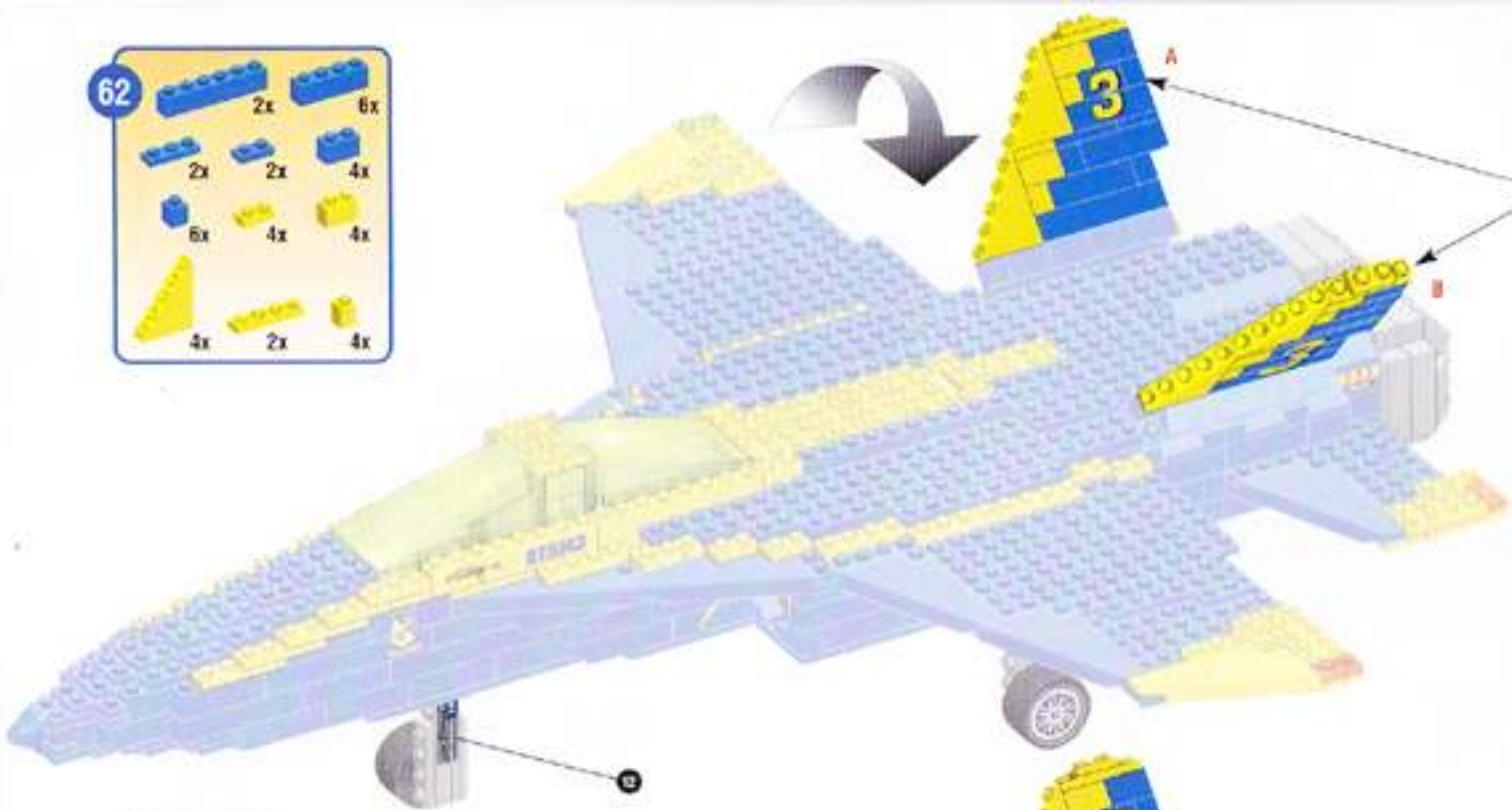

2x

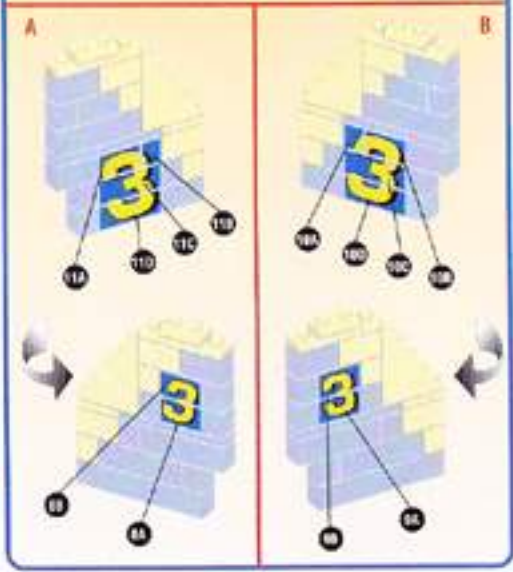



BLUE THUNDER™

9743



- Items illustrated can be built individually or with added components.
- Les items illustrés peuvent être construits individuellement ou avec des pièces additionnelles.
- Los objetos ilustrados pueden ser contruidos individualmente o con piezas adicionales.



Ritvik

© 2000, RITVIK HOLDINGS INC.
PRINTED IN CANADA D97431

INTERNET: WWW.MEGAOKS.COM