

**MEGA
BLOKS**

PROBUILDER

MASTER SERIES

9778

**Steam
Express**

10+ Ages/Edades
Åges/Leeftijden













1300 Pieces/Piezas
Pièces/Onderdelen



High Definition Building Parts Included / Piezas de construcción de alta definición incluidas
Pièces de construction de haute définition incluses / Fijn gedetailleerde bouwonderdelen inbegrepen

-  **9x**
M1113F
-  **3x**
AM02802JY
-  **5x**
AM02802JX
-  **12x**
M1113N
-  **4x**
M1113ZD
-  **8x**
M1312F
-  **4x**
AM02804JY
-  **20x**
M1312N
-  **4x**
M1225F
-  **4x**
M1225N
-  **8x**
M1140F
-  **1x**
AM01683A

-  **40x**
M1086F
-  **2x**
M09393DR
-  **77x**
M09393F
-  **2x**
AM02803JY
-  **4x**
M09393NF
-  **4x**
M09393N
-  **26x**
M1322F
-  **10x**
M1133F
-  **37x**
M09013F
-  **10x**
M1419F
-  **3x**
M1320F

-  **81x**
M022501F
-  **19x**
M022501N
-  **9x**
M022501E
-  **16x**
AM03328F
-  **2x**
M1086DR
-  **2x**
M1086NF
-  **1x**
AM01748ZD
-  **22x**
M1323F
-  **2x**
AM01684JY
-  **4x**
AM01684JX
-  **8x**
M11101F
-  **1x**
AM02183JY

-  **3x**
M1389F
-  **2x**
M1133N
-  **9x**
M10273F
-  **6x**
M1314DR
-  **33x**
M1314F
-  **2x**
M1314N
-  **4x**
AM02212F
-  **8x**
M1418F
-  **2x**
AM03872F
-  **4x**
AM03323F
-  **4x**
AM03324F

-  **18x**
M09593DR
-  **98x**
M09593F
-  **2x**
M09593NF
-  **2x**
M09593N
-  **37x**
M1087F
-  **2x**
M1390F
-  **2x**
M1087NF
-  **19x**
M1313F
-  **10x**
M1313NF
-  **12x**
M10233F

-  **39x**
M0948F
-  **27x**
M0948N
-  **10x**
M1417F
-  **12x**
AM03773F
-  **9x**
M09023F
-  **10x**
AM01793F
-  **1x**
AM04310JY
-  **11x**
M1154F
-  **6x**
AS097786



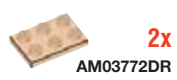

2x

AM03772DR



26x

AM03772F

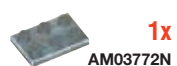

1x

AM03772N



23x

AM03873F



80x

M09493F



11x

M09493N



93x

M09033F

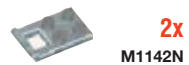

2x

M1142N



10x

M1141F

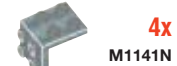

4x

M1141N



1x

M1153F

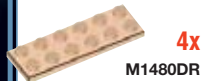

4x

M1480DR



48x

M1480F



2x

M1480N

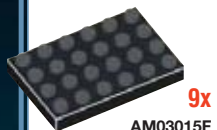

9x

AM03015F

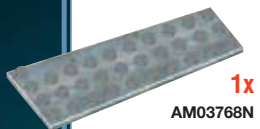

1x

AM03768N

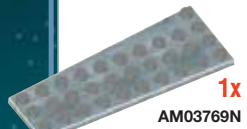

1x

AM03769N

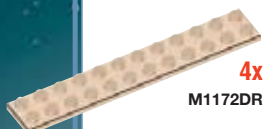

4x

M1172DR



31x

M1172F

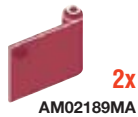

2x

AM02189MA



2x

AM02190MA

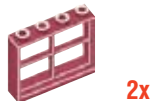

2x

AM04306MA

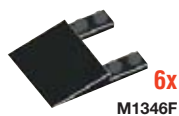

6x

M1346F

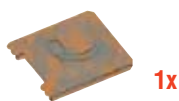

1x

AS097787

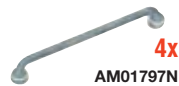

4x

AM01797N



3x

AM03057F

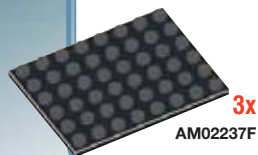

3x

AM02237F



8x

AM01317F



4x

X097343F



2x

AM04301F

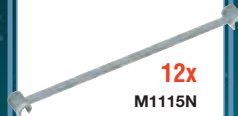

12x

M1115N



2x

S1163F



2x

AS097783



2x

AS097782

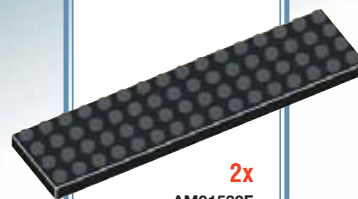

2x

AM01530F



6x

AS097781



1x

S1158F



2x

AS097784

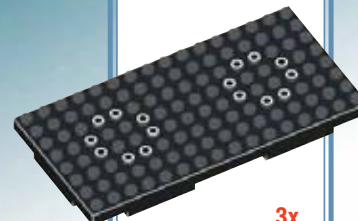

3x

AM03064F



1x

AS097785

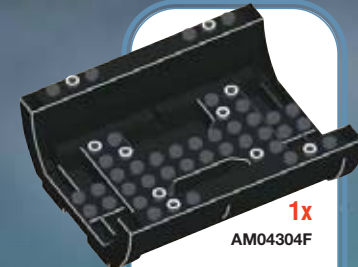

1x

AM04304F

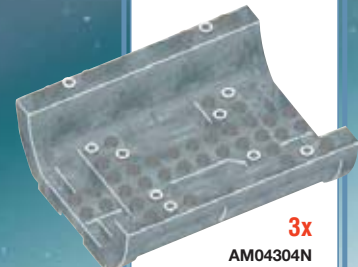

3x

AM04304N

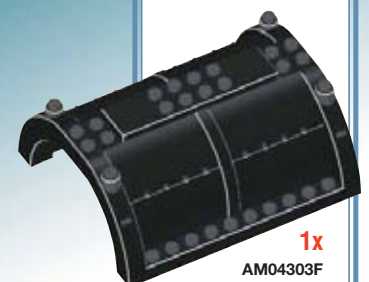

1x

AM04303F

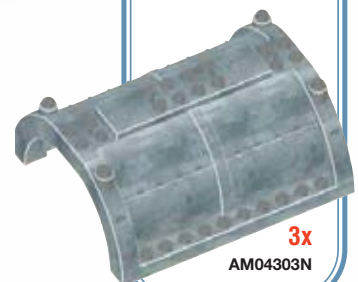

3x

AM04303N



Please read these instructions carefully before first use and keep them for future reference.
 Leer estas instrucciones cuidadosamente antes de la primera utilización y guardarlas para referencia futura.
 Il est recommandé de lire attentivement ce feuillet avant la première utilisation et de le conserver pour référence future.
 Wij raden u aan deze handleiding zorgvuldig te lezen en te bewaren voor eventuele raadpleging op een later tijdstip.

9778

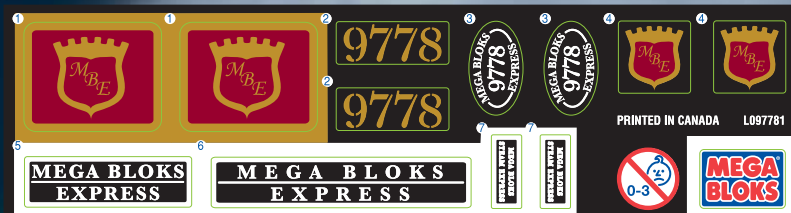

Apply stickers / Aplicar autoadhesivos
 Apposer les autocollants / Stickers aanbrengen

1x
 L097781

Color chart. Charte de couleurs. Kleurenkaart. カラーチャート
 Cuadro cromático. Färgtabell. Quadro cromatico. 色彩表

Active step / Etapa activa / Étape active / Aktivt skede
 Actieve stap / Azione attiva / アクティブなステップ / 積極步驟

Previous step / Etapa precedente / Étape précédente
 Föregående skedet / Vorige stap / Azione precedente
 前のステップ / 上一步驟

Active step / Etapa activa / Étape active / Aktivt skede
 Actieve stap / Azione attiva / アクティブなステップ / 積極步驟

Previous step / Etapa precedente / Étape précédente
 Föregående skedet / Vorige stap / Azione precedente
 前のステップ / 上一步驟

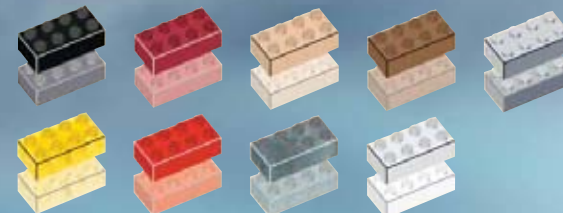

EN ⚠️ WARNING :
 CHOKING HAZARD. - Small parts.
 Not for children under 3 years.

ES ⚠️ ADVERTENCIA :
 PELIGRO DE ASFIXIA. - Contiene piezas pequeñas.
 No recomendado para niños menores de 3 años.

FR ⚠️ AVERTISSEMENT :
 RISQUE DE SUFFOCATION. - Présence de petits éléments.
 Ne convient pas aux enfants de moins de 3 ans.

NL ⚠️ WAARSCHUWING:
 VERSTIKKINGSGEVAAR. - Bevat kleine onderdelen.
 Niet geschikt voor kinderen onder de 3 jaar.

DE ⚠️ WARNUNG:
 ERSTICKUNGSGEFAHR. - Enthält kleine Teile.
 Nicht für Kinder unter 3 Jahren geeignet.

DA ⚠️ ADVARSEL:
 KVELNINGSFARE. - Indeholder smådele.
 Ikke til børn under 3 år.

EL ⚠️ ΠΡΟΕΙΔΟΠΟΙΗΣΗ:
 ΚΙΝΔΥΝΟΣ ΠΝΙΞΙΜΑΤΟΣ. - Περιέχει μικρά αντικείμενα.
 Όχι για παιδιά κάτω των 3 ετών.

FI ⚠️ VAROITUS:
 TUKEHTUMISVAARA. - Sisältää pieniä osia.
 Ei alle 3-vuotiaille lapsille.

IT ⚠️ ATTENZIONE:
 PERICOLO DI SOFFOCAMENTO. - Contiene piccole parti.
 Non indicato per bambini sotto i 3 anni.

NO ⚠️ ADVARSEL:
 KVELNINGSFARE. - Inneholder små deler.
 Kun for barn over 3 år.

EN ⚠️ WARNING :
 CHOKING HAZARD. - Small parts.
 Not for children under 3 years.

ES ⚠️ ADVERTENCIA :
 PELIGRO DE ASFIXIA. - Contiene piezas pequeñas.
 No recomendado para niños menores de 3 años.

FR ⚠️ AVERTISSEMENT :
 RISQUE DE SUFFOCATION. - Présence de petits éléments.
 Ne convient pas aux enfants de moins de 3 ans.

NL ⚠️ WAARSCHUWING:
 VERSTIKKINGSGEVAAR. - Bevat kleine onderdelen.
 Niet geschikt voor kinderen onder de 3 jaar.

DE ⚠️ WARNUNG:
 ERSTICKUNGSGEFAHR. - Enthält kleine Teile.
 Nicht für Kinder unter 3 Jahren geeignet.



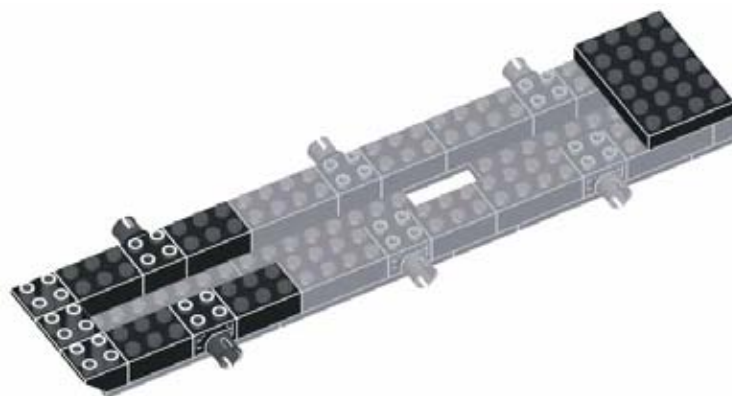
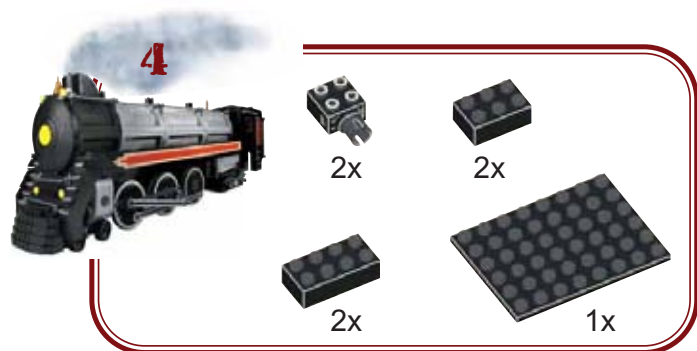
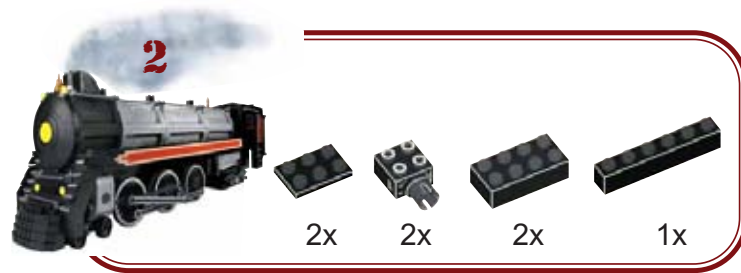
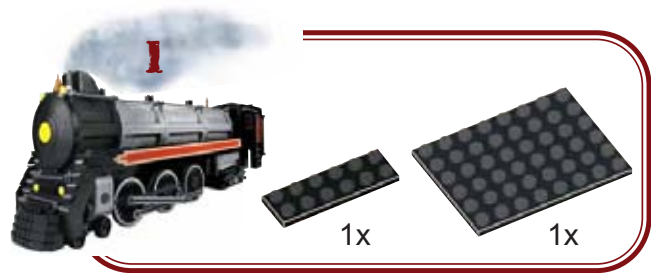

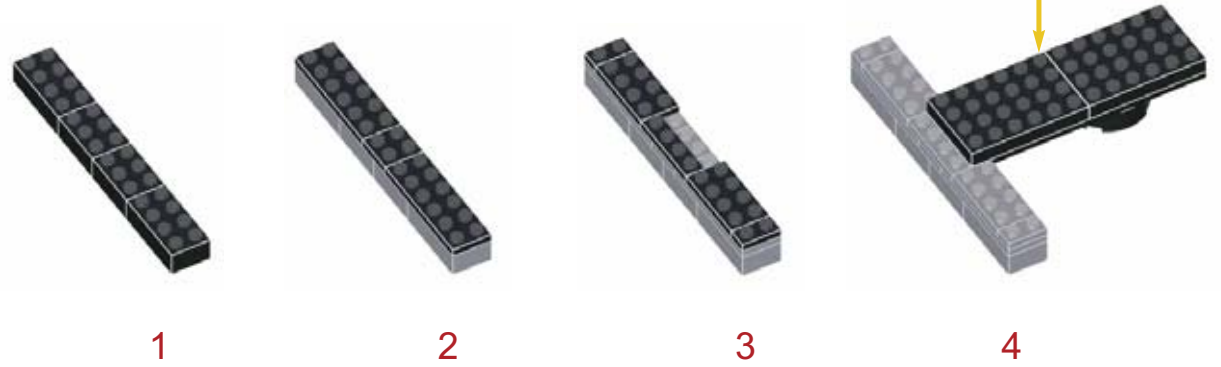
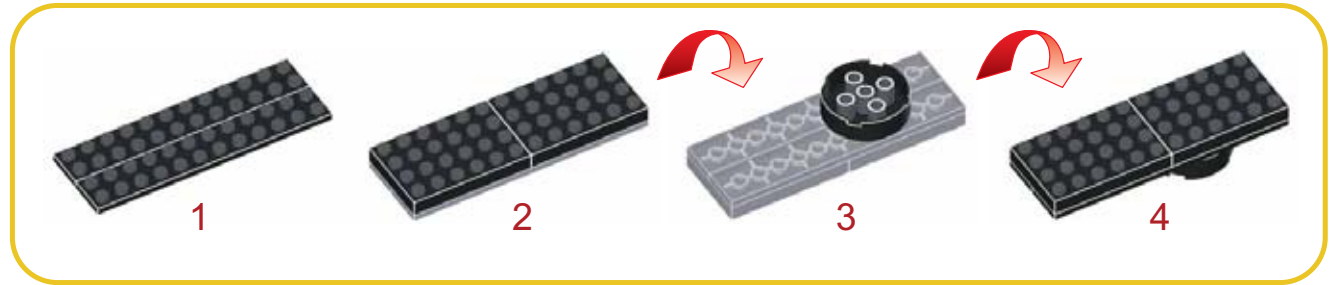
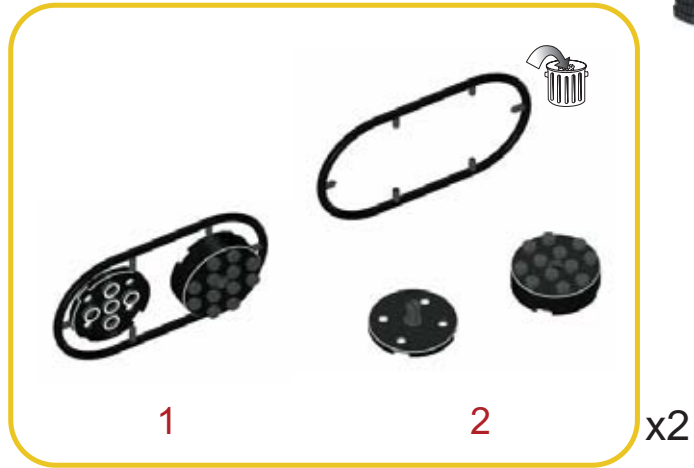
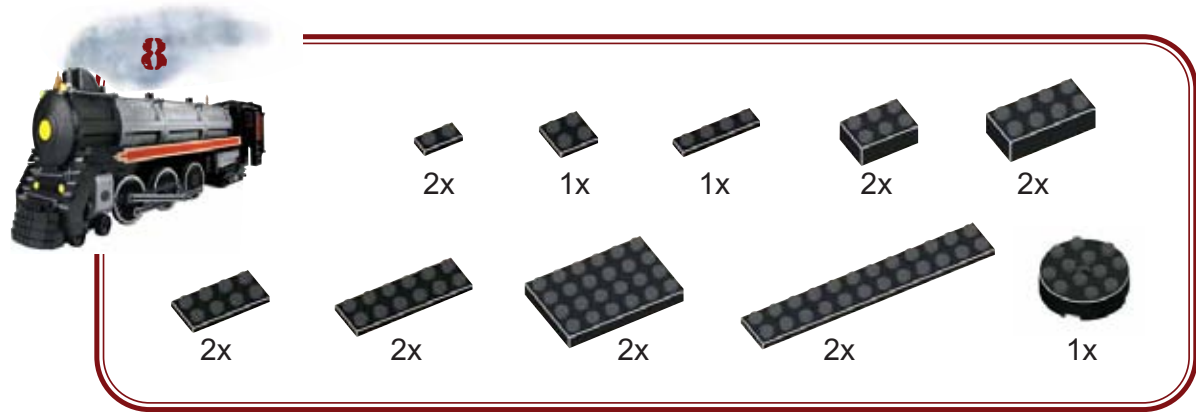

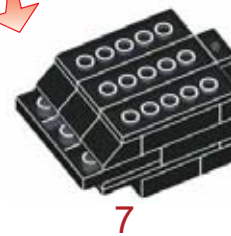
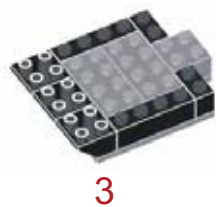
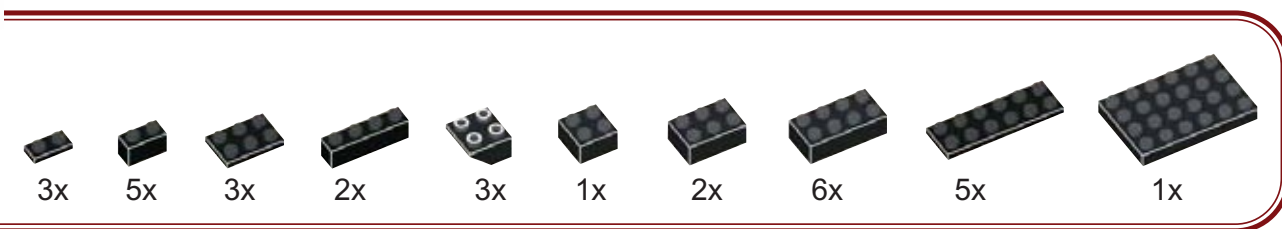
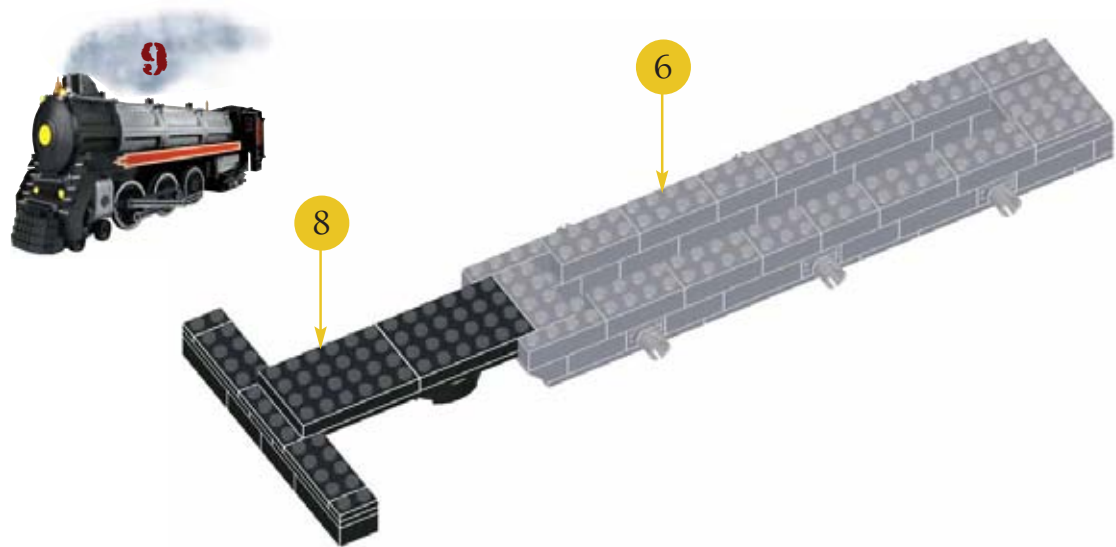

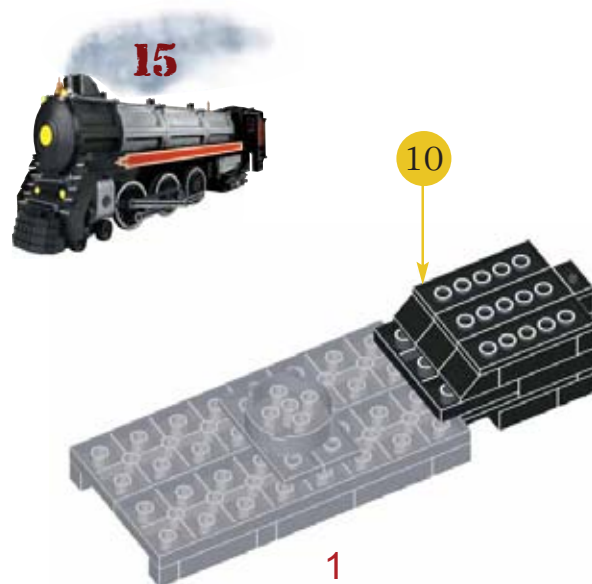
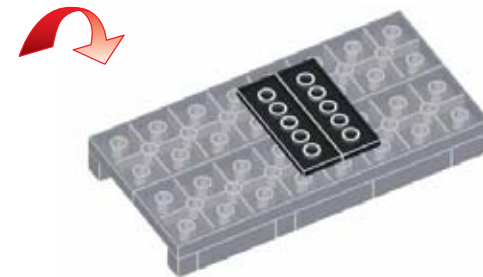
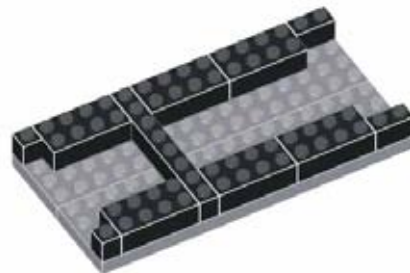
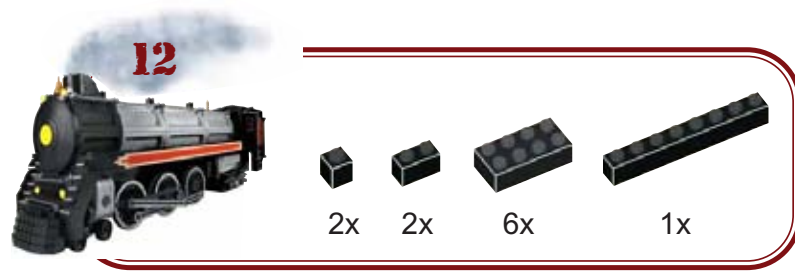





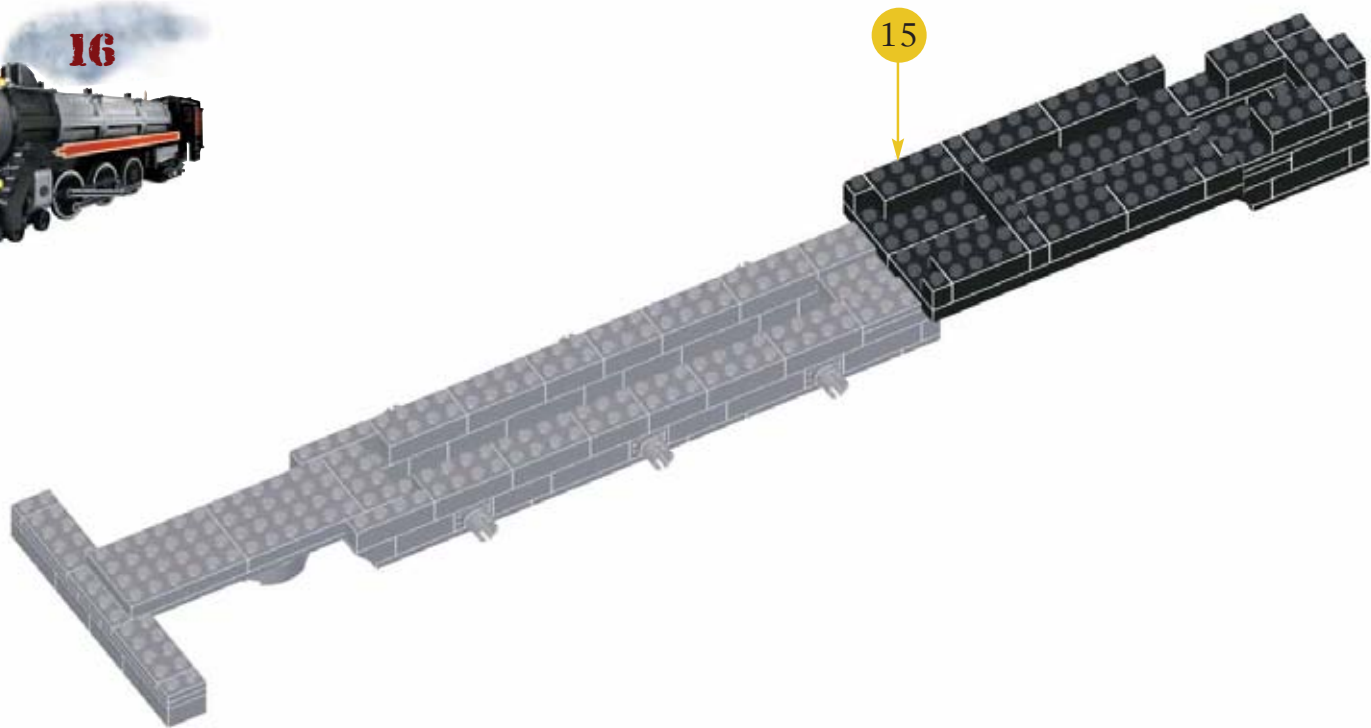







15



17

- | | | | |
|---|---|--|---|
| 
2x | 
4x | 
1x | |
| 
2x | 
2x | 
11x | |
| 
2x | 
2x | 
2x | 
2x |

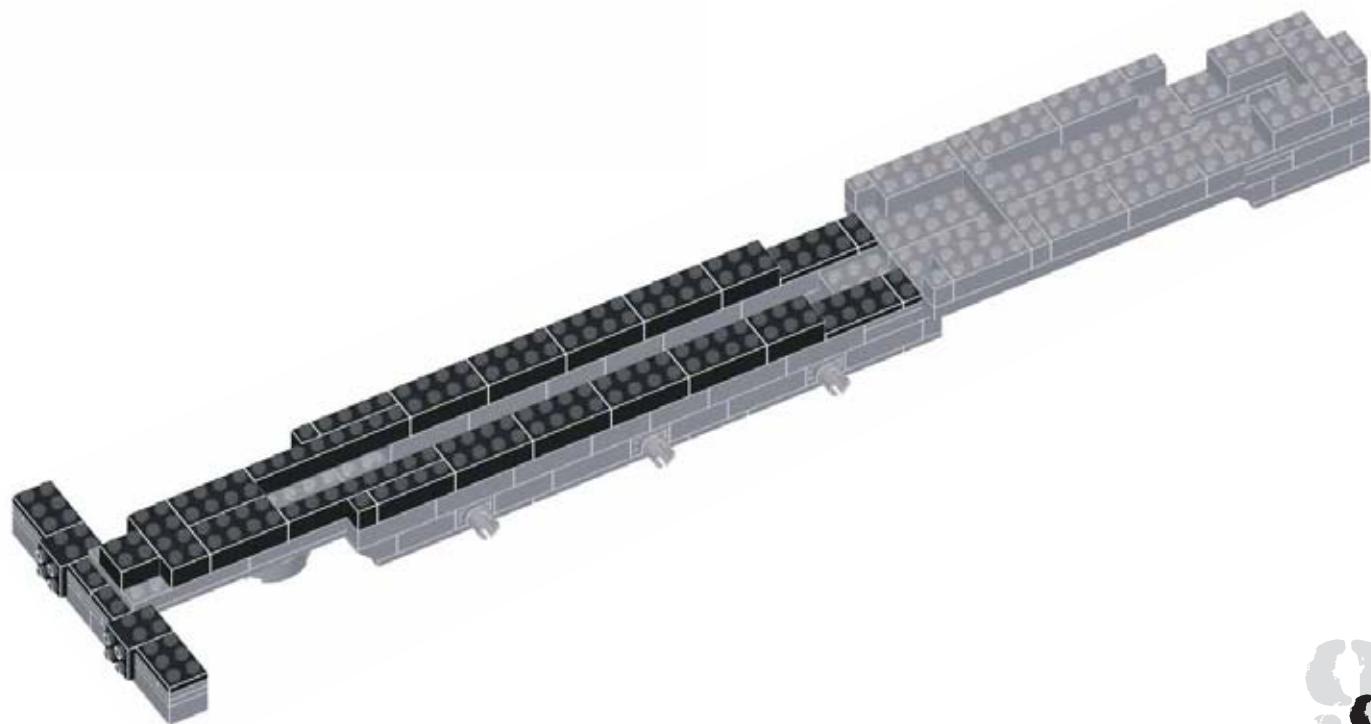

18



- 2x
- 4x
- 4x
- 3x
- 2x
- 2x
- 2x

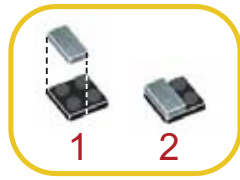

x2

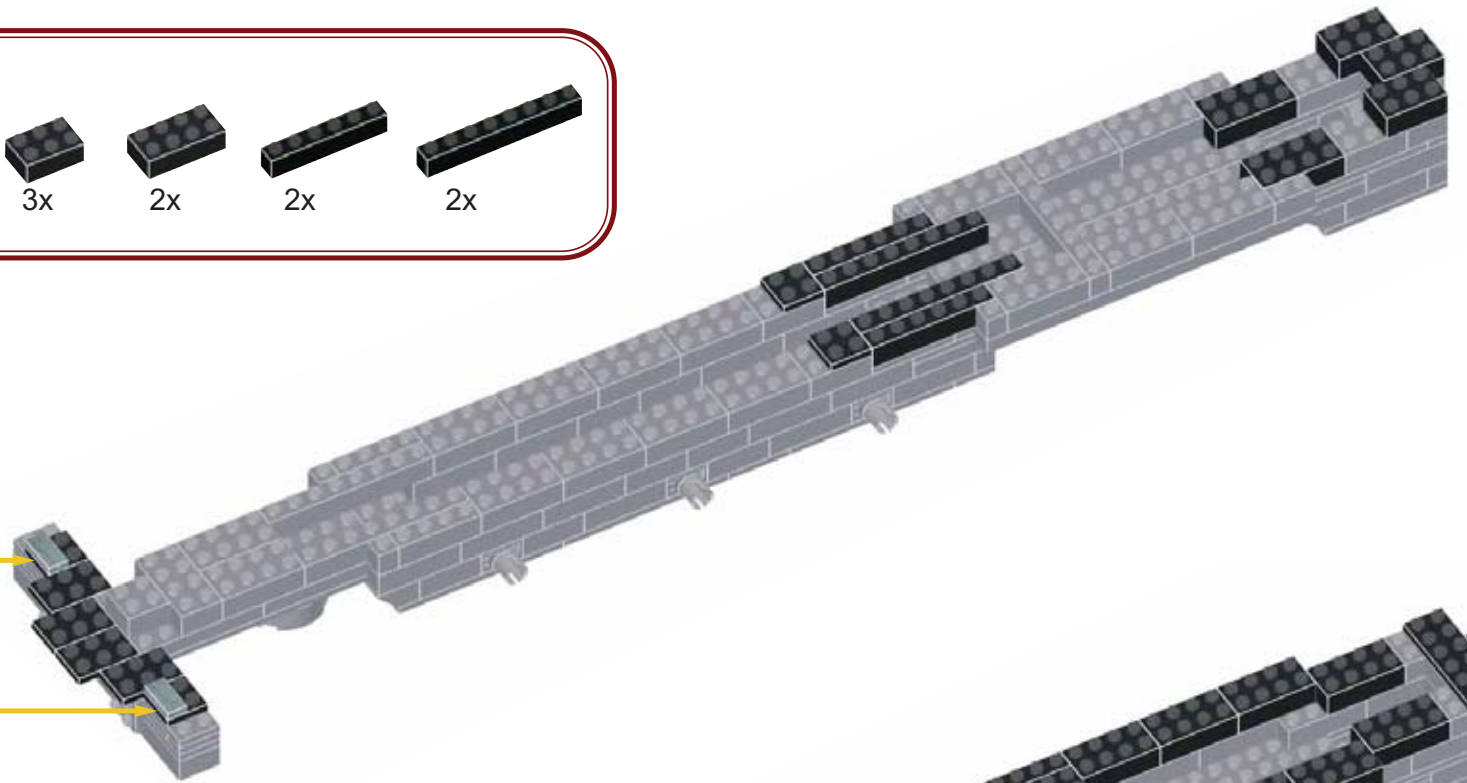

19



- 1x
- 2x
- 2x
- 8x
- 1x
- 2x

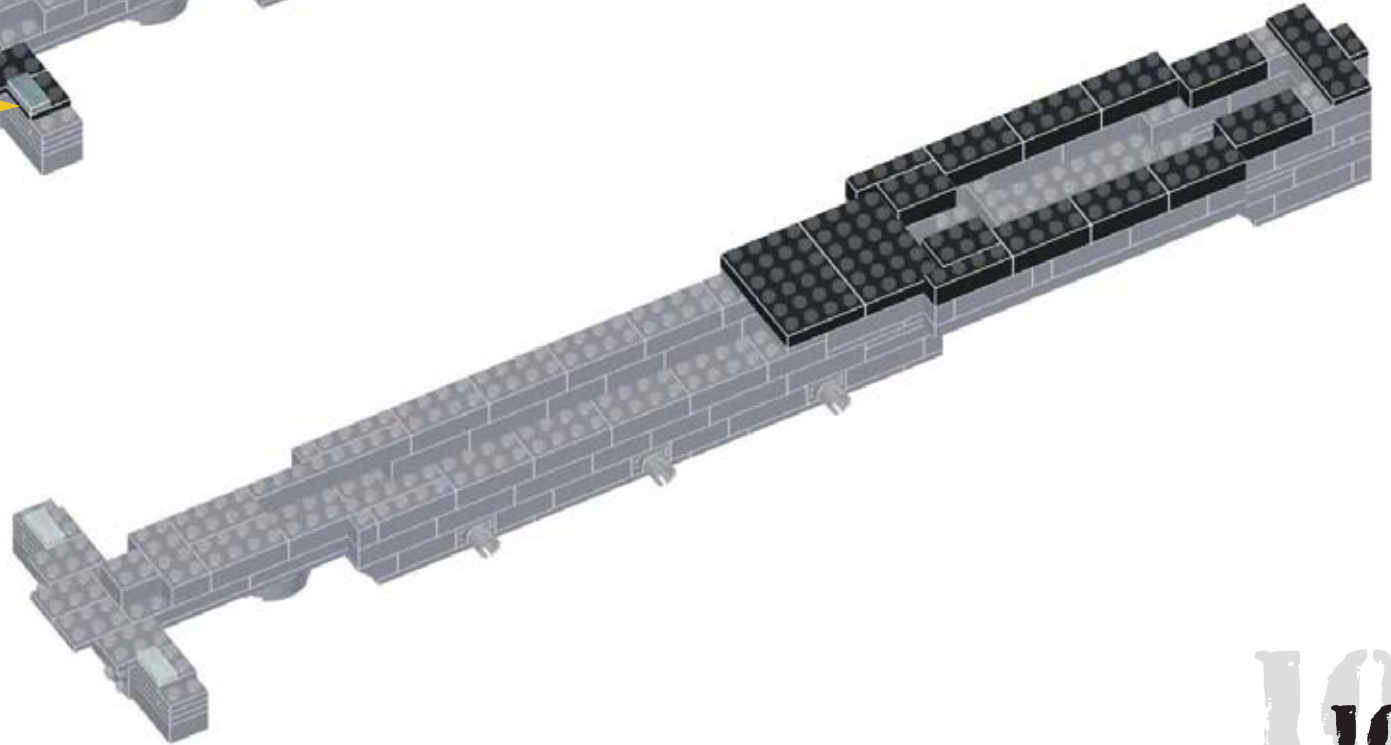



20

- 4x
- 2x
- 1x
- 4x

- 4x
- 2x
- 1x
- 2x

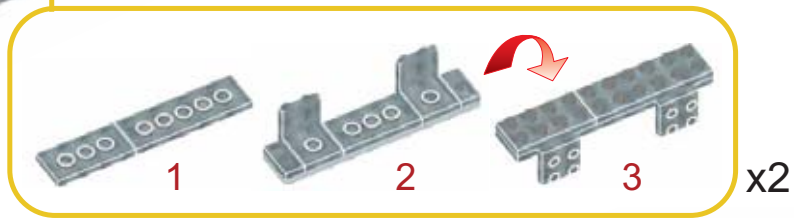
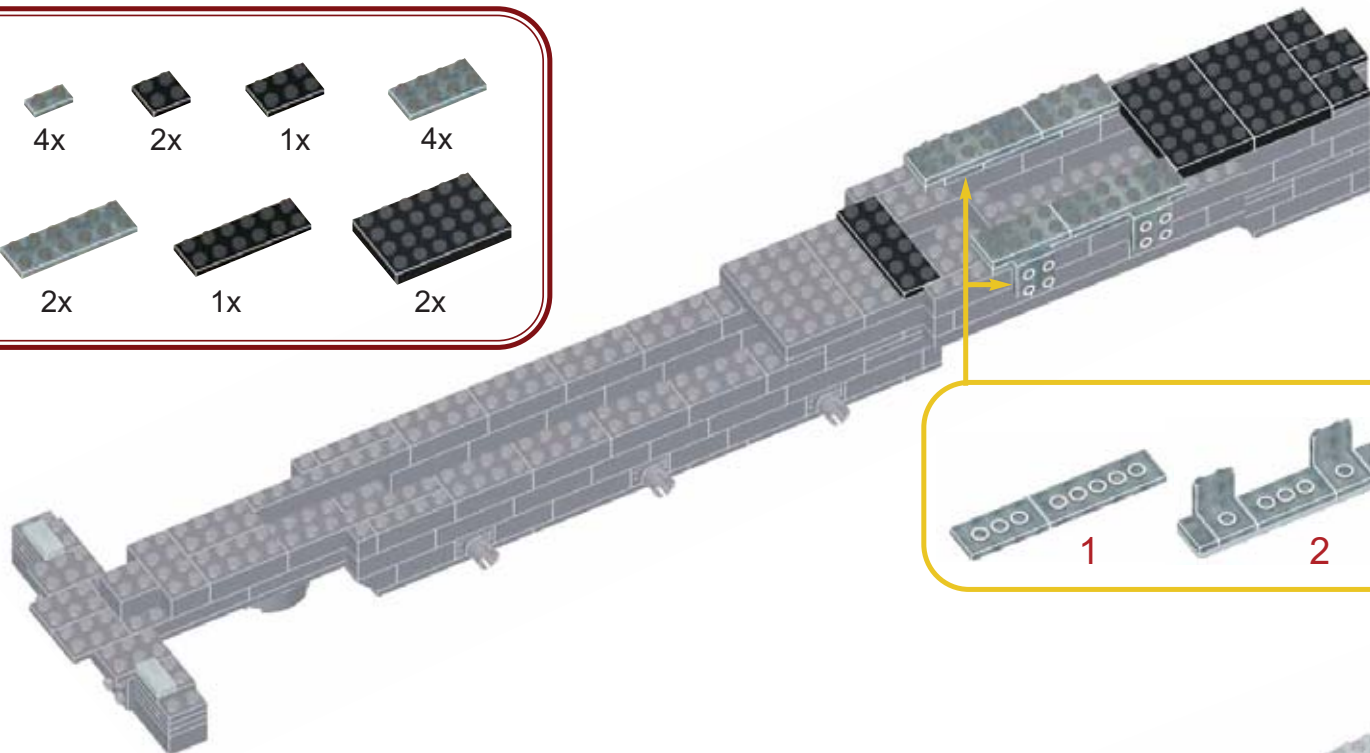

21

- 2x
- 18x
- 1x
- 1x

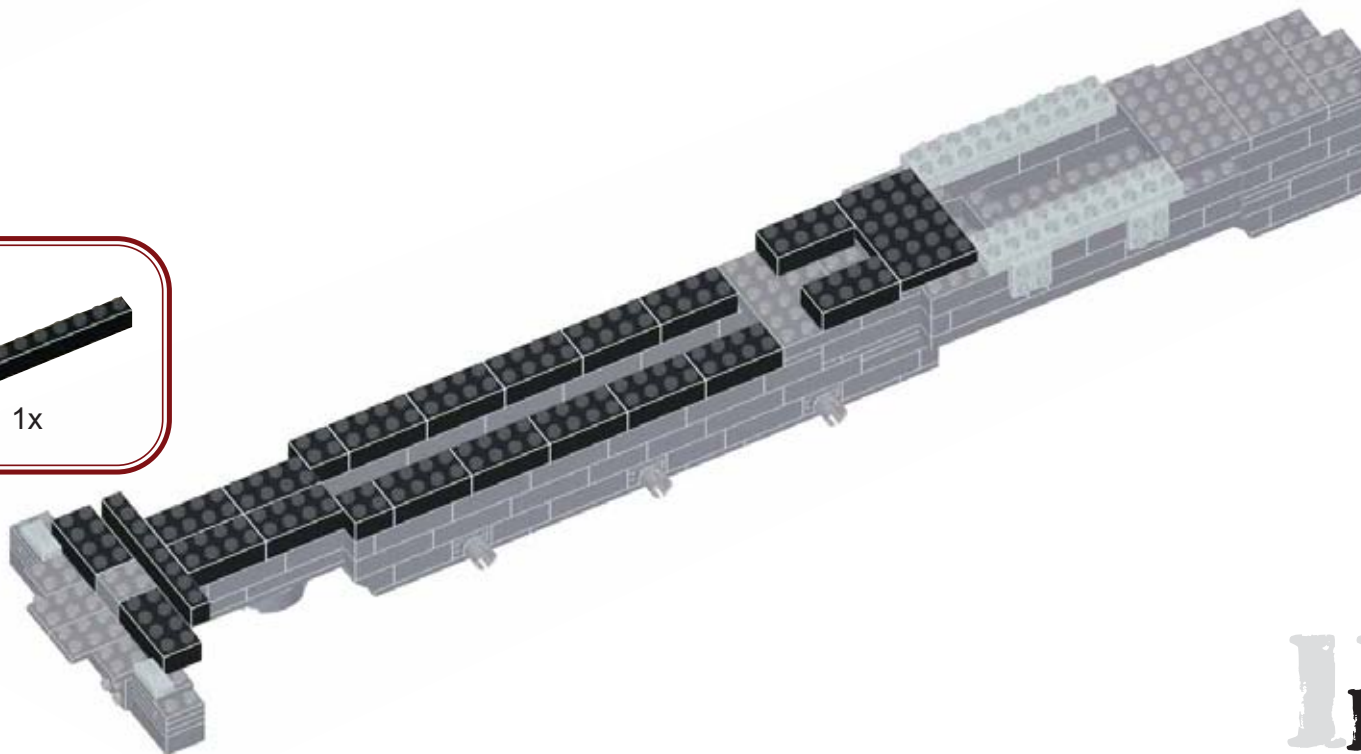

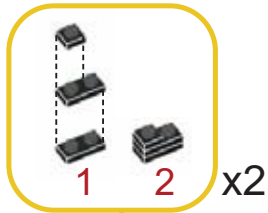

x2

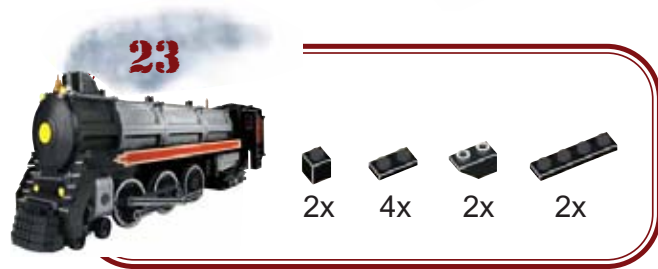
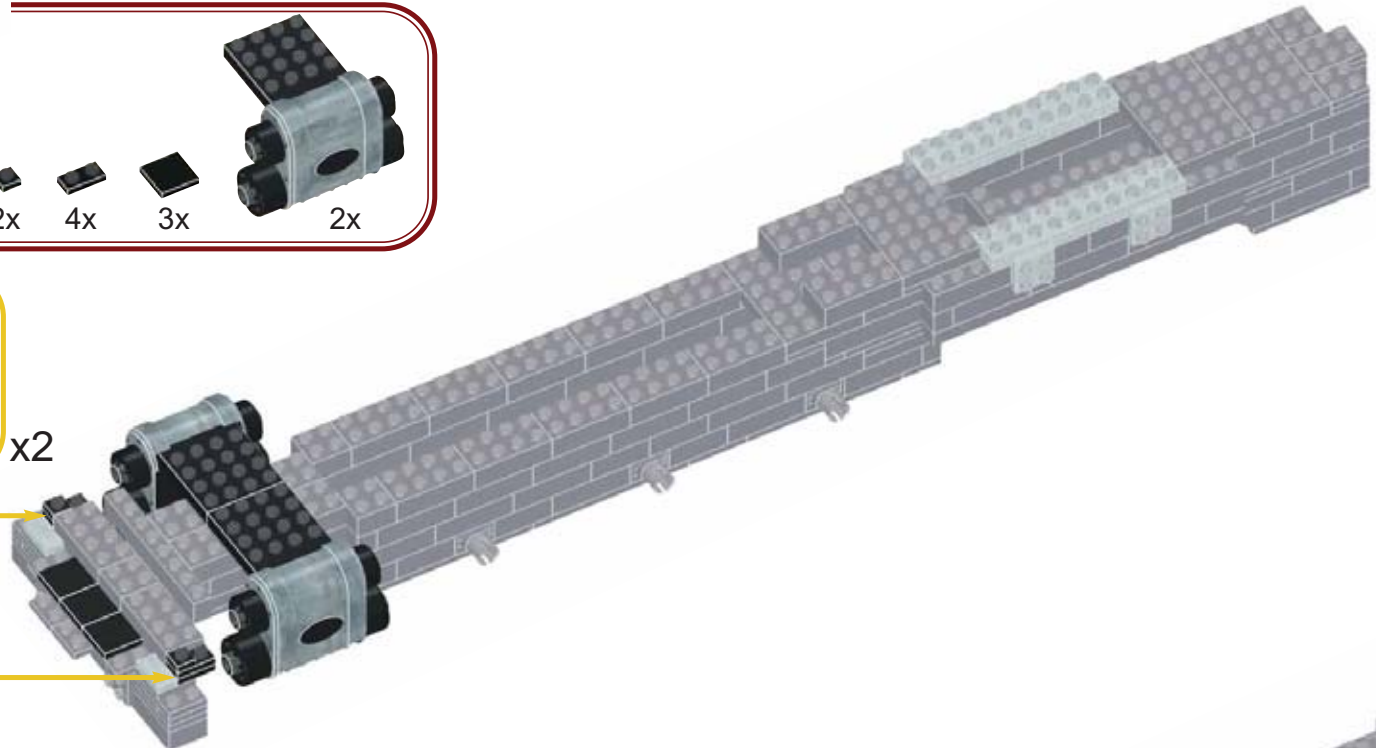



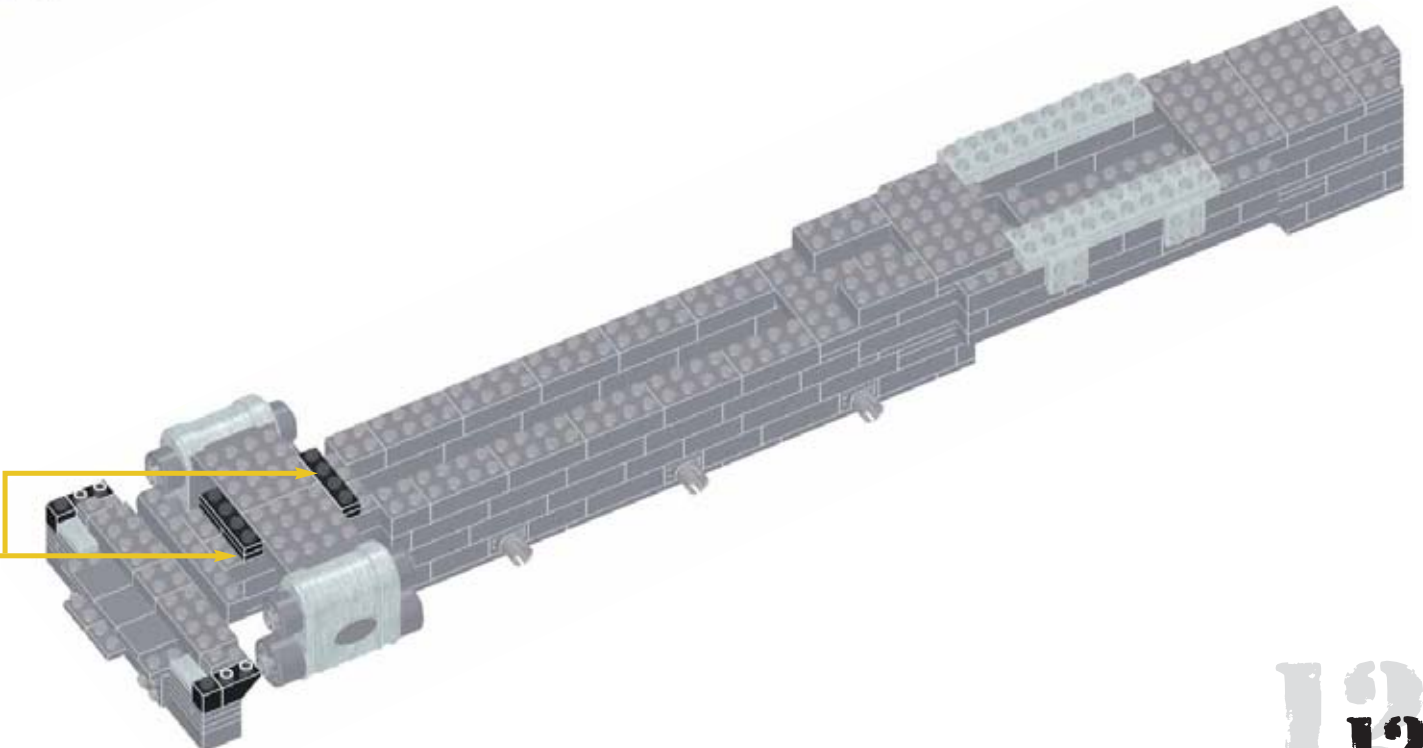

x2





24



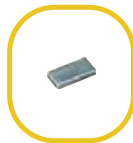



-  2x
-  2x
-  1x
-  12x
-  2x



x2



25

-  2x
-  9x
-  2x
-  2x
-  2x
-  1x

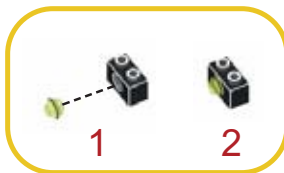

1

2

x2

26



- 2x [1x1 black Technic brick]
- 2x [1x2 black Technic brick]
- 2x [1x2 black Technic brick with 2 holes]

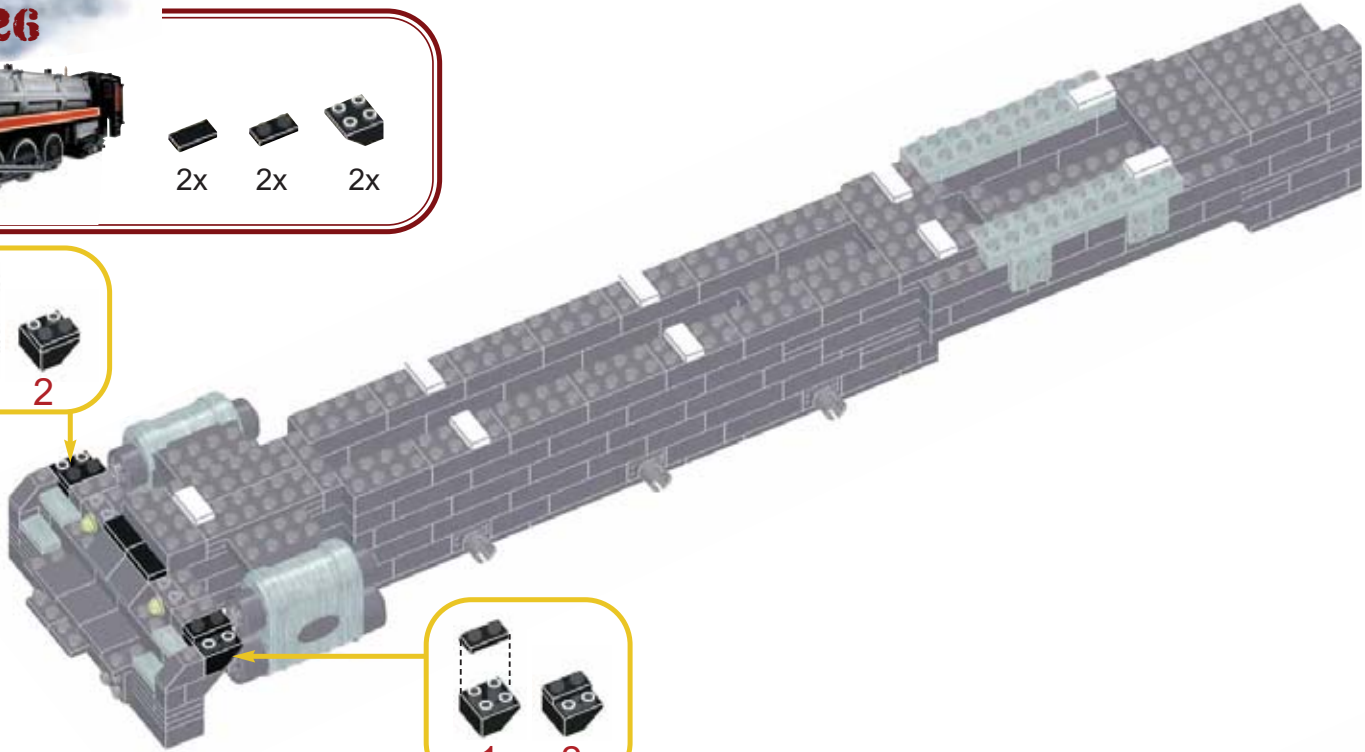

27



- 2x [1x1 grey Technic brick]
- 2x [1x2 black Technic brick]
- 1x [grey Technic axle]

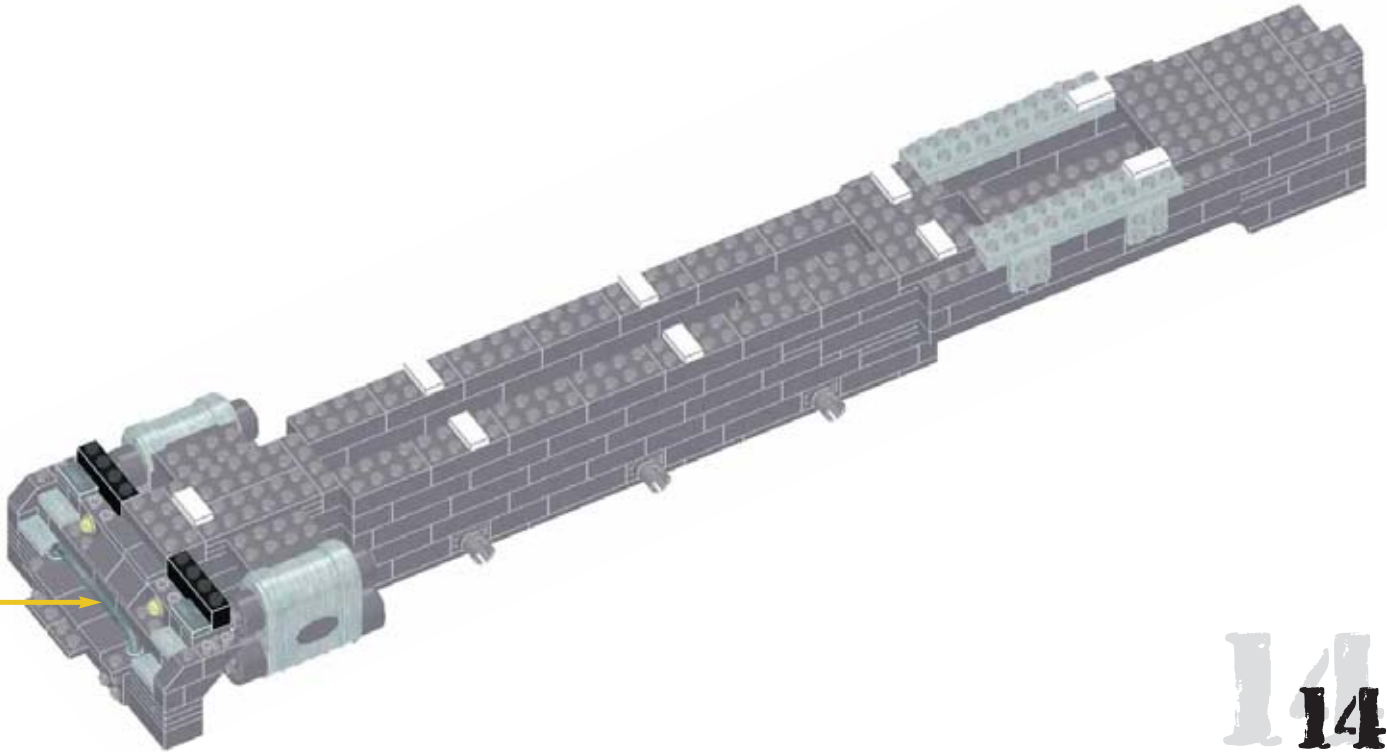

28



- 2x
- 2x
- 2x
- 2x

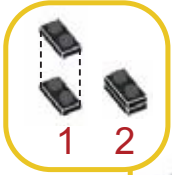

29



- 1x
- 3x

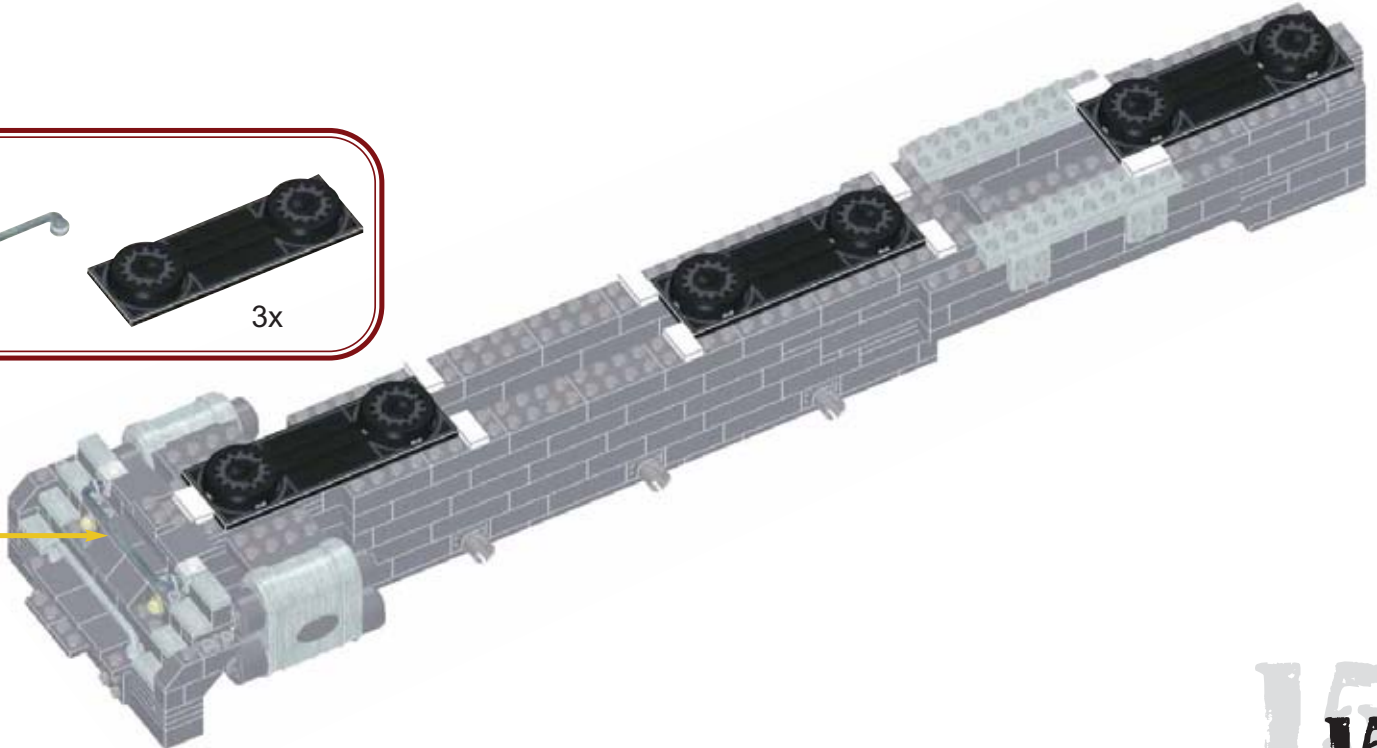

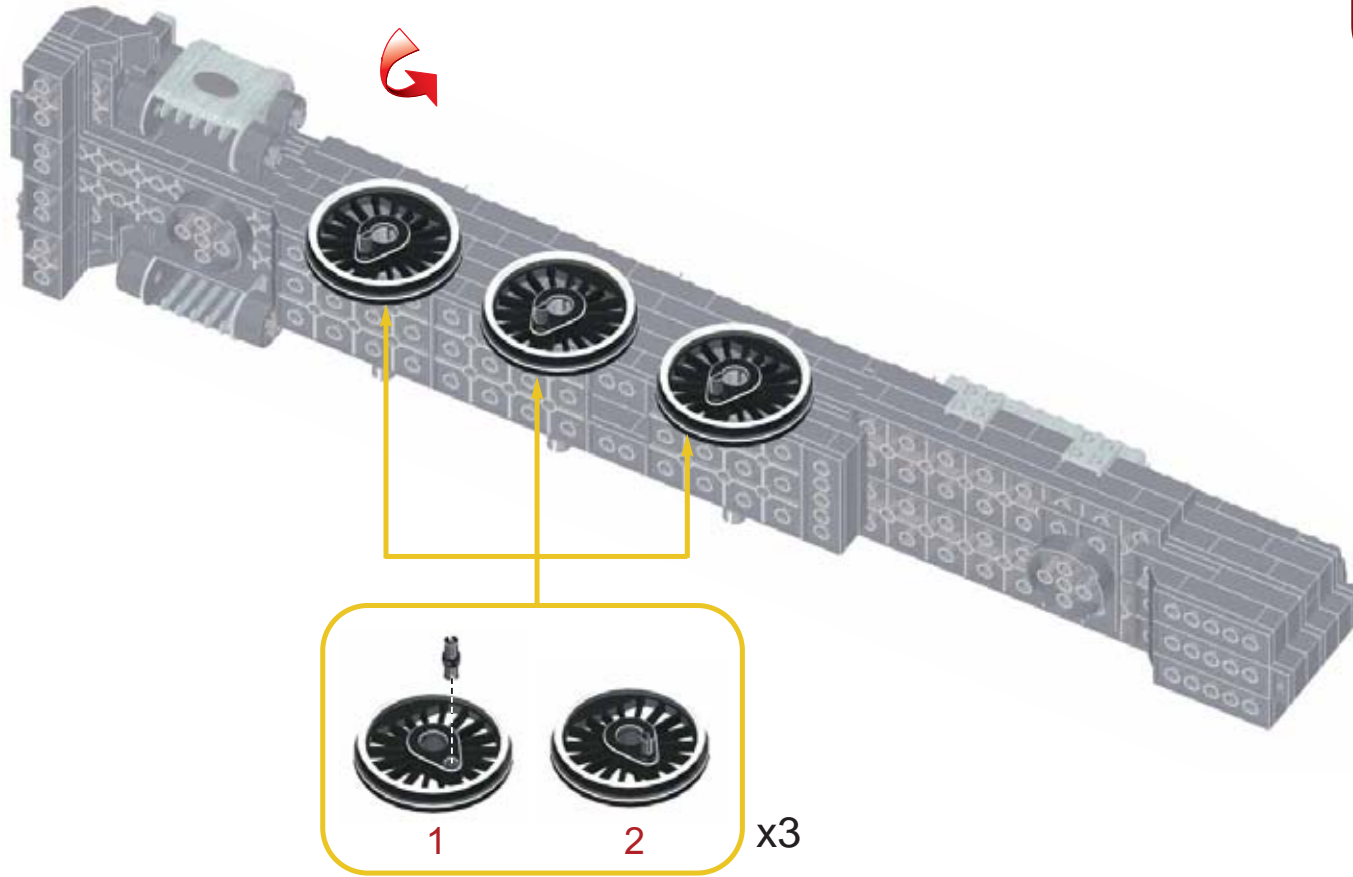

Adult assistance may be required. / Puede ser necesaria la ayuda de un adulto.
L'assistance d'un adulte peut être requise. / De hulp van een volwassene kan nodig zijn.

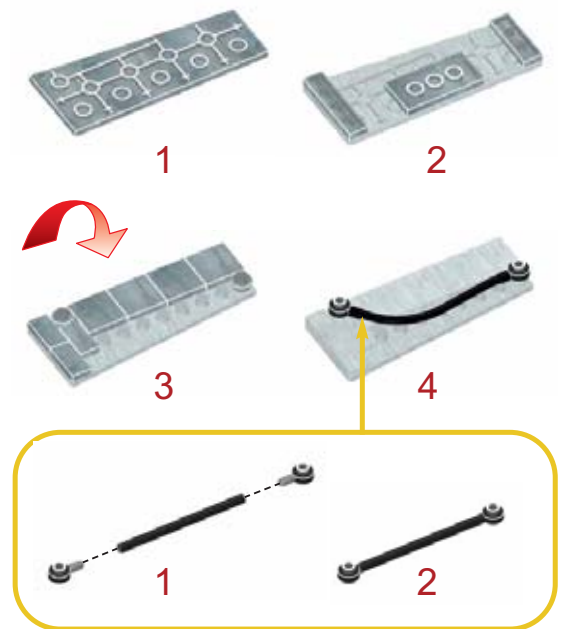



1x

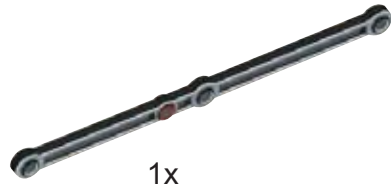

1x

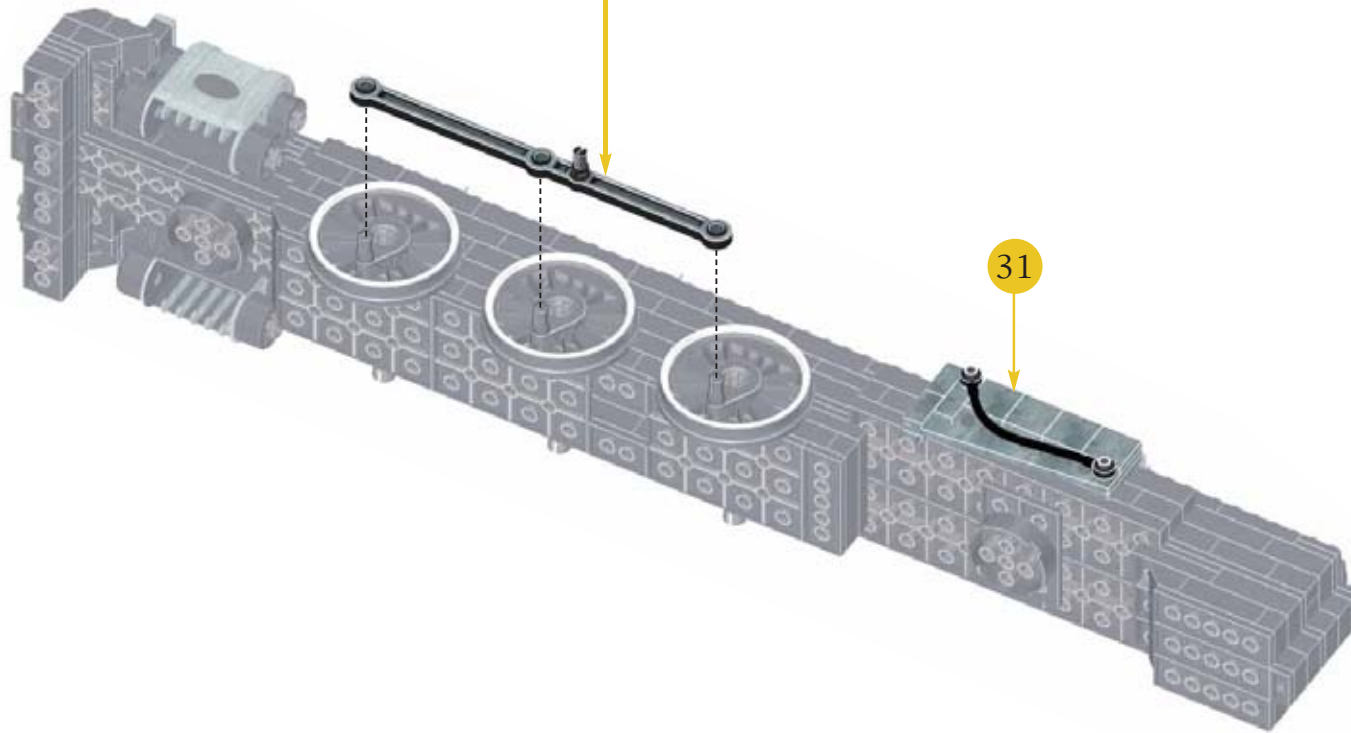



33



1x



1x

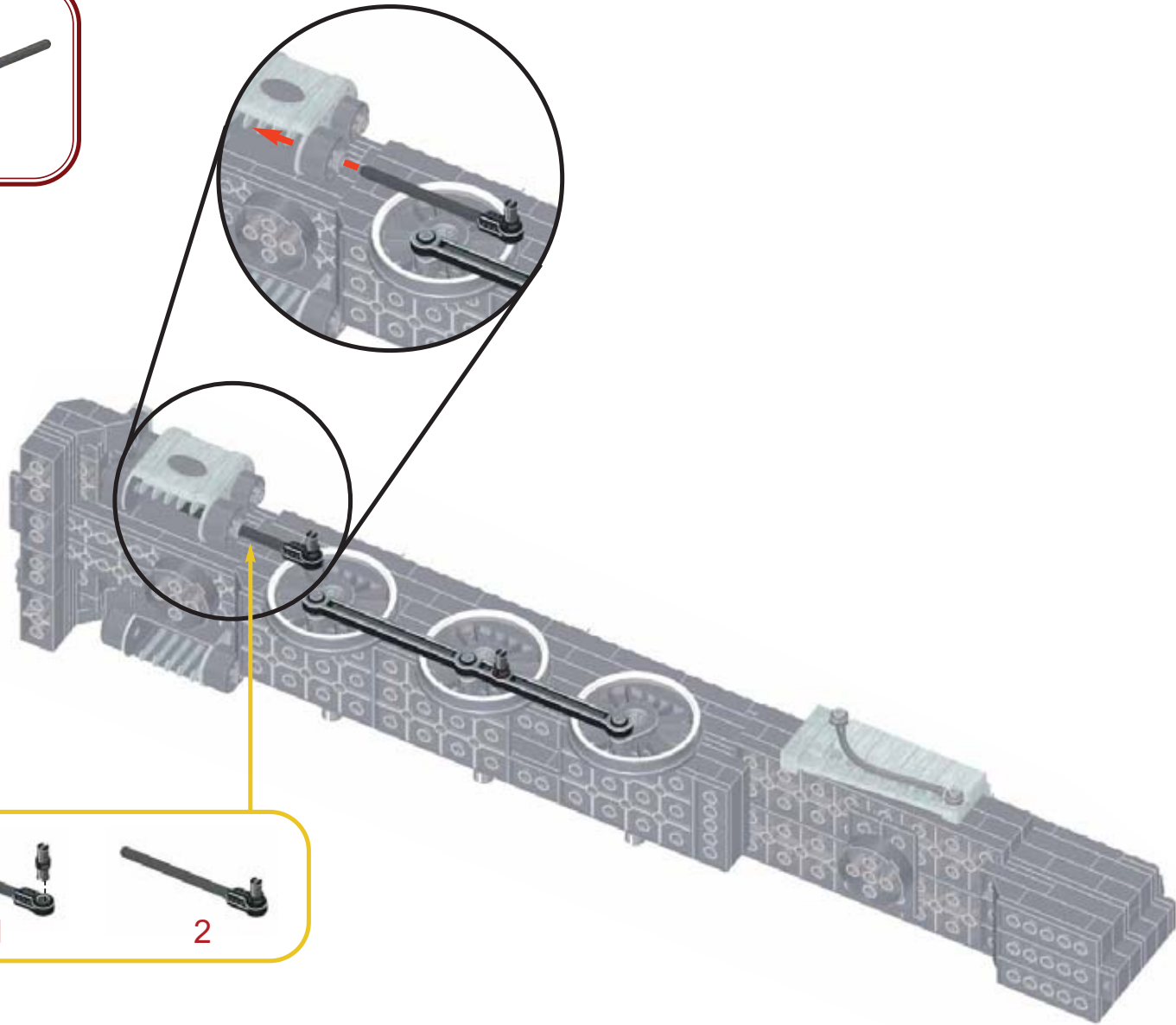

1

2

34



1x

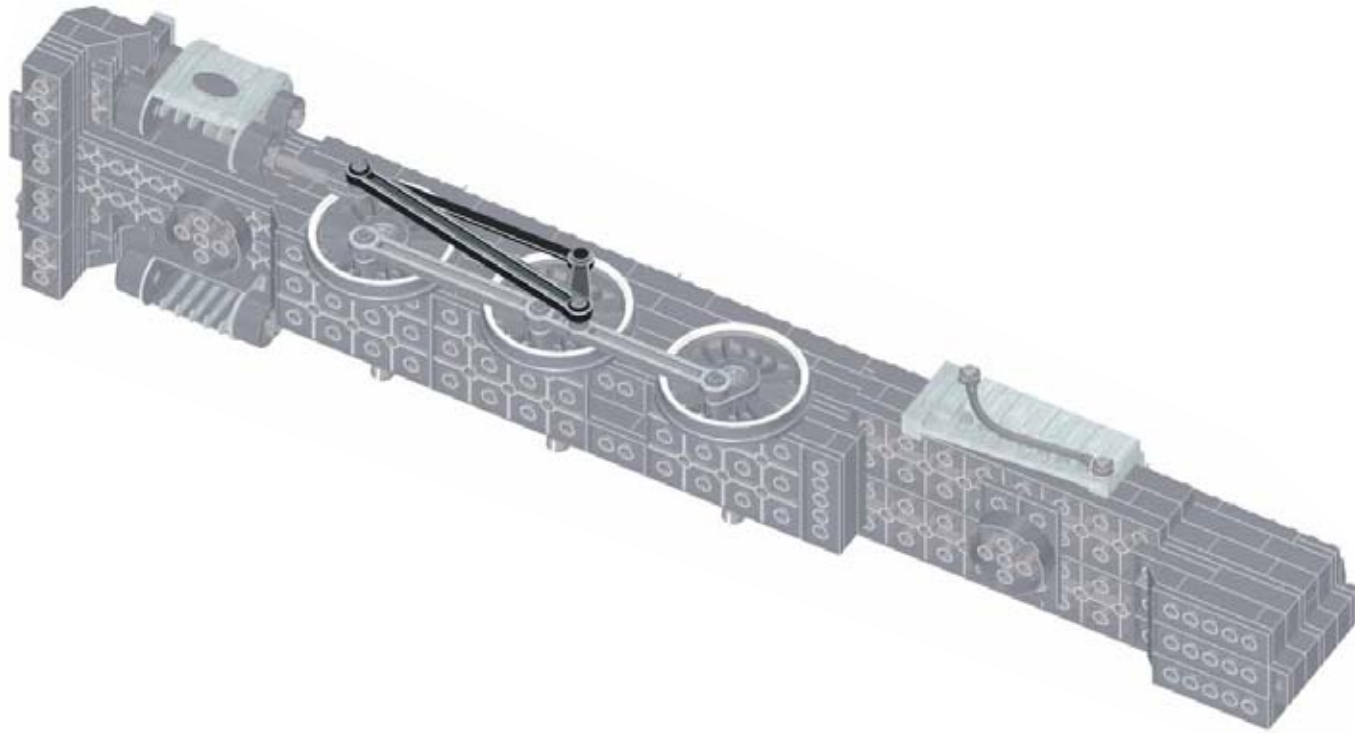

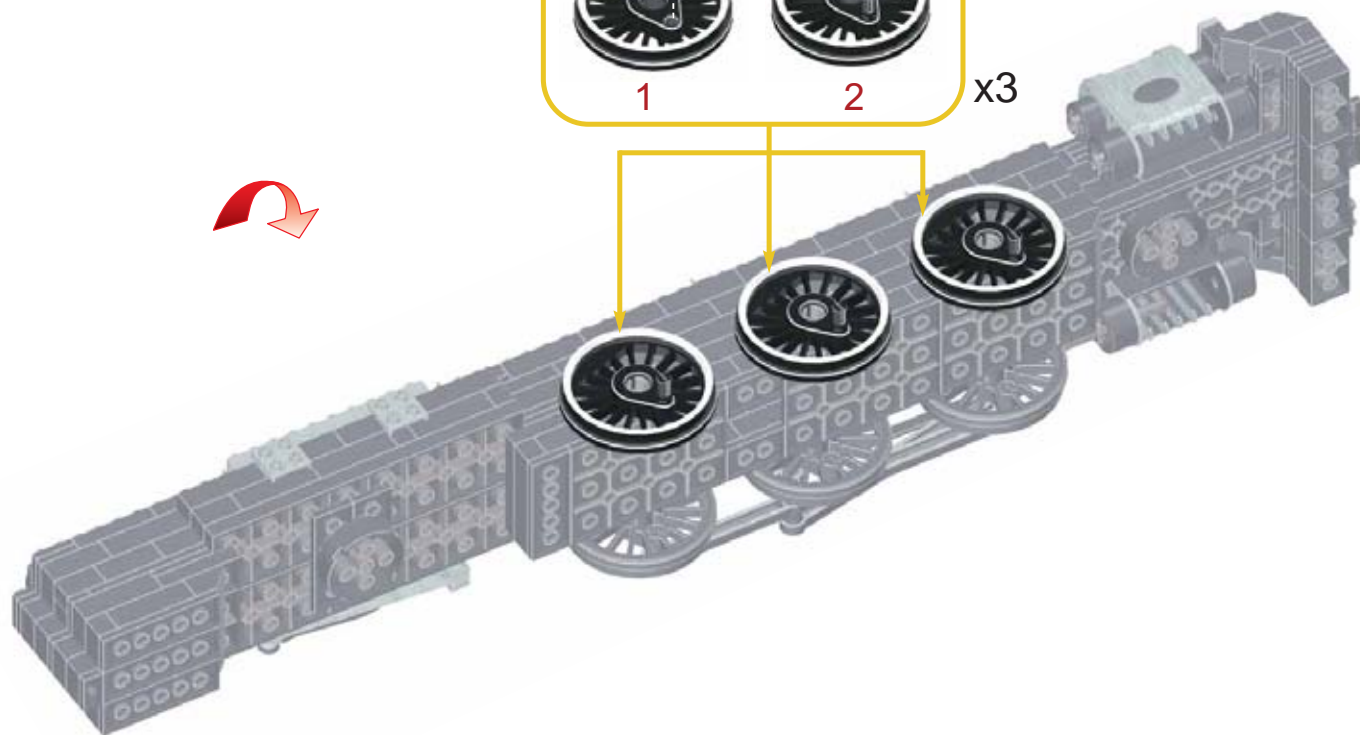

Adult assistance may be required. / Puede ser necesaria la ayuda de un adulto.
L'assistance d'un adulte peut être requise. / De hulp van een volwassene kan nodig zijn.

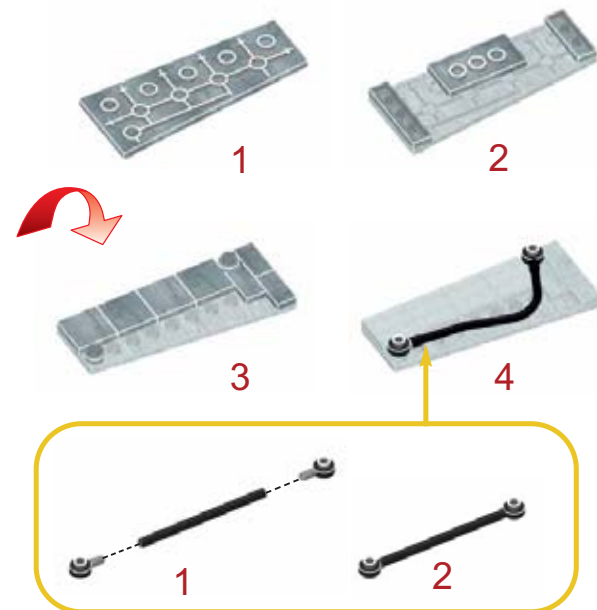

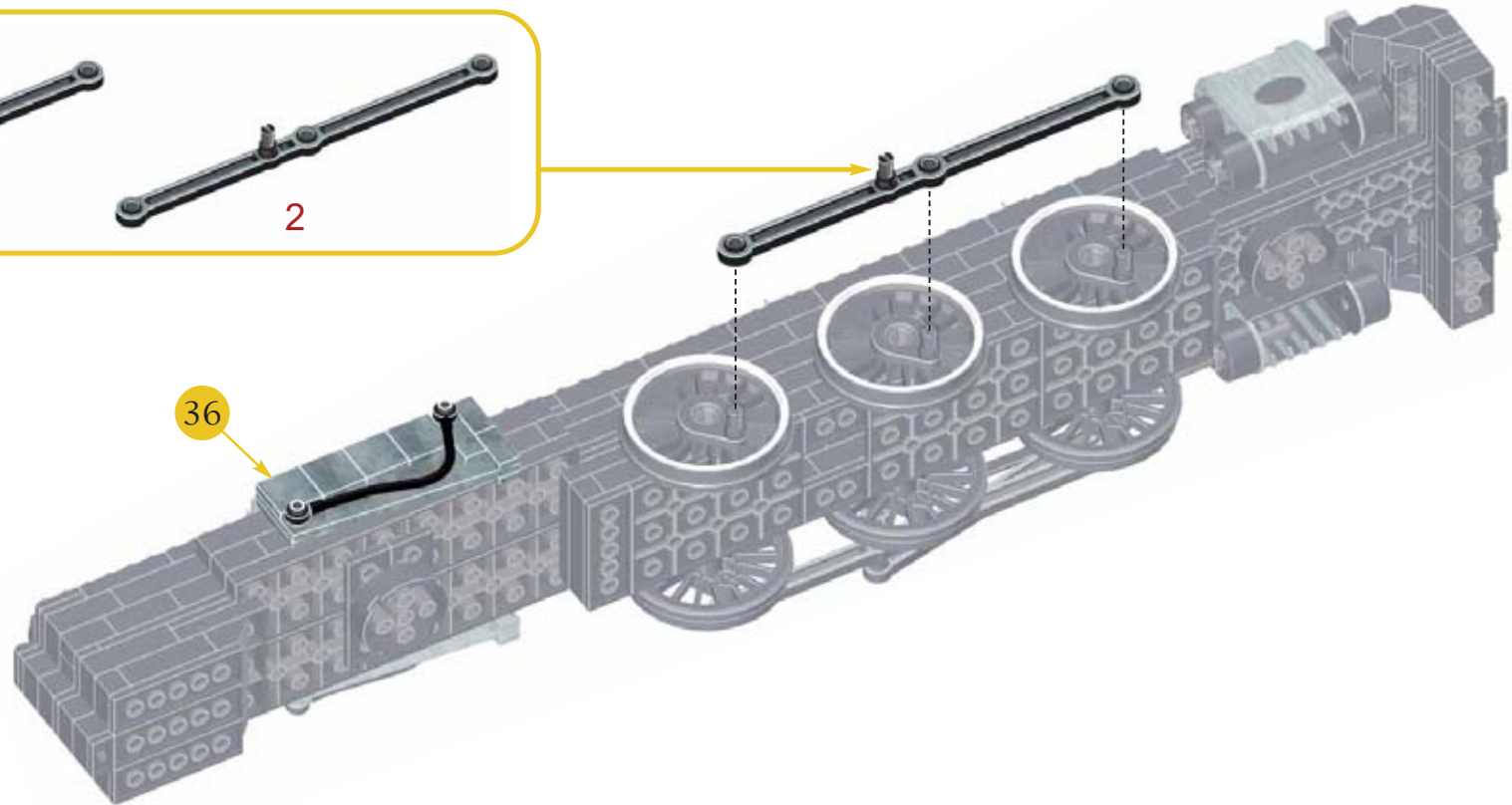
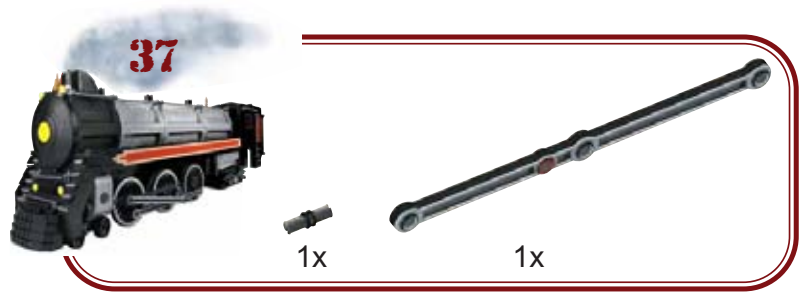

38



1x



1x



1



2

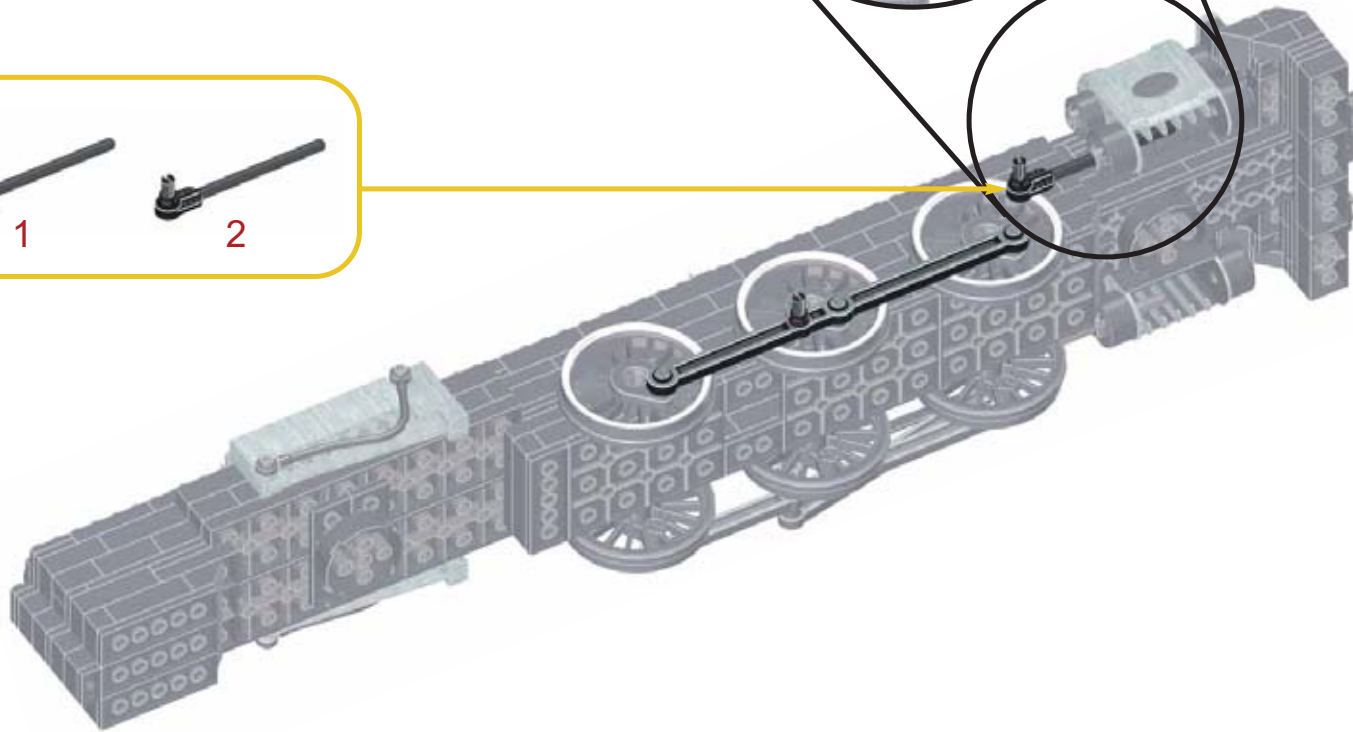
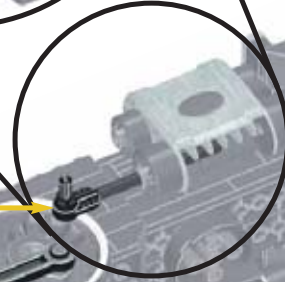
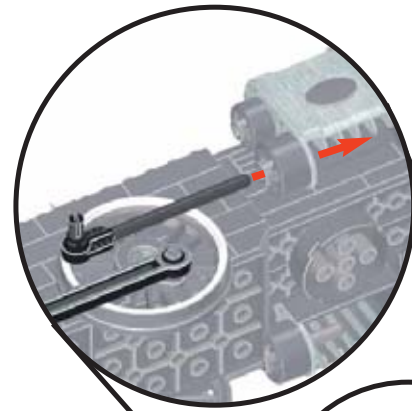

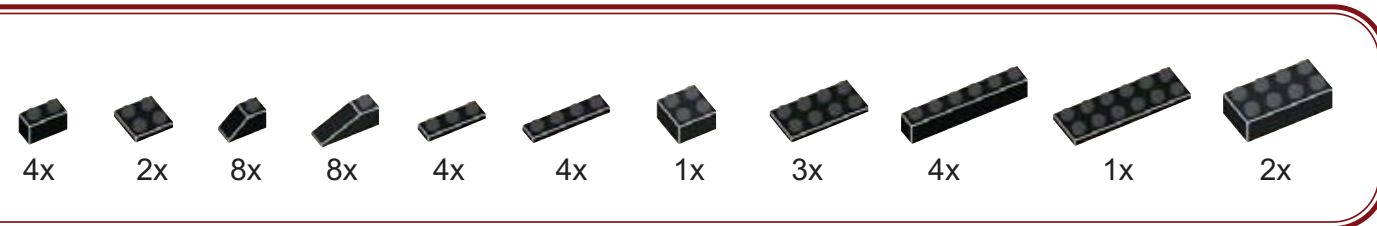
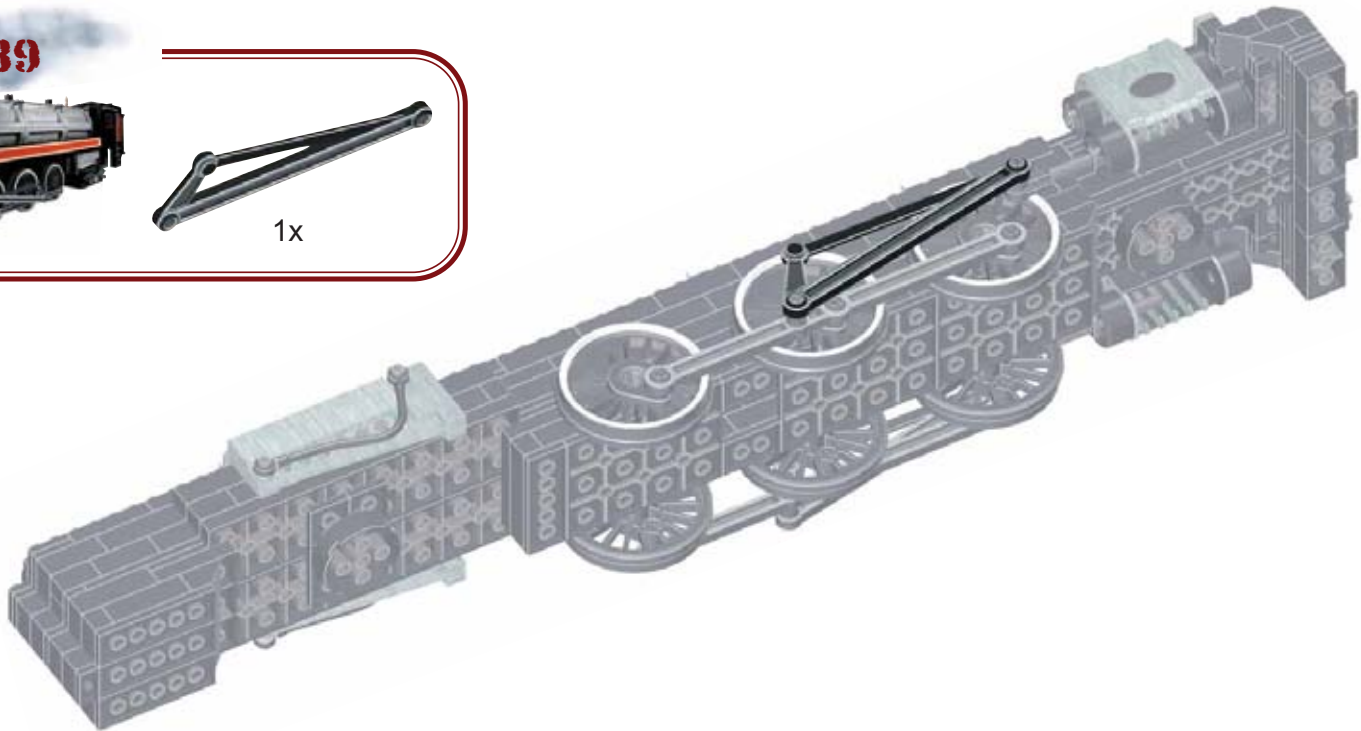
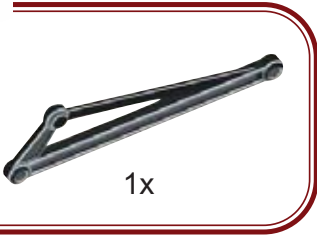



41

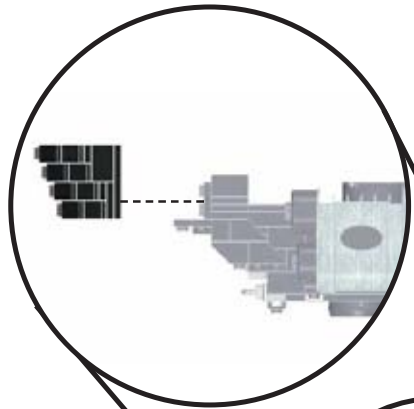

40

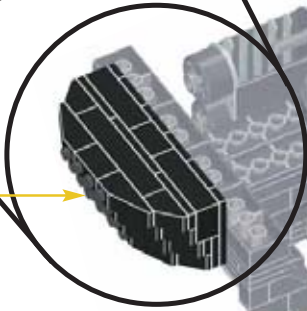

42



2x



43



2x

2x

1x

2x



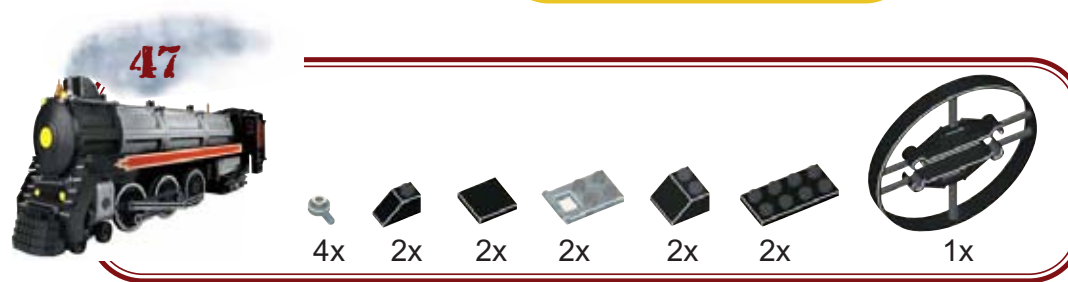
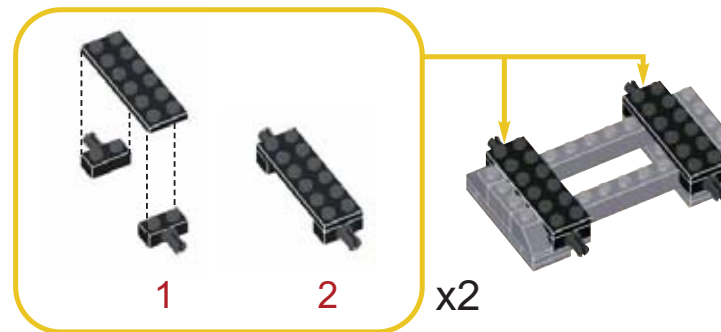
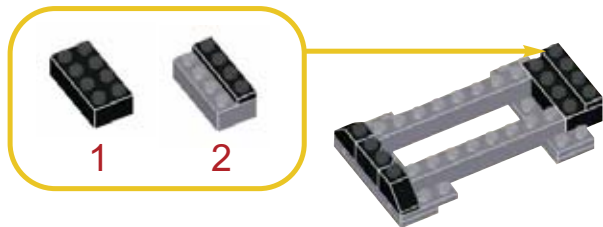

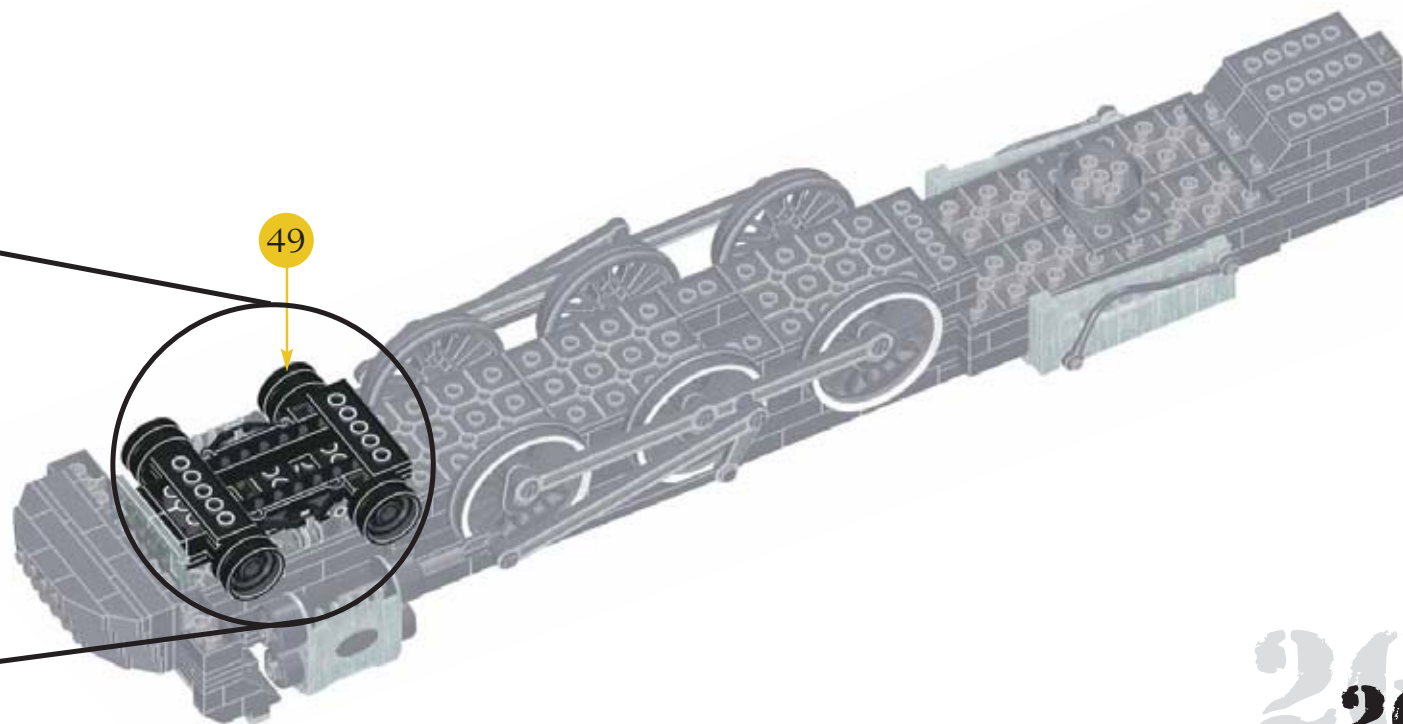
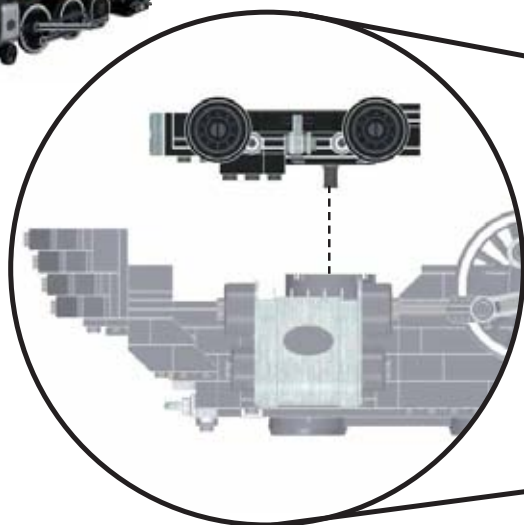
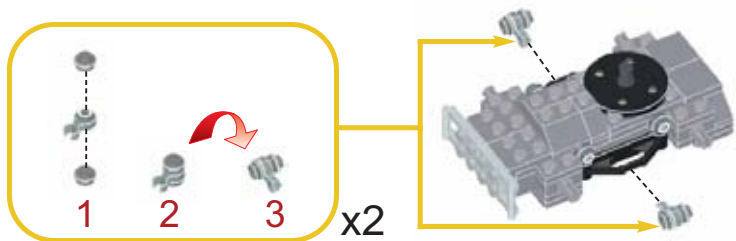











57

- 
1x
- 
3x
- 
2x
- 
2x
- 
2x
- 
2x
- 
1x

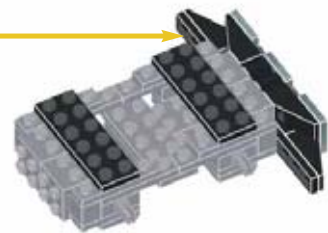

58

- 
2x
- 
2x
- 
2x
- 
1x
- 
2x

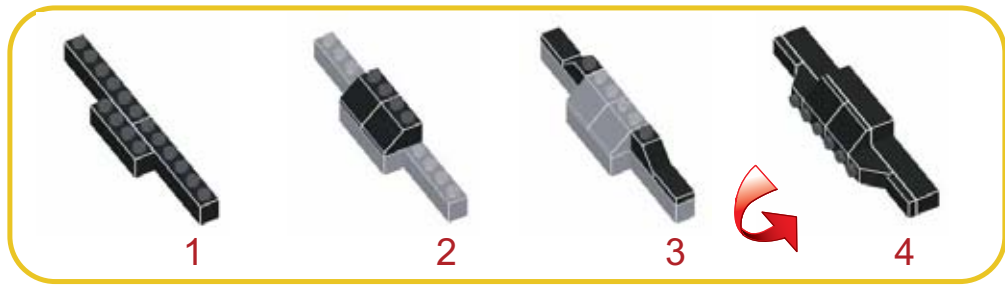

59

- 
- 4x



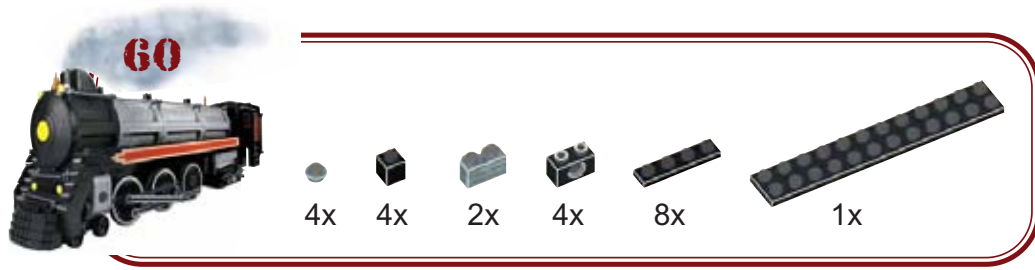

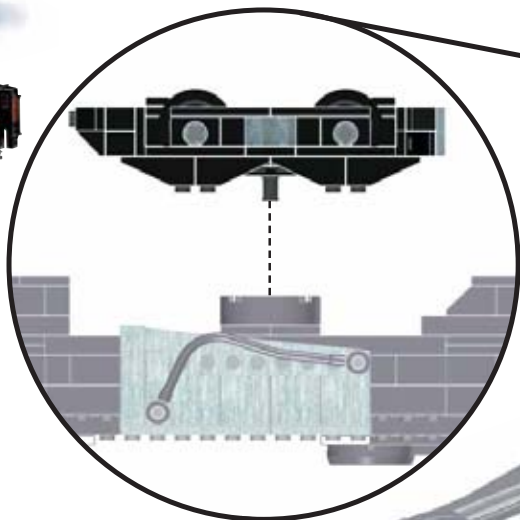

64

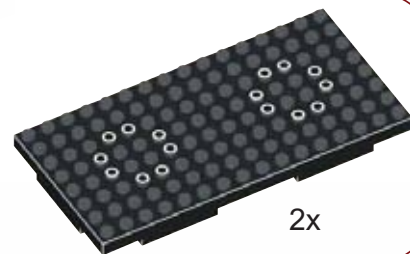
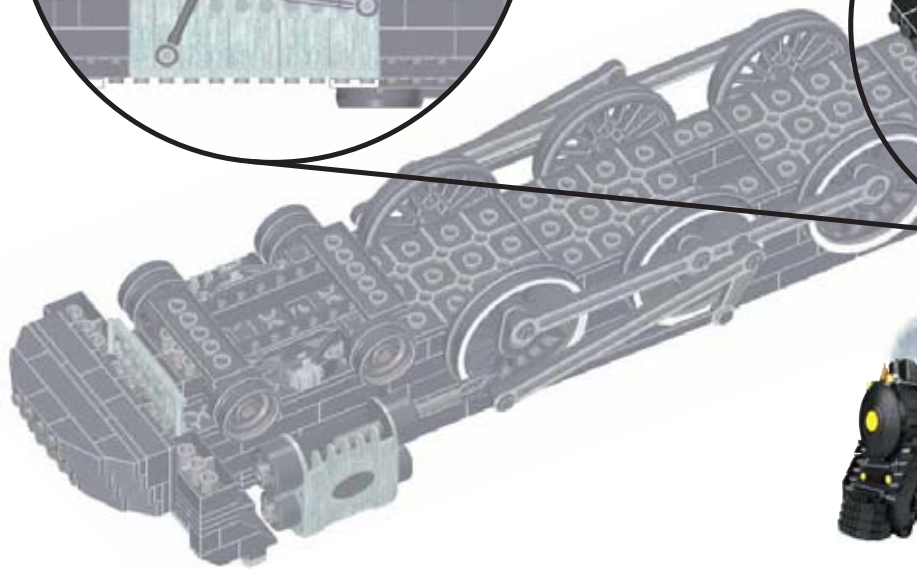
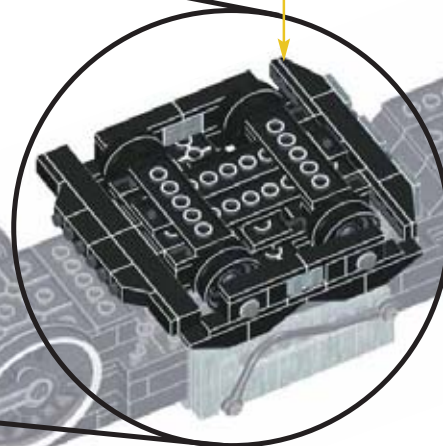

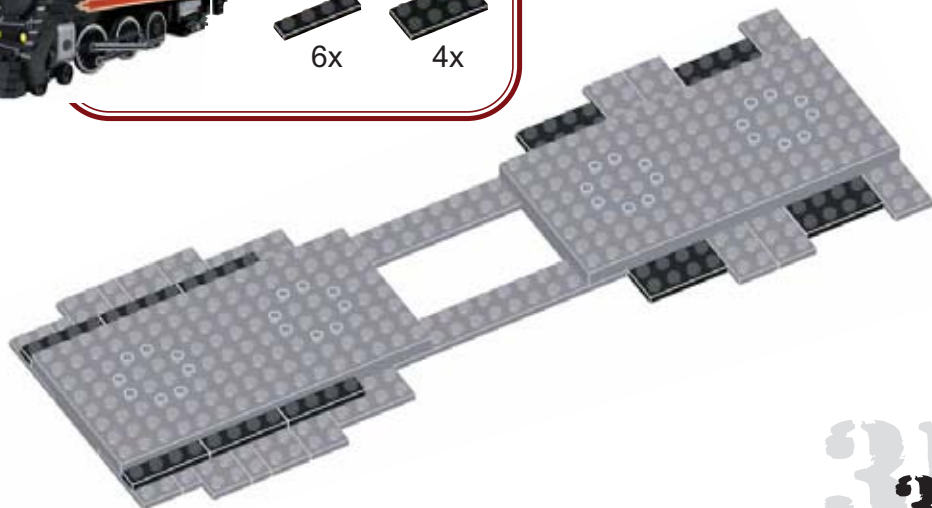
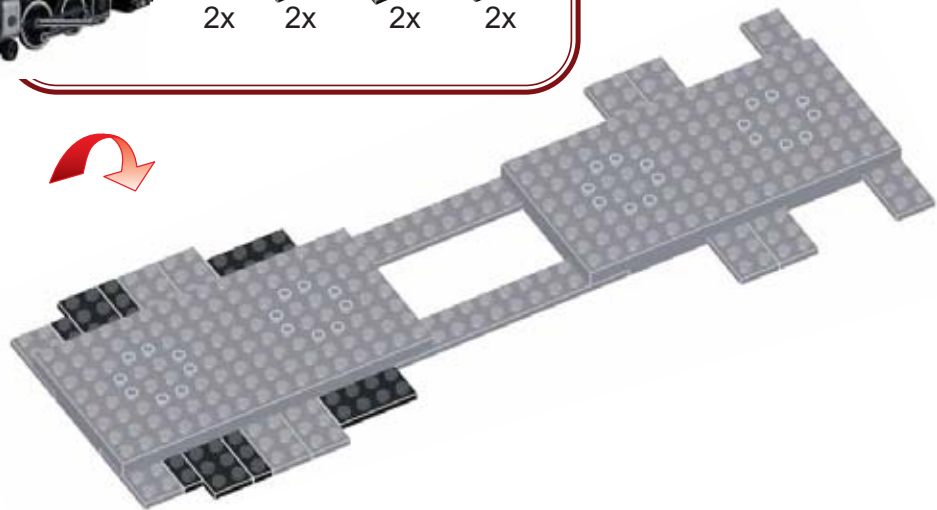
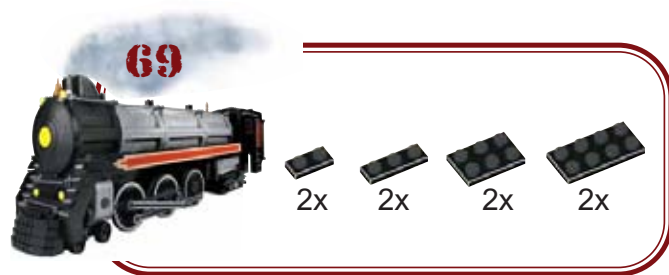
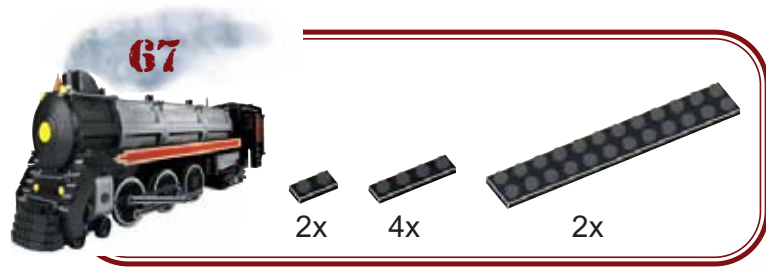

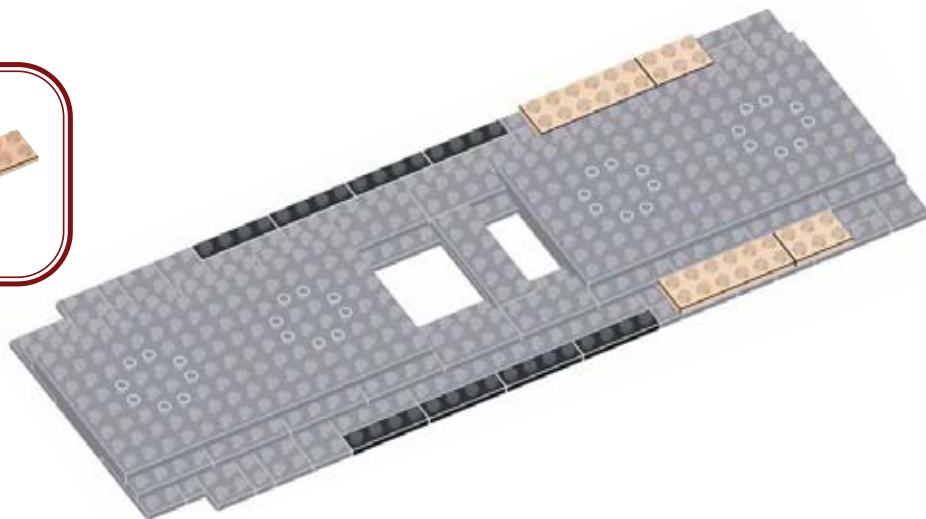
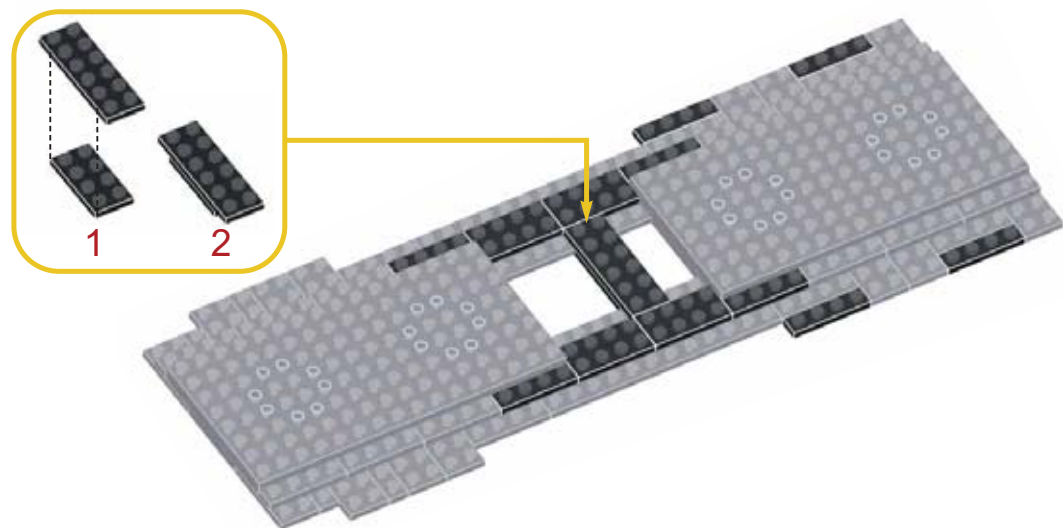
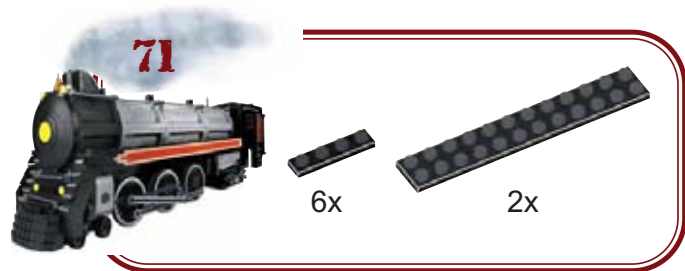

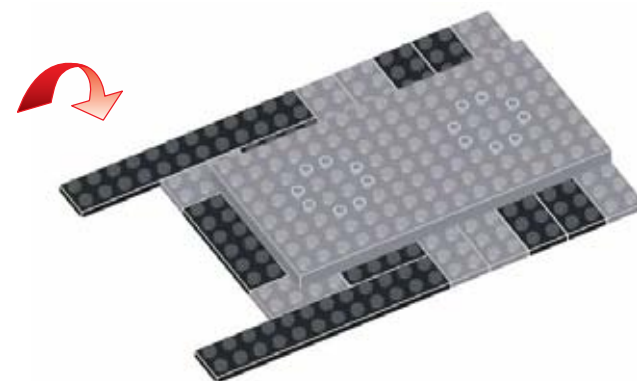
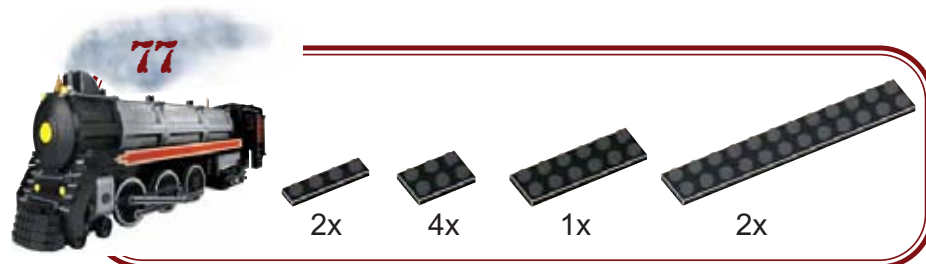
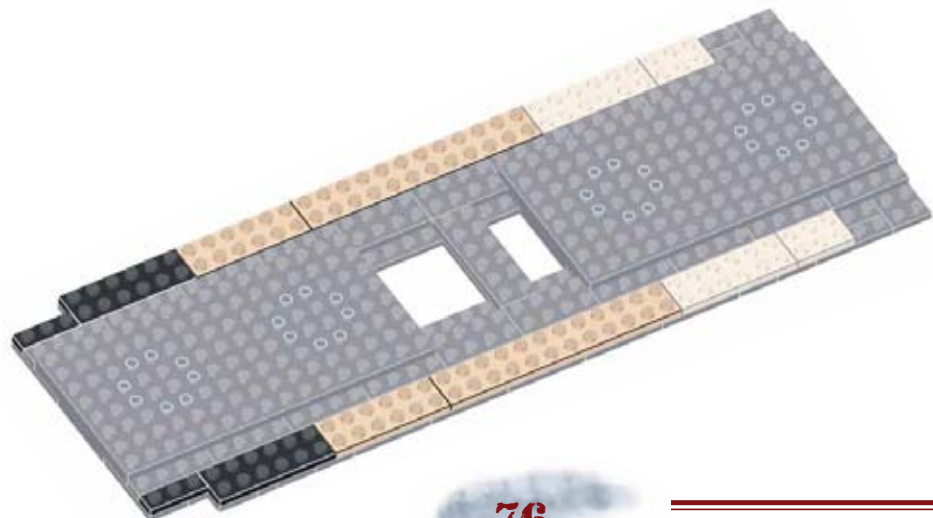
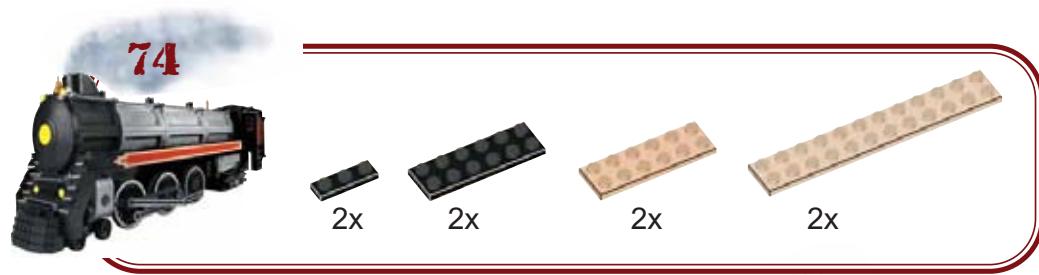

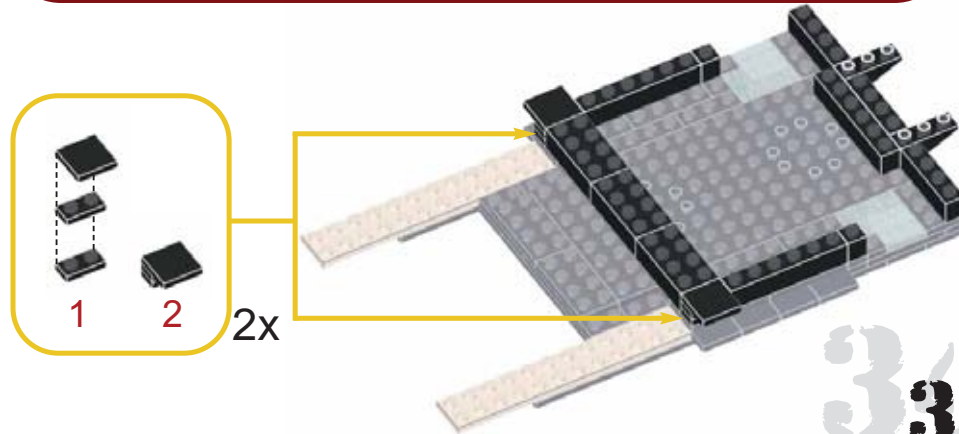
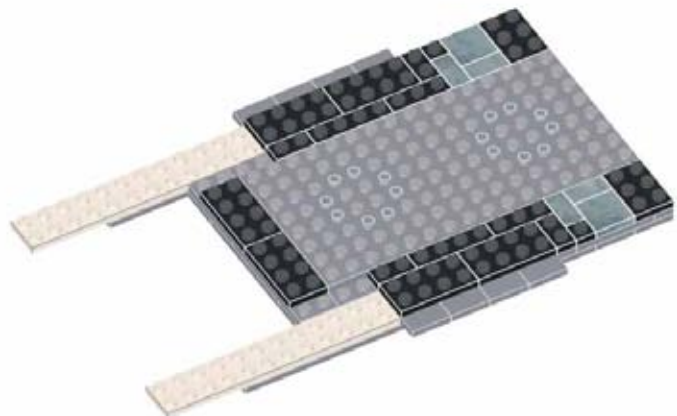
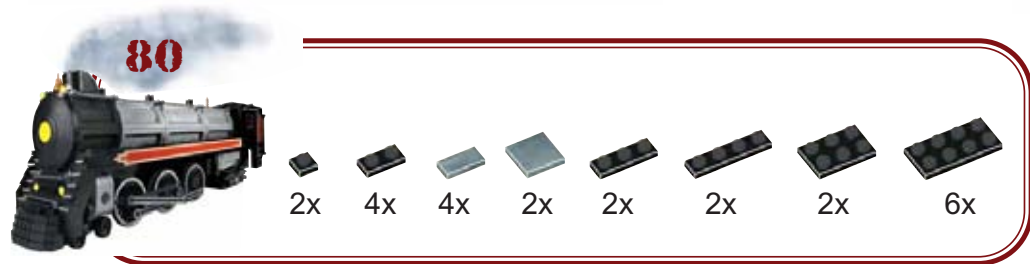
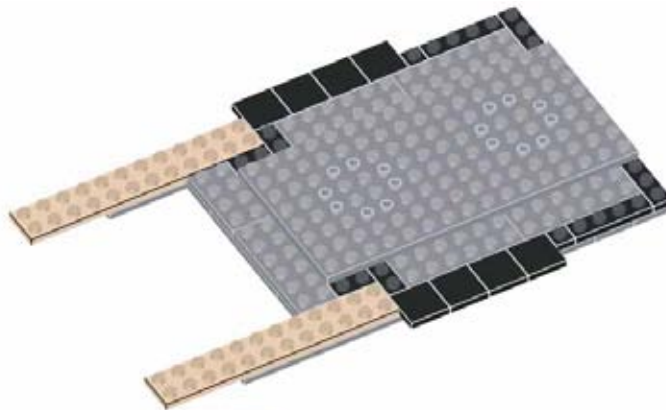
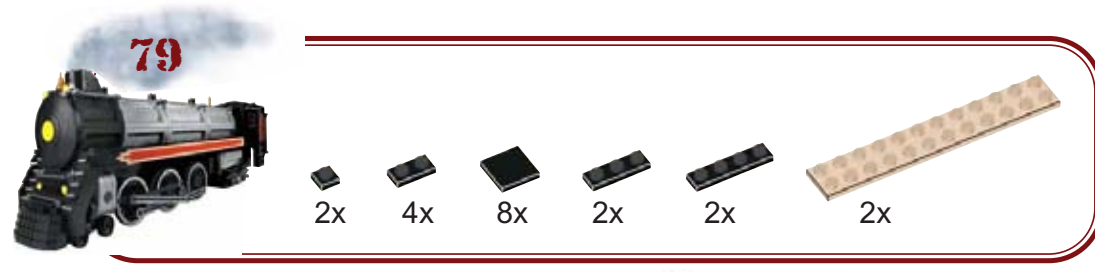
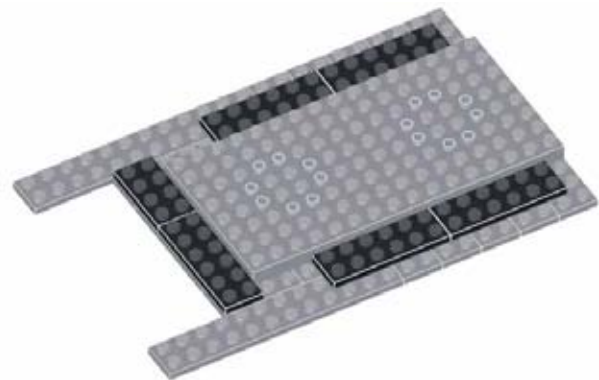
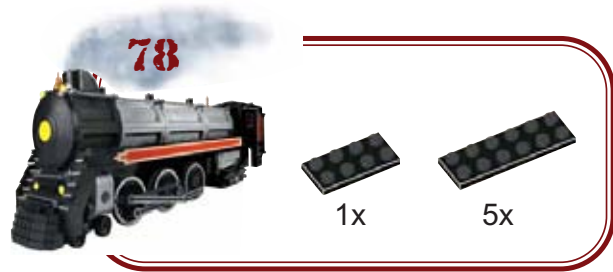



82

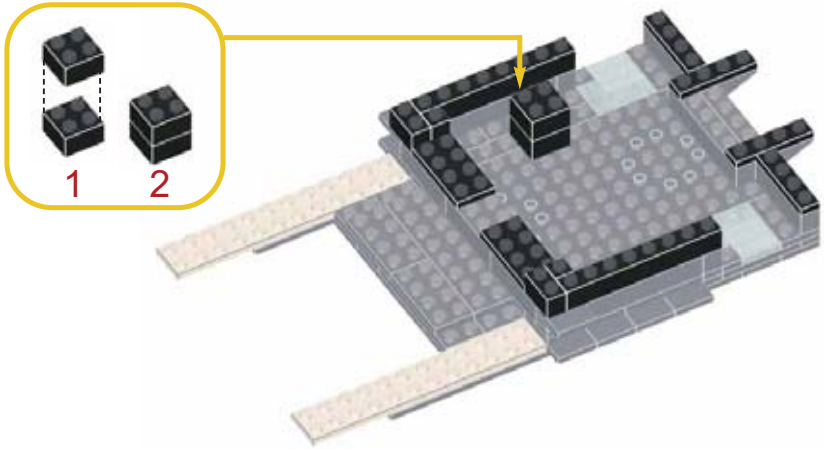

2x 2x 4x 2x 2x 2x



83



2x 4x 2x 2x

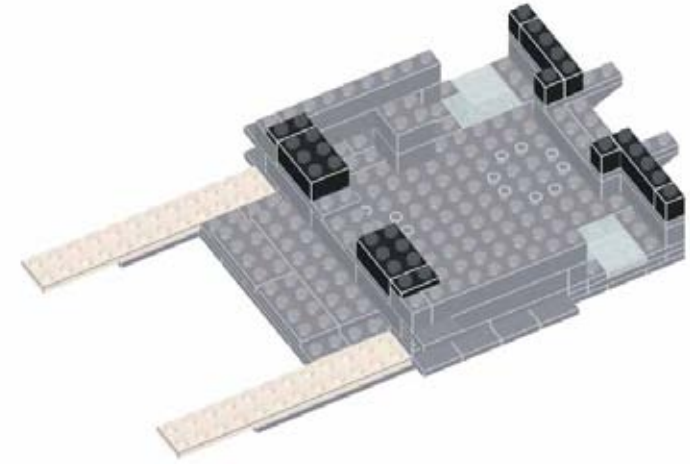

84



2x 2x 2x 2x 2x 2x

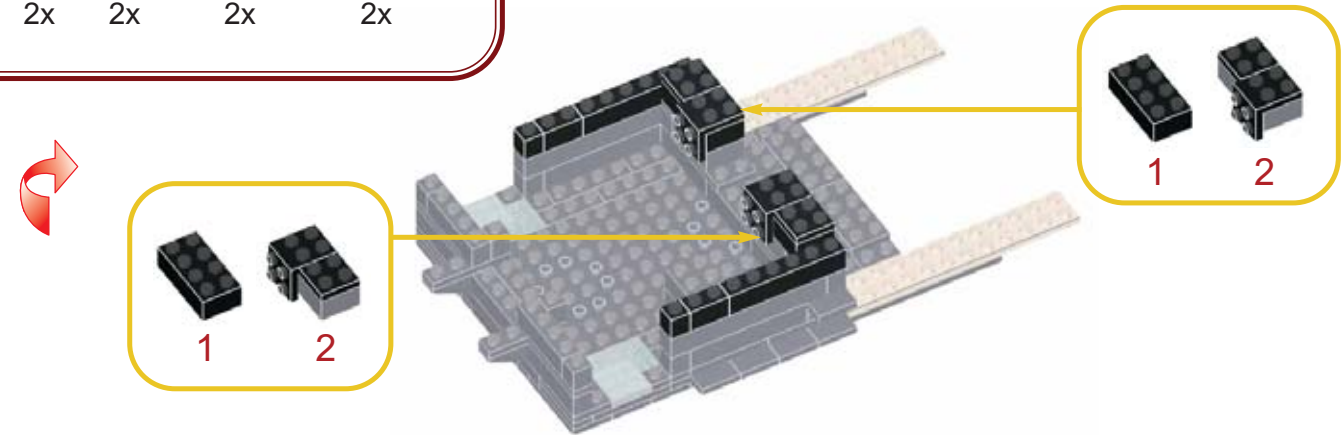



85

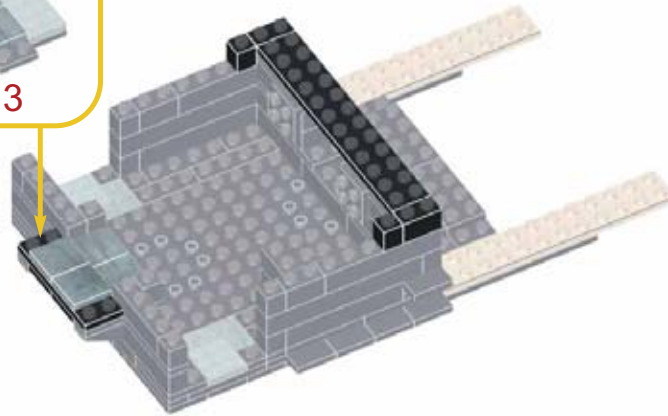

86

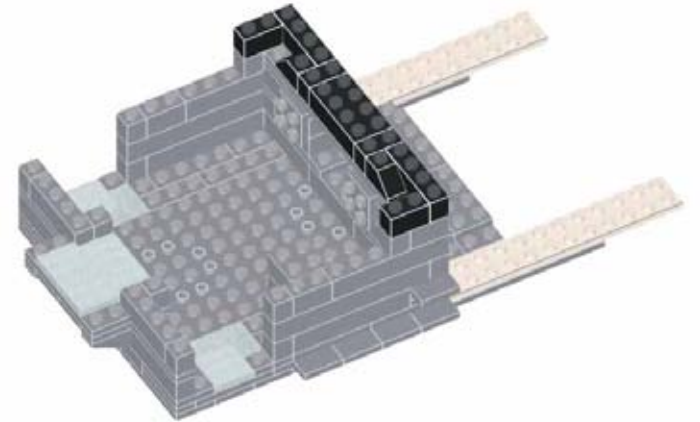
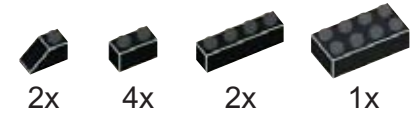

87



88



89



90



1x 2x 1x 1x

91



1x 1x 1x

92



1x 1x 1x



93



2x 2x 2x

94



3x 2x 2x 1x 1x 1x 1x 1x 1x



Adult assistance may be required. / Puede ser necesaria la ayuda de un adulto.
L'assistance d'un adulte peut être requise. / De hulp van een volwassene kan nodig zijn.

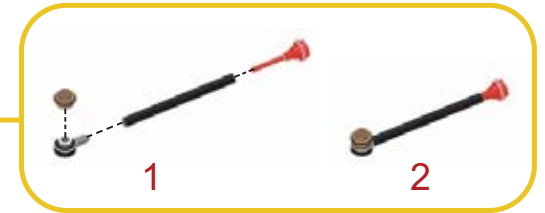
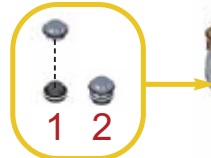
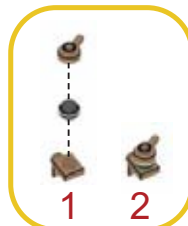

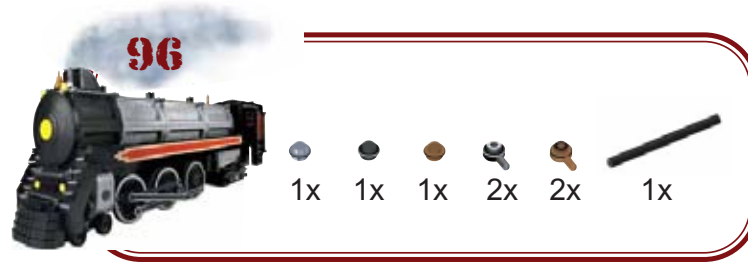
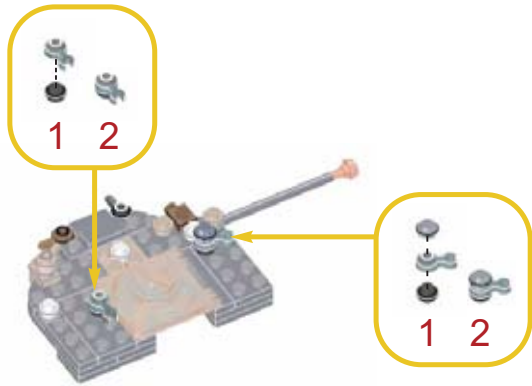
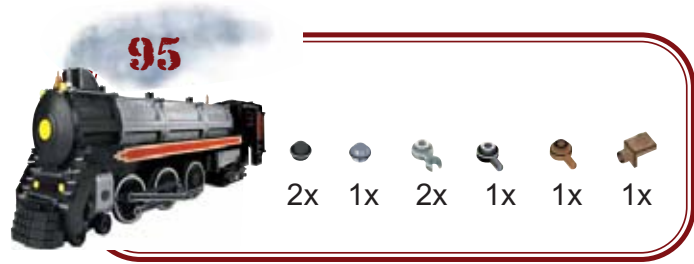

Adult assistance may be required.
 Puede ser necesaria la ayuda de un adulto.
 L'assistance d'un adulte peut être requise.
 De hulp van een volwassene kan nodig zijn.

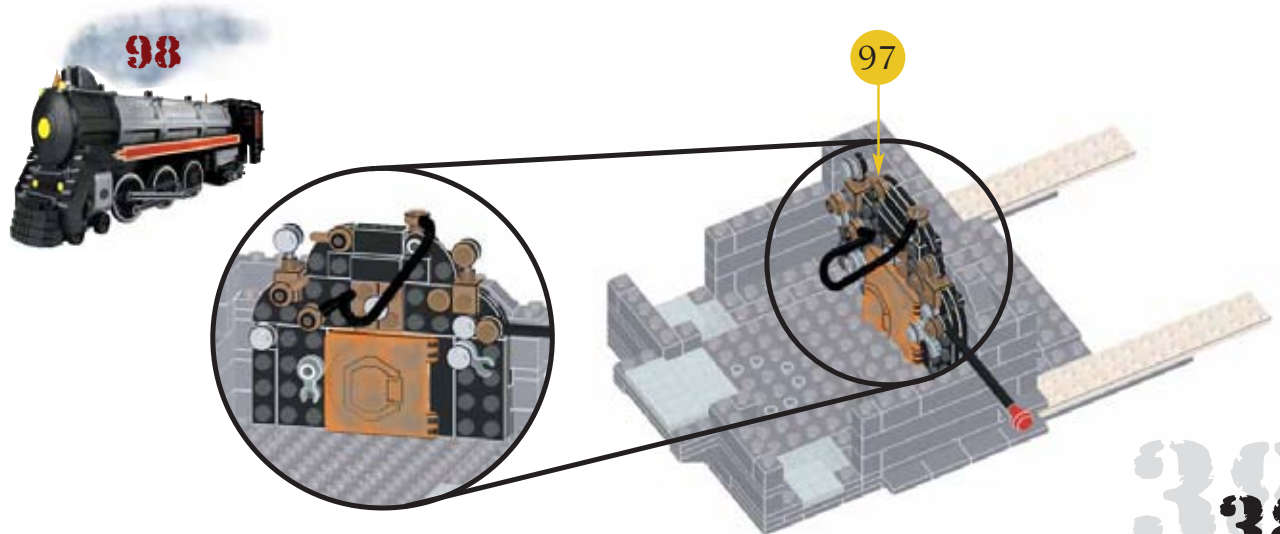

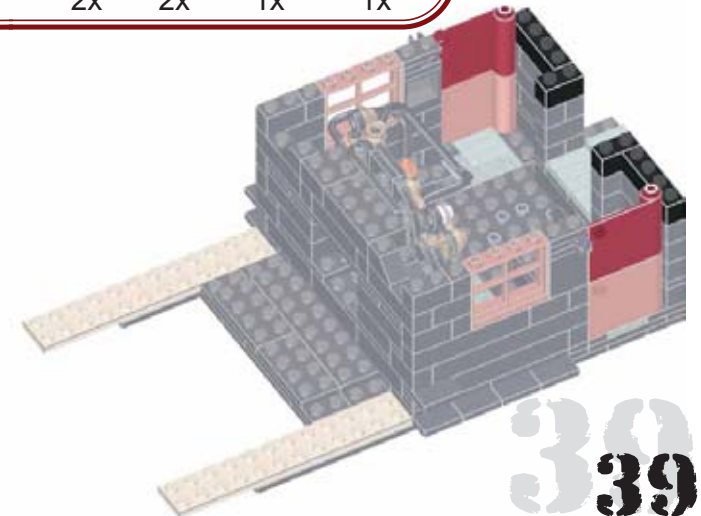
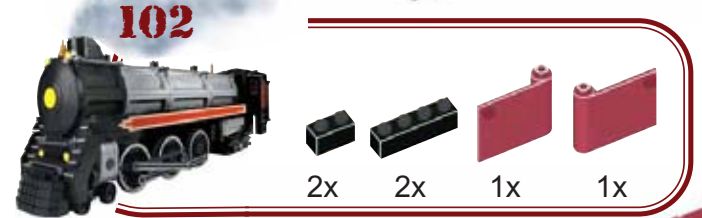
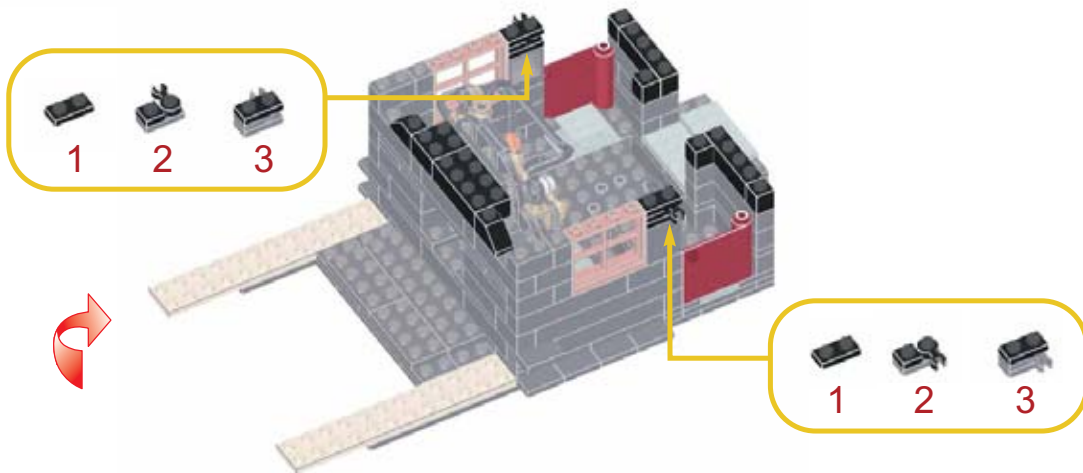
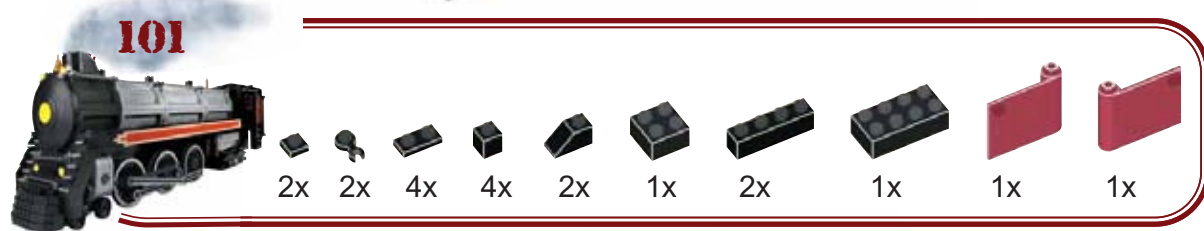
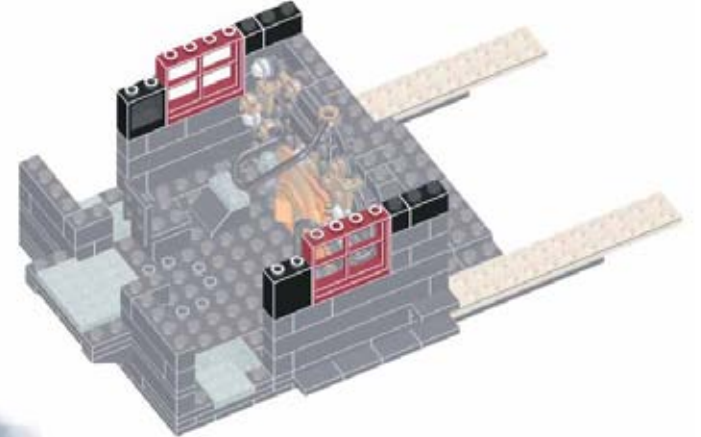
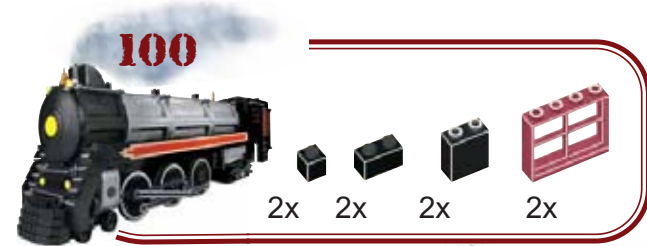
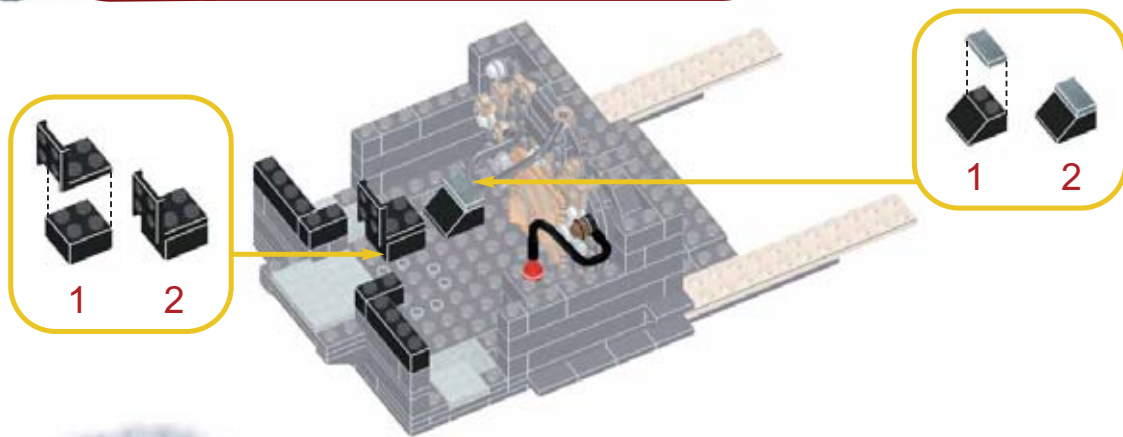
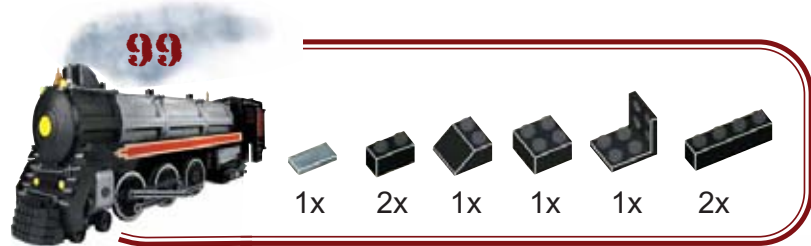



103



2x 2x 8x 2x

1 2 2x



104



4x 1x 1x



105



2x 3x 4x 1x 3x 1x 1x



1 2 3



106



4x 2x 2x 4x 2x 2x



1 2 4x



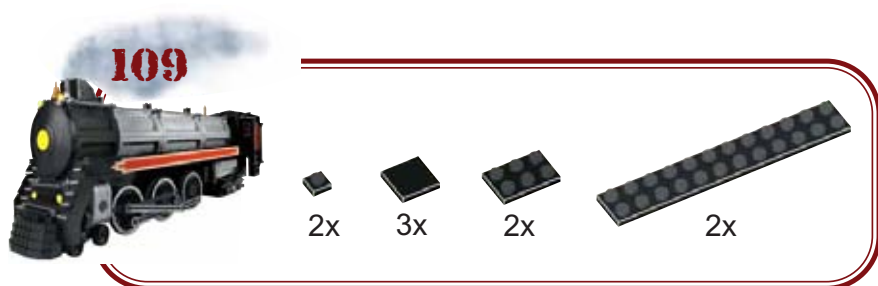
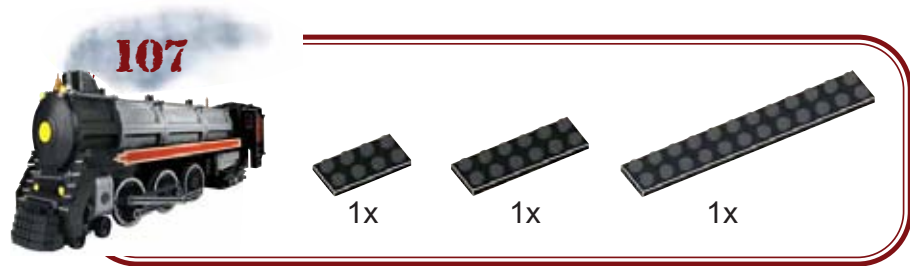

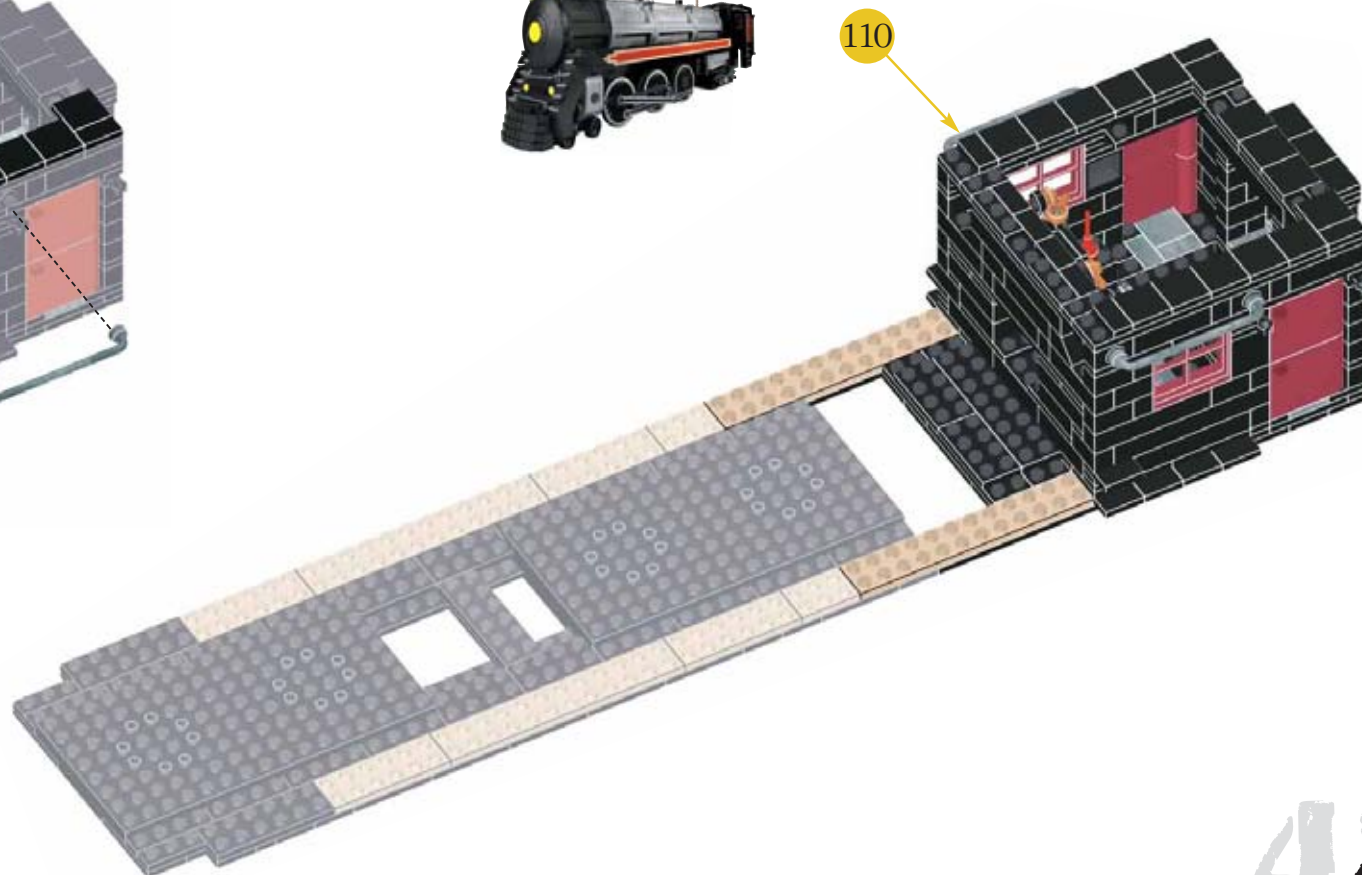
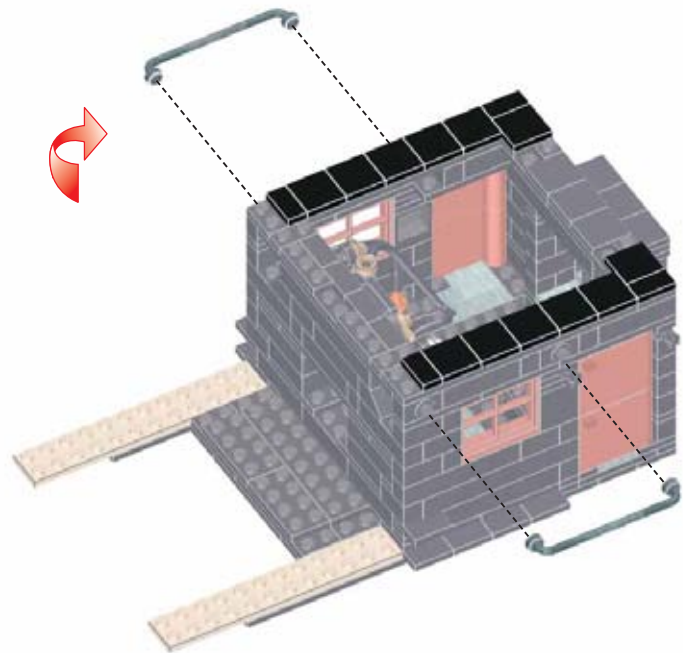
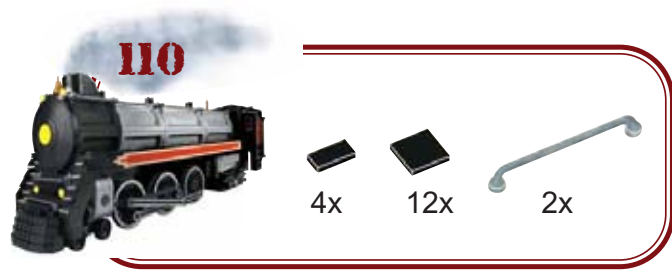

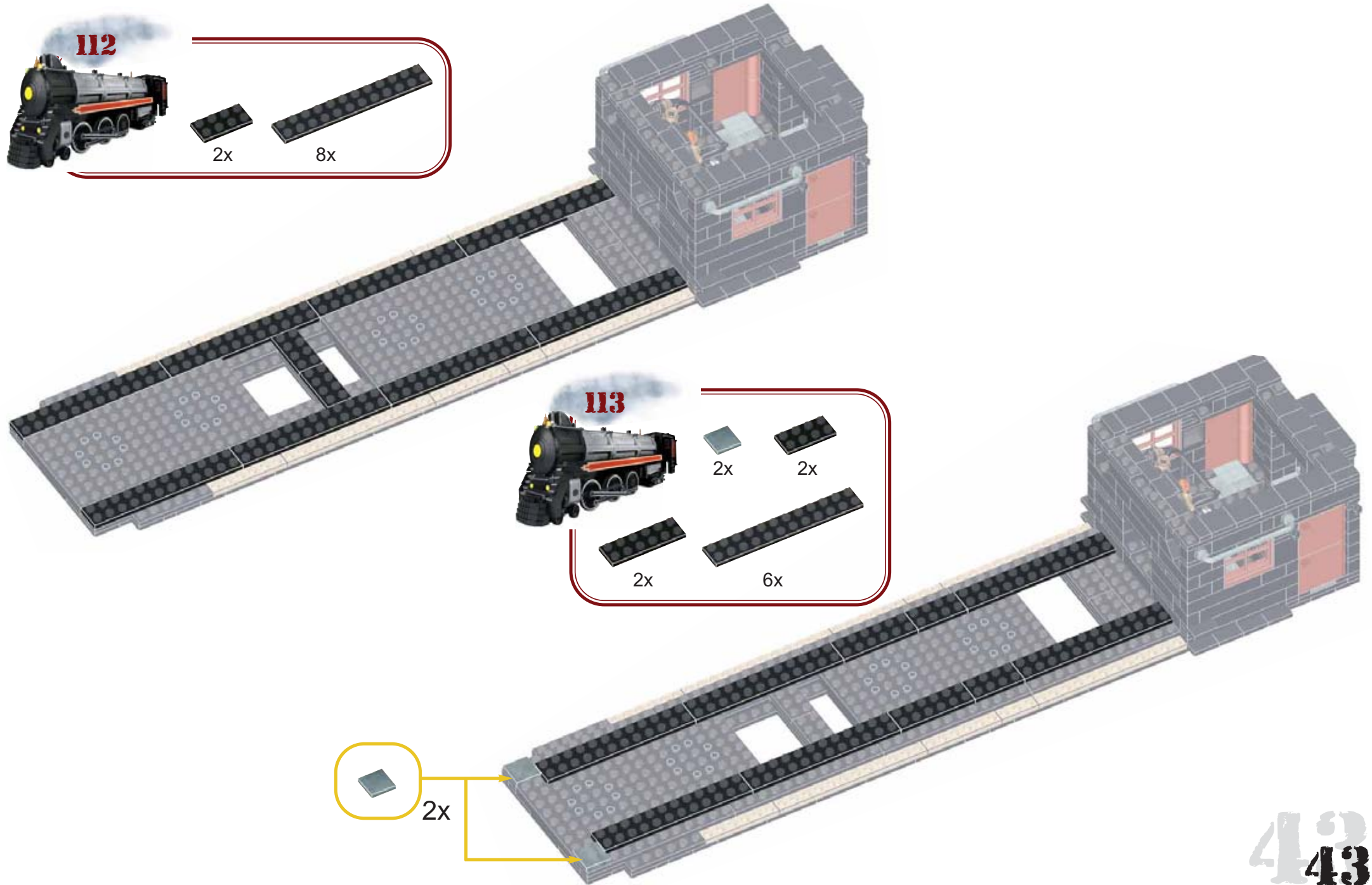
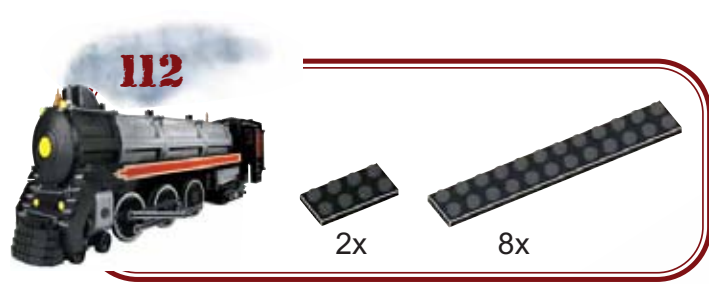



114

2x

2x

2x

10x

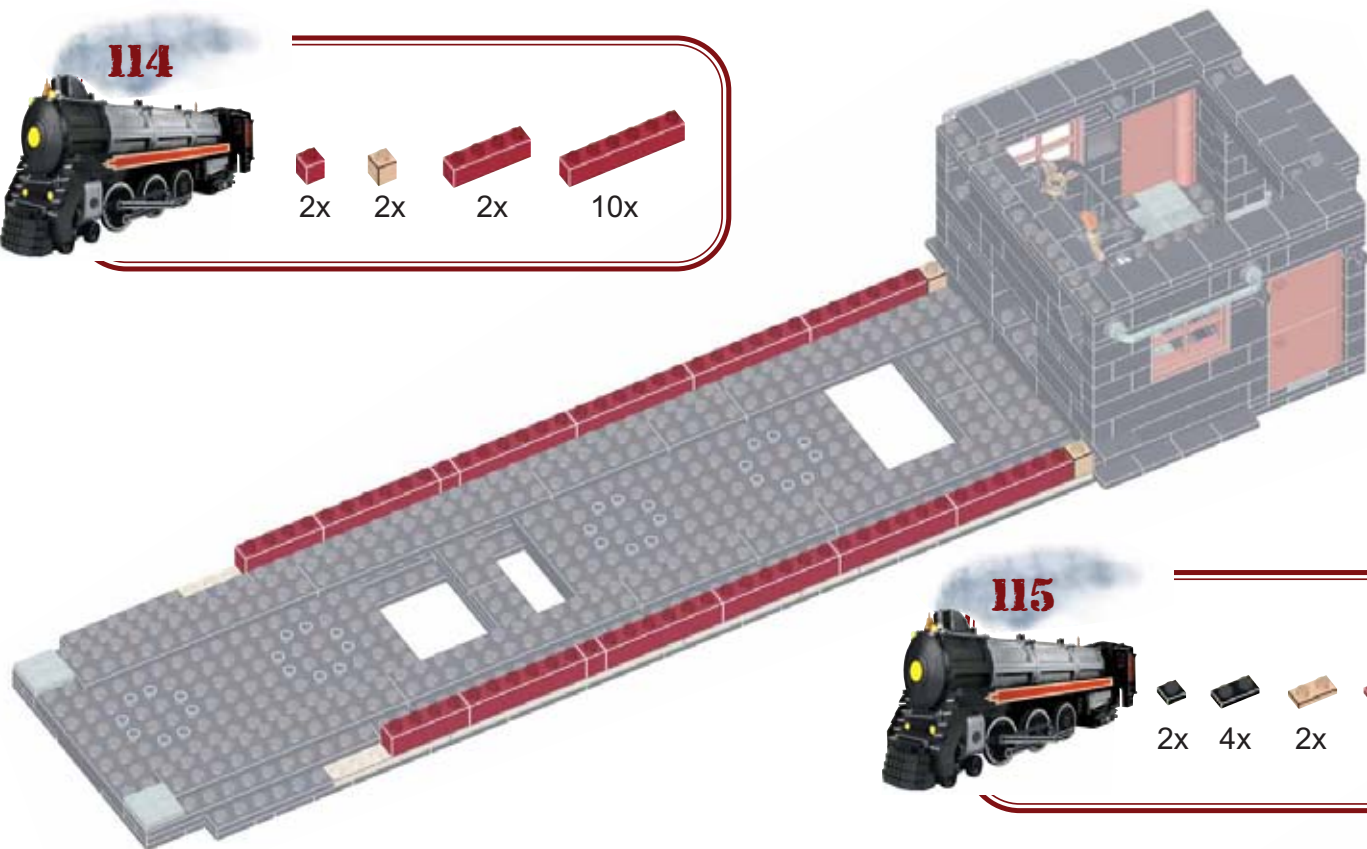

115

2x

4x

2x

4x

4x

2x

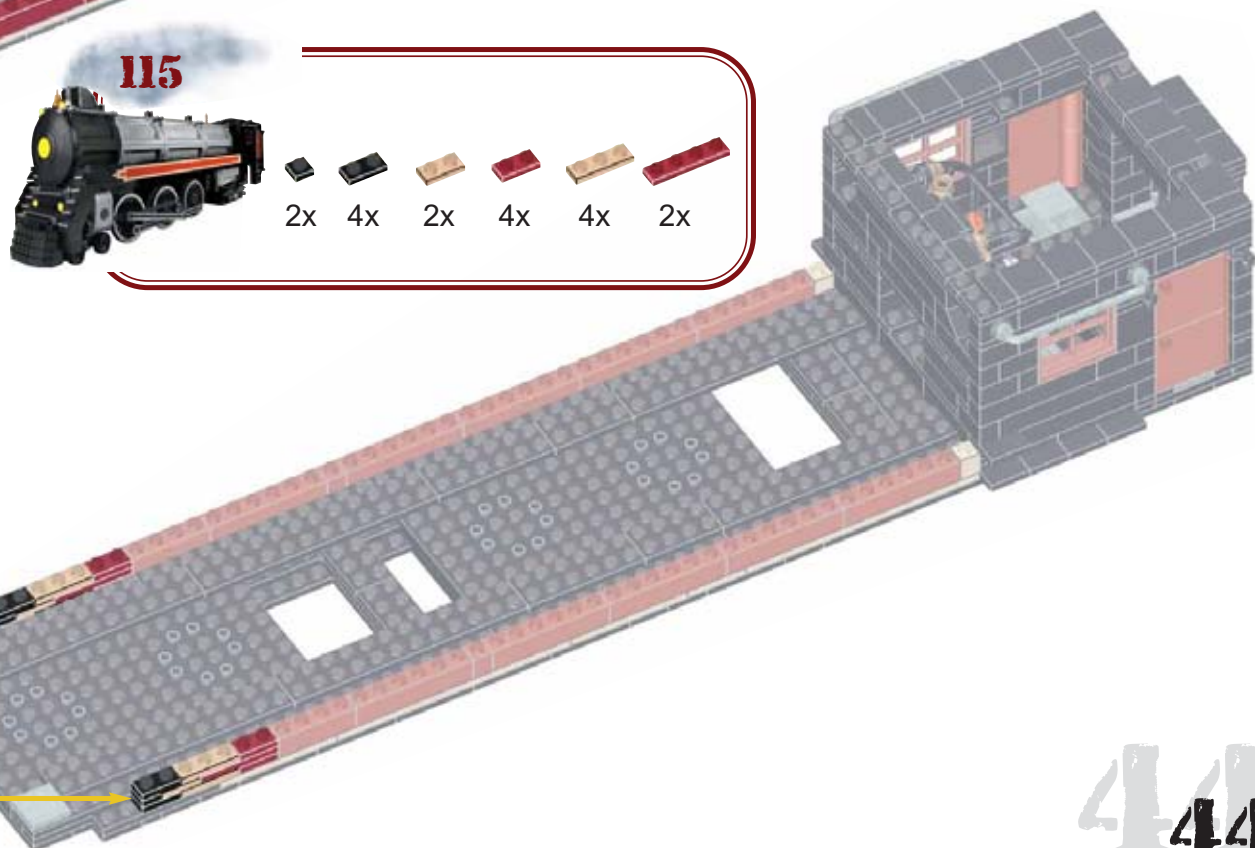

1

2

3

2x



116



2x



2x



18x

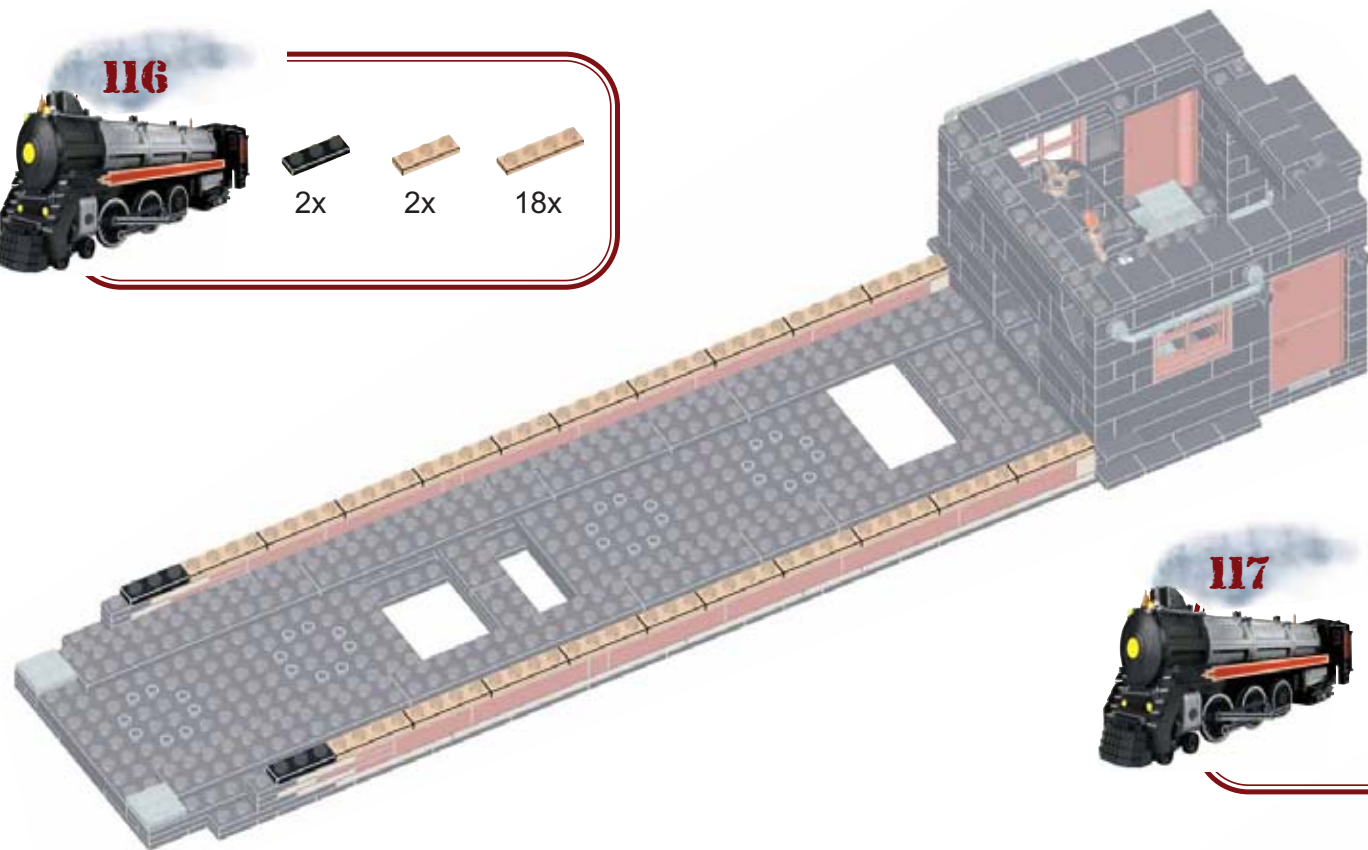

117



42x

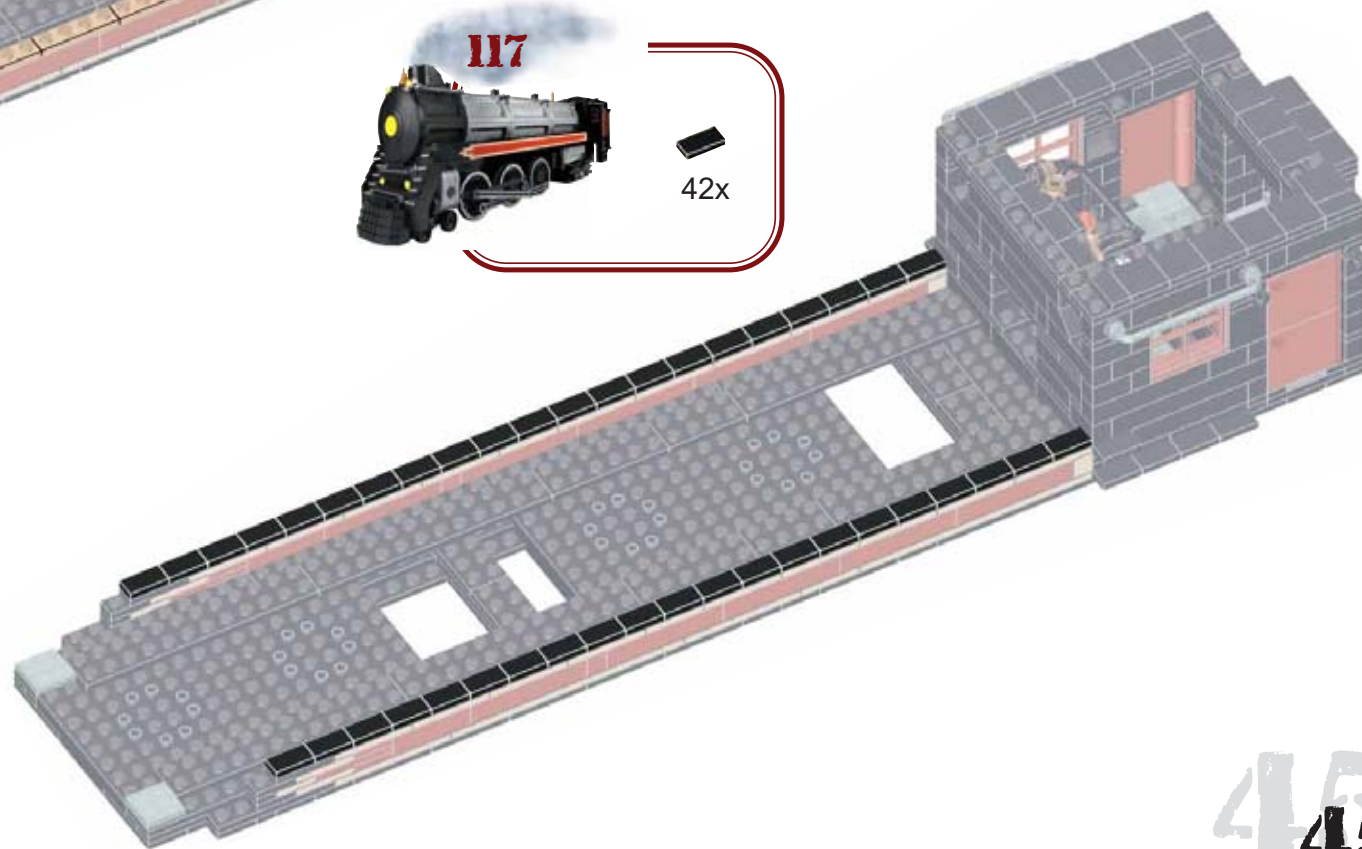



118

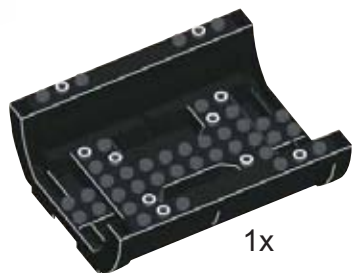

1x



3x

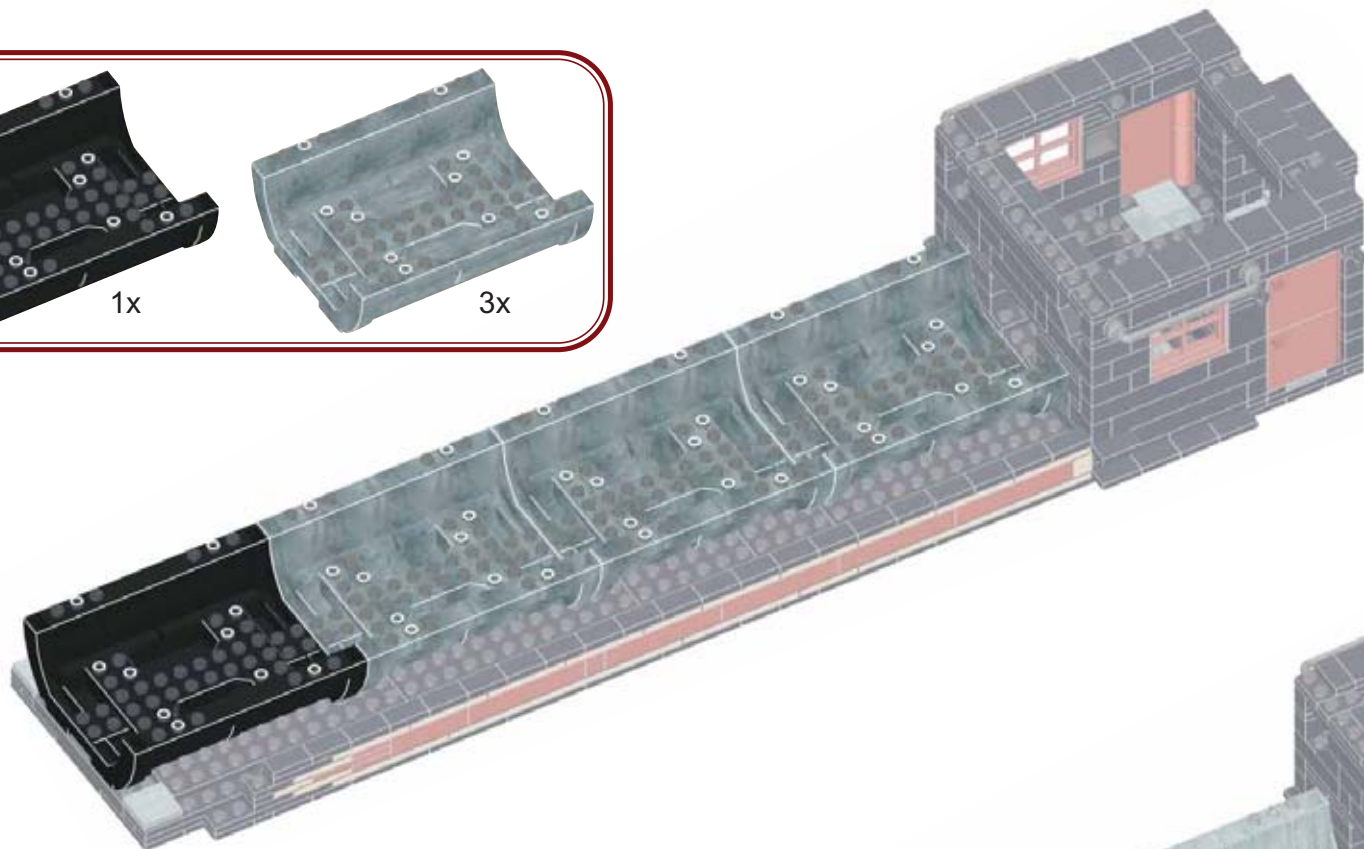

119



3x



1x

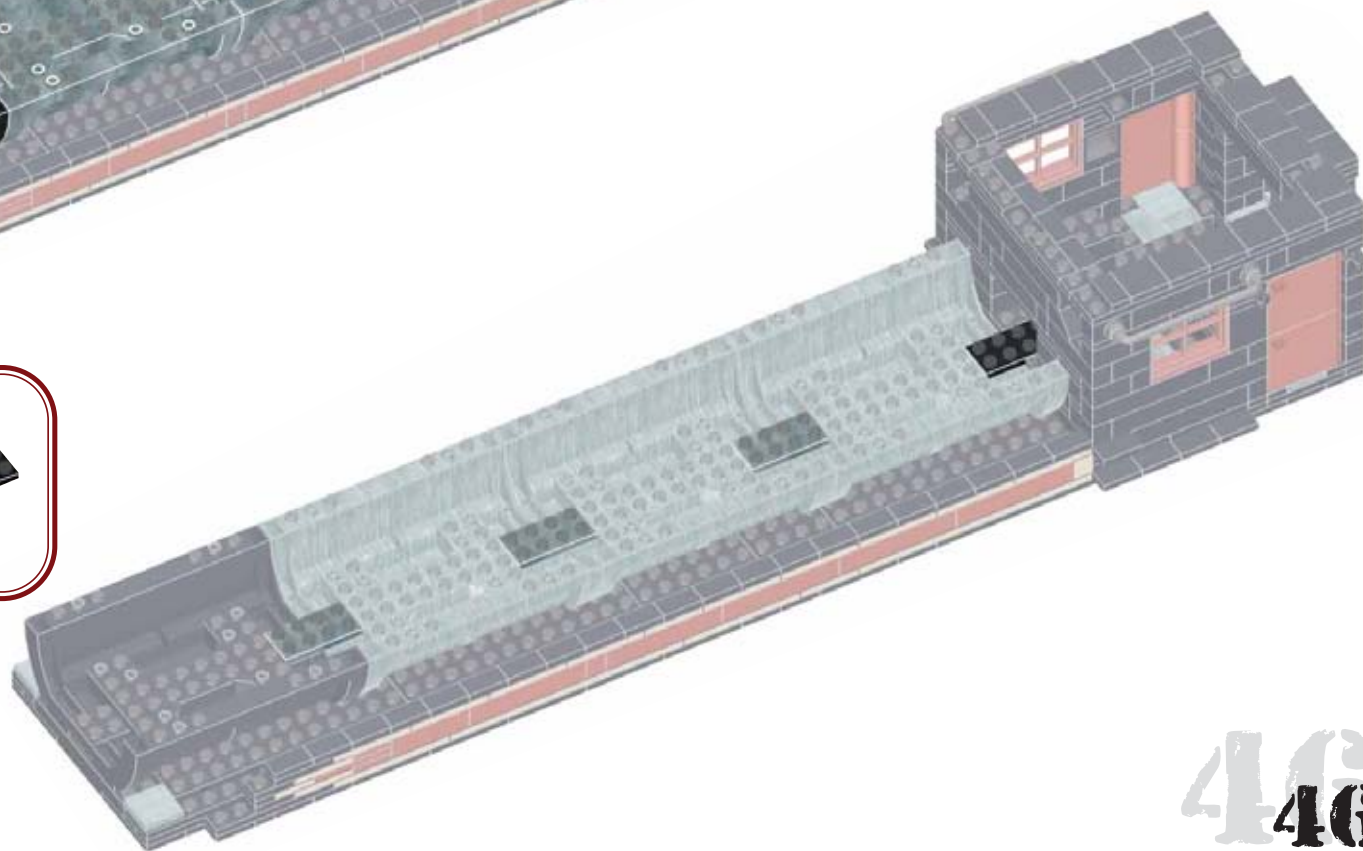

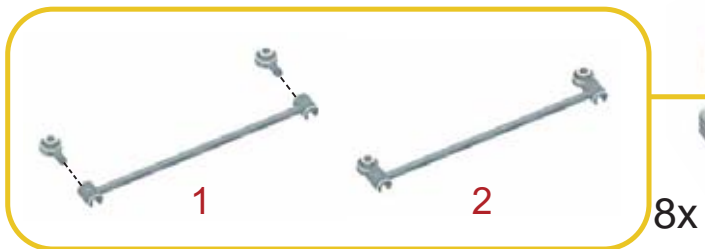
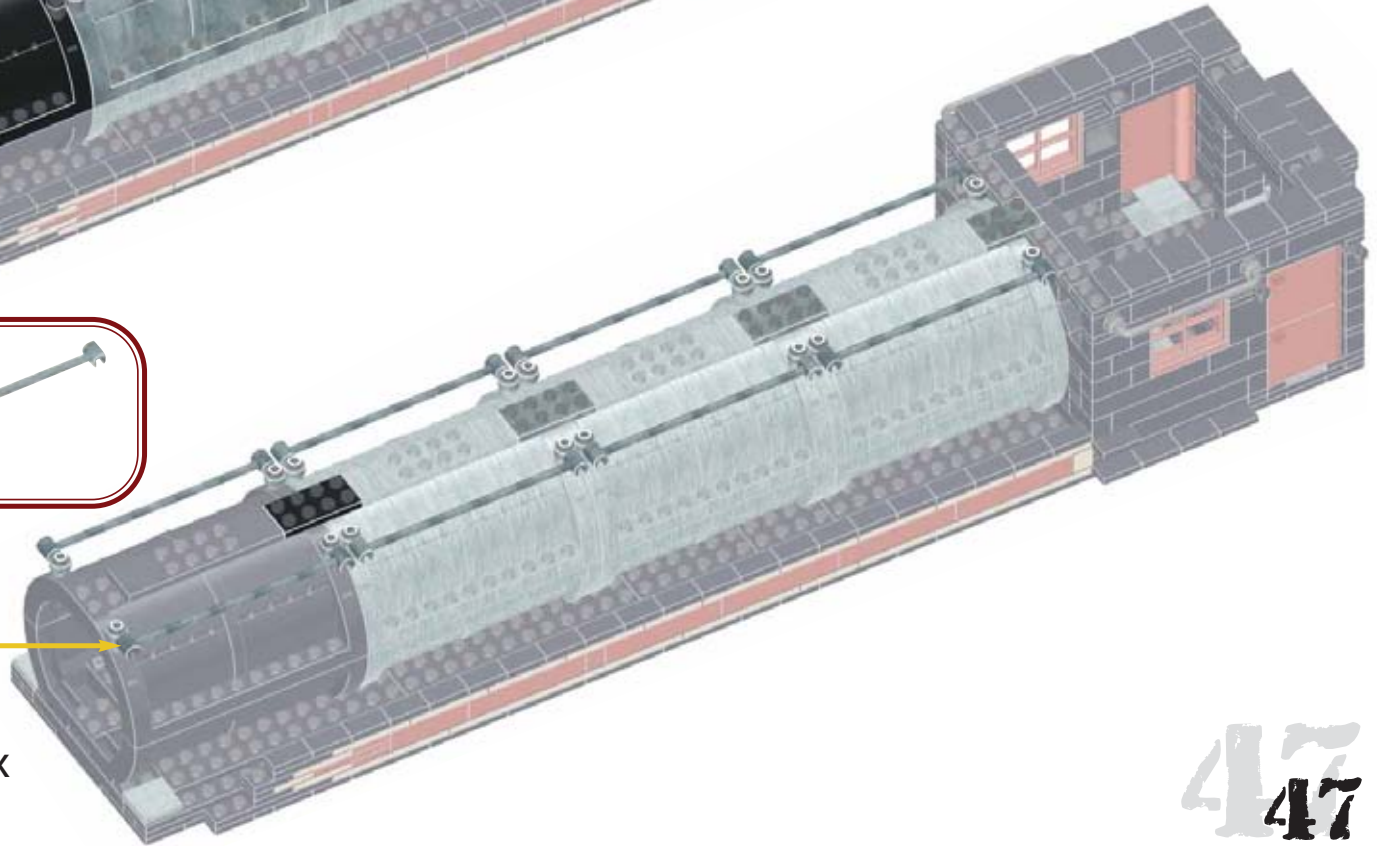
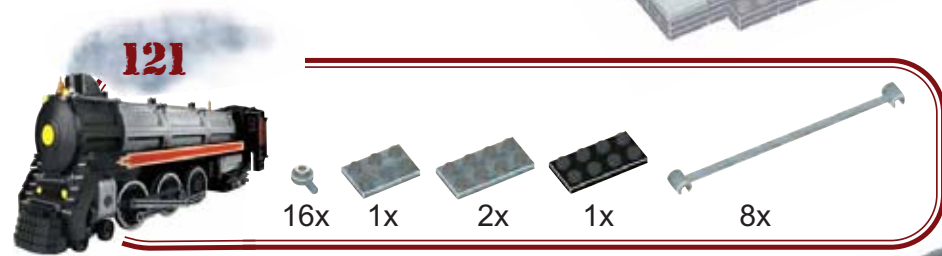
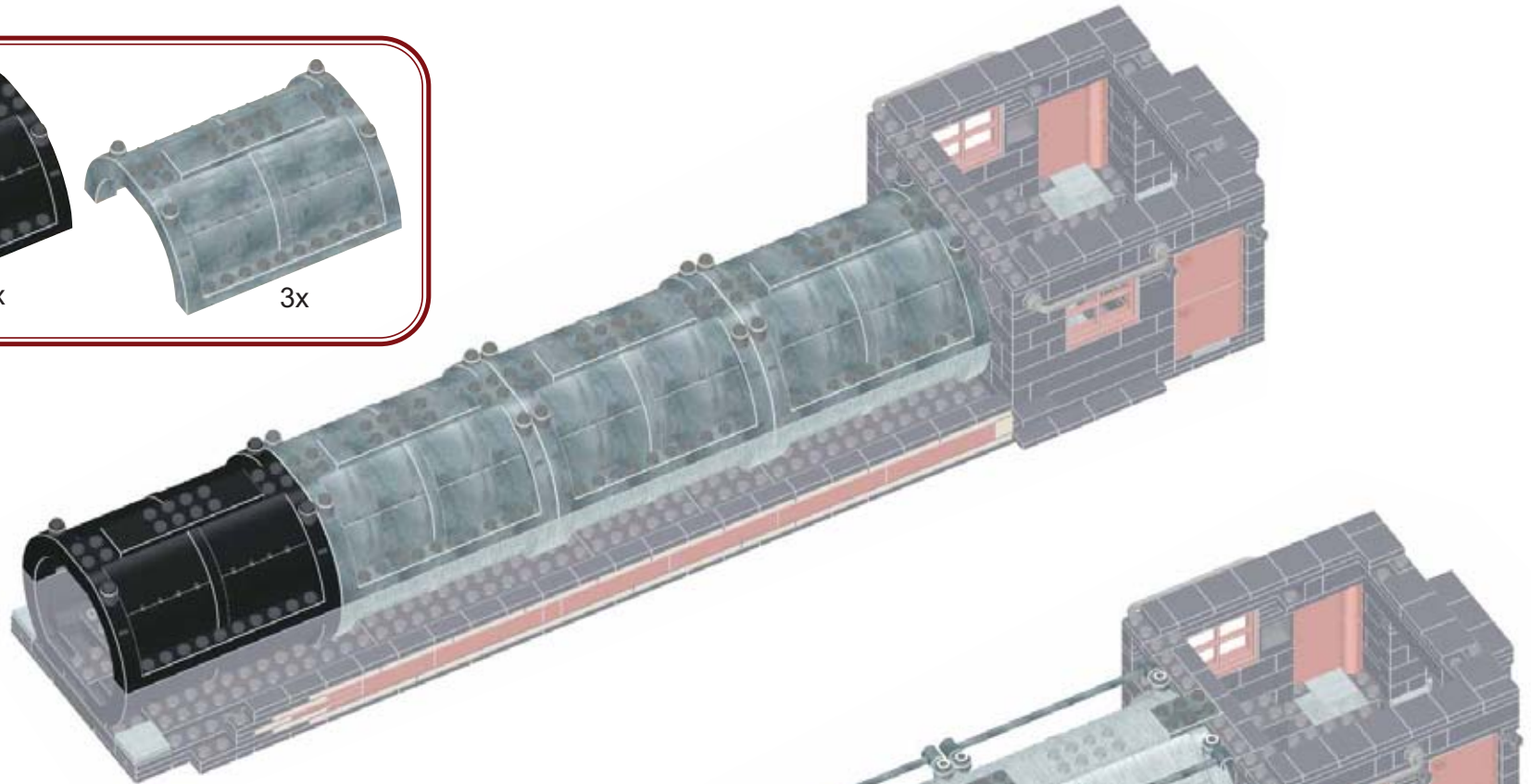



122



1x  3x  3x 

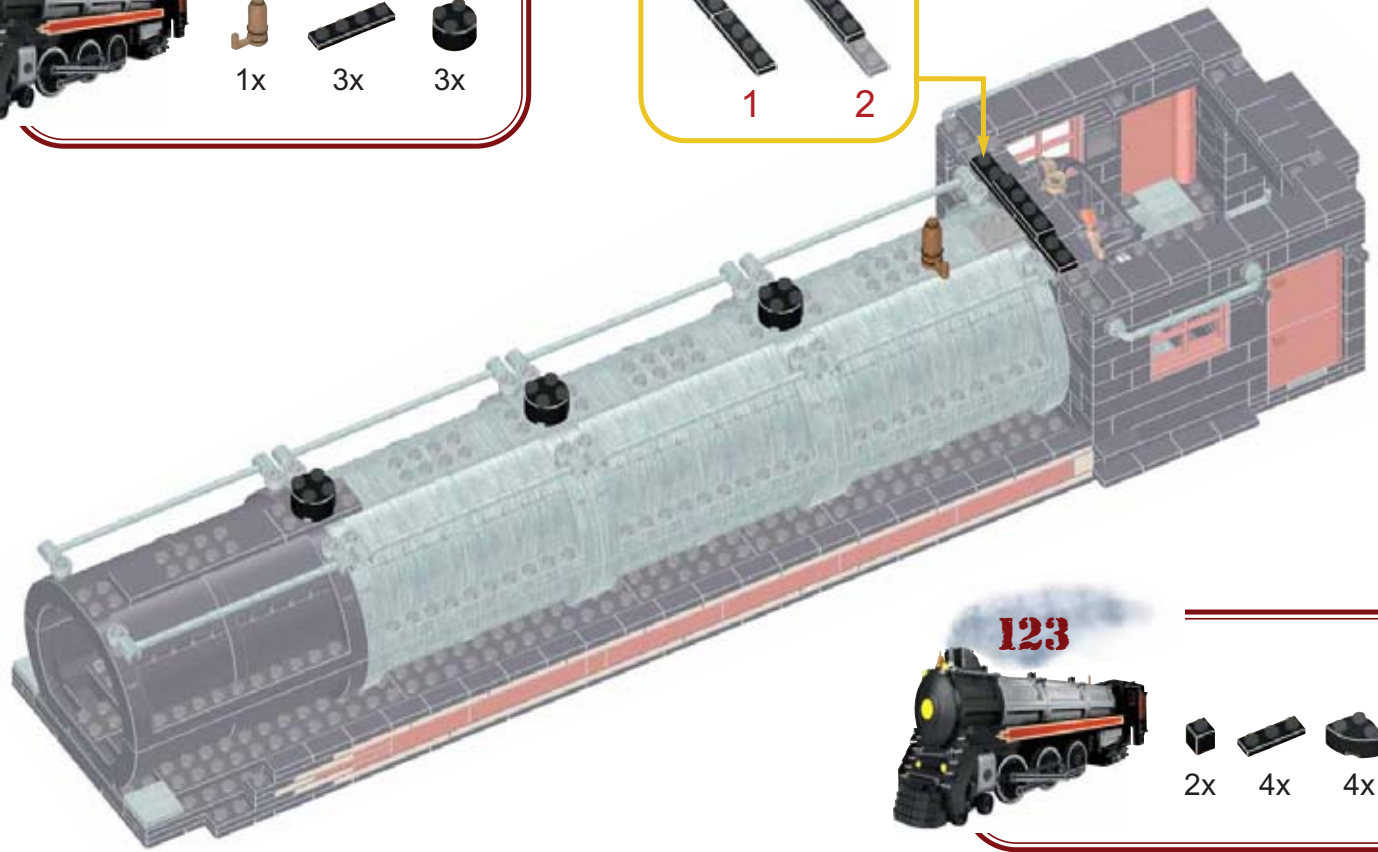

1  2 



123



2x  4x  4x  2x  2x  2x  1x  1x 2x 

1  2  2x

1  2  3  4 

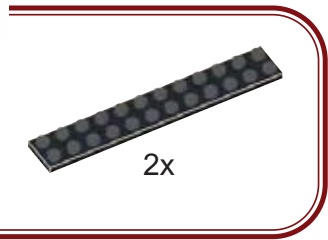
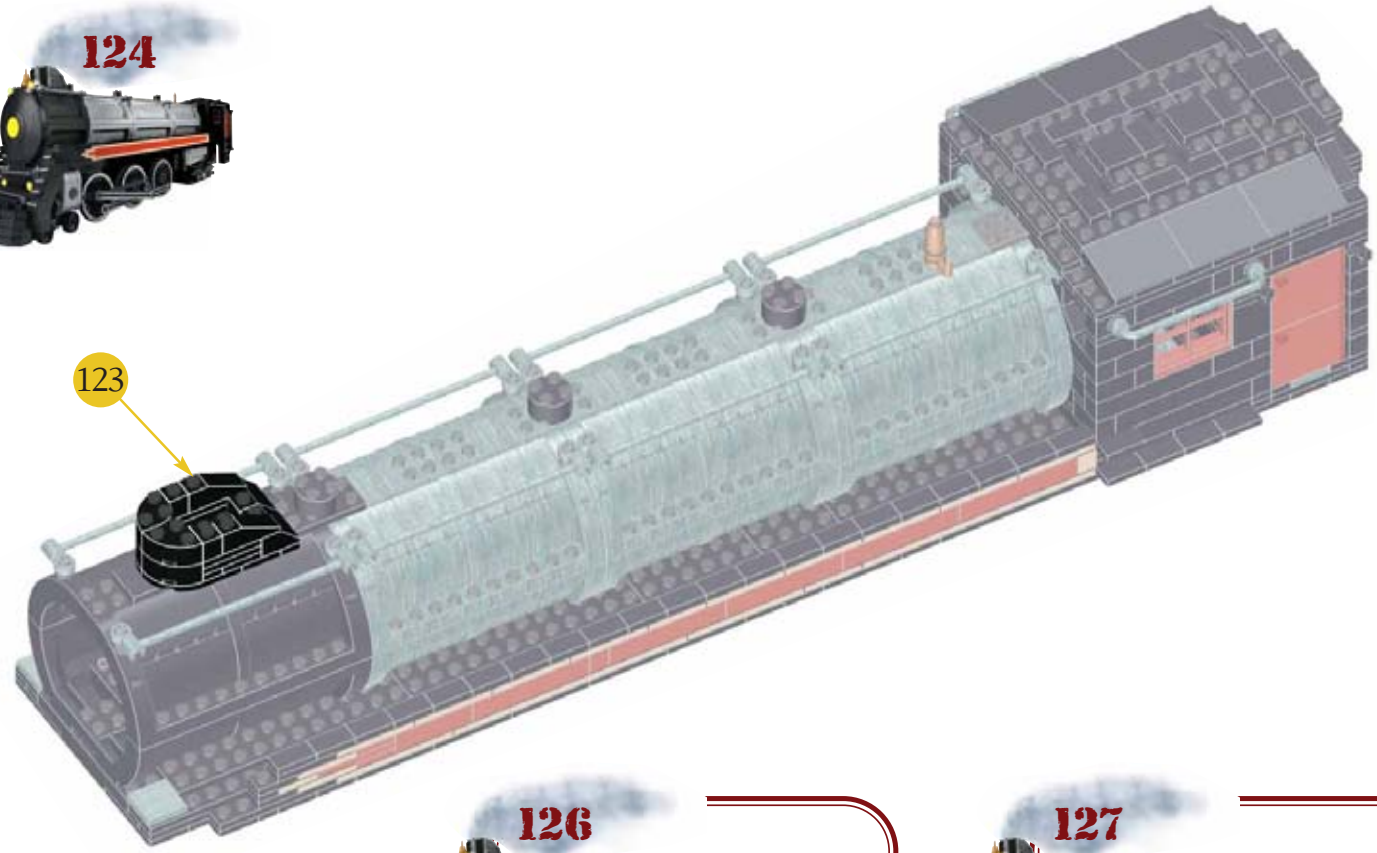

123

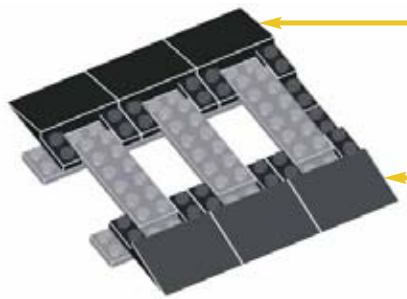
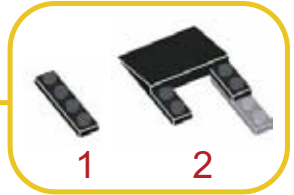

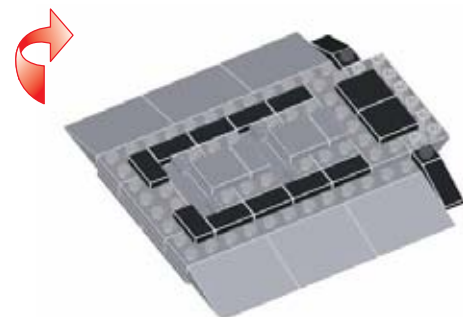
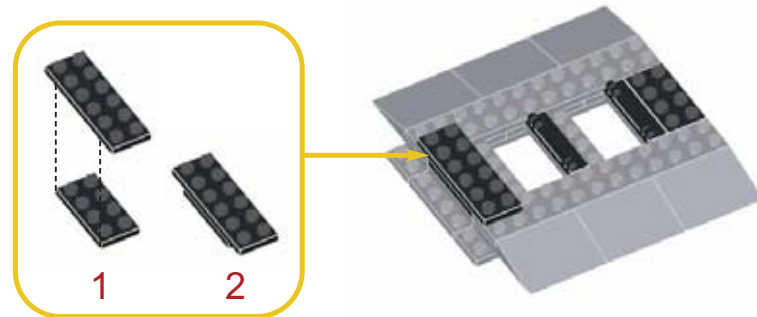
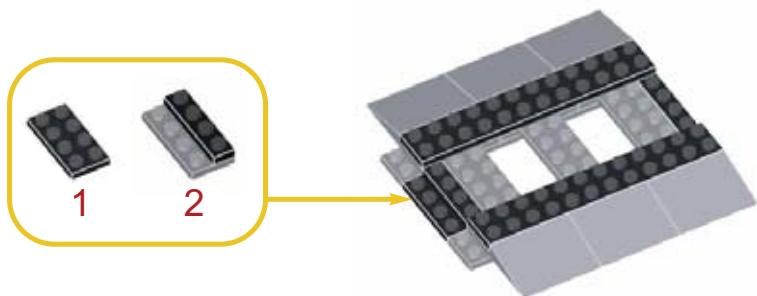
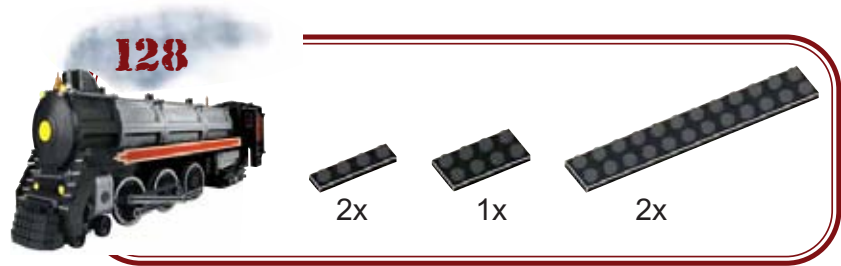

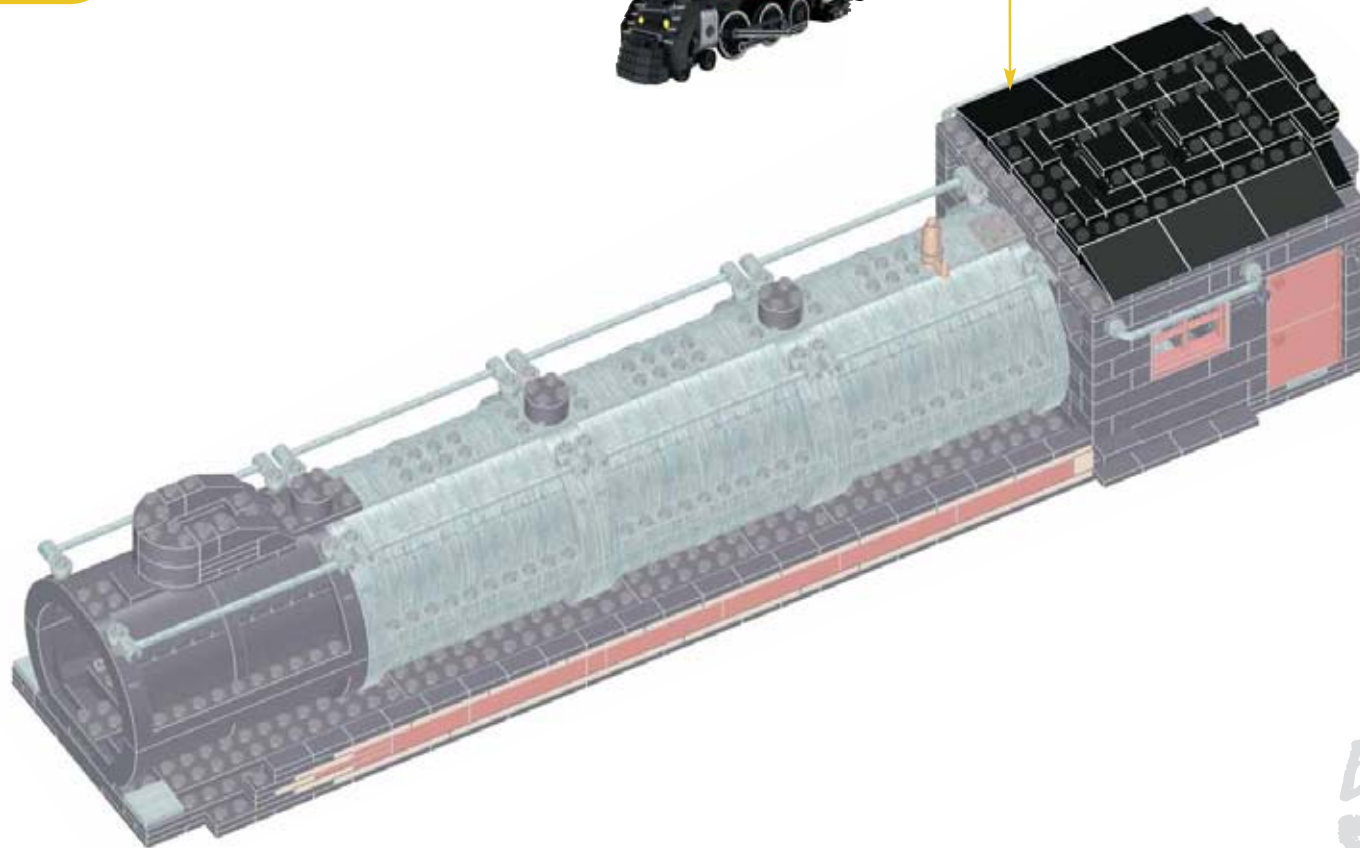
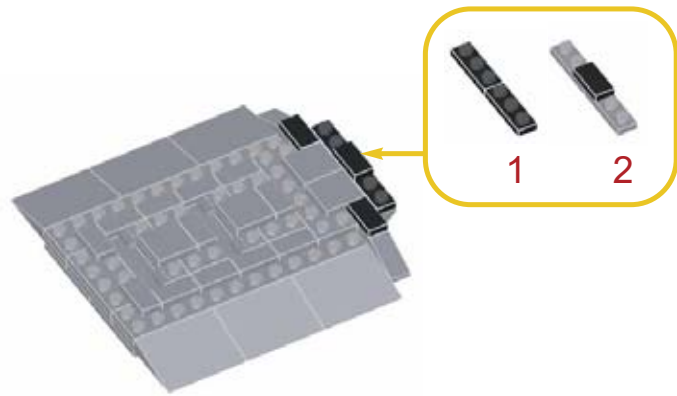

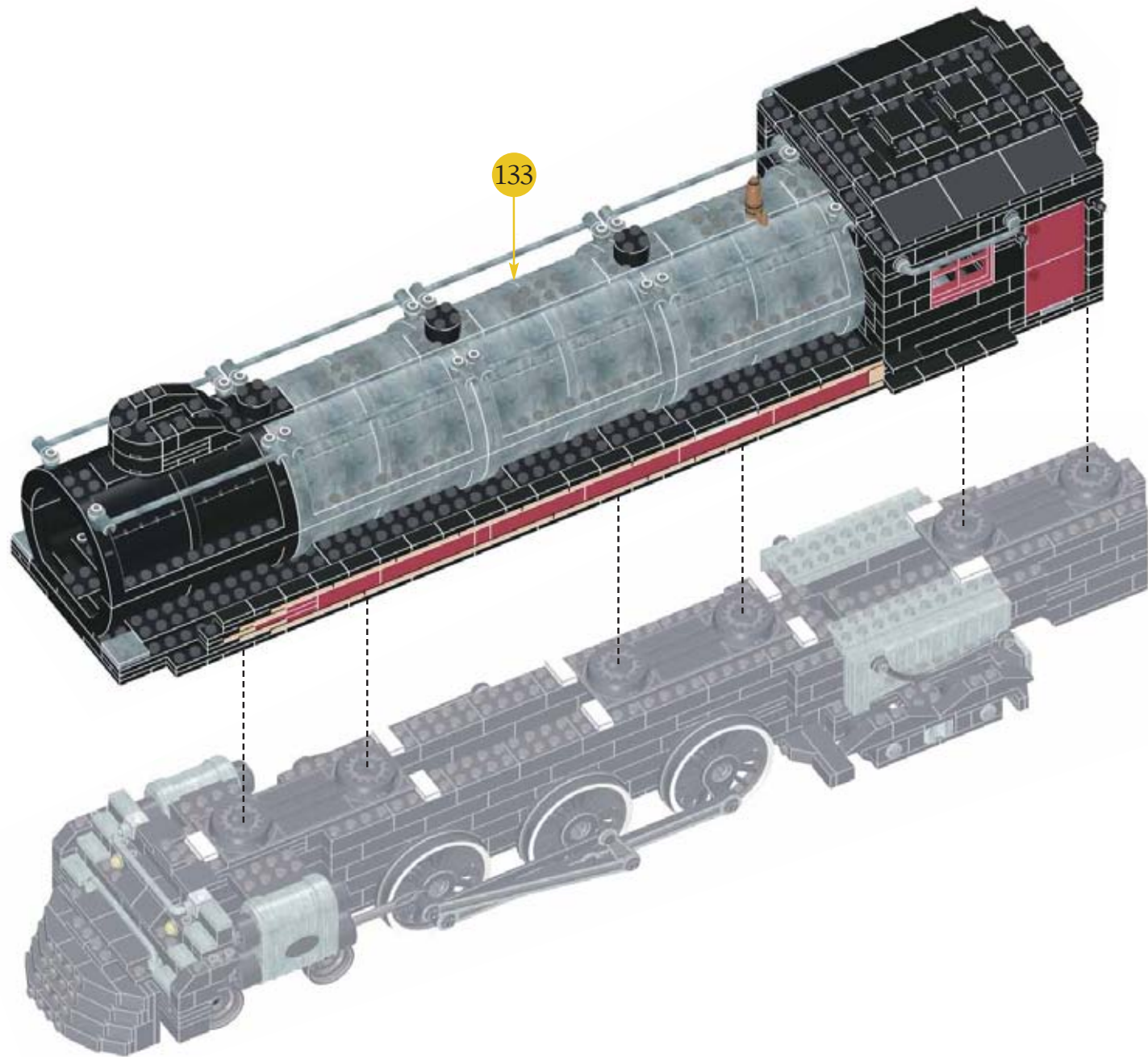



1x

2x

2x

4x

2x

2x



1x



2x



2x

2x

3x

6x

3x

3x

1x

4x

2x

3x

1x

2x



1



2



3



4



5



6



7



8

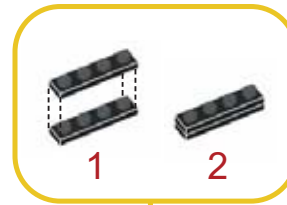

1

2



9



10



137

- 3x [1x3 black Technic brick]
- 1x [1x2 black Technic brick]
- 1x [1x2 black Technic brick with hole]
- 1x [1x brown Technic bush]
- 1x [1x4 black Technic brick]
- 1x [1x4 black Technic brick]
- 1x [1x6 black Technic brick]



Adult assistance may be required. / Puede ser necesaria la ayuda de un adulto.
L'assistance d'un adulte peut être requise. / De hulp van een volwassene kan nodig zijn.

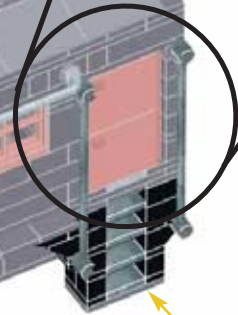
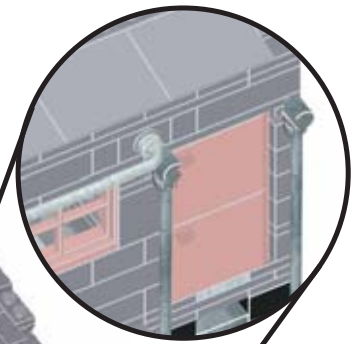
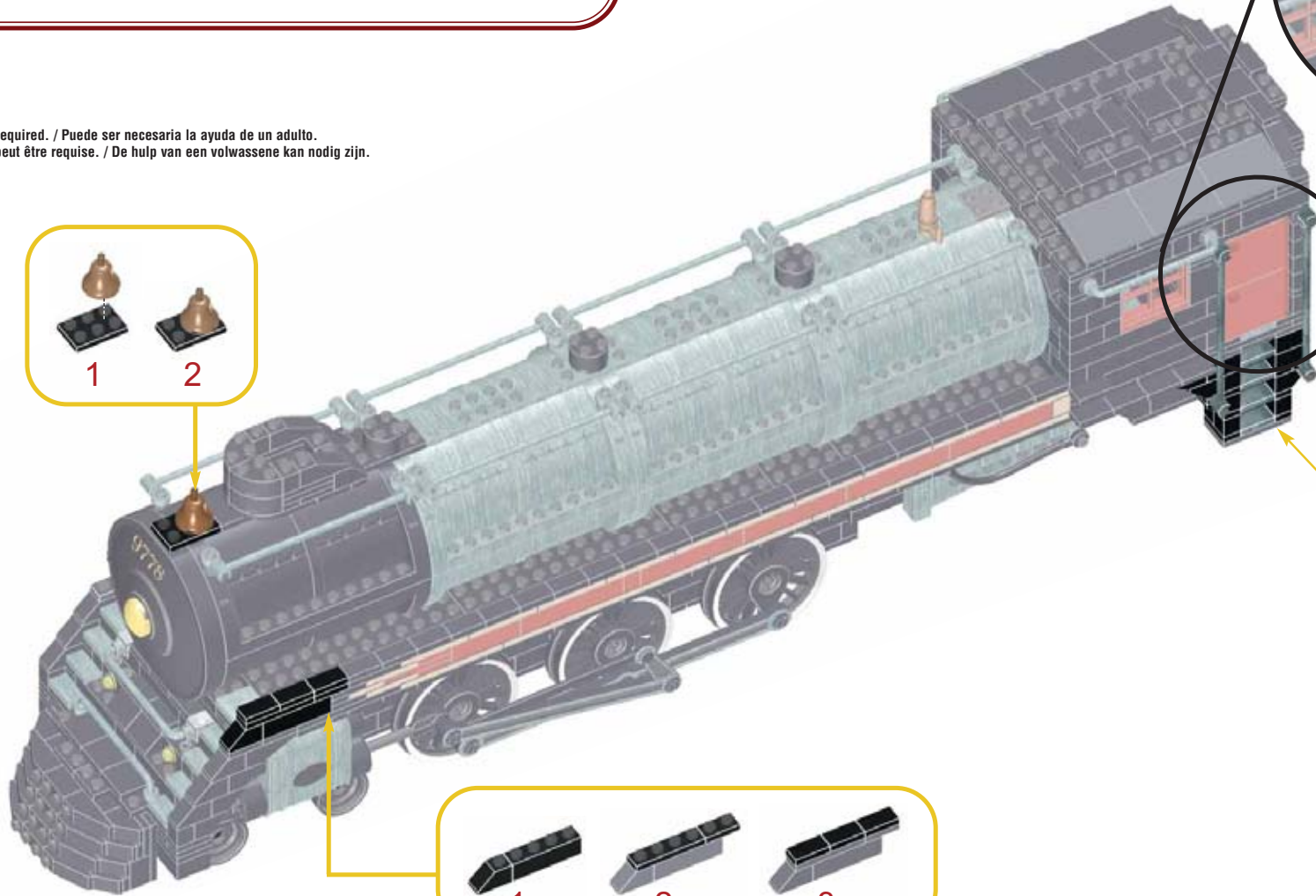

136



- 2x
- 2x
- 3x
- 6x
- 3x
- 3x
- 1x
- 4x
- 2x
- 3x
- 1x
- 2x



1



2



3



4



5



6



7



8

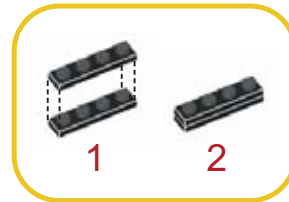

9



10



139

- 
2x
- 
2x
- 
3x
- 
1x
- 
1x
- 
1x
- 
1x



Adult assistance may be required. / Puede ser necesaria la ayuda de un adulto.
L'assistance d'un adulte peut être requise. / De hulp van een volwassene kan nodig zijn.

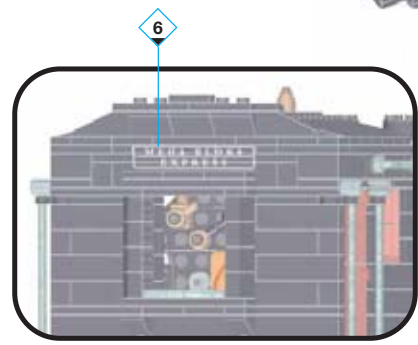
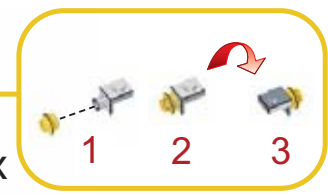
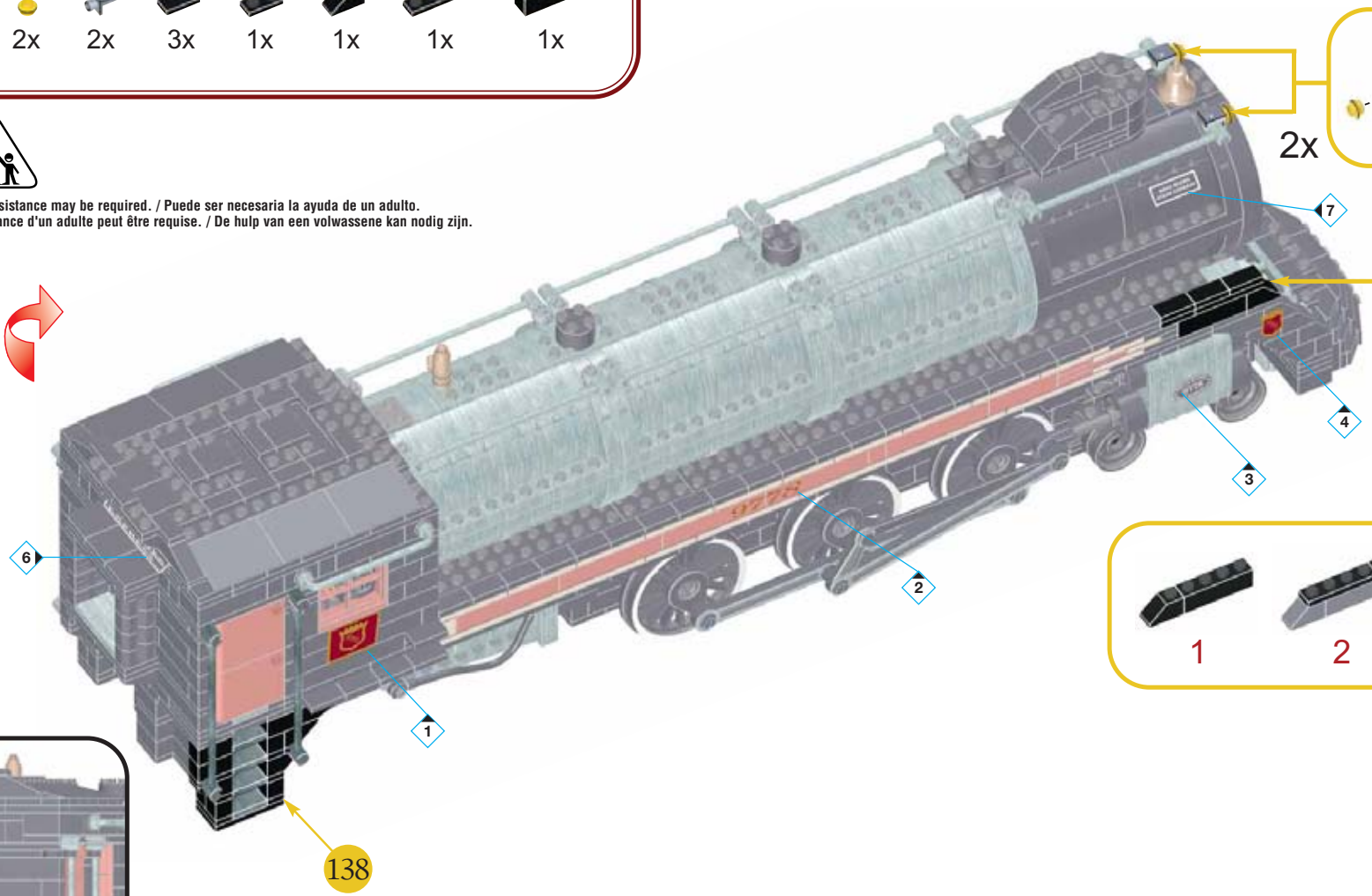

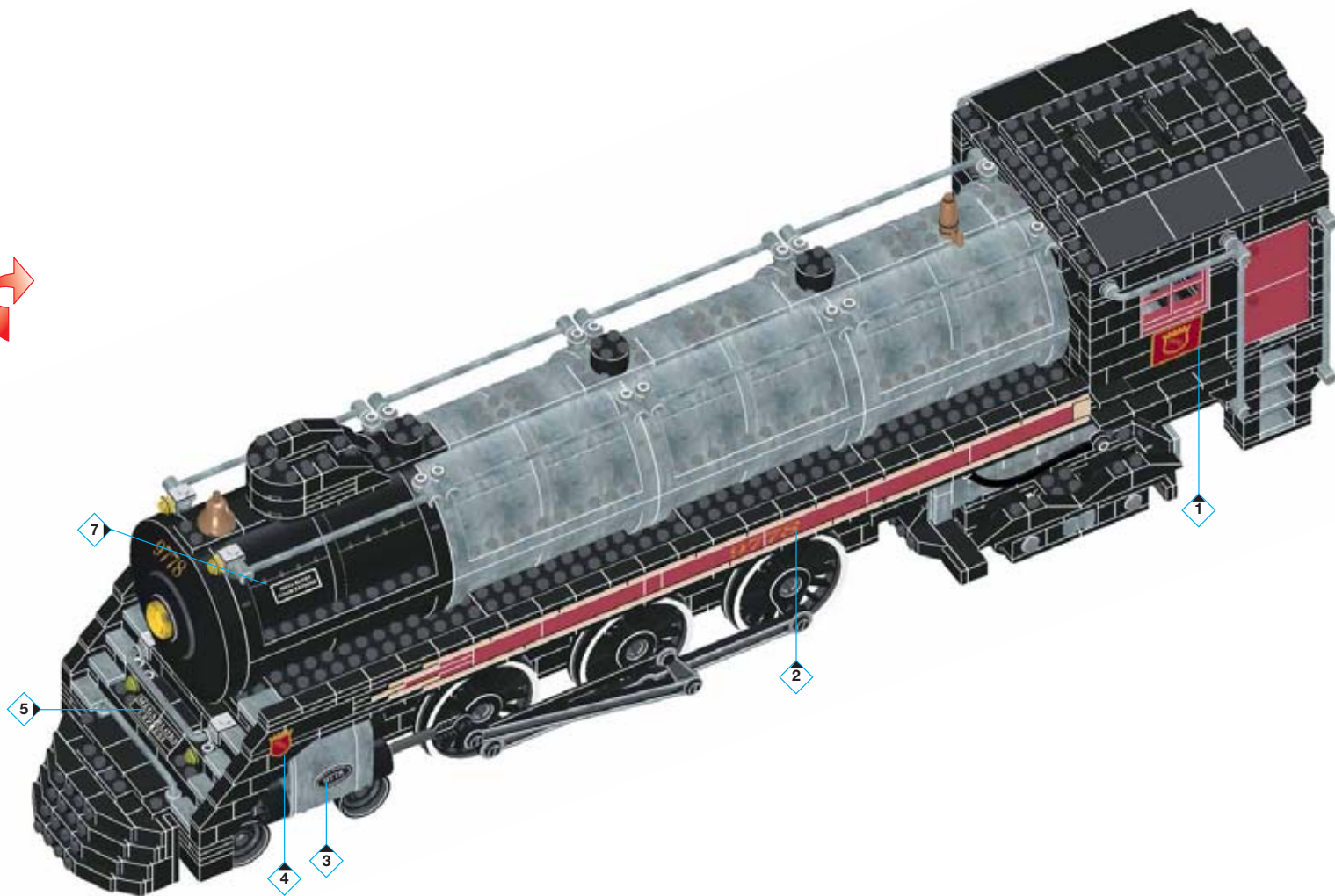



Real Moving 4-6-4 Wheels •
 Ruedas 4-6-4 que realmente giran •
 Roues 4-6-4 réellement mobiles •
 Echt bewegende 4-6-4 wielen •

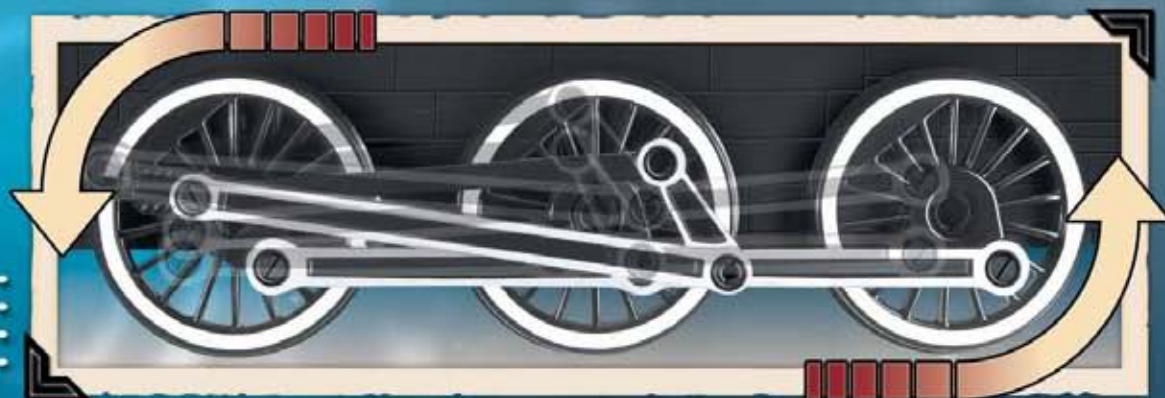



PROBUILDER

MASTER SERIES

9778

Steam Express



Also available
También disponible
Également disponible
Eveneens beschikbaar



USS Nimitz 9795



U.S.S. Enterprise NCC-1701-D 9777



Ford GT™ 9710



Air Force Warthog 9789

© & © Paramount Pictures. All Rights Reserved.

Ford Oval and Ford GT are registered trademarks owned and licensed by Ford Motor Company.

Also available
También disponible
Également disponible
Eveneens beschikbaar



Supersonic Fighter 9962



#8 Dale Earnhardt Jr. 9961



#24 Jeff Gordon 9960



© 2004, MEGA BLOKS INC.
© and ™ denote trademarks of MEGA BLOKS INC.
© y ™ designan la marca registrada y la marca comercial de MEGA BLOKS INC.
© et ™ désignent des marques de commerce de MEGA BLOKS INC.
© en ™ duiden op handelsmerken van MEGA BLOKS INC.

Printed in Canada D097781

NASCAR is a registered trademark of the National Association for Stock Car Auto Racing, Inc.
Jeff Gordon® © 2004 License for driver, helmet, car and uniform granted by JG Motorsports, Inc. Made under license from JG Motorsports, Inc.
The name, signature and likeness of Dale Earnhardt, Jr., as well as the Dale Jr. name and signature, are licensed under the administration of Dale Earnhardt, Inc. Licensed by J. Motorsports, L.L.C. The stylized #8, likeness of the #8 race car and the Dale Earnhardt, Inc. crest or script logo are used under the administration of Dale Earnhardt, Inc.