

**MEGA
BLOKS**

Dragons

Krystal Wars

9891



8+ Ages/Edades
Åges/Leeftijden

215 Pieces/Piezas
Pièces/Stuks

Instruction Book
Manual de instrucciones
Livret d'instructions
Handleiding

1

Vorgan Stronghold

 **17x**
AM02929JG

 **18x**
AM03157JG

 **54x**
AM01982JG

 **1x**
AM03213NY

 **1x**
AM01891ZD

 **1x**
AM01889JG

 **3x**
AM01890ZD

 **3x**
AM01887KN

 **1x**
AS0989124

 **2x**
AM01901MY

 **1x**
AM03146MY

 **1x**
AS0989123

 **1x**
AM026762KN

 **1x**
AS09891231

 **1x**
AS098917

 **2x**
AM03209LP

 **2x**
AS0988507

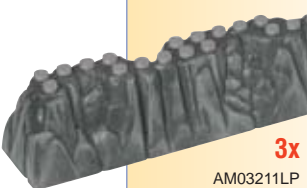
 **3x**
AM03211LP

 **2x**
AS0988506

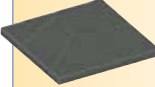
 **3x**
AM03198LP

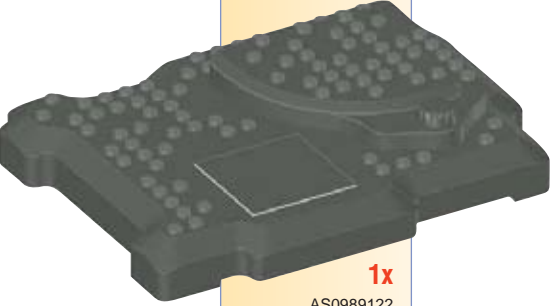
 **1x**
AS0989122

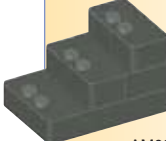
 **3x**
AM03210LP

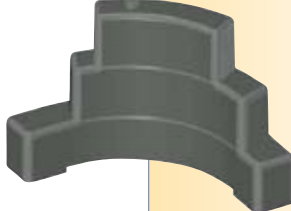
 **1x**
AM03212LP

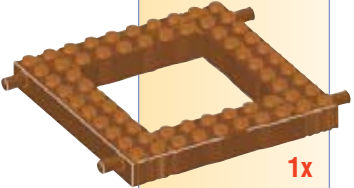
 **1x**
AM03218MY

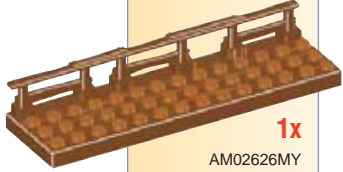
 **1x**
AM02626MY

 **1x**
AM03148KN

 **1x**
AM03147NQ

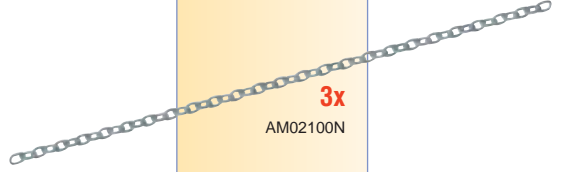
 **3x**
AM02100N

 **1x**
AM02641N

 **4x**
AM03236N

 **1x**
AS0989111

 **1x**
AS098733

 **1x**
AS0989121

 **9x**
AM03215MY

 **5x**
AM03216MY



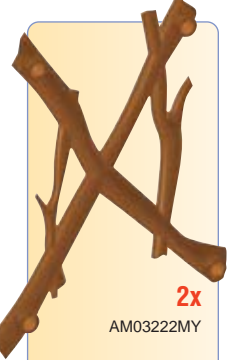

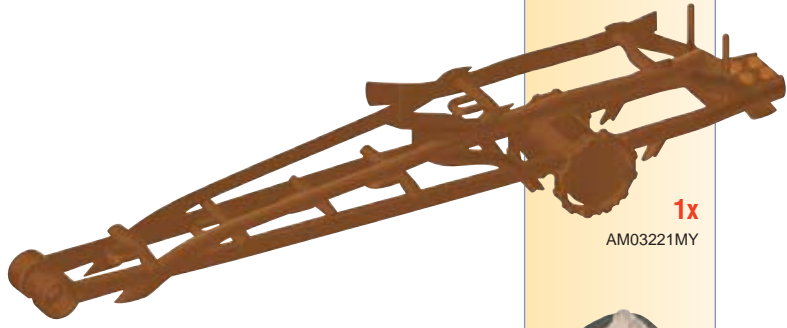

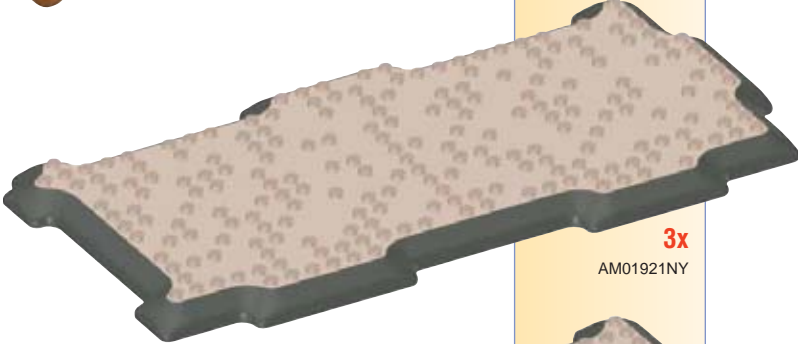

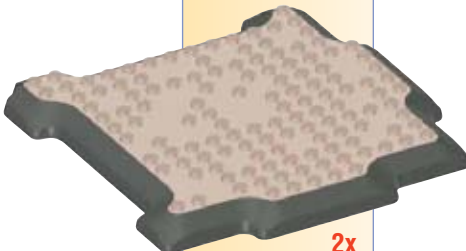
 **2x**
AM03220MY









 **2x**
AM03222MY

 **1x**
AM03221MY











 **3x**
AM01921NY











 **2x**
AM02897NY

	1x AS0989133
	1x AS0989134
	1x AS0989133
	1x AS0989131
	1x AS0989132
	1x AM03158F
	1x AM03163F
	1x AM03162F

	1x AS0989143
	1x AS0989144
	1x AS0989145
	1x AS0989141
	1x AS0989142
	1x AM03199KV
	1x AS03163KV
	1x AM03162KV

	1x AS09891510
	1x AS0989159
	1x AS0989155
	1x AS0989156
	1x AS0989158
	1x AS0989157
	1x AS0989154
	1x AS0989153
	1x AS0919152
	1x AS0919151

	1x AM01940F
	1x AM01941F
	1x AM01942F
	1x AM01943F
	1x AM01944F
	1x AM03137KX
	1x AM03138KX
	1x AM03139KX
	1x AM03140KX
	1x AM03141KX

	1x AS09891511
	1x AM02661KJ
	1x AM02662KJ
	1x AM02663KJ
	1x AM02664KJ
	1x AM02665KJ
	1x AM02666KJ
	1x AM02667KJ
	2x AM01946F
	6x AM03145KX
	2x AM02673DH

Vorgan Stronghold™

9891

Color chart.

Cuadro cromático

Charte de couleurs.

Färgtabell.

Kleurenkaart.

Quadro cromático.

カラーチャート
色彩表



Active step / Étape active / Etapa activa / Azione attiva
Aktivt skede / Actieve stap / アクティブなステップ / 積極步驟

Previous step / Étape précédente / Etapa precedente
Azione precedente / Föregående skedet / Vorige stap
前のステップ / 上一步驟

Active step / Étape active / Etapa activa / Azione attiva
Aktivt skede / Actieve stap / アクティブなステップ / 積極步驟

Previous step / Étape précédente / Etapa precedente
Azione precedente / Föregående skedet / Vorige stap
前のステップ / 上一步驟

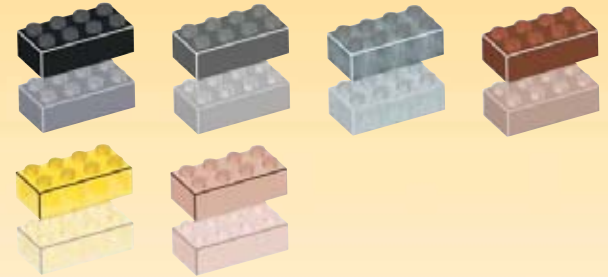

Please read these instructions carefully before first use and keep them for future reference.
Leer estas instrucciones cuidadosamente antes de la primera utilización y guardarlas para referencia futura.
Il est recommandé de lire attentivement ce feuillet avant la première utilisation et de le conserver pour référence future.
Wij raden u aan deze handleiding zorgvuldig te lezen en te bewaren voor eventuele raadpleging op een later tijdstip.

EN ⚠ **WARNING :**
CHOKING HAZARD. - Small parts.
Not for children under 3 years.

ES ⚠ **ADVERTENCIA :**
PELIGRO DE ASFIXIA. - Contiene piezas pequeñas.
No recomendado para niños menores de 3 años.

FR ⚠ **AVERTISSEMENT :**
RISQUE DE SUFFOCATION. - Présence de petits éléments.
Ne convient pas aux enfants de moins de 3 ans.

NL ⚠ **WAARSCHUWING:**
VERSTIKKINGSGEVAAR. - Bevat kleine onderdelen.
Niet geschikt voor kinderen onder de 3 jaar.

DE ⚠ **WARNUNG:**
ERSTICKUNGSGEFAHR. - Enthält kleine Teile.
Nicht für Kinder unter 3 Jahren geeignet.

DA ⚠ **ADVARSEL:**
KVÆLNINGSFARE. - Indeholder smådele.
Ikke til børn under 3 år.

EL ⚠ **ΠΡΟΕΙΔΟΠΟΙΗΣΗ:**
ΚΙΝΔΥΝΟΣ ΠΝΙΞΙΜΑΤΟΣ. - Περιέχει μικρά αντικείμενα
Όχι για παιδιά κάτω των 3 ετών.

FI ⚠ **VAROITUS:**
TUKEHTUMISVAARA. - Sisältää pieniä osia.
Ei alle 3-vuotiaille lapsille.

IT ⚠ **ATTENZIONE:**
PERICOLO DI SOFFOCAMENTO. - Contiene piccole parti.
Non indicato per bambini sotto i 3 anni.

NO ⚠ **ADVARSEL:**
KVELNINGSFARE. - Inneholder små deler.
Kun for barn over 3 år.

PT ⚠ **ATENÇÃO:**
PERIGO DE ASFIXIA. - Contém peças pequenas.
Não é concebido para crianças de menos de 3 anos.

SV ⚠ **VARNING!**
KVÄVNINGSRISK. - Innehåller små delar.
Inte för barn under 3 år.

JA ⚠ **警告:**
窒息の危険性 小さな部品が含まれています
3歳以下の子供には与えないで下さい。

ZH ⚠ **警告:**
有窒息危險。包含有小部件
不适合3岁以下的小孩玩。



Build VORÇAN STRONÇHOJD™ in sections • Construya el VORÇAN STRONÇHOJD™ en secciones
 Construis le VORÇAN STRONÇHOJD™ par sections • Bozw VORÇAN STRONÇHOJD™ in Deien!

00	00	00	00
00	00	00	

Page • Page
 Pagina • Bladzijde

Dragons/Figures • Dragones/Figuras
 Dragons/Figures • Draken/Krijgerfiguren

7

Weapons • Armas
 Armes • Wapens

10

Section 1 • Sección 1
 Section 1 • Deel 1

11

Section 2 • Sección 2
 Section 2 • Deel 2

16

Section 3 • Sección 3
 Section 3 • Deel 3

22

Final Assembly • Ensamblado Final
 Assemblage Final • Eindmontage

Section 4 • Sección 4
 Section 4 • Deel 4

27

33

Figures • Figuras
Figurines • Kriegerfigurines

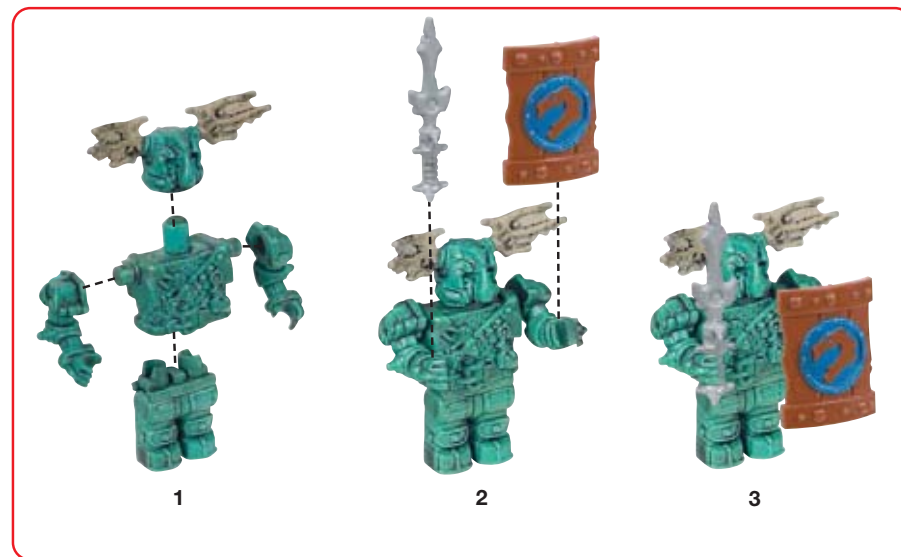
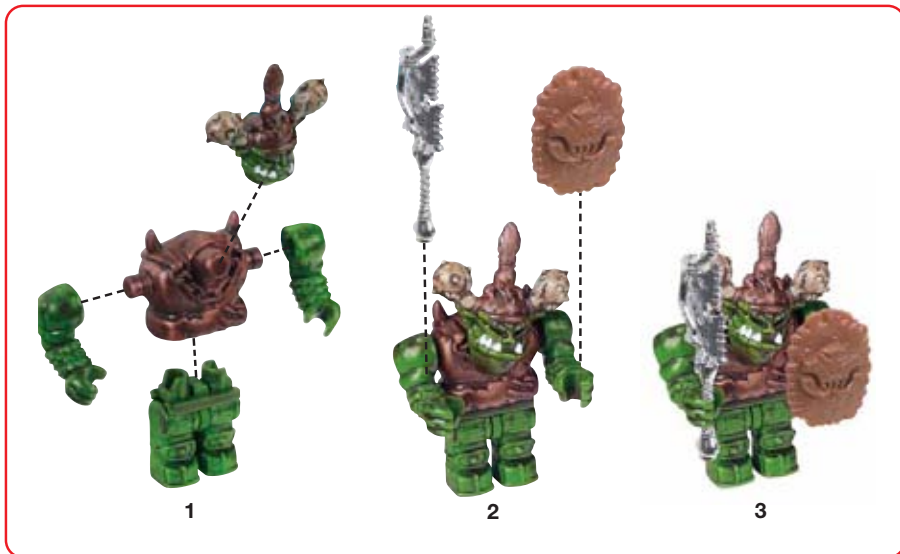



Push and twist
Empuje oscilando
Insérer en oscillant
Indrukken en draaien

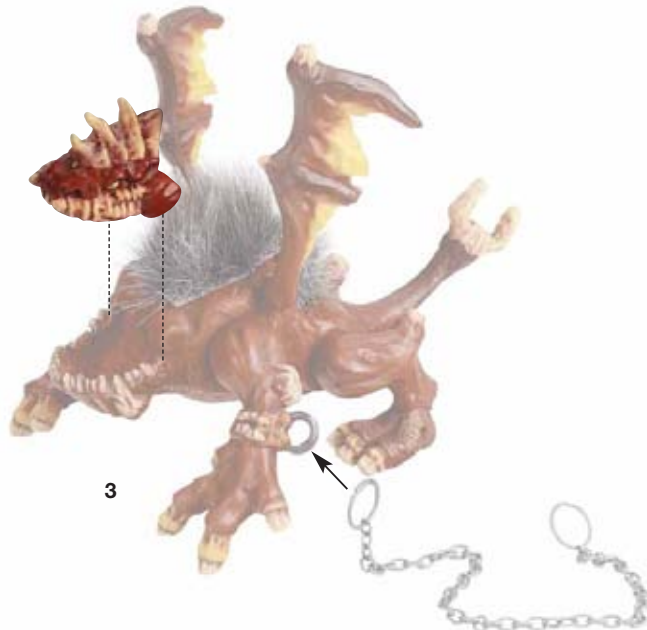
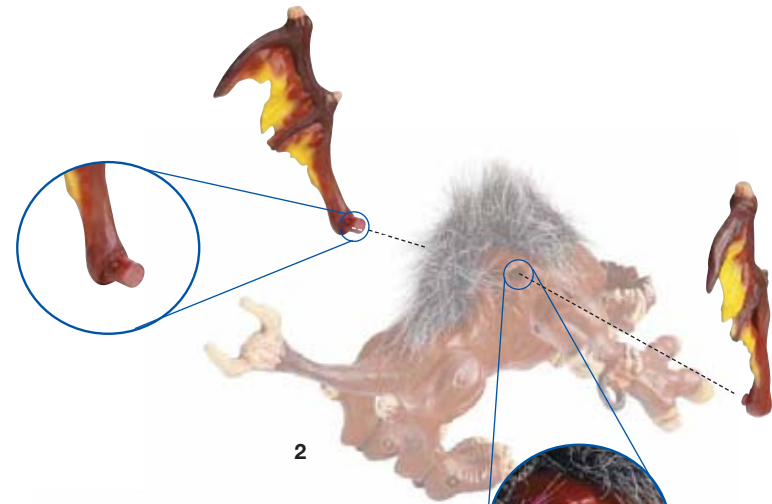
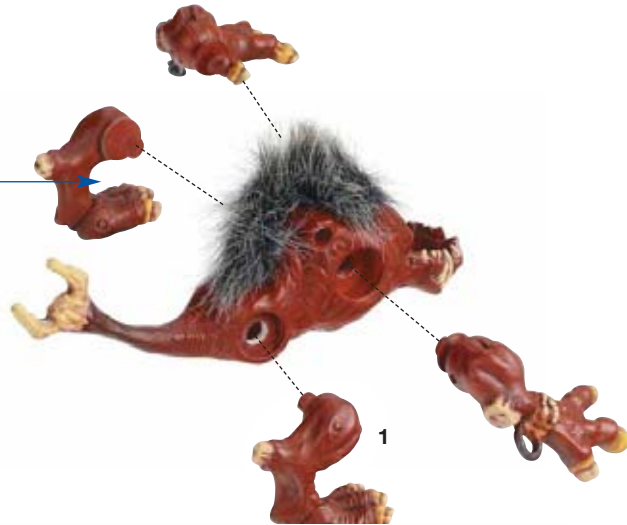

*Adult assistance may be required. / Puede ser necesaria la ayuda de un adulto. / L'assistance d'un adulte peut être requise. / De hulp van een volwassene kan nodig zijn.

Fully poseable / Jaws open to snare warriors • Se puede cambiar de posición / Las mandíbulas se abren para atrapar a los guerreros
Entièrement amovible / Les mâchoires s'ouvrent pour emprisonner les guerriers • Zeheel poseerbaar / Kaak opent om krijgers te vangen

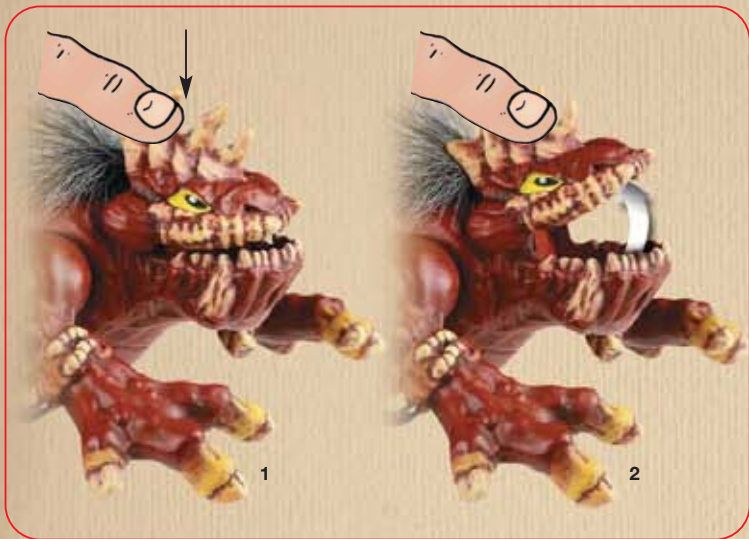

Working cannon / Collectible, light-zip Power Crystal • Cañon móvil / Cristal del poder láminoso a coleccionar
Canon fonctionnel / Cristal da poarvoir illamine a collectionner • Kanon werkt echt / Oplichtende Krachtkristal om te verzamelen

1

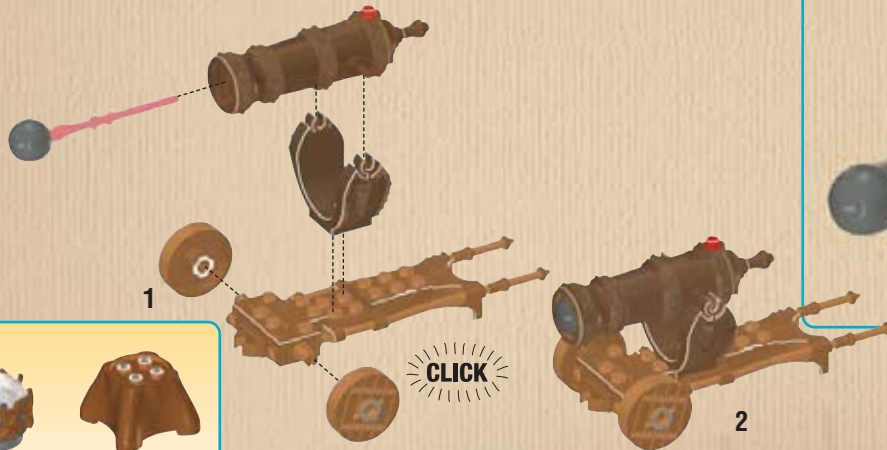
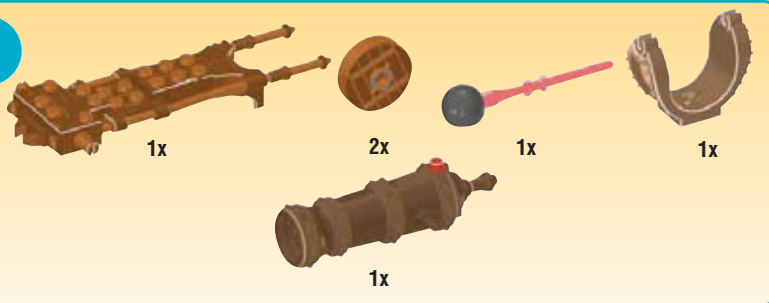

2

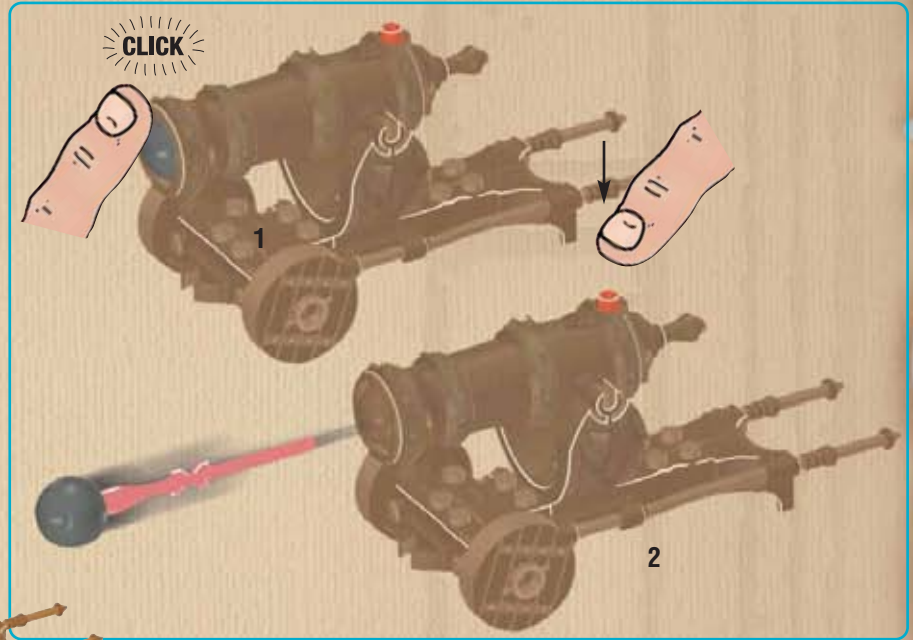

Use only the projectiles included with this toy./Utilizar solamente los proyectiles incluidos con el juguete./Utiliser seulement les projectiles fournis avec le jouet./Alleen de met het speelgoed bijgeleverde projectielen gebruiken.

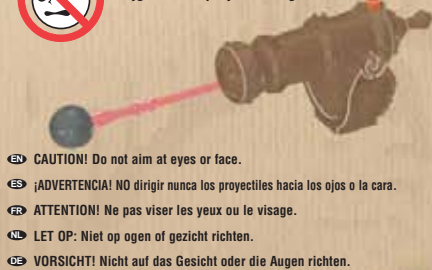

- Ⓔ CAUTION! Do not aim at eyes or face.
- Ⓔ ¡ADVERTENCIA! NO dirigir nunca los proyectiles hacia los ojos o la cara.
- Ⓔ ATTENTION! Ne pas viser les yeux ou le visage.
- Ⓔ LET OP: Niet op ogen of gezicht richten.
- Ⓔ VORSICHT! Nicht auf das Gesicht oder die Augen richten.
- Ⓔ ADVARSEL! Peg ikke i retning af øjne eller ansigt.
- Ⓔ ΠΡΟΣΟΧΗ! Να μην σκοπεύετε προς τα μάτια ή το πρόσωπο.
- Ⓔ VARO! Älä tähtää silmiin tai kasvoihin.
- Ⓔ Attenzione! Non puntare verso gli occhi o il viso.
- Ⓔ FORSIKTIG! Sikkt ikke mot øyne eller ansikt.
- Ⓔ ATENÇÃO: Não apontar para os olhos ou o rosto.
- Ⓔ VAR FÖRSIKTIG! Rikta inte med ögon eller ansikte.
- Ⓔ 警告! 不要对准眼睛或脸。
- Ⓔ 注意! 目や顔に使用しないで下さい。



Sección 1 • Sección 1
Sección 1 • Deel 1

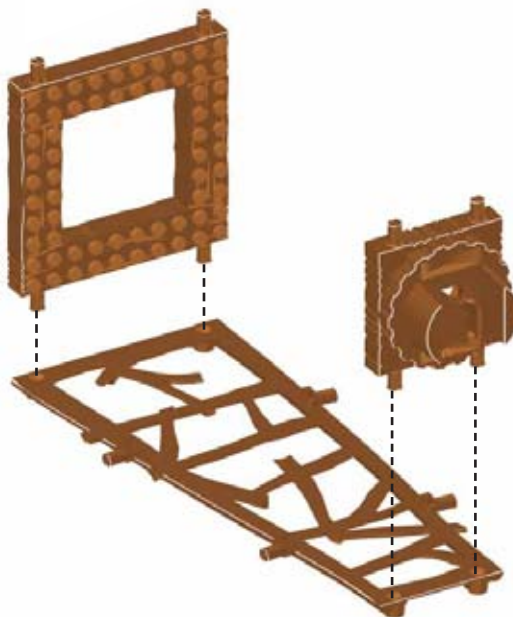
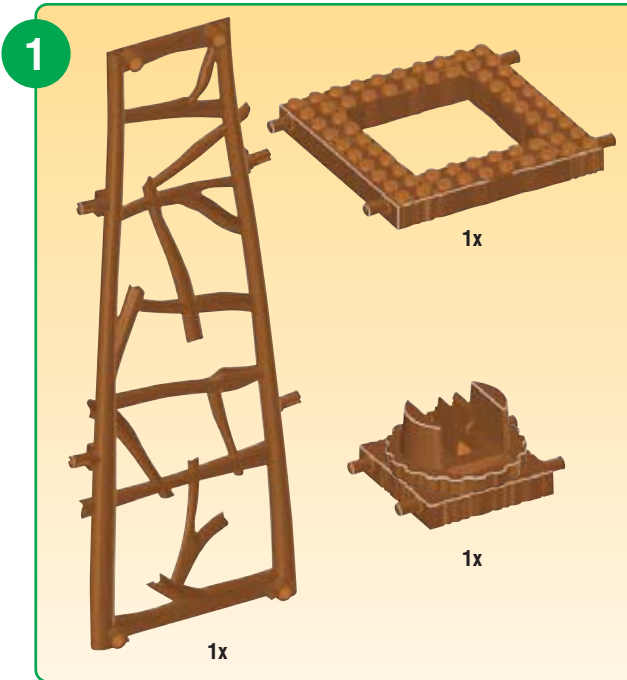

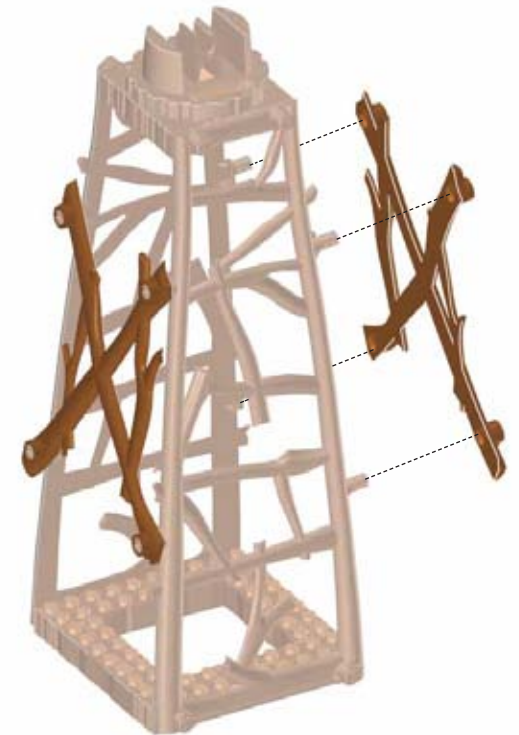

4

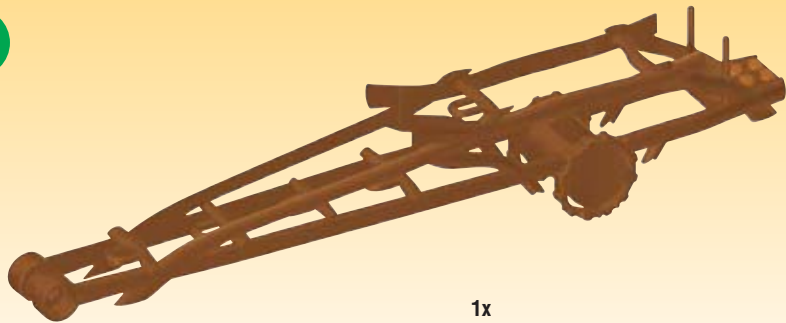

click



5

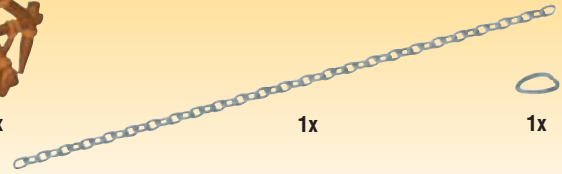

6

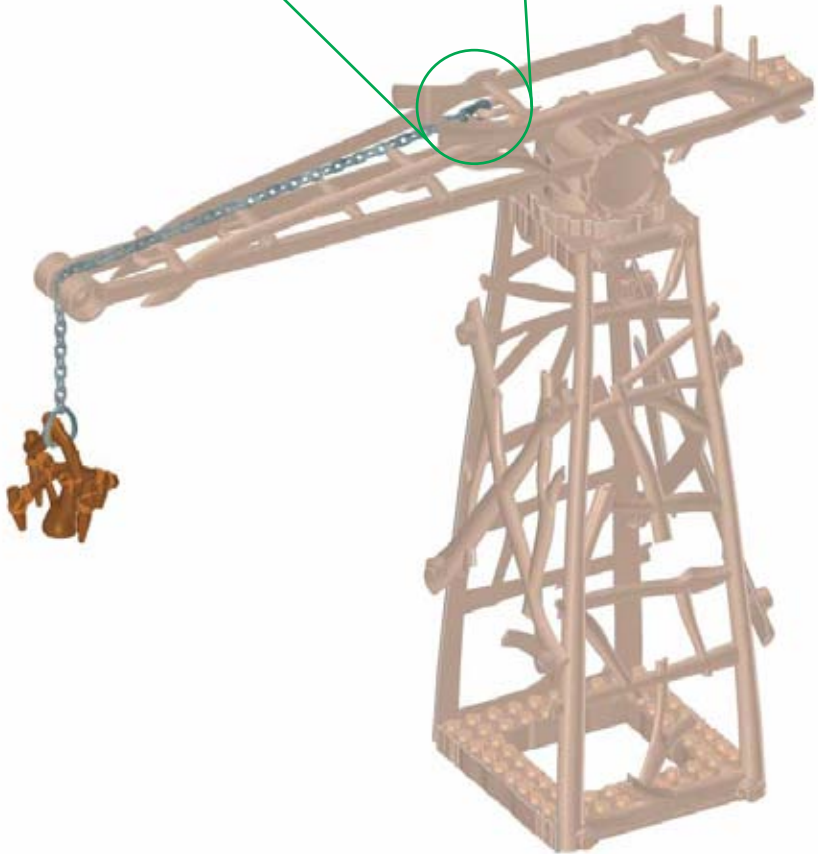

7

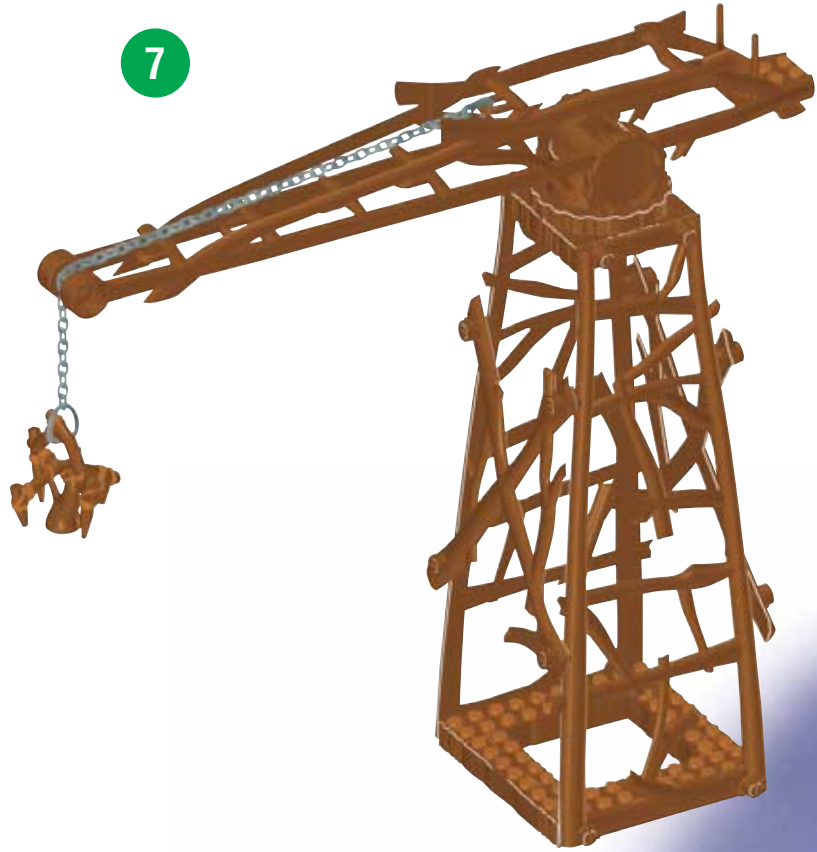

Cage tower rotates, raises and lowers/Magnetic claw picks up warriors! • La torre de la jaula gira, se levanta y se baja./Garra magnética levanta a los guerreros! • La structure de la cage pivote, se soulève et s'abaisse./Pince magnétique qui attrape des guerriers! • Kooiforen draait en beweegt op en neer/Magnetische klauw pakt krijgers op!



Sección 2 • Sección 2
Sección 2 • Deel 2

1  9x

1  1

2  2

3  3

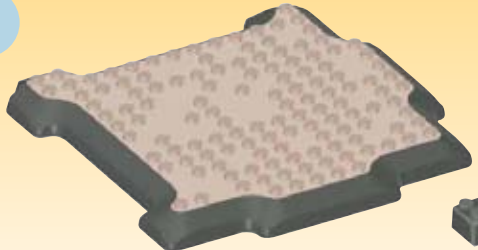
2  1x

 3x

 2x

 1x

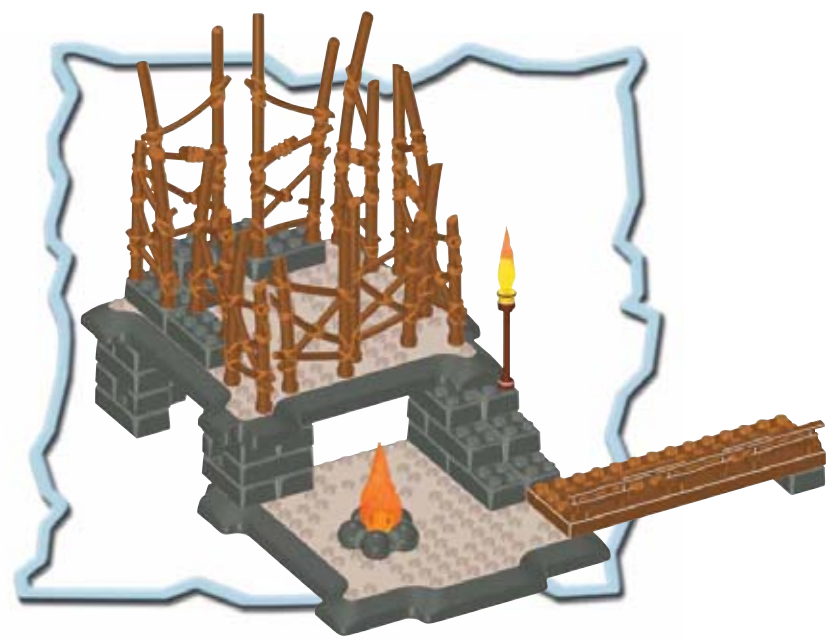



1  1

2  2

3  3



4  4

1  1

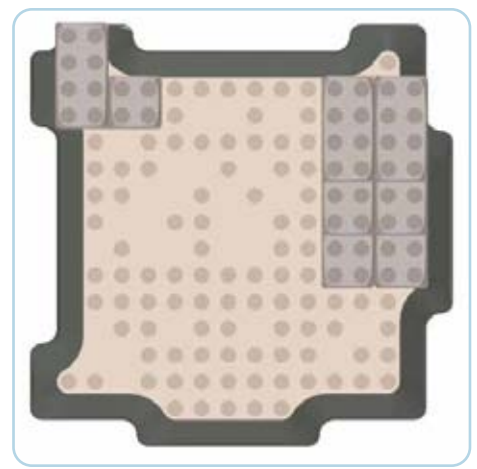

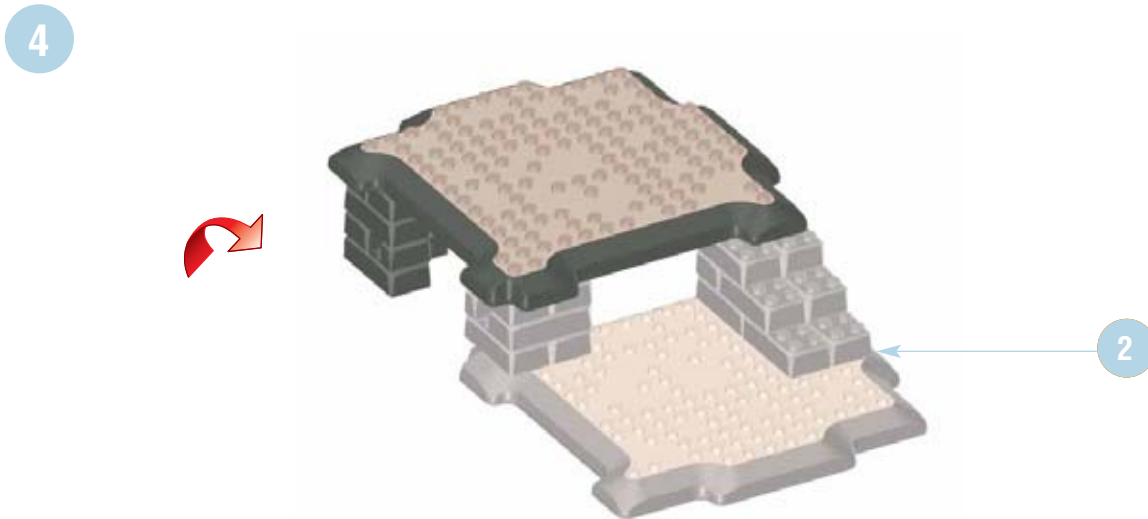
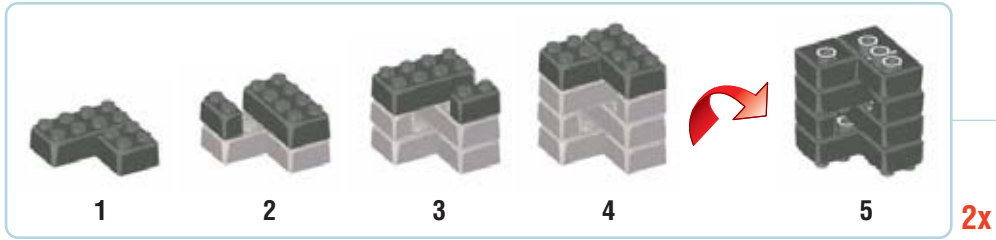
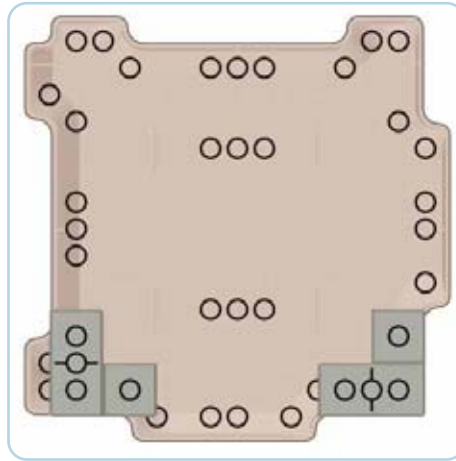
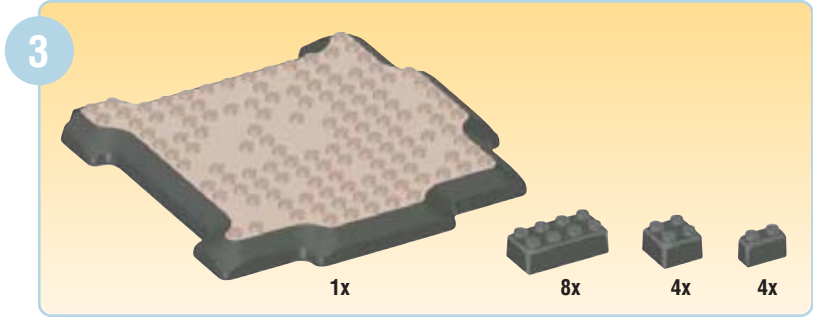

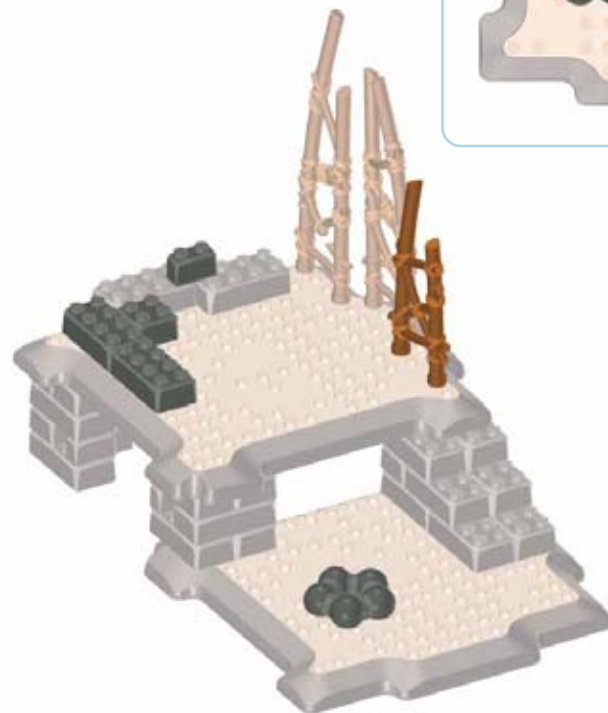
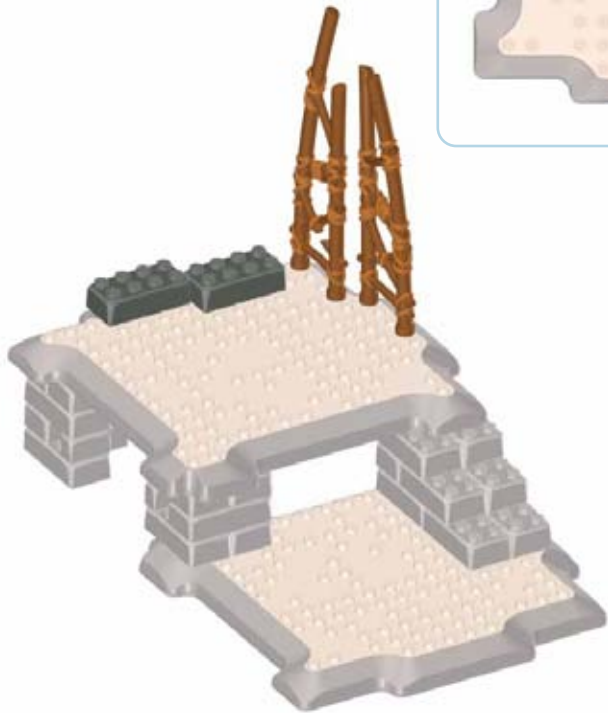
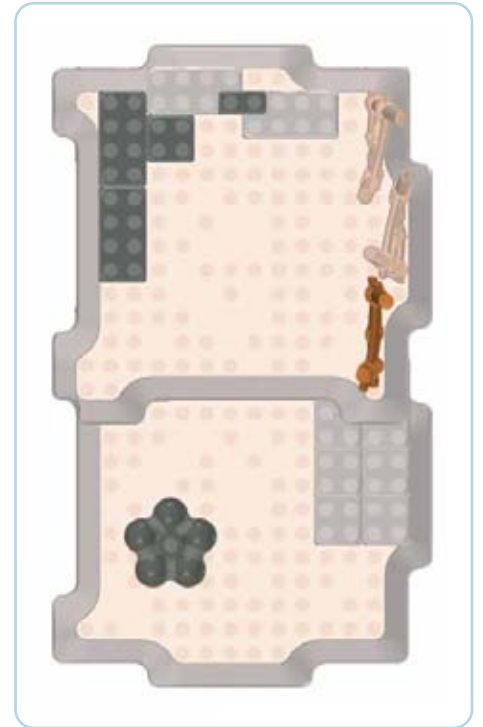
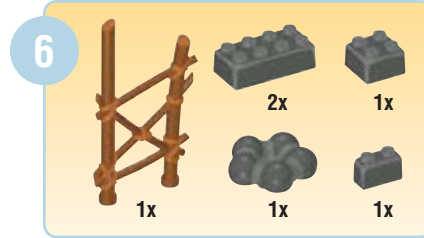
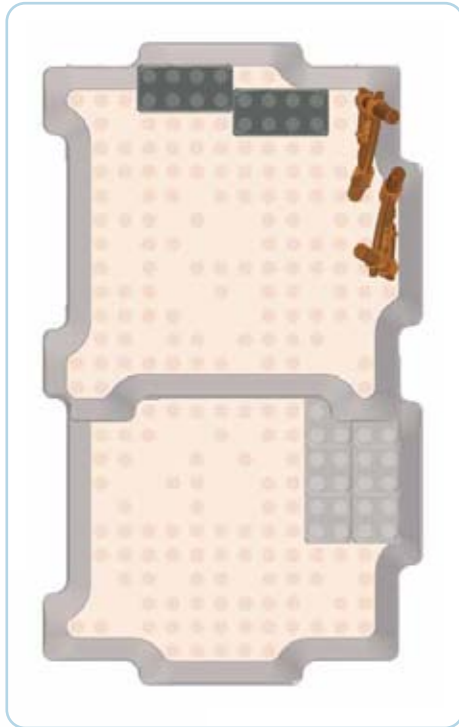

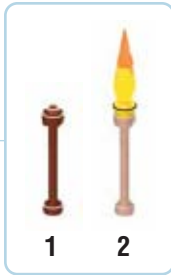
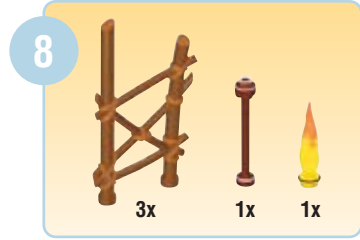
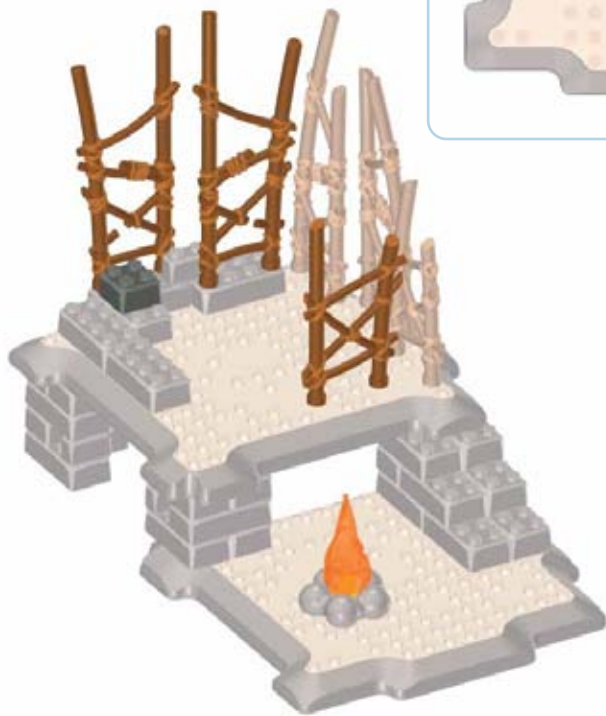
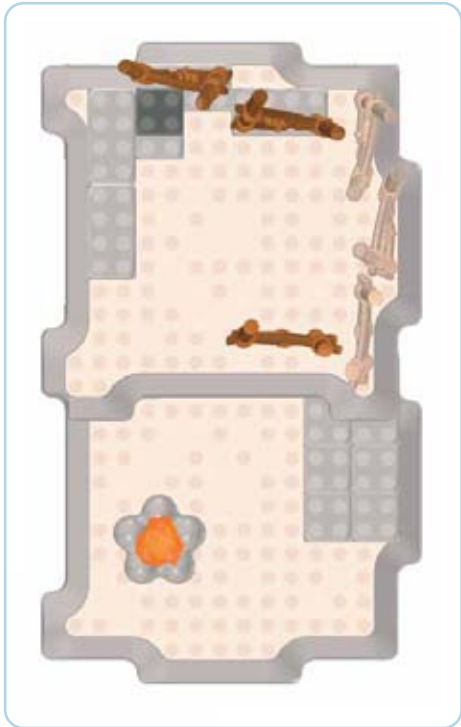

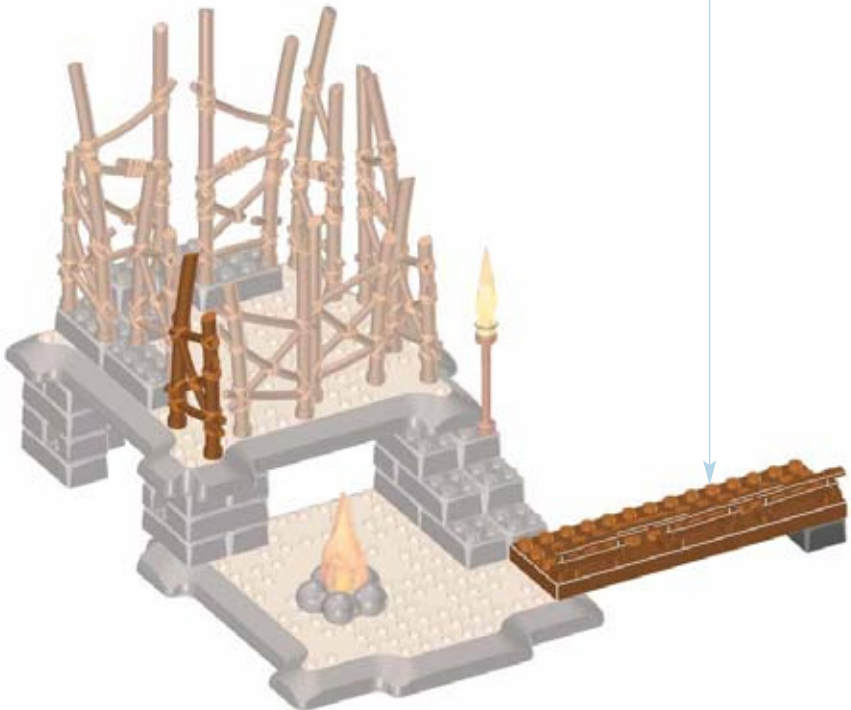
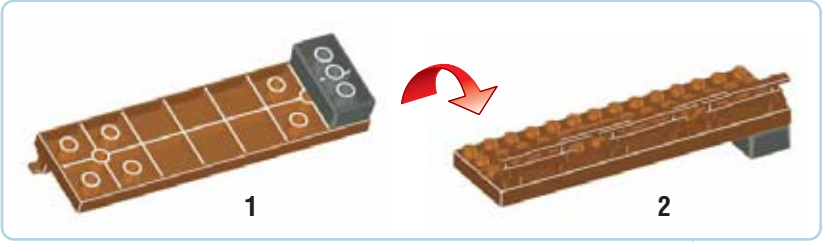
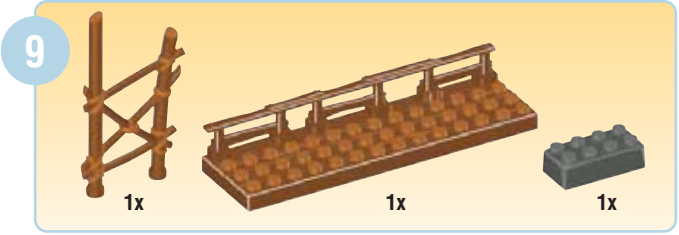

10

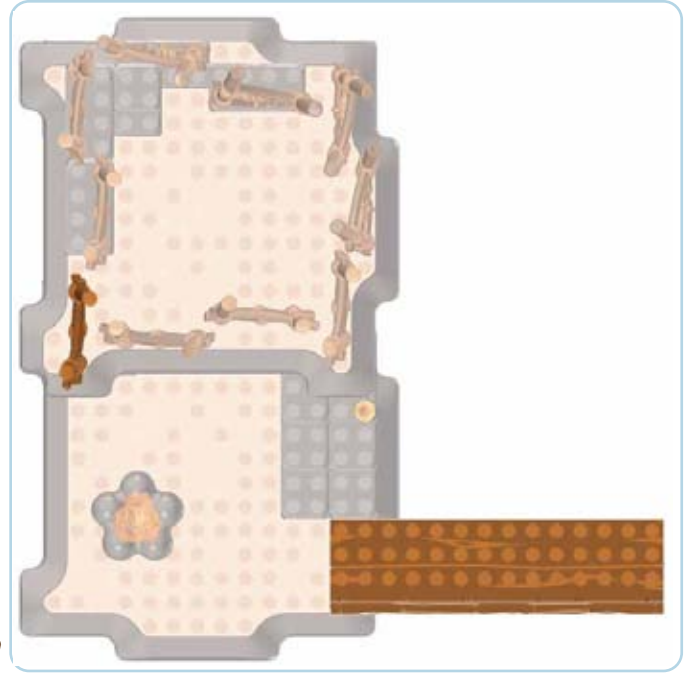

© 2003, MEGA BLOKS INC.
 ® and ™ denote trademarks of MEGA BLOKS INC.
 ® y ™ designan la marca registrada y la marca comercial de MEGA BLOKS INC.
 ® et ™ désignent des marques de commerce de MEGA BLOKS INC.
 ® en ™ duiden op handelsmerken van MEGA BLOKS INC.

**MEGA
BLOKS**

Dragons

Krystal Wars

9891



8+ Ages/Edades
Åges/Leeftijden

215 Pièces/Piezas
Pièces/Stuks

Instruction Book
Manual de instrucciones
Livret d'instructions
Handleiding

2

Vorgan Stronghold

Sección 3 • Sección 3
Sección 3 • Deel 3

1

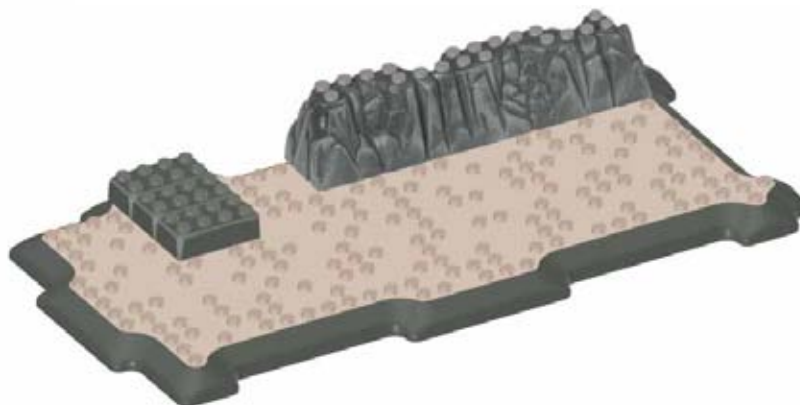
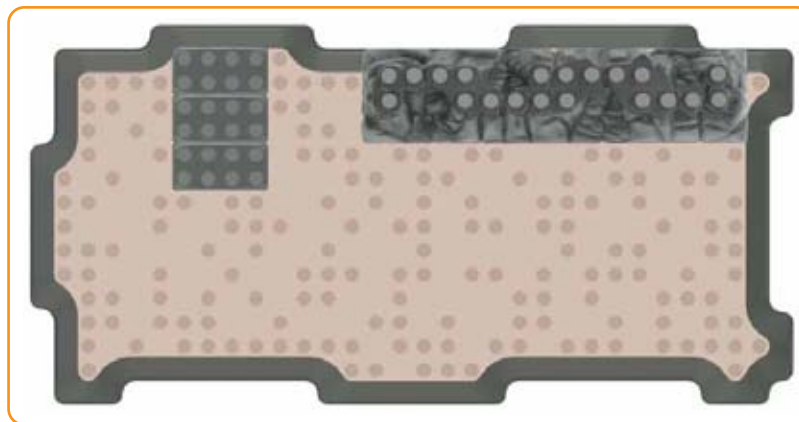
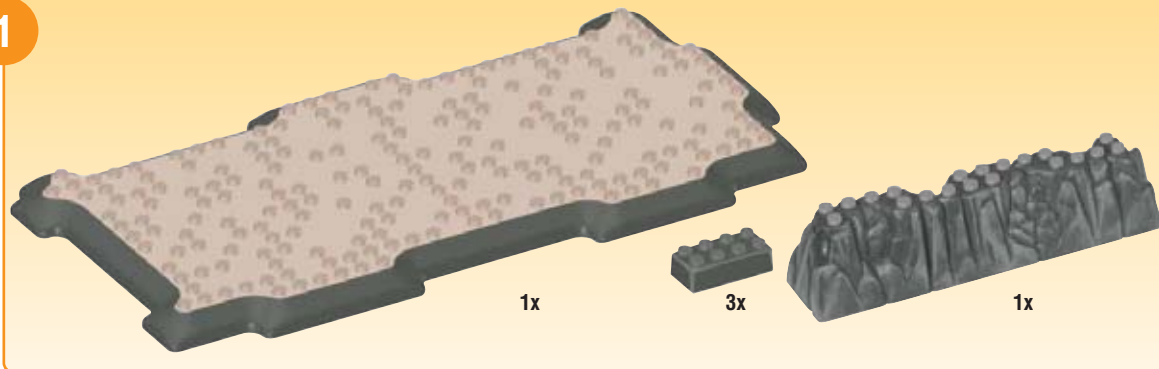
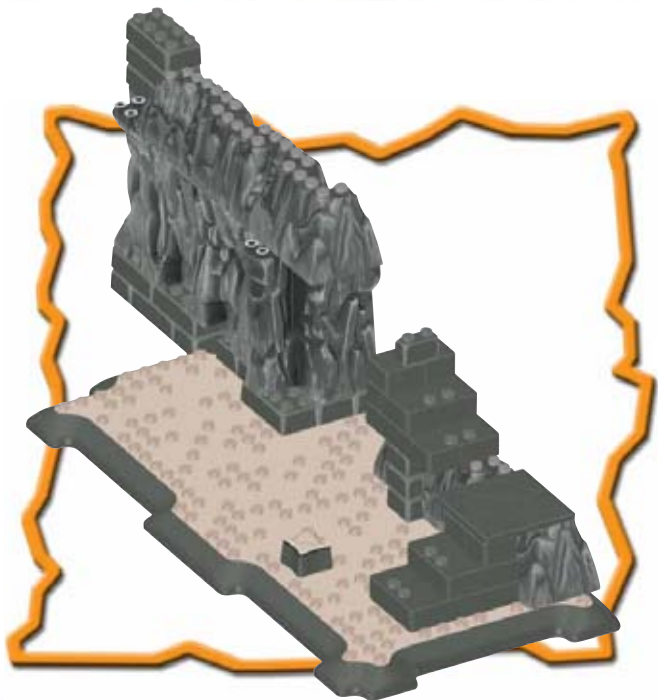

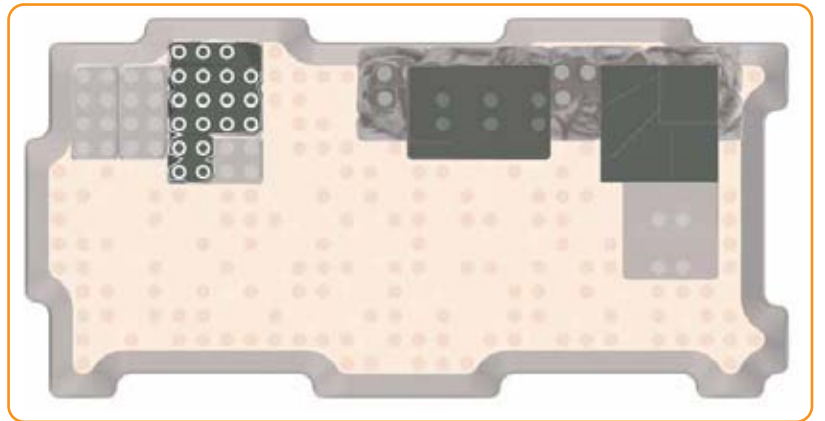
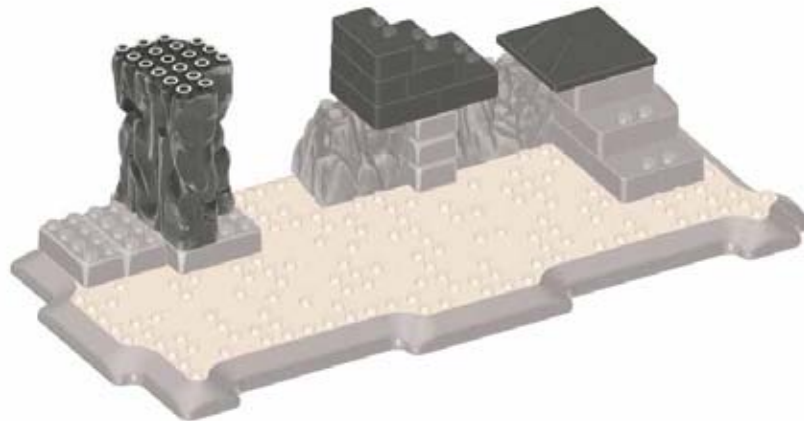
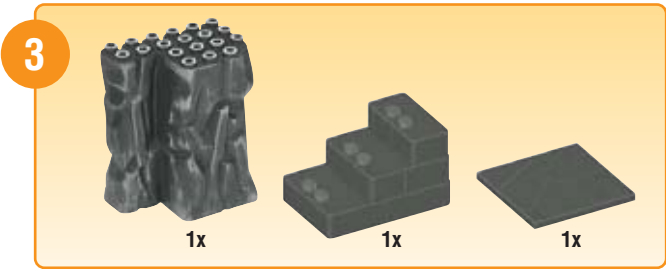
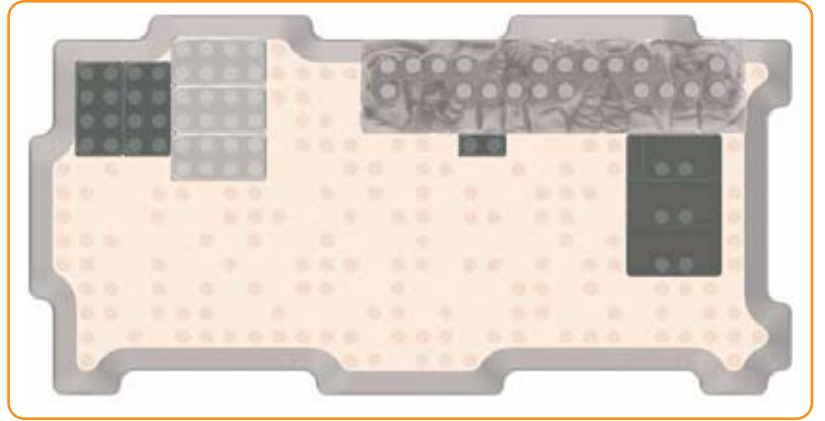
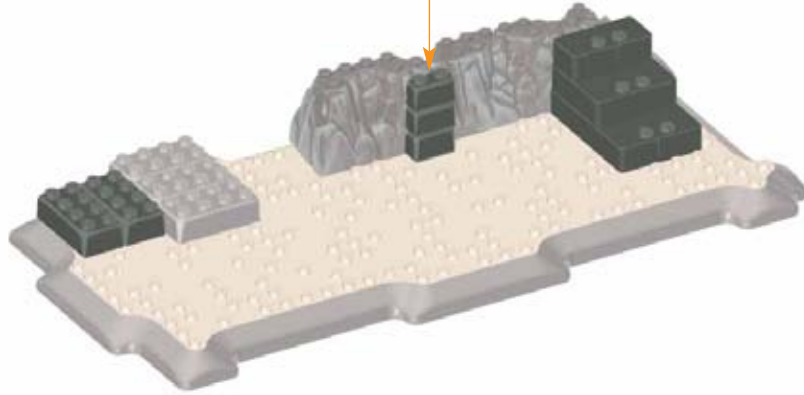
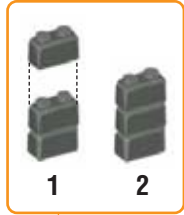
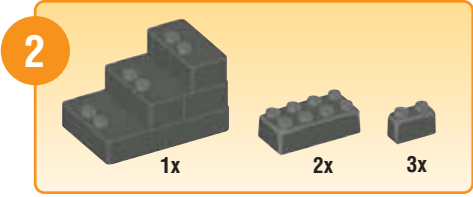

4

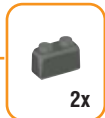
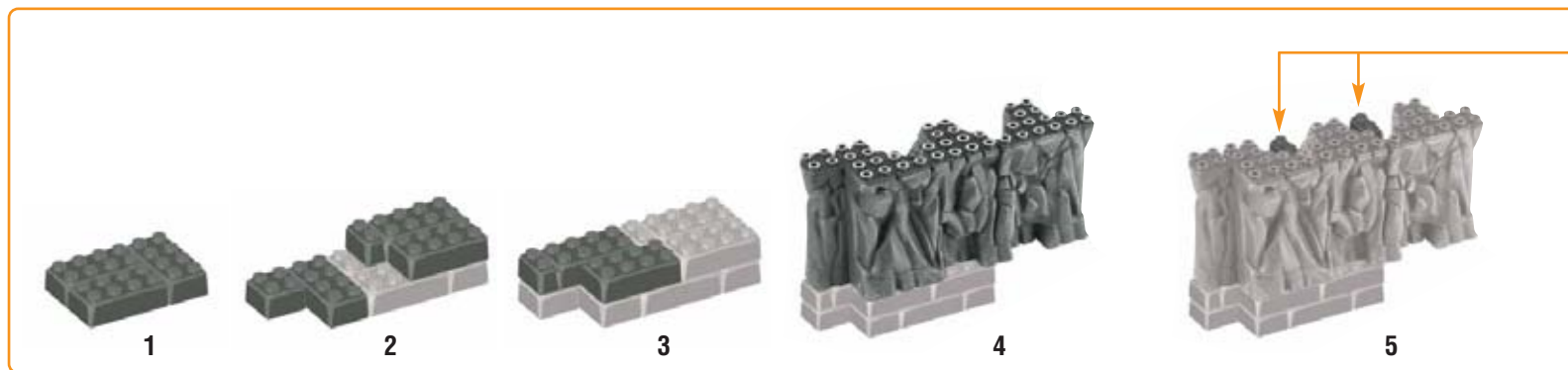
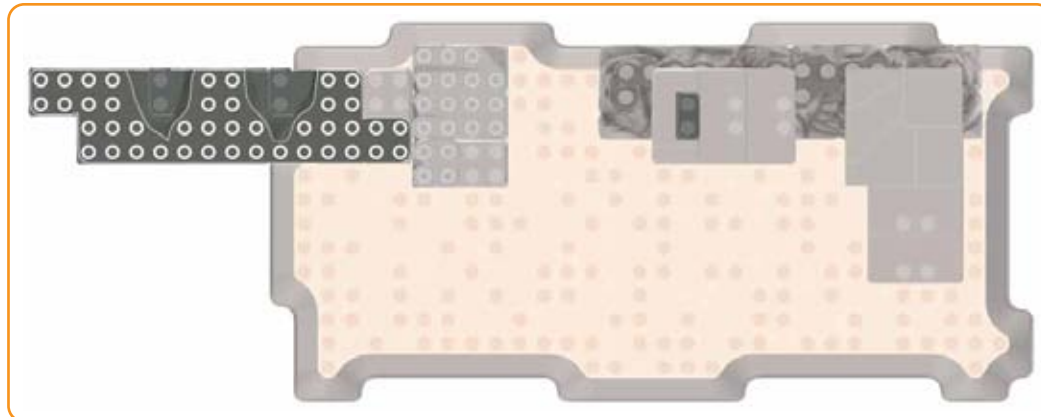
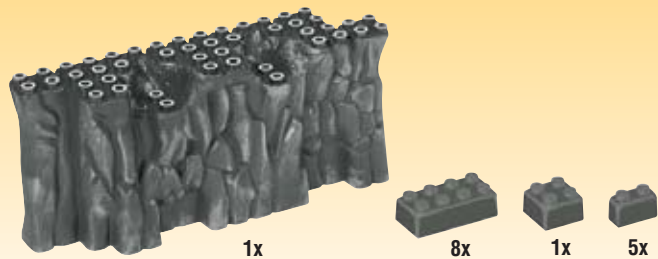

5

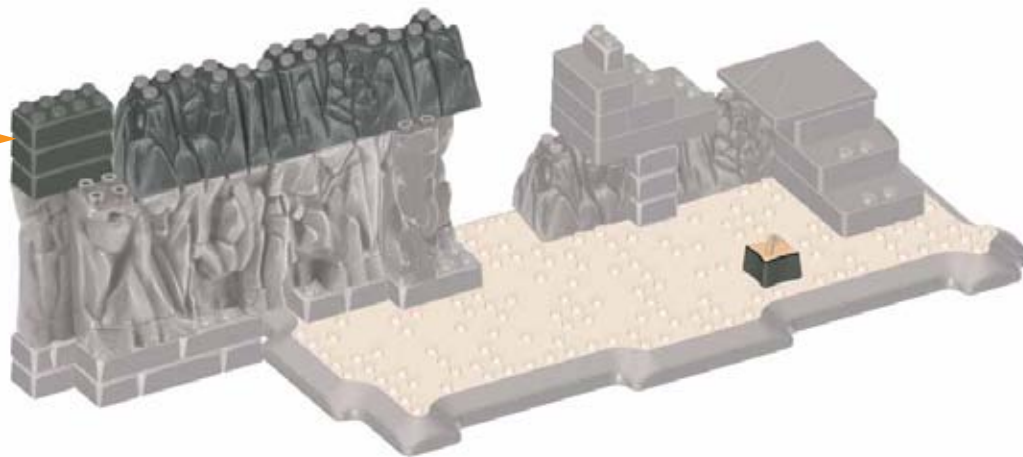
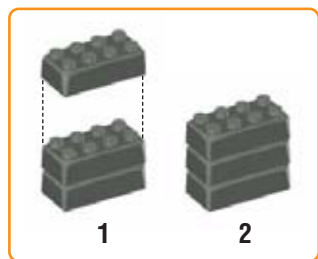
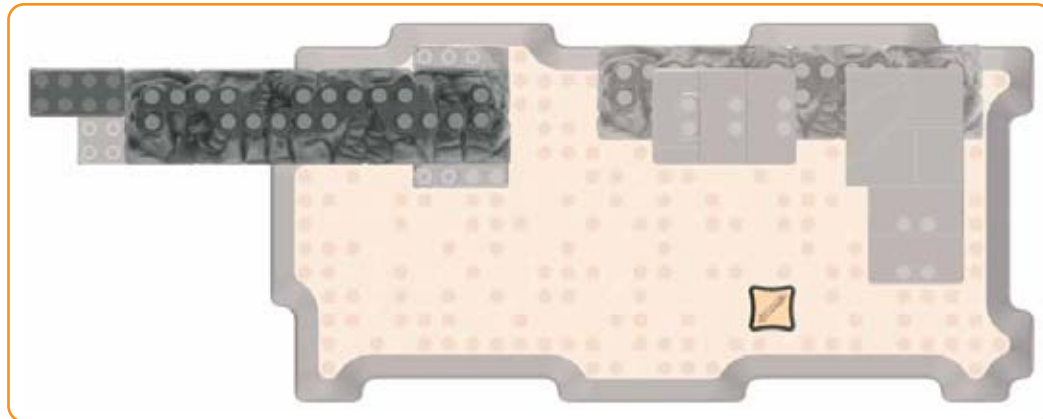

6

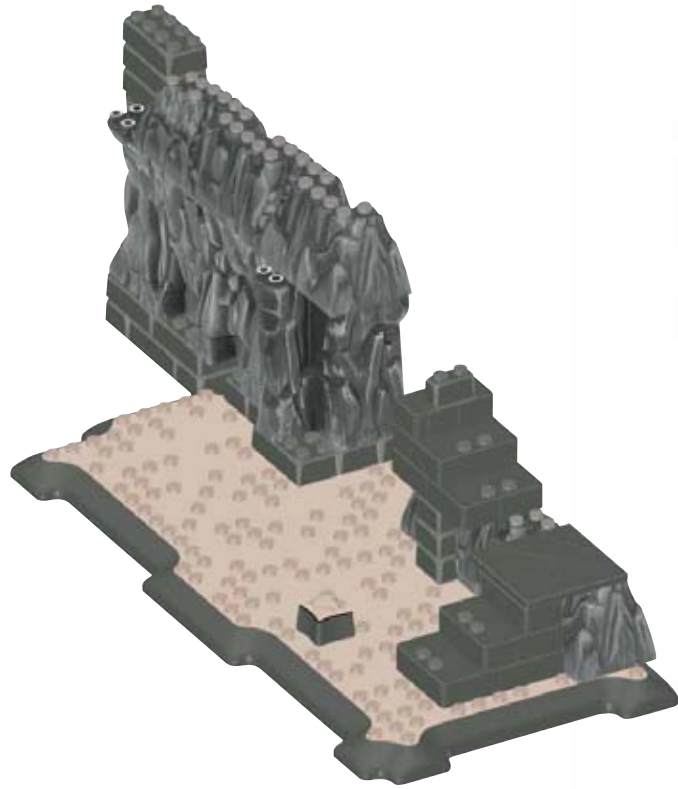

Section 4 • Sección 4
Section 4 • Deel 4

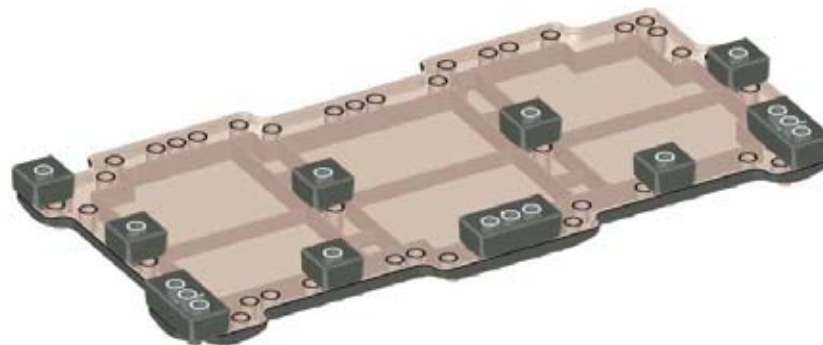
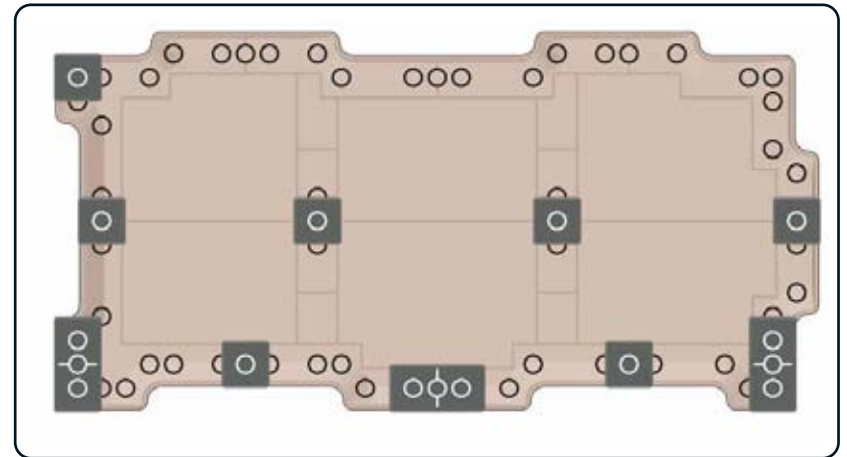
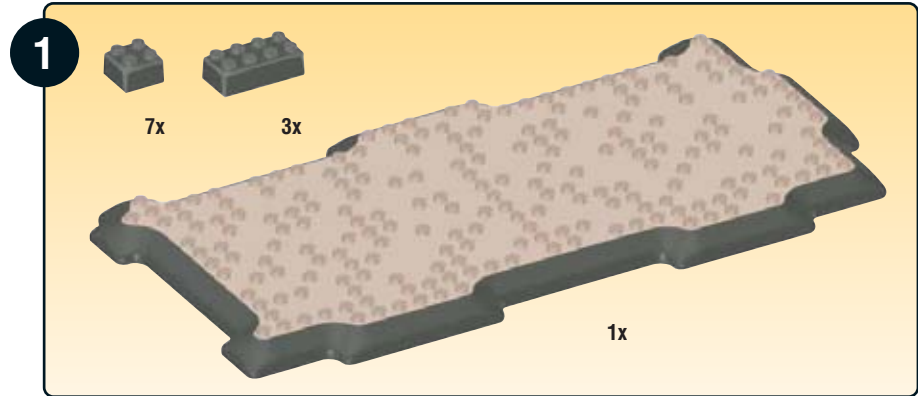
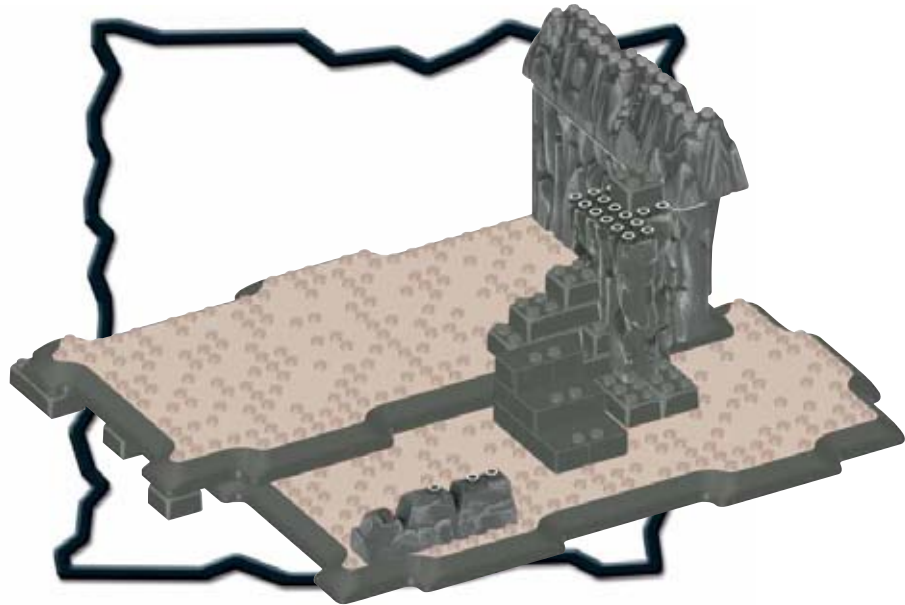

2

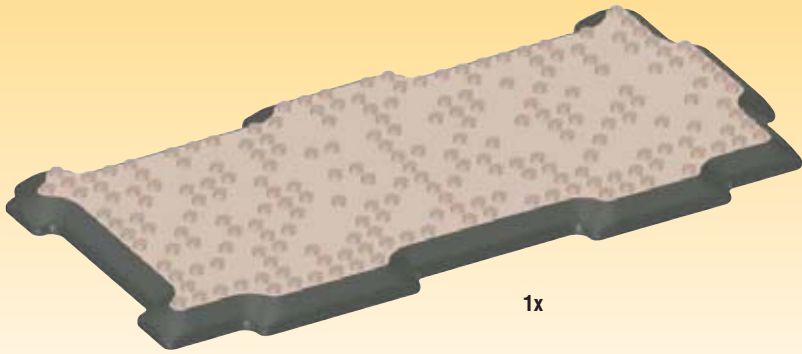

1x

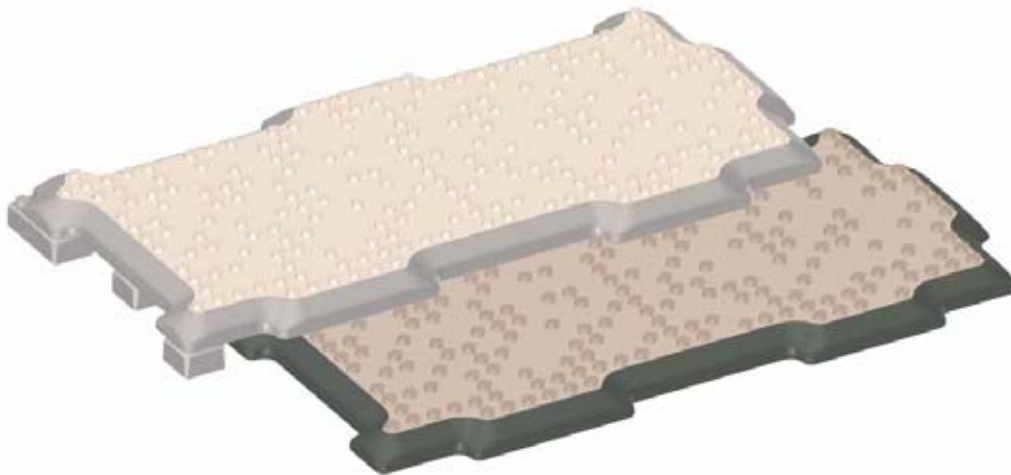
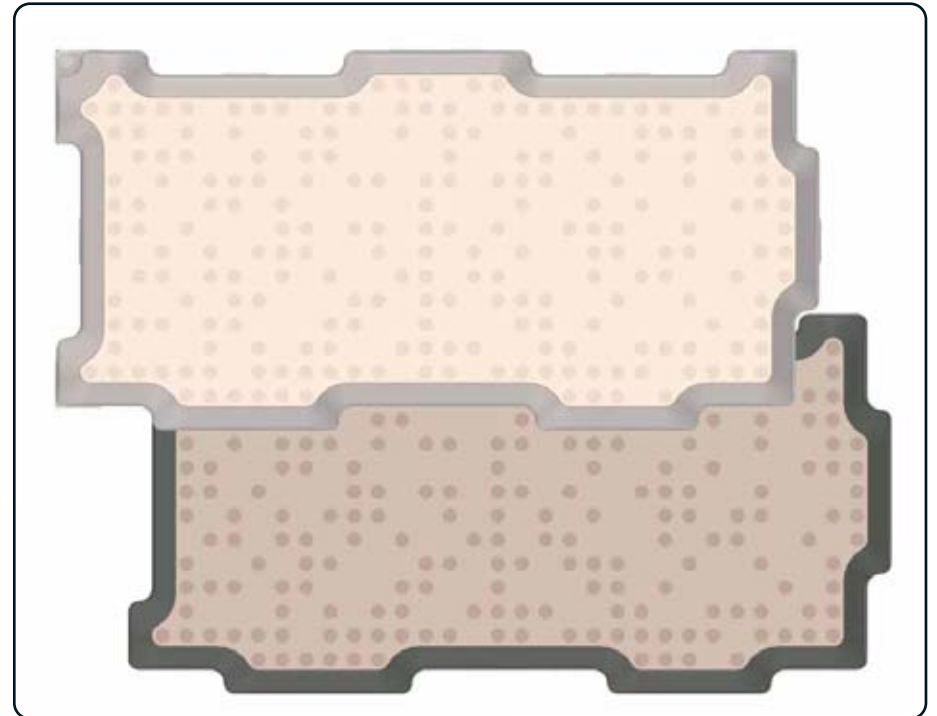

3



2x



1x

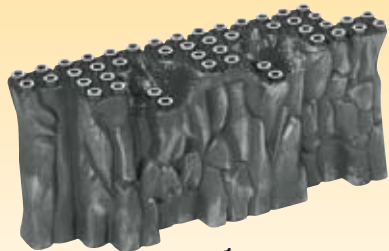

1x

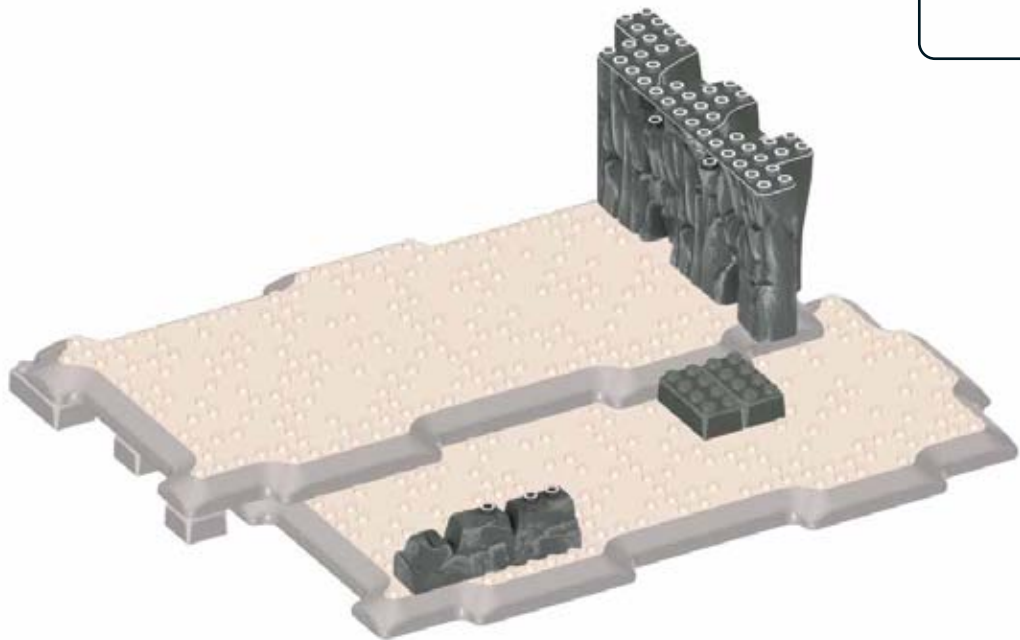
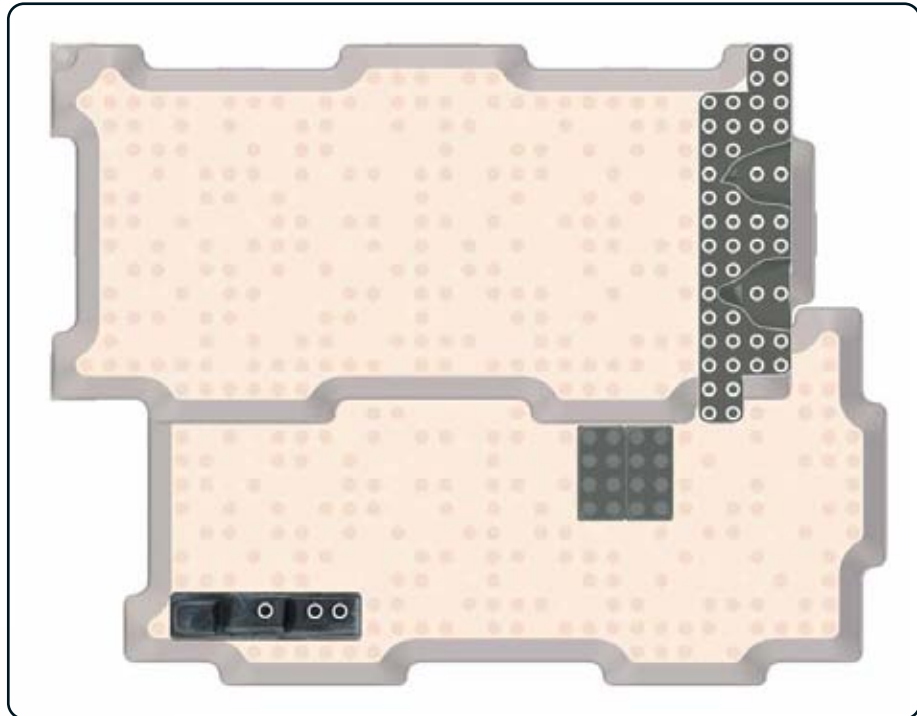

4



1x



2x



2x

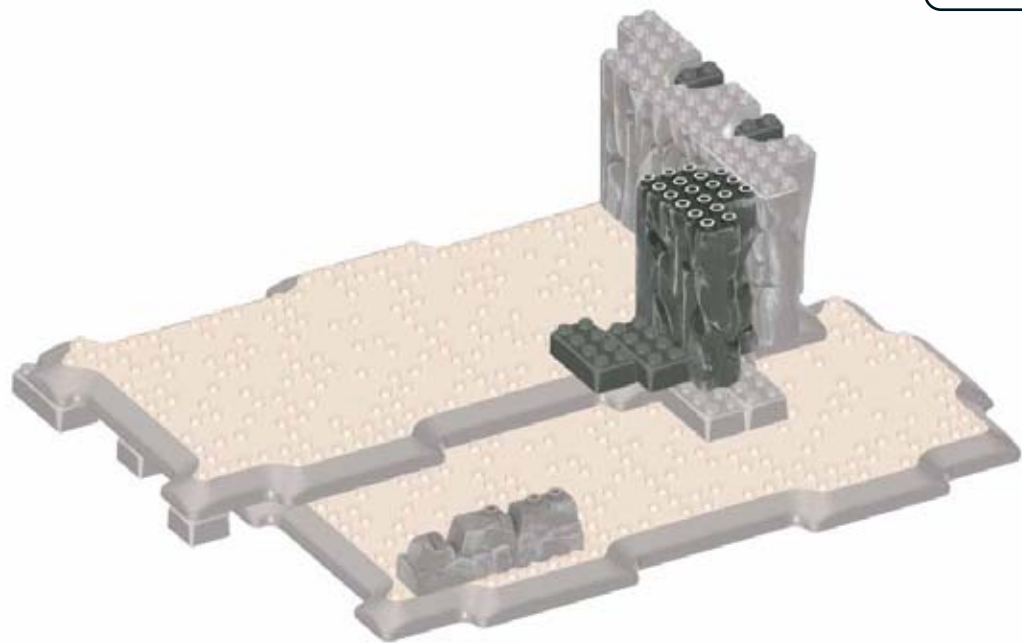
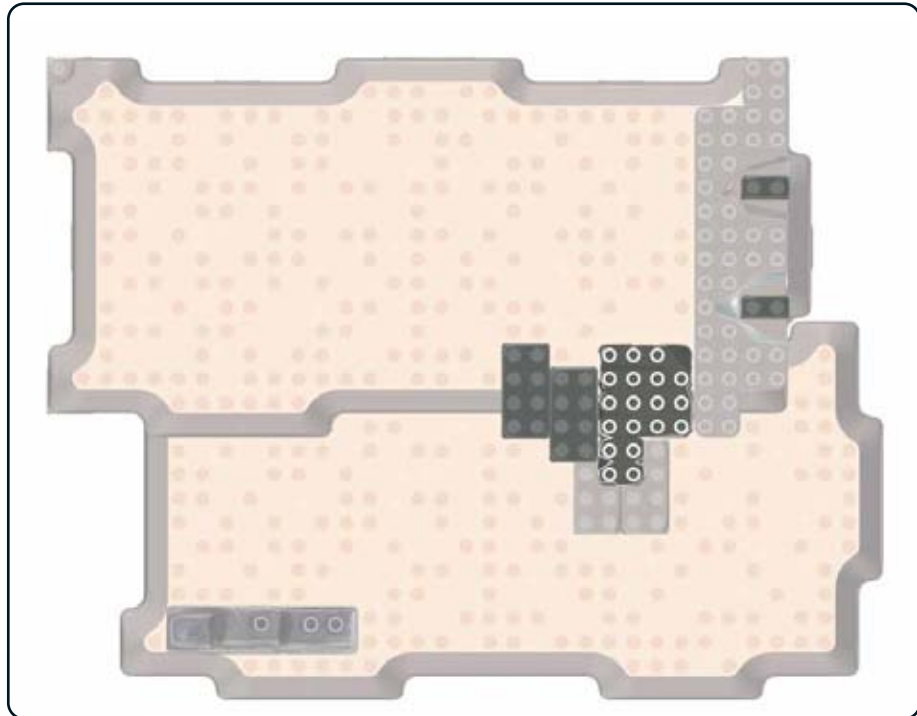

5



1x



1x

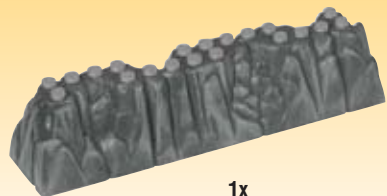

1x

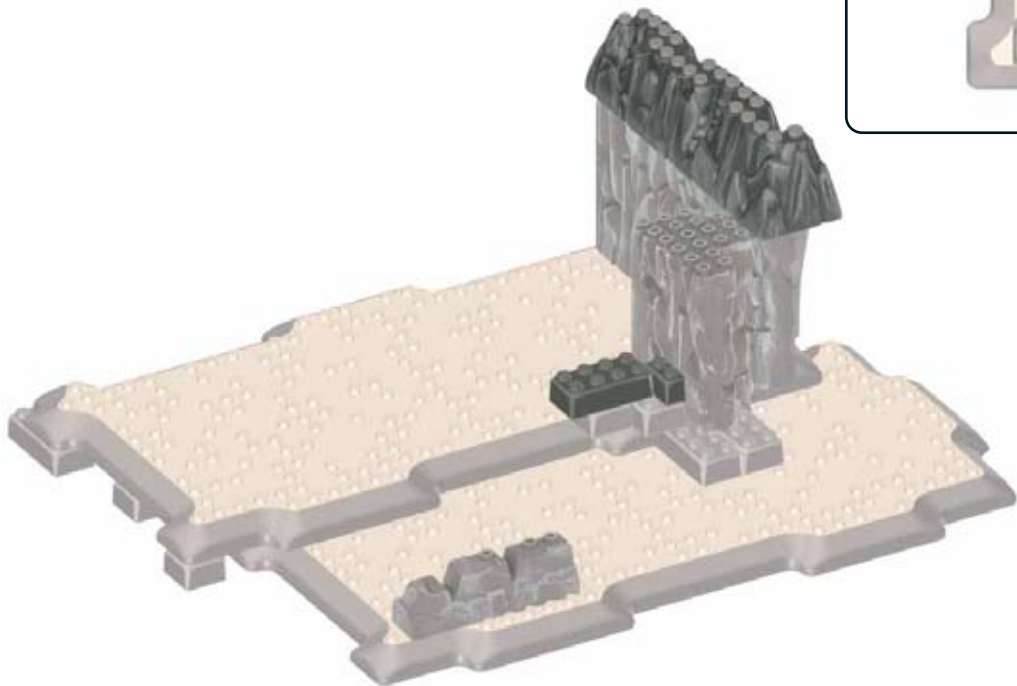
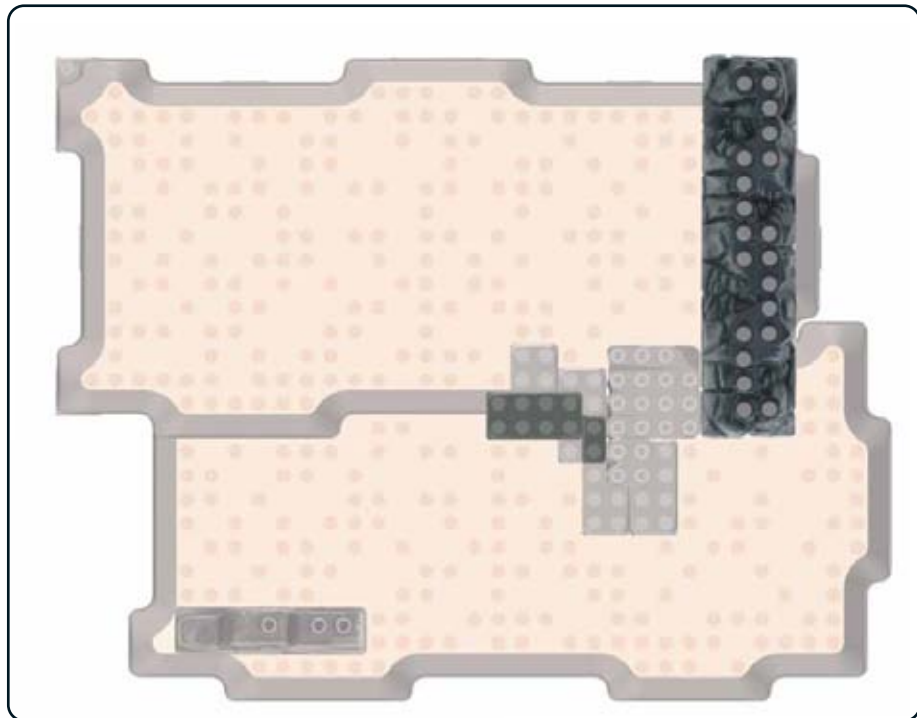

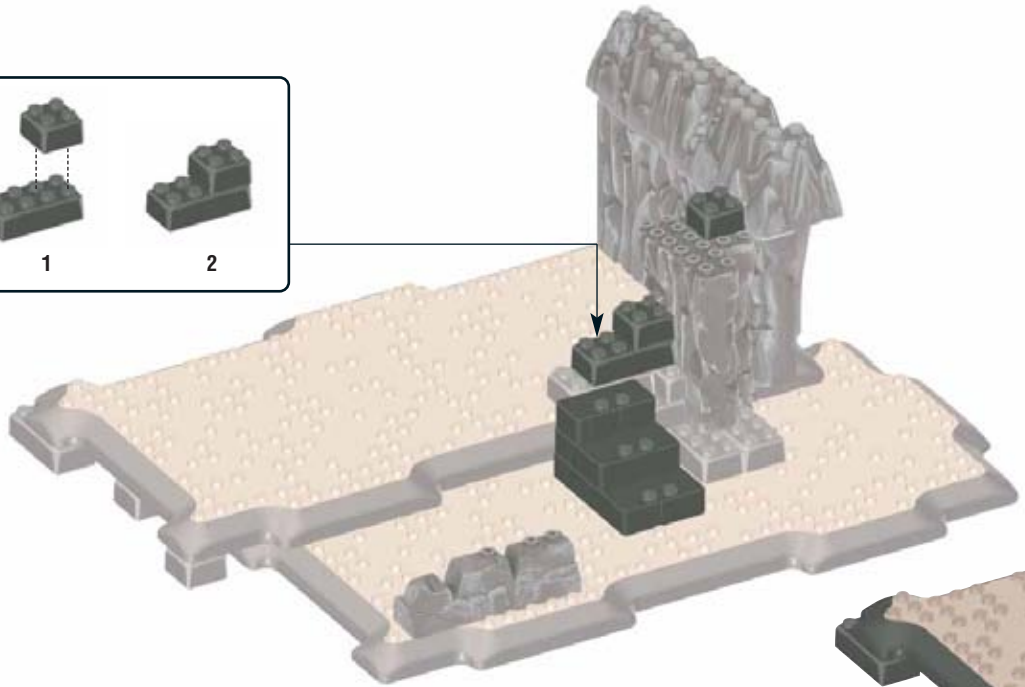
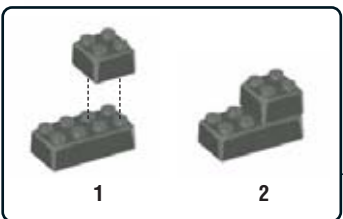
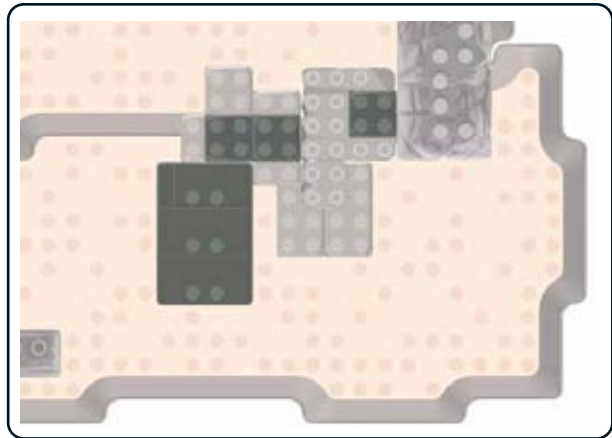
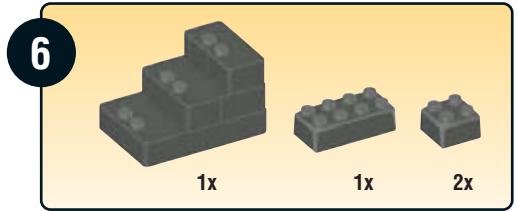

7

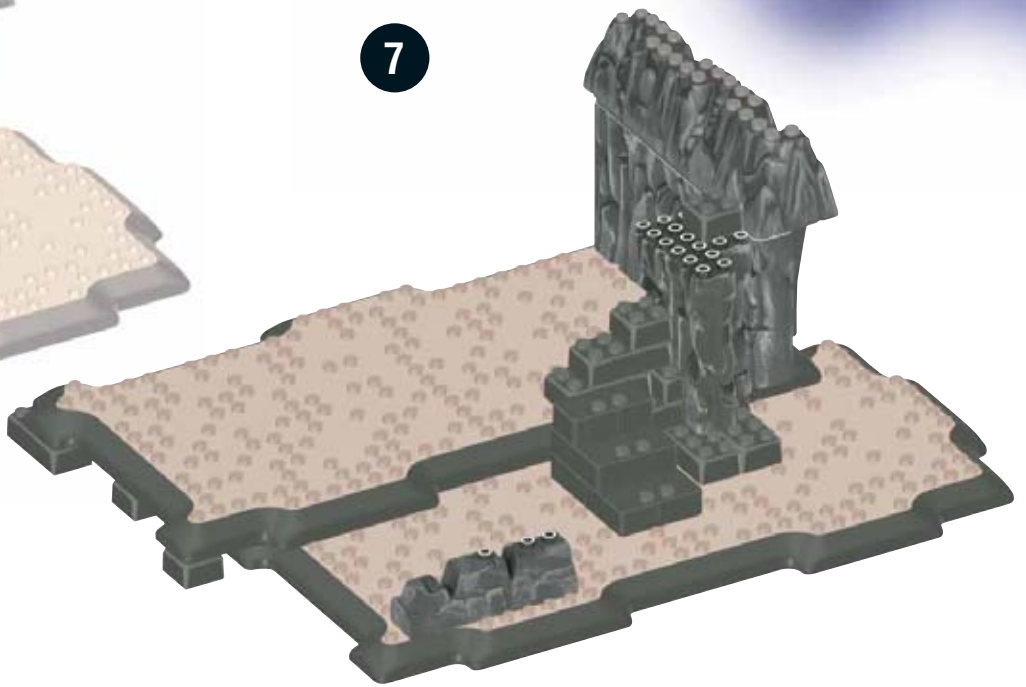

Final Assembly • Ensamblado Final
Assemblage Final • Eindmontage



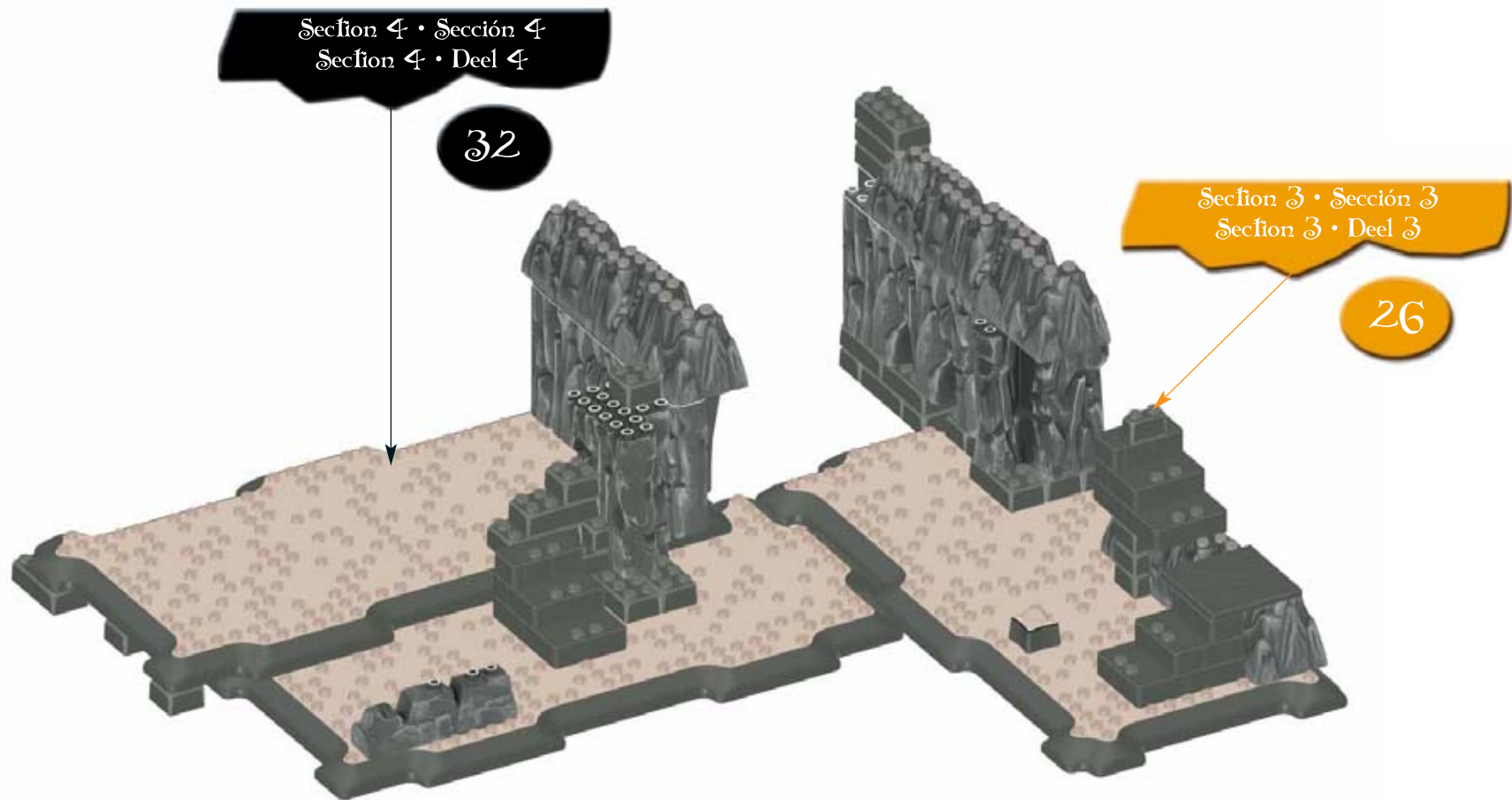

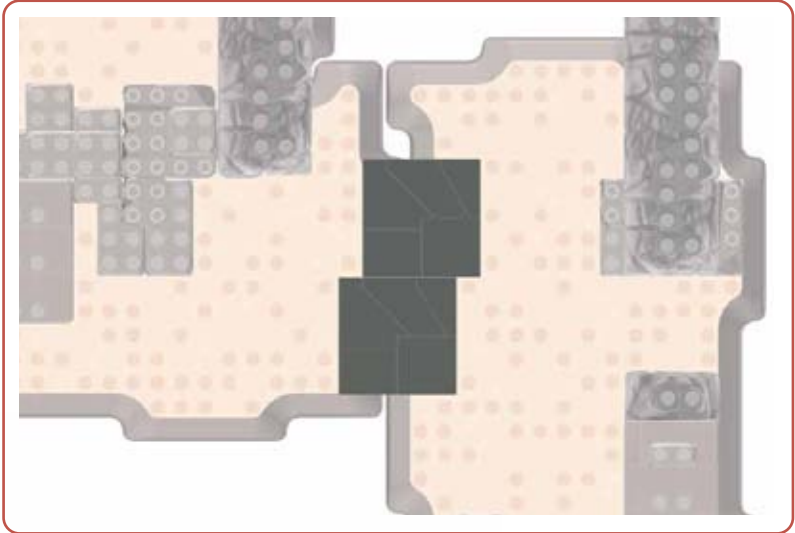
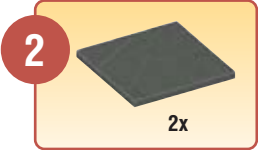

3

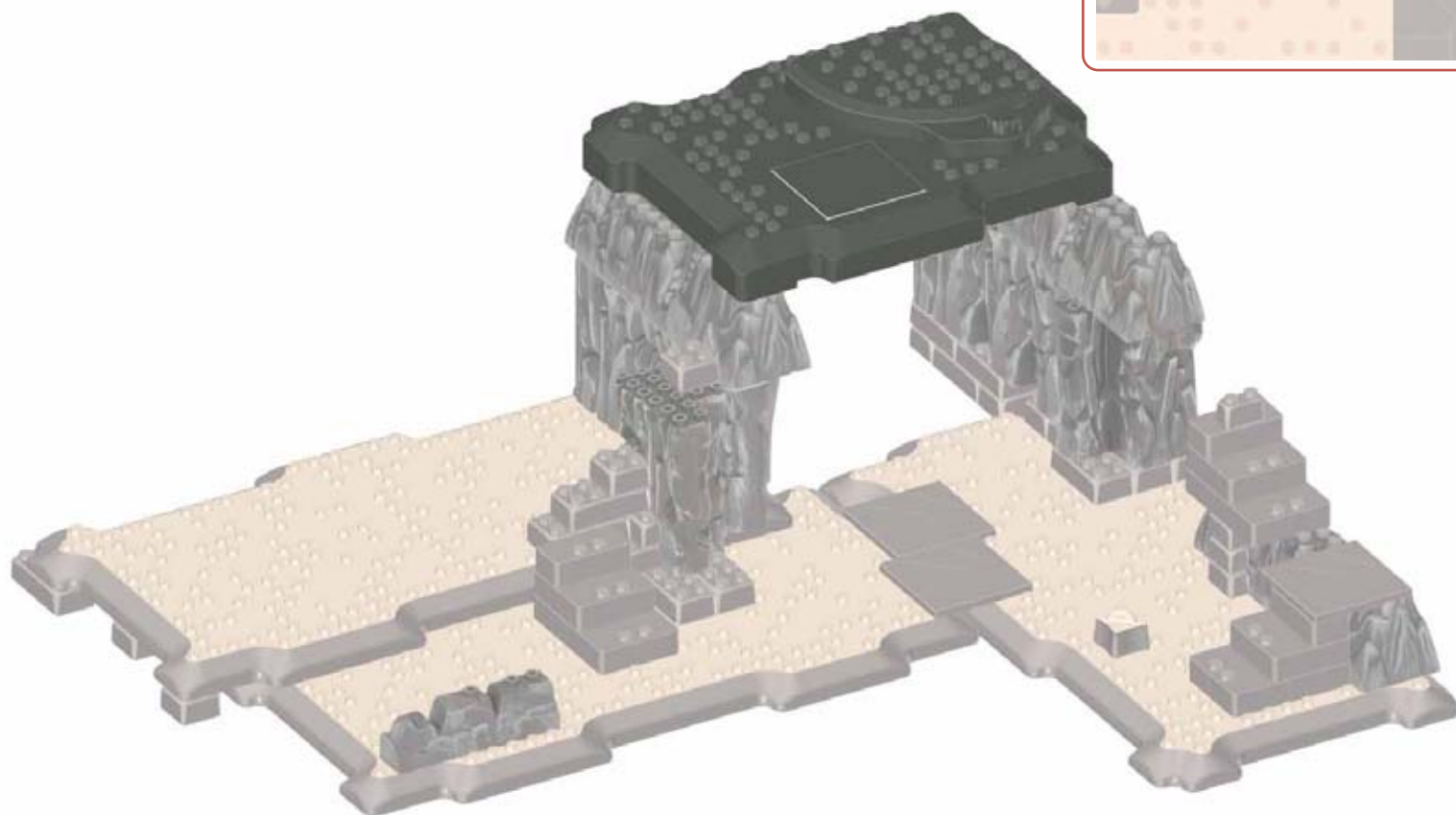
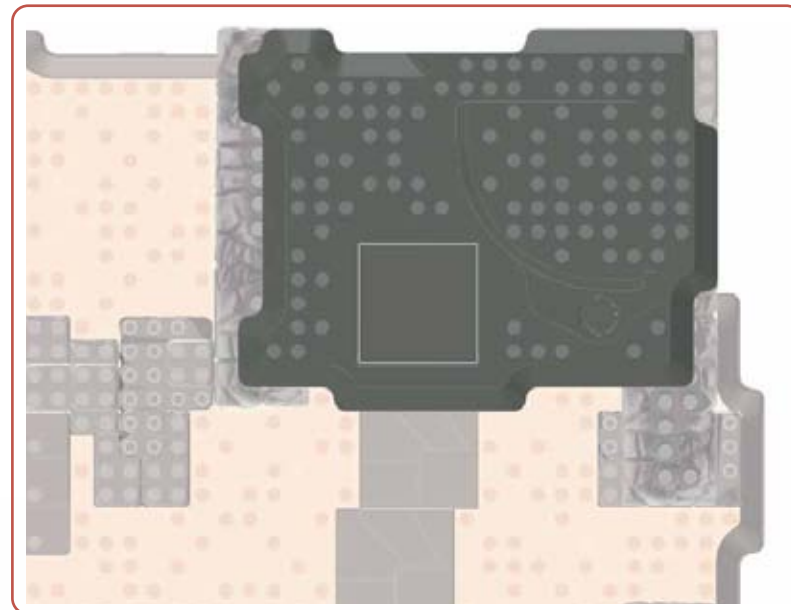
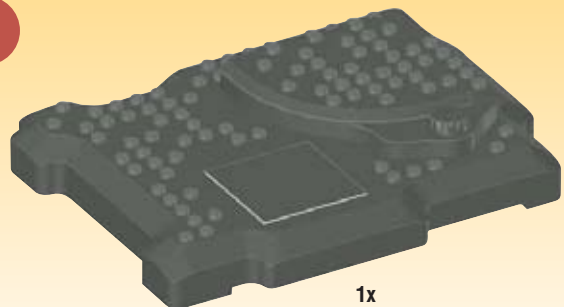



4  4x

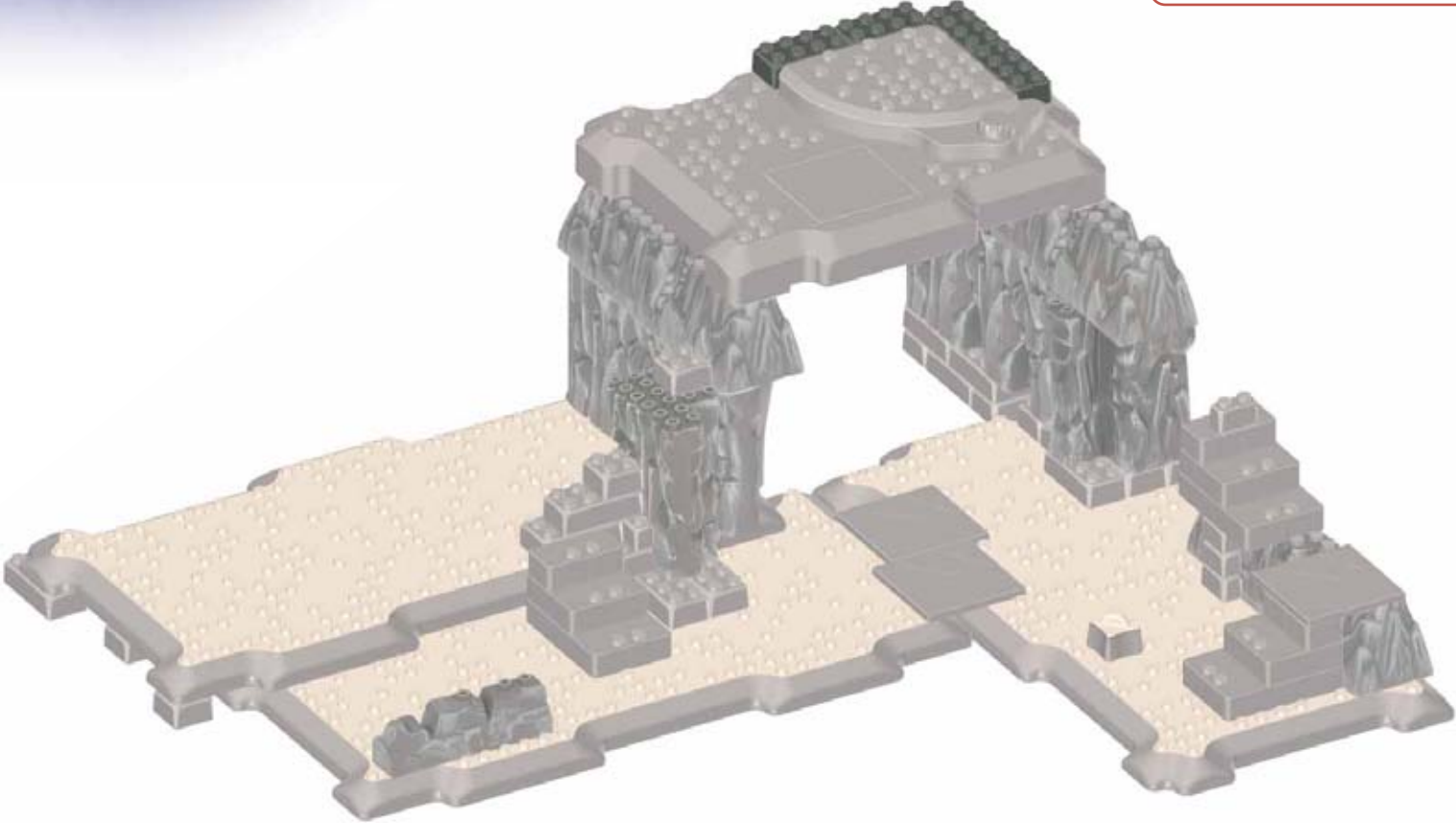
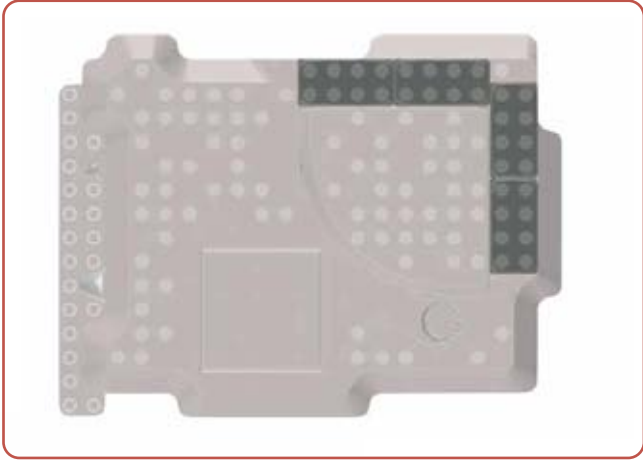

5

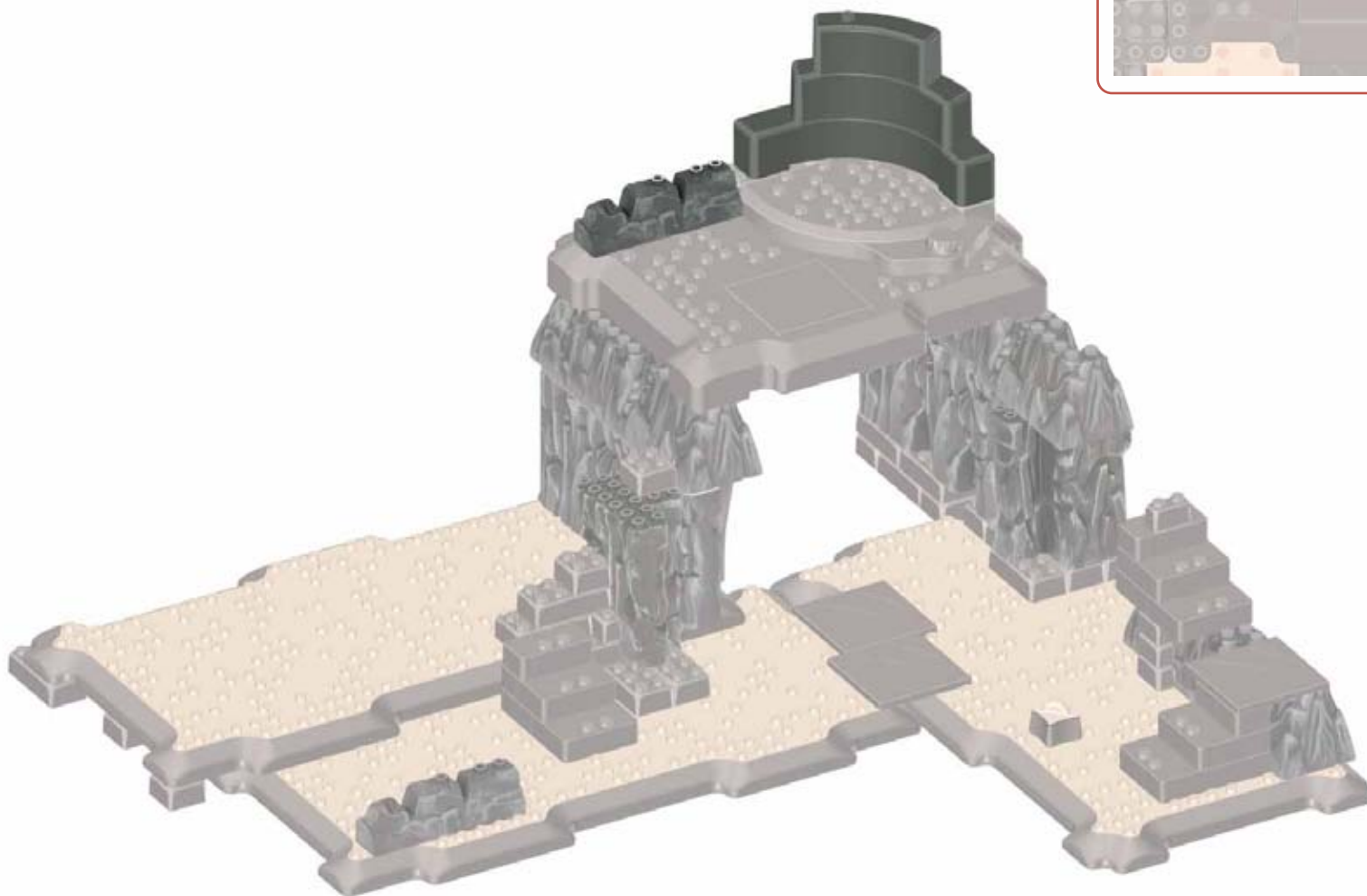
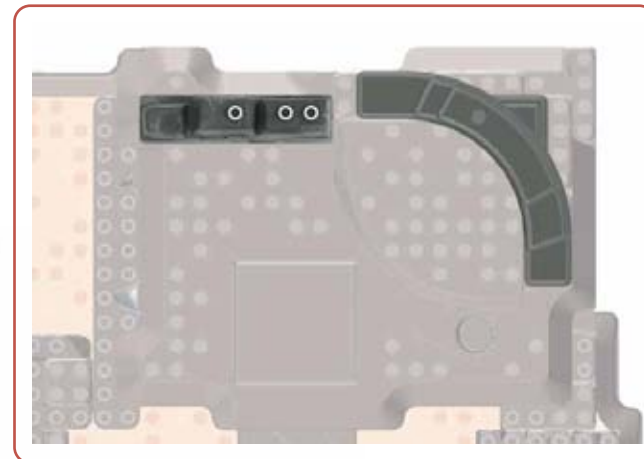
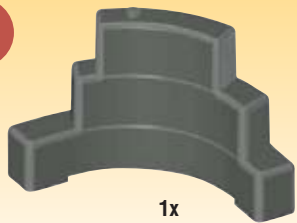

6



3x

Weapons • Armas
Armes • Wapens

10

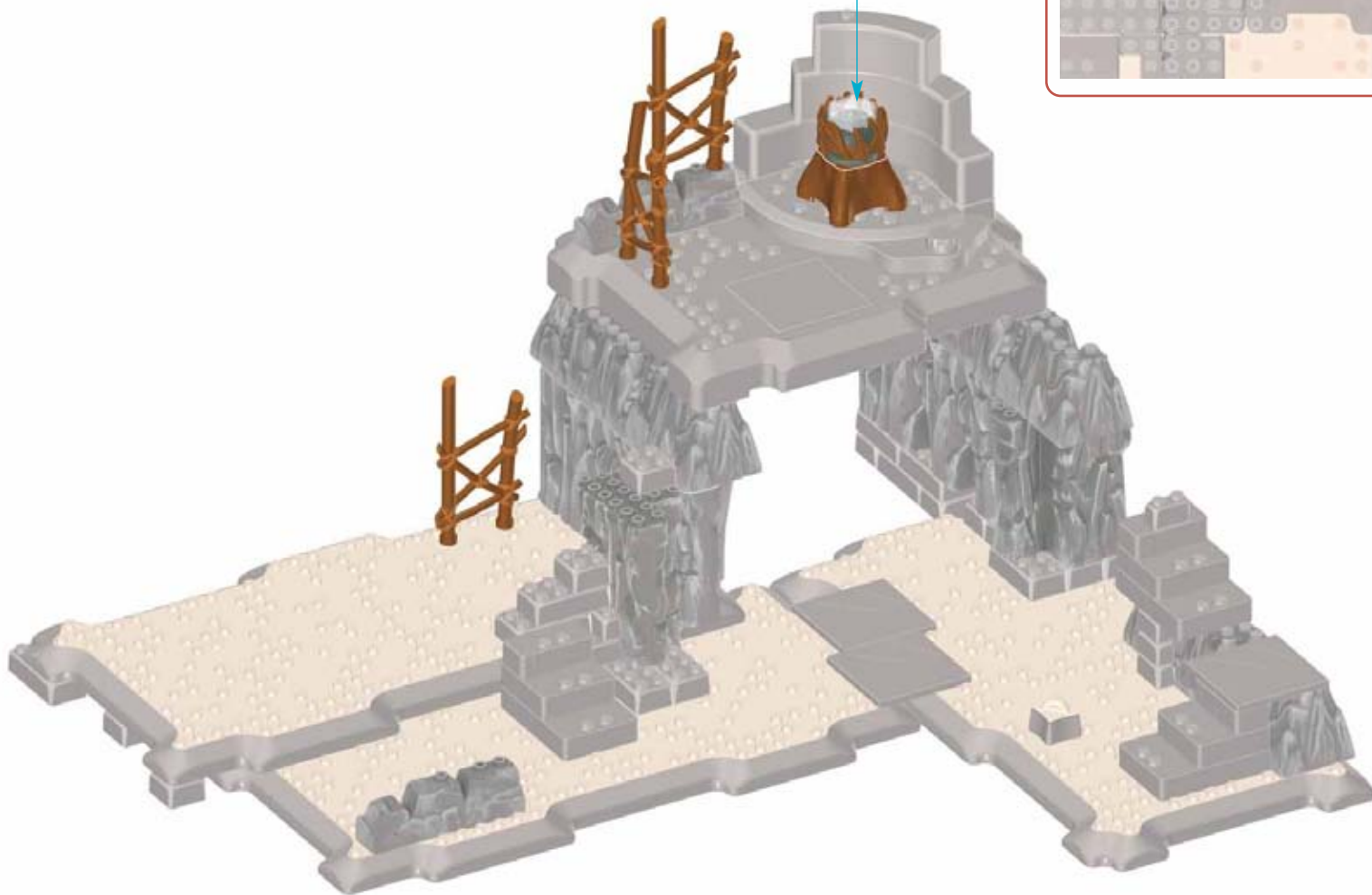
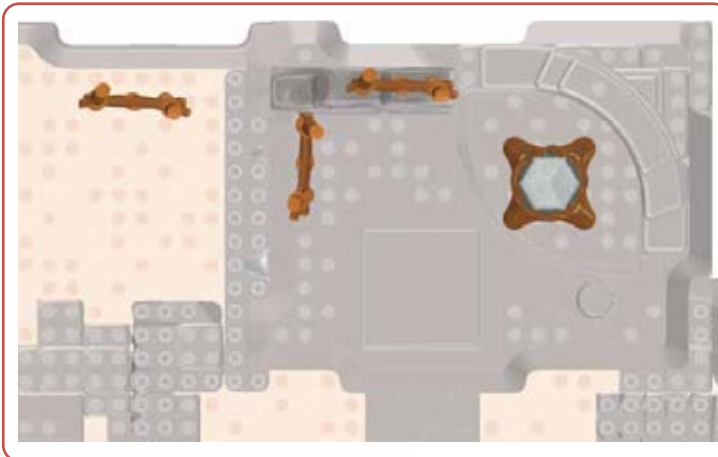

7

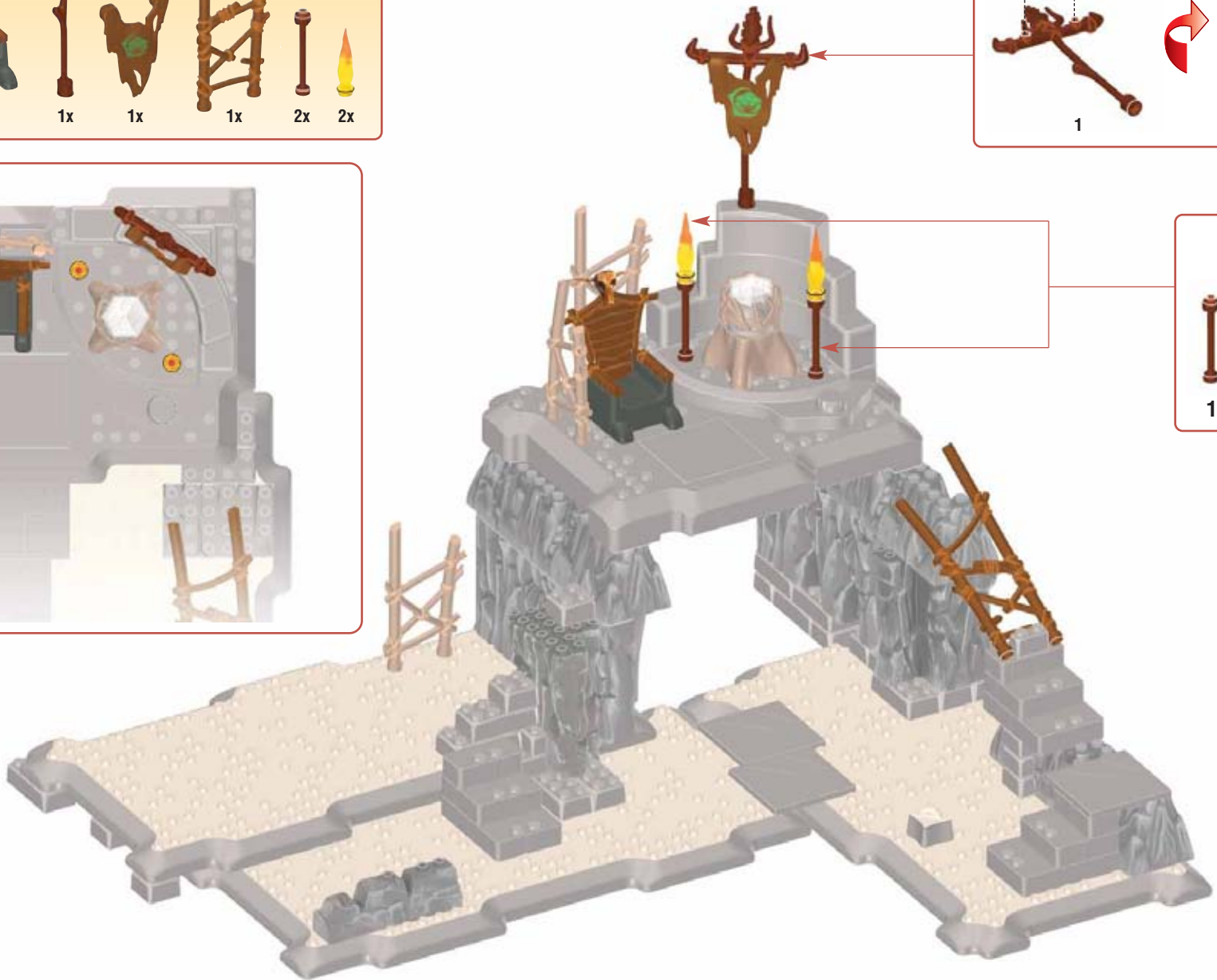
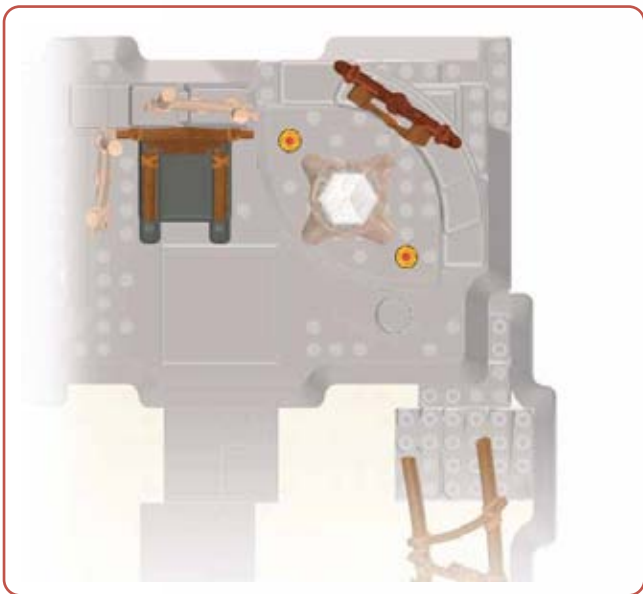
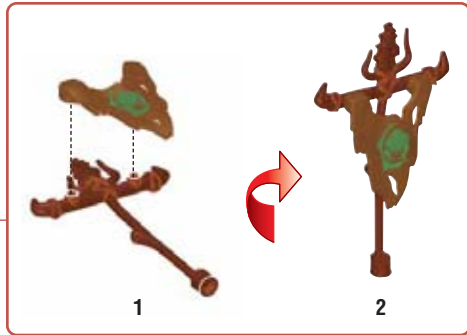

2x

8

Sección 1 • Sección 1
Sección 1 • Deel 1

14



9

Sección 2 • Sección 2
Sección 2 • Deel 2

20

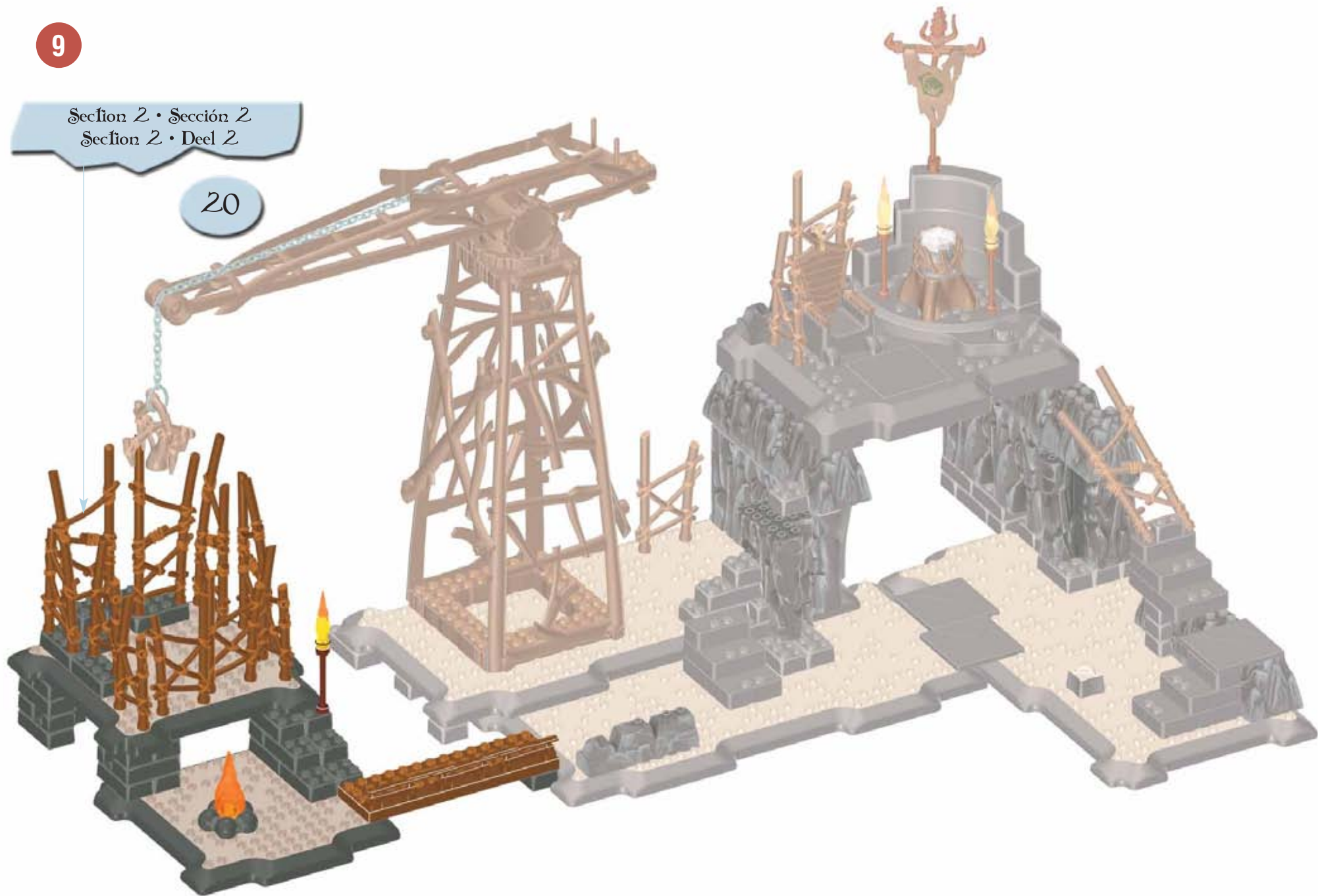



The captured warriors are held at VORÇAN STRONGHOLD™. • Los guerreros capturados son retenidos en la VORÇAN STRONGHOLD™.
Les guerriers capturés sont détenus au VORÇAN STRONGHOLD™. • De gevangen krijgers worden in VORÇAN STRONGHOLD™ vastgeboorden.



Insert the chrome staff to flip the warrior into the battle pit! • Introduce el bastón de cromo para empujar el guerrero dentro del foso de lucha!
Insérez le bâton de chrome pour faire basculer le guerrier dans l'arène. • Steek de chromestaf erin om de krijger in de vechtkuil te kieperen!



TROUBLE SHOOTER GUIDE

Problem

- Lights do not turn on.

Try these solutions

- Remove power crystal and re-insert according to the instructions.
- Remove batteries and install according to instructions and diagram.
- Clean battery terminals.
- Replace batteries.

PROBLEMA Y SOLUCIONES

Problema

- Las luces no se encienden

Intentar lo siguiente

- Retirar el cristal del poder e instalarlo según las instrucciones.
- Retirar las pilas y volver a colocarlas, siguiendo las instrucciones y diagramas.
- Limpiar los bornes.
- Cambiar las pilas.

GUIDE DE DÉPANNAGE

Problème

- Les lumières ne s'allument pas.

Essayez ces solutions

- Enlever le cristal du pouvoir et le remettre en place selon les instructions.
- Enlever les piles et les remettre en place selon les instructions et diagrammes.
- Nettoyer les contacts des piles.
- Remplacer les piles.

HANDLEIDING STORINGZOEKEN

Probleem

- Lichten gaan niet aan.

Probeer de volgende oplossingen

- Verwijder de oplichtende krachtkristal en steek het weer in volgens de aanwijzingen.
- Verwijder de batterijen en leg ze opnieuw in zoals aangegeven in de handleiding en op de afbeelding.
- Reinig de polen.
- Vervang de batterijen.

EN CAUTION:

- Do not leave the dragon, power crystal or electronic module close to a source of heat or in direct sunlight.
- Do not operate the dragon, power crystal or electronic module outdoors.
- Operate the dragon, power crystal or electronic module in a dry area.
- Avoid sand and water. If moisture gets inside one of the electronic compartments, remove the batteries and allow it to dry thoroughly before using.

ES ADVERTENCIA:

- No exponga el dragón, el cristal del poder o el módulo electrónico a una fuente de calor ni a los rayos directos del sol.
- No utilice el dragón, el cristal del poder o el módulo electrónico al exterior.
- Utilice el dragón, el cristal del poder y el módulo electrónico en un lugar seco.
- Evite el contacto con agua o arena. Si la humedad penetra los compartimentos electrónicos, retire las pilas y deje secar completamente antes de volver a utilizar el juguete.

FR AVERTISSEMENT:

- Ne pas laisser le dragon, le cristal du pouvoir ou le module électronique près d'une source de chaleur ou directement au soleil.
- Ne pas utiliser le dragon, le cristal du pouvoir ou le module électronique dehors.
- Utiliser le dragon, le cristal du pouvoir et le module électronique dans un endroit sec.
- Ne pas utiliser dans l'eau ni dans le sable. Si l'humidité pénètre dans les compartiments électroniques, enlever les piles et laisser sécher complètement avant d'utiliser à nouveau.

NL WAARSCHUWING:

- Laat de draak, oplichtende krachtkristal of elektronische module niet dichtbij een warmtebron of in direct zonlicht staan.
- Gebruik de draak, oplichtende krachtkristal of elektronische module niet buitenshuis.
- Gebruik de draak, oplichtende krachtkristal of elektronische module op een droge plaats.
- Vermijd zand en water. Mocht er toch vocht in een van de elektronicavakken terecht komen, verwijder dan de batterijen en laat het speelgoed grondig drogen voordat het weer wordt gebruikt.

EN CAUTION: TO AVOID BATTERY LEAKAGE:

1. See the diagram to know how to remove and insert batteries.
2. Non-rechargeable batteries must never be recharged.
3. Rechargeable batteries must be removed from toy before being recharged and rechargeable batteries should be charged under adult supervision.
4. Do not mix alkaline, standard (carbon zinc), or rechargeable (nickel cadmium) batteries. Do not mix used and new batteries together.
5. Only batteries of the recommended type or of a similar type should be used.
6. Batteries must be inserted according to the correct polarity. (see diagram)
7. Remove batteries from toy when storing for an extended period of time or if batteries are exhausted.
8. The supply terminals must not be short-circuited.

ES ADVERTENCIA: PARA EVITAR QUE LAS PILAS SE SULFATEN:

1. Consultar el diagrama para saber cómo retirar e introducir las pilas.
2. No recargar jamás pilas que no sean recargables.
3. Retirar las pilas recargables del juguete antes de recargarlo; las pilas recargables deben cargarse bajo la supervisión de un adulto.
4. No mezclar pilas alcalinas, con pilas standard (carbon zinc) ni tampoco con pilas recargables (níquel cadmio). No mezclar pilas usadas con pilas nuevas.
5. Solamente deben utilizarse las pilas del tipo recomendado o de tipo similar.
6. Colocar las pilas respetando la polaridad correcta. (ver diagrama)
7. Retirar las pilas del juguete cuando vaya a guardarlo durante un periodo largo de tiempo o si las pilas están gastadas.
8. No originar cortocircuitos en los bornes del compartimiento de las pilas.

FR AVERTISSEMENT: POUR ÉVITER LA FUITE DES PILES:

1. Consulter le diagramme pour savoir comment enlever ou mettre en place les piles ou les accumulateurs.
2. Ne jamais recharger des piles (non-rechargeables).
3. Les accumulateurs doivent être enlevés du jouet avant d'être chargés et les accumulateurs ne doivent être chargés que sous la surveillance d'un adulte.
4. Différents types de piles alcalines, standard (carbone zinc) ou d'accumulateurs (nickel cadmium) ne doivent pas être mélangés. Des piles neuves et usagées ou des accumulateurs neufs et usagés ne doivent pas être mélangés.
5. Seuls des piles ou des accumulateurs du type recommandé ou d'un type similaire doivent être utilisés.
6. Les piles et les accumulateurs doivent être mis en place en respectant la polarité. (voir le diagramme)
7. Retirer les piles avant rangement du jouet pour une longue période ou bien si les piles sont usées.
8. Les bornes d'une pile ou d'un accumulateur ne doivent pas être mises en court-circuit.

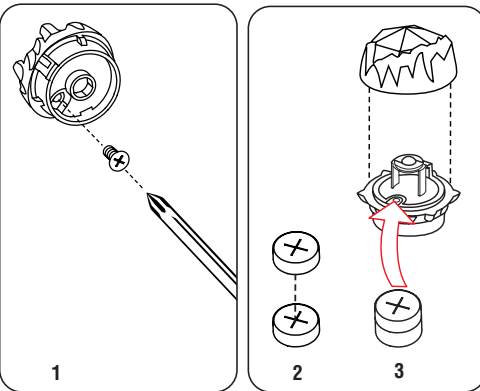

- CAUTION! Batteries are to be changed by an adult. Do not leave batteries within reach of children.
- ADVERTENCIA: Las pilas debe cambiarlas un adulto. No dejar las pilas al alcance de los niños.
- ATTENTION : Le changement de piles doit être réalisé par un adulte. Ne pas laisser les piles à la portée des enfants.
- OPGEPAST: de batterijen moeten door een volwassene worden vervangen.

- This toy uses 2 alkaline button cell batteries (SR41, 392, 1134SO or equivalent).
- El juguete requiere 2 pilas botón alcalinas (SR41, 392, 1134SO o equivalente).
- Le jouet utilise 2 piles boutons alcalines (SR41, 392, 1134SO ou l'équivalent).
- Dit speelgoed gebruikt 2 alkalische knoopcelbatterijen (SR41, 392, 1134SO of gelijkwaardig).

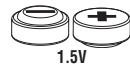

Non-rechargeable batteries included./
Incluye pilas no recargables./

Piles fournies non rechargeables./
Niet-oplaadbare batterijen meegeleverd.

⚠️ WAARSCHUWING: VOORKOMEN VAN LEKKENDE BATTERIJEN:

1. Wijze waarop vervangbare batterijen moeten worden verwijderd en ingelegd (zie afbeelding).
2. Niet-oplaadbare batterijen mogen niet worden opgeladen.
3. Oplaadbare batterijen dienen vóór het opladen uit het speelgoed te worden verwijderd en alleen onder toezicht van een volwassene te worden opgeladen.
4. Gebruik oude en nieuwe batterijen niet door elkaar. Gebruik alkalische, standaard (zinkkoolstof) of oplaadbare (nikkelcadmium) batterijen niet door elkaar. Gebruik oude en nieuwe batterijen niet door elkaar.
5. Uitsluitend batterijen van het aanbevolen type of van een vergelijkbaar type mogen worden gebruikt.
6. Batterijen moeten worden ingelegd met inachtneming van de juiste polariteit (zie afbeelding).
7. Haal de batterijen uit het speelgoed wanneer het voor een lange periode niet wordt gebruikt of als de batterijen leeg zijn.
8. De voedingsklem mag niet worden kortgesloten.

⚠️ WARNUNG: UM DAS AUSLAUFEN DER BATTERIEN ZU VERMEIDEN:

1. Einlegen und Auswechseln der Batterien. (Siehe Abbildung)
2. Nichtwiederaufladbare Batterien dürfen nicht wieder aufgeladen werden.
3. Wiederaufladbare Batterien müssen zum Aufladen aus dem Spielzeug herausgenommen werden und dürfen nur unter Aufsicht von Erwachsenen aufgeladen werden.
4. Alte und neue Batterien nicht zusammen verwenden. Alkalibatterien, Standardbatterien (Kohle-Zink-Batterien), wiederaufladbare Batterien (Nickel-Cadmium) nicht mischen. Nur Batterien derselben Sorte verwenden.
5. Nur Batterien der empfohlenen oder ähnlichen Sorte verwenden.
6. Batterien gemäß Polarität einlegen. (siehe Abbildung)
7. Batterien bei längerer Lagerung, oder wenn sie verbraucht sind, aus dem Spielzeug herausnehmen
8. Die Batterieanschlüsse nicht kurzschliessen.

⚠️ ADVARSEL: SÅDAN UNGDÅS BATTERI-LÆKAGE:

1. Se diagrammet om hvordan batterier udtages og indsættes.
2. Ikke opladelige batterier må aldrig oplades.
3. Opladelige batterier skal tages ud af legetøjet før det oplades, og opladelige batterier skal oplades i tilstedeværelse af en voksen.
4. Opladelige (nikkel-kadmium) batterier og alkalisk-, standardbatterier (zink-kul) må ikke blandes. Nye og brugte batterier må ikke bruges sammen.
5. Brug kun den foreslåede type batterier eller lignende type.
6. Sæt batterier i med polerne vendt den rigtige vej. (se diagram)
7. Tag batterierne ud, hvis legetøjet ikke skal bruges i længere tid eller hvis batterierne er udrændte.
8. Batteriterminalerne må ikke kortsluttes.

⚠️ ΠΡΟΣΟΧΗ: ΠΑ ΤΗΝ ΑΠΟΦΥΓΗ ΔΙΑΡΡΟΗΣ ΤΗΣ ΜΠΑΤΑΡΙΑΣ

1. Δείτε το διάγραμμα για να δείτε πως να αφαιρείτε και να τοποθετείτε τις μπαταρίες.
2. Δεν πρέπει ποτέ να επαναφορτίζετε τις μη επαναφορτιζόμενες μπαταρίες.
3. Θα πρέπει να αφαιρείτε τις επαναφορτιζόμενες μπαταρίες από το παιχνίδι πριν τις επαναφορτίσετε και θα πρέπει να φορτίζετε τις επαναφορτιζόμενες μπαταρίες κάτω από την επίβλεψη ενήλικου.
4. Να μην αναμειγνύετε αλκαλικές, κανονικές (άνθρακα - ψευδάργυρου), ή επαναφορτιζόμενες (νικελίου καδμίου) μπαταρίες. Να μην τοποθετείτε καινούργιες και μεταχειρισμένες μπαταρίες μαζί.
5. Να χρησιμοποιείτε μόνο μπαταρίες του συνιστώμενου τύπου ή ισοδύναμα.
6. Θα πρέπει να εισάγετε τις μπαταρίες σύμφωνα με τη σωστή πολικότητα.
7. Να αφαιρείτε τις μπαταρίες από το παιχνίδι όταν το αποθηκεύετε για παρατεταμένο χρονικό διάστημα ή εάν έχουν εξαντληθεί οι μπαταρίες.
8. Δεν θα πρέπει να βραχυκυκλώνετε τα θερματικά παροχής.

⚠️ VARO: PARISTOJEN VUOTAMISEN ESTÄMINEN:

1. Katso kuvasta, kuinka poistat ja asennat paristot.
2. Ei-ladattavia paristoja ei koskaan saa ladata.
3. Ladattavat paristot on poistettava leikkikalusta ennen niiden lataamista ja lataaminen on tehtävä aikuisen valvonnassa.
4. Älä sekoita alkali-, normaali- (hiili-sinkki) tai ladattavia (nikkelikadmium) -paristoja. Älä sekoita käytettyjä ja uusia paristoja keskenään.
5. Käytä vain suositeltuja tai samankaltaisia paristoja.
6. Paristot on asennettava navat oikein päin. (katso kuvaa)
7. Poista paristot leikkikalusta, kun leikkialua säilytetään pitkän aikaa tai jos paristot ovat lopussa.
8. Virtanapoihin ei saa aiheuttaa oikosulkuja.

⚠️ ATTENZIONE: PER EVITARE PERDITE DALLE PILE

1. Osservare il diagramma per capire come togliere ed inserire le pile
2. Le pile non ricaricabili non devono mai essere ricaricate.
3. Le pile ricaricabili devono essere tolte dal giocattolo prima di essere ricaricate e devono essere ricaricate sotto la supervisione di un adulto.
4. Non mescolare pile alcaline, normali (zinco carbonio) o ricaricabili (nickel cadmium). Non mescolare pile usate e nuove.
5. Si dovrebbero usare solo pile del tipo raccomandato o di un tipo simile.
6. Le pile devono essere inserite secondo la giusta polarità (vedi diagramma).
7. Togliere le pile dal giocattolo prima di lunghi periodi di inutilizzazione o se le pile sono scariche.
8. I terminali di alimentazione non devono essere corto-circuitati.

⚠️ FORSIKTIG! SLIK UNNGÅR DU BATTERILEKKASJE:

1. Illustrasjonene viser hvordan du skal ta ut og sette inn batteriene.
2. Batterier som ikke er oppladbare, skal aldri lades opp på nytt.
3. Oppladbare batterier må tas ut av leketøyet før de lades opp igjen, og oppladning må skje under oppsyn av en voksen.
4. Alkaliske, standard og oppladbare batterier (nikkelkadmium) skal ikke brukes om hverandre. Nye og gamle batterier skal heller ikke brukes sammen.
5. Bruk kun batterier av anbefalt type eller en tilsvarende type.
6. Batteriene skal settes inn slik at polene vender riktig vei.
7. Ta batteriene ut av leketøyet ved lengre tids oppbevaring og når de er oppbrukte.
8. De elektriske polene må ikke kortsluttes.

⚠️ ATENÇÃO: PARA EVITAR O ESCORRIMENTO DAS BATERIAS:

1. Consulte o diagrama sobre a inserção das baterias.
2. As baterias não recarregáveis nunca devem ser recarregadas.
3. As baterias recarregáveis devem ser removidas do brinquedo antes de serem recarregadas. O recarregamento de baterias sempre deve ser supervisionado por um adulto.
4. Não misture baterias alcalinas normais (zinco de carbono) com recarregáveis (níquel cádmio). Não combine baterias novas com usadas.
5. Utilisar só baterias do tipo recomendado ou semelhantes.
6. As baterias devem ser inseridas de acordo com a polaridade indicada.. (veja o diagrama)
7. Remova as baterias do brinquedo ao armazená-lo por um período prolongado ou se as baterias estiverem gastas.
8. Os terminais de alimentação não devem ser ligados em curto circuito.

⚠️ VAR FÖRSIKTIG! UNDVIK BATTERILÄCKAGE:

1. I diagrammet visas hur batterierna ska bytas ut.
2. Ladda aldrig batterier som inte är avsedda för att återladdas.
3. Laddningsbara batterier måste avlägsnas från leksaken innan de laddas och laddningsbara batterier måste laddas under övervakning av vuxen.
4. Blanda inte alkaliska, standard (kolzink) och laddningsbara (nickelkadmium) batterier. Blanda inte ihop använda och nya batterier.
5. Endast batterier av rekommenderad typ eller liknande bör användas.
6. Batterier måste föras in med polerna i rätt läge. (se diagrammet)
7. Avlägsna batterierna från leksaken när den ska förvaras under längre tid eller om batterierna är urladdade.
8. Strömtillförselterminalerna måste kortslutas.

⚠️ 警告：避免電池滲漏。

參看附圖，了解如何裝卸電池。

非充電電池不能充電。

充電之前必須先把充電電池從玩具 里取出來，充電過程必須由成人監督。

不要把鹼性電池、標準電池(碳化鋅電池)或充電電池(鎳鎘電池)混在一起使用。不要把新舊電池混在一起使用。

只應當使用我們推薦的電池或者類似型 號的電池。

電池必須按正確的極性裝入玩具里。(見附圖)

如果一段時間不用玩具，請取出玩具 里的電池，否則電池會消耗干。

電源的两極不能短路。

⚠️ 注意：電氣洩れを防ぐために：

電池の取外し及び挿入については、ダイアグラムをご覧ください。

非再充電式電池へ充電しないで下さい。

再充電を行なう場合には再充電式電池をおもちゃから取り外し、再充電式電池の取扱いは大人が行なって下さい。

アルカリ、標準(炭素-亜鉛)、あるいは再充電式(ニッケルカドミウム)を混合しないで下さい。古い電池と新しい電池を混合して使用しないで下さい。

推奨タイプ、もしくは同等タイプの電池のみを使用して下さい。

電池は正しい電極に挿入して下さい(ダイアグラムを参照下さい)。

おもちゃを長時間使用しない時には、電池を取り外しておいて下さい、そのままにしておくと電池が消耗します。

供給ターミナルは短絡してないこと。

IF YOU HAVE A PROBLEM, PLEASE DO NOT TAKE THIS TOY BACK TO THE STORE. CONTACT US
EN CASO DE PROBLEMAS, NO DEVUELVA EL PRODUCTO A LA TIENDA DONDE LO COMPRÓ. CONTÁCTENOS
VOUS AVEZ DES PROBLÈMES? ON VOUS PRIERAIT DE NE PAS RETOURNER CE JOUET AU MAGASIN. CONTACTEZ-NOUS
HEEFT U PROBLEEM? BRENG HET SPEELGOED DAN NIET TERUG NAAR DE WINKEL. NEEM CONTACT MET ONS OP

1-800-465-MEGA

U.S. & Canada only / Solamente en EEUU y Canadá

É.U. et Canada seulement / Uitsluitend in de V.S. en Canada

INFO@MEGABLOKS.COM



Dragons Krystal Wars

Collect them all! • Colecciónalos todos!
Collectionne-les tous! • Verzamel ze allemaal!



Vorgan Stronghold™
9891



Dragonar Castle™
9898



Vorgan War Chest™
9867



Dragonar War Chest™
9866



Newspaper War Chest™
9865



Mara's O'War™
9895



Marszalek's Cliff™
9885



Vorgan Attacks™
9873

Vorgan Stronghold™

The captured warriors are held at VORGAN STRONGHOLD™. Help them escape and join the search for the magical Crystal of Power!

Les guerriers capturés sont détenus au VORGAN STRONGHOLD™. Aidez-les à s'échapper et rejoignez-les à la chasse aux Cristaux magiques du pouvoir!

Los guerreros capturados son retenidos en la VORGAN STRONGHOLD™. Ayúdalos a escapar y únete en la búsqueda de los Cristales mágicos del poder!

De gevangene krijgers worden in VORGAN STRONGHOLD™ vastgehouden. Help hen te ontsnappen en doe mee aan de zoektocht naar de magische Krachtkristallen!

Build The Legend! ¡Crea la leyenda!
Bâtis la légende! Bouw de legende!



*Additional purchases required to collect all elements shown.
*La compra adicional de juguetes es necesaria para completar la colección.
*L'achat de jeux additionnels est nécessaire pour compléter la collection présentée.
*Verdere aankopen zijn nodig om alle afgebeelde artikelen te verzamelen.

Products and colors may vary. / Las piezas y los colores pueden variar. /
Les items et les couleurs peuvent varier. / In producten en kleuren kan variatie optreden.



© 2003, MEGA BLOKS INC.
© and ™ denote trademarks of MEGA BLOKS INC.
© y ™ designan la marca registrada y la marca comercial de MEGA BLOKS INC.
© et ™ désignent des marques de commerce de MEGA BLOKS INC.
© en ™ duiden op handelsmerken van MEGA BLOKS INC.

PRINTED IN CHINA AD098912