

# HALO



NMPD Warthog | Warthog du NMPD | Warthog de NMPD  
Javali do NMPD | Warthog di NMPD | NMPD Warzenschwein  
Guziec NMPD | NMPD-Warthog | Автомобиль огневой поддержки NMPD

**MEGA  
BLOKS**

**MEGA  
BLOKS**

# HALO



**INTERCHANGEABLE ARMOR SYSTEM**  
**SYSTÈME D'ARMURE INTERCHANGEABLE**  
**SISTEMA DE ARMADURA INTERCAMBIABLE**  
**SISTEMA DE ARMADURA INTERCAMBIÁVEL**



**SISTEMA DI ARMATURA INTERCAMBIABILE**  
**AUSTAUSCHBARE PANZERUNGSSYSTEM**  
**ZAMIENNY SYSTEM UZBROJENIA**  
**WERWISSELBOAR WAPENRUSTINGSSYSTEEM**  
**СМЕННАЯ СИСТЕМА БРОНИ**

**SUPER POSEABLE MICRO ACTION FIGURES**  
**FIGURINES D'ACTION SUPER ARTICULÉES**  
**FIGURAS DE ACCIÓN MINIATURAS SÚPER FLEXIBLES**  
**MICRO FIGURAS DE AÇÃO SUPER ARTICULÁVEIS**  
**VOLLBEWEGLICHE MICRO AKTION FIGUREN**  
**FIGUURTJES KUNNEN IN ALLE STANDEN WORDEN GEZET**  
**PERSONAGGI MICRO ACTION COMPLETAMENTE SNODABILI**  
**FIGURKI Z WIELOMA RUCHOMYMI ELEMENTAM, KTÓRE POZWALAJĄ PRZYBRAĆ RÓŻNE POZY**  
**СУПЕРПОДВИЖНЫЕ МИКРОФИГУРКИ ГЕРОЕВ**



NMPD Officer  
 Officier du NMPD  
 Oficial del DPNM  
 Oficial do NMPD  
 Agente NMPD  
 NMPD-Offizier  
 Oficer NMPD  
 NMPD-officier  
 Офицер отделения  
 полиции Нью-Момбасы



NMPD Trooper  
 Combattant du NMPD  
 Soldado del DPNM  
 Soldado do NMPD  
 Poliziotto NMPD  
 NMPD-Trooper  
 Żołnierz NMPD  
 NMPD-soldaat  
 Рядовой отделения  
 полиции Нью-Момбасы



Covenant Brute Jump Pack  
 Brute avec propulseur dorsal  
 Paquete de lanzamiento  
 de Covenant Brute  
 Covenant Brute Sprungpaket  
 Covenant Brute met jetpack  
 Mochila de Salto  
 Covenant Brute  
 Bruut Springruzgzak  
 Десантный набор













Covenant Brute Stalker  
 Espion Brute du Covenant  
 Acosador Brute de Covenant  
 Covenant Brute Cacciatore  
 Perseguidor Brute Covenant  
 Следопыт Brute

- 6x MA03328AKQ 
- 4x MA15258AKQ 
- 1x AS-CNH06-05 
- 2x AM74211F 
- 2x AM74210F 
- 1x AM18220F 
- 1x MA09198ALH 
- 5x MA09393AKQ 
- 2x MA09393F 
- 1x AM18221AKQ 
- 4x AM73534BDG 
- 4x AM72534F 
- 1x AM15555X 
- 1x AM15555HJ 

- 2x AM72002ALH 
- 2x AS-CNH06-06 
- 1x AM18234AKQ 
- 1x AM18235AKQ 
- 1x MA03019F 
- 1x AS-CNH06-01 
- 4x MA18710ALH 
- 4x MA72000ALH 
- 4x MA15484AKQ 
- 6x MA15484F 
- 1x MA09013F 
- 2x MA18223ALH 

- 1x MA03773F 
- 11x MA03773AKQ 
- 1x MA1323AKQ 
- 1x AM18231AKQ 
- 4x MA18329ALH 
- 1x AM18224AKQ 
- 1x AM18225AKQ 
- 1x MA03772AKQ 
- 1x MA03772ALH 
- 1x MA03772F 

- 1x MA09106F 
- 1x AM17019ALH 
- 4x MA09593AKQ 
- 4x MA09593ALH 
- 5x MA09493AKQ 
- 4x MA09033ANW 
- 1x AS-CNH06-04 
- 1x AS-CNH06-03 
- 1x AS-CNH06-08 
- 1x AS-CNH06-07 

- 2x AM16964ALH 
- 4x AM18230AKQ 
- 2x AM18241ALH 
- 2x AS-CNH06-10 
- 2x AS-CNH06-09 
- 4x MA73472F 
- 1x AM17148ALH 
- 1x AM17149ALH 

- 1x AM18236AMD 
- 3x MA1480AKQ 
- 1x AM18237ALH 
- 1x AM17184ALH 
- 1x AM17183ALH 
- 1x AM17182ALH 
- 1x MA08483F 

1x  
AS-CNH06-02



1x  
AM17181ALH



1x  
AM18217AKQ

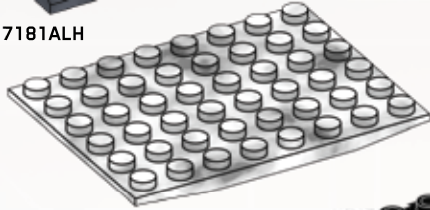

2x  
AM18668F



1x  
MA1172F

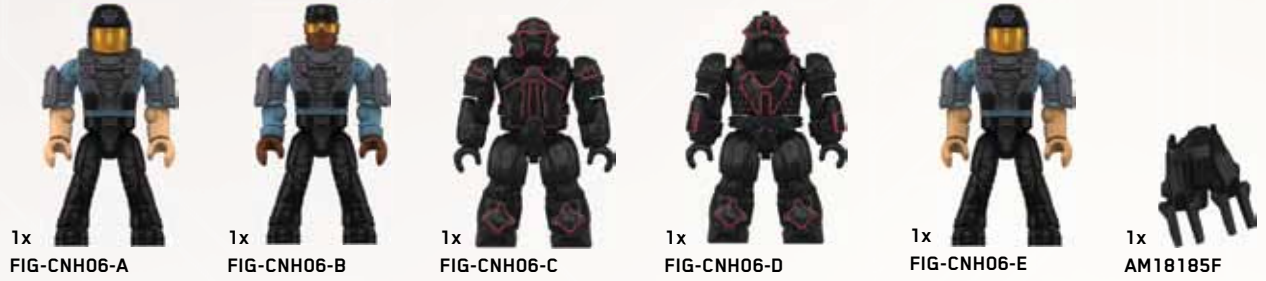

1x  
FIG-CNH06-A

1x  
FIG-CNH06-B

1x  
FIG-CNH06-C

1x  
FIG-CNH06-D

1x  
FIG-CNH06-E

1x  
AM18185F



1x  
AM16700MM



1x  
AM19181MM



1x  
AM73800MM



1x  
AM16699MM



1x  
AM19232AJT

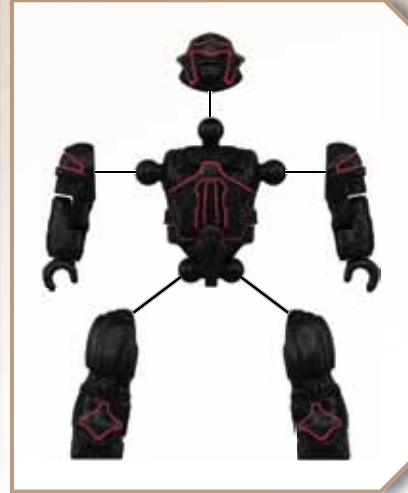

Please read these instructions carefully before first use and keep them for future reference.  
 Il est recommandé de lire attentivement ce feuillet avant la première utilisation et de le conserver pour référence future.  
 Leer estas instrucciones cuidadosamente antes de la primera utilización y guardarlas para referencia futura.  
 Leia as instruções antes do primeiro uso e guarde-as para futura referência.  
 Leggere le istruzioni prima di cominciare ad usare il gioco e conservarle per referenze future.  
 Die Gebrauchsanleitung bitte durchlesen und aufbewahren.  
 Proszę uważnie przeczytać instrukcję obsługi przed pierwszym użyciem, a następnie zachować ją na przyszłość.  
 Wij raden u aan deze handleiding zorgvuldig te lezen en te bewaren voor eventuele raadpleging op een later tijdstip.  
 Внимательно прочитайте инструкцию перед первым использованием и сохраните ее для дальнейшего использования.  
 Vær venlig at læse disse instruktioner omhyggeligt inden ibrugtagten og opbevar dem til fremtidigt brug.  
 Läs noggrant igenom dessa instruktioner innan du använder produkten för första gången och spara dem för ev. framtida frågor.  
 Les disse instruksjonene nøye før første gangs bruk, og ta vare på dem for fremtidige oppslag.  
 Lue nämä ohjeet huolellisesti ennen ensimmäistä käyttöä ja säilytä ne myöhempää tarvetta varten.  
 Διαβάστε αυτές τις οδηγίες προσεκτικά πριν χρησιμοποιήσετε το προϊόν για πρώτη φορά και φυλάξτε τις για μελλοντική αναφορά.  
 يرجى قراءة هذه التعليمات بدقة قبل البدء بالاستعمال والاحتفاظ بها كمرجع للمستقبل  
 请在初次使用前仔细阅读这些指示，并保留它们以便未来参考。  
 初めてご使用になる前に、この説明書をよくお読みください。また、本書は将来いつでも参照できるように保管してください。



© 2015 MICROSOFT CORPORATION. ALL RIGHTS RESERVED. MICROSOFT, 343 INDUSTRIES, THE 343 INDUSTRIES LOGO, HALO, THE HALO LOGO ARE TRADEMARKS OF THE MICROSOFT GROUP OF COMPANIES.

1

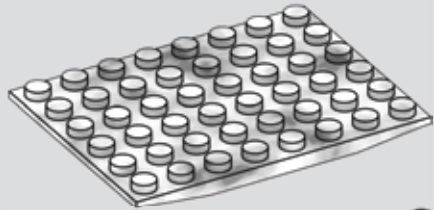
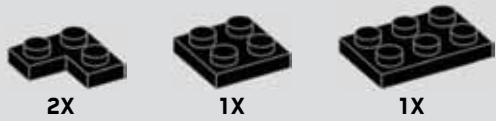

1X

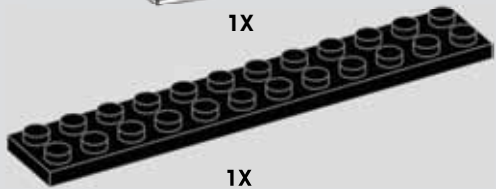

1X

2

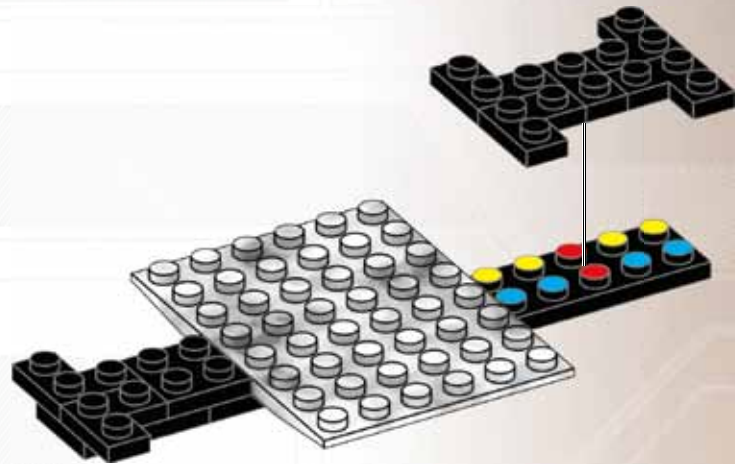
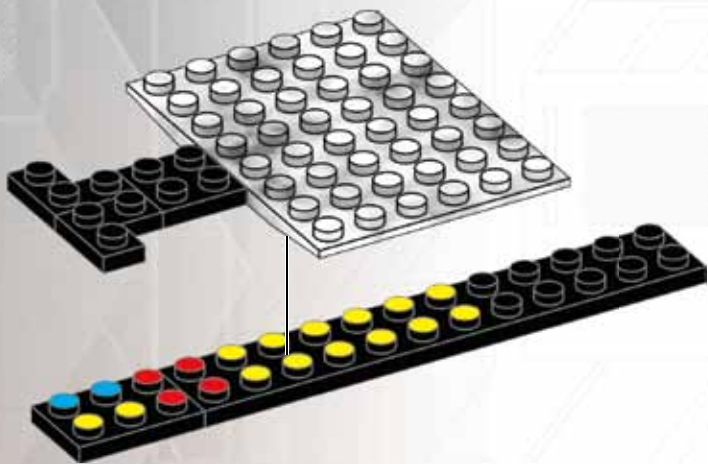

3



4x



Place temporary pieces  
 Placez les pièces temporaires  
 Colocar piezas temporales  
 Coloque peças temporárias  
 Installare i pezzi temporanei  
 Vorübergehende Teile platzieren  
 Umieścić elementy tymczasowe.  
 Plaats tijdelijke bouwstenen  
 Установите временные детали  
 Placer midlertidige stykker.  
 Placera temporära delar  
 Plasser midlertidige deler  
 Aseta väliaikaiset osat  
 Τοποθέτηση προσωρινών κομματιών  
 ضع القطع المؤقتة  
 放置临时件  
 暫定ピースを配置してください

X2



4



1X



2X

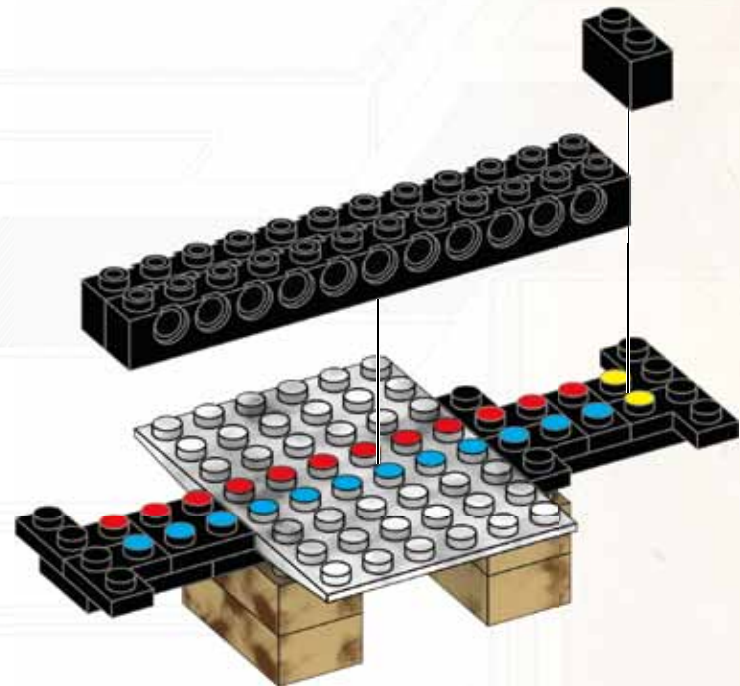
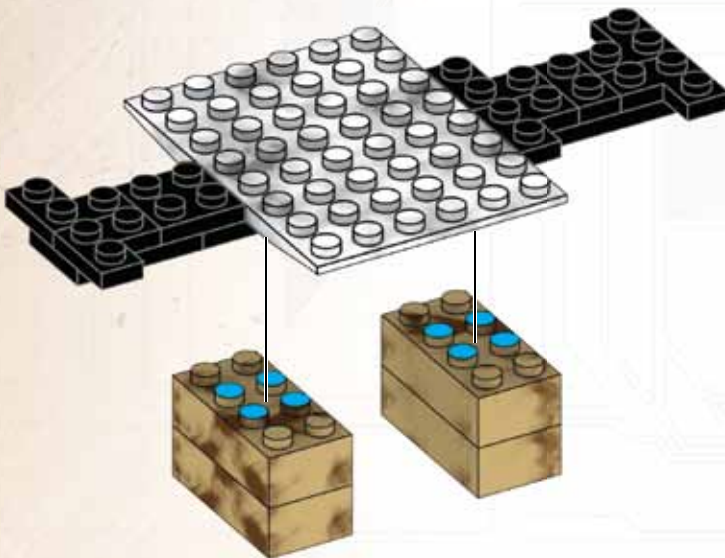

5

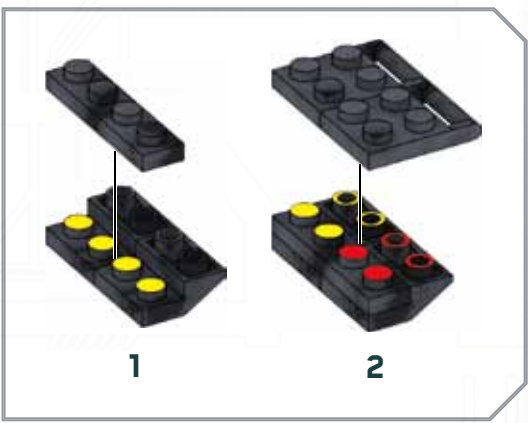
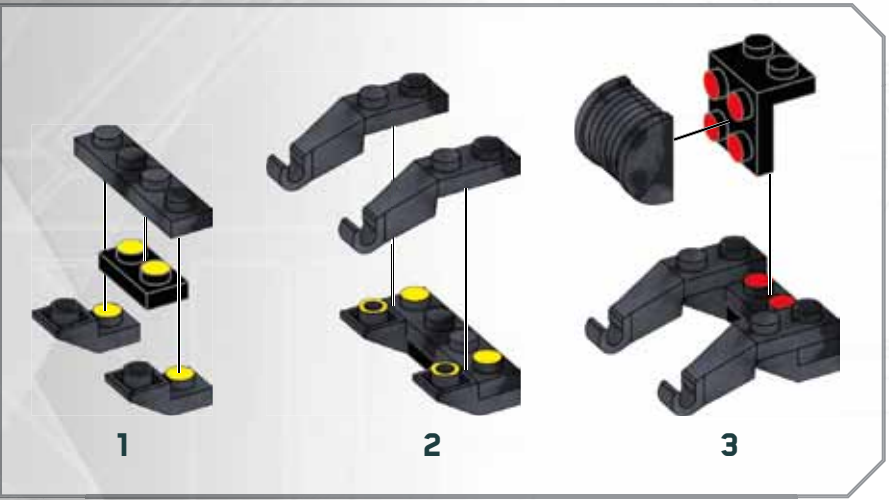
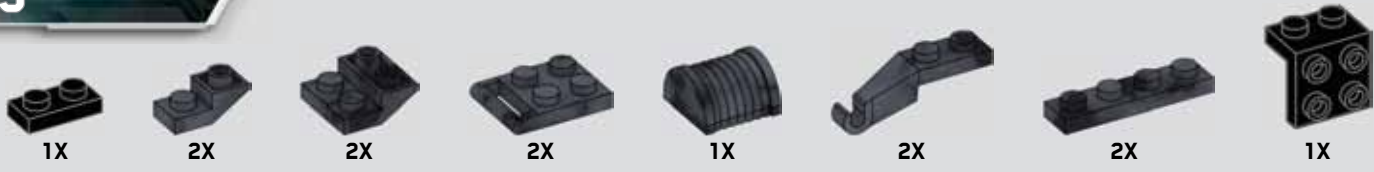



6



4X



4X

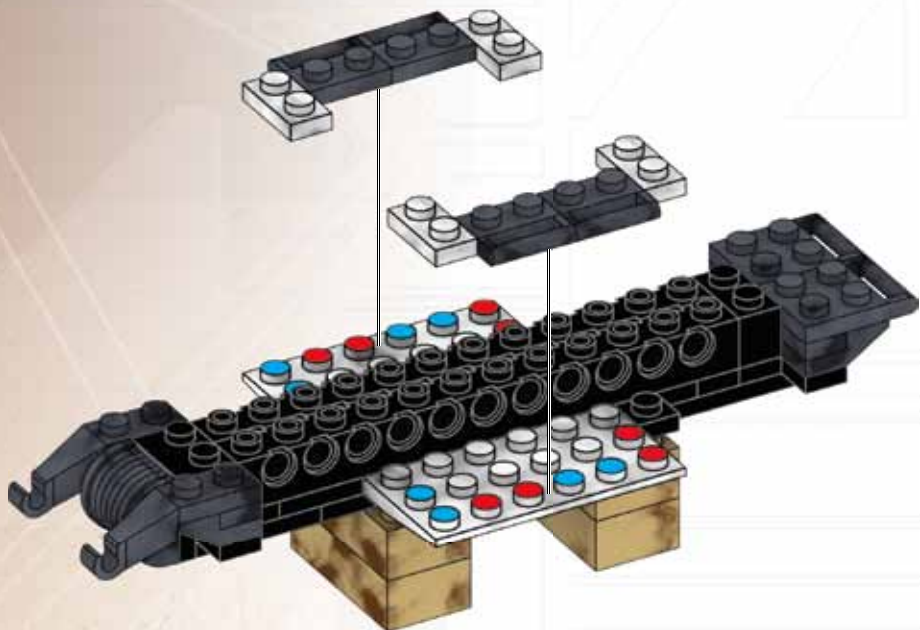

7



1X



2X



8

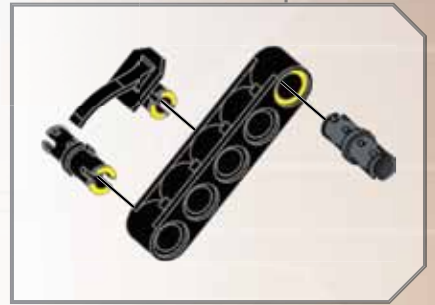

9



X2



10

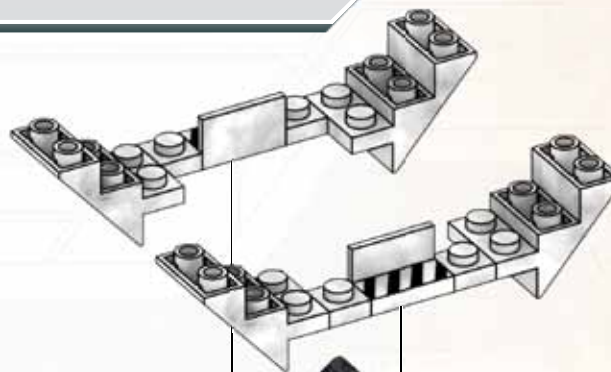

11



4X



12



8X



X4

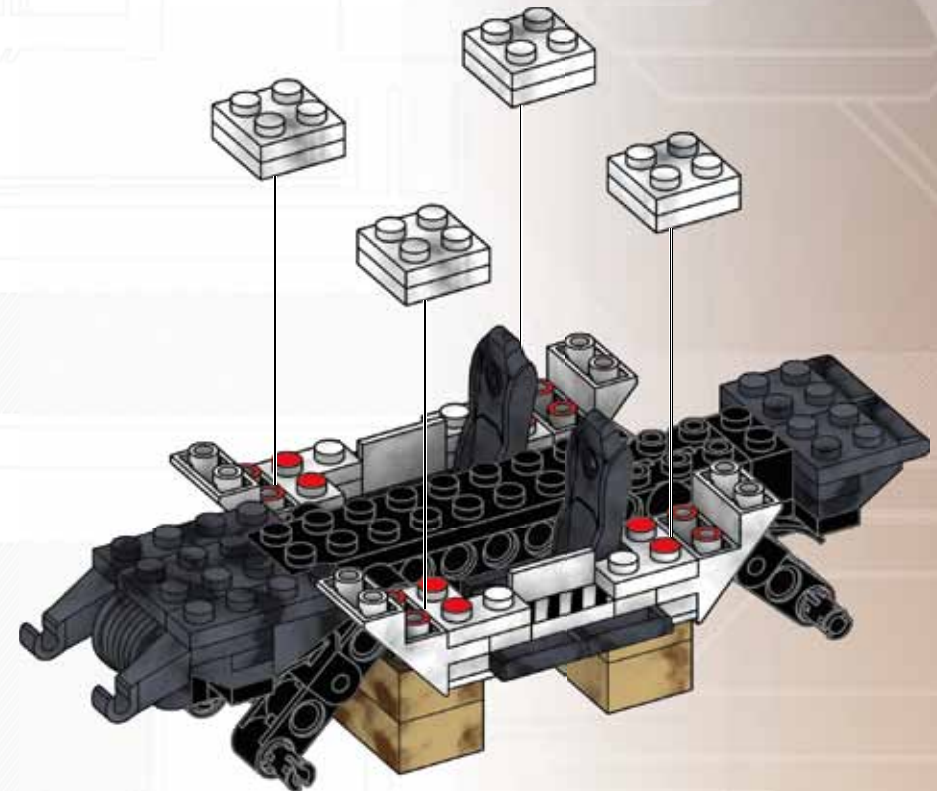
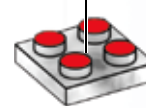

13



1X



1X



1X

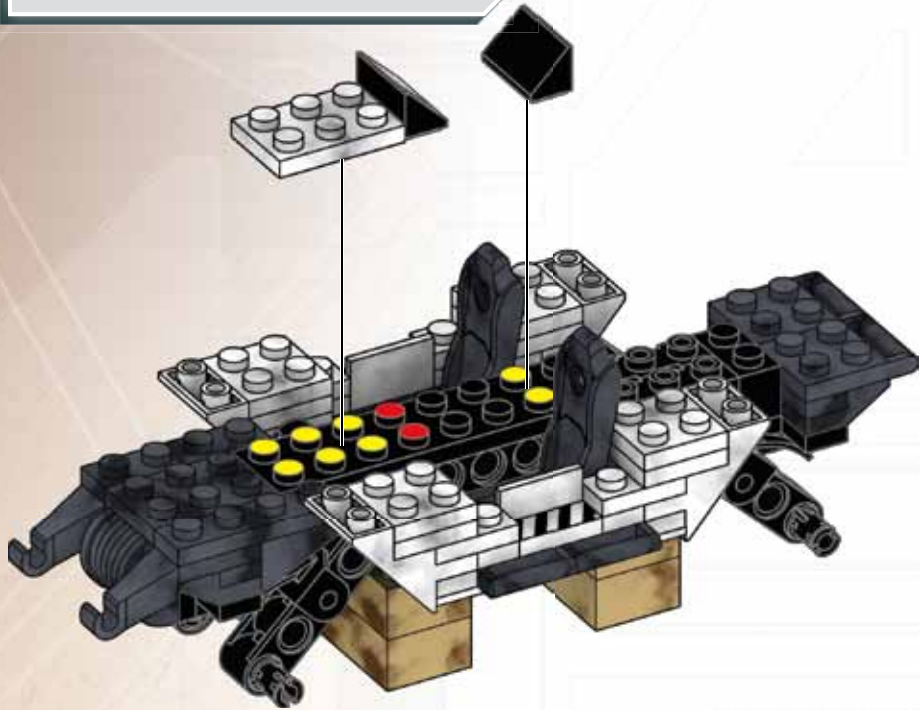

14



4X

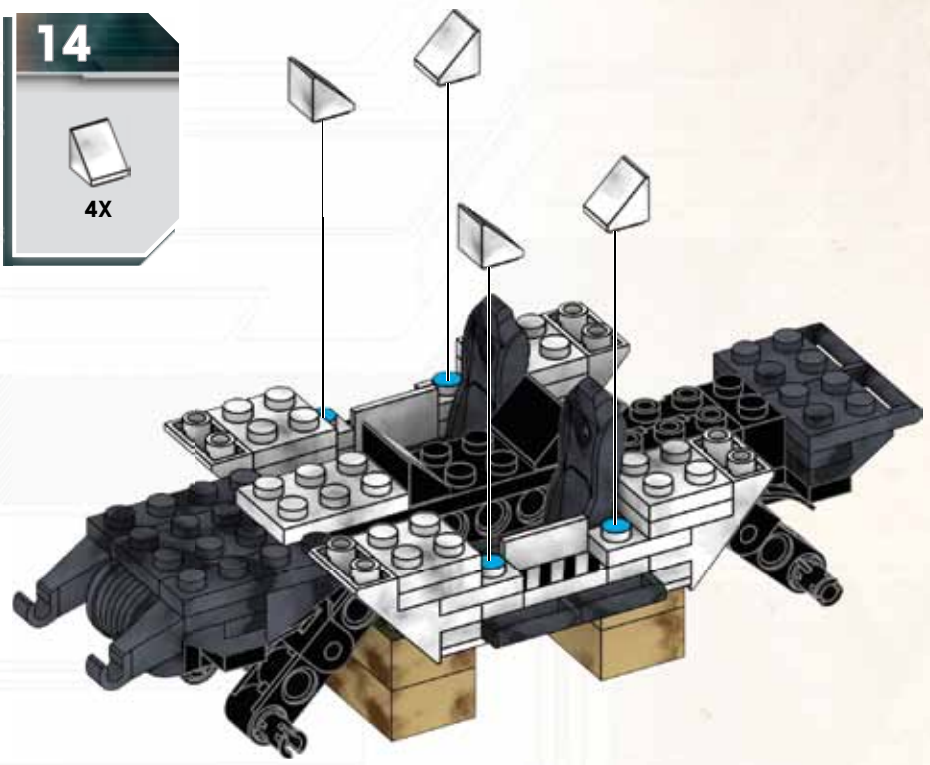

15



2X



2X



1X



1X



1X

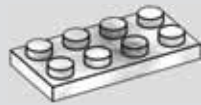

4X

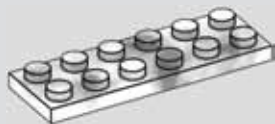

2X



1X

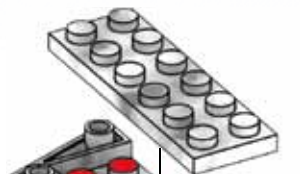

1

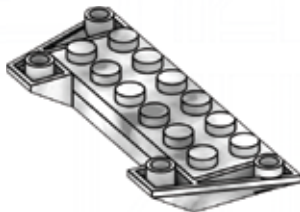

2



1

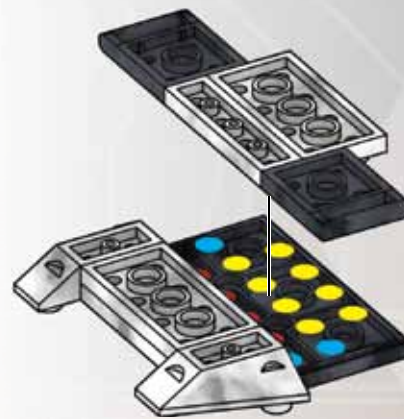

2

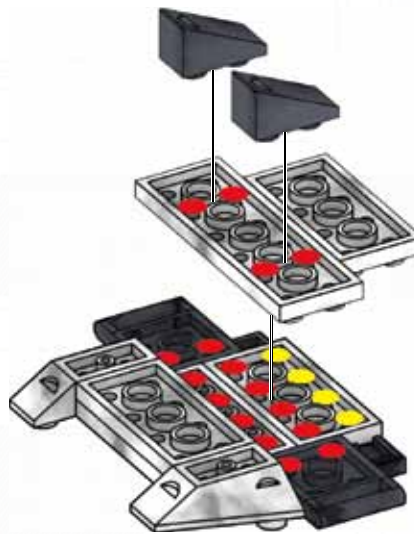
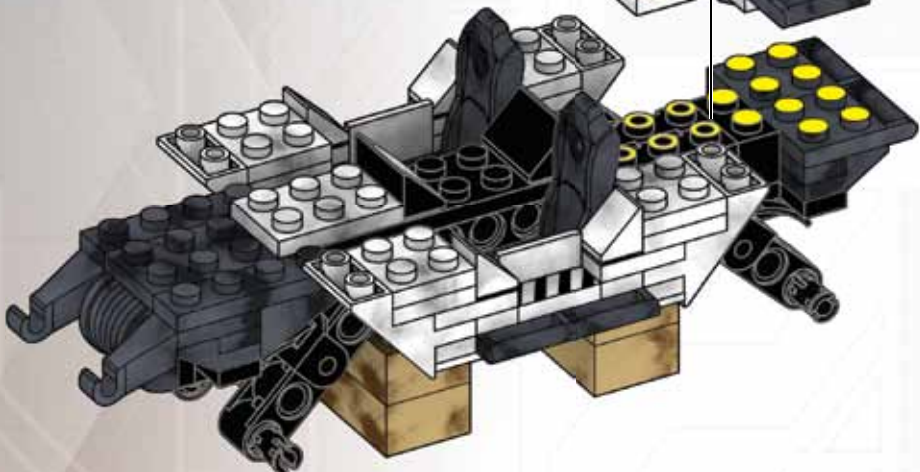
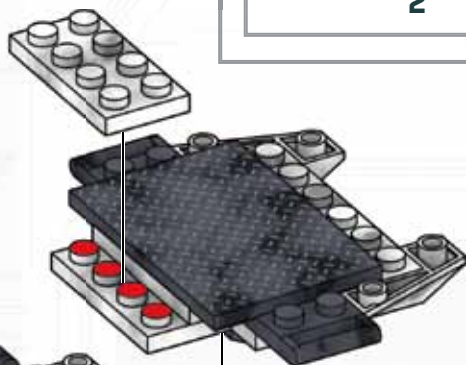

3

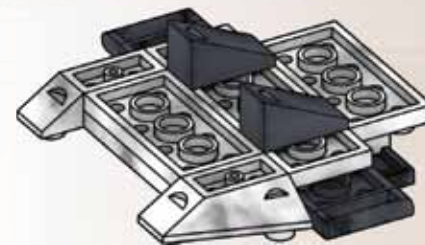

4

2X

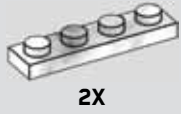

2X

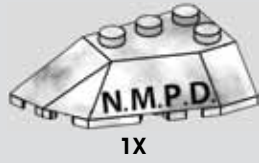

1X

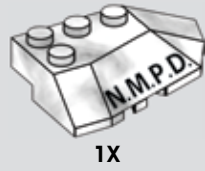

1X



1X



1X

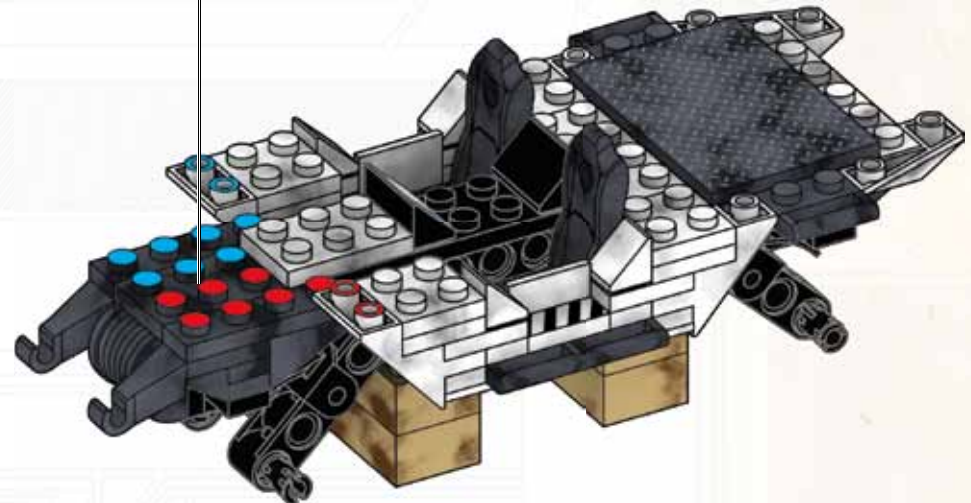
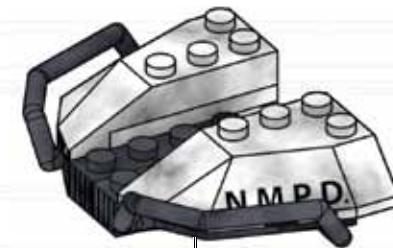
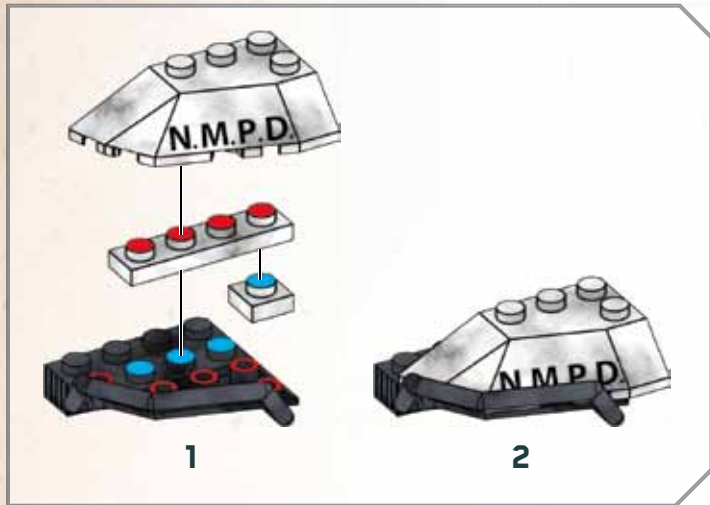
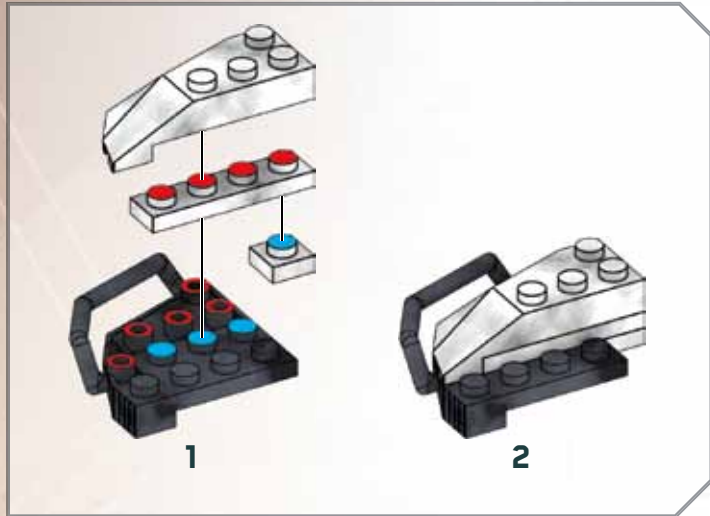



1X



1X



1X



1X



1X

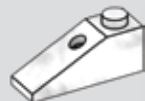

1X



1X



3X



1X

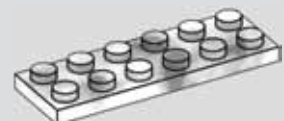

1X

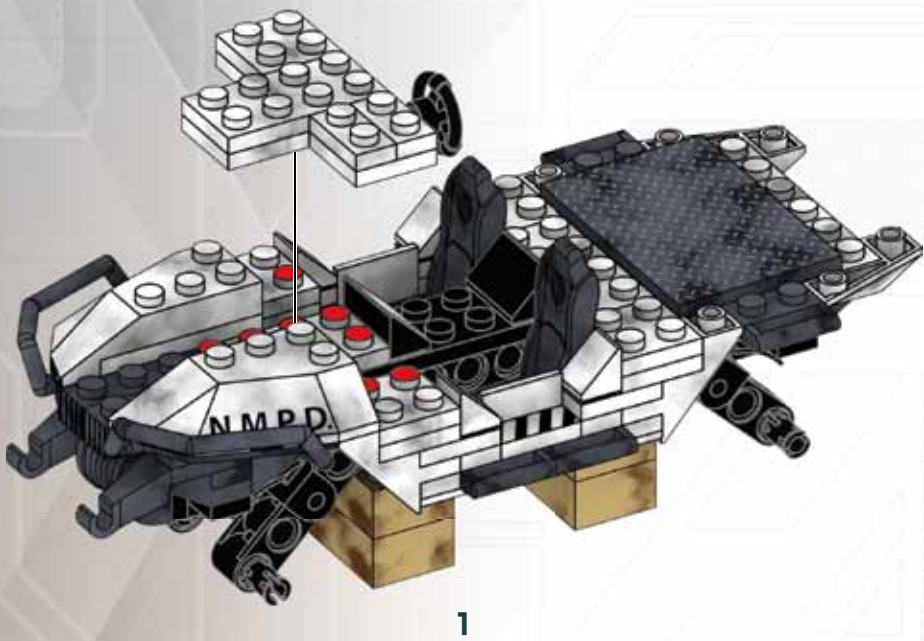
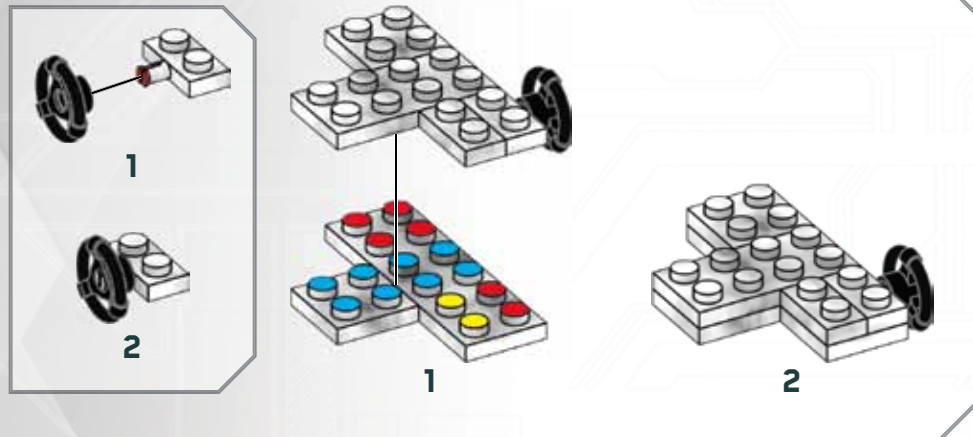

1

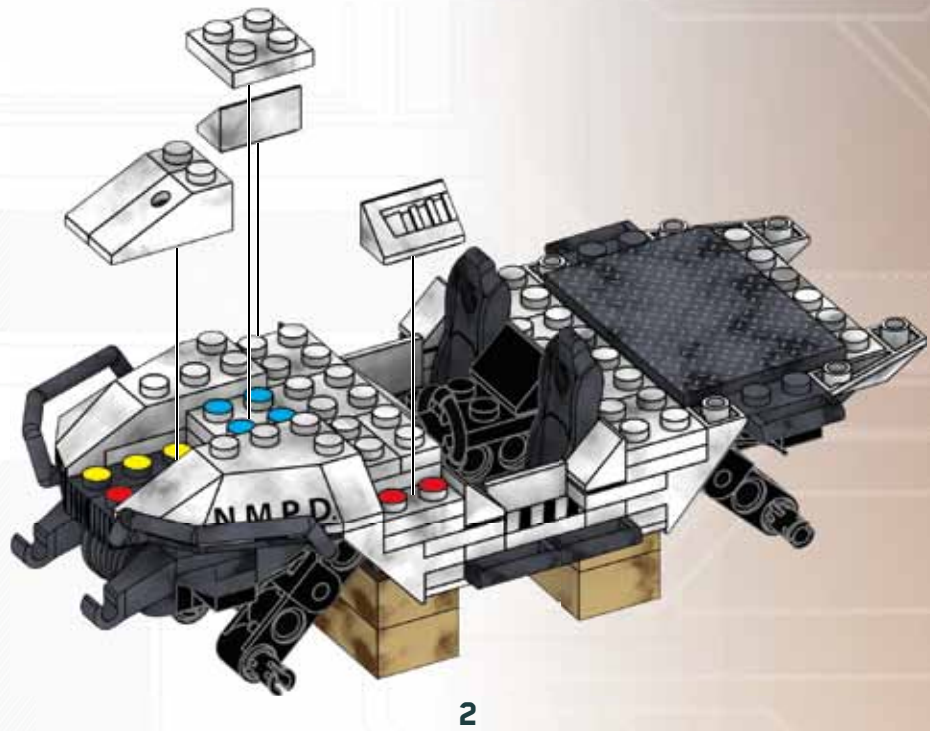

2





1X



1X



1X



19



1X



1X



1X



20



1X



1X



1X



21



1X



1X



1X



1X

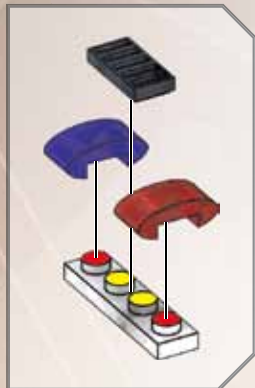

1



2

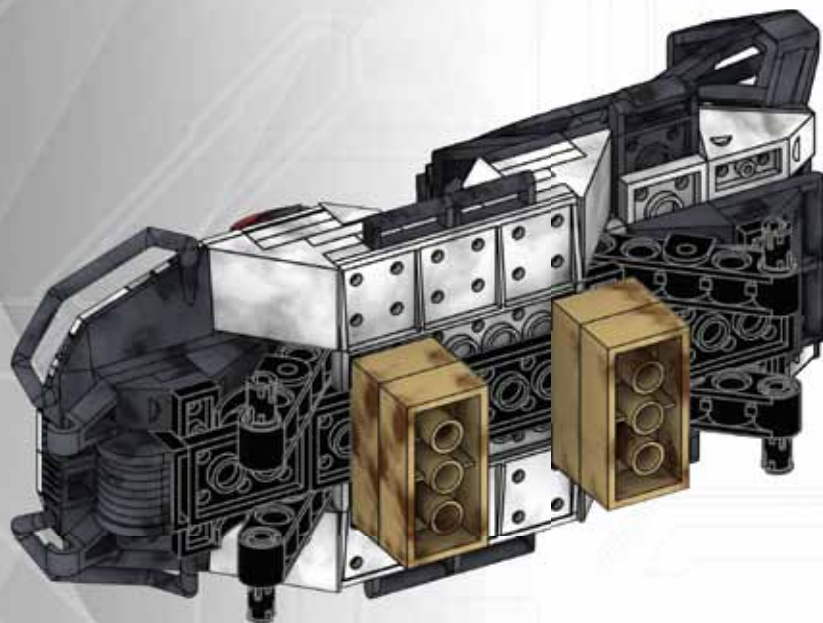

1



Remove temporary pieces  
 Retirez les pièces temporaires  
 Retirar piezas temporales  
 Remova peças temporárias  
 Rimuovere i pezzi temporanei  
 Vorübergehende Teile entfernen  
 Usunąć elementy tymczasowe.  
 Verwijder tijdelijke bouwstenen  
 Снимите временные детали  
 Fjern midlertidige stykker.  
 Ta bort temporära delar  
 Fjern midlertidige deler  
 Poista väliaikaiset osat  
 Αφαίρεση προσωρινών κομματιών  
 انزع القطع المؤقتة  
 移除临时件  
 暫定ピースを外してください

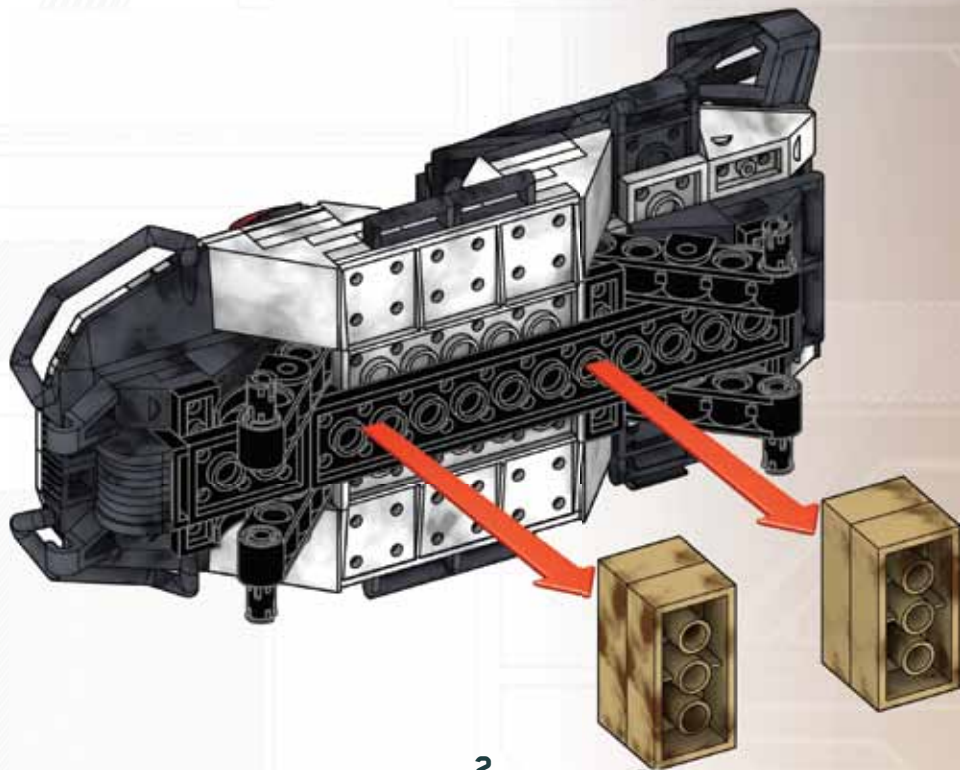

2

23



2x



2x



1



2





**INTERCHANGEABLE ARMOR SYSTEM**  
**SYSTÈME D'ARMURE INTERCHANGEABLE**  
**SISTEMA DE ARMADURA INTERCAMBIABLE**  
**SISTEMA DE ARMADURA INTERCAMBIÁVEL**



**SISTEMA DI ARMATURA INTERCAMBIABILE**  
**AUSTAUSCHBARE PANZERUNGSSYSTEM**  
**ZAMIENNY SYSTEM UZBROJENIA**  
**WERWISSELBOAR WAPENRUSTINGSSYSTEM**  
**СМЕННАЯ СИСТЕМА БРОНИ**



**NMPD Officer**  
 Officier du NMPD  
 Oficial del DPNM  
 Oficial do NMPD  
 Agente NMPD  
 NMPD-Offizier  
 Oficer NMPD  
 NMPD-officier  
 Офицер отделения  
 полиции Нью-Момбасы



**Covenant Brute Jump Pack**  
 Brute avec propulseur dorsal  
 Paquete de lanzamiento  
 de Covenant Brute  
 Covenant Brute Sprungpaket  
 Covenant Brute met jetpack  
 Mochila de Salto  
 Covenant Brute  
 Bruut Springrugzak  
 Десантный набор



**NMPD Trooper**  
 Combattant du NMPD  
 Soldado del DPNM  
 Soldado do NMPD  
 Poliziotto NMPD  
 NMPD-Trooper  
 Żołnierz NMPD  
 NMPD-soldaat  
 Рядовой отделения  
 полиции Нью-Момбасы



**Covenant Brute Stalker**  
 Espion Brute du Covenant  
 Acosador Brute de Covenant  
 Covenant Brute Cacciatore  
 Perseguidor Brute Covenant  
 Следопыт Brute

**COLLECT THEM ALL!**  
**COLLECTIONNEZ-LES TOUS!**  
**COLECCIONALOS TODOS**  
**COLEZIONE TODOS ELES**  
**COLLEZIONALI TUTTI**  
**SAMMELE SIE ALLE!**  
**ZBIERZ JE WSZYSTKIE!**  
**VERZAMEL ZE ALLEMAAL!**  
**СОБРАТЬ ИХ ВСЕХ**

**HALO.MEGABLOKS.COM**

CNG64



CNG68



Each sold separately and subject to availability. / Tous vendus séparément. Certains produits peuvent ne pas être commercialisés. / Se venden por separado y están sujetos a disponibilidad. / Vendidos em separado e sujeitos à disponibilidade. / Ognuno in vendita separatamente secondo disponibilità. / Alle Artikel separat erhältlich. Einige Artikel werden nicht in allen Ländern vertrieben. / Sprzedawane oddzielnie w zależności od dostępności. / Per stuk verkrijgbaar en niet overal leverbaar. / Каждый продукт продается отдельно, в зависимости от наличия. / Sælges separat og så længe lager haves. / Alla delar säljs separat så långt lagret räcker. / Hver leke selges separat så langt lageret rekker. / Jokainen myydään erikseen, saatavuus voi vaihdella. / Το καθένα πωλείται ξεχωριστά και ανάλογα με τη διαθεσιμότητα. /

تباع كل منها على حدة وتخضع لتوفرها.  
 每件单独出售，并且视库存情况而定。  
 それぞれ在庫状況に従って個別に販売されます。