

**MEGA
CONSTRUX™**

WellieWishers™
American Girl®



**Easy to
build!
Construction
facile!
¡Constrúyelo
fácil!**

FFC47



Wellie wishers™



The WellieWishers are a sweet and silly group of girls who each have the same big, bright wish: to be a good friend. They have a pet bunny named Carrot. Can you guess his favorite snack?



Les WellieWishers sont des filles adorables et farfelues qui partagent toutes le même grand rêve : être une bonne amie. Elles ont un lapin de compagnie nommé Carotte. Peux-tu deviner sa collation favorite?



Las WellieWishers son un grupo de niñas tiernas y chistosas que comparten el mismo deseo: ser buenas amigas. Tienen un conejito llamado Zanahoria. ¿Puedes adivinar cuál es su comida favorita?



FUN & FRIENDLY BUILDING TIPS

DES TRUCS DE CONSTRUCTION AMUSANTS

CONSEJOS DE CONSTRUCCIÓN DIVERTIDOS!



Separate the bricks by color.
Sépare les briques par couleurs.
Separa las piezas por colores.

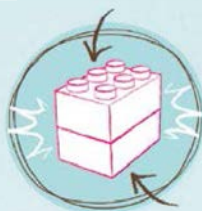

Press down firmly on the bricks to secure them.
Appuie fermement sur les briques
pour bien les emboîter.
Empuja las piezas con fuerza para que
queden bien encajadas.

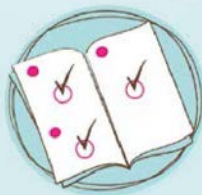

Be sure each step is complete before moving on.
Assure-toi que chaque étape est finie
avant de passer à la suivante.
Realizar el montaje del juguete paso a paso,
siguiendo atentamente las instrucciones.



Read more about the WellieWishers
in their books from American Girl!
Découvre encore plus sur les WellieWishers
dans leurs livres d'American Girl!
¡Lee más sobre las WellieWishers
en sus libros de American Girl!



1



1x



1x



1x

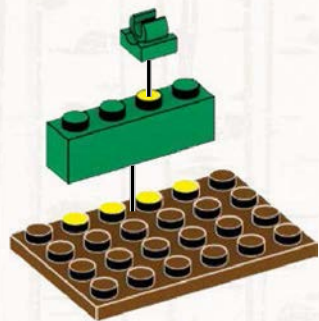

1



2

2



3x



1x

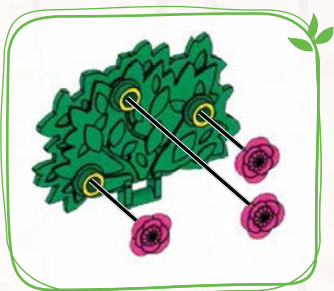

3



1x



1x



4



1x



1x



1



2



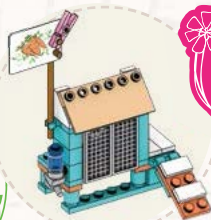

5



2x



1x



1x



2x



2x



2x



2x

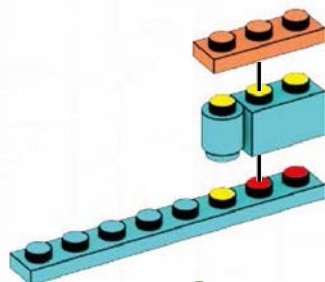

x2

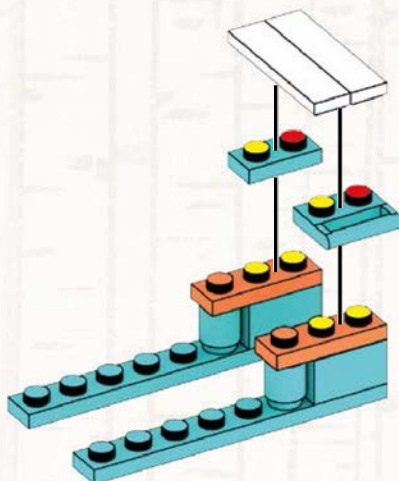

6



6



2x



1x

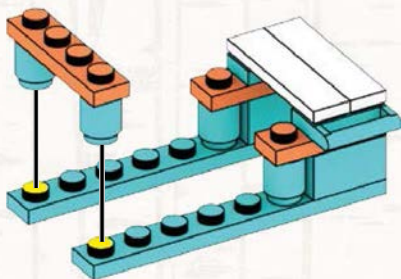
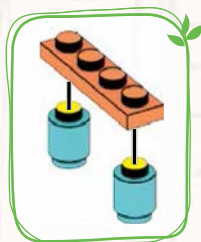

Great job!
Excellent travail!
¡Bien hecho!

7



1x

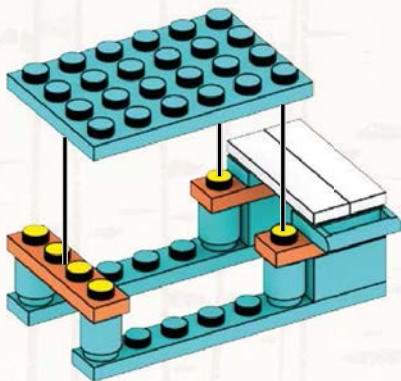

8



2x



1x



1x

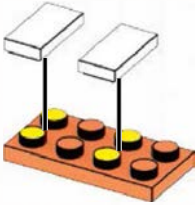

1

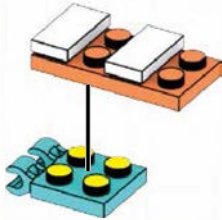

2

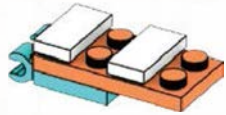

3

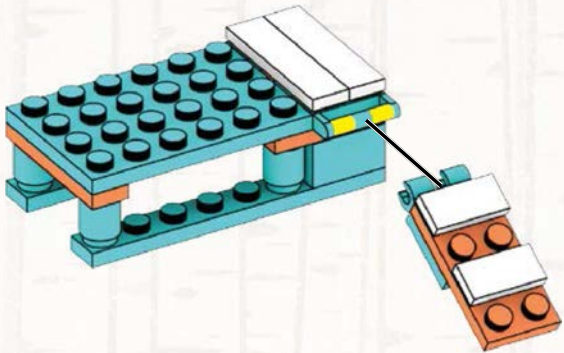

8



9



1x



1x

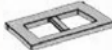

2x



1x

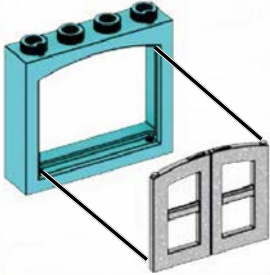

1



2

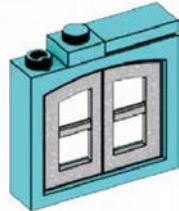

3

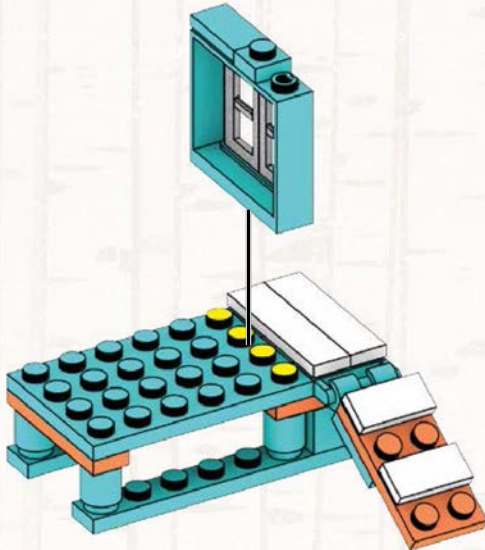

10



1x



2x



1x

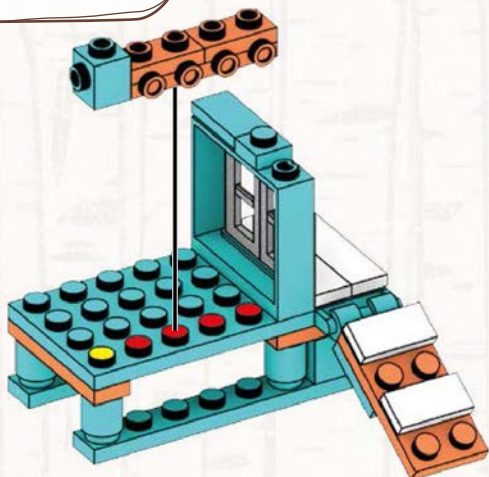
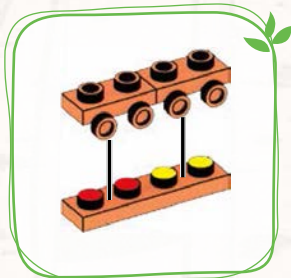

11



1x



2x

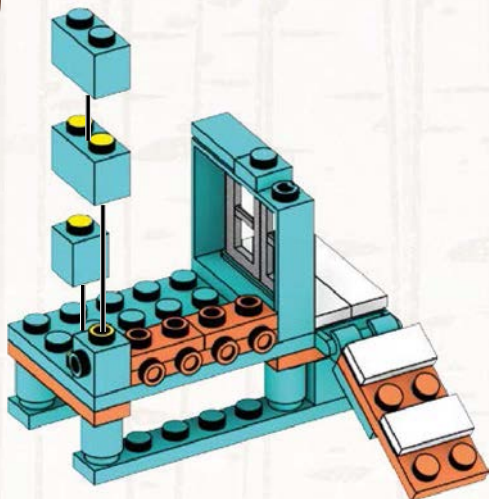

12



1x



1x

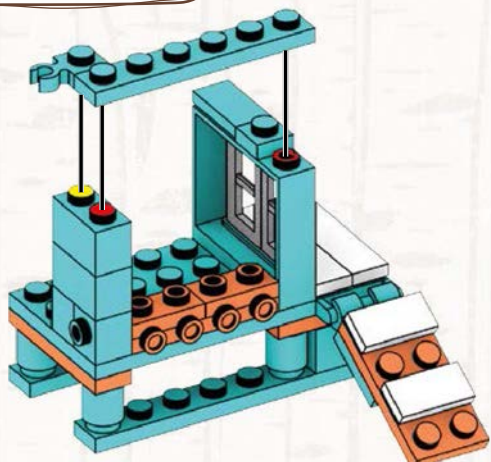

13



2x

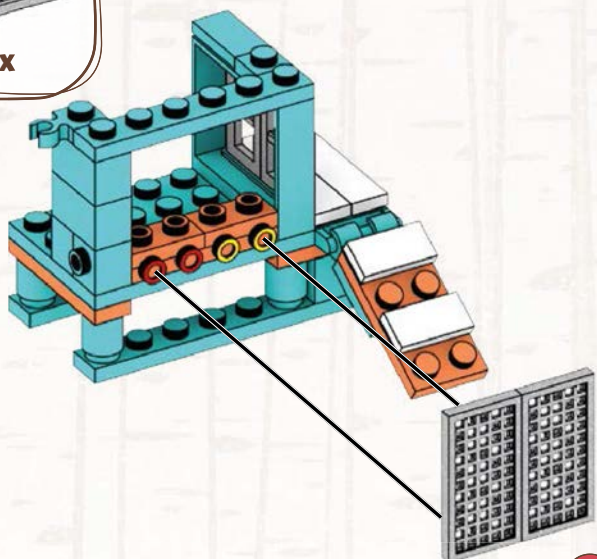

14



2x

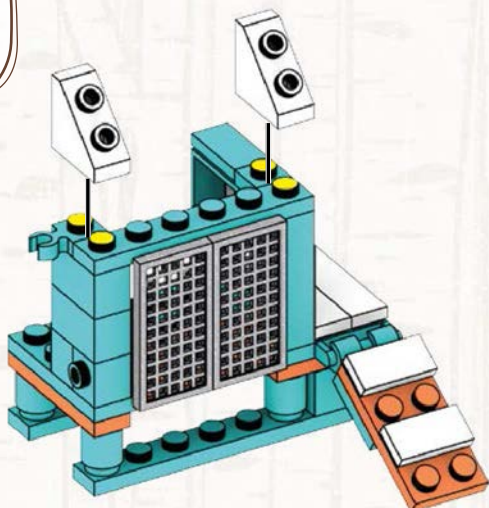

15



1x

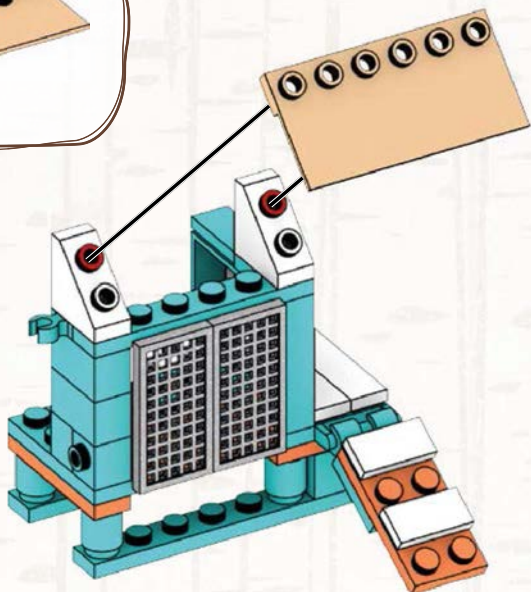

16



1x



2x



1x



1x

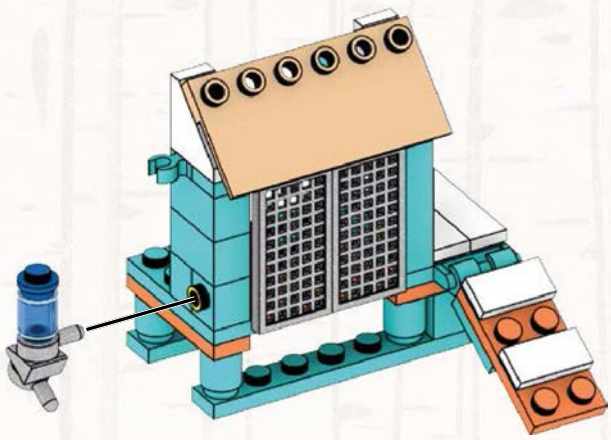
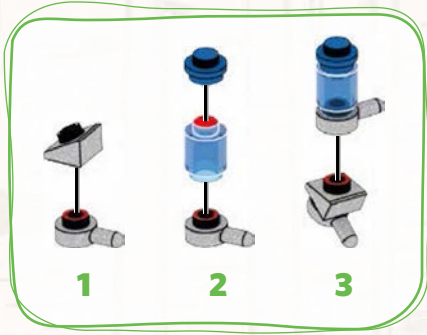

17



1x



1x



1x



1x

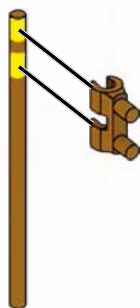

1

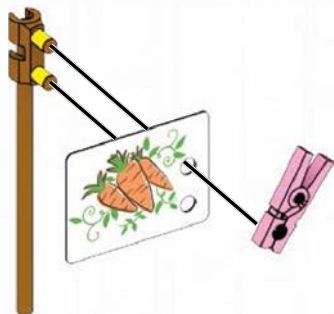

2

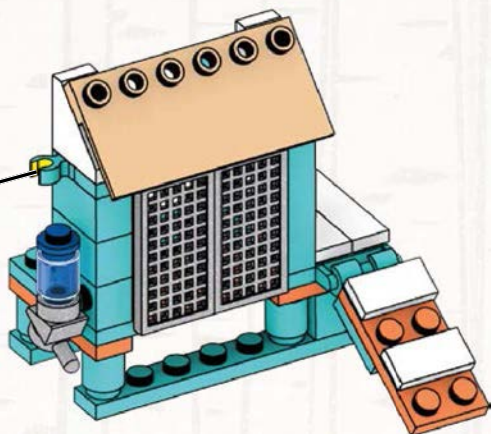

14





You did it!
Tu as réussi!
¡Lo hiciste!

Color it in
Coloriez l'image
Coloréalo

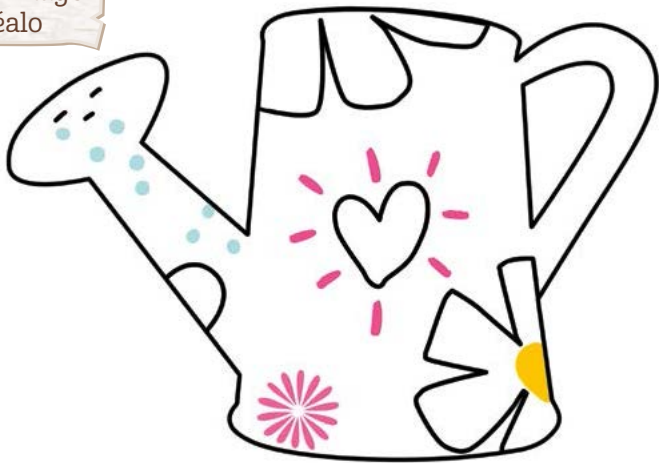

Connect the Dots
Reliez les points
Conecta los puntos!

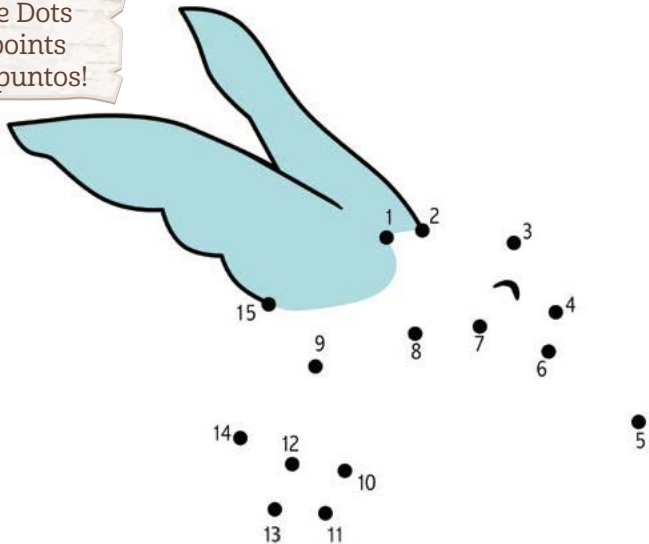

Each sold separately and subject to availability. / Tous vendus séparément. Certains produits peuvent ne pas être commercialisés.
 / Se venden por separado y están sujetos a disponibilidad. / Vendidos em separado e sujeitos à disponibilidade. / Ognuno
 in vendita separatamente secondo disponibilità. / Alle Artikel separat erhältlich. Einige Artikel werden nicht in allen Ländern
 vertrieben. / Sprzedawane oddzielnie w zależności od dostępności. / Per stuk verkrijgbaar en niet overal leverbaar. / Каждый
 продукт продается отдельно, в зависимости от наличия. / Sælges separat og så længe lager haves. / Alla delar säljs separat så
 långt lagret räcker. / Hver leke selges separat så langt lageret rekker. / Jokainen myydään erikseen, saatavuus voi vaihdella. / Το
 καθένα πωλείται ξεχωριστά και ανάλογα με τη διαθεσιμότητα. / Her biri ayrı ayrı ve stoklara bağlı olarak satılır. / 每件单独出售，
 并且视库存情况而定。 / それぞれ在庫状況によって個別に販売されます。 /
 تباع كل منها على حدة وتخضع لتوفرها.







Patent pending.
Brevet en instance.

© 2016 American Girl. All rights reserved.
Todos los derechos reservados. Tous droits réservés.
All American Girl marks are trademarks of American Girl. Marcas registradas utilizadas bajo licencia.
American Girl ainsi que les marques et designs y afférents appartiennent à American Girl.

⚠️ **WARNING:**

CHOKING HAZARD. - Small parts.
Not for children under 3 years.

⚠️ **ATTENTION:**

DANGER D'ÉTOUFFEMENT. - Présence de petits éléments.
Ne convient pas aux enfants de moins de 3 ans.

⚠️

警告:
窒息危険. 包含小部件
不适合3岁以下的孩兒玩。

⚠️

警告:
のどに つまる危険 小さな部品が含まれています
3歳以下の子供には与えないで下さい。

تحذير :

خطر الاختناق - قطع صغيرة.

غير صالحة للاطفال أقل من 3 سنوات.



ADVERTENCIA: Peligro de asfixia. Juguete no recomendado para menores de 3 años, porque contiene piezas pequeñas que podrían provocar asfixia en caso de ser ingeridas o inhaladas por el/la niño/a.

ATENÇÃO: Não recomendável para crianças com menos de 36 meses. Contém peças pequenas capazes de criar risco de asfixia.

AVVERTENZA: Contiene pezzi di piccole dimensioni.

ACHTUNG: Kleine Teile.

OSTRZEŻENIE: Małe części

WAARSCHUWING: Kleine onderdelen

ПРЕДУПРЕЖДЕНИЕ: Мелкие детали

ADVARSEL: Små dele.

VARNING: Smådelar

ADVARSEL: Små deler.

VAROITUS: Pieniä osia

ПОСОВИТ: Непопільвовати млякі кошти.

UYARI: BÜĞÜMLÜ TEHLİKESİ - Küçük Parçalar (çeritir.) 3 yaşından küçük çocuklar için uygun değildir.

Please read these instructions carefully before first use and keep them for future reference.

Il est recommandé de lire attentivement ce feuillet avant la première utilisation et de le conserver pour référence future.

Leer estas instrucciones cuidadosamente antes de la primera utilización y guardarlas para referencia futura.

Leia as instruções antes do primeiro uso e guarde-as para futura referência.

Leggere le istruzioni prima di cominciare ad usare il gioco e conservarle per riferimento futuro.

Die Gebrauchsanleitung bitte durchlesen und aufbewahren.

Proszę uważnie przeczytać instrukcję obsługi przed pierwszym użyciem, a następnie zachować ją na przyszłość.

Wij raden u aan deze handleiding zorgvuldig te lezen en te bewaren voor eventuele raadpleging op een later tijdstip.

Внимательно прочитайте инструкцию перед первым использованием и сохраните ее для дальнейшего использования.

Vær venlig at læse disse instruktioner omhyggeligt inden brugstagen og opbevar dem til fremtidig brug.

Läs noggrant igenom dessa instruktioner innan du använder produkten för första gången och spara dem för ev. framtida frågor.

Les disse instruksjonene nøye før første gangs bruk, og ta vare på dem for fremtidig oppsagd.

Lue nämä ohjeet huolellisesti ennen ensimmäistä käyttöä ja säilytä ne myöhempää tarvetta varten.

Диагносте попроси́те нас обьяснѣт прав а́нто оти́х игрушк (заключи́те в себѣ бу́дущее) ава́ризи.

Ilk kullannadan önce talmanlan dikkaitece okumamanız ve bu bilgilere ilerde tekrar bakabileceğiniz saklamamanız öneririz.

第一次使用前，請仔細閱讀本說明書并保留以為將來參考。

初めてご使用になる前に、この説明書をよくお読みください。また、本書は将来いつで

も参照できるように保管してください。

يجب قراءة هذه التعليمات بحذارة قبل الاستخدام والاحتفاظ بها للمرجعة مستقبلاً.



MEGA CONSTRUX™

Build Beyond™

Au-delà de la
construction!

¡Construye sin límites!

Mais do que Construção!

Costruisci oltre ogni limite!

Es gibt keine Grenzen!

Więcej niż budowanie!

Meer dan alleen bouwen!

Больше, чем конструктор!

Χτίσε έναν ολόκληρο κόσμο!

Hayallerini İnşa Et!

لبنی .. وأكثراً!

©2016, MEGA Brands Inc. & ™ MEGA Brands Inc.
CONSTRUX™ is owned by Mattel and used under
license. CONSTRUX™ appartient à Mattel et est
utilisée sous licence.
Printed in China AD-FFC47-01



play.megaconstrux.com

