





LEGO.com/sustainable-packaging

GESTECK ZUM AUSSTELLEN UND AUFHÄNGEN



☛ Du kannst dein vielseitig gestaltbares Modell auf einem Tisch aufstellen oder an den beiden Aufhängern an einer Wand befestigen.



☛ Kombiniere zwei Sets zu einem vierspeichigen bzw. drei Sets zu einem sechsspeichigen Tischschmuck.



☛ **DISCLAIMER:**
Die Aufhänger tragen ein Set. Kombinierte Sets eignen sich nicht zum Aufhängen an der Wand.



LANGLEBIGER BLICKFANG FÜR KREATIVE

» Floristen, Innenarchitektinnen und Blumenfreunde in aller Welt lieben es, mit Trockenblumen kreativ zu werden. Getrocknete zarte Gräser und prächtige Blütenblätter lassen sich zu dekorativen Tischgestecken, Blumensträußen in Vasen oder kunstvollen Wandornamenten arrangieren, die Monate und mitunter sogar Jahre halten. Diese neueste Ergänzung zur LEGO® Botanik Kollektion wird dich hoffentlich dazu inspirieren, eigene prachtvolle Gestecke aus „LEGO Strohlblumen“ in warmen Herbstfarben zu kreieren.

Viel Spaß beim Bauen!



CHRIS McVEIGH
Designer bei der LEGO Gruppe

PFLANZEN AUS PFLANZEN

„Frische Blumen sind Geschenke der Natur. Sie dauerhaft zu erhalten und als Kunstwerke zu feiern, hat sehr viel Schönes. Wusstest du eigentlich, dass dein LEGO® Trockenblumengesteck auch Elemente aus Biokunststoff enthält?“

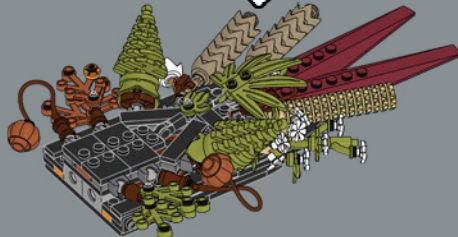
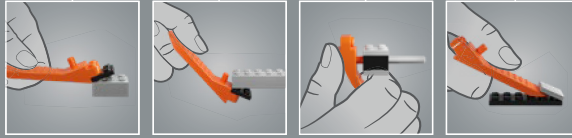
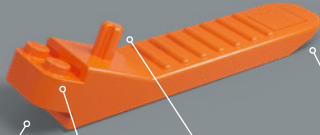

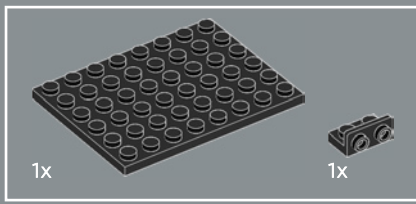

1

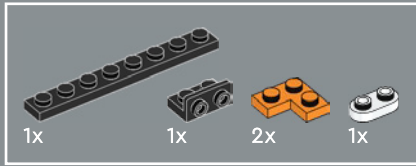
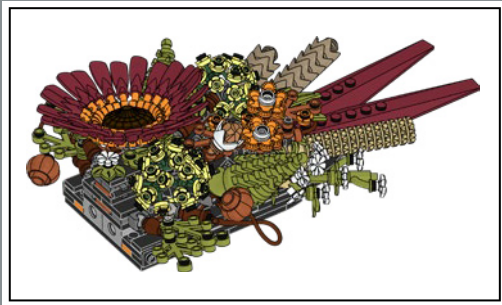
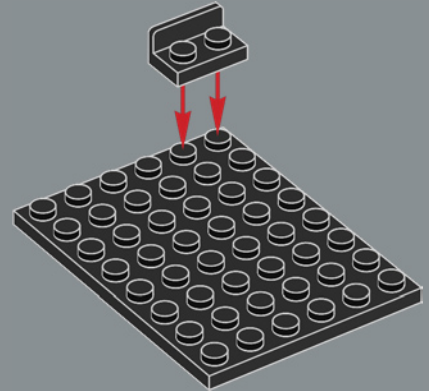

2

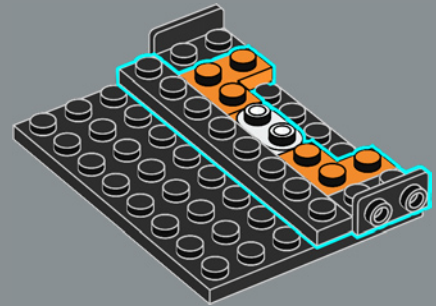

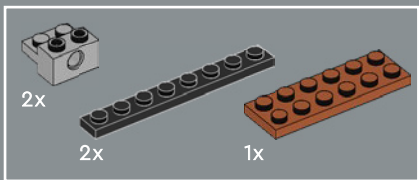

3

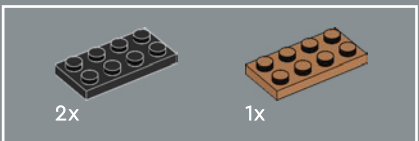
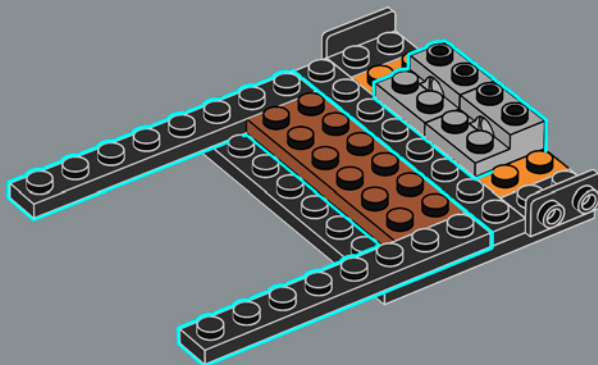

4

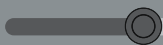
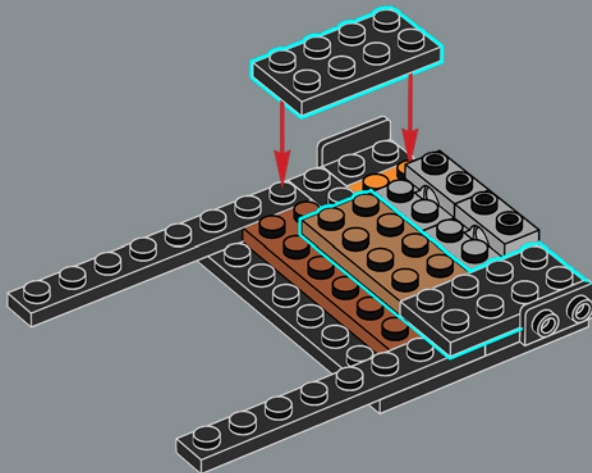

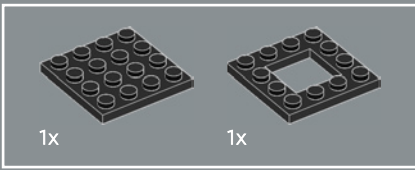

5

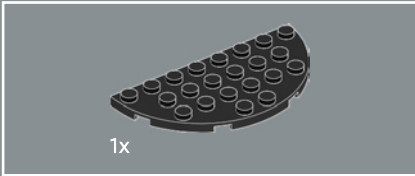
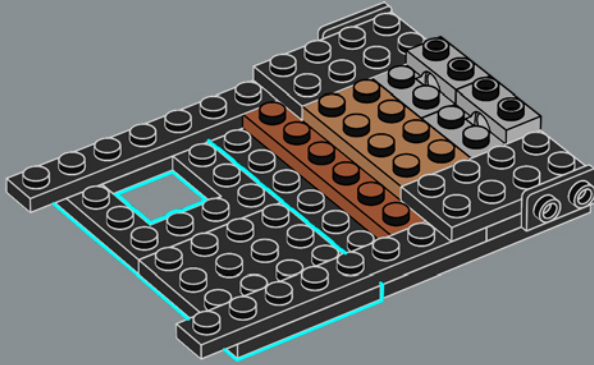

6

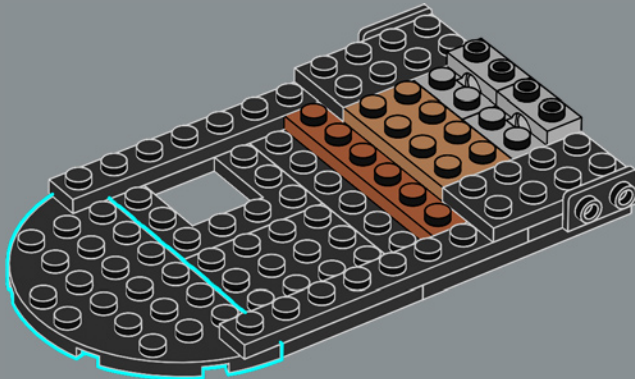

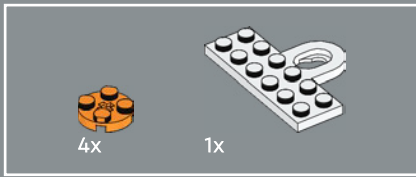

7



In beiden Seiten des Modells ist eine 2×6 Platte mit Aufhänger eingebaut, damit du das Gesteck an einer Wand befestigen kannst. Dieses spezielle Element kam erstmals in DOTS Produkten zum Tragen.

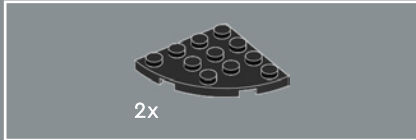
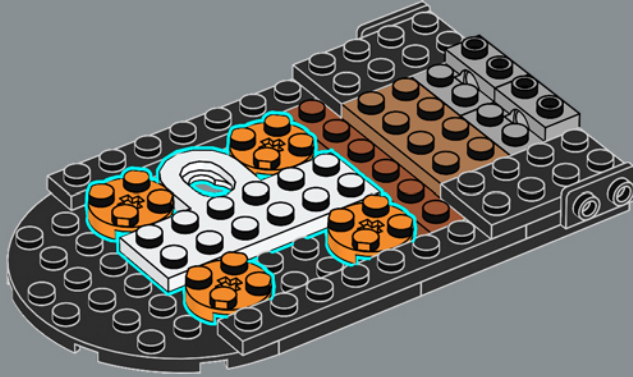

8

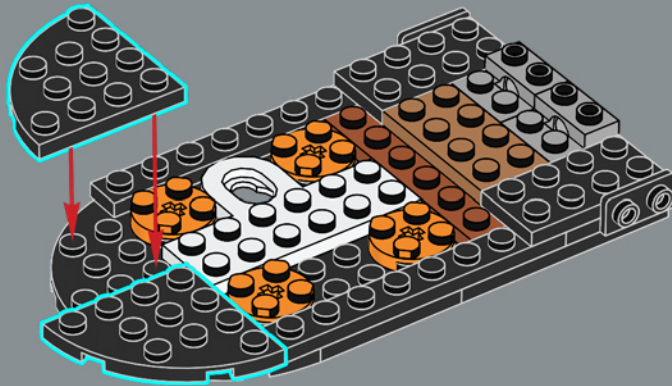

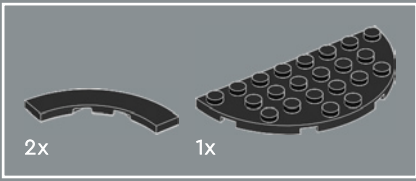

11

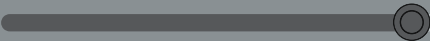
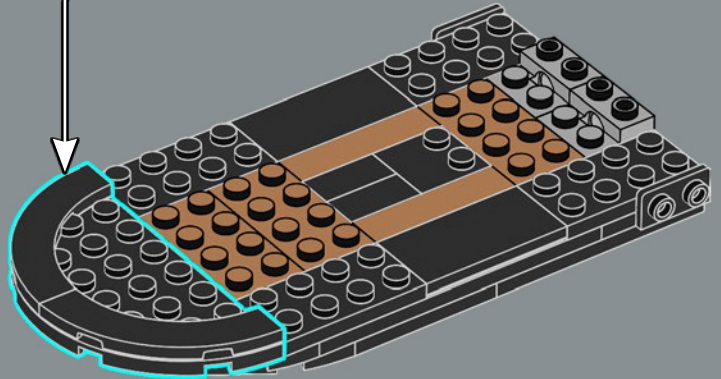
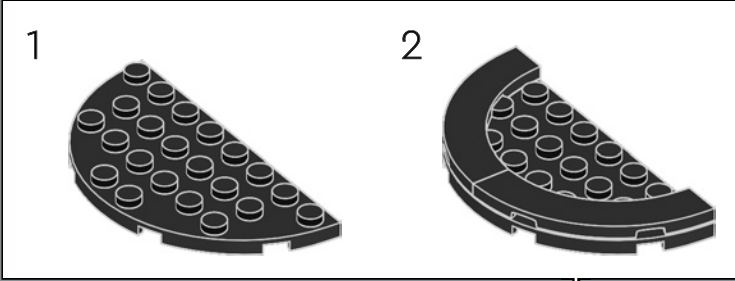

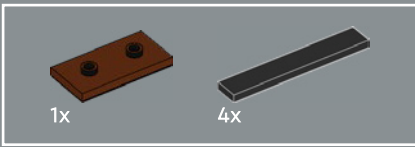

12

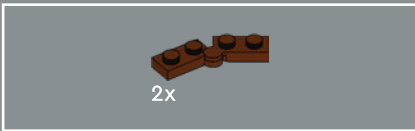
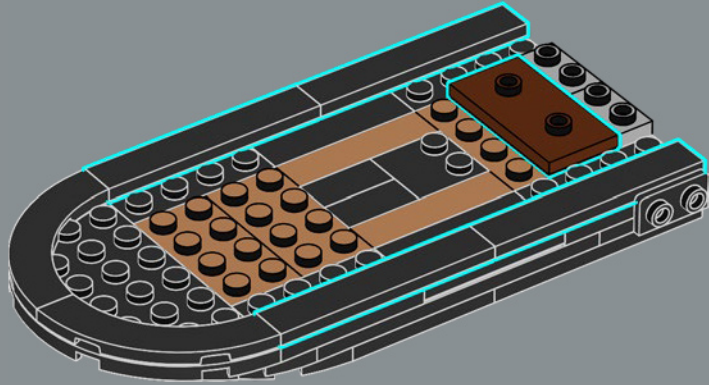

13

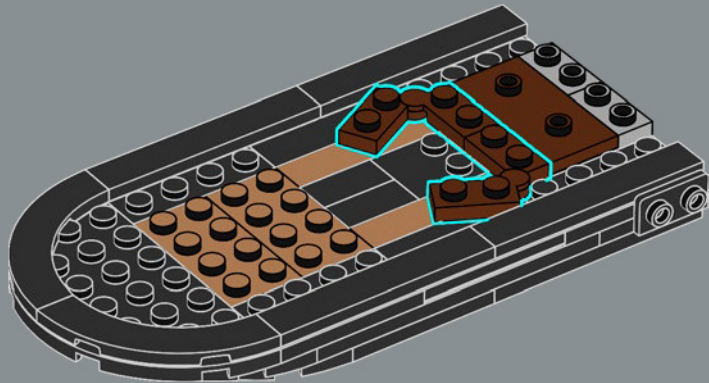

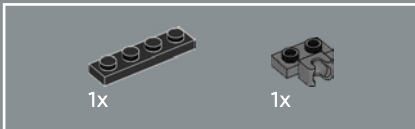
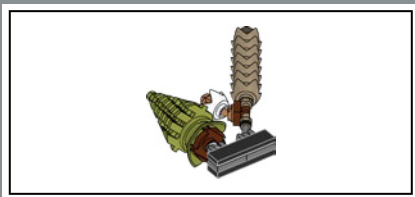

16

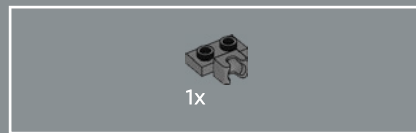
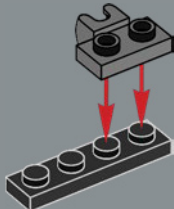

17

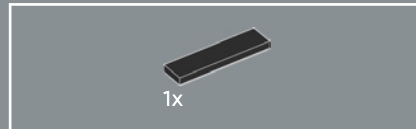
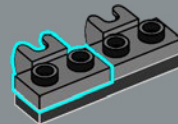

18

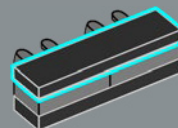



19

1



2



3

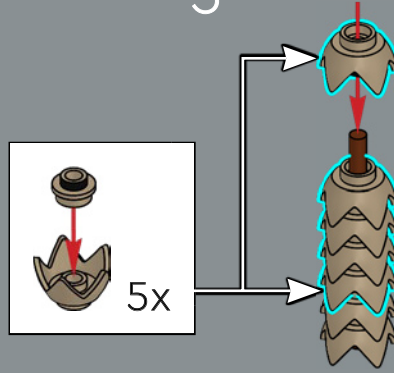

4





5

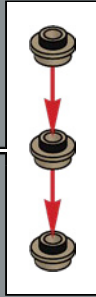

20

1



2



3

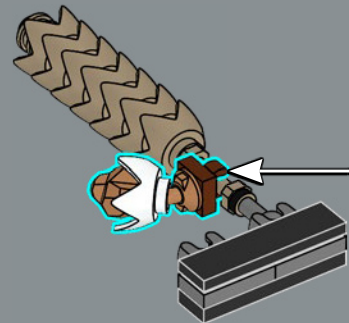
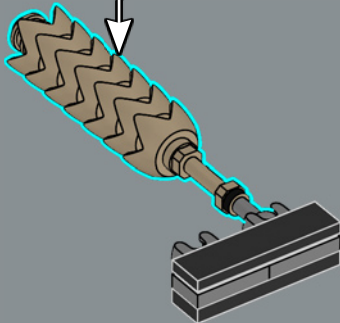

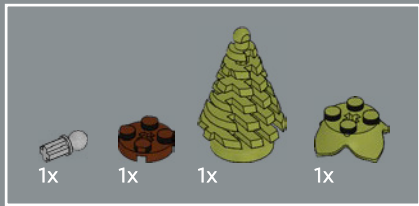

21

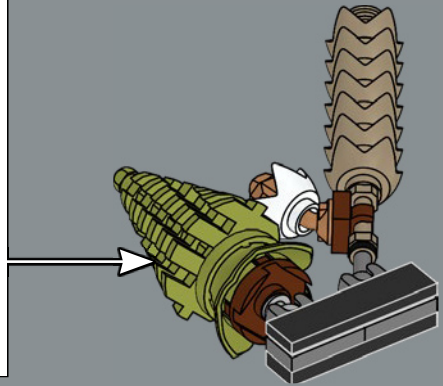
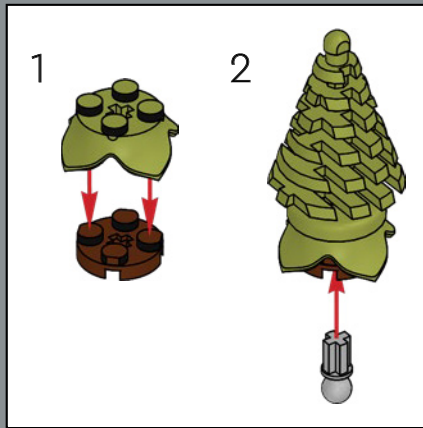

22

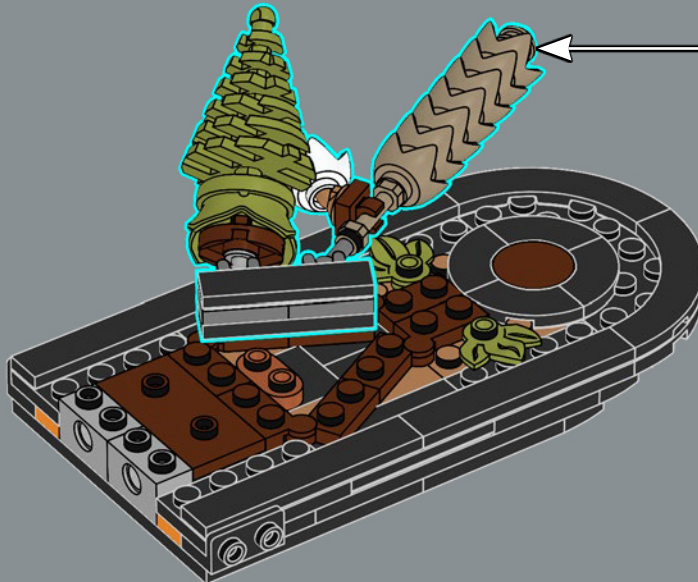

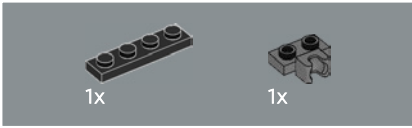
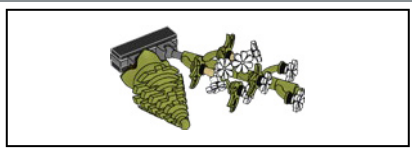

23

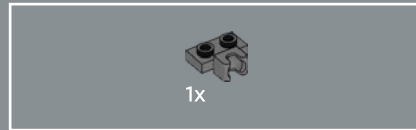
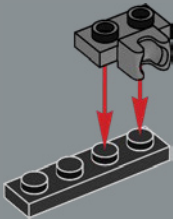

24

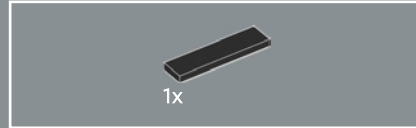
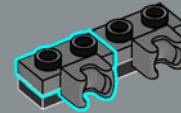

25

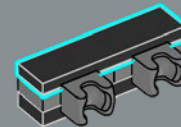

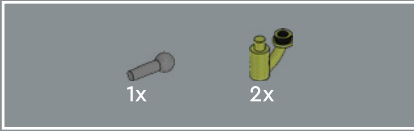

1x

2x

26



2x

27

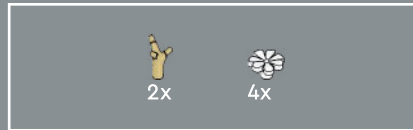
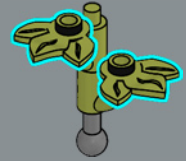

2x

4x

28

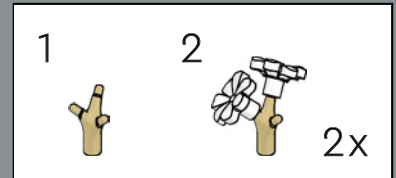

1

2

2x

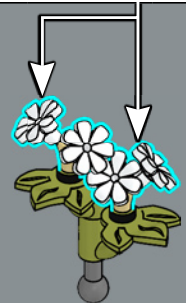



29

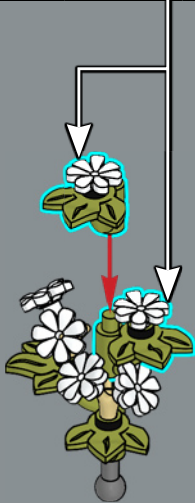
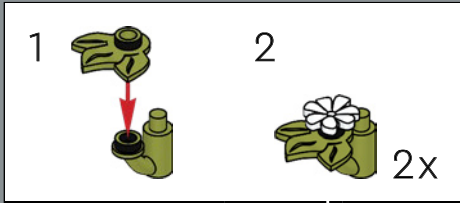

30

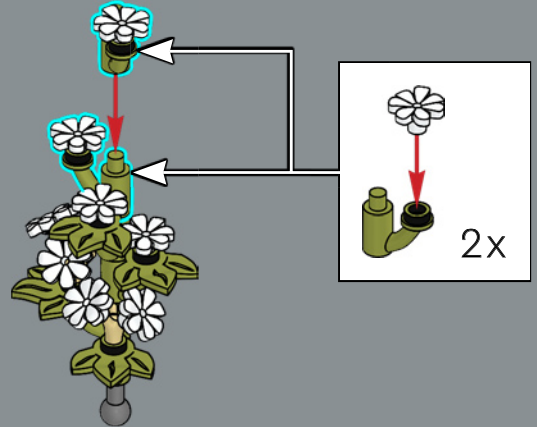

31

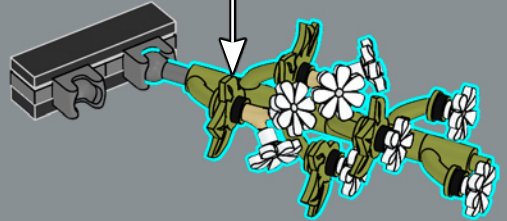

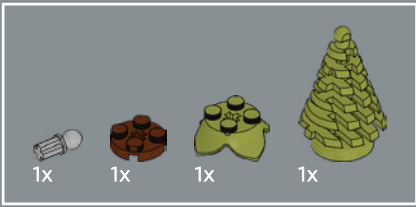

32

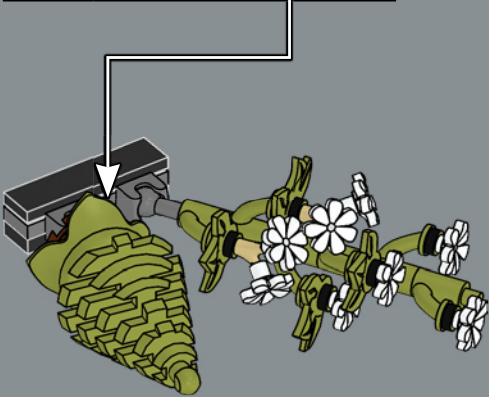
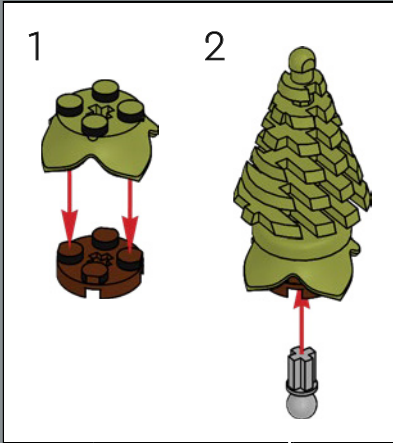

33

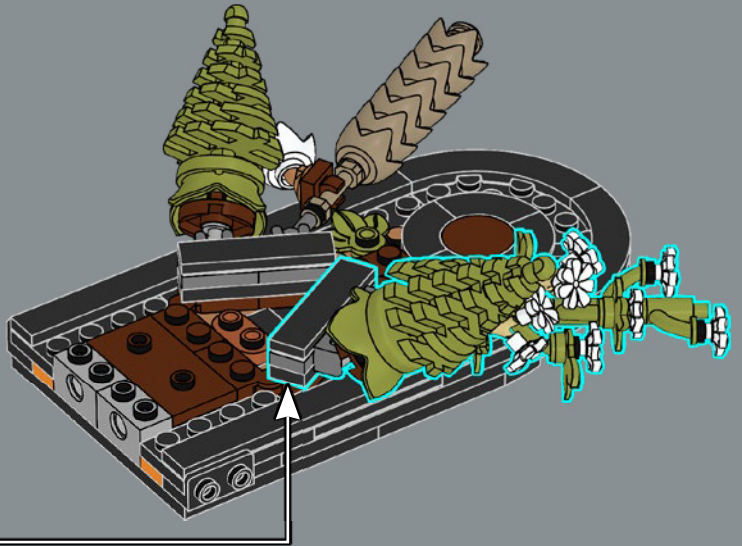

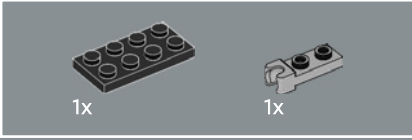
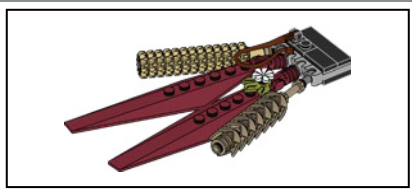

34

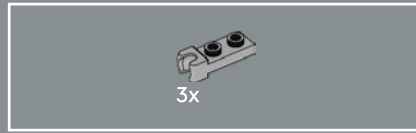
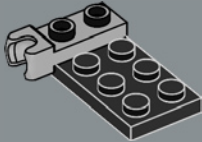

35

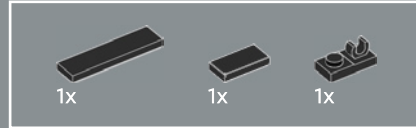
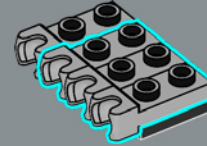

36

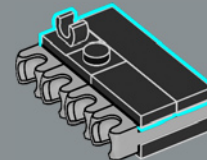

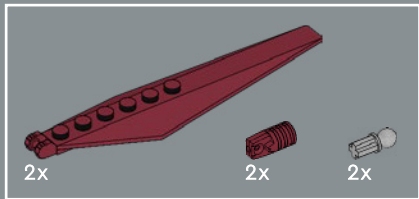

37

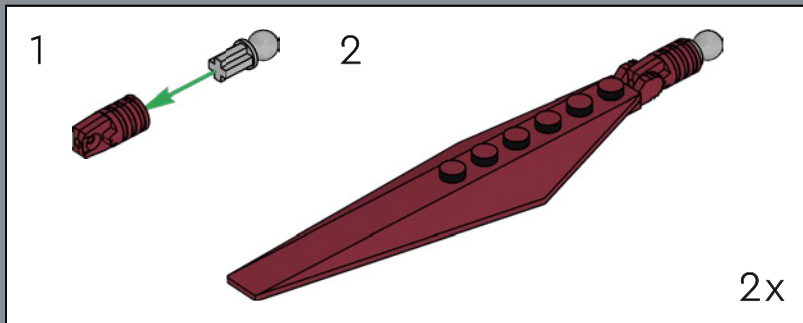

38

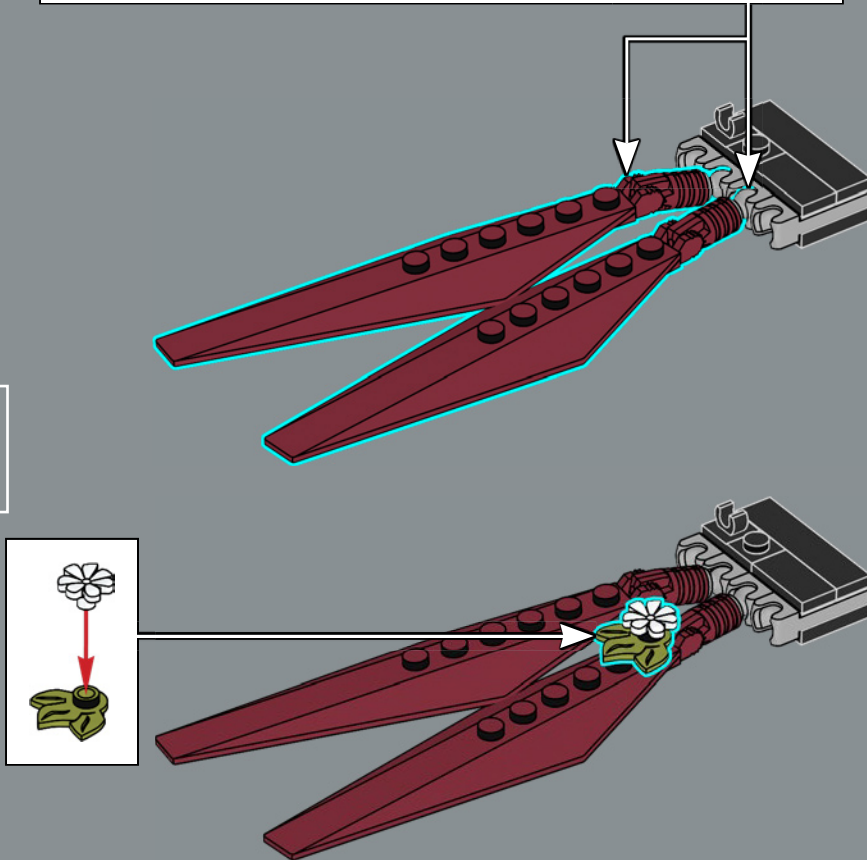

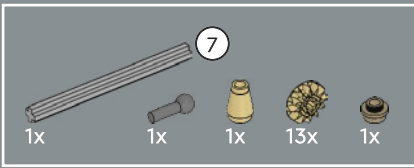

39

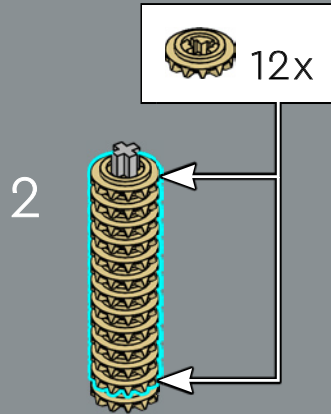

Die filigrane Struktur der Perlhirstängel wird mit aufeinandergesteckten konischen Zahnrädern nachgebildet.

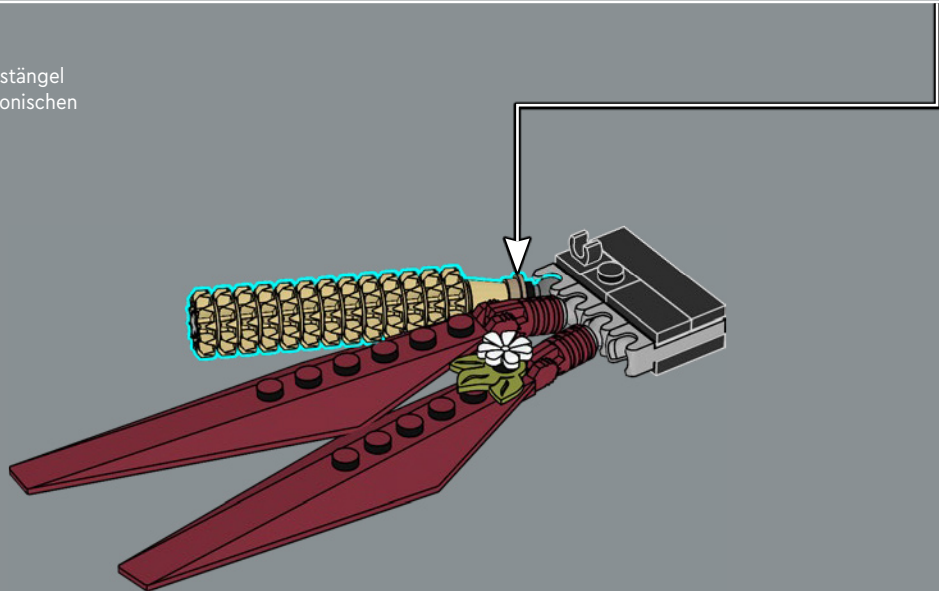



40

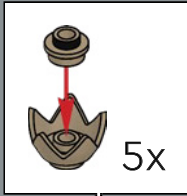
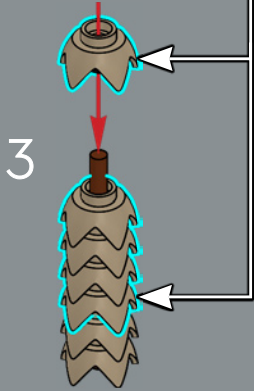
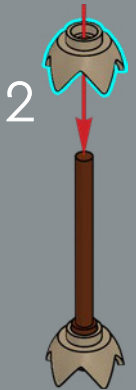
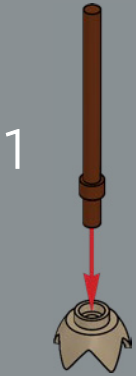

5

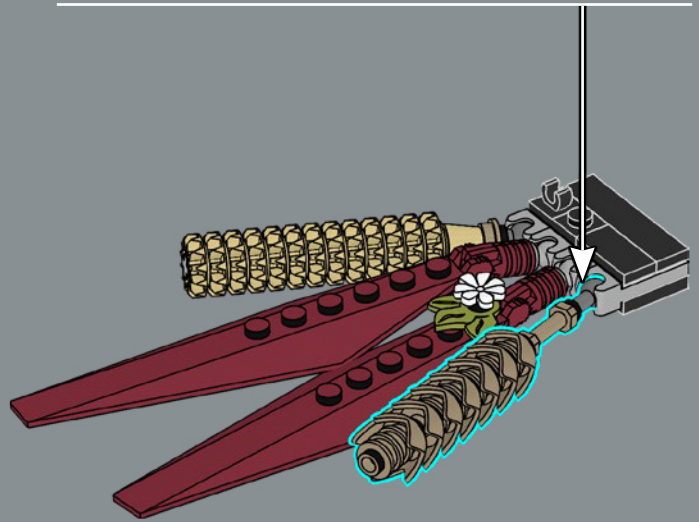
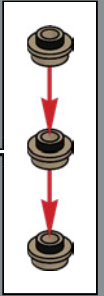

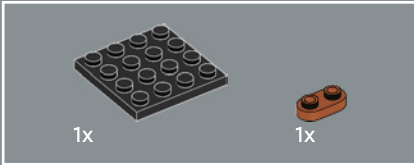
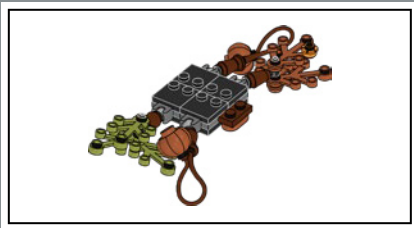

43

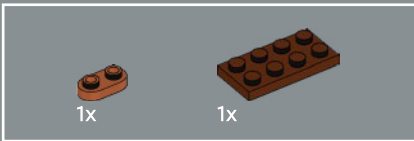
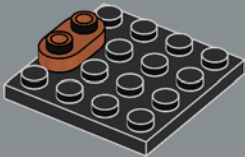

44

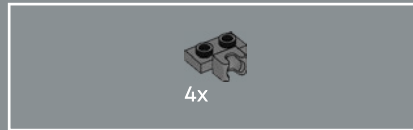
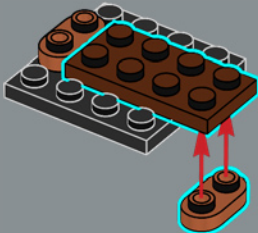

45

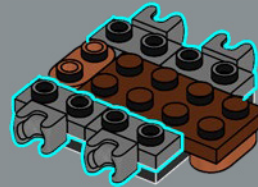

46

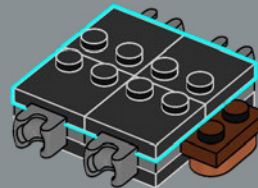

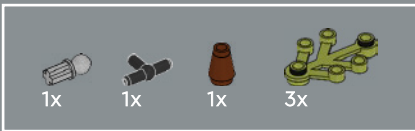

47

1

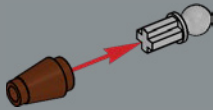

2

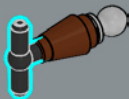

3

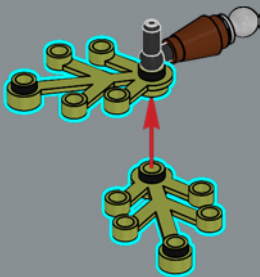

4

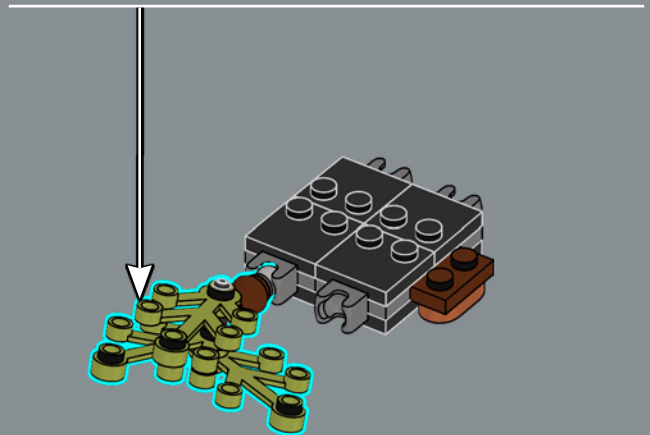
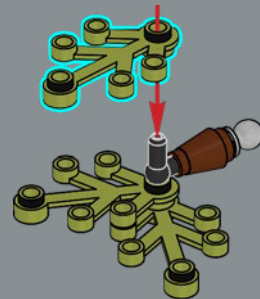

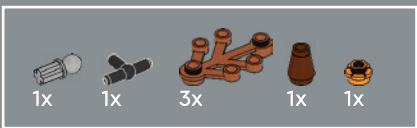

48

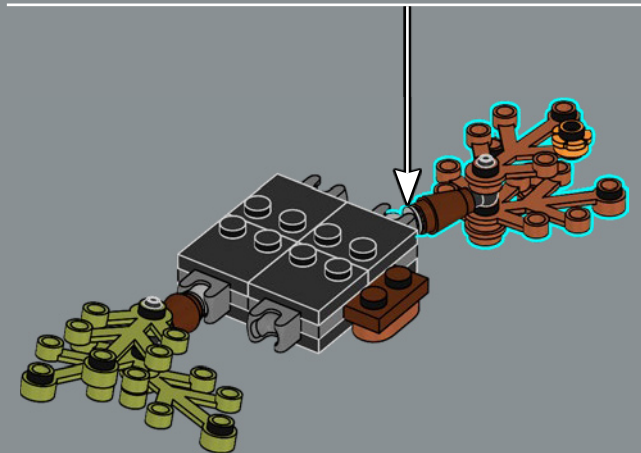
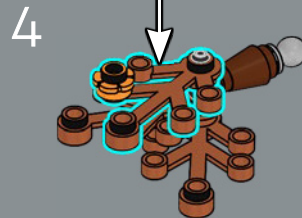
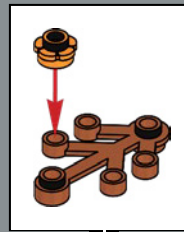
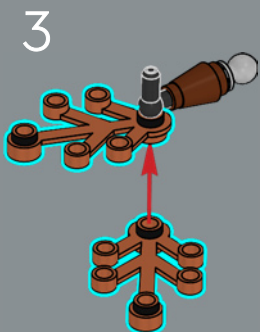
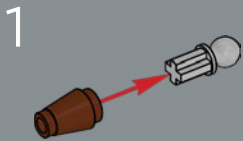



49

1

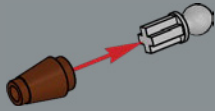

2

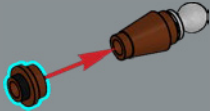

3

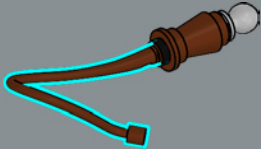

4

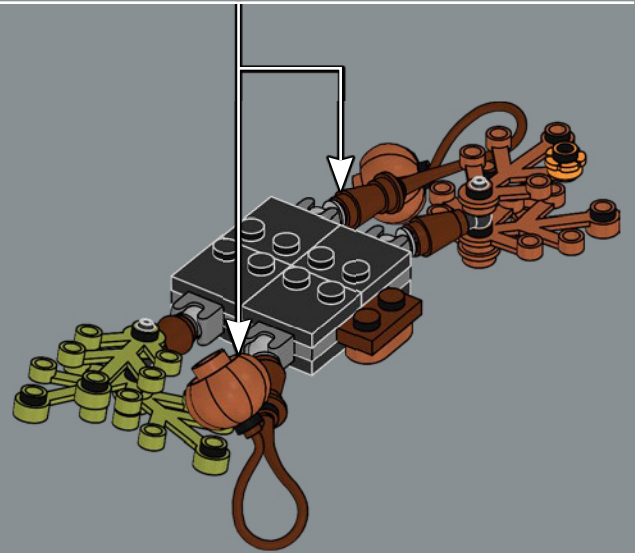

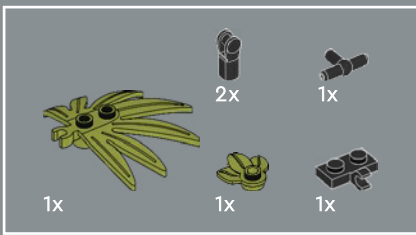

51

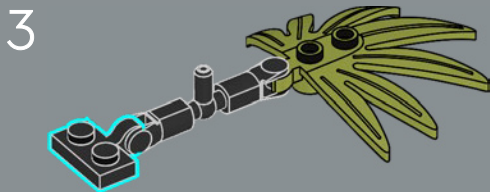
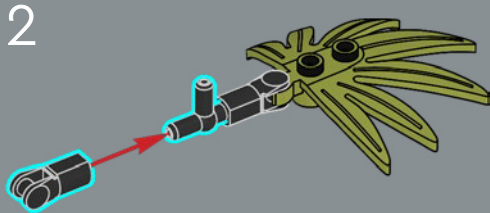
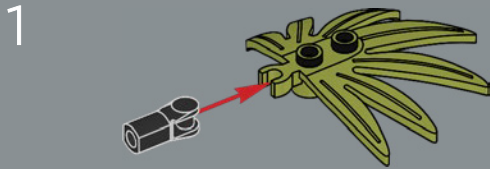

4

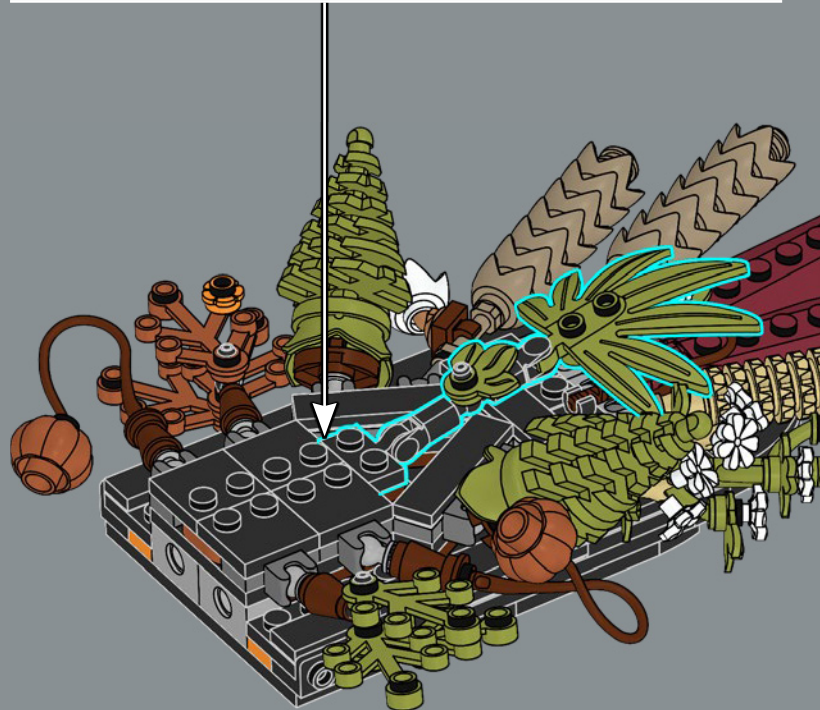
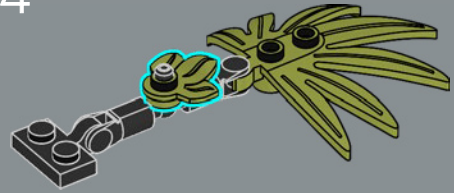

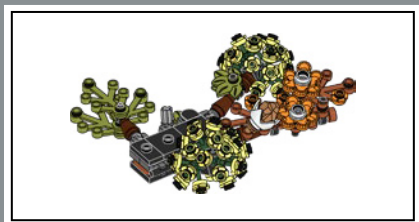

52

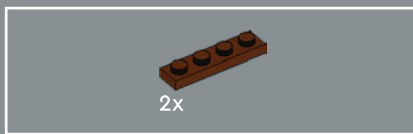
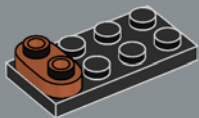

53

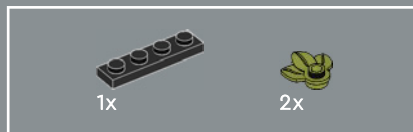

54

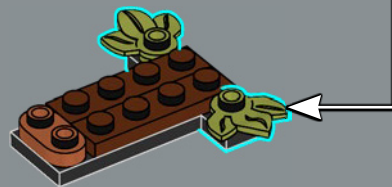
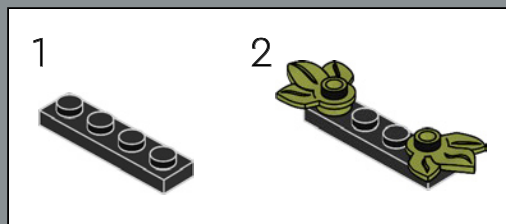

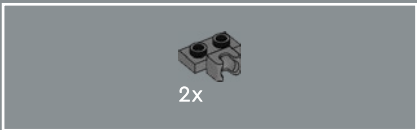

55

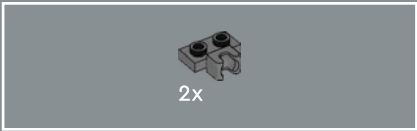
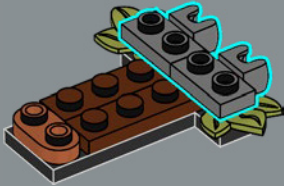

56

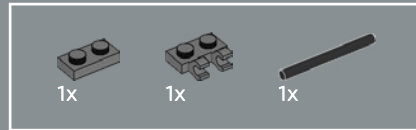
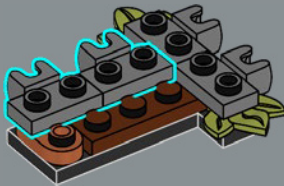

57

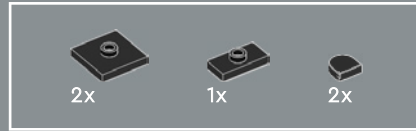
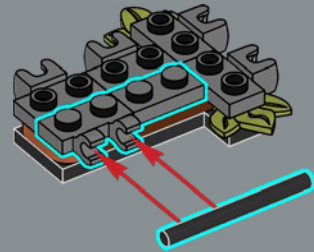

58

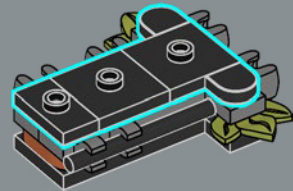

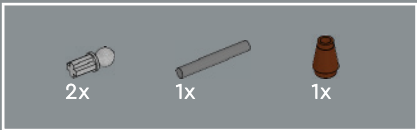

59

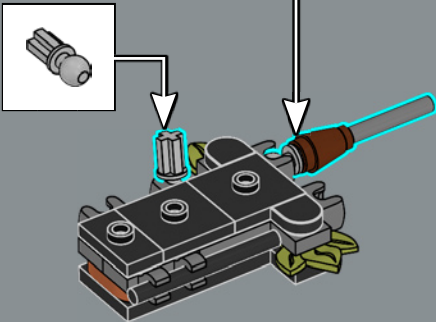
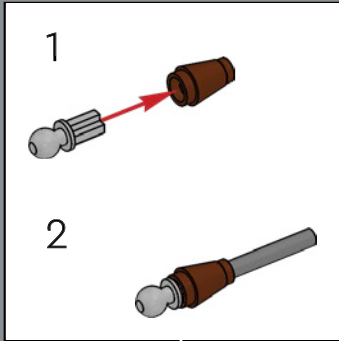

60

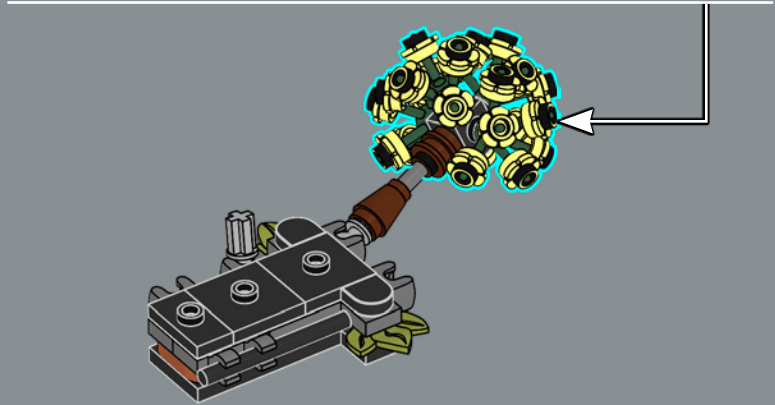
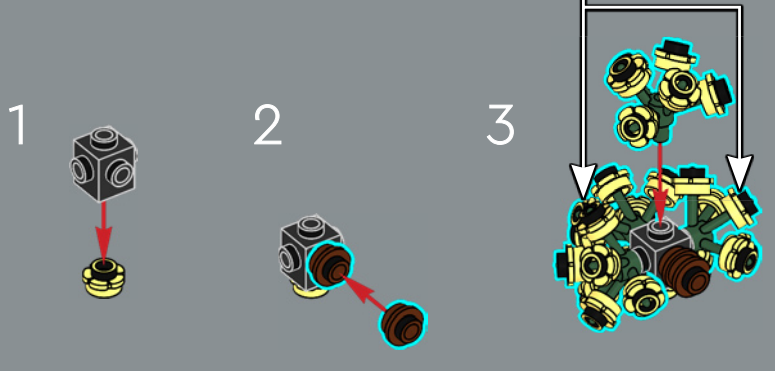
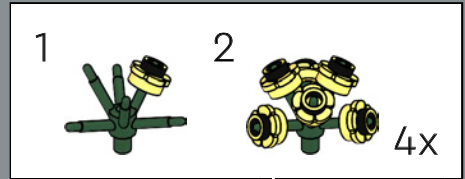

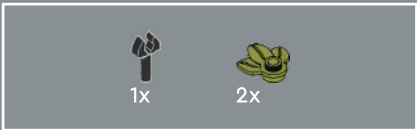

61

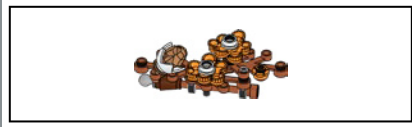
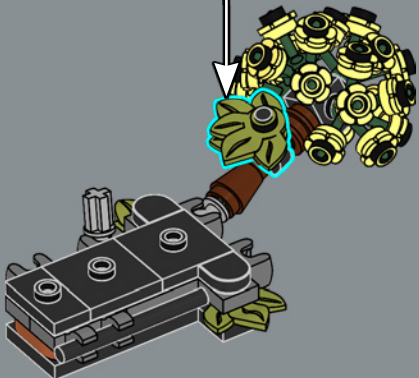
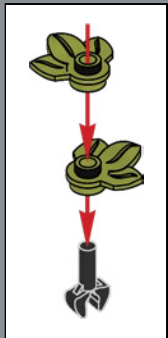

62

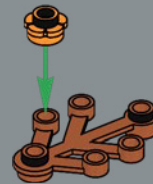

63

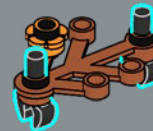



64

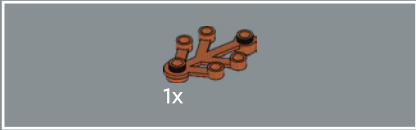
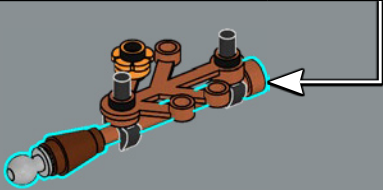
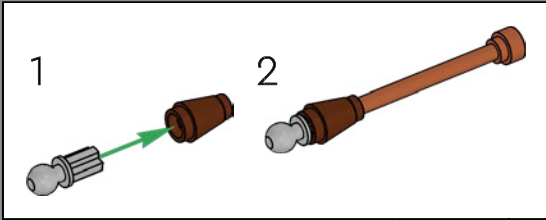

65

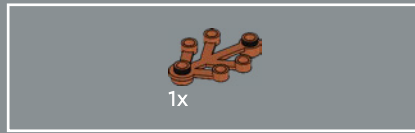
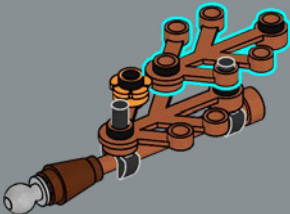

66

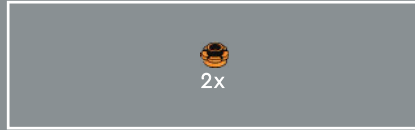
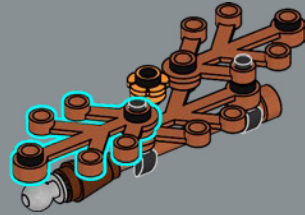

67

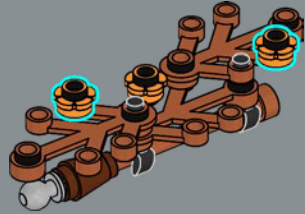



68

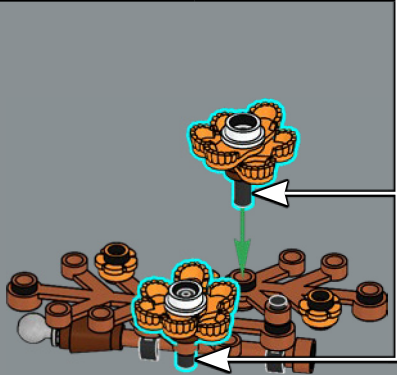
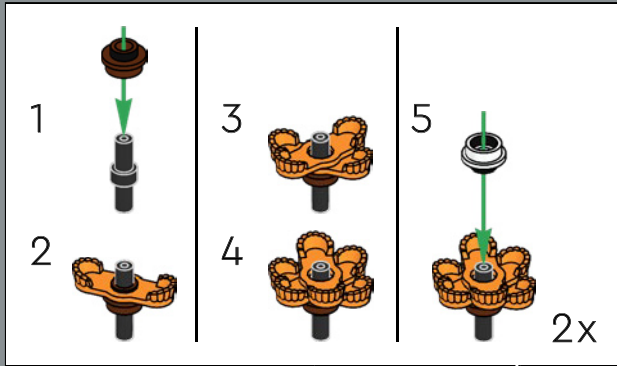

Die kleinen orangenen Schmuckkörnchen werden aus einem klassischen Minifiguren-Element gefertigt, genauer gesagt aus den Schulterklappen, die 1989 von den kaiserlichen Soldaten aus der Piraten-Themenwelt getragen wurden.



69

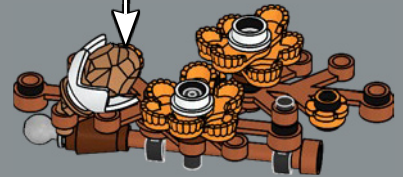
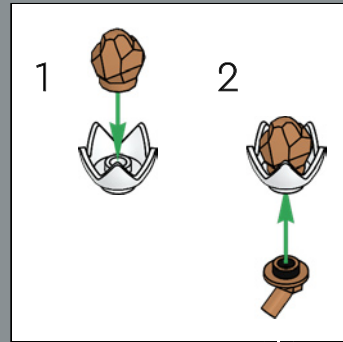

70

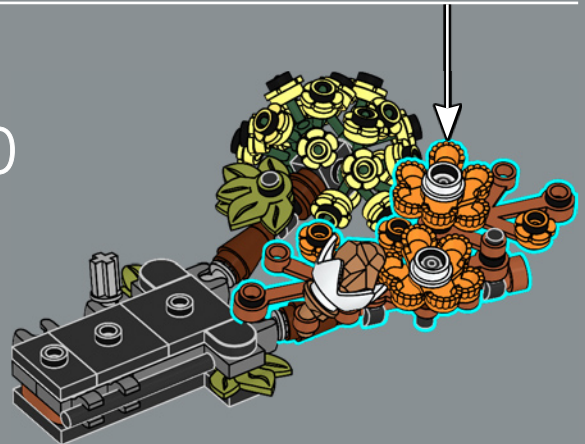



71

1

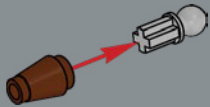

2



3

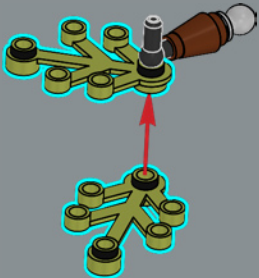

4

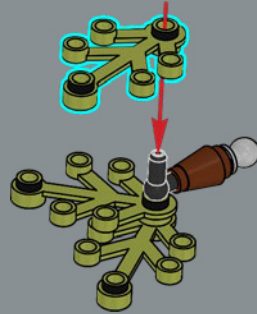

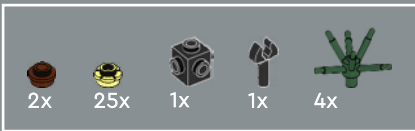

72

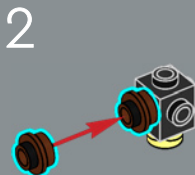
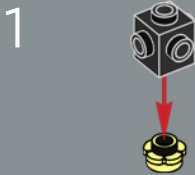

4

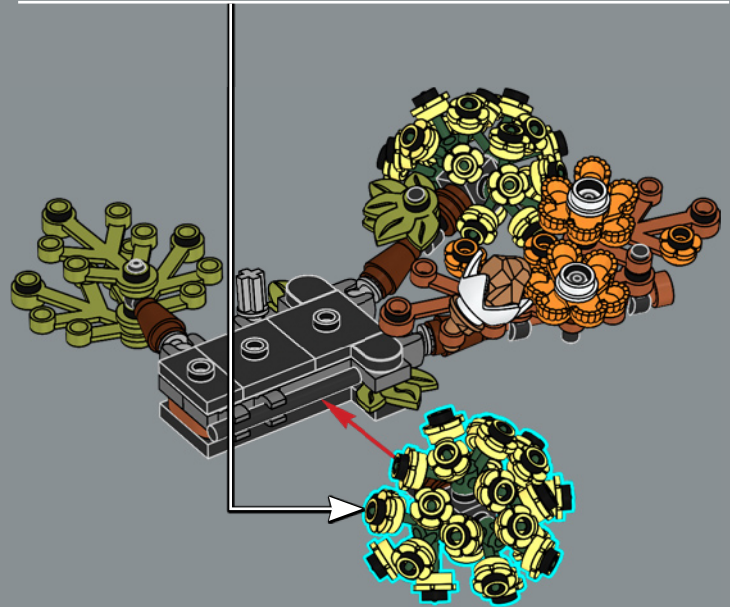
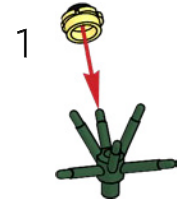
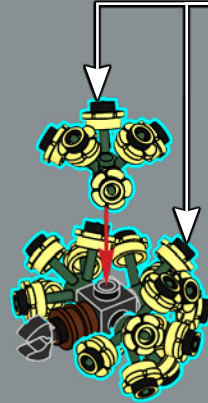

73

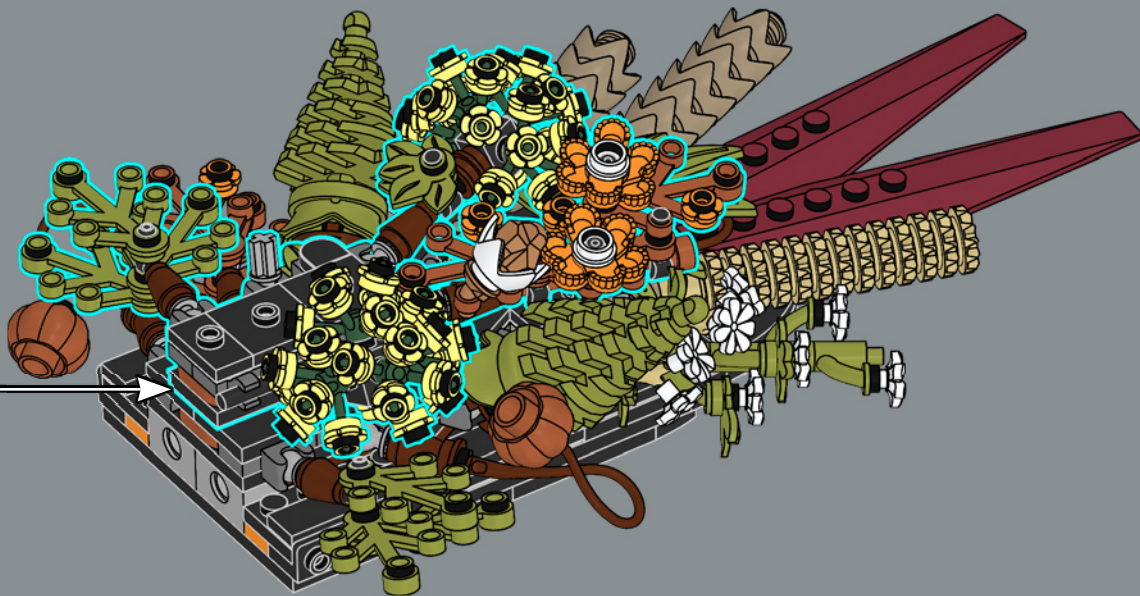



1x



3x

74

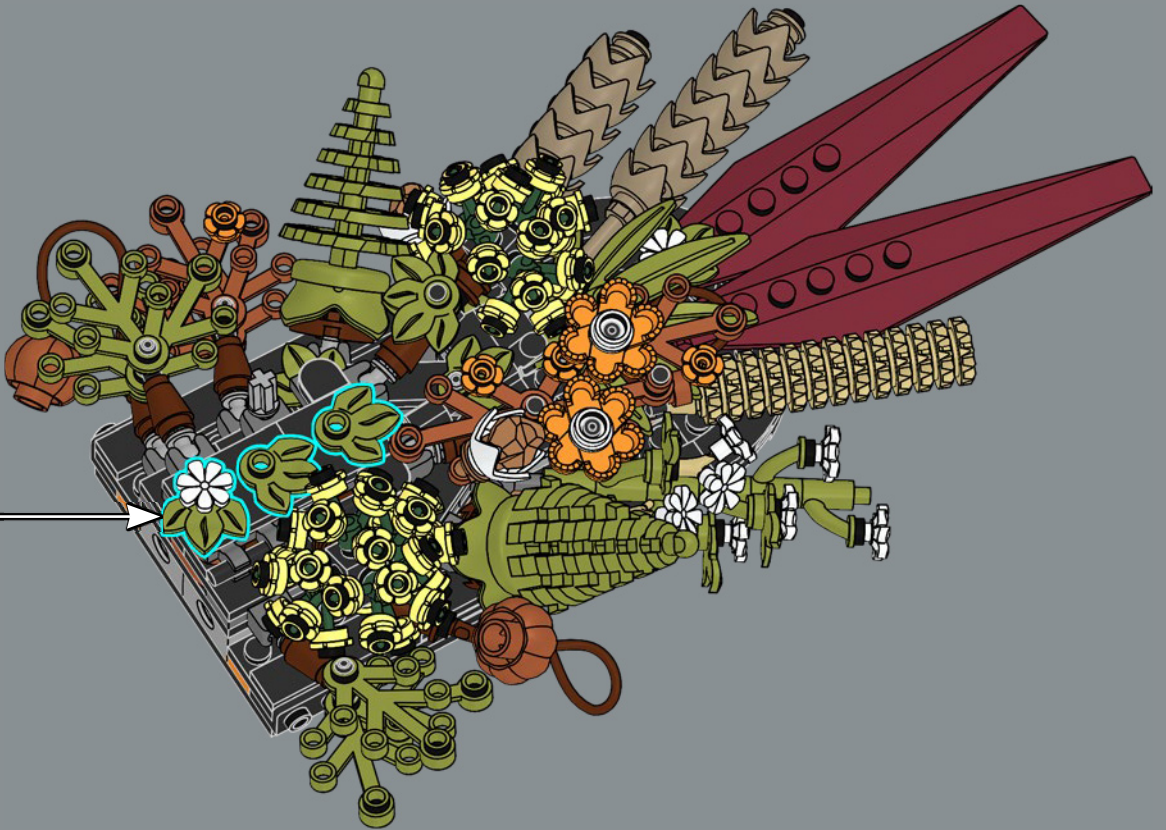
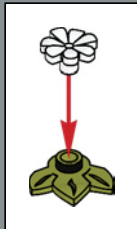

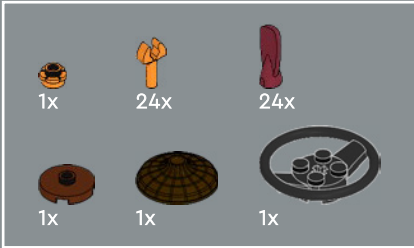
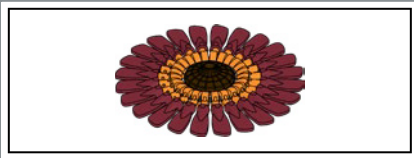

75

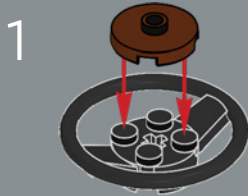

3

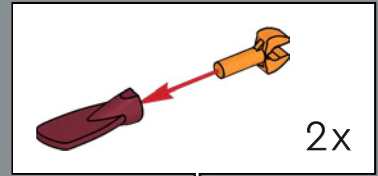
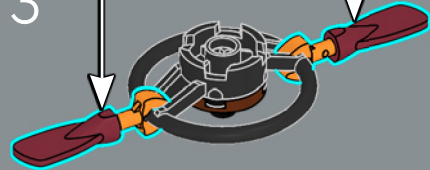

2x



4

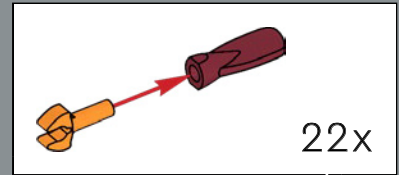

22x



5

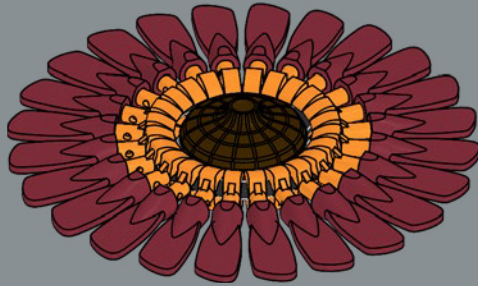

Beim Zusammensetzen der dunkelroten Gerbera wird dir auffallen, dass die Blütenblätter aus Minifigur-Ruderblättern bestehen. Und ein Minifiguren-Hut dient als Scheibenblüte.

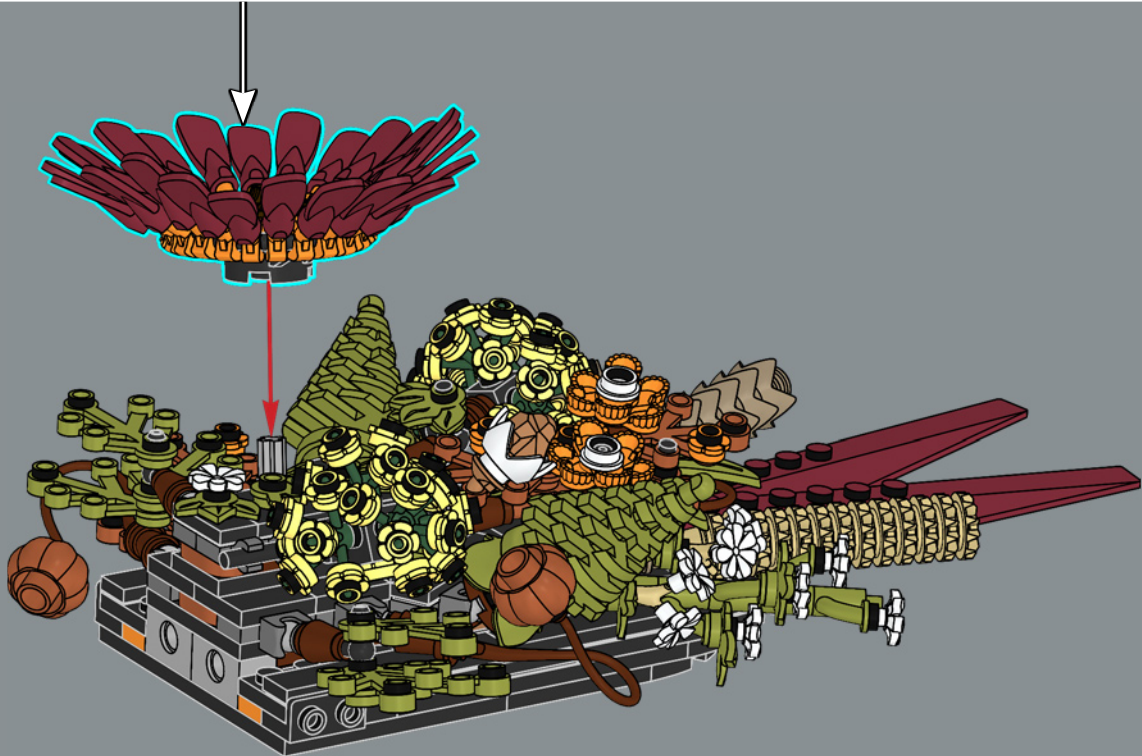

76

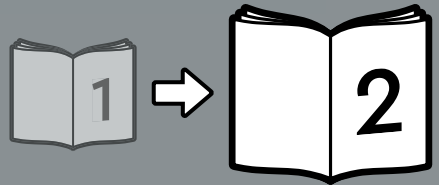
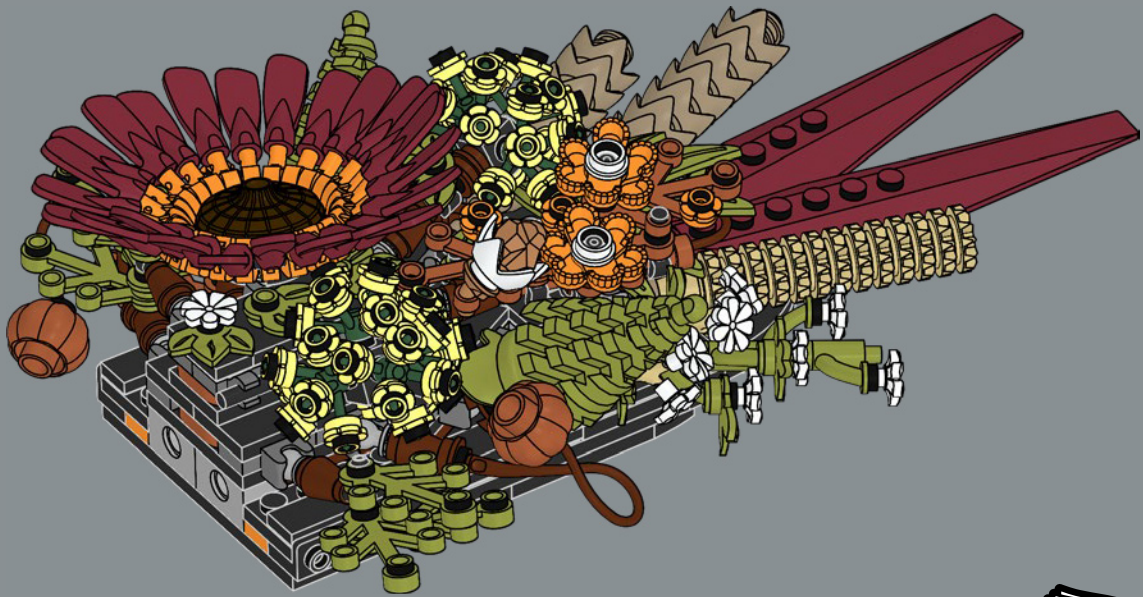



YOU COULD WIN



YOU COULD WIN

Your feedback will help shape the future development of this product series.

Visit:

DU KÖNNTEST GEWINNEN

Dein Feedback trägt zur Weiterentwicklung dieser Produktreihe bei.

Geh auf:

VOUS POURRIEZ GAGNER

Vos commentaires nous aideront à concevoir les futurs produits de cette gamme.

Visitez :

POTRESTI VINCERE TU

La tua opinione ci aiuterà a migliorare la creazione futura di questa linea di prodotti.

Visita:

PUEDES GANAR

Tu opinión contribuirá al futuro de esta serie de productos.

Visita:

轻松获奖

您的反馈将有助于我们在今后改进本产品系列。

请访问：

LEGO.com/productfeedback

You also have the chance to win a LEGO® set.

Terms and conditions apply.*

Außerdem hast du die Chance, ein LEGO® Set zu gewinnen.

Es gelten die Teilnahmebedingungen.*

Vous pourriez également gagner un ensemble LEGO®.

Des conditions s'appliquent.*

Hai anche la possibilità di vincere un set LEGO®.

Termini e condizioni sono applicabili.*

También tienes la oportunidad de ganar un set LEGO®.

Aplican términos y condiciones.*

您还有机会赢取乐高®套装。

条款和条件适用。*

*LEGO.com/productfeedback-terms

ERWEITERE
DEINE LEGO®
BOTANIK
KOLLEKTION



10280
Blumenstrauß



10311
Orchidee

10313
Wildblumenstrauß



10281
Bonsai Baum



6x
6168642



2x
6210272



24x
6338913



4x
6259700



2x
6378415



2x
4529237



4x
6347292



6x
6324176



26x
4565452



4x
6431730



4x
6330588

50



1x
6391341



2x
370126



2x
6267487



6x
306926



2x
302326



2x
6092585



10x
6192346



2x
4565323



2x
6133722



6x
243126



6x
371026



4x
4560182



12x
302026



2x
6350415



4x
6347310



2x
6313116



4x
6020193



1x
6350725



4x
6256435



4x
6210270



12x
663626



2x
6058118

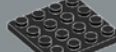

4x
4243819

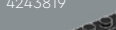

7x
346026



2x
303626



2x
4514845



4x
287726



4x
473326



6x
6371584



2x
6116604



6x
6321194



8x
6278152



4x
6279875



8x
6104209



8x
6191630



3x
6325190



1x
6299938



4x
6171264



4x
6101857



4x
6133200



8x
6369194



13x
6022079



2x
6400293



3x
6426472



1x
6074892



2x
6219673



2x
4177932



4x
6106027



8x
6030521



8x
6214234



18x
6426228



24x
6278159



1x
6149656



1x
6240515

15x
6426470

4x
6285465

31x
6398008

4x
6426468

4x
6426464

10x
6268815

2x
6313102

2x
6348057

4x
6313124

14x
4529242

4x
6172922

1x
6257604

3x
4211190

2x
6307618

2x
4211186

17x
6215659

2x
6075213

4x
4211159

1x
6102360

4x
6170468

5x
6359864

8x
6416695

2x
4211440

4x
6326478

8x
6043639

22x
4211375

2x
4211805

1x
4211063

2x
6388119

23x
6146792

2x
6350292

2x
6310596

9x
6364352

100x
6426463

1x
6384238

1x
6384589

1x
6416732

4x
6431549

16x
6398343

4x
6102998

6x
6093494

2x
6347304

1x
6177189

4x
6400315

4x
6432504

2x
6299413

34x
6300322

28x
6431686

24x
6426473

4x
6431687

4x
6426471

7

 [LEGO.com/service](https://www.LEGO.com/service)



