



CLASSIC

10704



[LEGO.com/classic](https://www.lego.com/classic)



WARNING: CHOKING HAZARD.
Small parts. Not for children under 3 years.





AVERTISSEMENT : RISQUE D'ÉTOUFFEMENT.

Contient des petites pièces. Ne convient pas aux enfants de moins de 3 ans.



ADVERTENCIA: PELIGRO DE ASFIXIA.

No recomendado para niños menores de 3 años. Contiene piezas pequeñas.

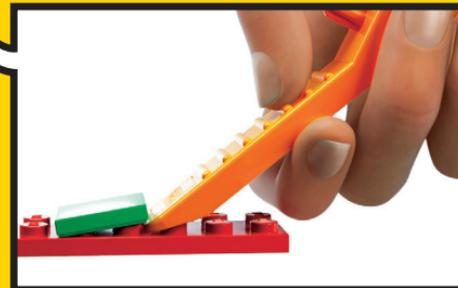
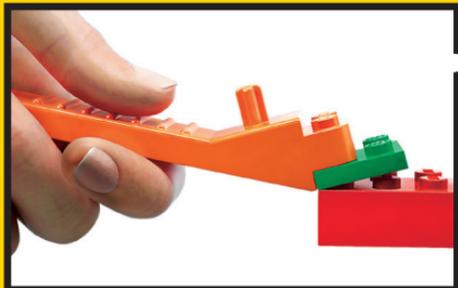
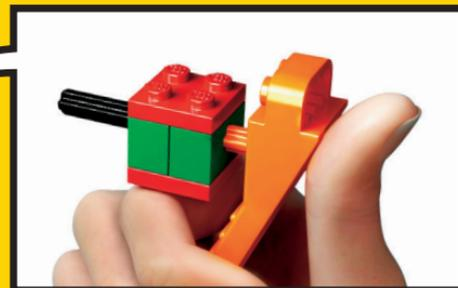

LEGO.com/brickseparator



Easy Building
Construction facile
Construcción fácil



Medium Building
Construction intermédiaire
Construcción intermedia



Advanced Building
Construction avancée
Construcción avanzada



p./pag.
6



p./pag.
18

p./pag.
14



p./pag.
26



p./pag.
38



p./pag.
56



LEGO.com/classic

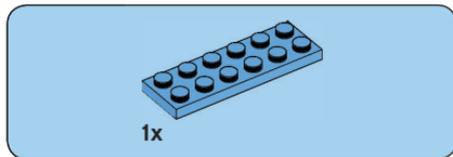

1

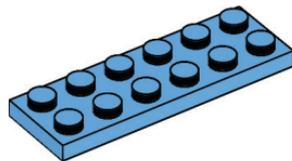



1x

2

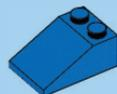
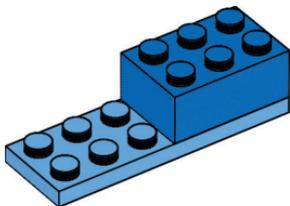

1x

3

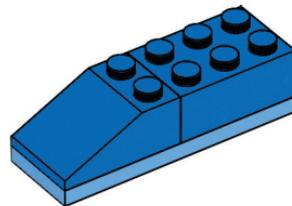



1x



1x

4

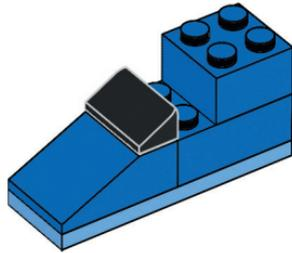

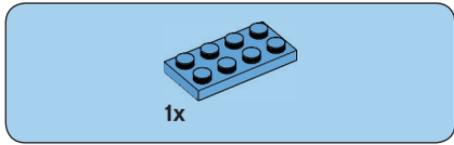

5

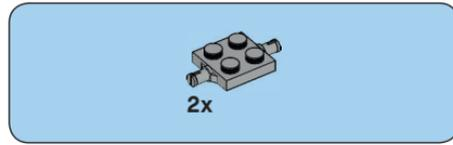
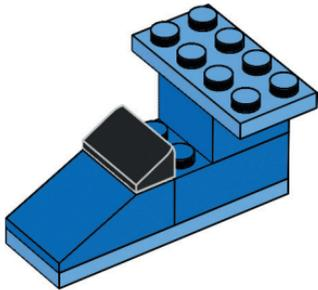

6

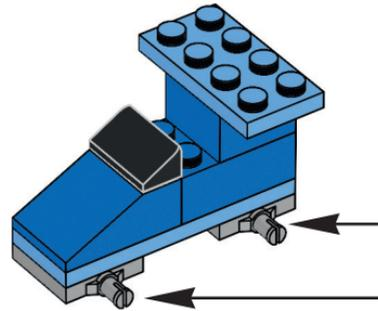
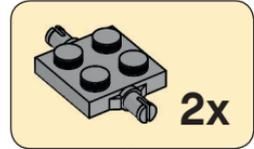



4x



4x

7



4x

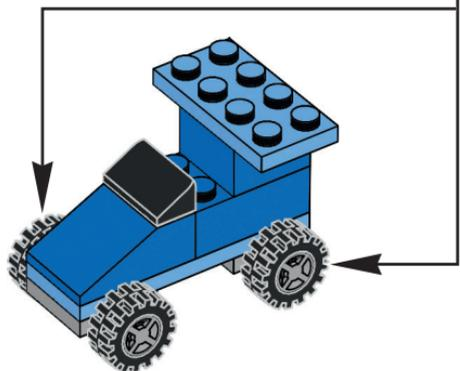

1x

8

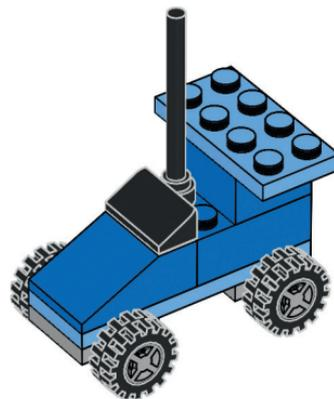

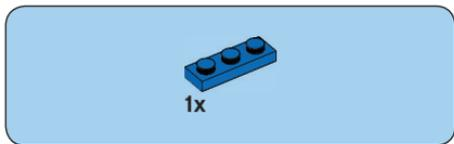
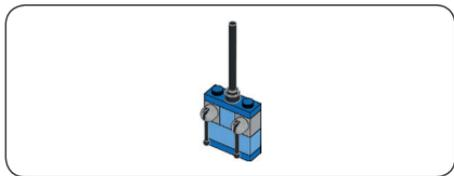

1

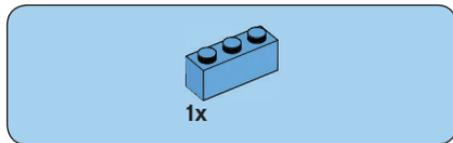

2

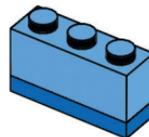



1x



2x

3

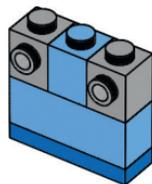

1x

4

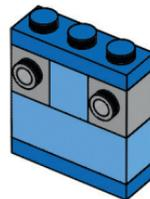



5

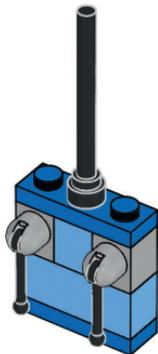

6

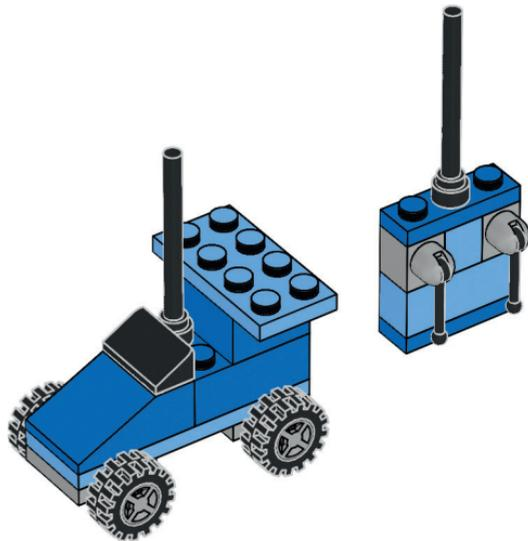

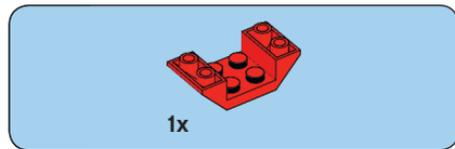

1

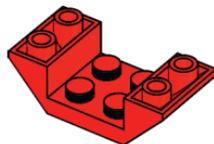

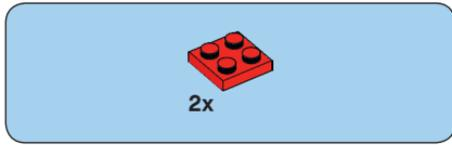

2

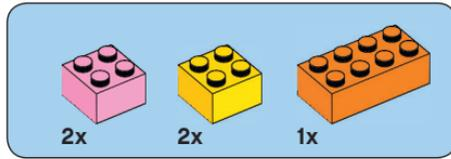
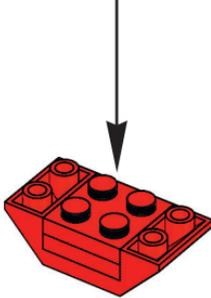
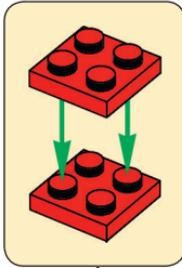

3

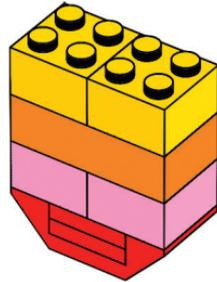

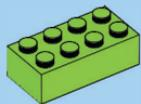

1x

4

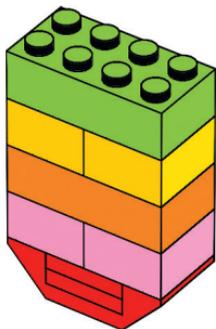

2x

5

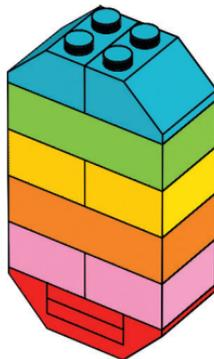



3x

6

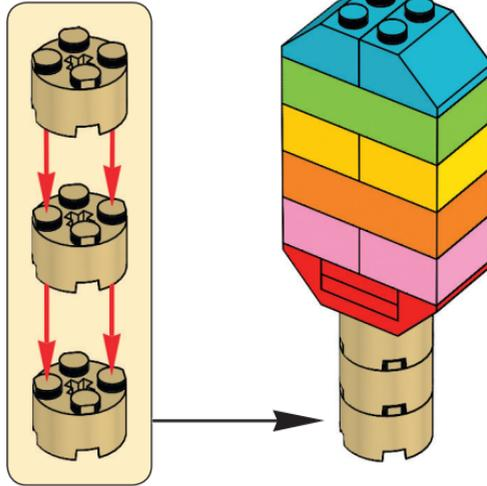

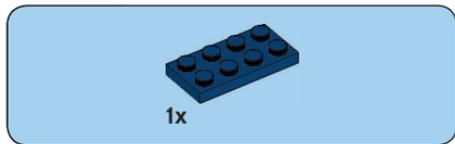

1



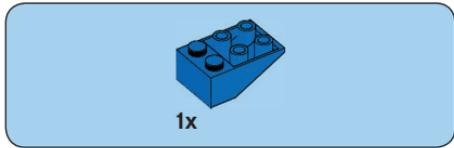

2

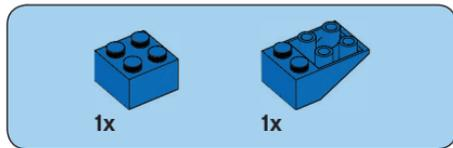
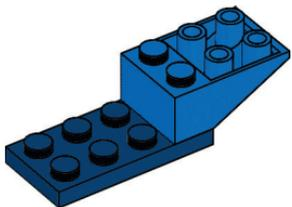

3

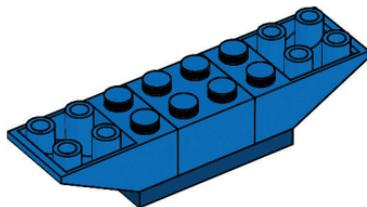

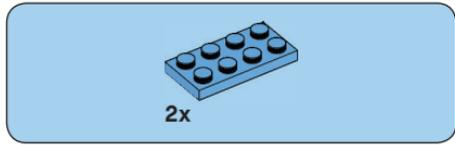

4

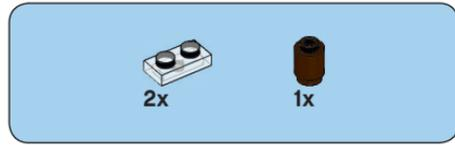
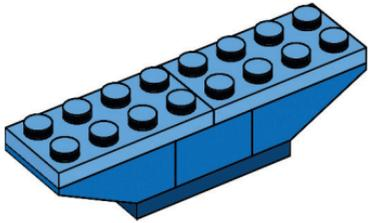

5

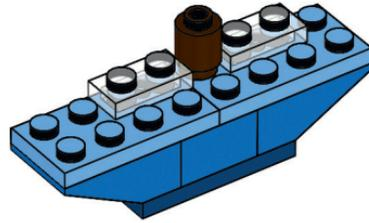

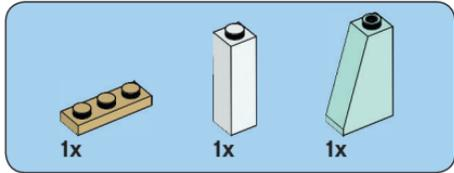
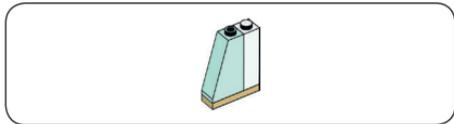

6

1

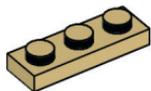

2

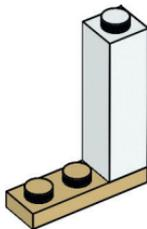

3

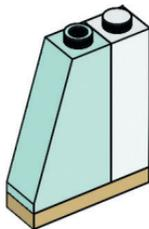

7

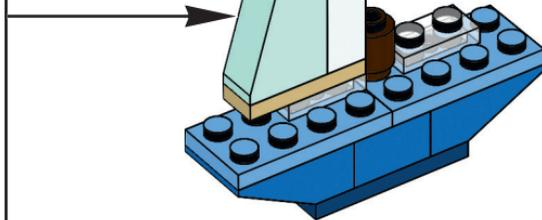



2x



2x

8

1



2

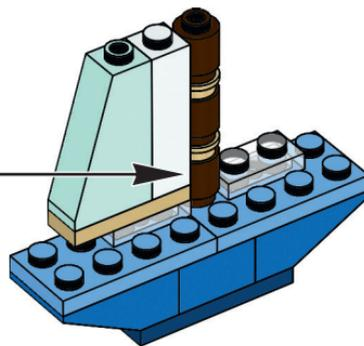

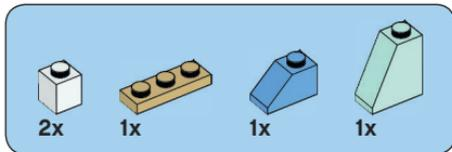
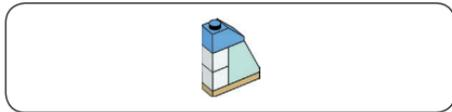

9

1

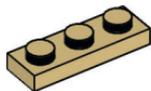

2

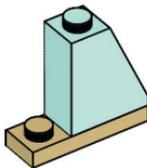

3

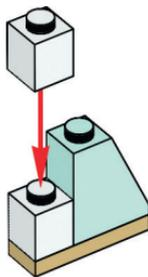

4

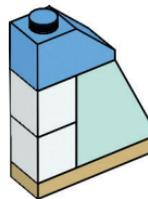

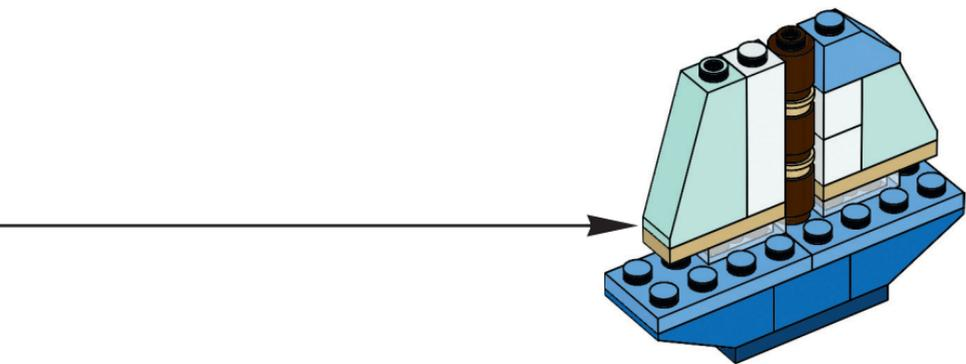

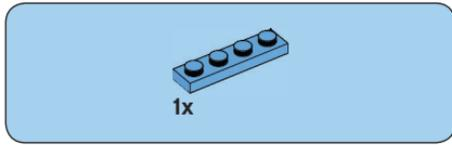

10

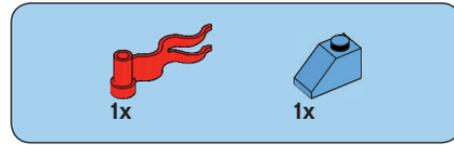
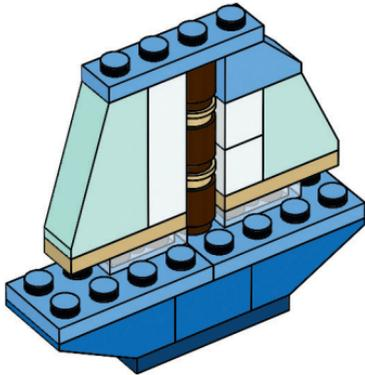

11

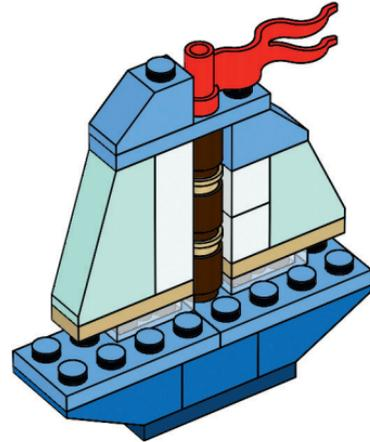

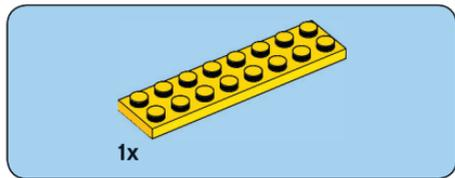

1

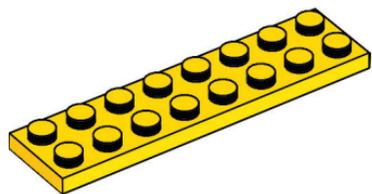

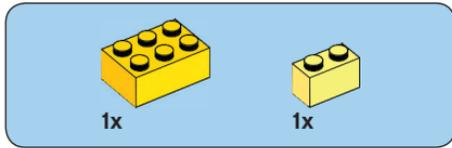

2

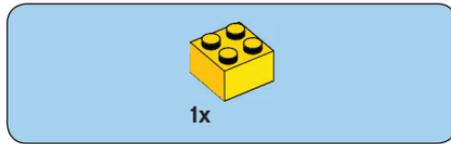
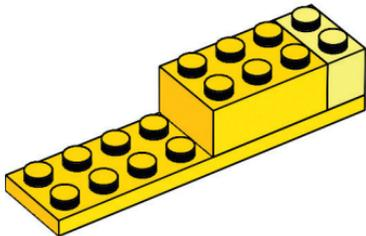

3

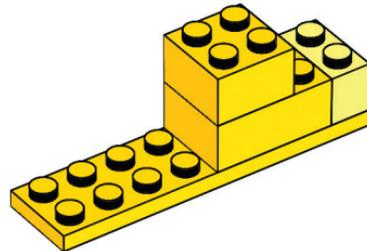



4x

4



2x

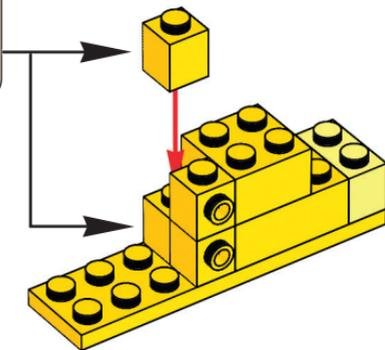

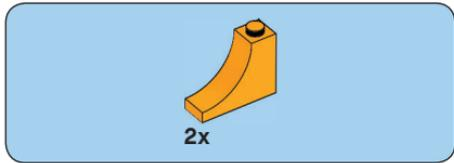

5

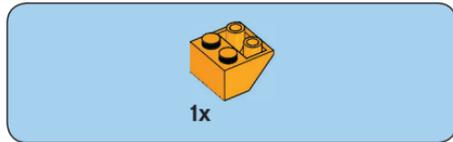
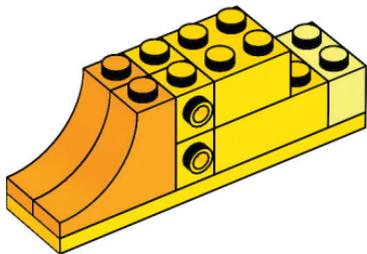

6

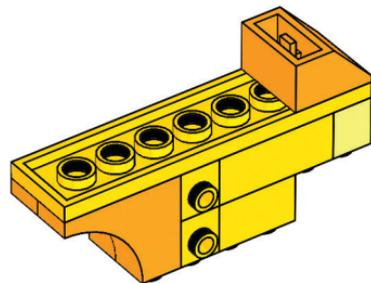

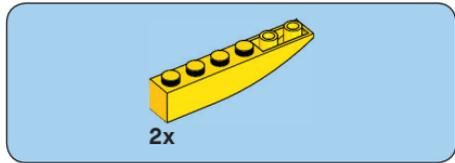

7

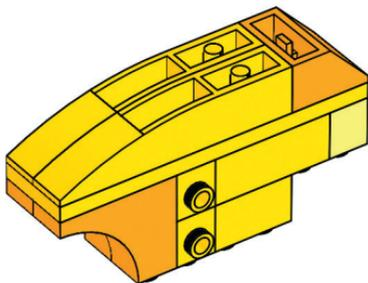

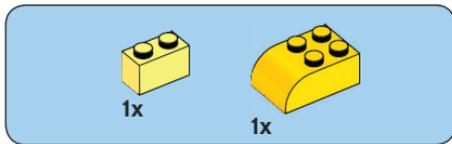

8

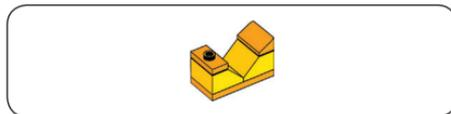
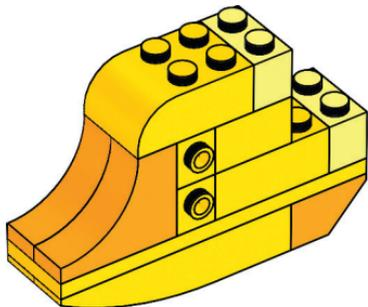

9

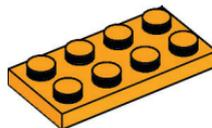
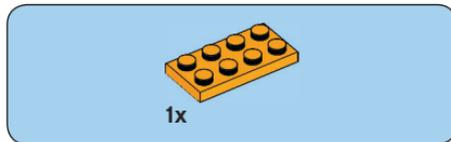



2x

10

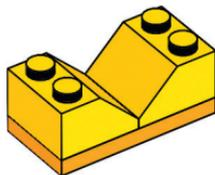

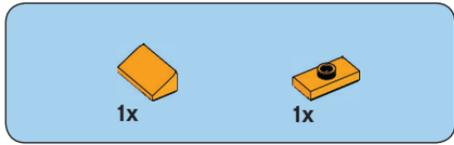

11

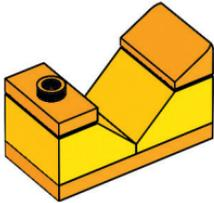

12

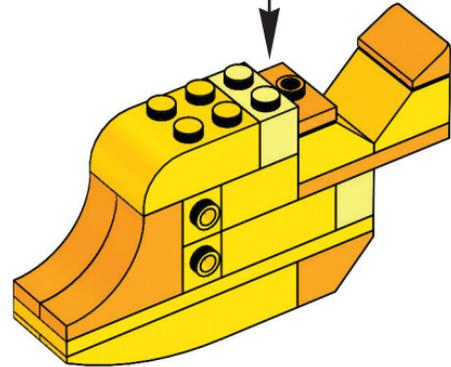



1x

13

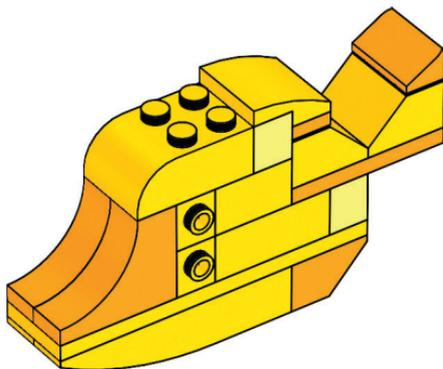

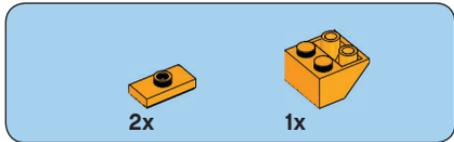

14

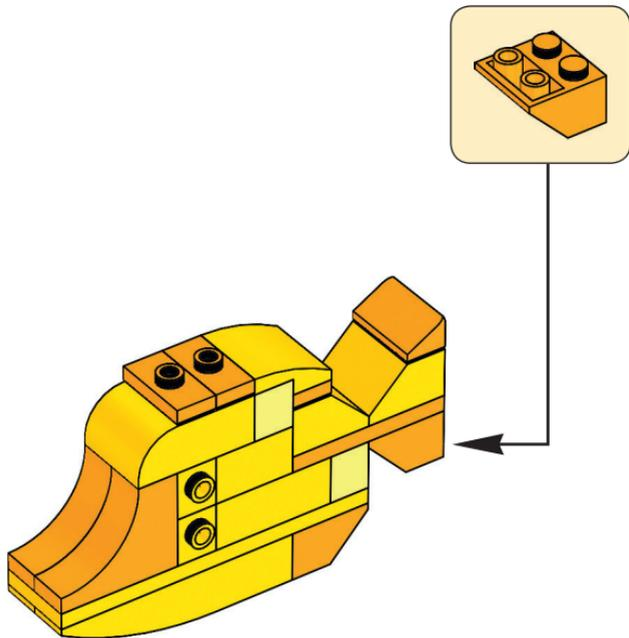



1x

15

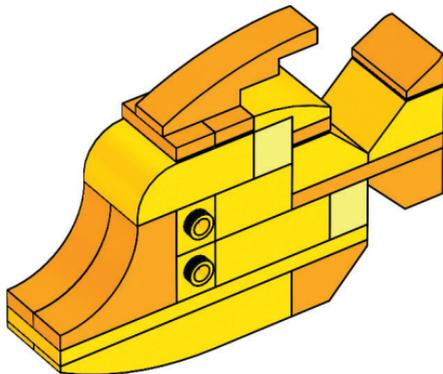



16

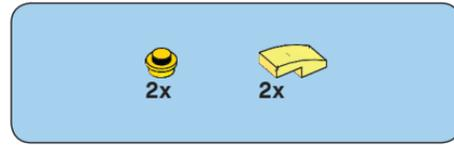
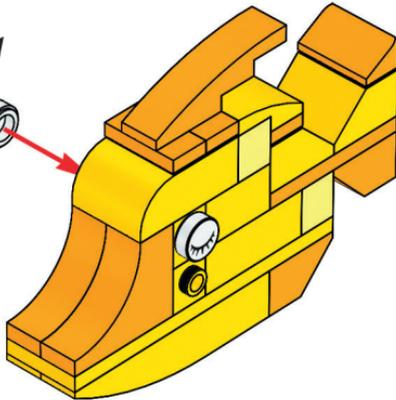

17

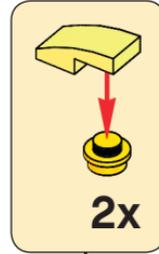

2x

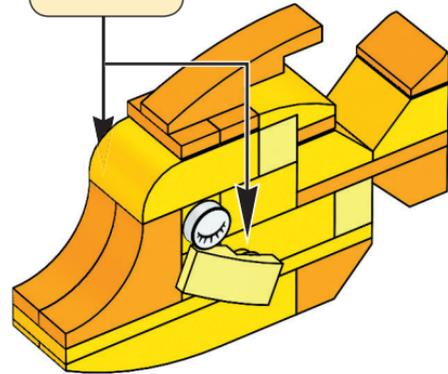
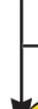

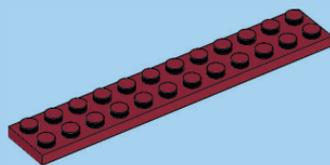

1x

1

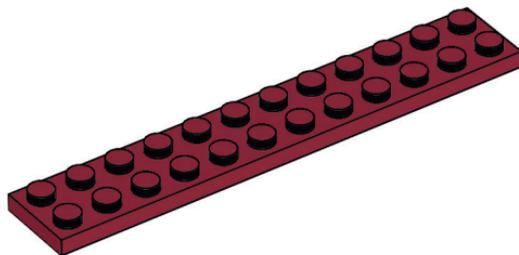



1x



1x

2

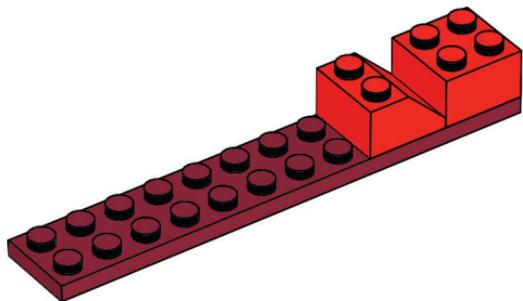

2x

3

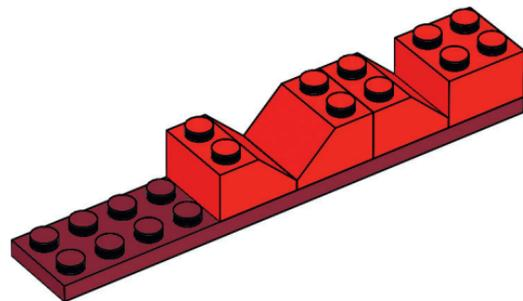

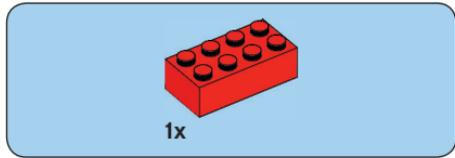

4

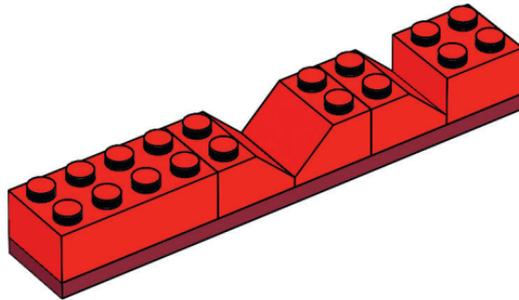

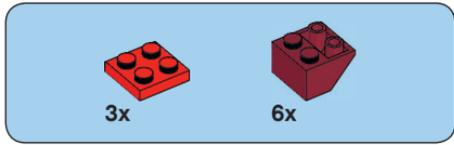

5

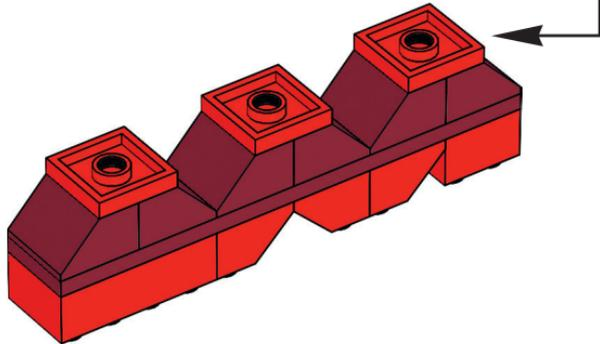
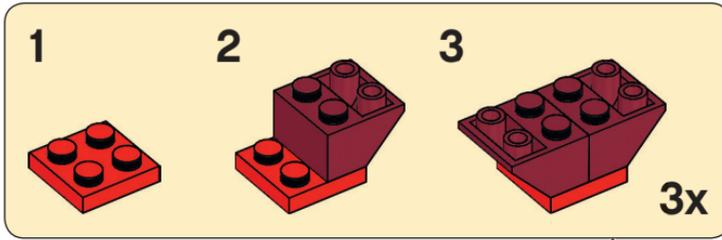

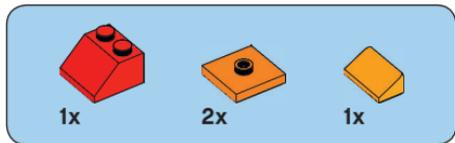

6

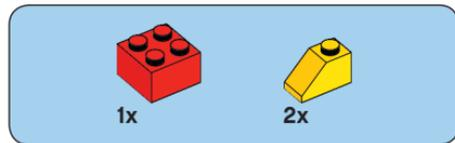
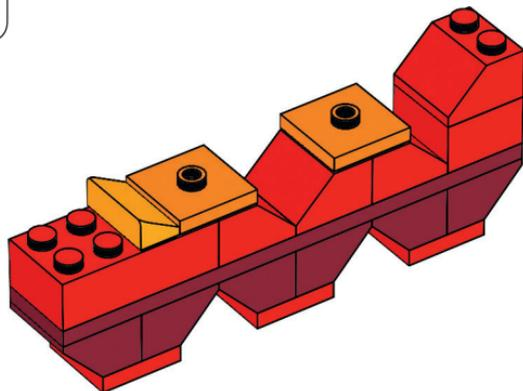

7

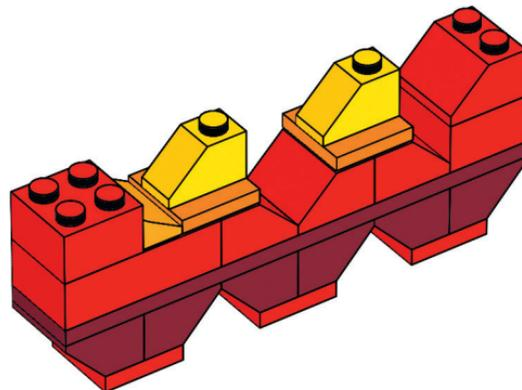

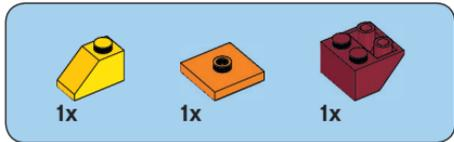

8

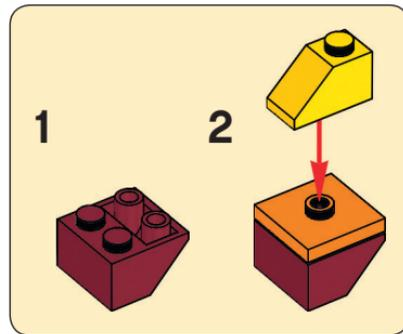
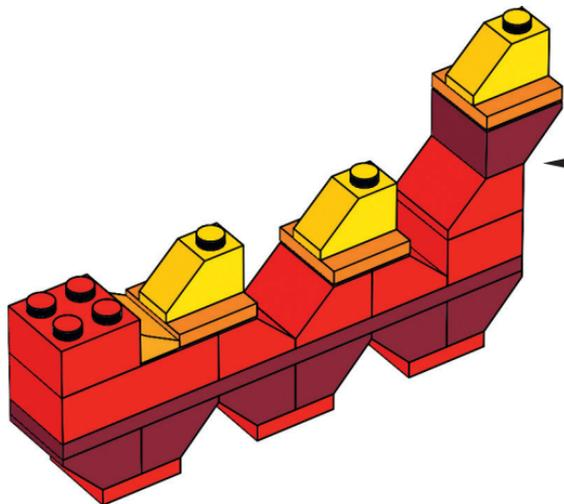

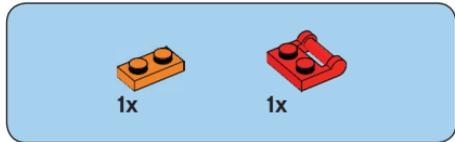

9

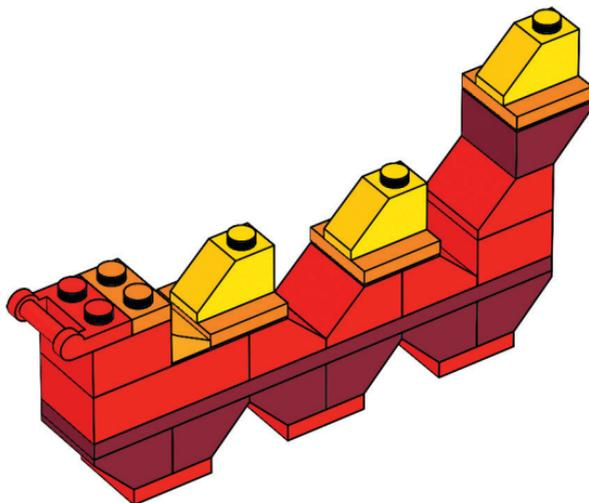



2x

10

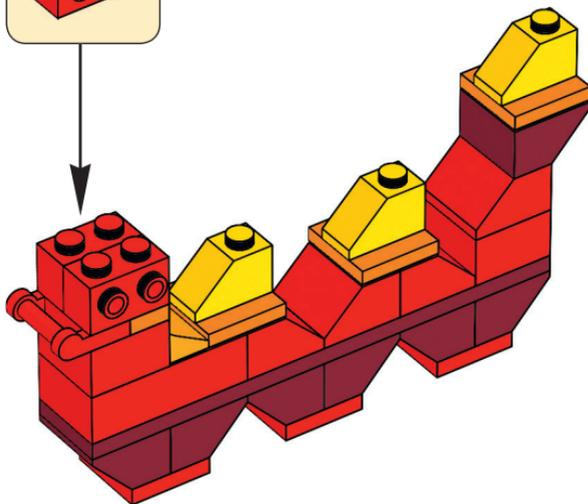
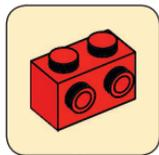

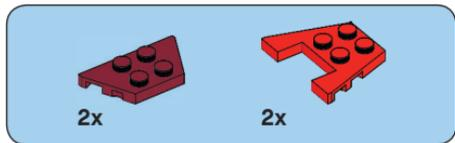

11

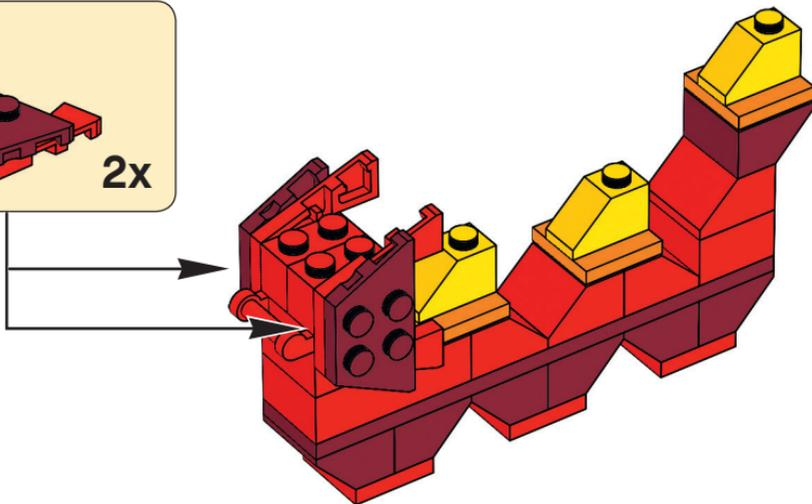
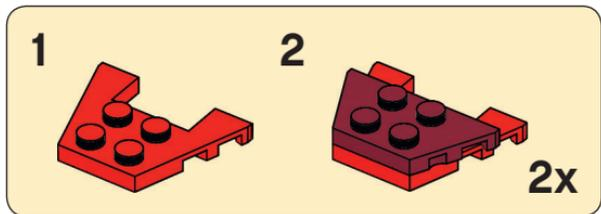

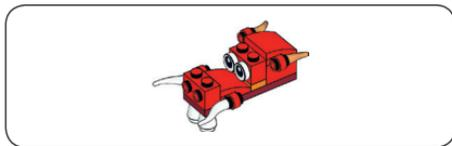

12

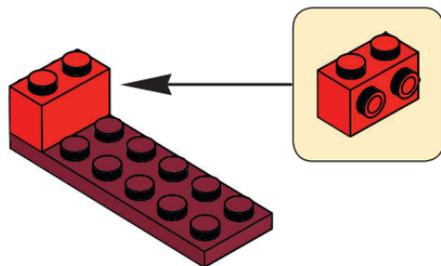

13

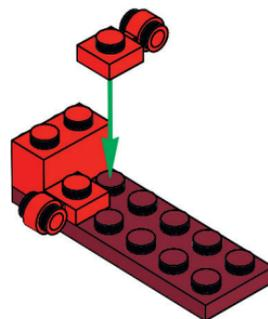



1x



1x

14

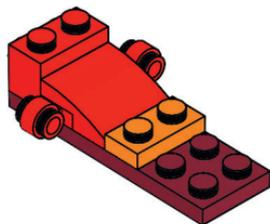



1x

15

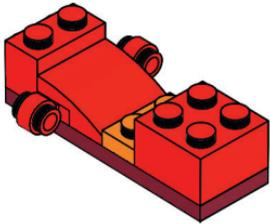

2x



1x

16

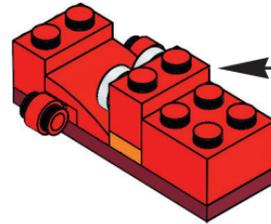
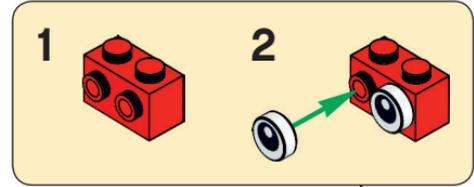



2x

17

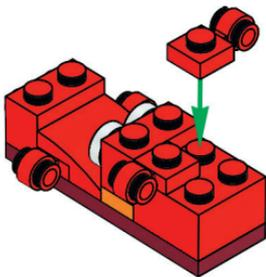



18

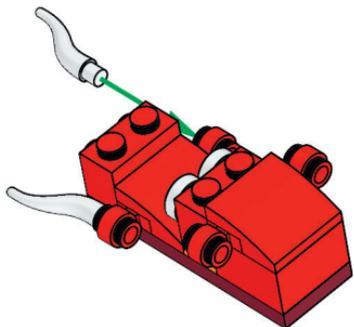

19

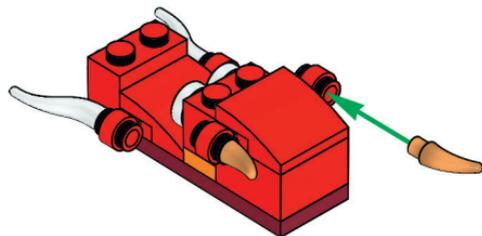



20

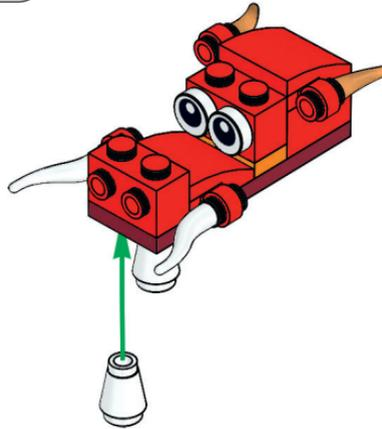

21

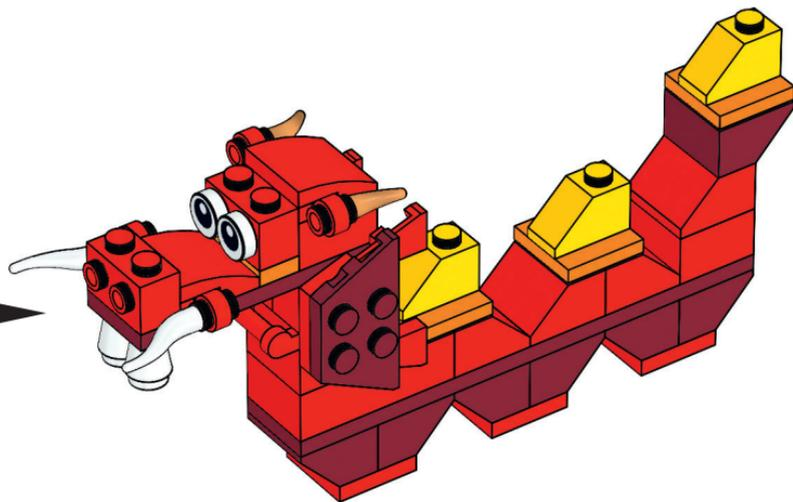

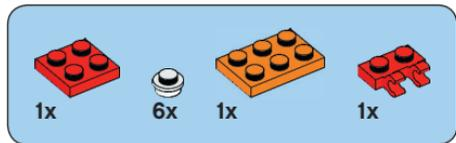

22

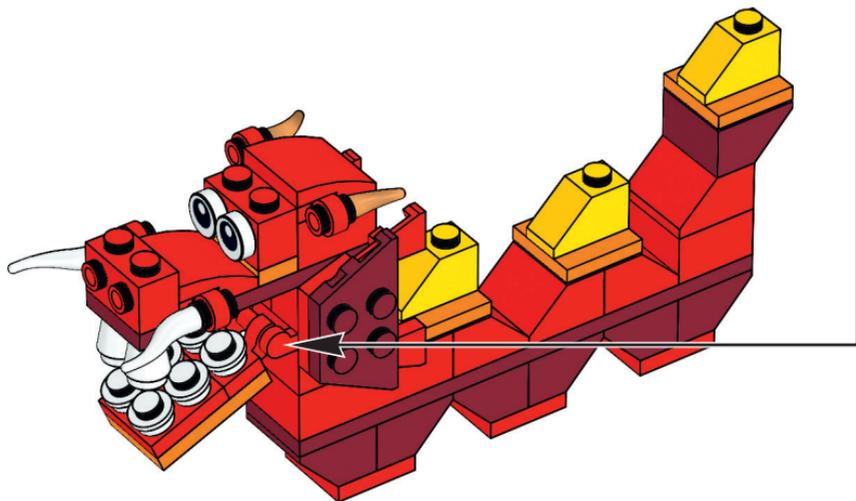
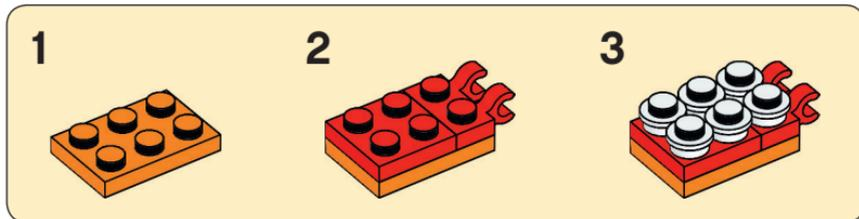



3x



3x

23

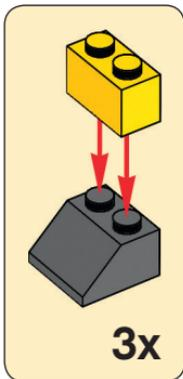
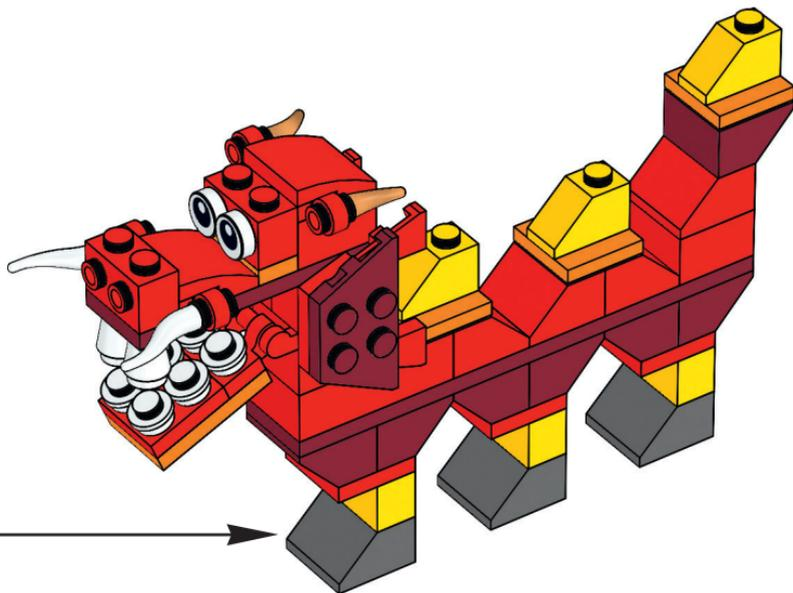

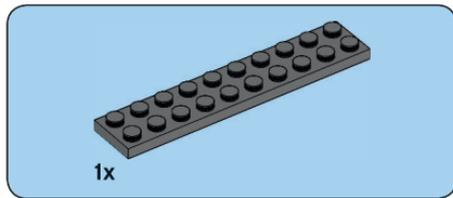

1

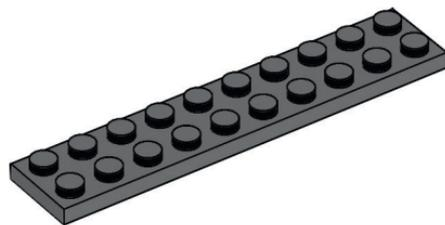

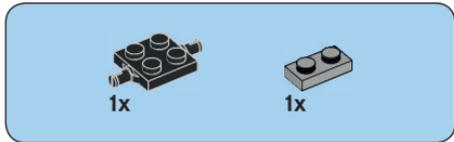

2

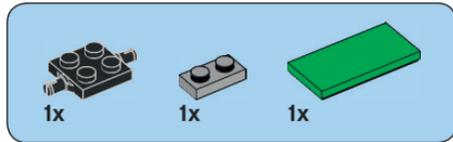
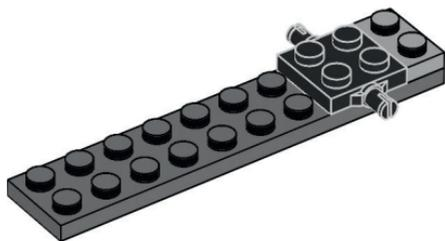

3

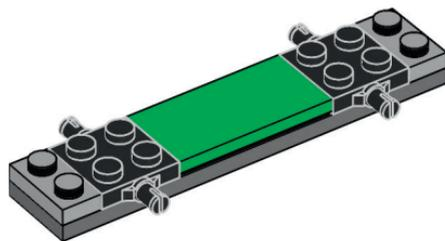

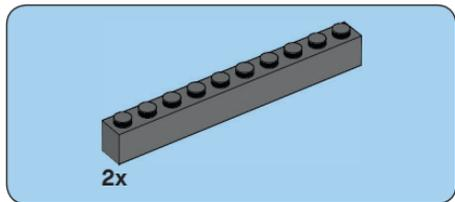

4

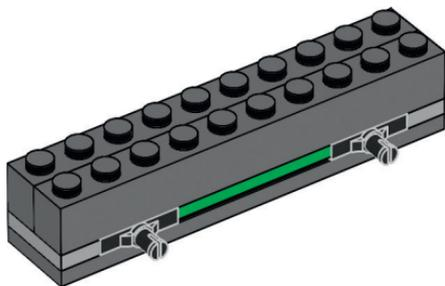

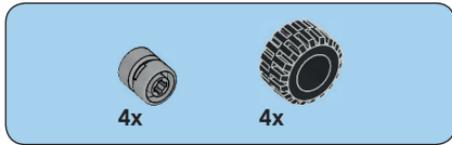

5

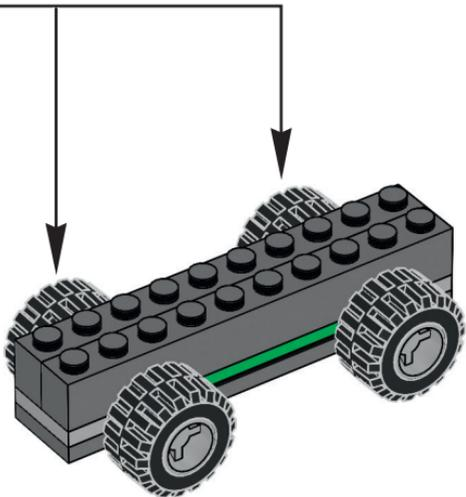
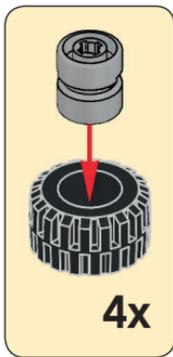

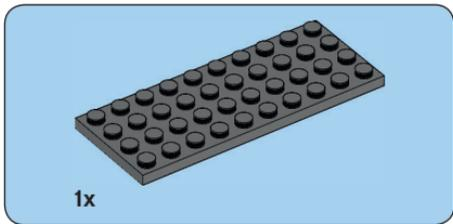

6



7

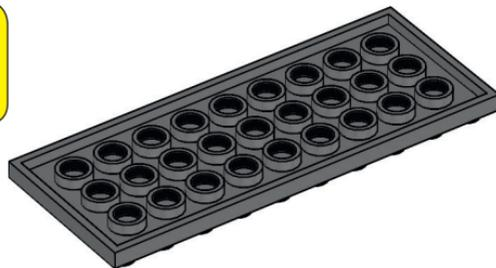



8

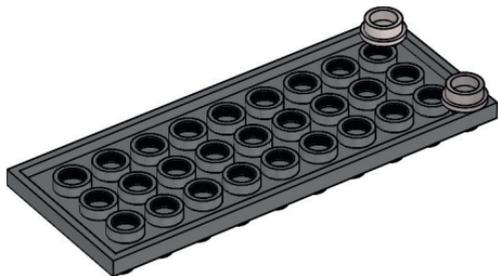

9

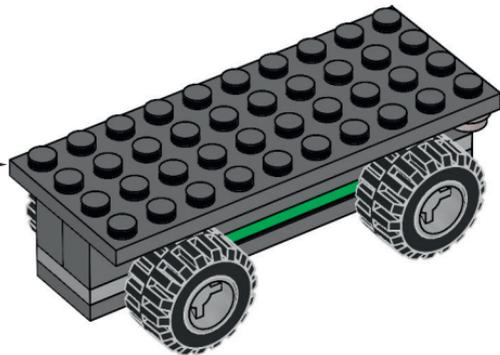



2x

10

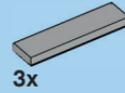
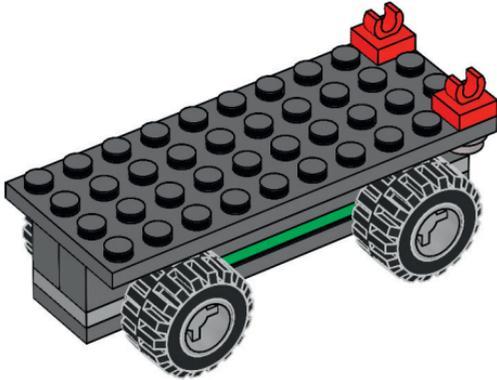

3x

11

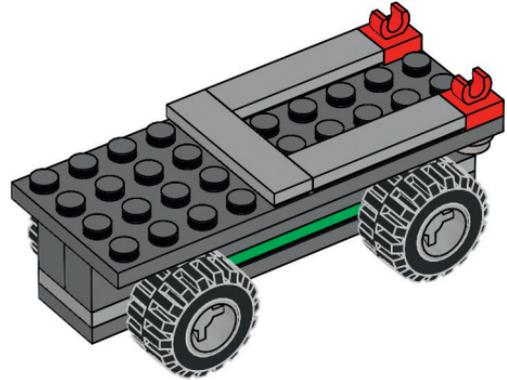

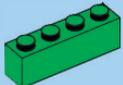

1x

12

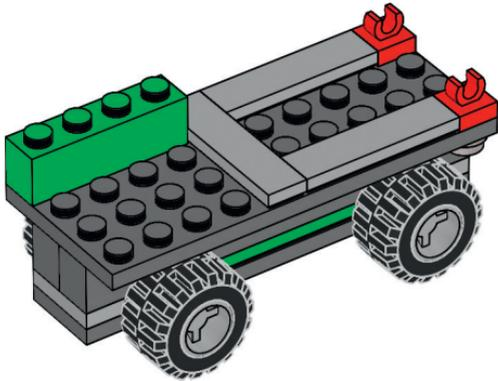

1x

13

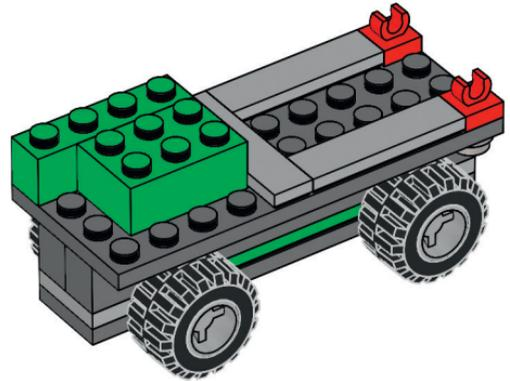

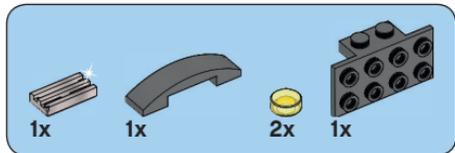

14

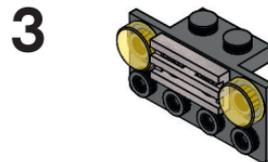
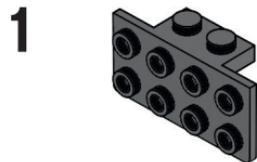

4

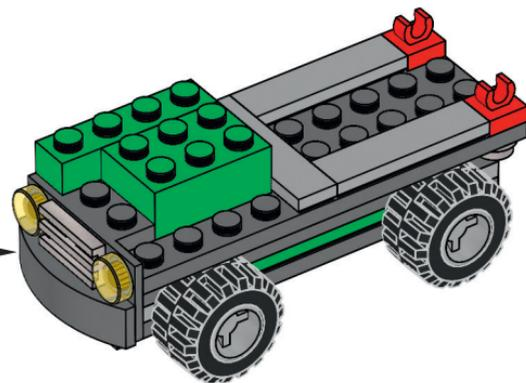
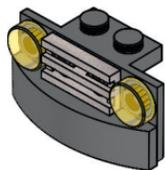



2x

15

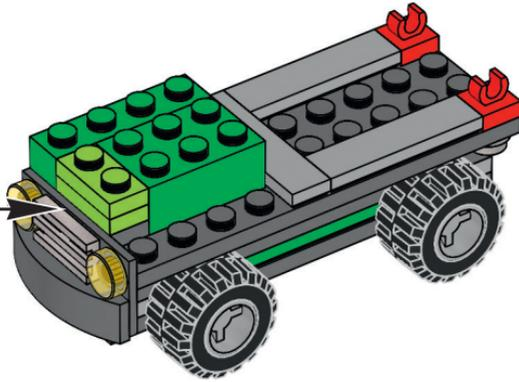
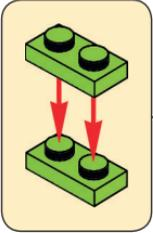

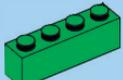

1x

16

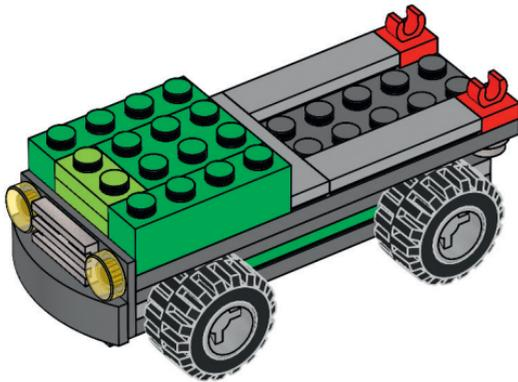

2x



1x

17

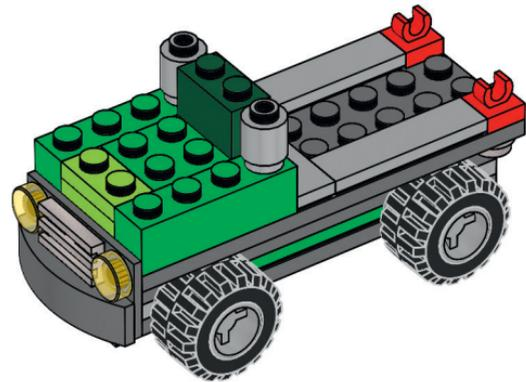

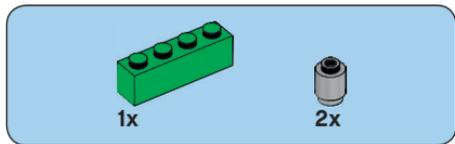

18

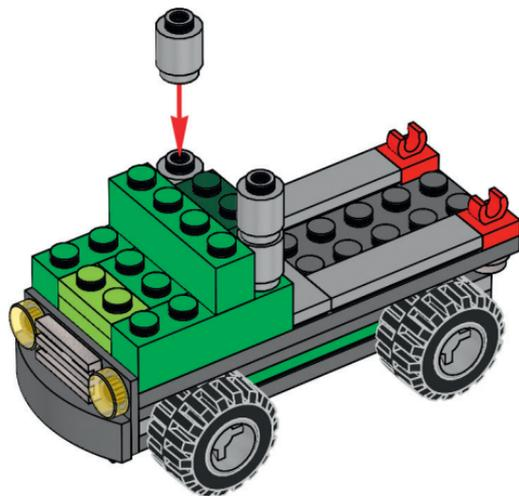



2x

19

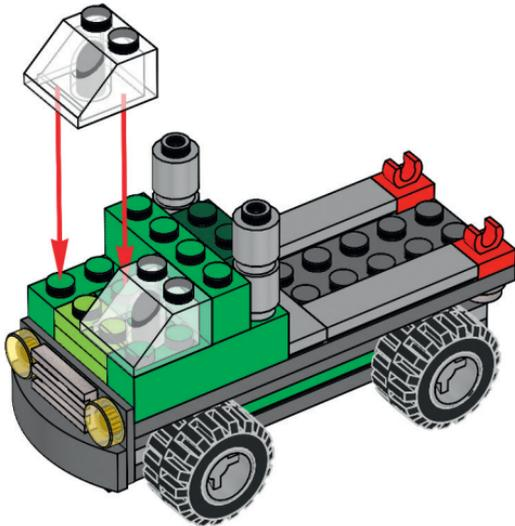

1x

20

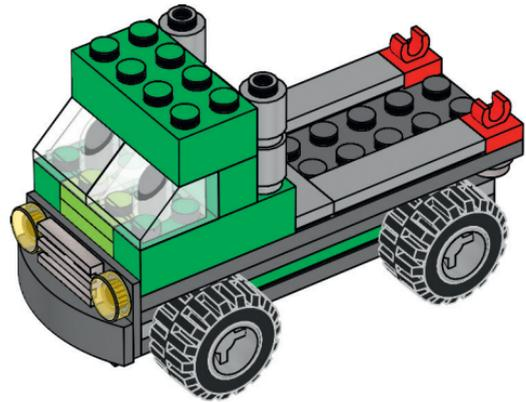

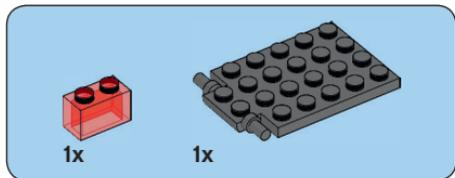
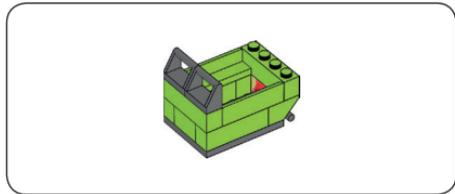

21

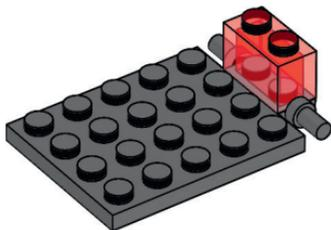



2x

22

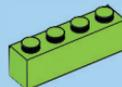
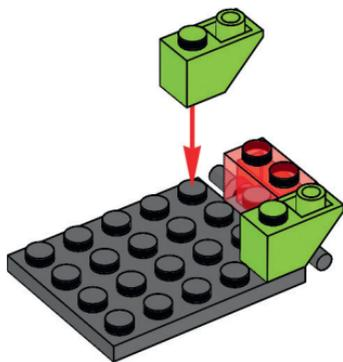

2x

23

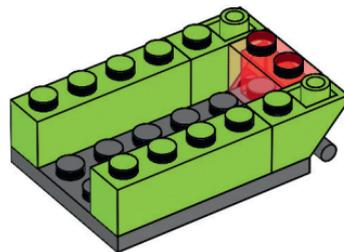



1x

24

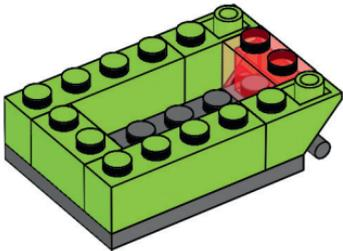

1x

25

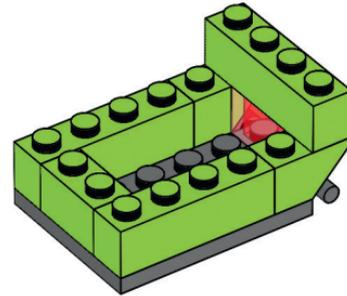

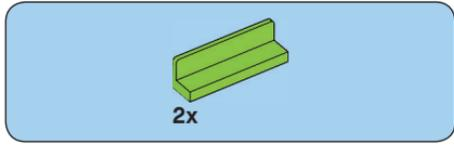

26

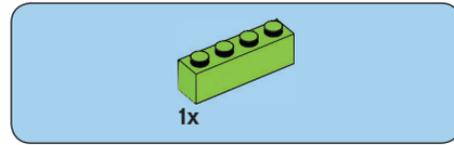
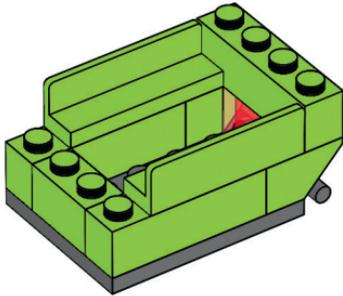

27

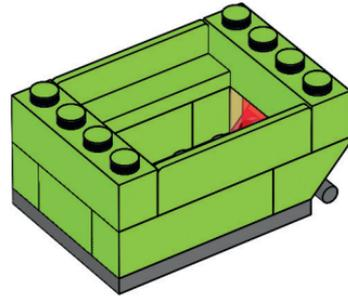



2x

28

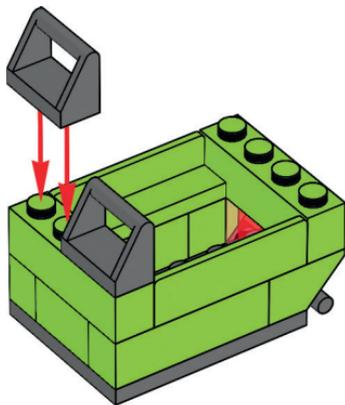

29

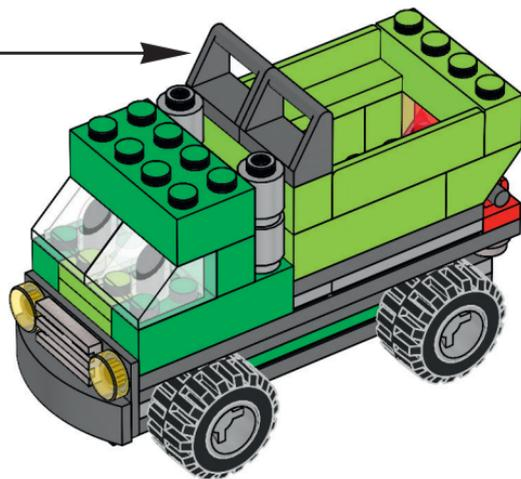



3x

30



3x

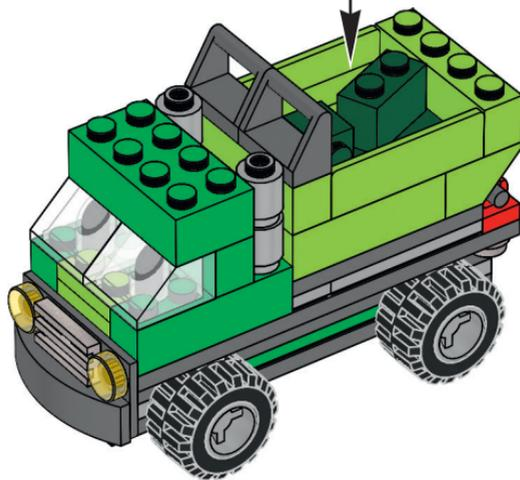

**MORE IDEAS
ONLINE:**

**PLUS D'IDÉES
EN LIGNE :**

**MÁS IDEAS EN
INTERNET:**

LEGO.COM/classic





10698



10696



10692



10699



10700



10701



31060



31054



31055





4x
4518400



6x
614101



4x
6029156



3x
6097402



3x
6099548



4x
300501



2x
6055541



2x
6097801



4x
6058177



4x
4532972



4x
300301



10x
303901



2x
4233370



4x
302101



2x
4530590

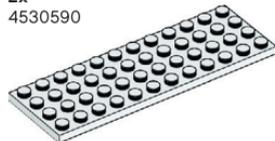

1x
4168072



4x
4121932



2x
6032360



3x
4161734



2x
4579260



4x
4125220



4x
4109995



4x
6092587



2x
6046924



4x
4114306



2x
4118866



4x
4121921



4x
4114309



2x
6139363



4x
4114319



1x
4114001



2x
4113988



4x
614321



4x
6019155



2x
4556153



2x
4226876



6x
302221



4x
6105976



4x
300321



4x
303921



4x
4632572



1x
449521



2x
6170523



2x
487121



8x
300121



4x
366621



4x
362221



4x
300521



2x
6072998

 4x
 362323

 4x
 4509443

 4x
 300223

 4x
 6141996

 4x
 4649773

 4x
 300123

 2x
 366623

 1x
 303423

80

 4x
 4529235

 3x
 614123

 4x
 300523

 4x
 300323

 3x
 614124

 4x
 4624985

 8x
 300424

 4x
 4121965



 2x
 6079007

 4x
 300324



 4x
 303924

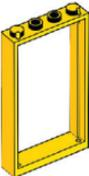

 4x
 300224

 4x
 621524

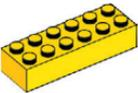
 1x
 4561507

 2x
 6175158

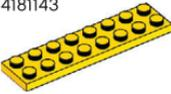
 2x
 4181143

 2x
 303424

 2x
 4221775

 2x
 4504382

 4x
 300526

 4x
 4613162

 4x
 4578677

 2x
 4548180

 4x
 4515373

 4x
 4617848

 4x
 300426

 4x
 4568644

 4x
 428626

 2x
 460026

 1x
 4530589

 2x
 395726

 4x
 302026

 4x
 300126

 2x
 292626

 4x
 300528

 4x
 6112266

 4x
 4121969

 4x
 302228

 4x
 4644085

 4x
 4107637

 1x
 4583718

 4x
 4109674



 3x
 4619599

 4x
 4112838

 2x
 4141737

 3x
 4566179

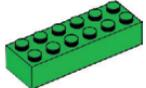
 4x
 4106356

 2x
 6102903

 1x
 4277361

					
2x 6024020	4x 4179830	4x 4177932	4x 4527943	4x 6172869	2x 6093064
					
4x 4167842	4x 4626883	4x 6078590	4x 6030276	3x 6078932	4x 6015454
					
4x 622740	4x 6000881	4x 6013635	4x 4164037	4x 6101073	4x 6184880
					
4x 3006841	2x 4179828	4x 4153825	4x 4164022		4x 4249891
					
4x 306541	4x 4650970	4x 4251969	2x 6170559	2x 6022656	4x 4528981
					
4x 6107790	2x 6101858	4x 4125278	4x 4220632	2x 6037652	2x 4540280
					
2x 4650500		4x 4153827	4x 4234716	4x 6037658	4x 6142695
					
4x 306544		4x 4153827	4x 6092671	4x 6066120	
	1x 4654448	2x 4189007			2x 4667595
4x 3006848			4x 4165967	1x 6170921	

 4x 6092771	 4x 4539061	 4x 6024286	 2x 6075213	 2x 6058130	 4x 4515374	 4x 4211088
 4x 4245570	 4x 6117418	 4x 6122504	 4x 4223303	 1x 4211211	 4x 4211387	 4x 4210978
 4x 6055241	 2x 6089268	 4x 6170916	 2x 4595814	 8x 4211412	 4x 4211428	 2x 4221745
 4x 6020923	 2x 4618986	 4x 6172370	 1x 4542131	 4x 4211506	 2x 4211504	 4x 4211039
 2x 4245566	 1x 6009130	 2x 6045944	 4x 4264755	 2x 4213567	 2x 6031056	 4x 4211135
 4x 4539082	 1x 6009130	 4x 6097511	 2x 6092659	 4x 4211764	 4x 4211356	 4x 4211094
 8x 6052917	 4x 6172766	 2x 6133815	 4x 4211201	 4x 4211398	 4x 4211385	 4x 4211054
 4x 4541544	 4x 6172762	 4x 6062574	 8x 6022105	 2x 4529240	 4x 4648256	 1x 6118832
 4x 4541544	 4x 6172762	 1x 4624507				

WIN

GO TO WWW.LEGO.COM/PRODUCTFEEDBACK AND
GIVE US YOUR SHORT **FEEDBACK** ABOUT THIS
LEGO® SET FOR A CHANCE TO WIN
A COOL LEGO PRIZE.

Terms & Conditions apply

LEGO.com/productfeedback



GEWINNE

Erzähle uns auf
www.LEGO.com/productfeedback

etwas über die Erfahrungen, die du mit
diesem LEGO® Set gemacht hast, und
sichere dir die Chance auf einen coolen
LEGO Preis!

Es gelten die Teilnahmebedingungen

GAGNE

Rends-toi sur
www.LEGO.com/productfeedback

et donne-nous quelques commentaires sur
ce produit LEGO® pour avoir une chance
de gagner un prix LEGO !

Voir Conditions Générales

GANAN

Visita
www.LEGO.com/productfeedback

y envíanos tu opinión acerca de este set
LEGO®. ¡Participarás en el sorteo de un
premio LEGO!

Términos y Condiciones aplicables

获取奖品

登录
www.LEGO.com/productfeedback

给出关于此乐高®套装的简短反馈，
就有机会获得炫酷乐高奖品

《条款及条件》适用

LEGO and the LEGO logo are trademarks of the/son des marques de commerce du/son marcas registradas de LEGO Group. ©2017/2018 The LEGO Group.

6259465