



CLASSIC

10717



 [LEGO.com/classic](https://www.lego.com/classic)







LEGO.com/brickseparator



Easy building
Einfach zu bauen
Construction facile
Costruzione facile
Construcción fácil
Construção fácil
Kezdő építőknek
简单拼砌



Medium building
Mittelschwer
Construction intermédiaire
Costruzione media
Construcción intermedia
Construção intermédia
Gyakorló építőknek
中级拼砌



Advanced building
Fortgeschritten
Construction avancée
Costruzione avanzata
Construcción avanzada
Construção avançada
Tapasztalt építőknek
高级拼砌

Page
Seite
Pagina
Página
Oldalszám
页码

Page
6



Page
14



Page
22



Page
30



Page
38





[LEGO.com/classic](https://www.lego.com/classic)

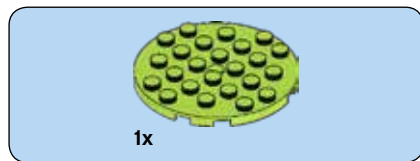



1

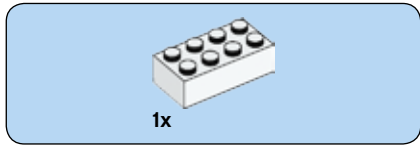



2

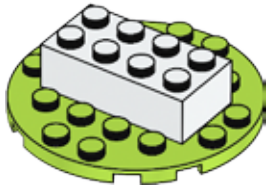

3

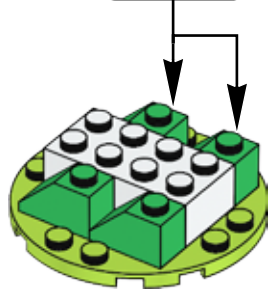

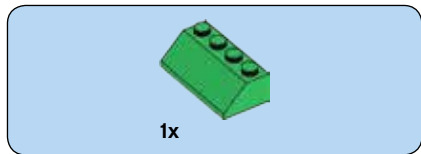

4

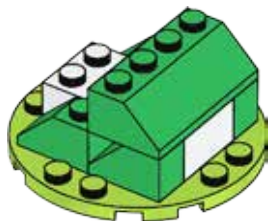



2x

5

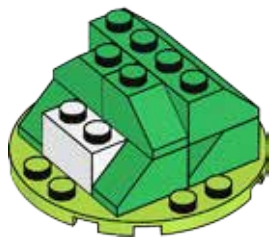

1x

6

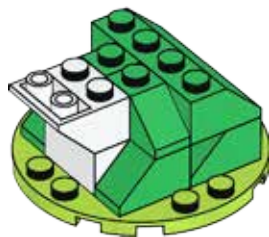



1x

7

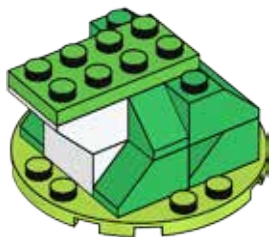



2x

8

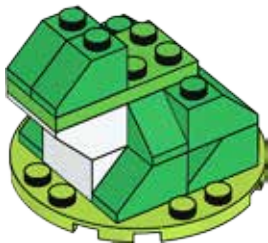

2x



2x

9

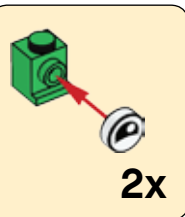

2x

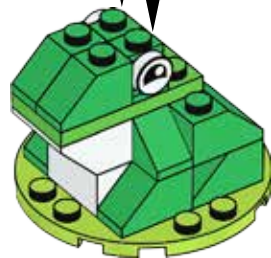



1x

10





11



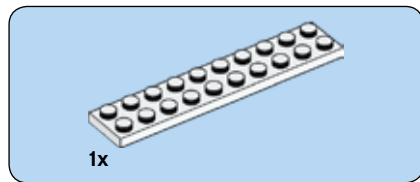

1

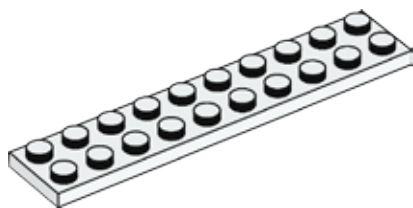



1x

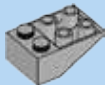

1x

2

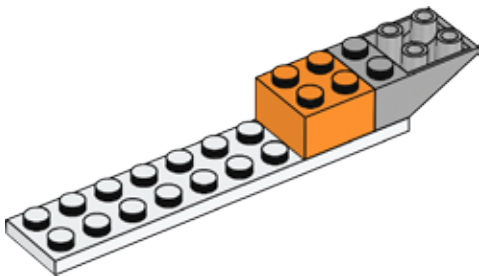



2x

3

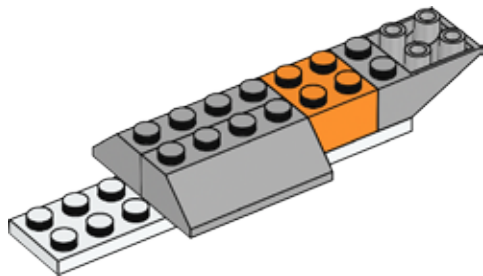

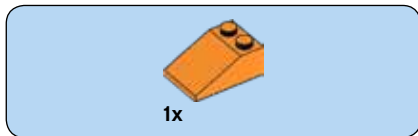

4

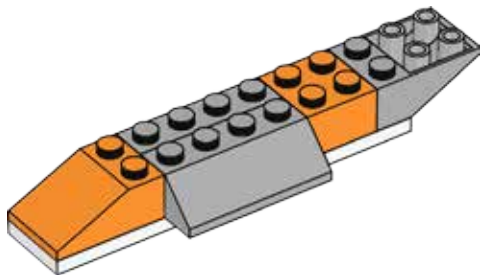

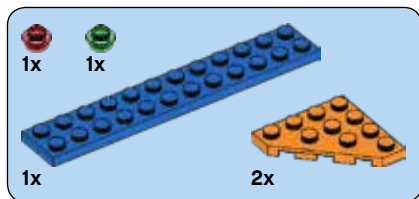

5

1

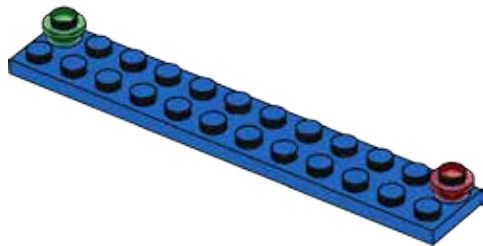

2

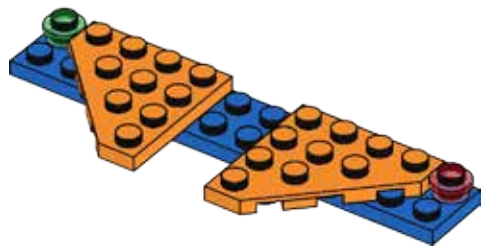

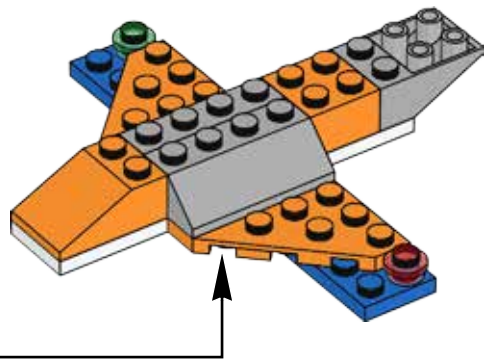

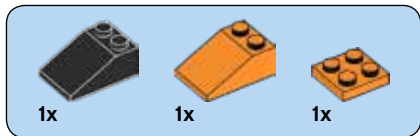

6

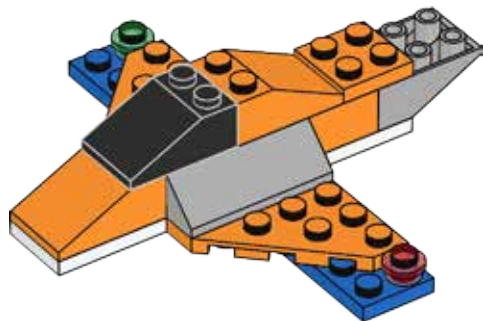

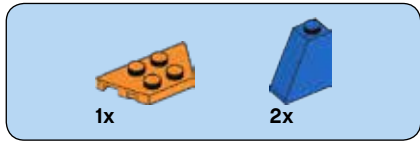

7

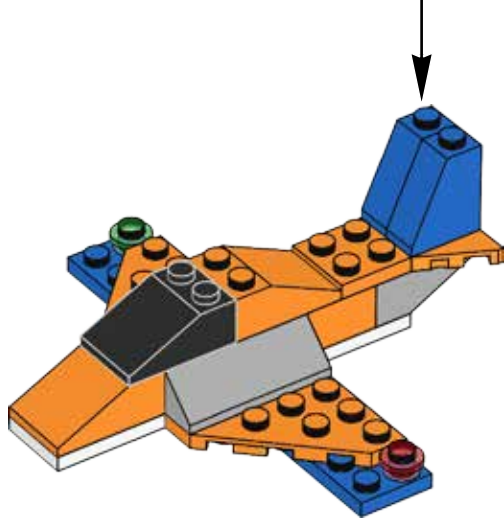
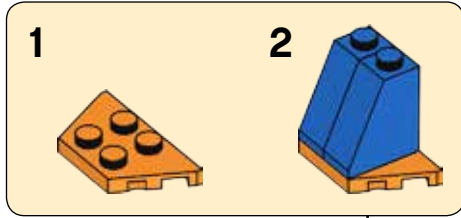

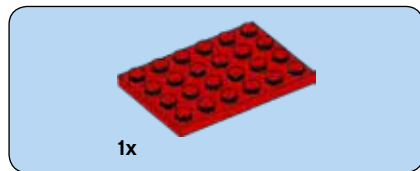

1



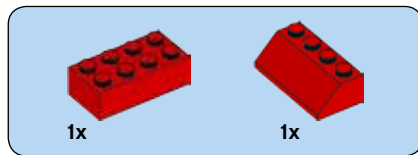

2

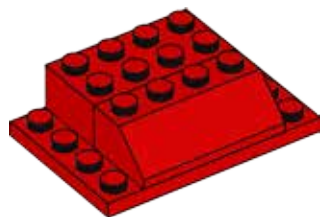

3

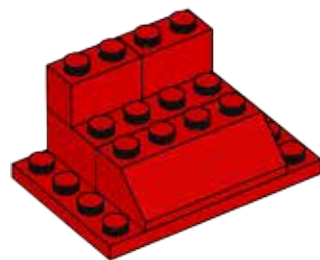

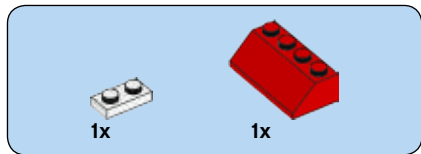

4

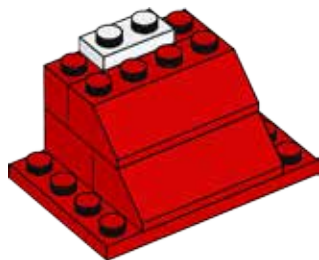

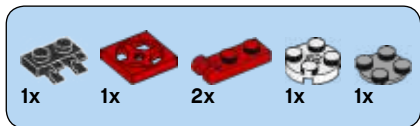

5

1



2

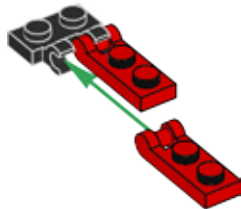

3

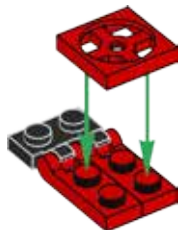

4

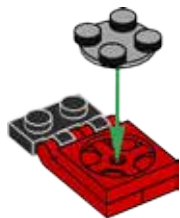

5



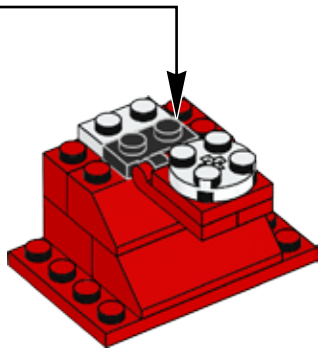

6

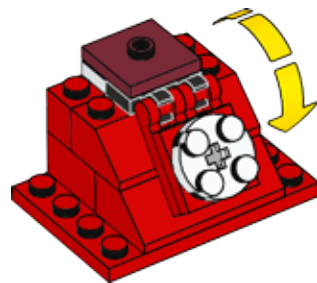

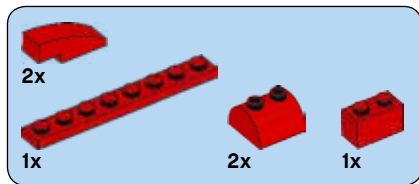

7

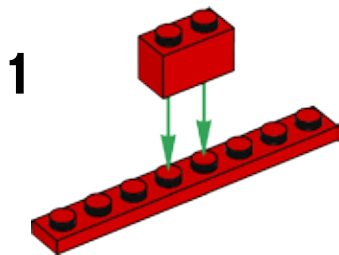

2

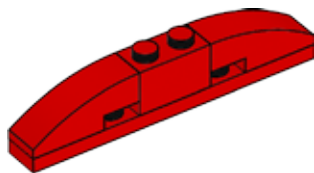

3

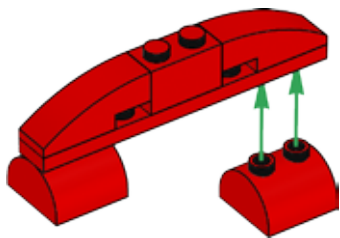

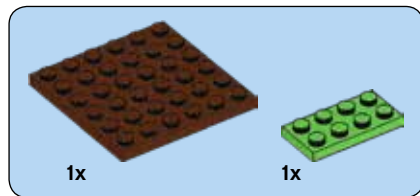

1



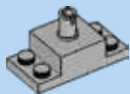

1x

2



2x

3





4x

4



3x



1x

5

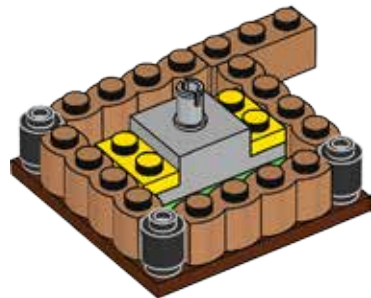



4x

6

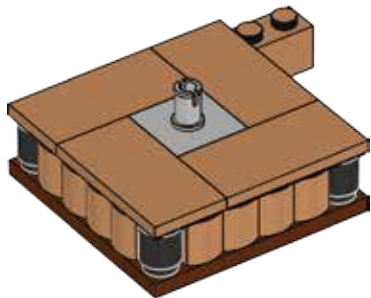

1x

7

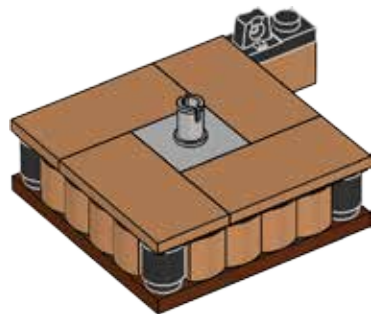

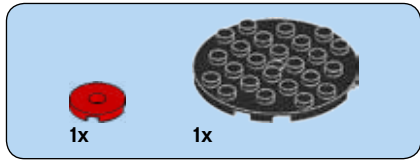

8

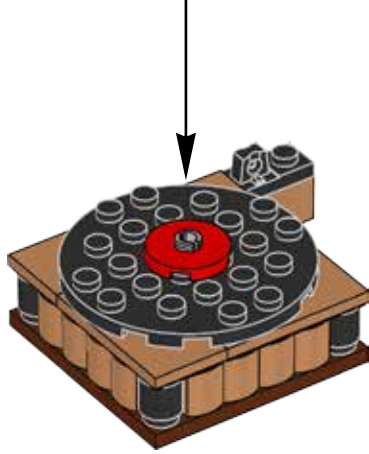
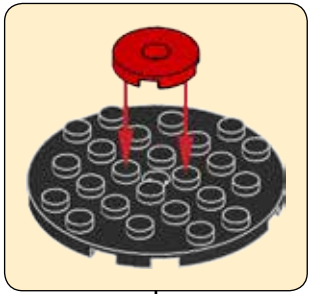

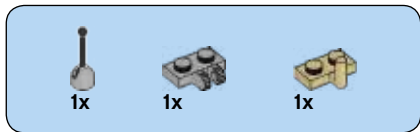

9

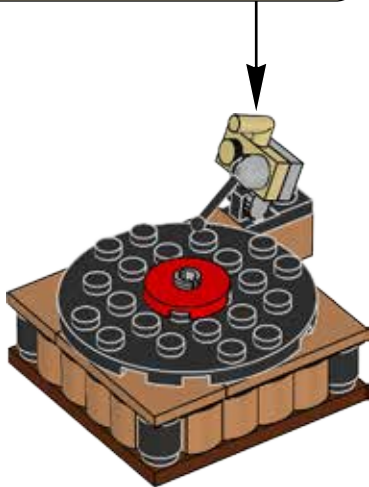
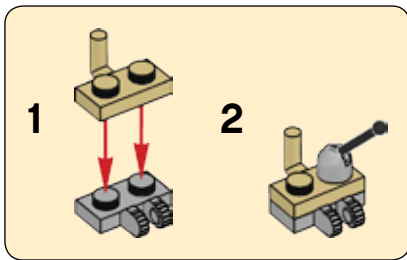

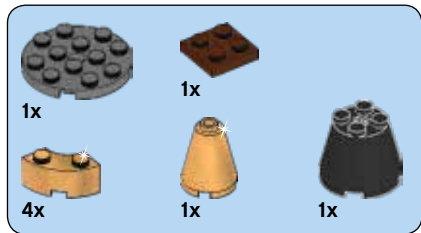

10

1



2

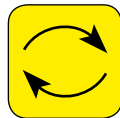

3

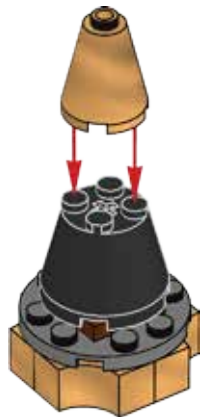

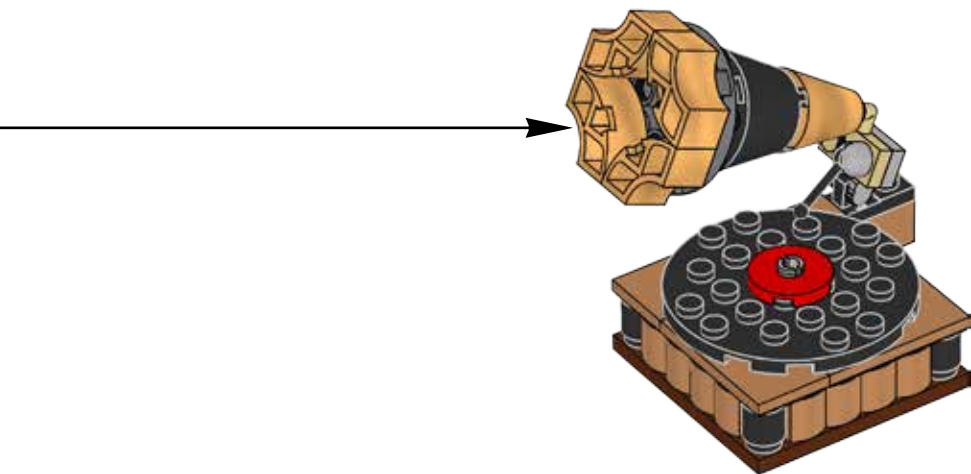

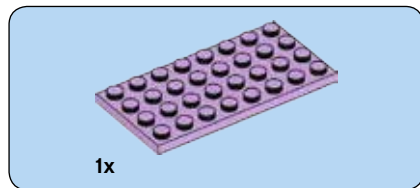

1

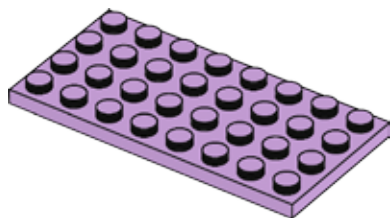



3x

2

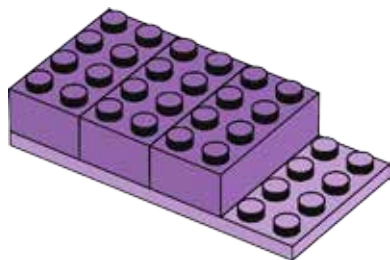

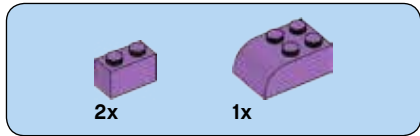

3

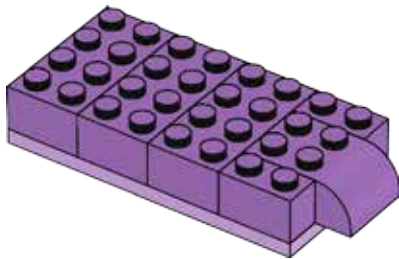

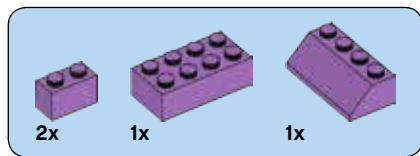

4

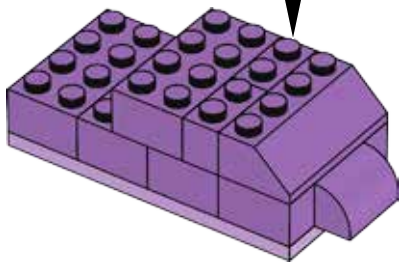
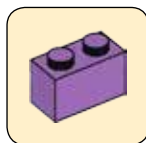

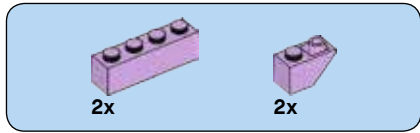

5

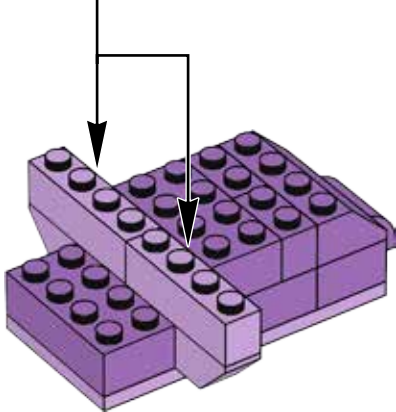
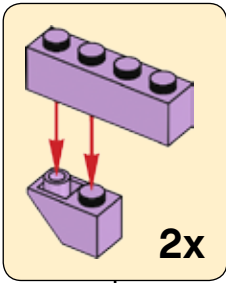

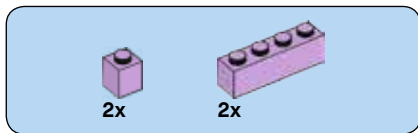

6

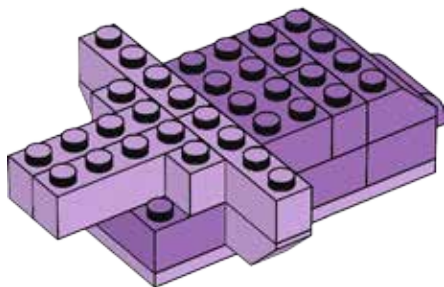

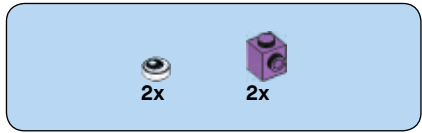

7

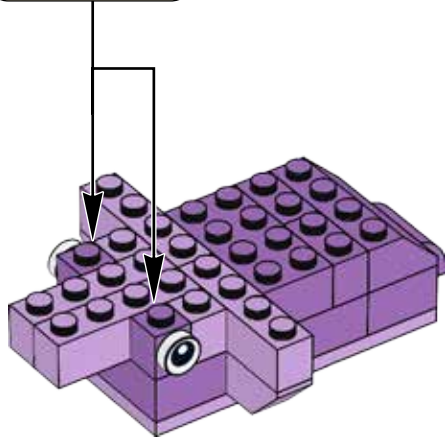
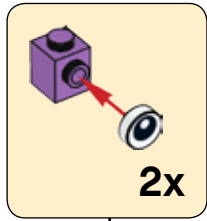



2x



1x

8

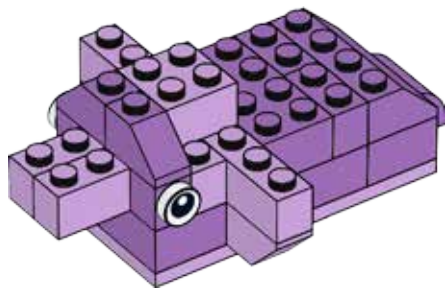

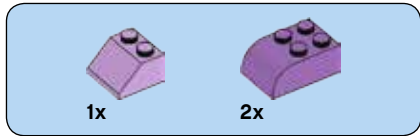

9

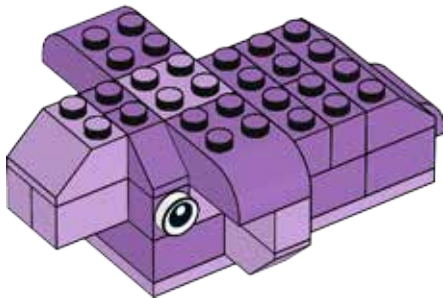



12x

10

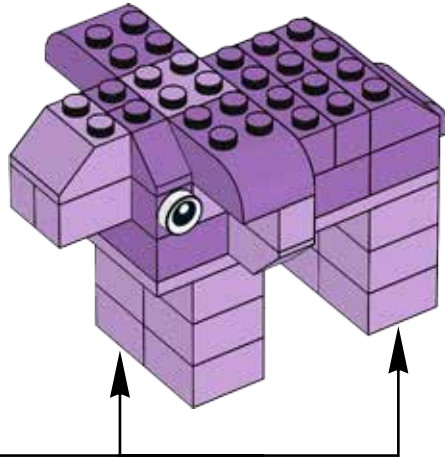
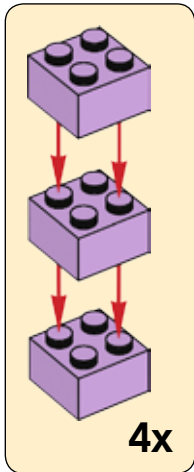

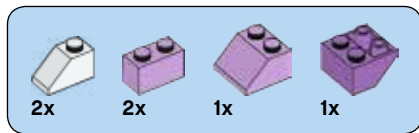

11

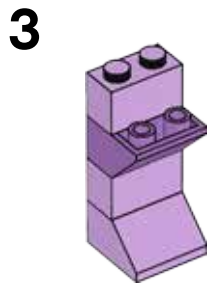
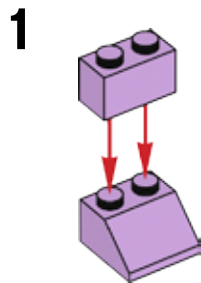

4

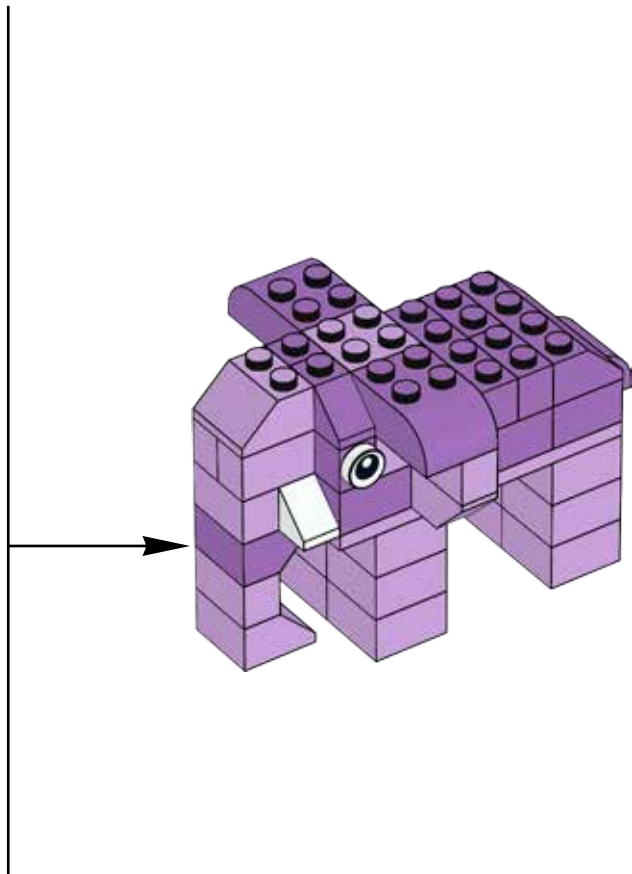
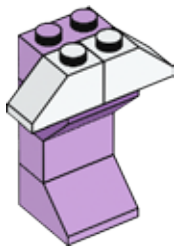

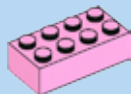

1x

12

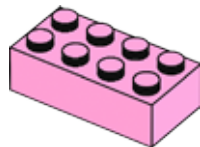



2x

13

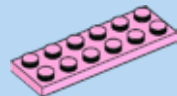
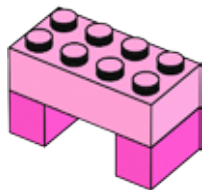

1x

14

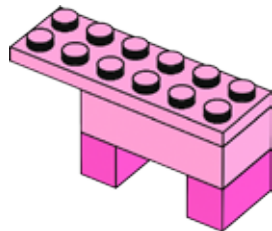



15

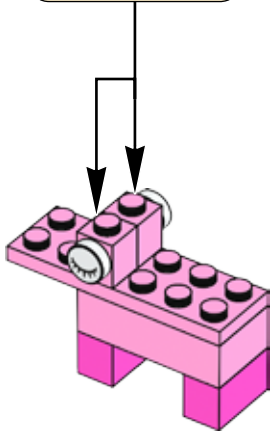
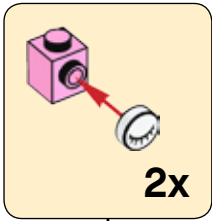



1x



1x

16

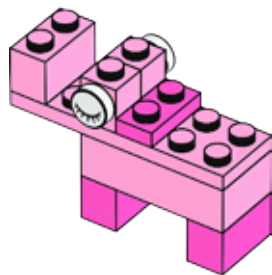

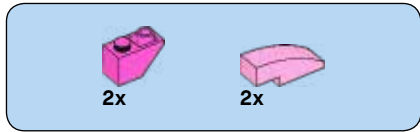

17

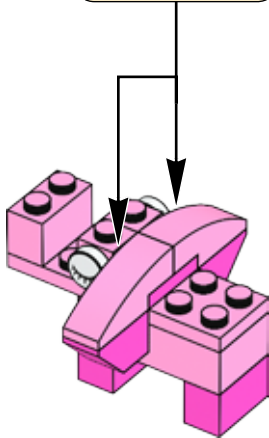
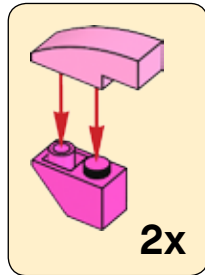

18

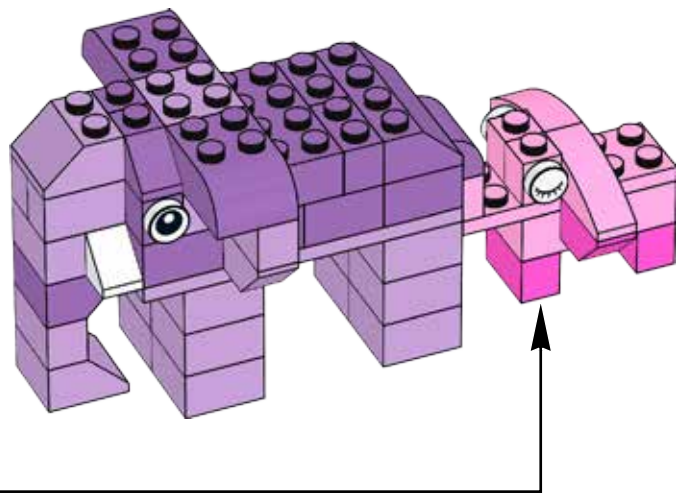

what will you build to help the baby elephant cross the river?

Was wirst du bauen, um dem Elefantenbaby über den Fluss zu helfen?

Que pourrais-tu bien construire pour aider le bébé éléphant à traverser la rivière ?

Cosa costruiresti per aiutare l'elefantino ad attraversare il fiume?

¿Qué puedes construir para ayudar al bebé elefante a cruzar el río?

O que vais construir para ajudar o elefante bebé a atravessar o rio?

Mit építész, hogy segíts a kiselefántnak átkelni a folyón?

你会拼搭些什么帮助小象跨越河流呢？





10698



10696



10700



10714



10713



10701



CREATOR™

3 IN 1



3 in 1
3 en 1
3 em 1
3 az 1-ben
3 合 1

31077





8x
306201



4x
6099548



4x
6029156



4x
6097402



4x
6194809



4x
4558952



4x
4170457



4x
403201



4x
4547489



8x
302301



8x
300401



6x
446001



2x
6153776



4x
4121932



8x
300301



4x
366001



4x
362201



1x
4541956



3x
4530590



4x
302001



8x
300101



2x
4181142



1x
383201



1x
4514842



1x
4168072



6x
4118793



4x
4140562



4x
4125220



36x
4109995



4x
4655257



20x
4162465



4x
4118790



4x
4500453



8x
4159739



2x
4550323



3x
4114309



3x
4112982



4x
4529234



8x
300521



2x
6102138



16x
300421



2x
370021

4x
4121934



2x
368021



4x
4521852



4x
4515365



8x
362221



4x
362321



4x
4251162



8x
303721



4x
300121

2x
346021



2x
303221



4x
459923



8x
300523



4x
6189189



4x
6055065



8x
366523



4x
4514398







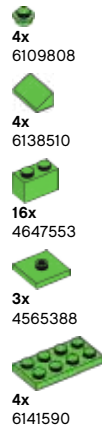
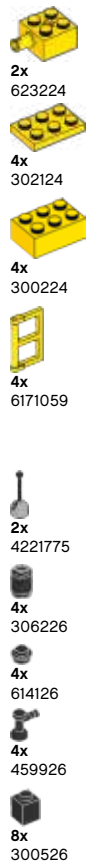
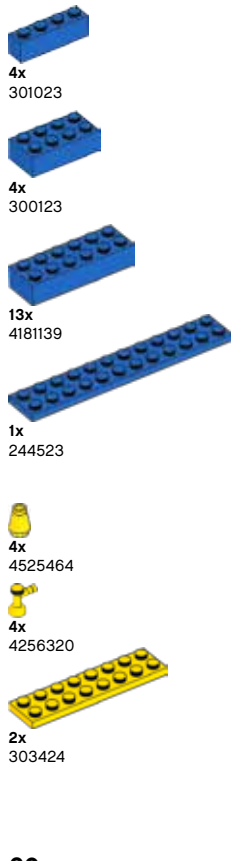

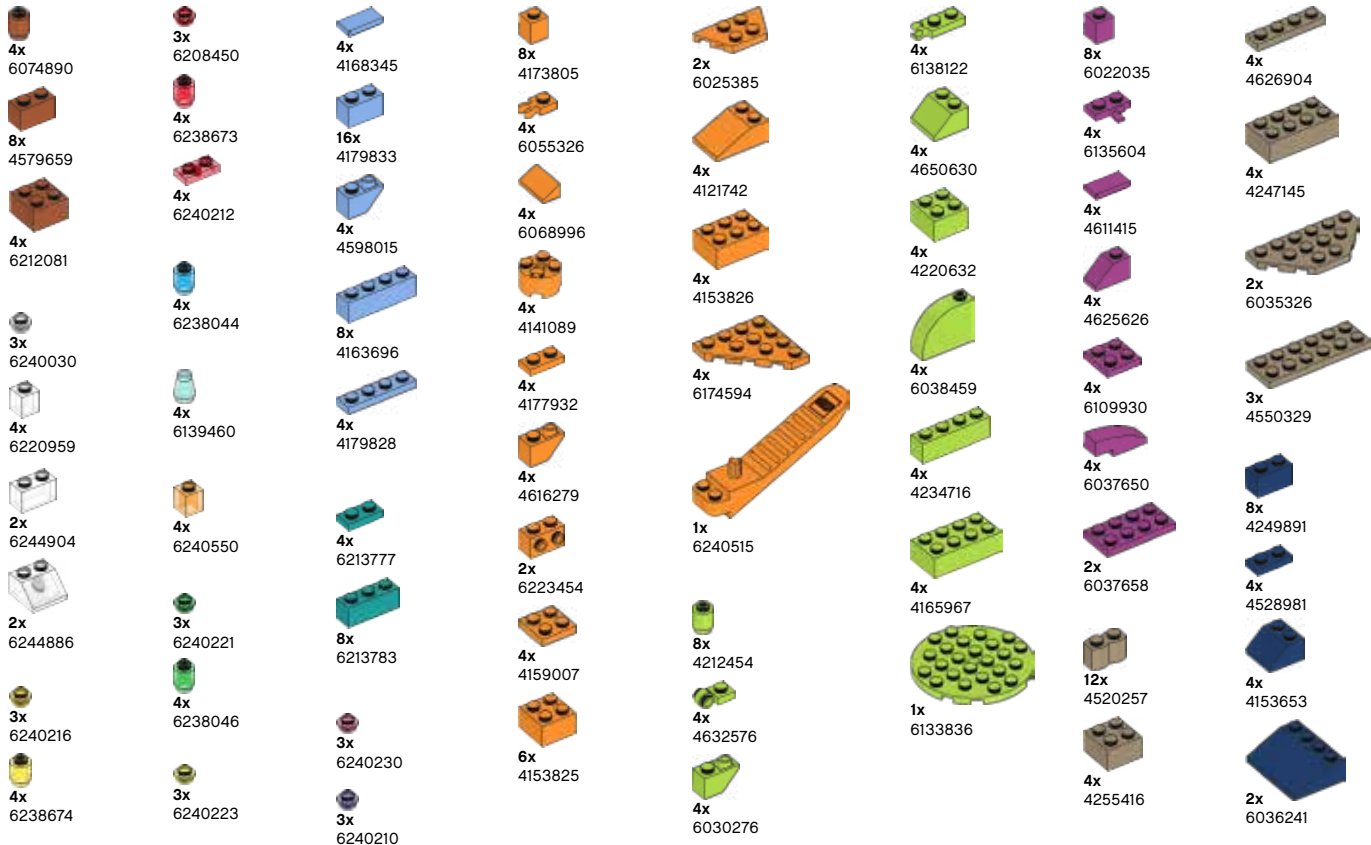

































































4x
302123

4x
300223





 8x 4245570	 8x 4541376	 4x 6122504	 4x 4529242	 4x 4216668	 12x 4211389	 2x 4211570	 4x 4529240
 4x 6003331	 4x 4541506	 4x 6170916	 3x 4216581	 2x 6153594	 2x 4540203	 4x 4211394	 3x 4210633
 4x 6214611	 4x 4539097	 4x 6061688	 4x 4223303	 4x 6096217	 4x 4617170	 2x 4211409	 8x 4558955
 4x 4616578	 4x 4613761	 4x 6022064	 4x 6069984	 4x 6096217	 4x 6000066	 1x 4211666	 4x 4210636
 4x 6186823	 4x 4609925	 4x 6020073	 4x 4629736	 1x 4217848	 4x 4515341	 2x 4618874	 8x 4211063
 4x 6075624	 4x 4539104	 4x 6100027	 4x 4211149	 2x 6096716	 4x 4211350	 2x 6037399	 4x 4211043
 4x 6100234	 4x 6004938	 4x 6182777	 4x 4216695	 12x 4211221	 4x 6198932	 2x 6037399	 2x 4528323
 3x 6240227	 8x 6004943	 4x 6132418	 12x 4211221	 4x 6022032	 4x 4645397	 4x 6022105	 4x 4211085
	 4x 6151671		 2x 6050918	 4x 6192270	 2x 4211504	 4x 6092677	 4x 6036232
	 8x 6036851		 4x 4211220				

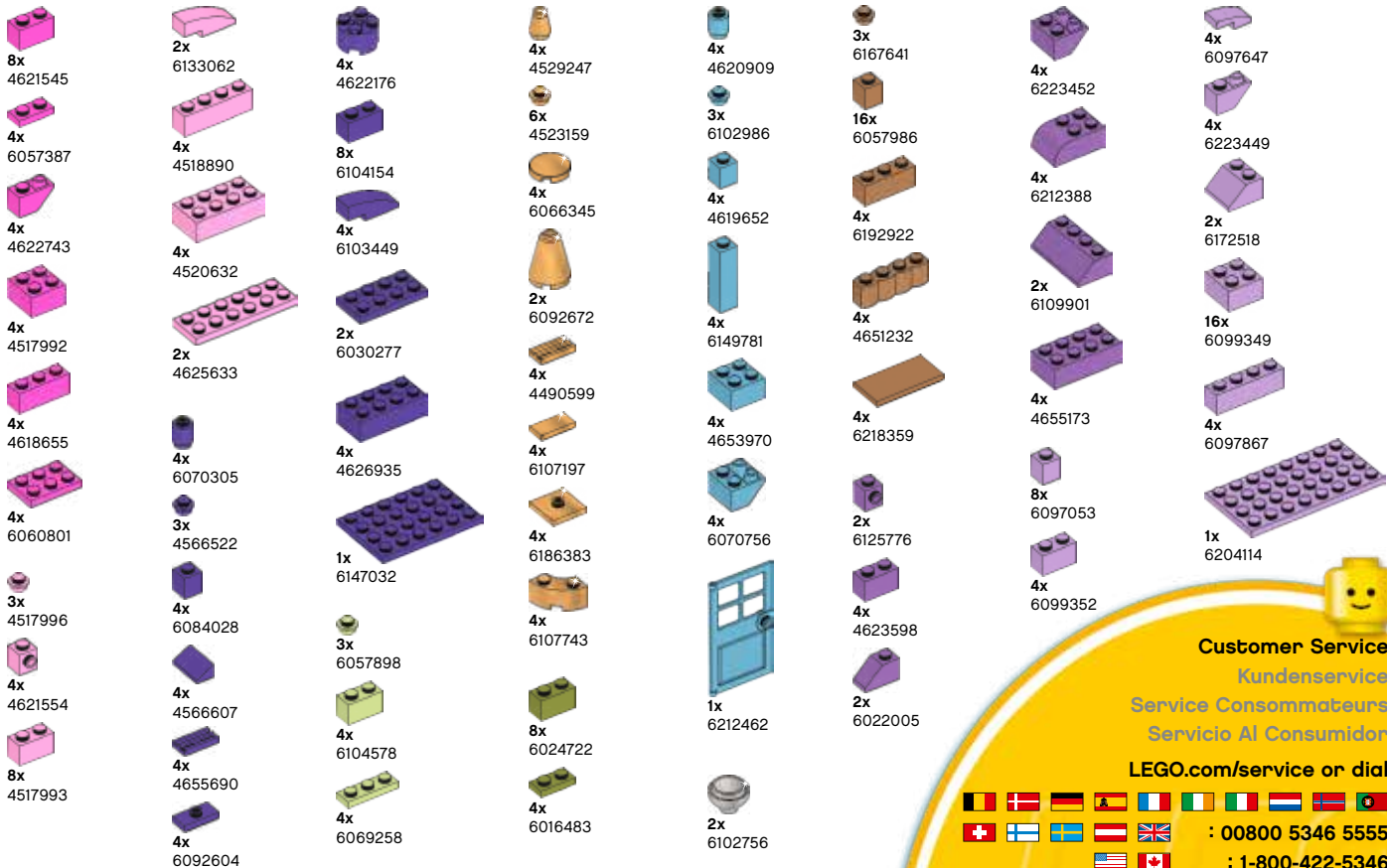

Customer Service

Kundenservice

Service Consommateurs

Servicio Al Consumidor

LEGO.com/service or dial



: 00800 5346 5555

: 1-800-422-5346

WIN

GO TO WWW.LEGO.COM/PRODUCTFEEDBACK AND
GIVE US YOUR SHORT **FEEDBACK** ABOUT THIS
LEGO® SET FOR A CHANCE TO WIN
A COOL LEGO PRIZE.

Terms & Conditions apply

LEGO.com/productfeedback



GEWINNE

Erzähle uns auf
www.LEGO.com/productfeedback

etwas über die Erfahrungen, die du mit
diesem LEGO® Set gemacht hast, und
sichere dir die Chance auf einen coolen
LEGO Preis!

Es gelten die Teilnahmebedingungen

GAGNE

Rends-toi sur
www.LEGO.com/productfeedback

et donne-nous quelques commentaires sur
ce produit LEGO® pour avoir une chance
de gagner un prix LEGO !

Voir Conditions Générales

GANAN

Visita
www.LEGO.com/productfeedback

y envíanos tu opinión acerca de este set
LEGO®. ¡Participarás en el sorteo de un
premio LEGO!

Términos y Condiciones aplicables

获取奖品

登录
www.LEGO.com/productfeedback

给出关于此乐高®套装的简短反馈，
就有机会获得炫酷乐高奖品

《条款及条件》适用

LEGO and the LEGO logo are trademarks of the LEGO Group. ©2018 The LEGO Group.

6242580