



Architecture

21028

New York City

New York, USA

New York

New York, États-Unis

Ciudad de Nueva York

Nueva York (EE. UU.)

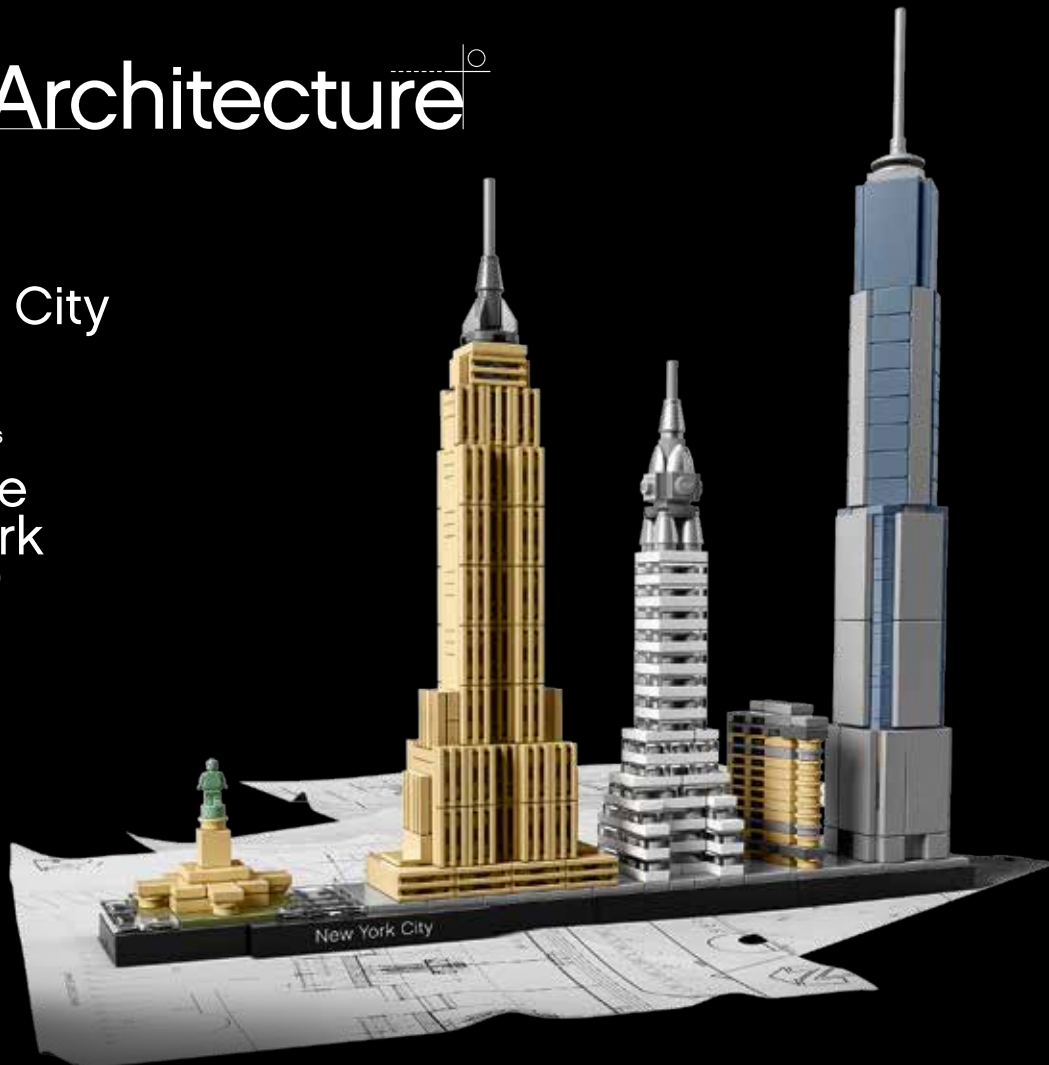

[LEGO.com/architecture](https://www.lego.com/architecture)

New York City

Home to one of the most iconic skylines in the world, New York City sits at the point where the Hudson River meets the Atlantic Ocean.

The city consists of five boroughs—Brooklyn, Queens, Manhattan, the Bronx and Staten Island—and can trace its roots back to 1624, when Dutch colonists founded a trading post called New Amsterdam. Renamed New York in 1664, it has been the United States' largest city since 1790. Today almost 8.5 million people live in an area of just 305 sq. miles (790 km²), which also makes it the most densely populated city in the country.

The city's architecture mixes traditional structures with modern designs, but the skyline is most famous for its skyscrapers. With more than 550 structures over 330 ft. (100 m) high, only Hong Kong has a greater number of tall buildings.

With three of the world's ten most visited attractions—Times Square, Central Park and Grand Central Station—the city is a popular tourist destination with 56 million visitors in 2014. It is often claimed that New York City is the most photographed city in the world.

[“New York is the
only real city-city.”]

Truman Capote



One World Trade Center

As the main building of the World Trade Center complex, the new One World Trade Center tower stands as both a shining beacon for the downtown business district and a bold addition to the New York skyline.

The building was completed in May 2013, when the final section of the 408 ft. (124 m) spire was installed, bringing the structure's height to a symbolic 1,776 ft. (541 m)—a deliberate reference to the year when the United States Declaration of Independence was signed.

Designed by architect David M. Childs from the New York office of Skidmore, Owings & Merrill, the tower ascends from a cubic base, its edges slanting back to form eight isosceles triangles with a perfect octagon near its middle, culminating in a glass parapet at the top.

The enclosed One World Observatory allows visitors a spectacular view of the surrounding city from 1,250 ft. (381 m) above street level. At night, an intense beam of horizontal light is projected from the spire and is visible over 1,000 ft. (300 m) above the tower.

[“There is something in the New York air that makes sleep useless.”]

Simone de Beauvoir



The Statue of Liberty

Standing on Liberty Island at the entrance to New York Harbor, the Statue of Liberty was a welcoming signal to millions of immigrants and a symbol of freedom and democracy in the United States.

Designed by the French sculptor Frédéric Auguste Bartholdi and given as a gift to the United States from the people of France, the robed female figure represents the Roman goddess Libertas. In one hand she raises a torch, in the other she holds a tablet inscribed with the date of the American Declaration of Independence, July 4, 1776.

The 151 ft. (46 m) tall copper statue was constructed in France and shipped in pieces to the completed pedestal on what was then called Bedloe's Island. The dedication ceremony in October 1886 was presided over by President Grover Cleveland and marked by New York's first ever ticker-tape parade.



The Statue of Liberty

Flatiron Building

Although never the tallest building in New York, or even the first building in the United States with a triangular ground plan, the Flatiron Building remains one of New York's most memorable structures.

Sitting on the intersection where Fifth Avenue and Broadway cross, the Flatiron's famous form was dictated by the shape of the plot of leftover land that lay undeveloped as the city raced northward during the second half of the 19th century. In 1901 the architect Daniel H. Burnham was hired to design a new showcase headquarters on the site for Chicago-based contractors The Fuller Company.

Burnham's radical design created a great deal of debate as the massive structure neared completion in 1902. Many New Yorkers believed that the unstable building would fall over at the first gust of wind. The Flatiron withstood both the criticism and the strong winds and, over a century later, stands tall as a groundbreaking engineering marvel.

Valued today at \$190 million, the Flatiron Building continues to function as a popular retail and office space. In 2009, Sorgente Group of America acquired the majority of the Flatiron Building.



Chrysler Building™

At 1,046 ft. (319 m) the Chrysler Building was the world's tallest building for 11 months before being surpassed by the Empire State Building in 1931. It remains the tallest steel-supported brick building in the world and is seen as an outstanding example of classic Art Deco architecture.

It was designed by New York architect William Van Alen for Walter P. Chrysler, chairman of the Chrysler Corporation, and construction commenced in September 1928. Almost 400,000 rivets were used in the creation of the steel skeleton and over 3.8 million bricks were manually laid as the building took shape.

As the building would be the headquarters for an automobile company, many of the architectural details including the gargoyles were modeled after Chrysler automobile parts. The iconic stainless-steel crown is composed of seven radiating arches ending in a 125 ft. (38 m) long spire.

Declared a US National Historic Landmark in 1976, the Chrysler Building is consistently rated one of the finest buildings in New York by architects and scholars. Since the observation deck on the 71st floor officially closed in 1945, visitors today can still view the spectacular Art Deco lobby.

[“The Chrysler Building...
was one of the
most accomplished
essays in the style.”]

John Julius Norwich



Empire State Building

Located in Midtown Manhattan on Fifth Avenue between West 33rd and West 34th streets, the 1,454 ft. (443 m) tall skyscraper was the world's tallest building when it was completed in April 1931. It remained so for nearly 40 years and is still the fourth tallest skyscraper in the United States and the 25th tallest in the world.

Named after the nickname for the State of New York, the Empire State, the distinctive Art Deco-style structure was designed by Brooklyn-born architect William F. Lamb. Construction began in early 1930 and was completed only 410 days later—12 days ahead of schedule. President Herbert Hoover officially opened the 102-story building on May 1, 1931 when he turned on the building's lights directly from Washington.

Over 4 million tourists visit the building's 86th floor observation deck every year to experience a unique panoramic view of New York City. Widely regarded as

an American cultural icon, the Empire State Building was hailed as one of the Seven Wonders of the Modern World by the American Society of Civil Engineers in 1994.

[“From the ruins, lonely
and inexplicable as
the sphinx, rose the
Empire State Building”]

F. Scott Fitzgerald



Empire State Building

New York

Possédant l'un des paysages les plus célèbres au monde, la ville de New York est située à la rencontre du fleuve Hudson et de l'océan Atlantique.

La ville est composée de cinq arrondissements ou *boroughs* : Brooklyn, Queens, Manhattan, le Bronx et Staten Island. Sa création remonte à 1624, lorsque des colons hollandais fondèrent un nouveau poste de commerce appelé New Amsterdam. Rebaptisée New York en 1664, elle est la plus grande ville des États-Unis depuis 1790. Aujourd'hui, presque 8,5 millions d'habitants vivent dans une superficie de seulement 790 km², ce qui en fait aussi la ville la plus densément peuplée du pays.

L'architecture de la ville mélange les structures traditionnelles et les créations modernes, mais le paysage reste surtout célèbre pour ses gratte-ciel.

Avec plus de 550 structures hautes de plus de 100 m, seule Hong Kong a un nombre supérieur de bâtiments de grande hauteur.

Comptant trois des dix attractions les plus visitées au monde (Times Square, Central Park et la gare Grand Central), la ville est une destination touristique populaire avec 56 millions de visiteurs en 2014. On dit souvent que New York est la ville la plus photographiée au monde.

[« New York est la seule véritable ville-ville. »]

Truman Capote



Le One World Trade Center

En tant que bâtiment principal du complexe du World Trade Center, le nouveau One World Trade Center est à la fois un emblème brillant du quartier des affaires et un ajout osé au paysage de New York.

Le bâtiment fut terminé en mai 2013, lorsque la section finale de la flèche de 124 m fut installée, faisant passer la tour à une hauteur symbolique de 541 m, soit 1776 pieds, une référence délibérée à l'année de la signature de la Déclaration d'indépendance des États-Unis.

Conçue par l'architecte David M. Childs du bureau new-yorkais Skidmore, Owings & Merrill, la tour s'élève depuis une base cubique, avec des bords inclinés pour former huit triangles isocèles avec un octogone parfait près de son milieu, et un parapet en verre au sommet.

Le One World Observatory donne aux visiteurs une vue spectaculaire sur la ville, depuis une hauteur de 381 m. La nuit, un rayon horizontal de lumière intense est projeté depuis la pointe et est visible jusqu'à plus de 300 m au-dessus de la tour.

[« Il y a quelque chose dans l'air de New York qui rend le sommeil inutile. »]

Simone de Beauvoir



La Statue de la Liberté

Située sur Liberty Island à l'entrée de la baie de New York, la Statue de la Liberté était un signal de bienvenue pour des millions d'immigrants et un symbole de démocratie et de liberté aux États-Unis.

Conçue par le sculpteur français Frédéric Auguste Bartholdi et offerte aux États-Unis comme cadeau du peuple français, la femme vêtue d'une robe représente la déesse romaine Libertas. Elle tient dans une main une torche, et dans l'autre une tablette où est inscrite la date de la Déclaration d'indépendance américaine, le 4 juillet 1776.

La statue en cuivre haute de 46 m fut construite en France et envoyée en plusieurs morceaux vers le piédestal terminé situé sur l'île, qui s'appelait alors Bedloe's Island. La cérémonie d'inauguration en octobre 1886 eut lieu sous l'égide du président Grover Cleveland et fut marquée par le premier grand défilé à New York.



La Statue de la Liberté

Le Flatiron Building

Le Flatiron n'a jamais été le plus haut bâtiment de New York, ni même le premier immeuble du pays avec un plan triangulaire, mais il reste cependant un symbole célèbre de New York.

Situé au croisement de la Cinquième avenue et de Broadway, la forme célèbre du Flatiron fut dictée par celle de la parcelle de terrain qui restait vacante alors que la ville s'étendait vers le nord pendant la deuxième moitié du XIX^e siècle. En 1901, l'architecte Daniel H. Burnham fut engagé pour créer un nouveau siège social sur le site pour des entrepreneurs basés à Chicago, The Fuller Company.

Le design radical de Burnham suscita beaucoup de débats alors que la construction de sa structure massive s'achevait en 1902. De nombreux New-Yorkais pensaient que la structure allait être instable et tomberait au premier coup de vent. Le Flatiron a résisté aux critiques et aux vents forts et, plus d'un siècle plus tard, demeure une merveille d'ingénierie révolutionnaire.

Évalué aujourd'hui à 190 millions de dollars, le Flatiron Building continue de servir d'espace populaire de commerces et de bureaux. En 2009, le Sorgente Group of America acquit une participation majoritaire dans le Flatiron Building.



Le Chrysler Building™

Haut de 319 m, le Chrysler Building fut le bâtiment le plus haut du monde pendant 11 mois avant d'être dépassé par l'Empire State Building en 1931. Il reste le bâtiment de brique et d'acier le plus haut du monde et est considéré comme un exemple exceptionnel de l'architecture Art déco classique.

Il fut conçu par l'architecte new-yorkais William Van Alen pour Walter P. Chrysler, président de la Chrysler Corporation, et sa construction débuta en septembre 1928. Presque 400 000 rivets furent utilisés pour la création de l'armature en acier et plus de 3,8 millions de briques furent posées manuellement alors que le bâtiment prenait forme.

Le bâtiment allant servir de siège social à un fabricant automobile, beaucoup de détails architecturaux, y compris les gargouilles, furent inspirés par les pièces automobiles de Chrysler. La célèbre couronne en acier inoxydable est composée de sept arches rayonnantes terminées par une flèche haute de 38 m.

Déclaré monument historique national des États-Unis en 1976, le Chrysler Building est constamment noté comme l'un des plus beaux bâtiments de New York par les architectes et les universitaires. Le pont d'observation au 71^e étage ayant officiellement fermé en 1945, les visiteurs doivent aujourd'hui se contenter de visiter la spectaculaire entrée Art déco.

[« Le Chrysler Building...
était l'un des essais les
plus accomplis dans
le style. »]

John Julius Norwich



Le Chrysler Building

L'Empire State Building

Situé au centre de Manhattan sur la Cinquième avenue entre les rues West 33rd et West 34th, ce gratte-ciel haut de 443 m était le plus haut bâtiment du monde lorsque sa construction s'est achevée en avril 1931. Il le resta pendant presque 40 ans et est toujours le quatrième gratte-ciel le plus haut aux États-Unis et le 25^e dans le monde.

Baptisé en l'honneur du surnom de l'État de New York, l'État de l'Empire, sa structure Art déco distinctive fut conçue par l'architecte de Brooklyn William F Lamb. Sa construction commença au début de 1930 et fut terminée en seulement 410 jours, avec 12 jours d'avance. Le président Herbert Hoover inaugura officiellement le bâtiment de 102 étages le 1^{er} mai 1931, lorsqu'il alluma les lumières directement depuis Washington.

Plus de 4 millions de touristes visitent chaque année le pont d'observation du bâtiment au 86^e étage pour

découvrir une vue panoramique unique sur New York. Considéré comme un symbole culturel des États-Unis, l'Empire State Building fut classé comme l'une des sept merveilles du monde moderne par la Société américaine d'ingénieurs civils en 1994.

[« Des ruines, seul et inexplicable comme le sphinx, s'éleva l'Empire State Building. »]

F. Scott Fitzgerald



L'Empire State Building

Nueva York

Con uno de los horizontes más emblemáticos del mundo, Nueva York se asienta en la desembocadura del río Hudson al océano Atlántico.

La ciudad se compone de cinco vecindarios (Brooklyn, Queens, Manhattan, el Bronx y Staten Island) y sus raíces se remontan a 1624, cuando los colonos holandeses fundaron un puesto comercial que llamaron Nueva Ámsterdam. Tras cambiar su nombre por el de Nueva York en 1664, ha sido la ciudad más grande de Estados Unidos desde 1790. Hoy, casi 8,5 millones de personas habitan en un área de tan sólo 790 km², lo cual la convierte también en la ciudad más densamente poblada del país.

La arquitectura de la ciudad mezcla estructuras tradicionales con diseños modernos, aunque su horizonte es célebre por sus rascacielos. Con más de

550 estructuras de altura superior a 100 m, sólo Hong Kong tiene más edificios que cumplan esa condición. Nueva York alberga tres de las diez atracciones más visitadas del mundo (Times Square, Central Park y la estación Grand Central) y recibió 56 millones de visitantes en 2014. A menudo se dice que es la ciudad más fotografiada del mundo.

[«Sin duda, Nueva York es la única ciudad de ciudades».]

Truman Capote



One World Trade Center

Como principal edificio del complejo World Trade Center, la torre One World Trade Center representa un brillante punto de referencia para el distrito de negocios y un audaz complemento para el horizonte de Nueva York.

La construcción terminó en mayo de 2013, con la instalación de la sección final del remate, de 124 m, que lleva la altura del edificio hasta unos simbólicos 541 m (1.776 ft, en clara relación con el año en que se firmó la Declaración de Independencia de Estados Unidos).

Diseñada por el arquitecto David M. Childs, de la sede neoyorkina de Skidmore, Owings & Merrill, la torre parte de una base cúbica cuyos lados se inclinan para formar ocho triángulos isósceles y un octógono perfecto a media altura, terminando en un parapeto superior de vidrio.

El observatorio One World proporciona a los visitantes unas espectaculares vistas de la ciudad a 381 m de altura desde la calle. Por la noche se proyecta un intenso haz de luz horizontal desde el remate, visible más de 300 m por encima de la torre.

[«Hay algo en el aire de Nueva York que hace del sueño una tarea inútil».]

Simone de Beauvoir



Estatua de la Libertad

Erigida en la isla de la Libertad, a la entrada del puerto de Nueva York, la Estatua de la Libertad da la bienvenida a millones de inmigrantes y es un símbolo de libertad y democracia en Estados Unidos.

Diseñada por el escultor francés Frédéric Auguste Bartholdi y regalada a Estados Unidos por el pueblo de Francia, la figura de la mujer con el hábito representa a la diosa romana Libertas. En una mano sostiene una antorcha; en la otra, una tabla grabada con la fecha de la Declaración de Independencia de Estados Unidos: el 4 de julio de 1776.

La estatua, de cobre y con una altura de 46 m, fue fabricada en Francia y enviada por piezas hasta el pedestal construido en lo que hasta entonces era la isla de Bedloe. La ceremonia de dedicación, celebrada en octubre de 1886, fue presidida por el entonces presidente Grover Cleveland y dio lugar al primer desfile con confeti de Nueva York.



Estatua de la Libertad

Edificio Flatiron

Incluso sin ser el edificio más alto de la ciudad (ni siquiera el primer edificio de Estados Unidos de planta triangular), el edificio Flatiron sigue siendo una de las estructuras más reconocibles de Nueva York.

Situado en el cruce entre la Quinta Avenida y Broadway, la popular forma del edificio Flatiron vino dada por la de un terreno que quedó sin construir durante la rápida expansión de la ciudad hacia el Norte en la segunda mitad del siglo XIX. En 1901, el arquitecto Daniel H. Burnham recibió el encargo de diseñar la nueva sede de The Fuller Company, una compañía de Chicago.

El radical diseño de Burnham dio lugar a intensas discusiones al tiempo que la construcción de la enorme estructura se acercaba a su fin en 1902. Muchos neoyorquinos creían que el inestable edificio se derrumbaría con la primera ráfaga de viento. El Flatiron soportó las críticas y los fuertes vientos y, más de un siglo después, continúa siendo una revolucionaria maravilla de la ingeniería.

Valorado actualmente en 190 millones de dólares, el edificio Flatiron alberga populares tiendas y espacio para oficinas. En 2009, Sorgente Group of America adquirió la mayor parte del edificio Flatiron.



Chrysler Building™

Con 319 m de altura, el edificio Chrysler fue el más alto del mundo durante 11 meses, antes de que el edificio Empire State lo superase en 1931. Sigue siendo la estructura de ladrillo reforzada con acero más alta del mundo y representa un extraordinario ejemplo de arquitectura clásica art déco.

Fue diseñado por el arquitecto neoyorkino William Van Alen para Walter P. Chrysler, presidente de Chrysler Corporation, y su construcción comenzó en septiembre de 1928. La estructura de acero requirió casi 400.000 remaches; se colocaron más de 3,8 millones de ladrillos manualmente conforme el edificio tomaba forma.

Dado que sería la sede de un fabricante de automóviles, muchos detalles arquitectónicos, como las gárgolas, se modelaron como piezas de automóviles Chrysler. La emblemática corona de acero inoxidable se compone de siete arcos superpuestos que terminan en un largo remate de 38 m.

Declarado Monumento Histórico Nacional de EE. UU. en 1976, arquitectos y expertos coinciden al considerar el edificio Chrysler uno de los mejores edificios de Nueva York. La plataforma de observación, situada en la planta 71, fue cerrada en 1945, por lo que los visitantes deben conformarse con las vistas del espectacular vestíbulo art déco.

[«El edificio Chrysler...
fue uno de los
representantes más
logrados del estilo».]

John Julius Norwich



Edificio Empire State

Situado en el centro de Manhattan, entre la Quinta Avenida y las calles 33 Oeste y 34 Oeste, este rascacielos, de 443 m de altura, era el edificio más alto del mundo cuando se construyó en abril de 1931. Continuó siéndolo durante casi 40 años y todavía es el cuarto rascacielos más alto de Estados Unidos y el 25° más alto del mundo. Llamado así por el apodo que recibe el estado de Nueva York, el particular estilo art déco del Empire State fue obra del arquitecto William F. Lamb, nacido en Brooklyn. La construcción comenzó a principios de 1930 y se completó tan sólo 410 días después (12 días antes de lo previsto). El presidente Herbert Hoover inauguró oficialmente el edificio, de 102 plantas, el 1 de mayo de 1931, prendiendo las luces directamente desde Washington.

Cada año, 4 millones de turistas visitan la plataforma de observación del edificio, situada en la planta 86, para

disfrutar de una extraordinaria panorámica de la ciudad de Nueva York. Ampliamente considerado un icono de la cultura americana, el edificio Empire State fue nombrado una de las siete maravillas del mundo moderno por la Sociedad Americana de Ingenieros Civiles en 1994.

[«De entre ruinas, tan solitaria e inexplicablemente como la Gran Esfinge, surge el edificio Empire State»]

F. Scott Fitzgerald



Edifício Empire State

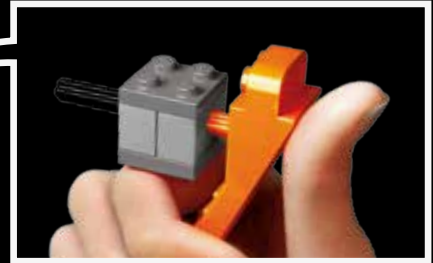
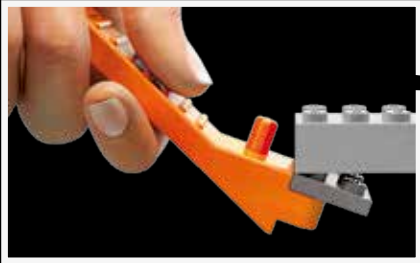

LEGO.com/brickseparator

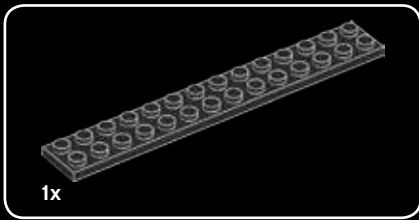

1

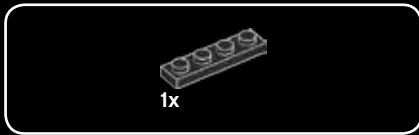
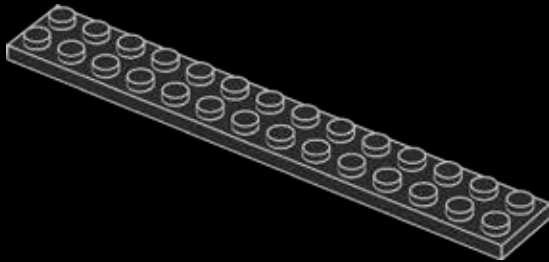

2

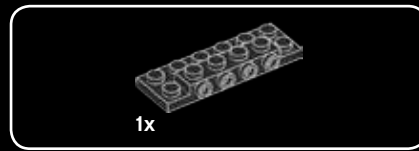
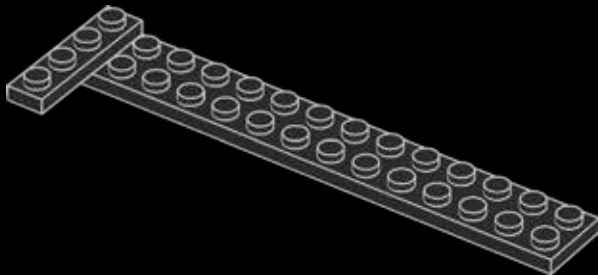

3

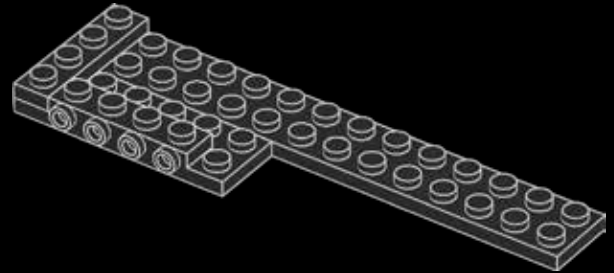

4

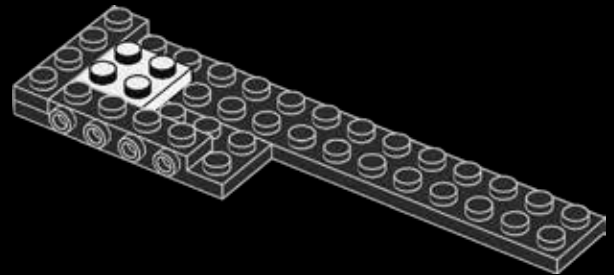

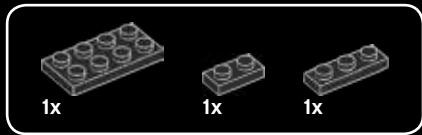

5

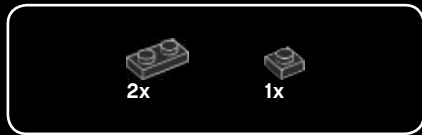
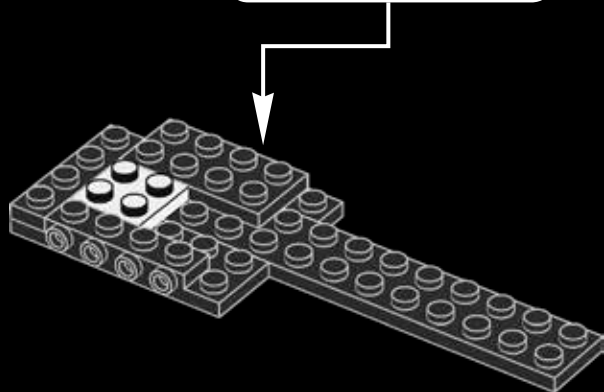
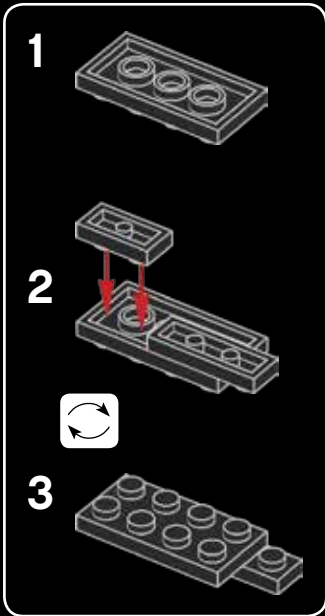

6

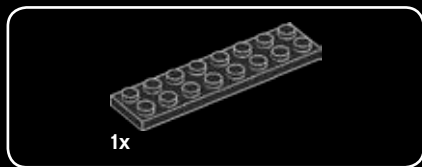
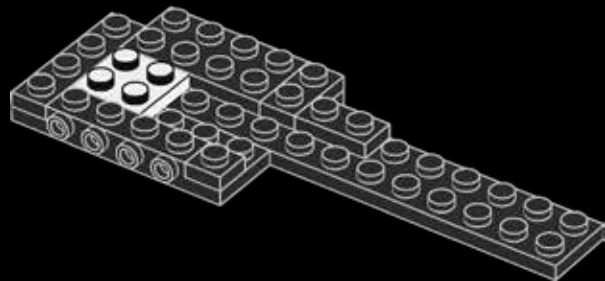

7

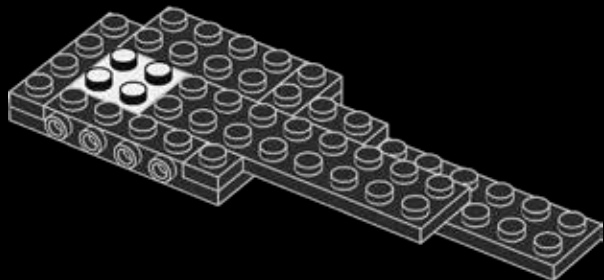



8

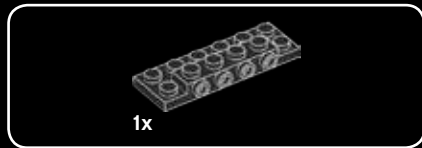
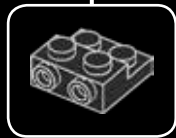
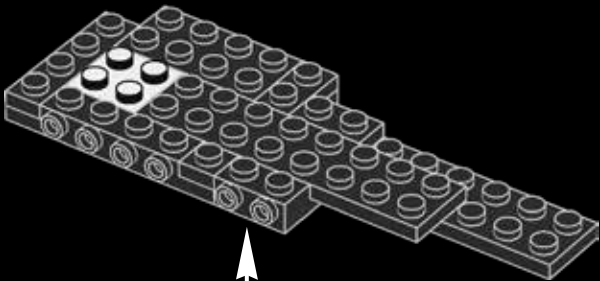

9

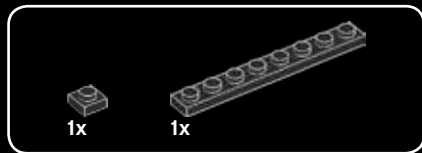
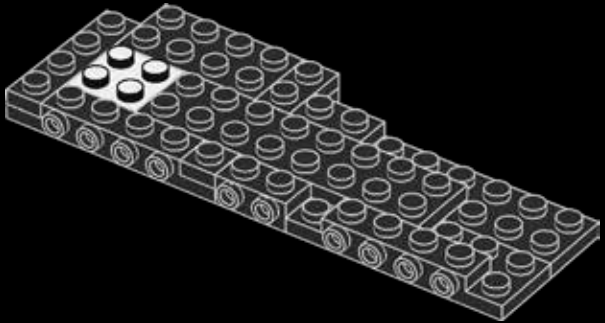

10

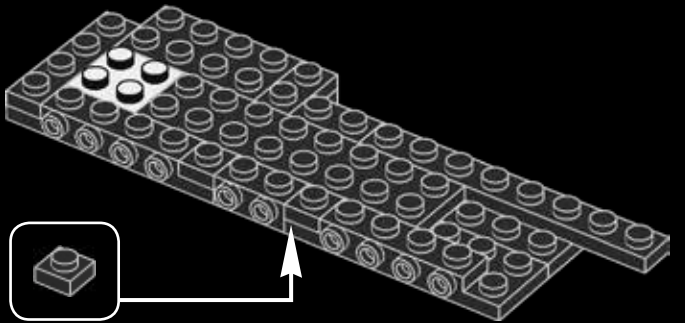

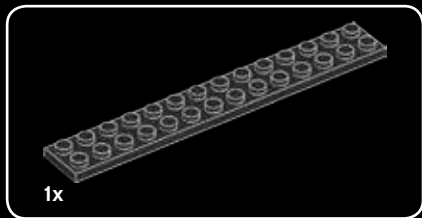

11

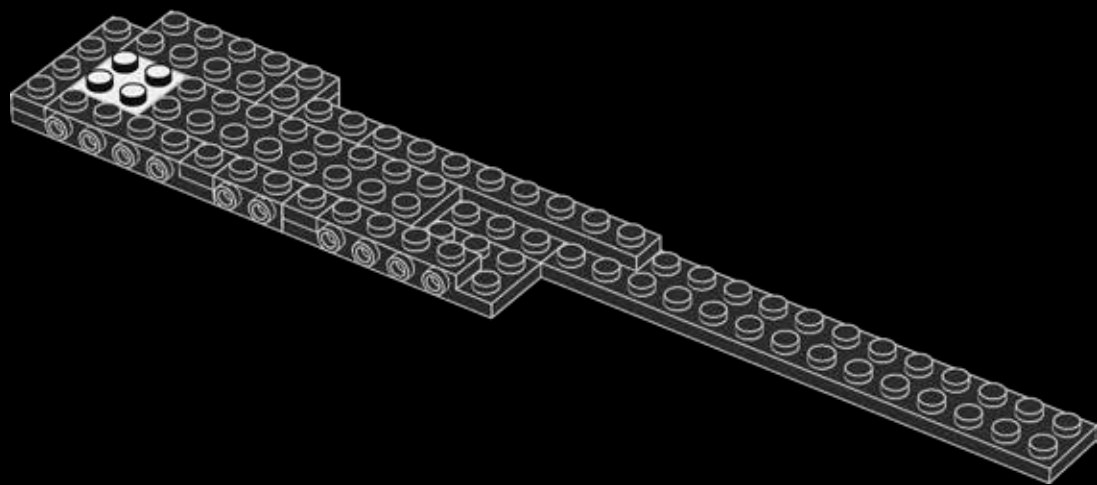

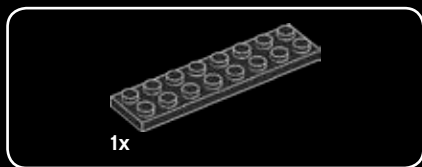

12

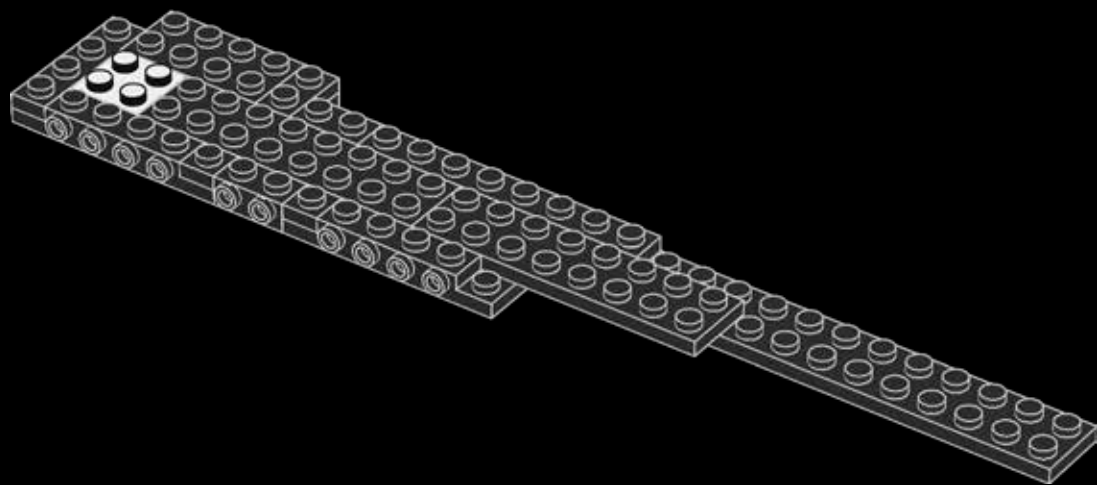



13

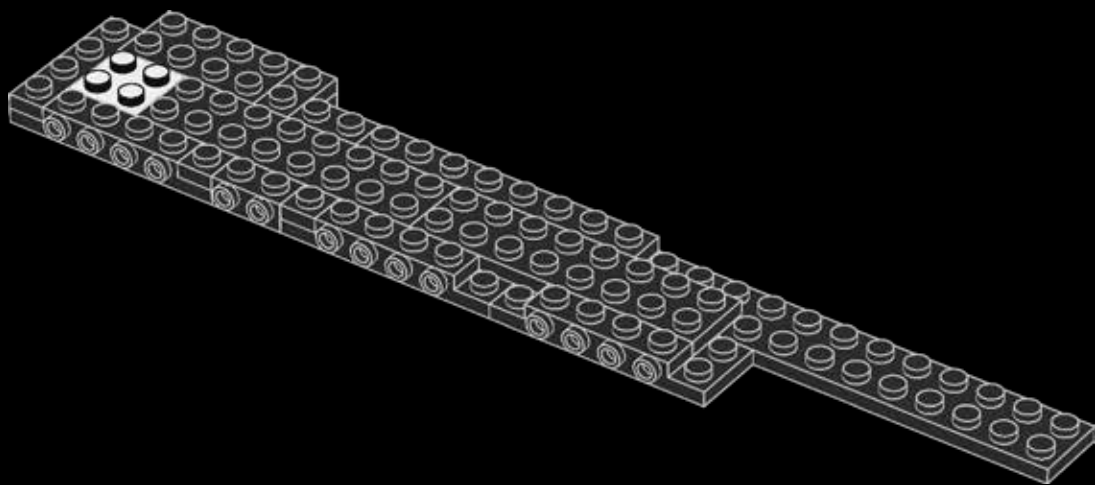

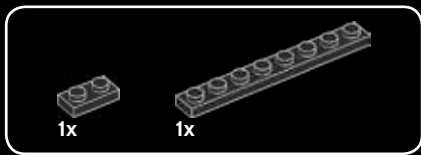

14

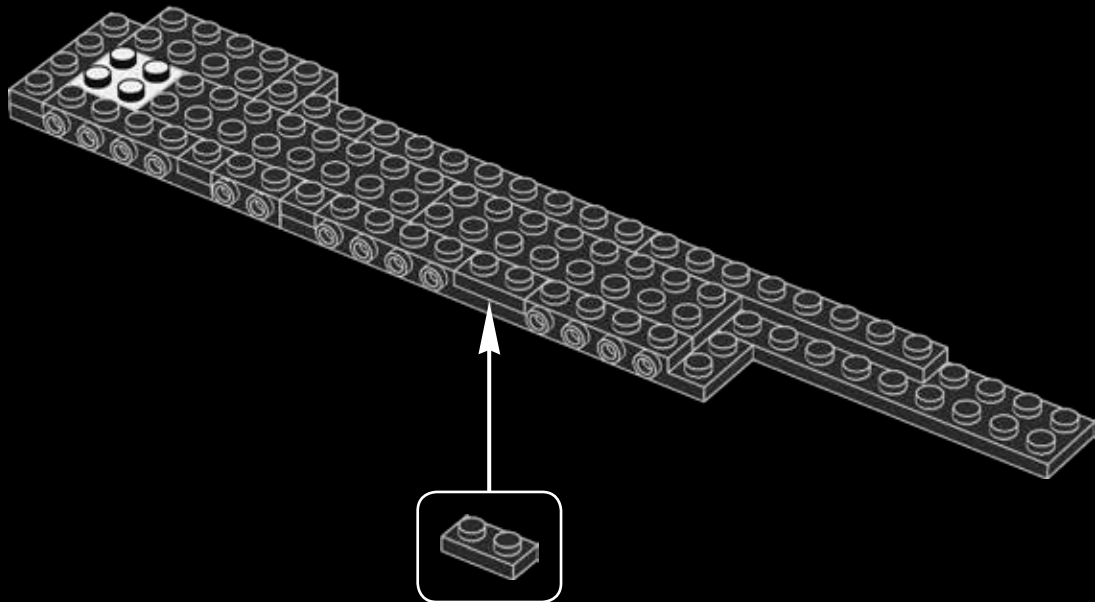

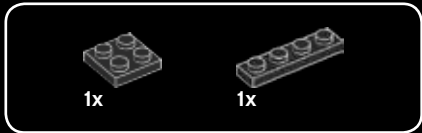

15

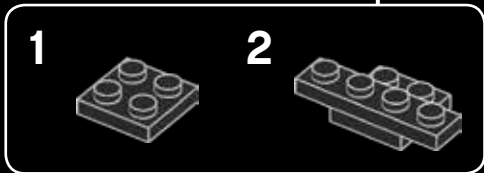
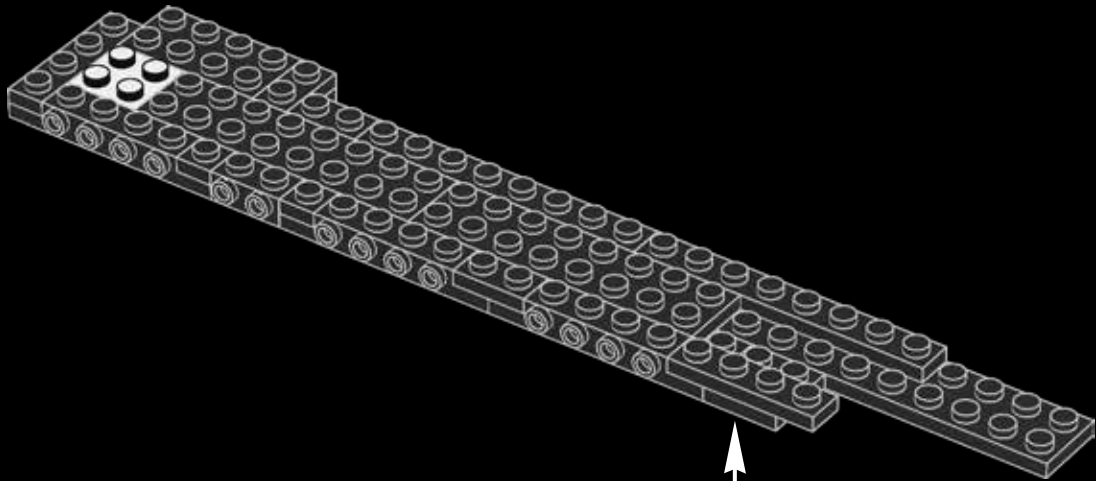

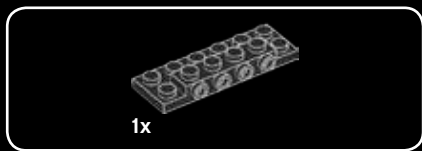

16

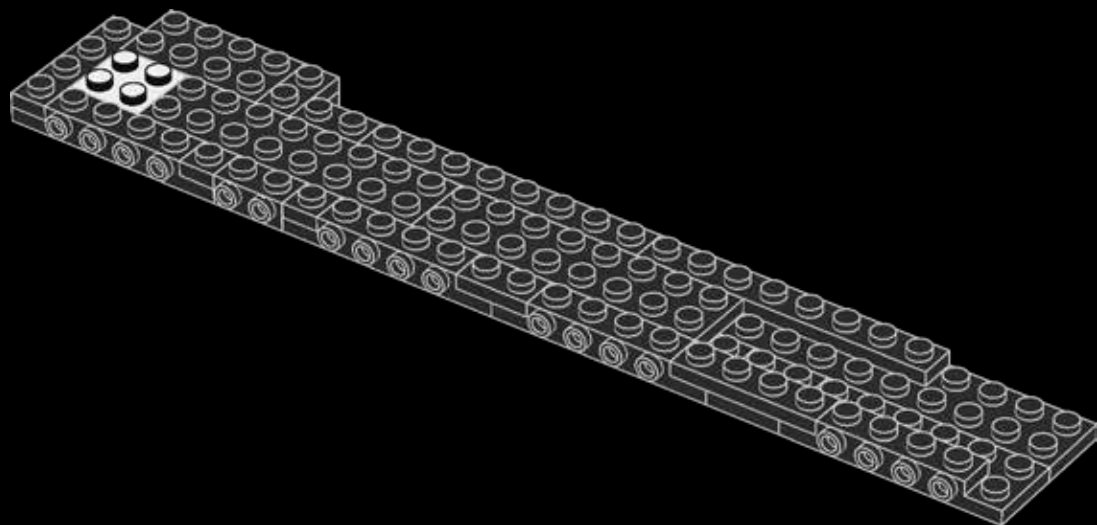

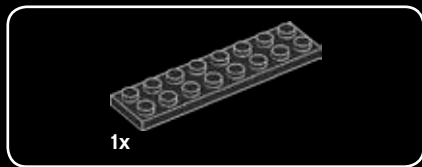

17

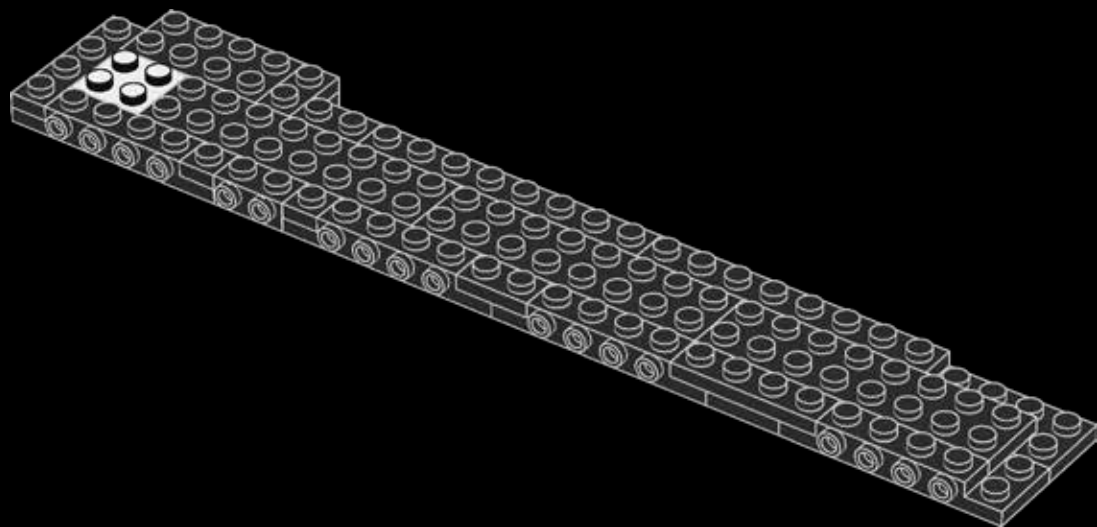

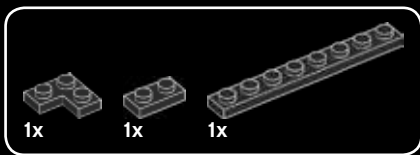

18

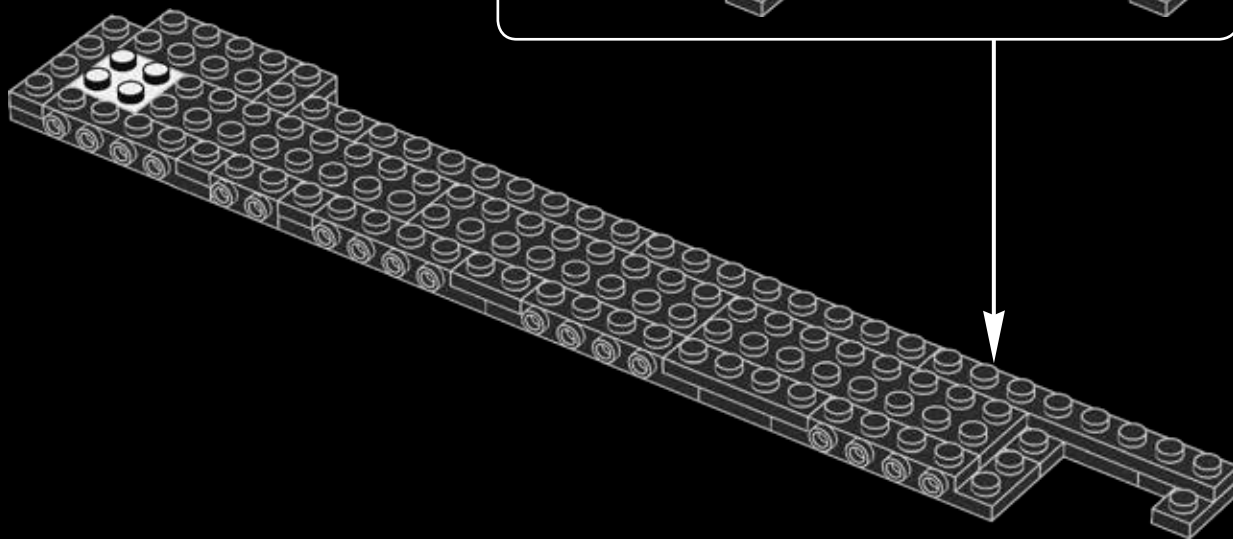
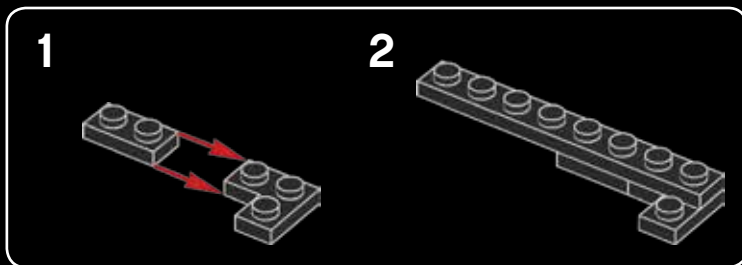



1x

19

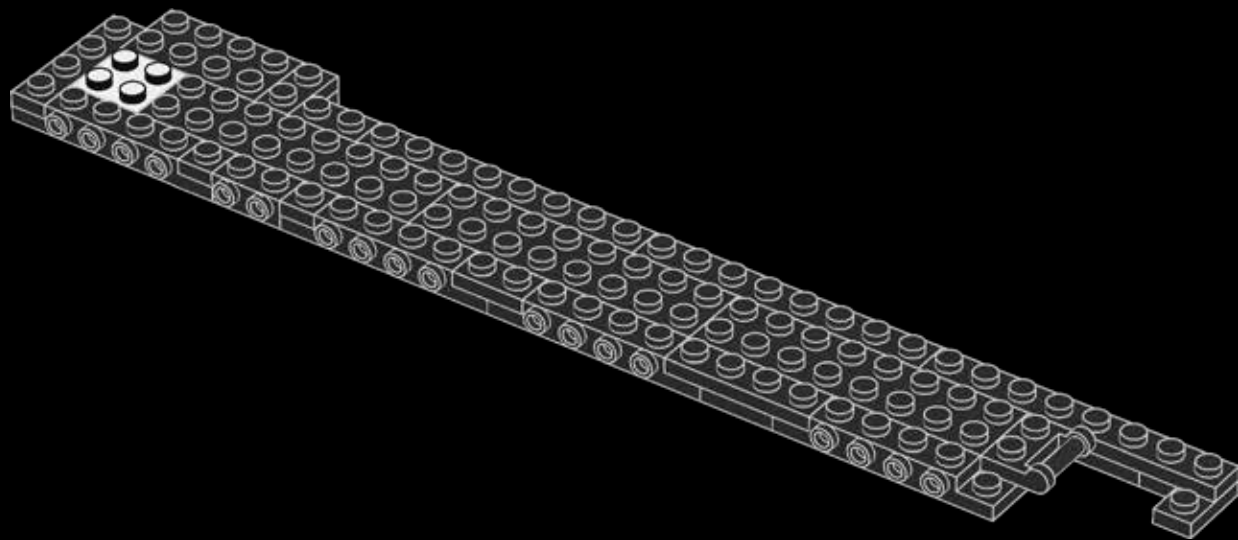



20

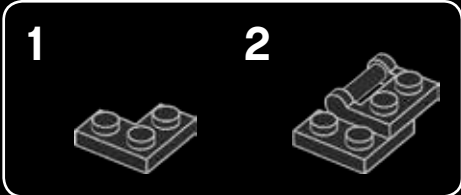
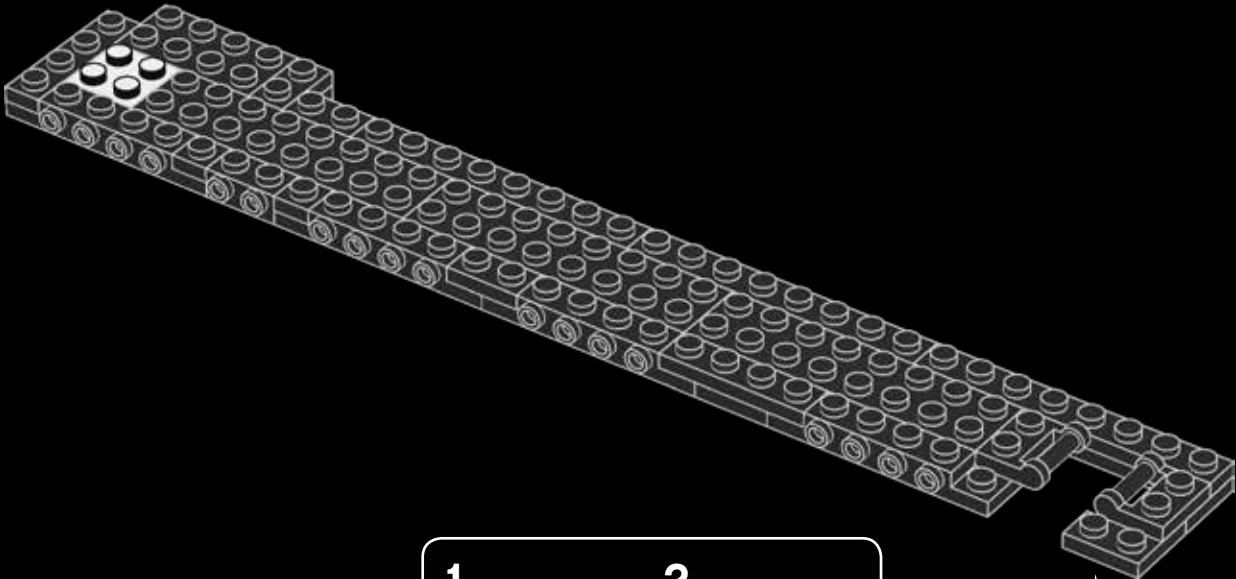



21

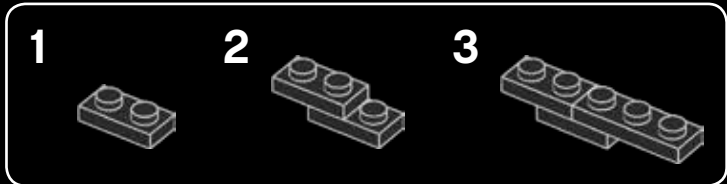
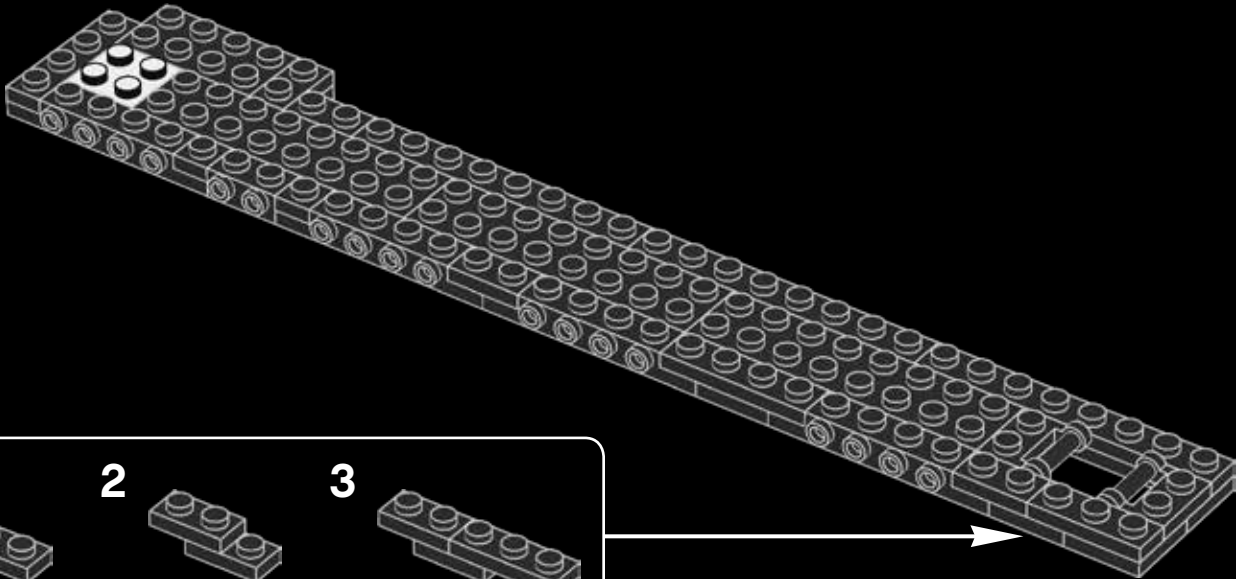

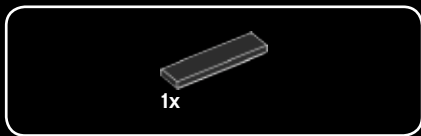

22

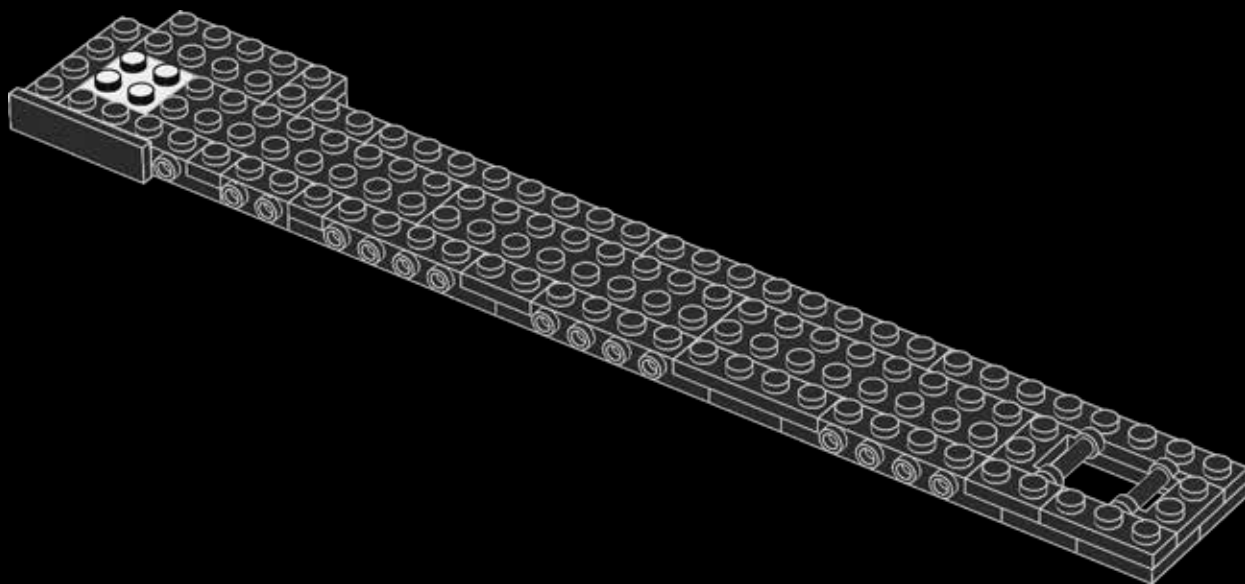

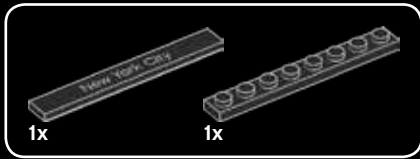

23

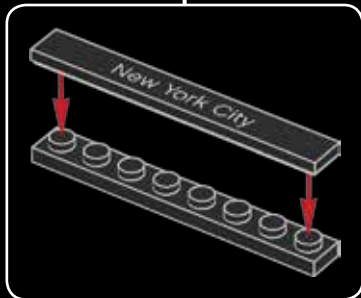
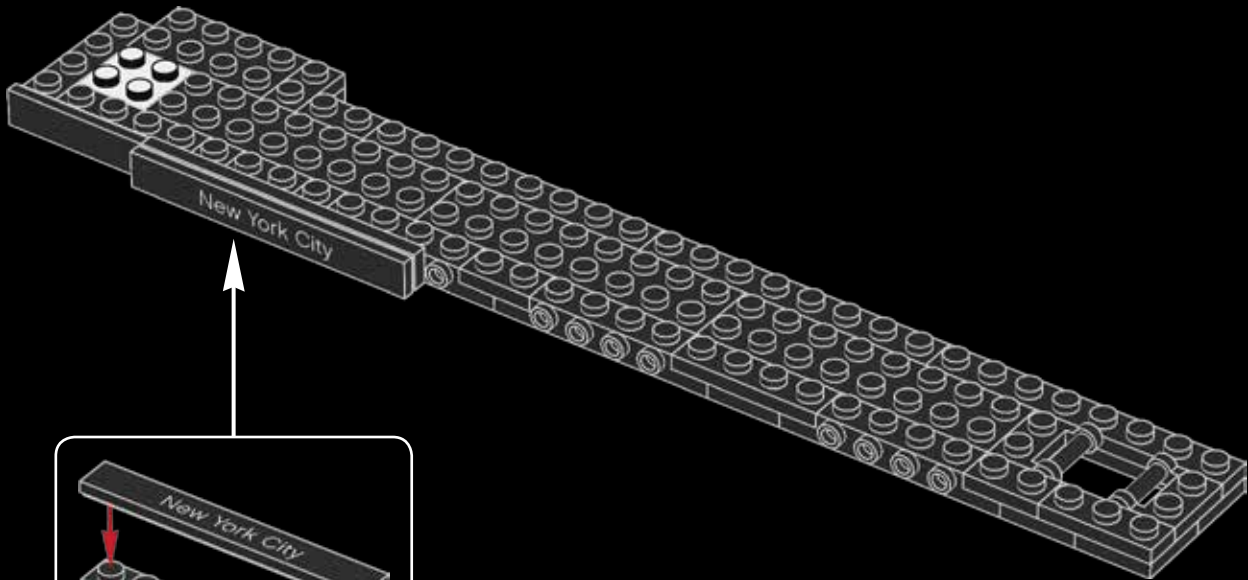

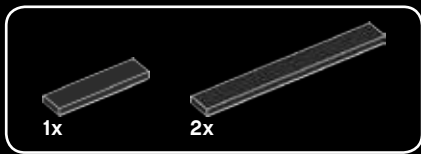

24

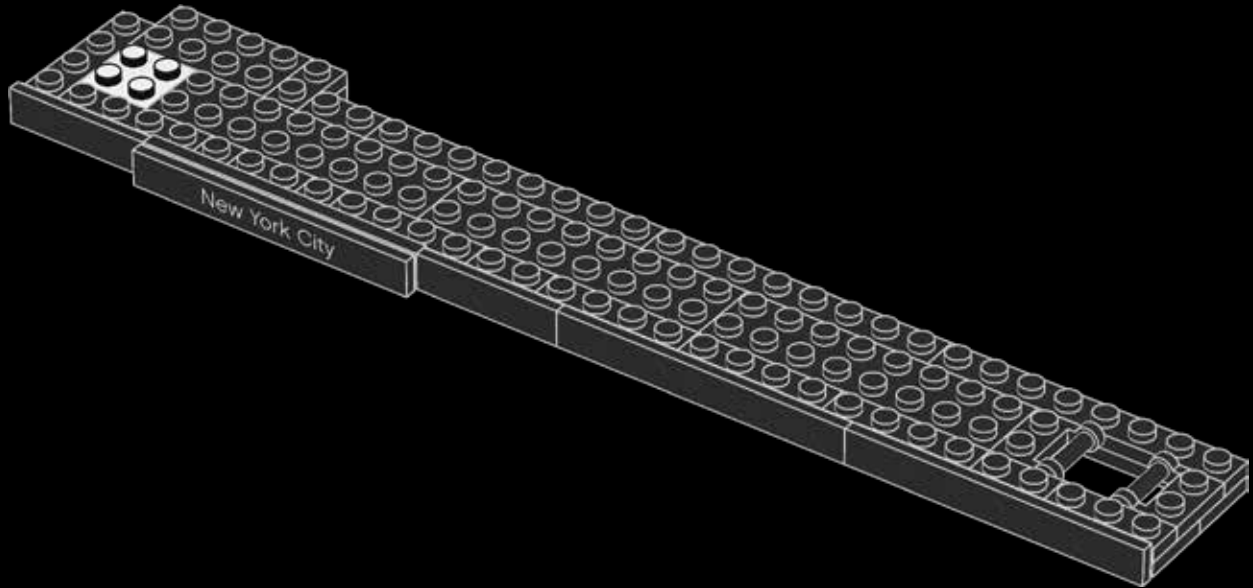



2x

25

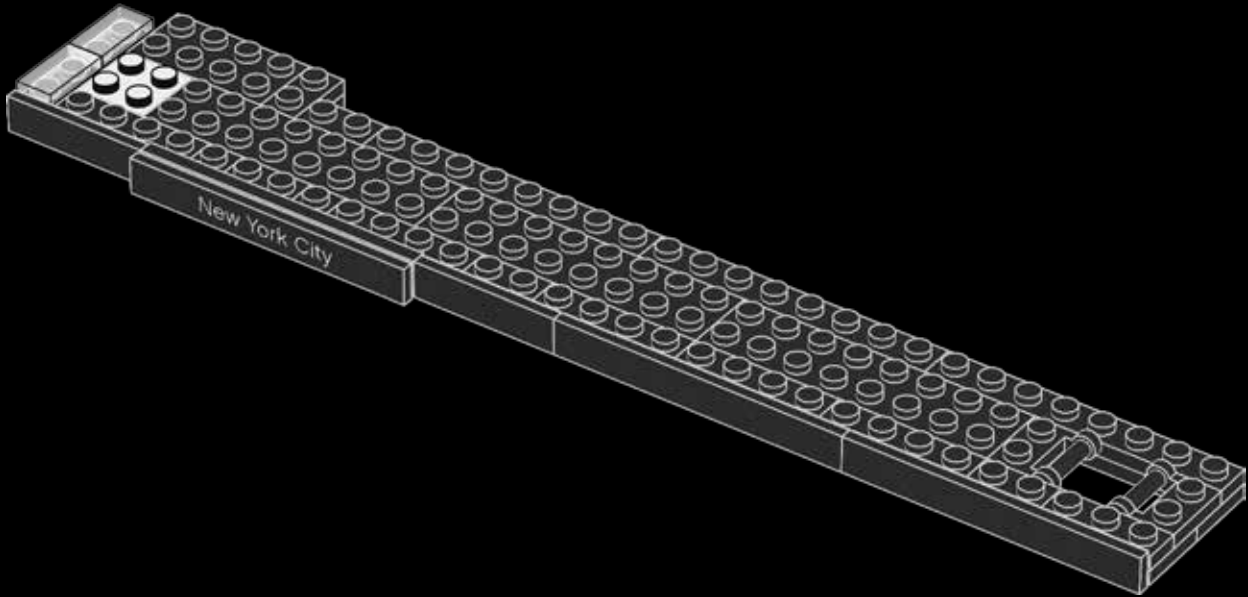



26

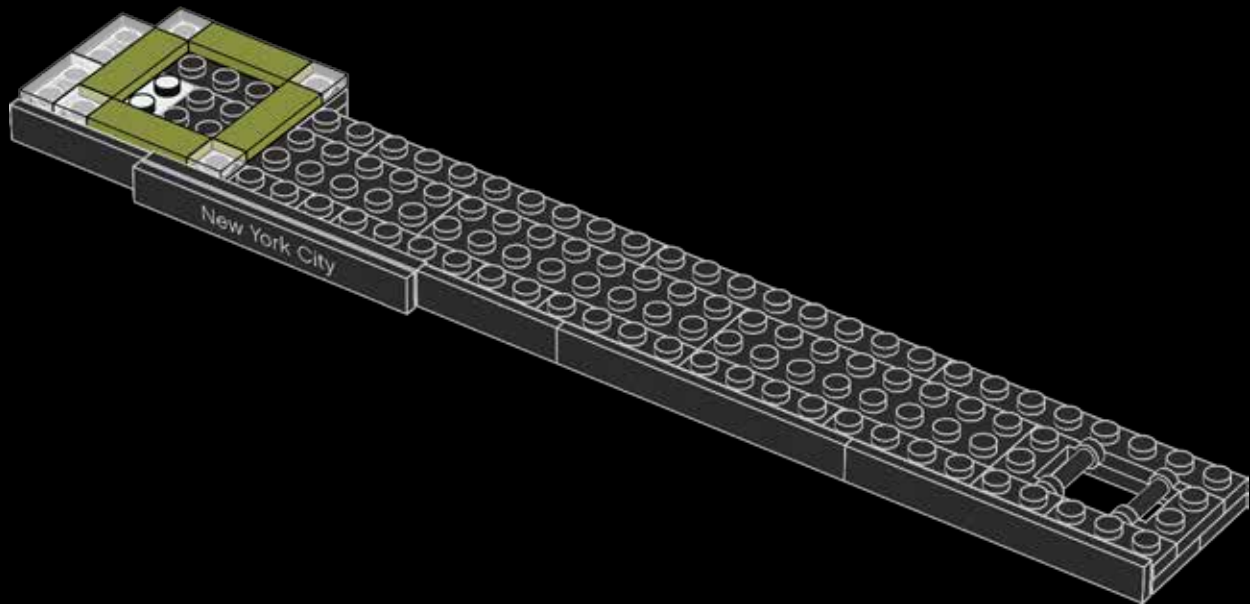



4x

27

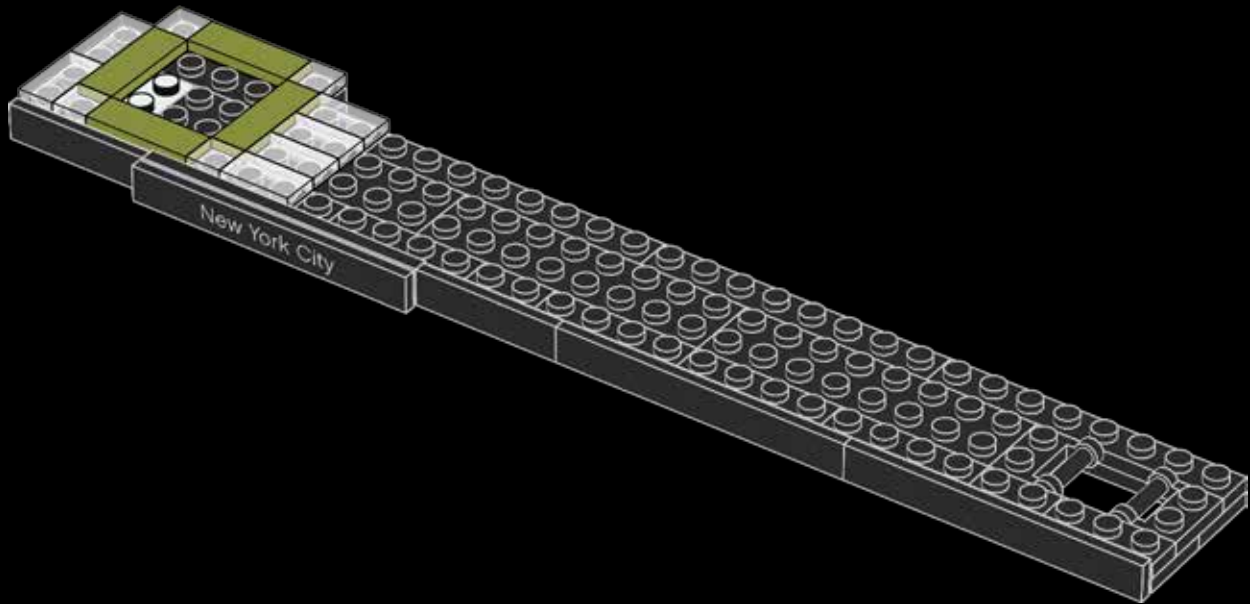

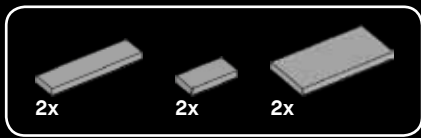

28

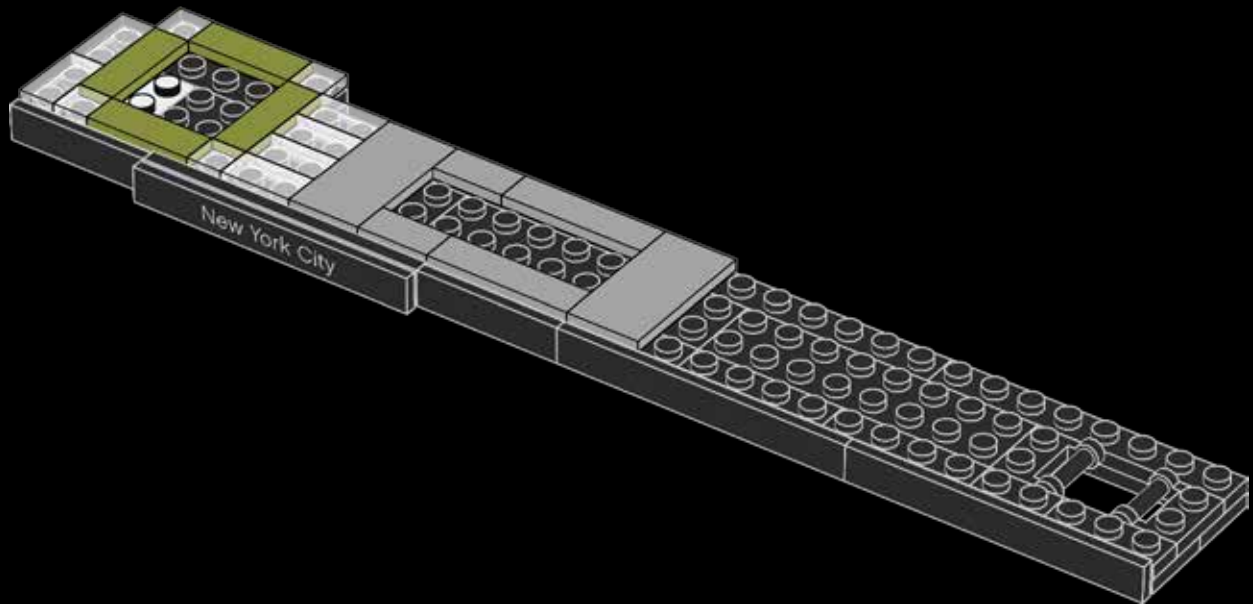



29

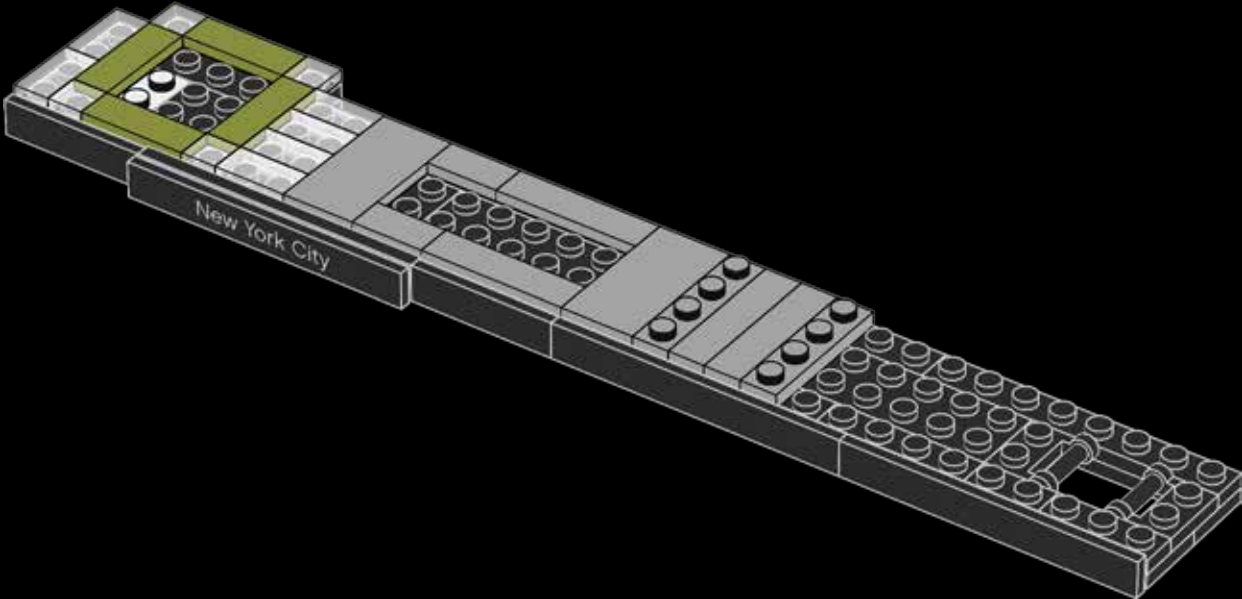

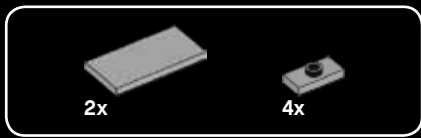

30

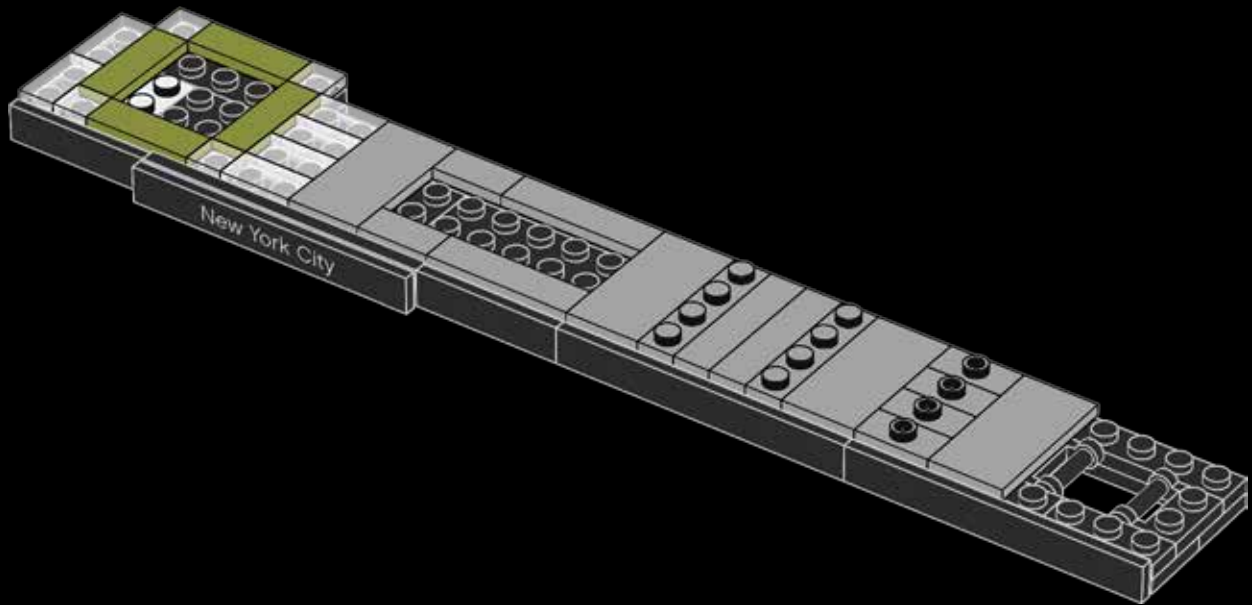



2x



2x

31

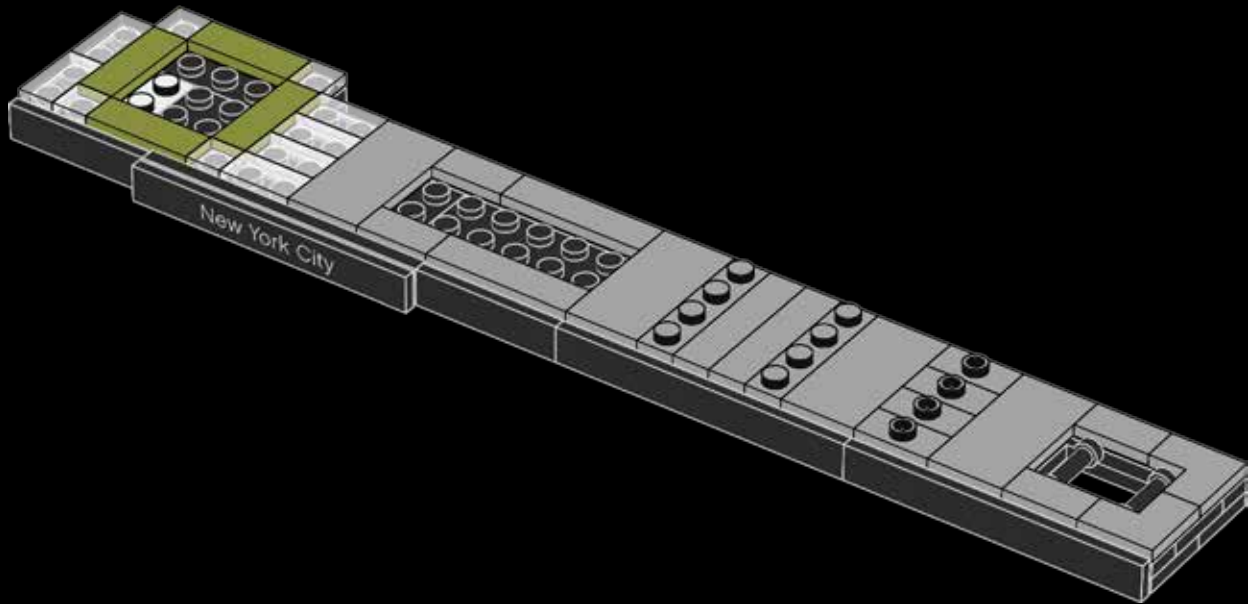

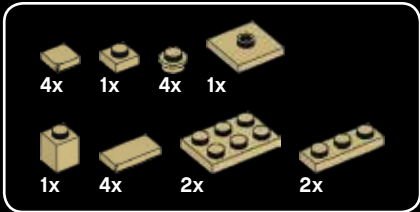

32

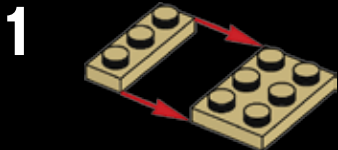

Maintained by the National Park Service since 1933, the Statue of Liberty is visited by around 4 million people every year.



© Victor Maschek

Chaque année, environ
4 millions de personnes
visitent la Statue de la
Liberté, entretenue par
le National Park Service
depuis 1933.



© Victor Maschek

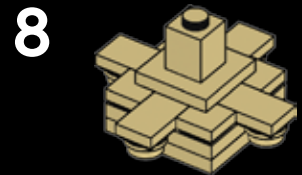
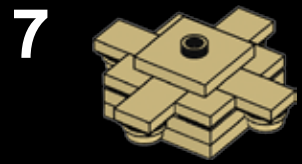
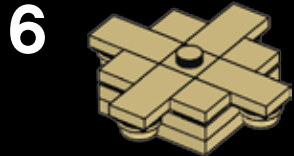
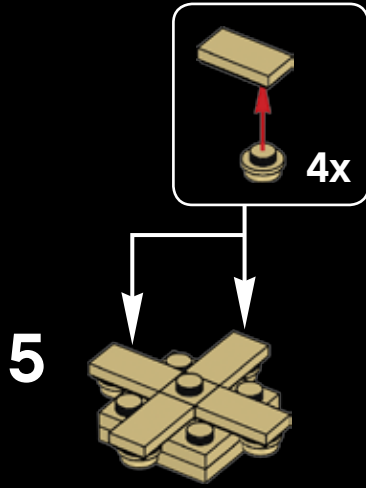

Mantenida por el Servicio de Parques Nacionales desde 1933, alrededor de 4 millones de personas visitan anualmente la Estatua de la Libertad.



© Victor Maschek

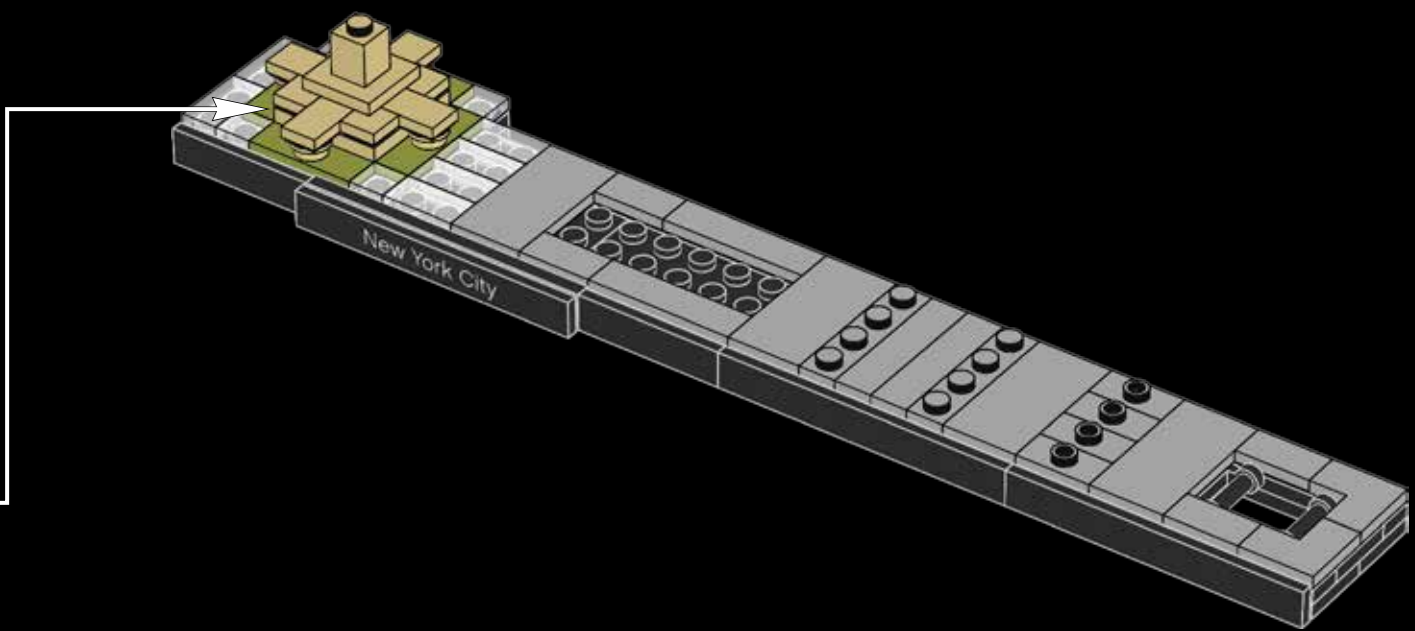

1x

1x

33

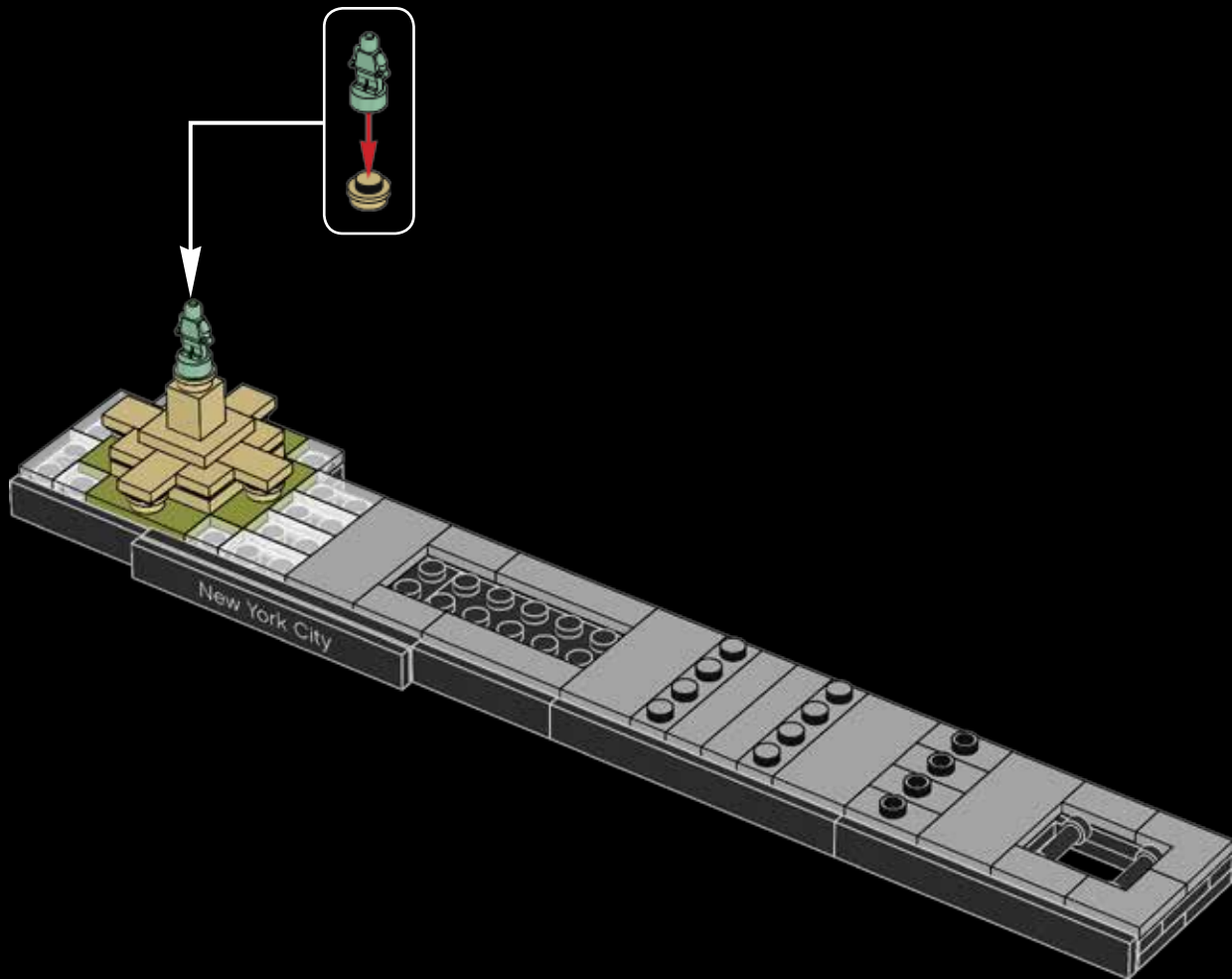

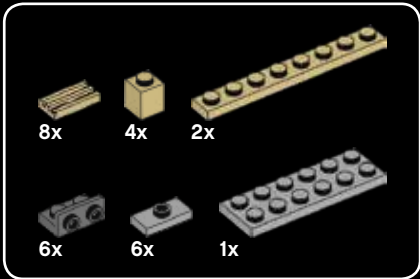

34

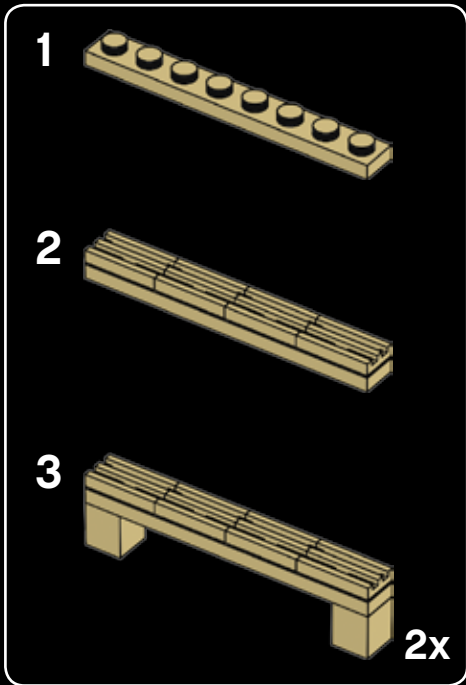

1



2

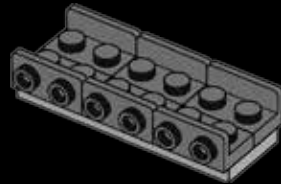

3



4



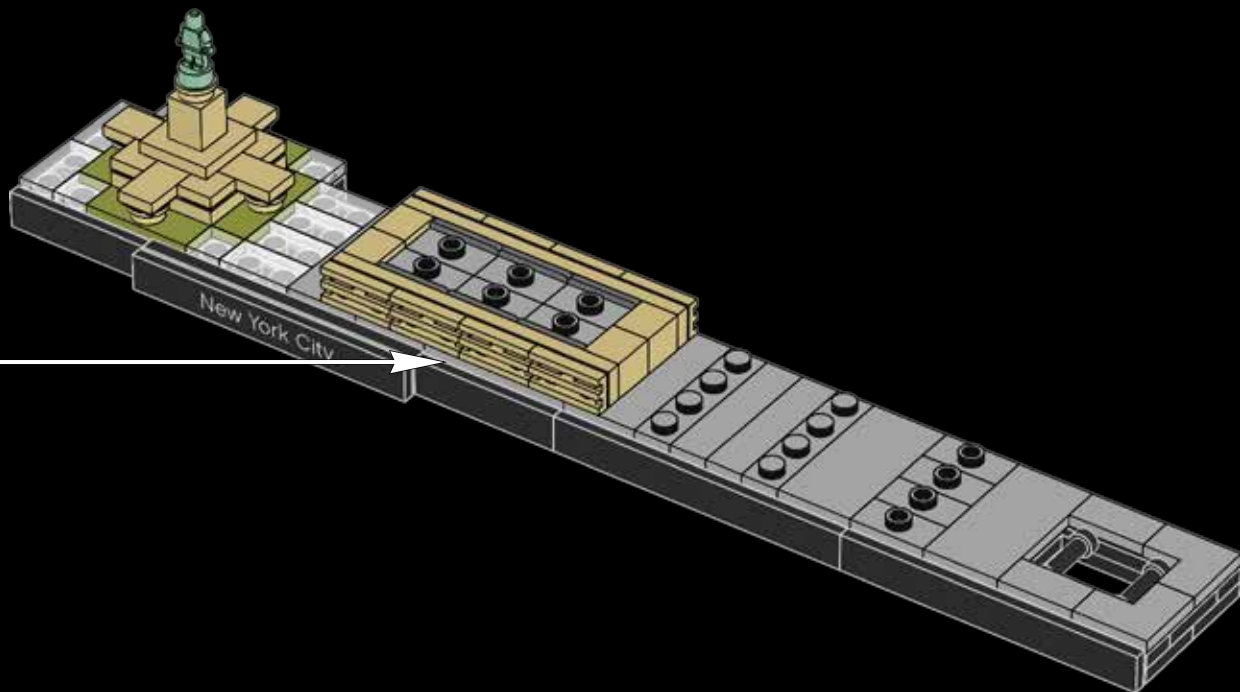



1

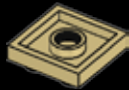

2

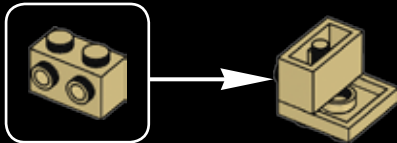

3

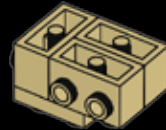

4

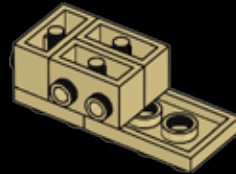



2x

5

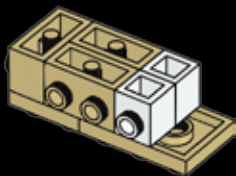

1x

6

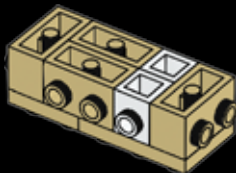

1x



1x

7

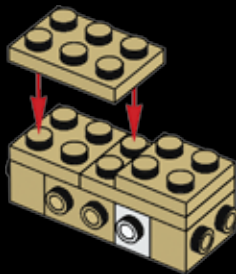

1x

8

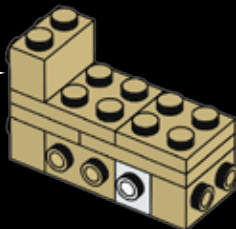



9

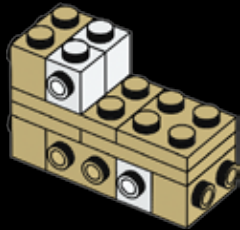

10

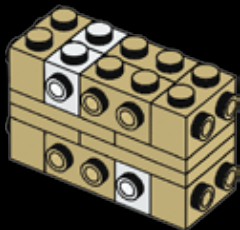

11

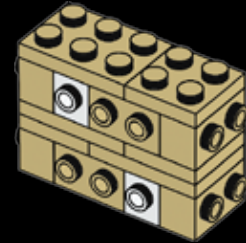

12

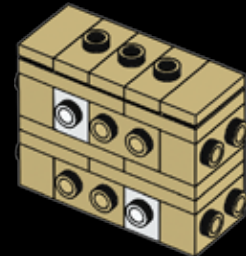



13

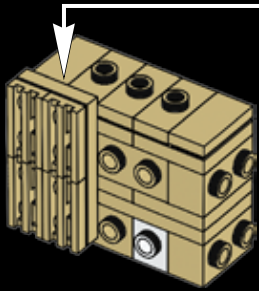
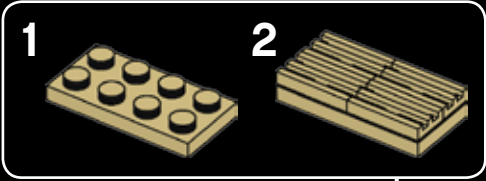

14

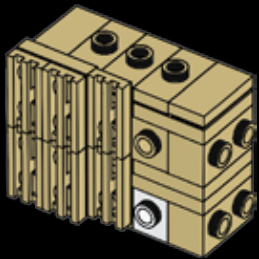

15

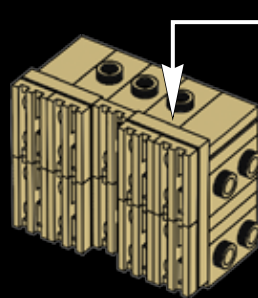
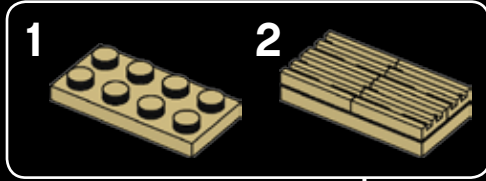

16

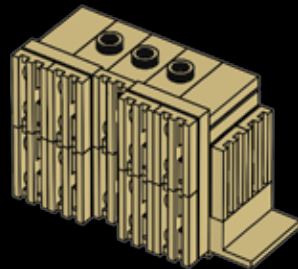



17

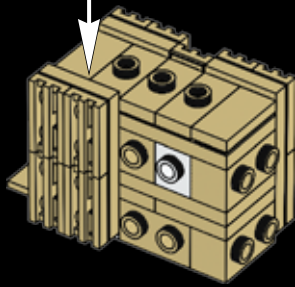
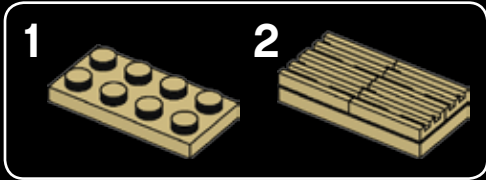

18

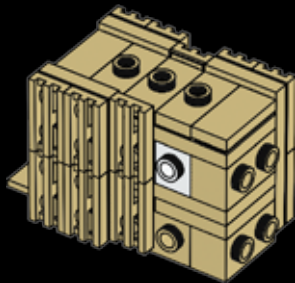

19

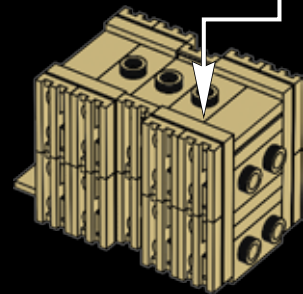
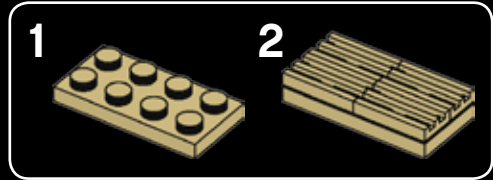

20

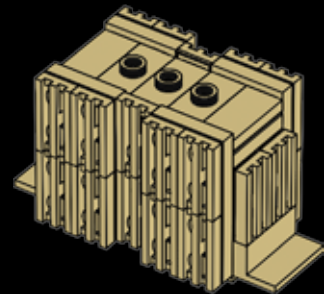



1x

21

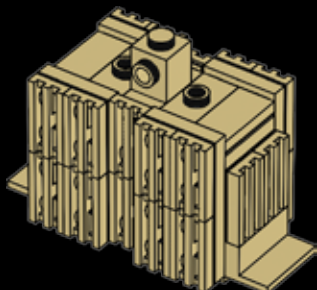

6x

22

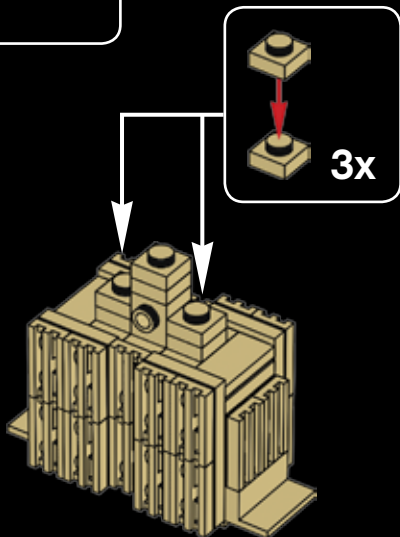

2x

23

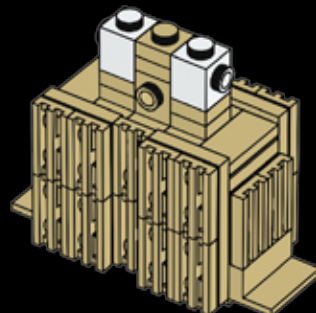

3x



1x

24

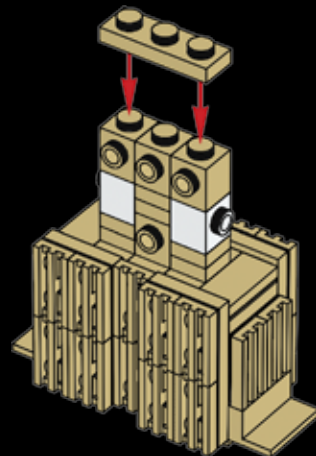

35

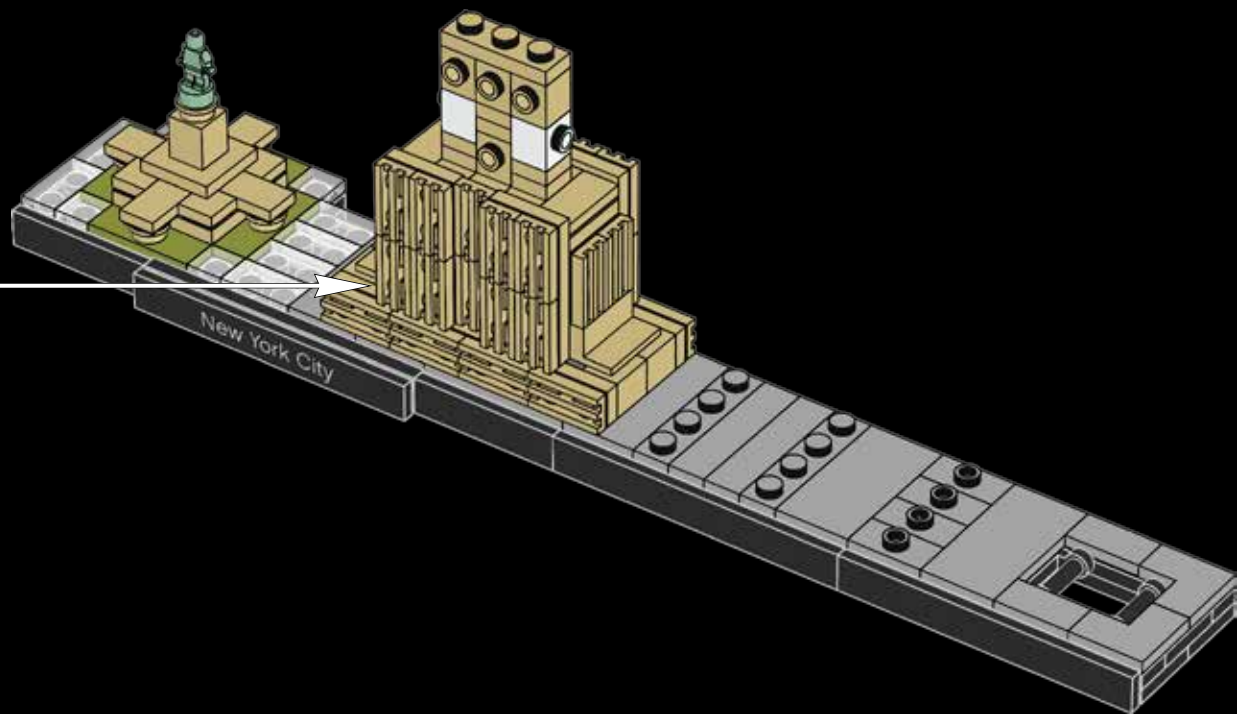



36

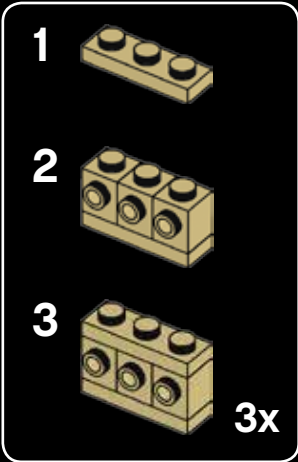

1



70

2

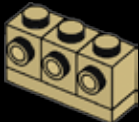

3



4



5



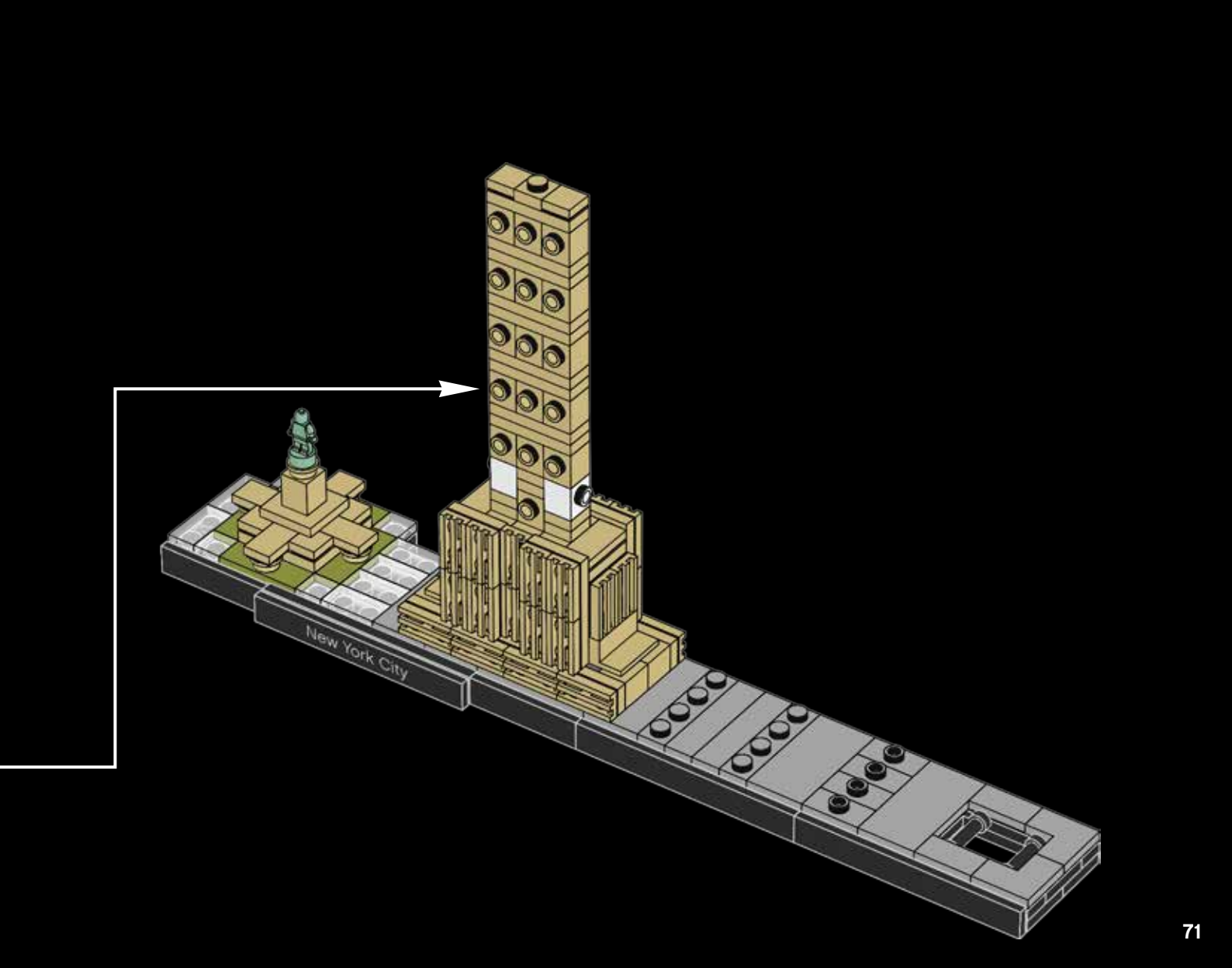

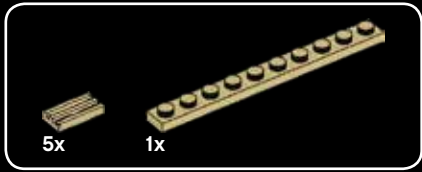

37

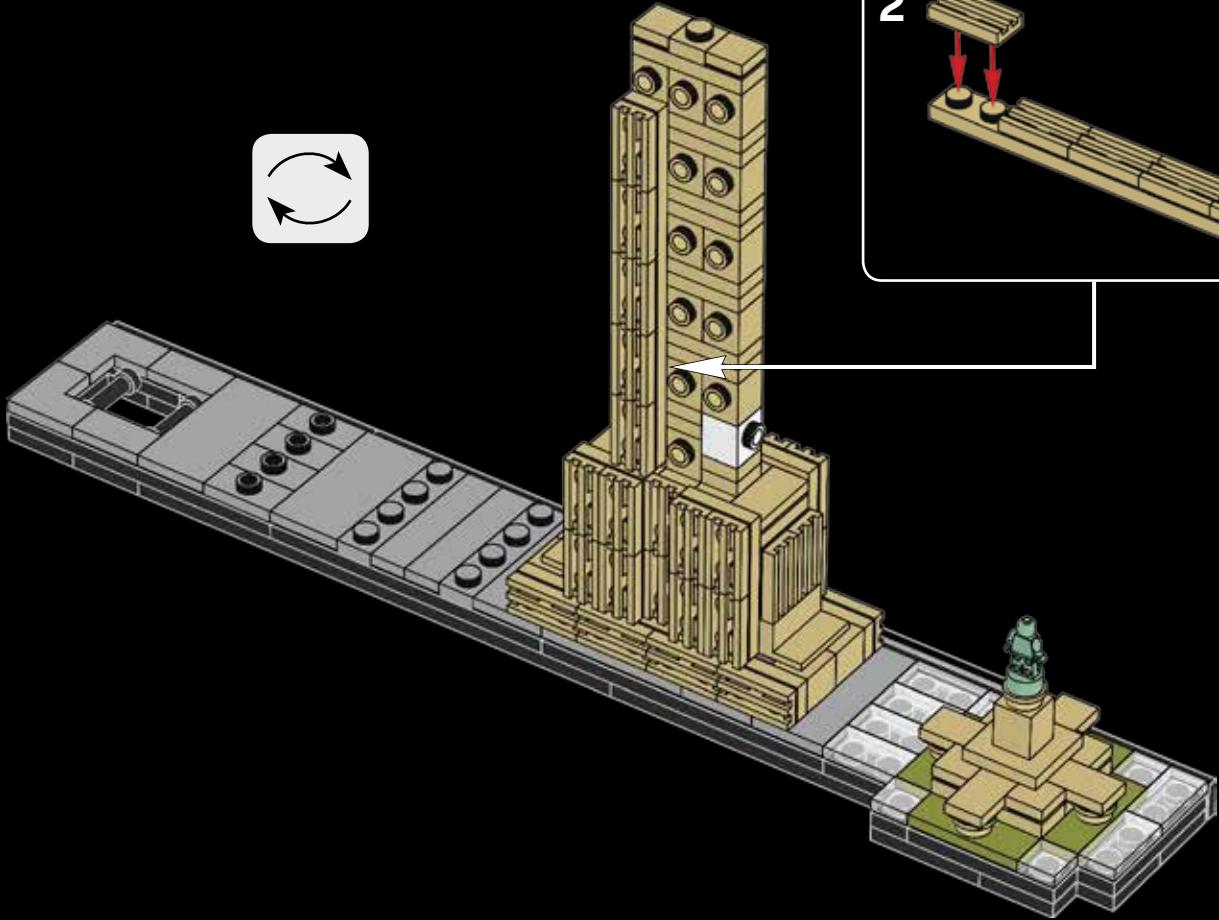
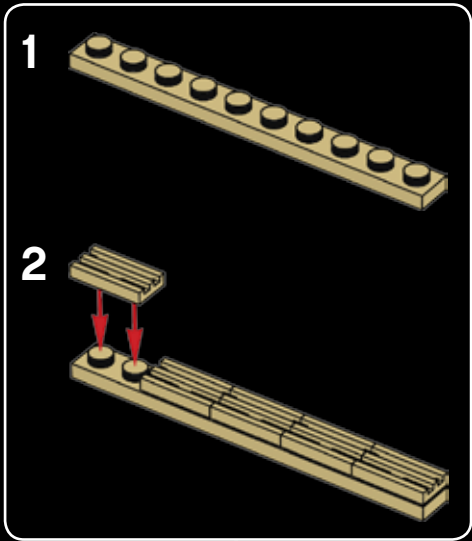



38

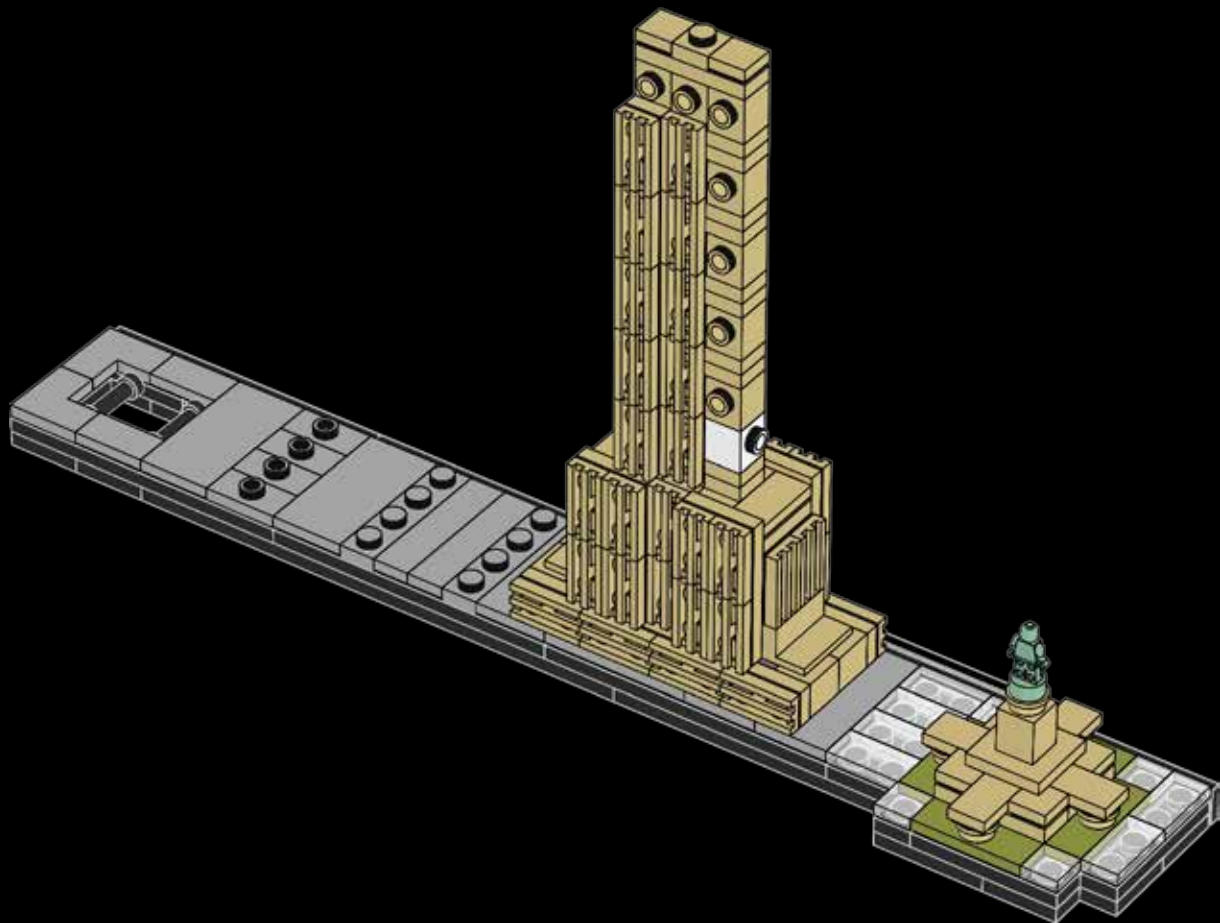

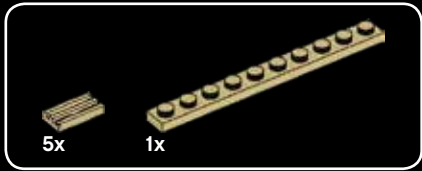

39

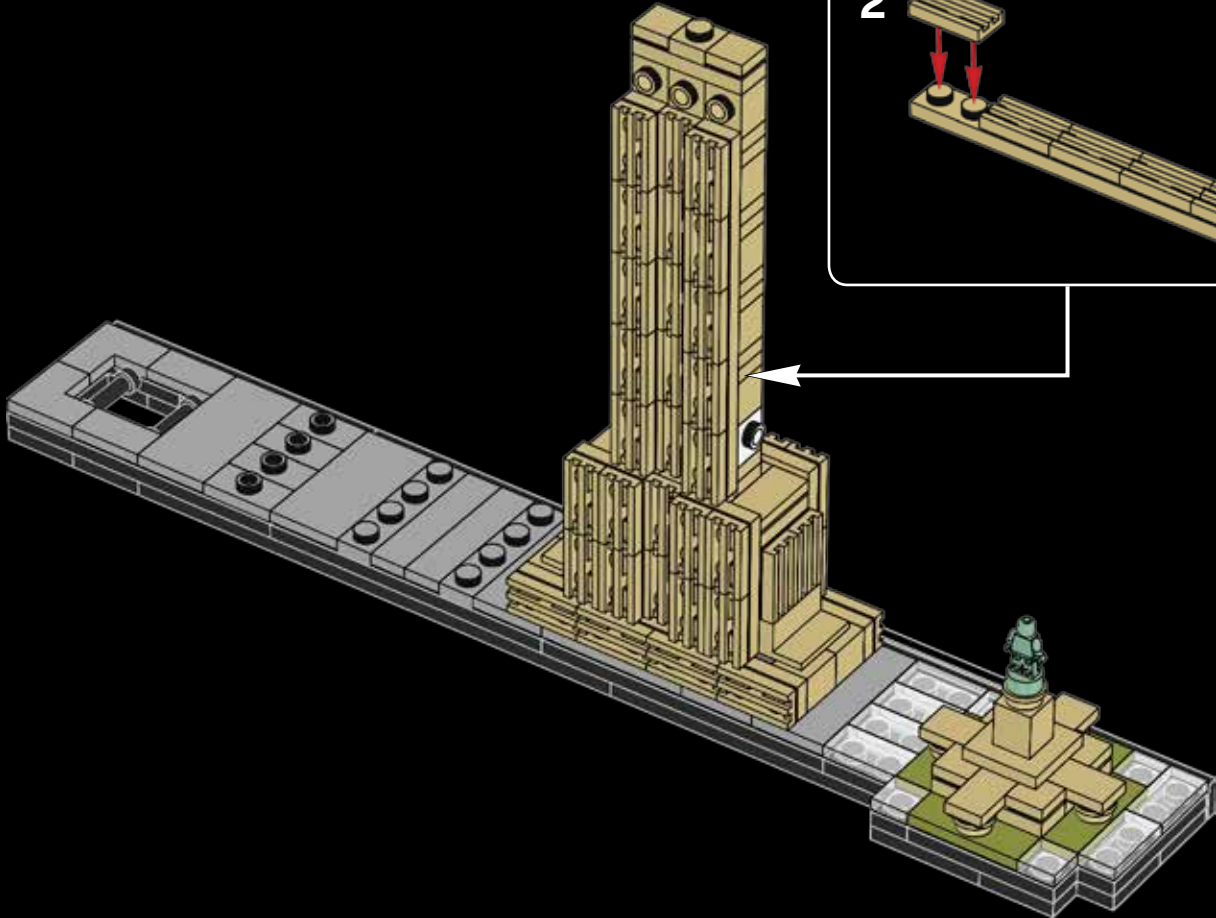
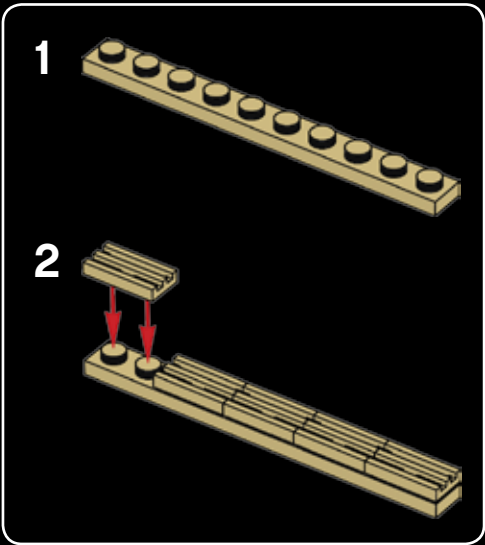



40

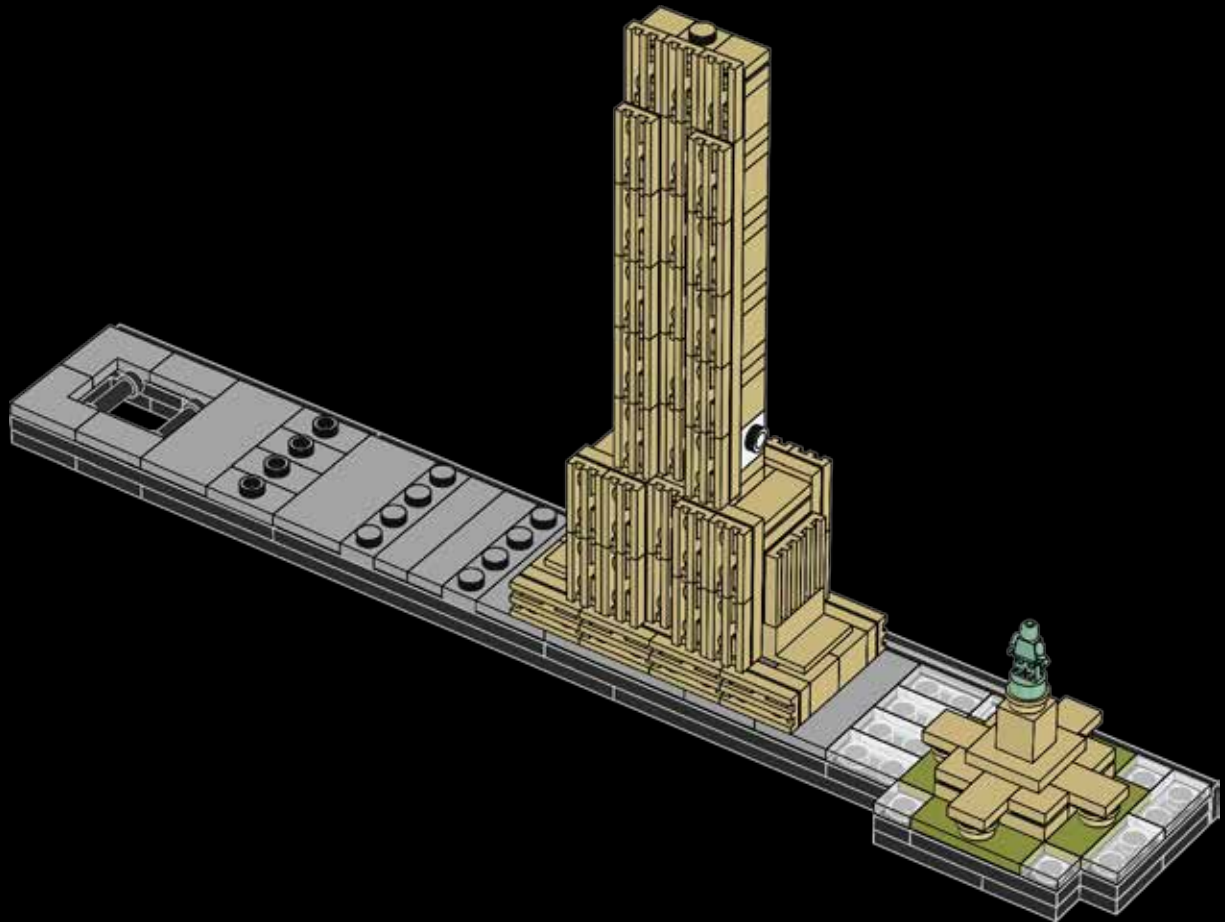

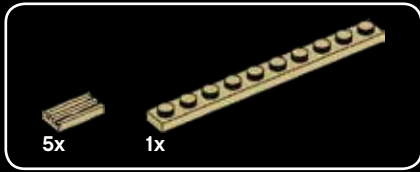

Il y a 6 514 fenêtres dans l'Empire State Building.



© Empire State Realty Trust, Inc.

41

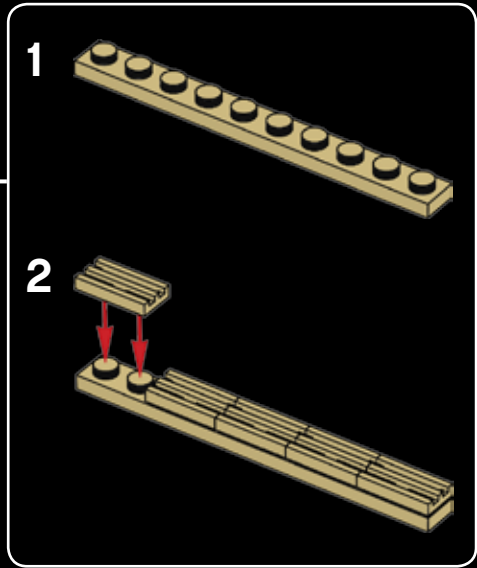
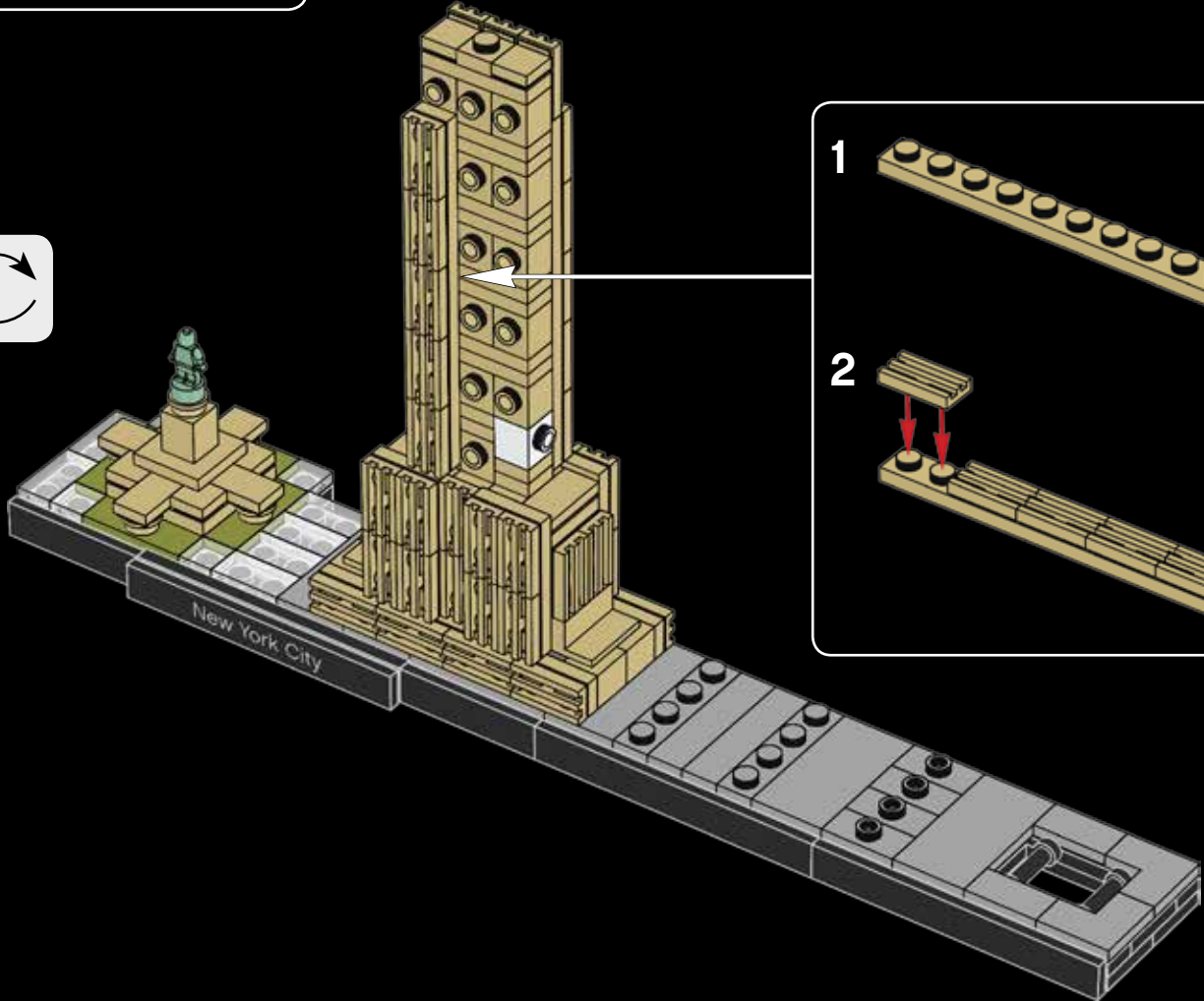



42

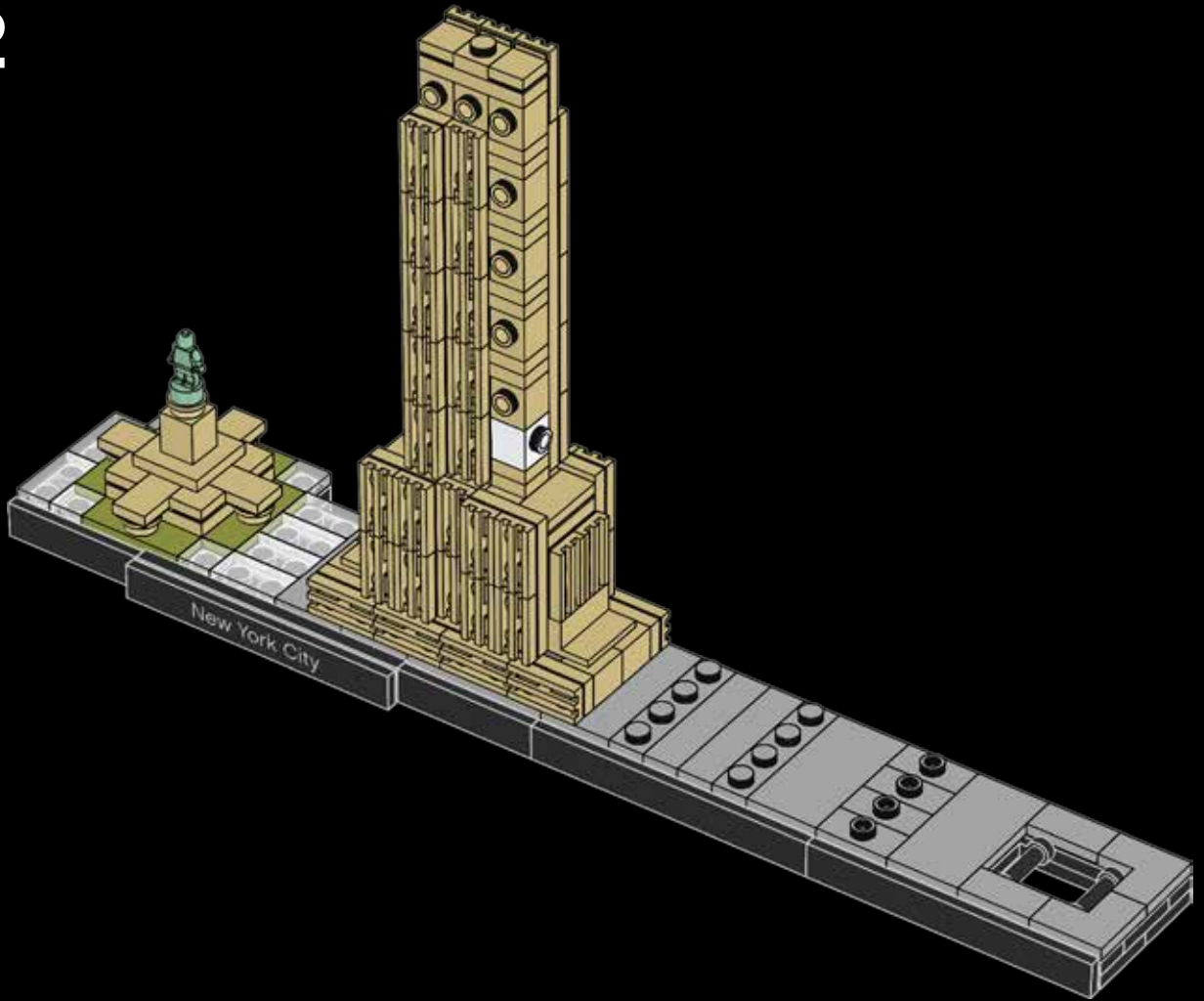

Hay 6.514 ventanas en el edificio
Empire State.



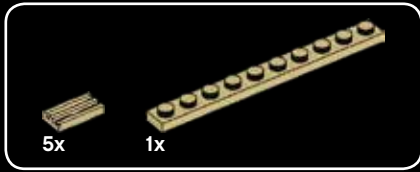

43

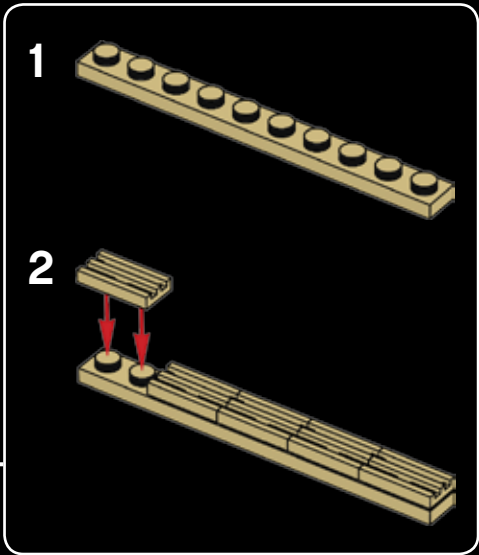
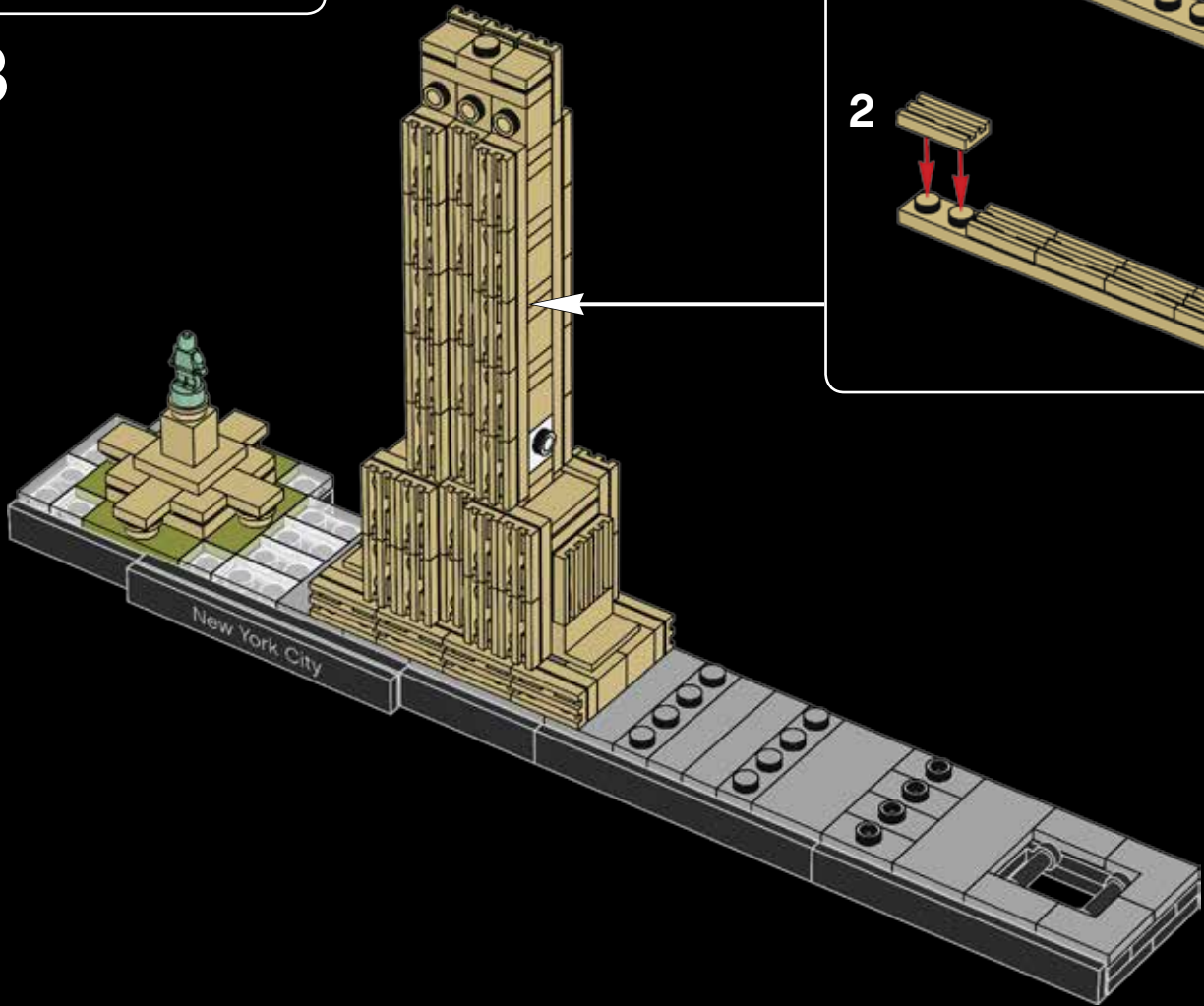



44

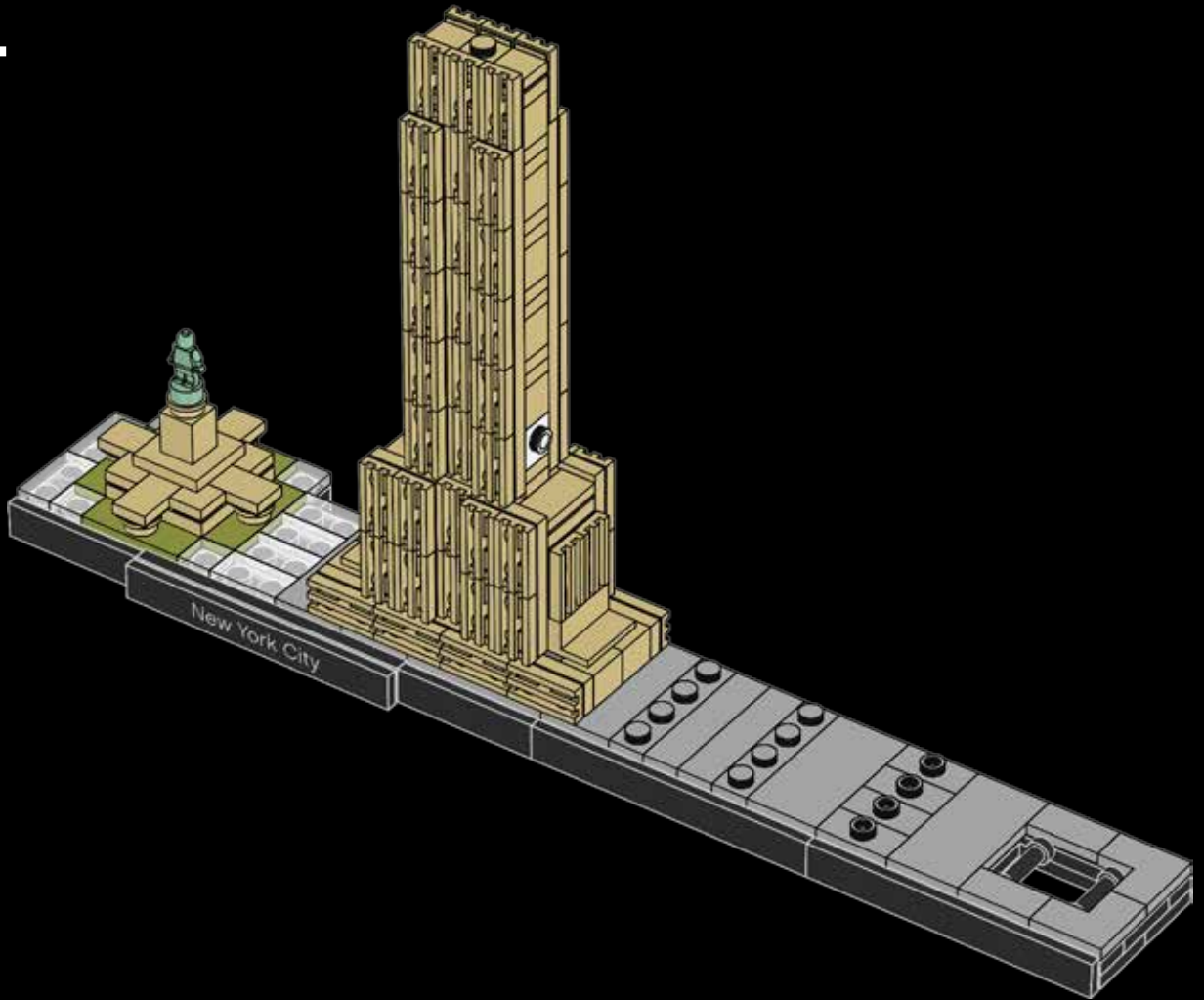



45

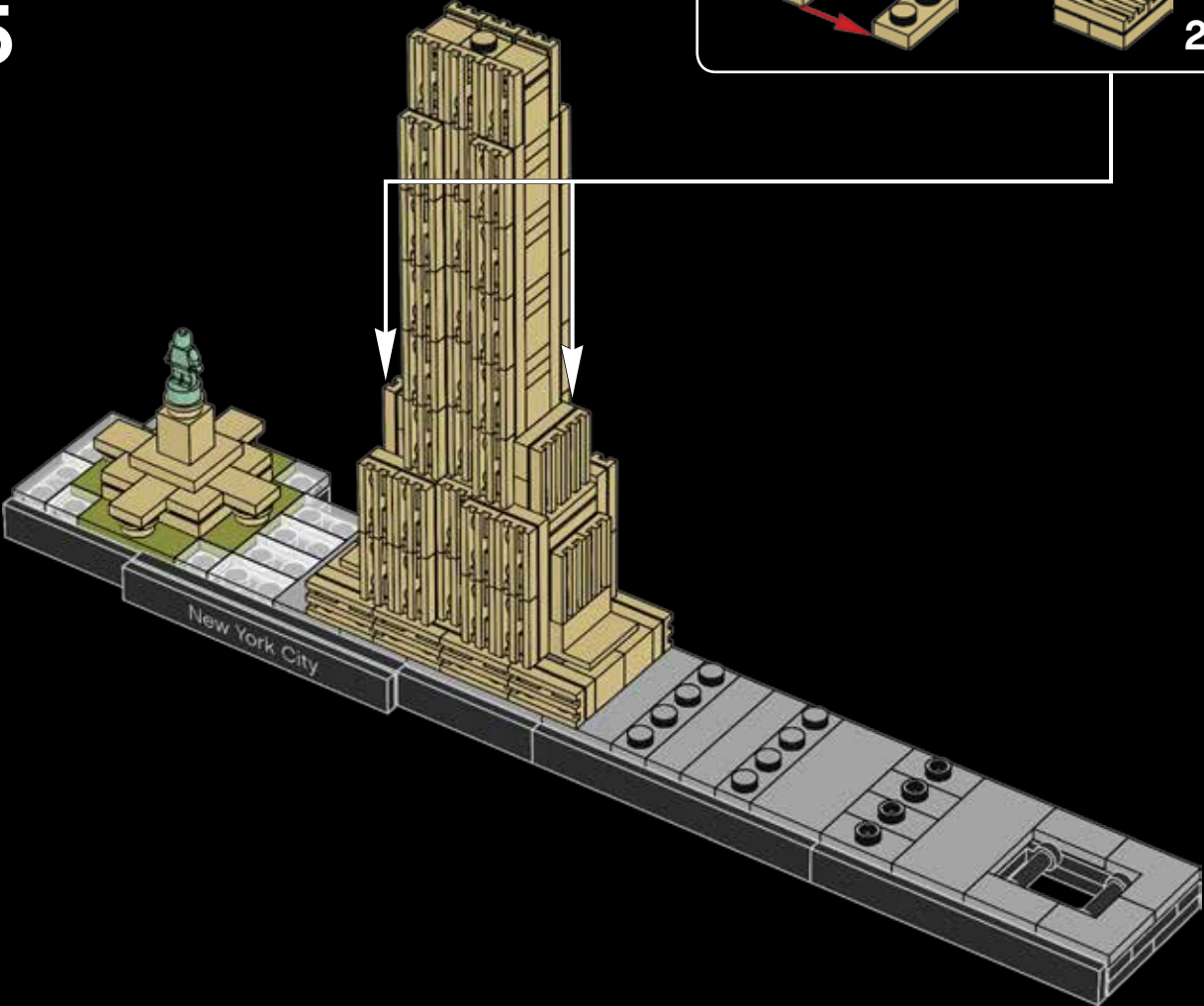
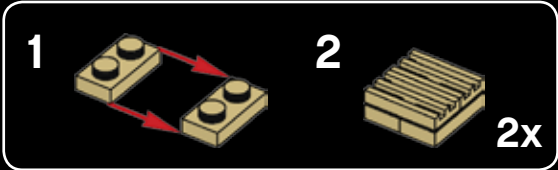

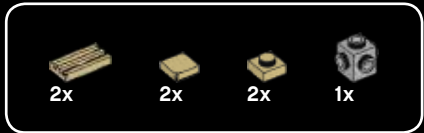

46

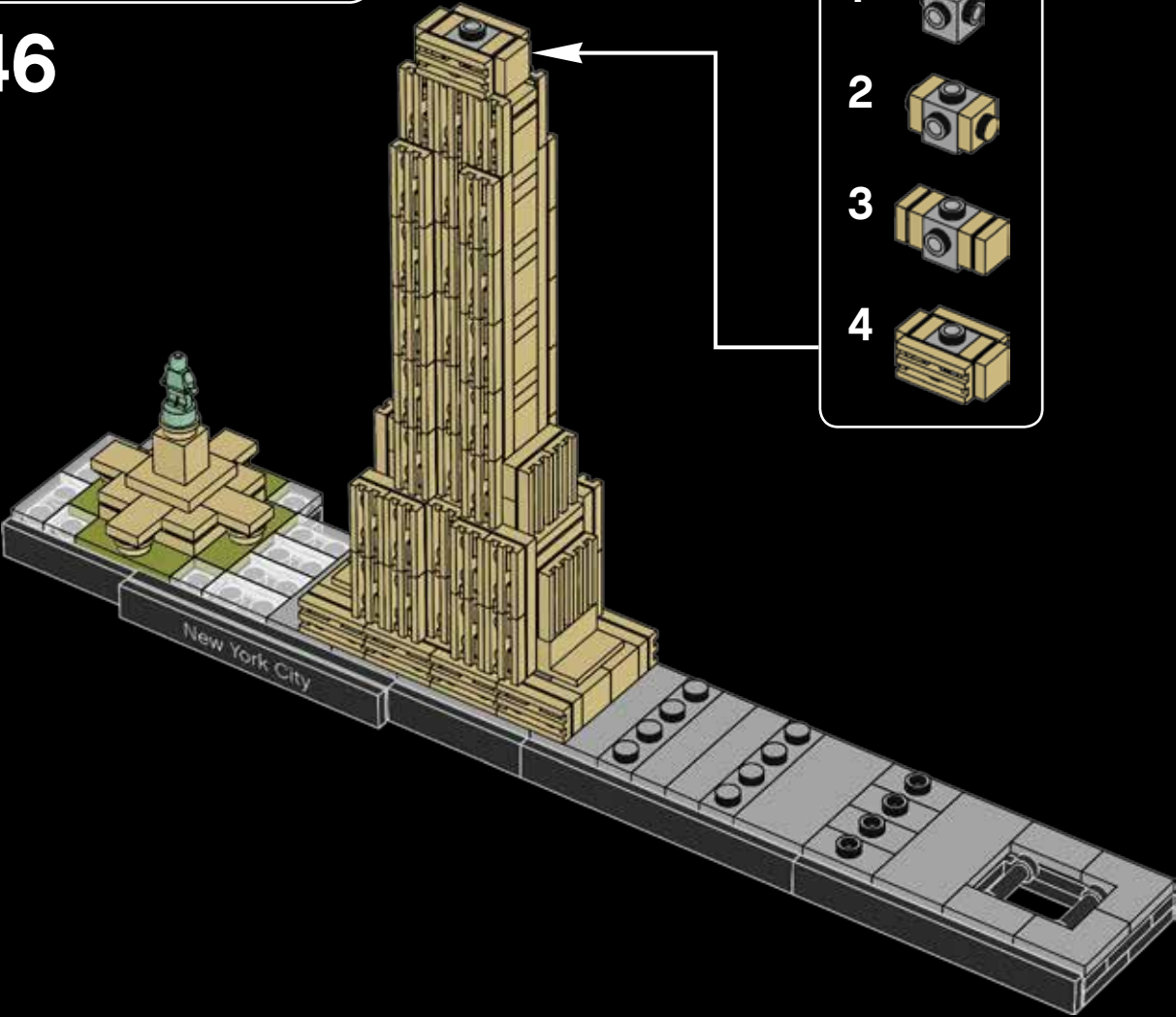

- 1
- 2
- 3
- 4



1x

47

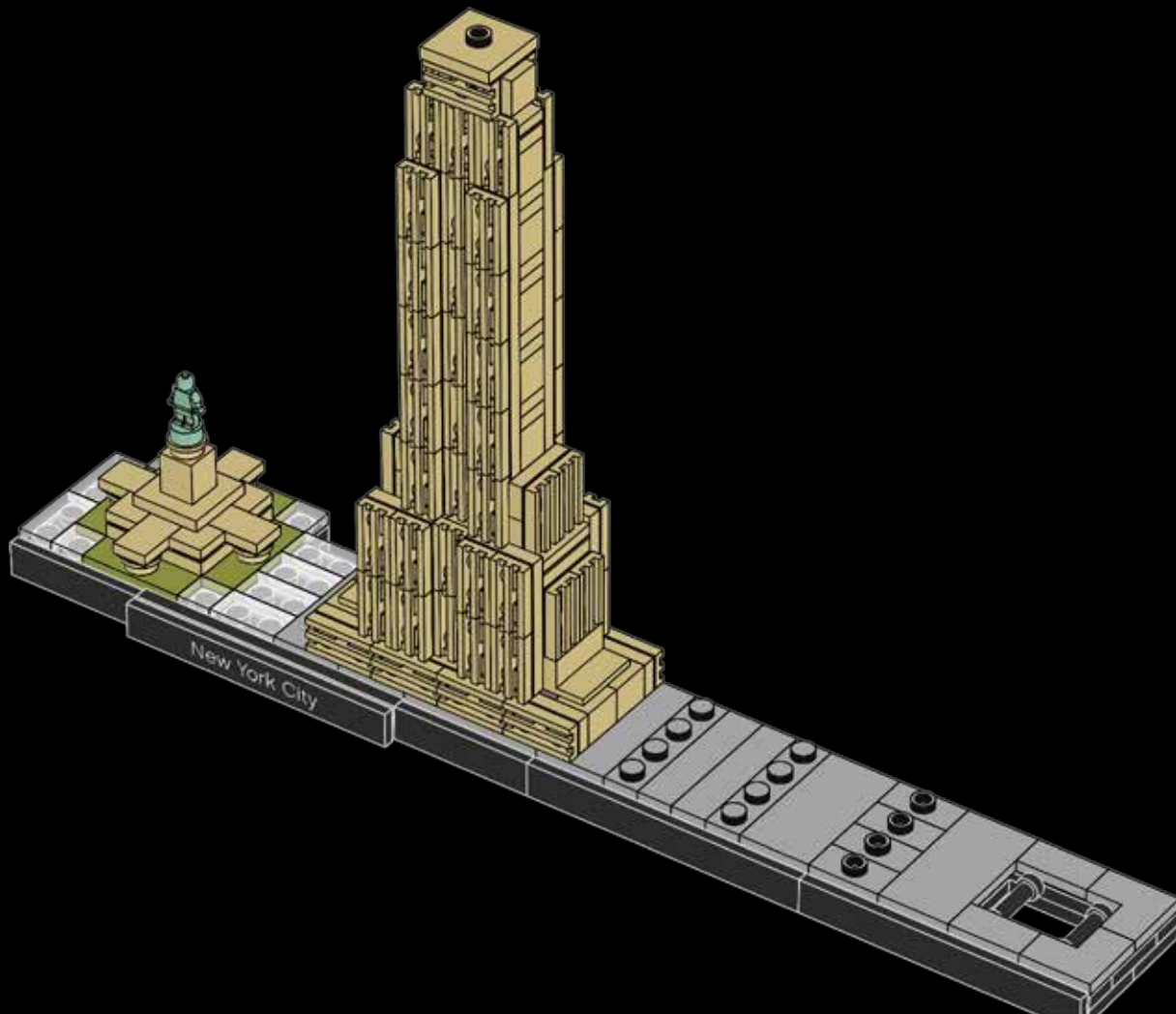

The Empire State Building has a lightning rod near the top which is struck by lightning around 23 times every year.



© Everett Historical



48

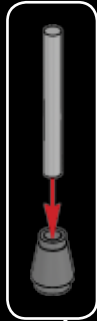

1 2 3

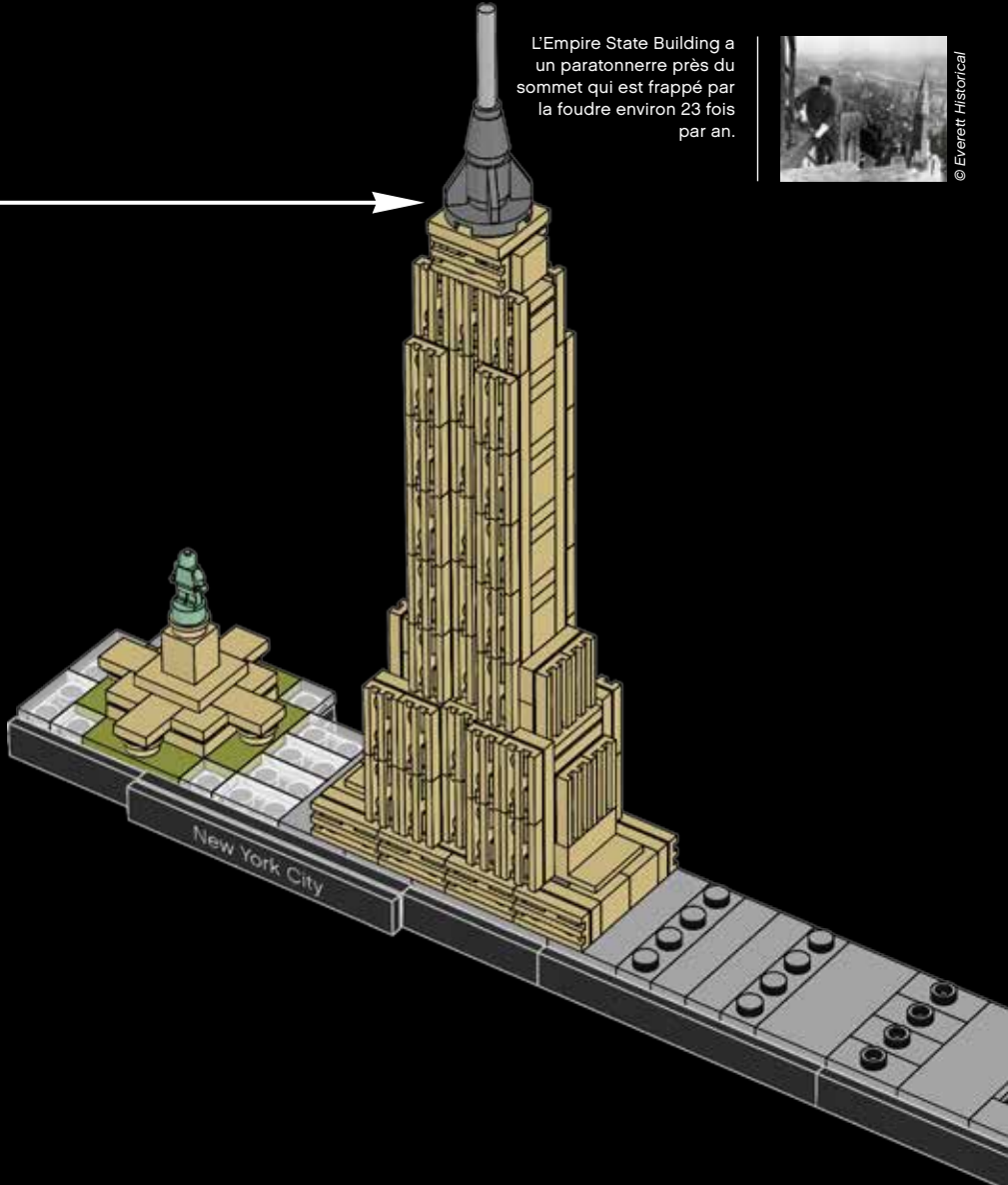
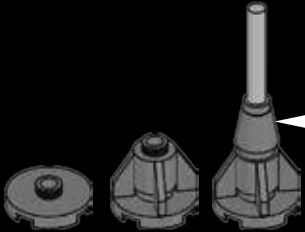

L'Empire State Building a un paratonnerre près du sommet qui est frappé par la foudre environ 23 fois par an.



© Everett Historical



4x

49

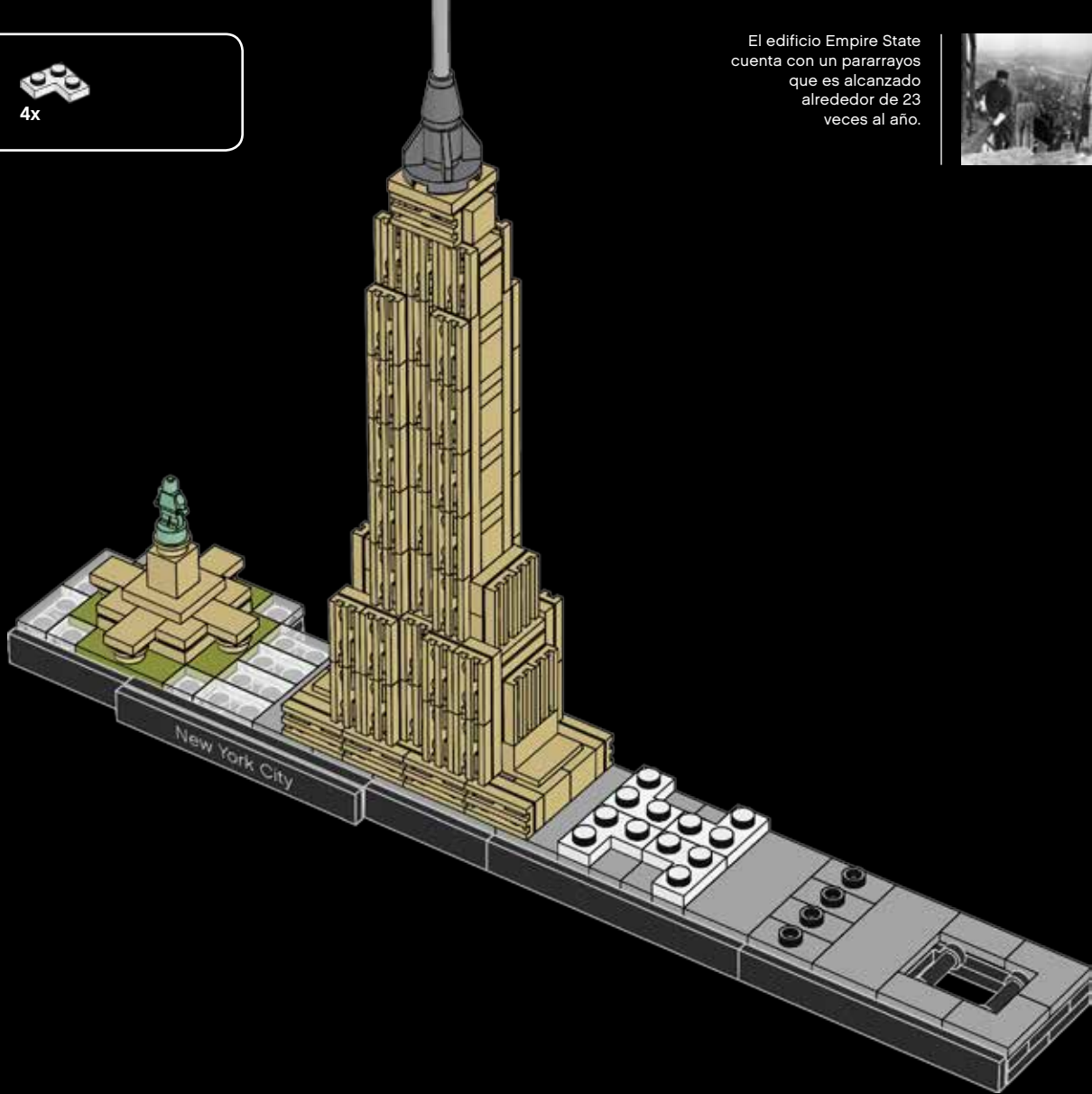

El edificio Empire State cuenta con un pararrayos que es alcanzado alrededor de 23 veces al año.



© Everett Historical



50

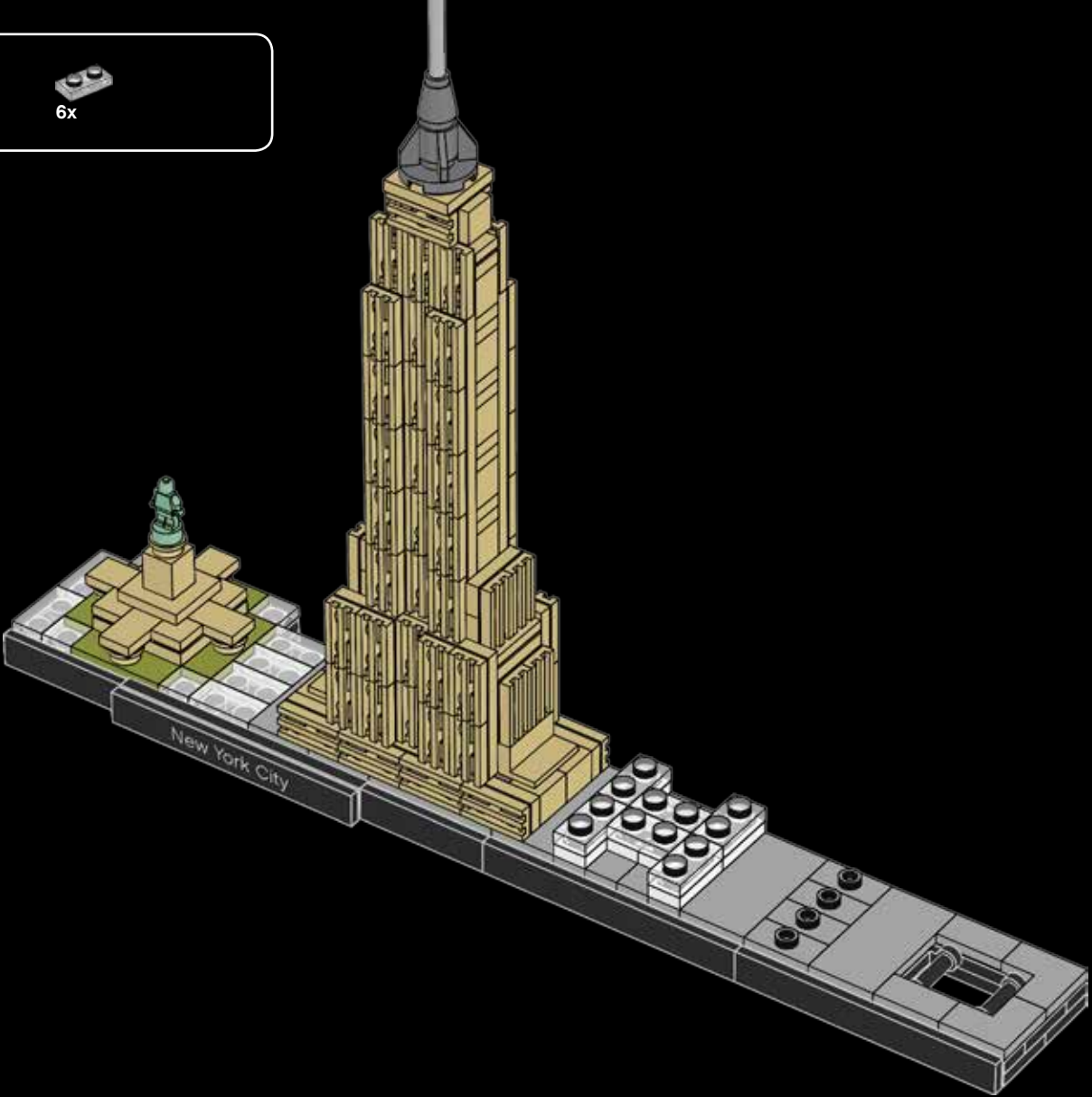

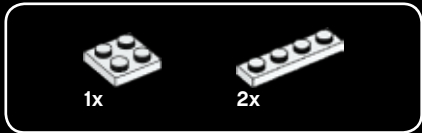

51

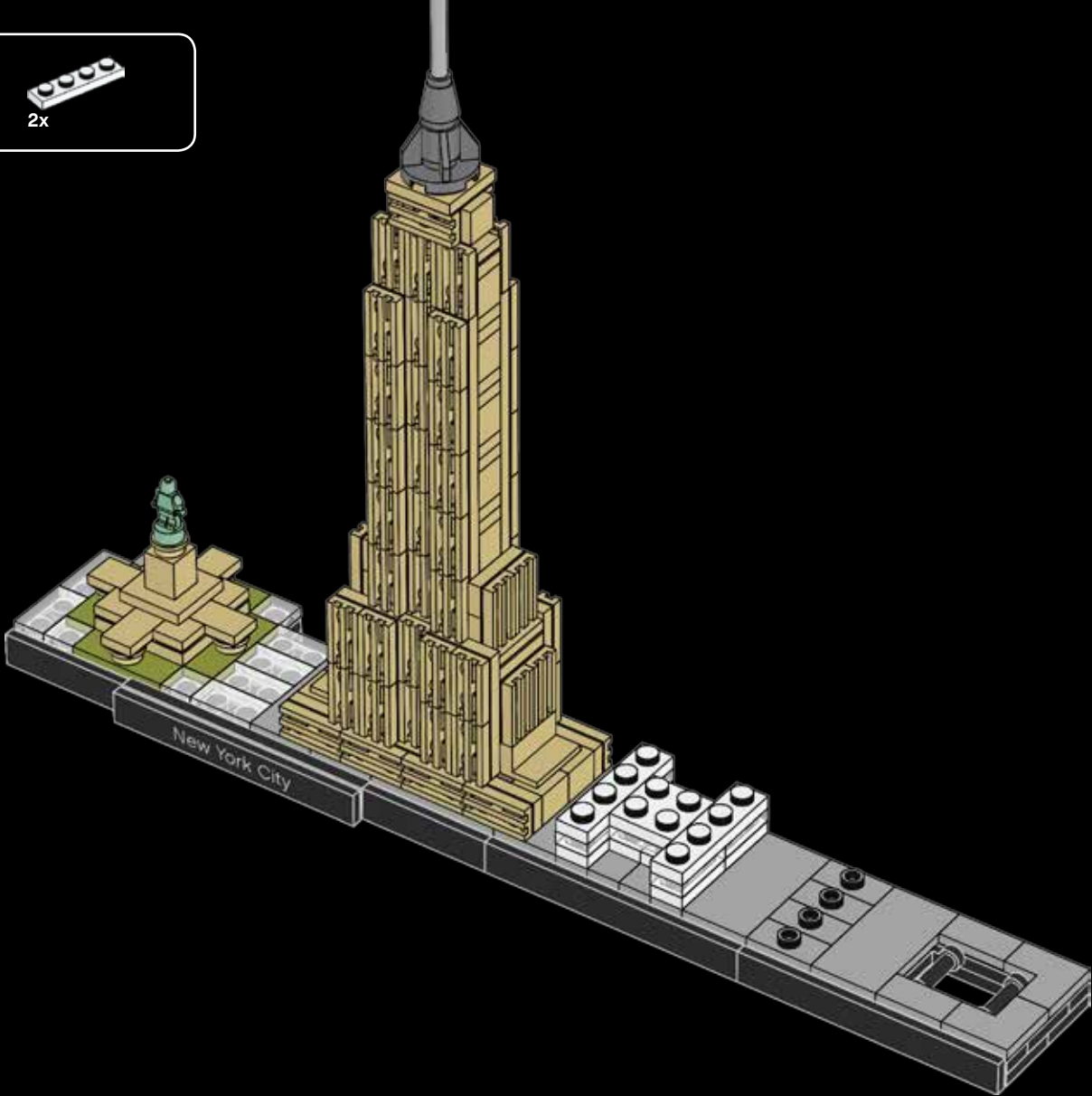



52

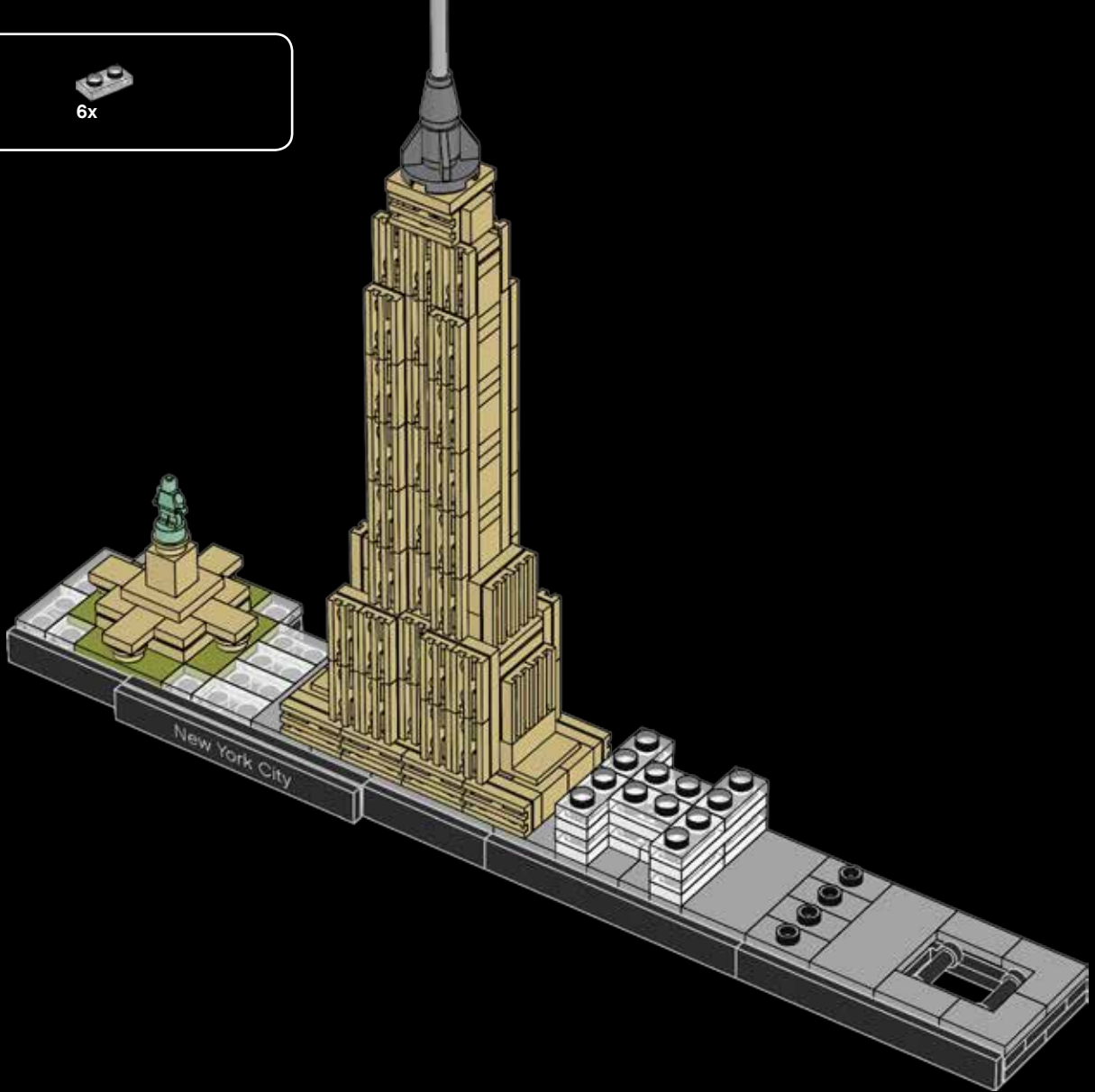



1x



4x

53

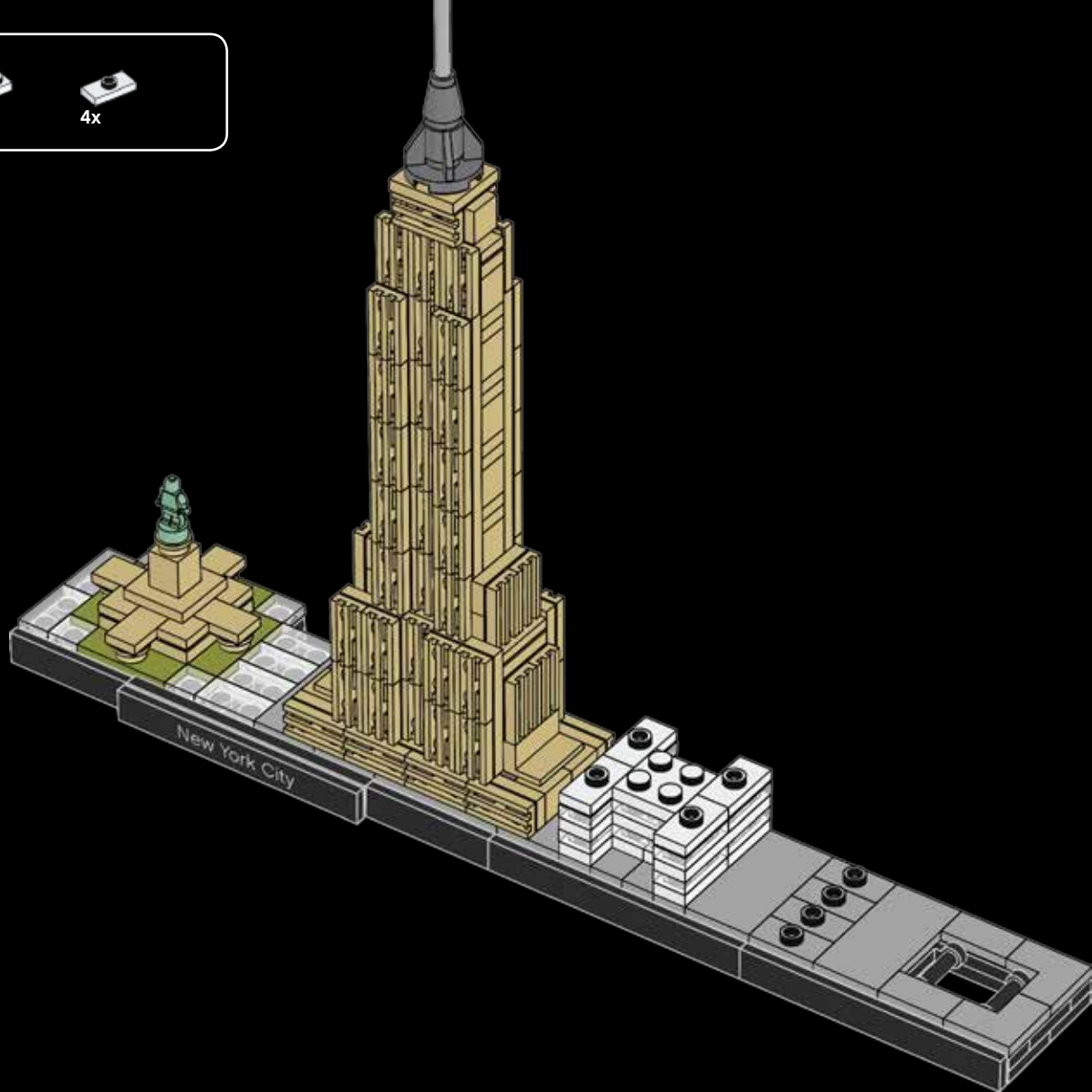

2x

54

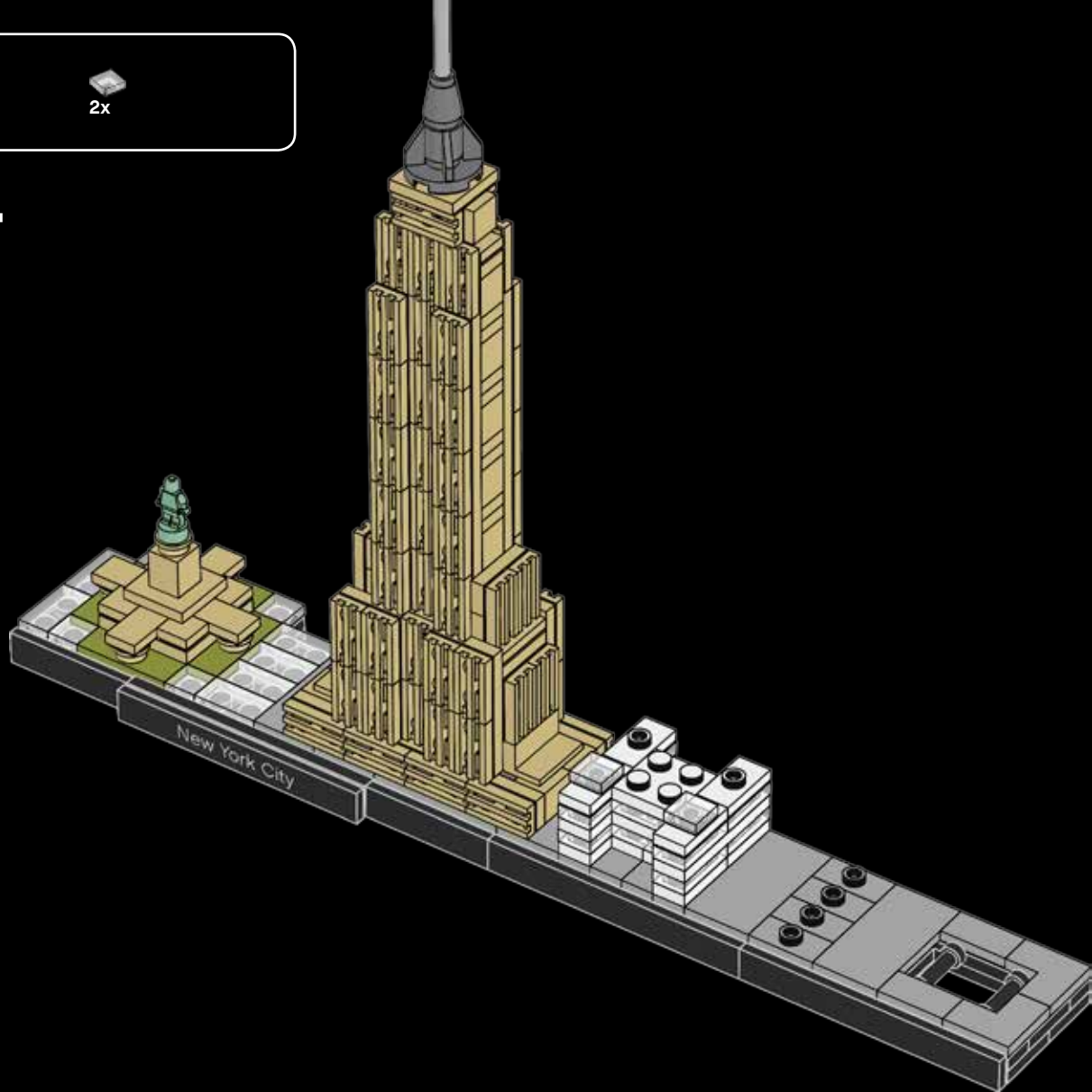



4x

55





2x

56

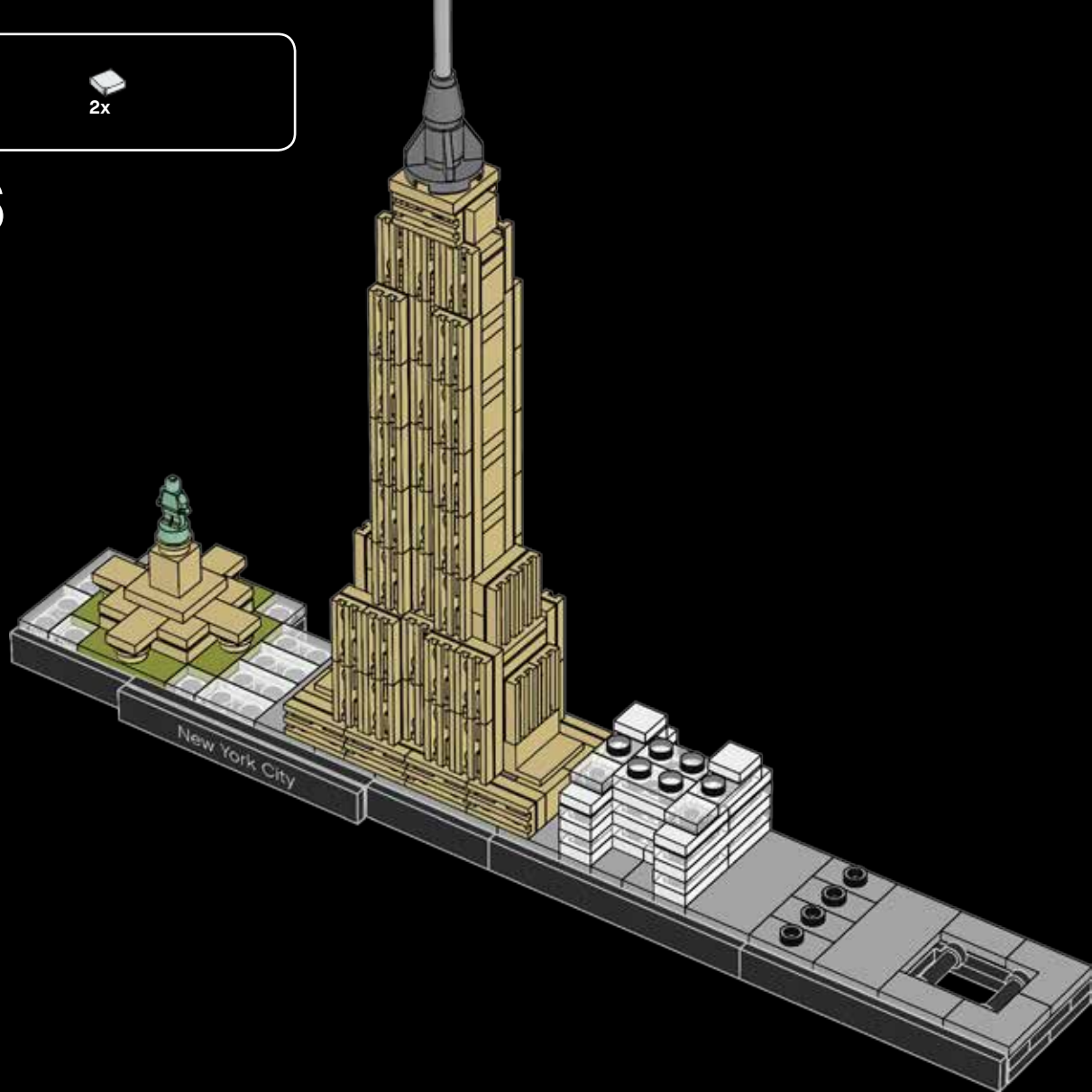



1x



2x

57

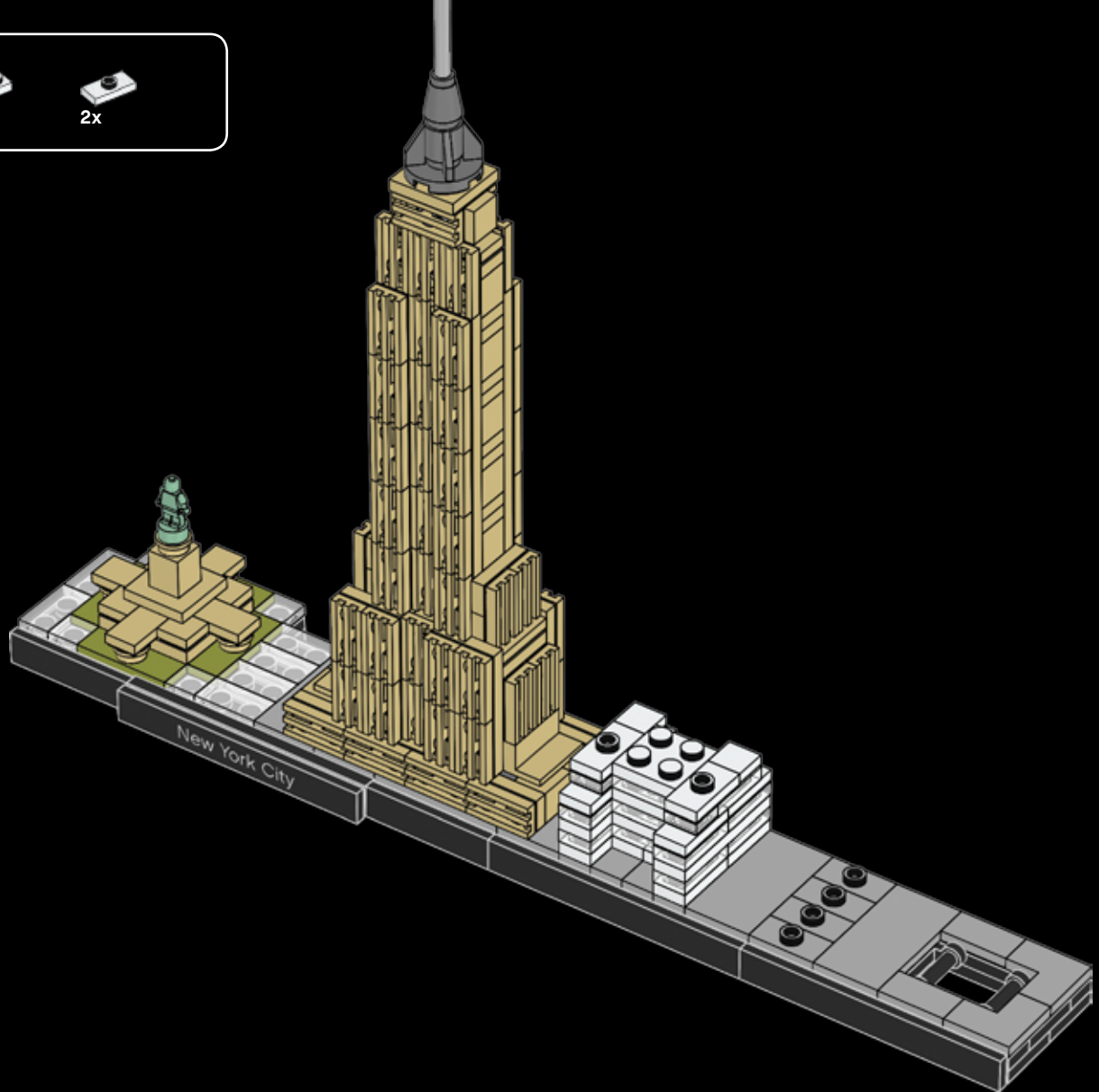



58

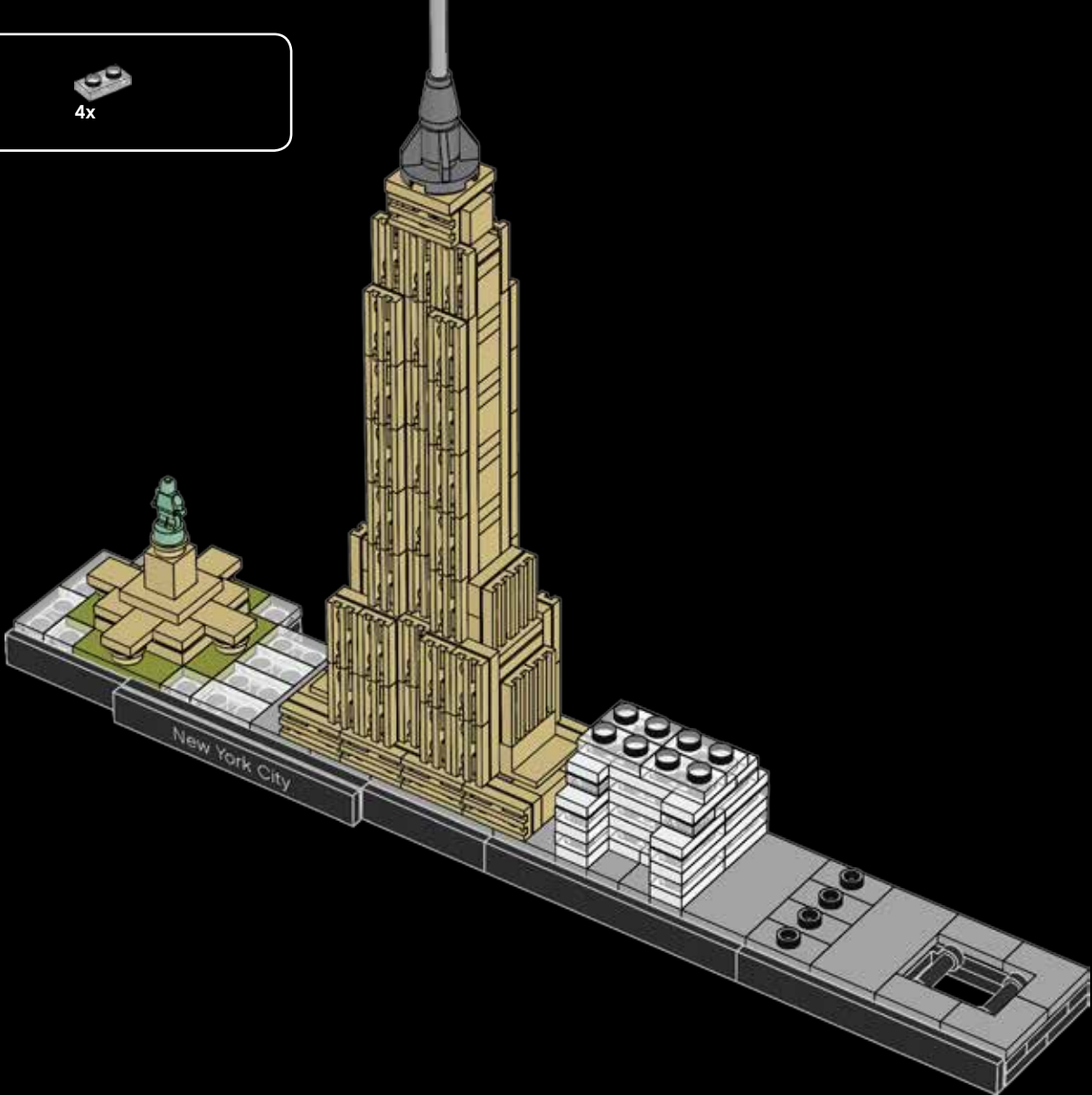



4x

59

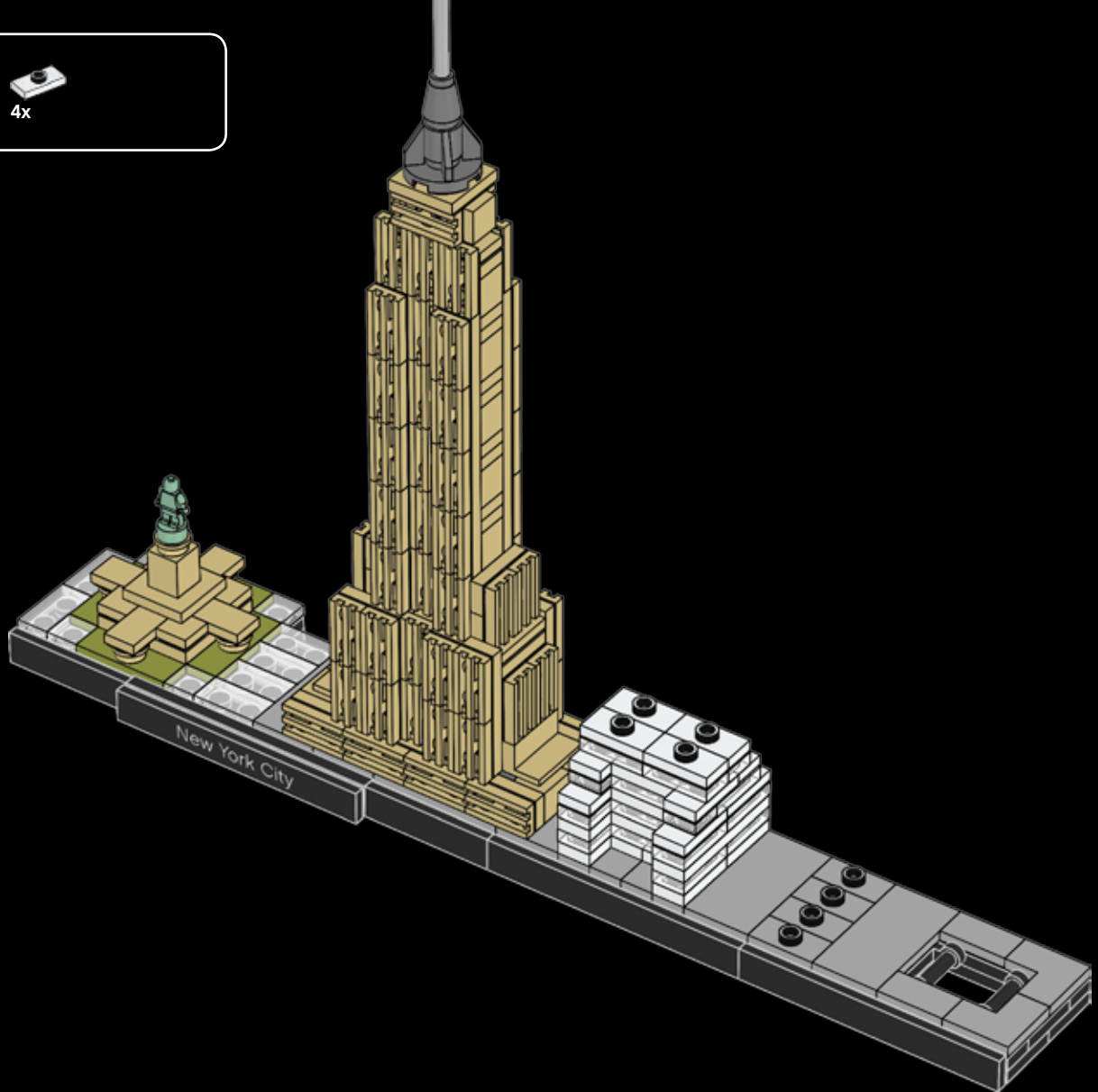

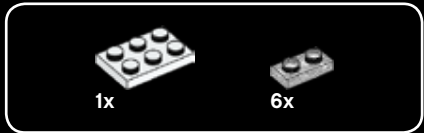

60

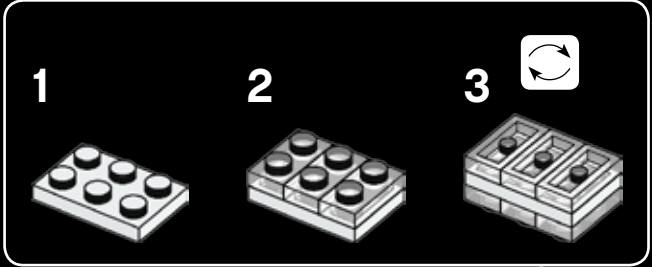
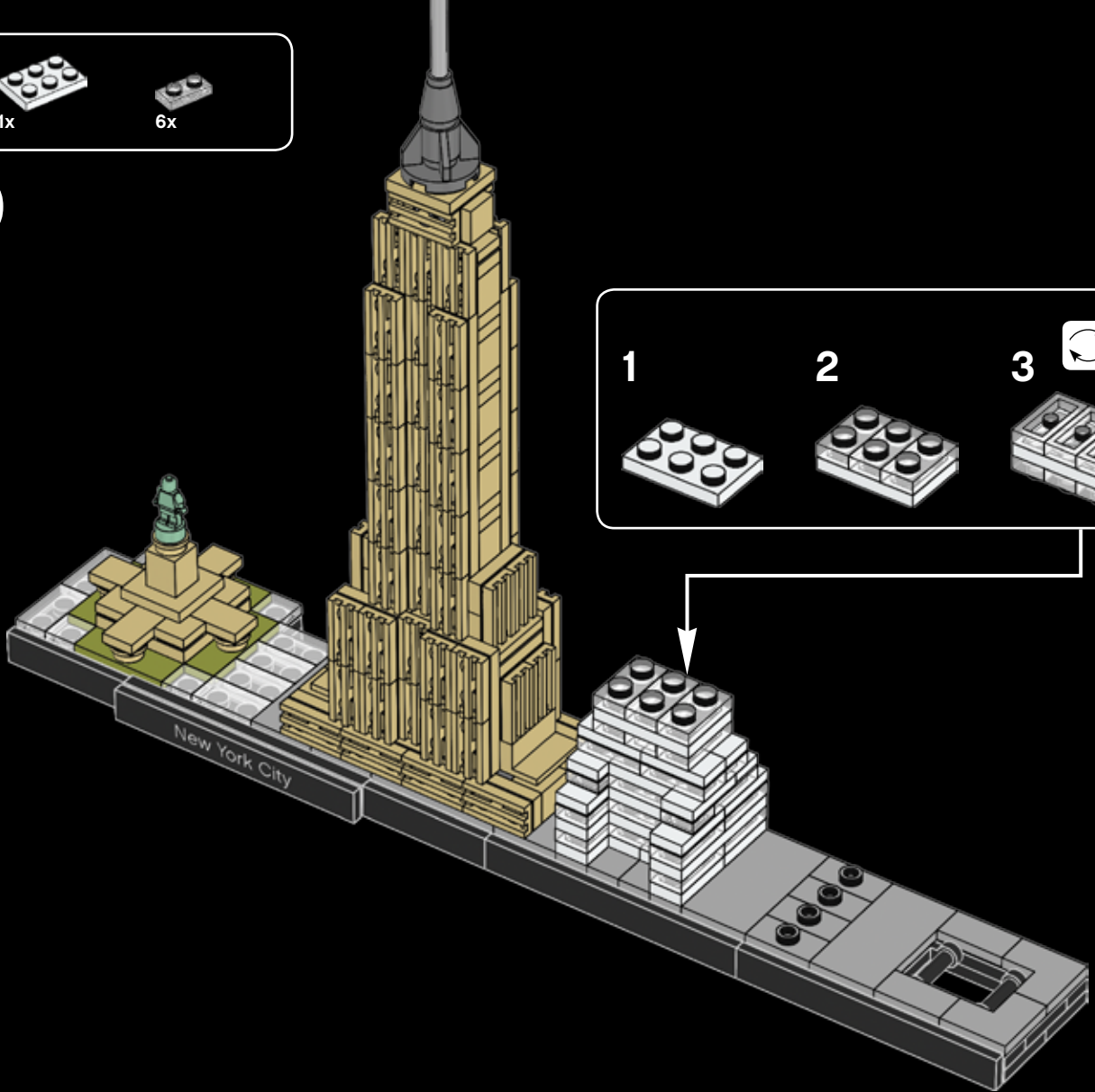



2x



2x

61

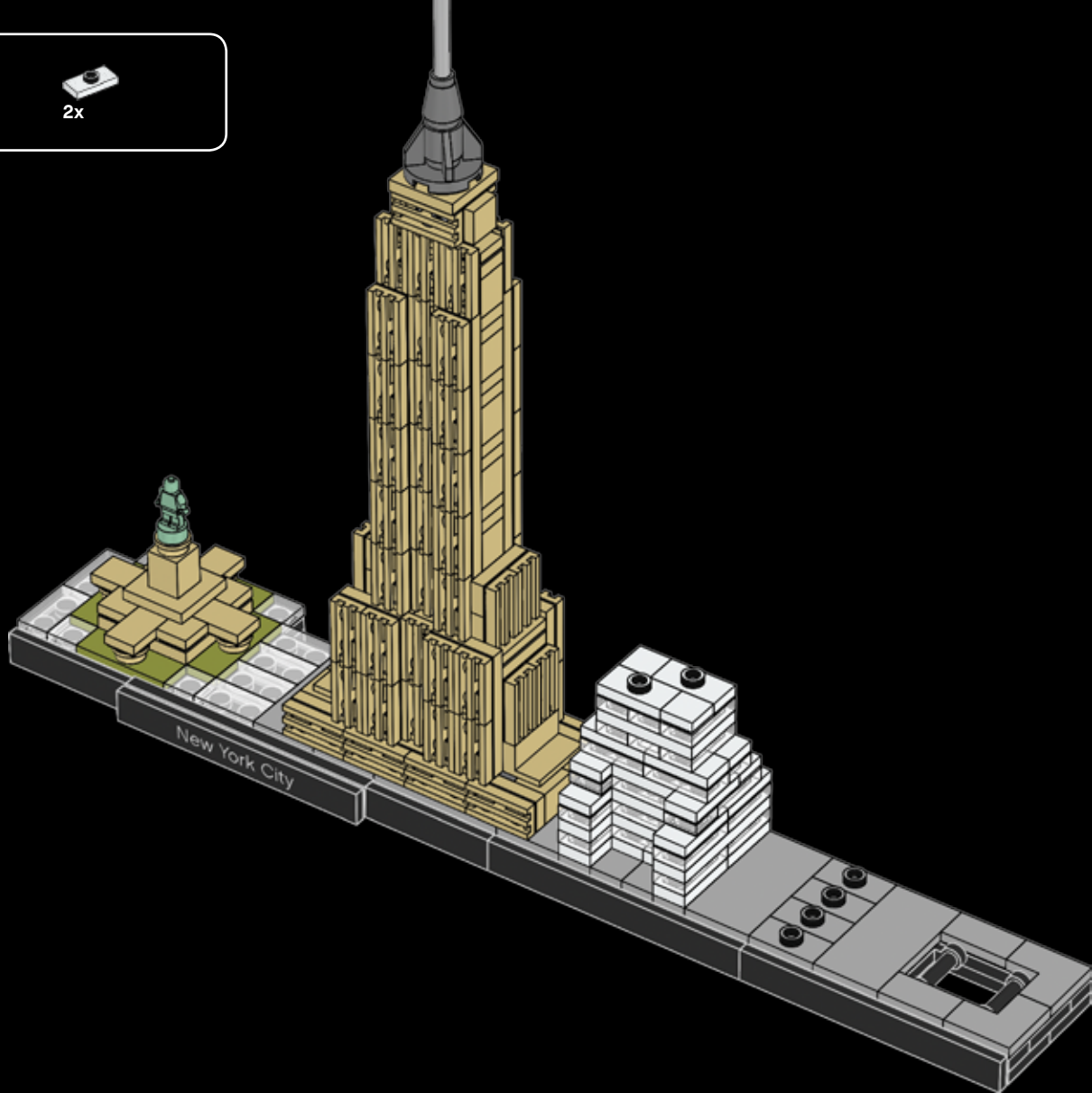



62

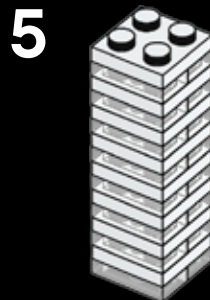
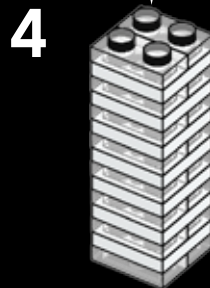
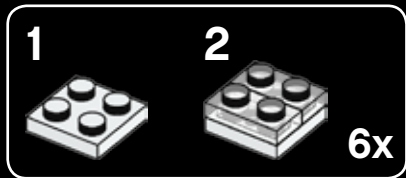
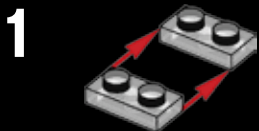

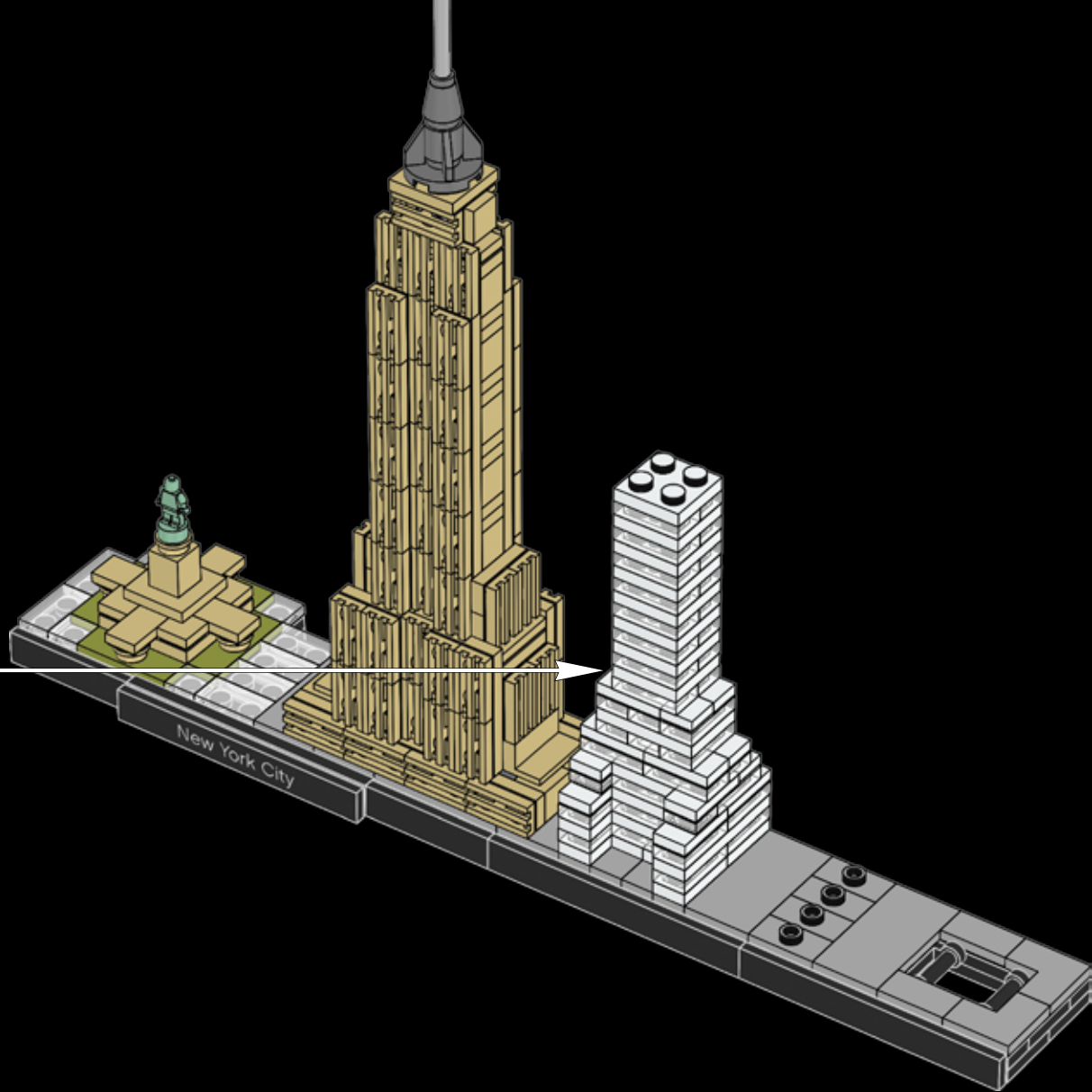

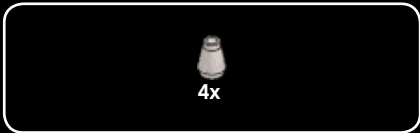

63

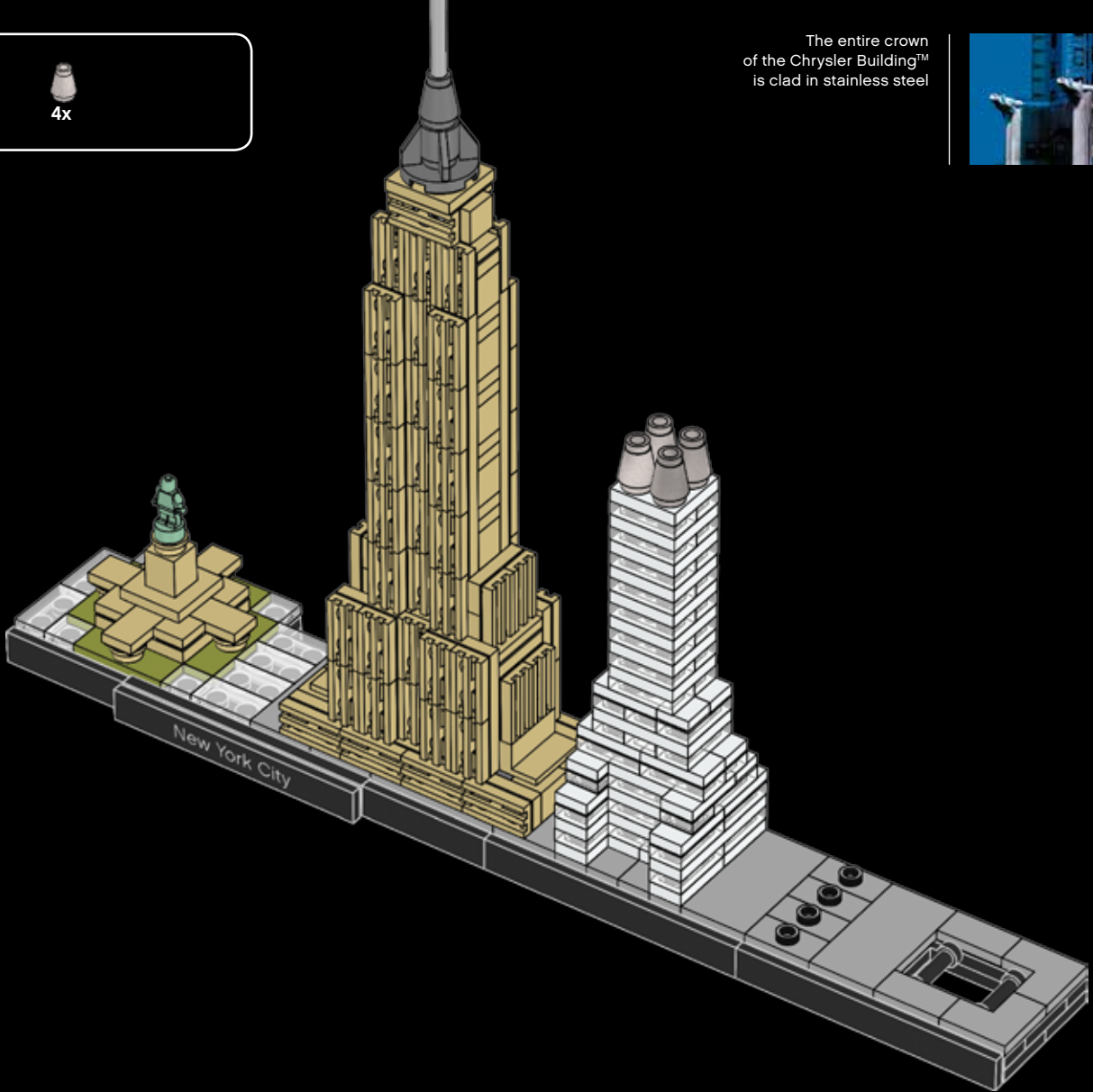

The entire crown of the Chrysler Building™ is clad in stainless steel



© Chrysler Building



64

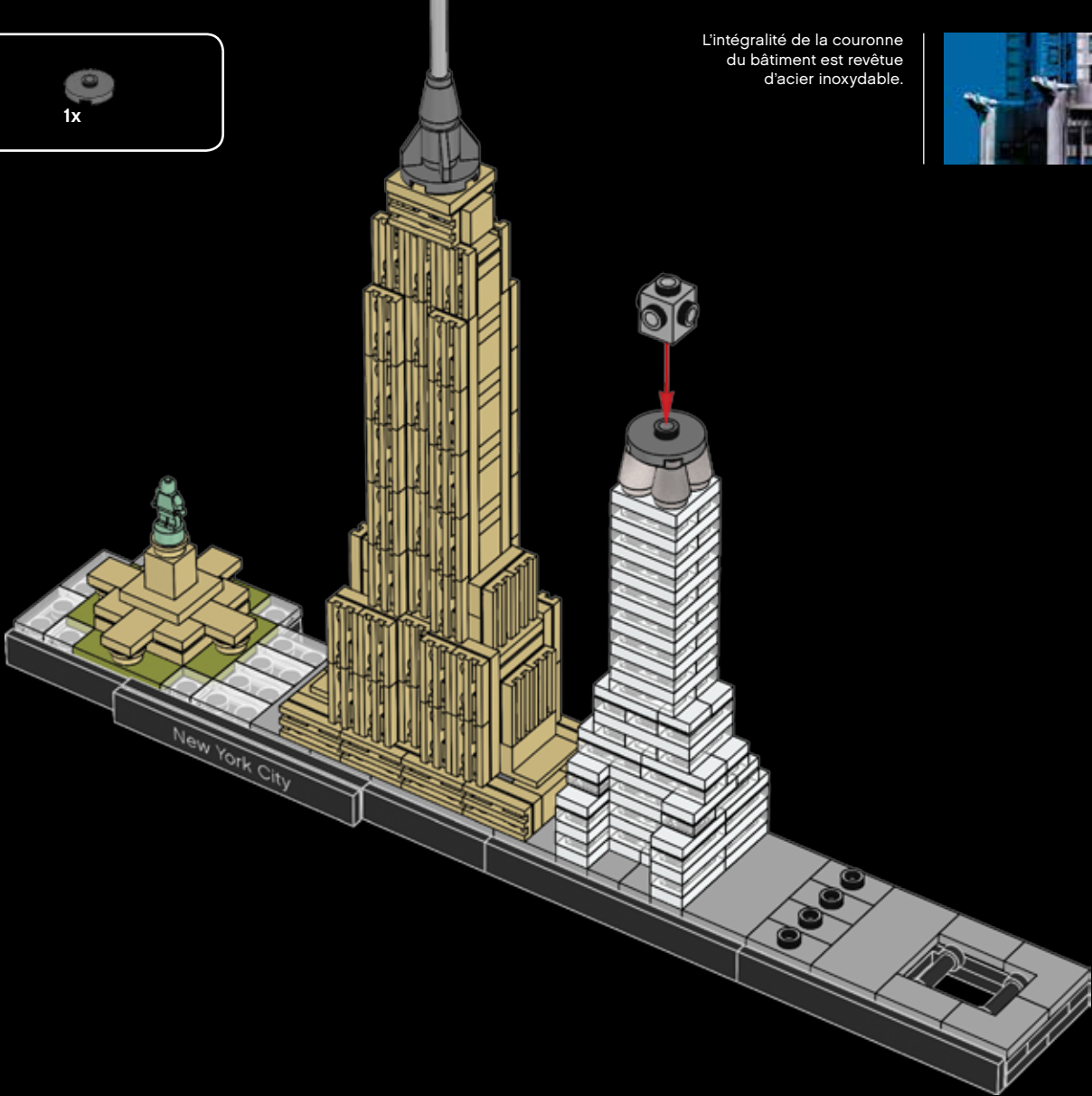

L'intégralité de la couronne
du bâtiment est revêtue
d'acier inoxydable.



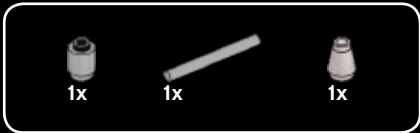

65

La sección superior del edificio está recubierta de acero inoxidable.

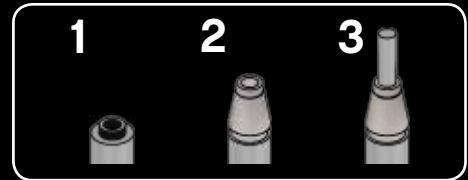



4x

66



4x

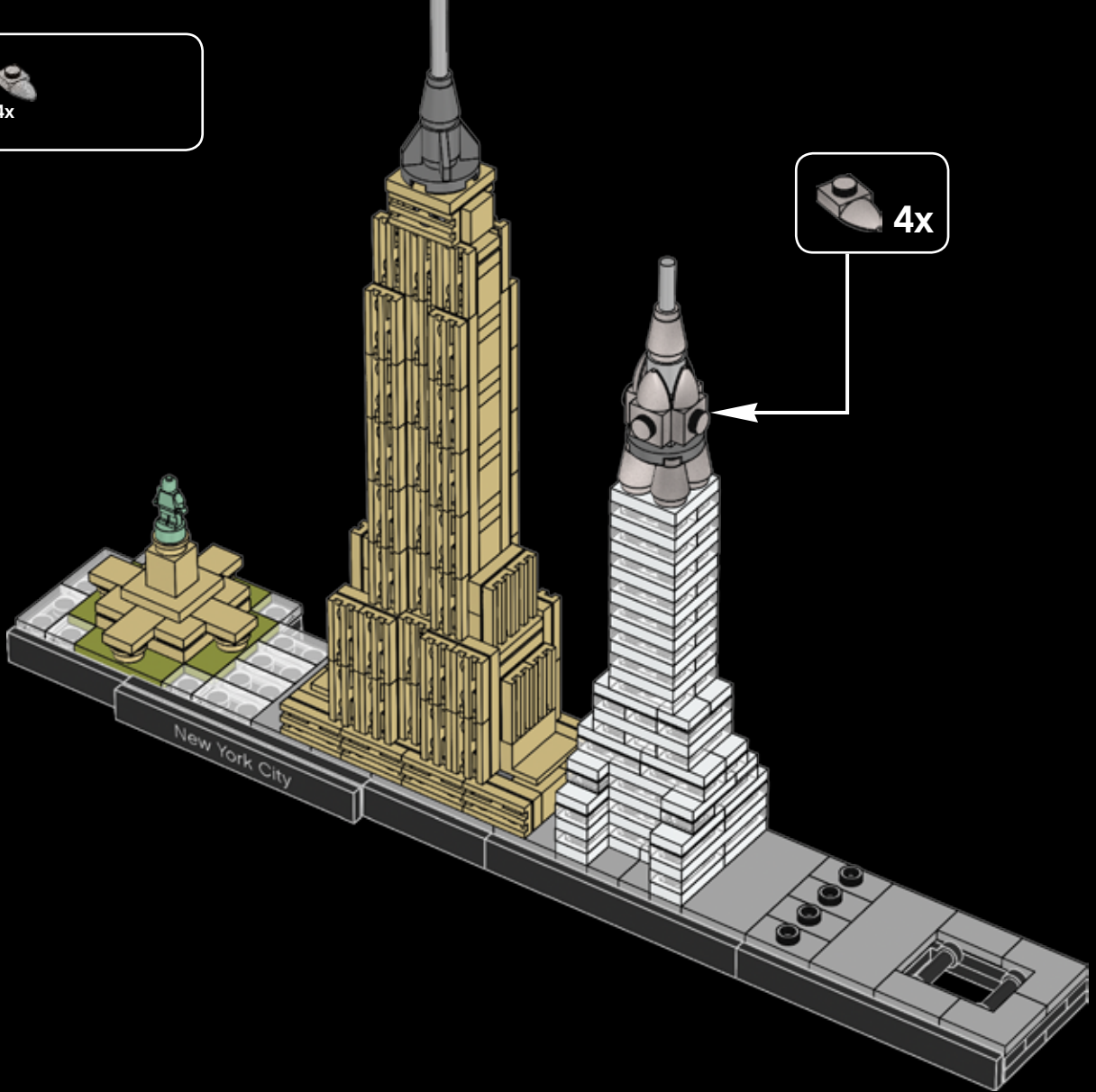



67

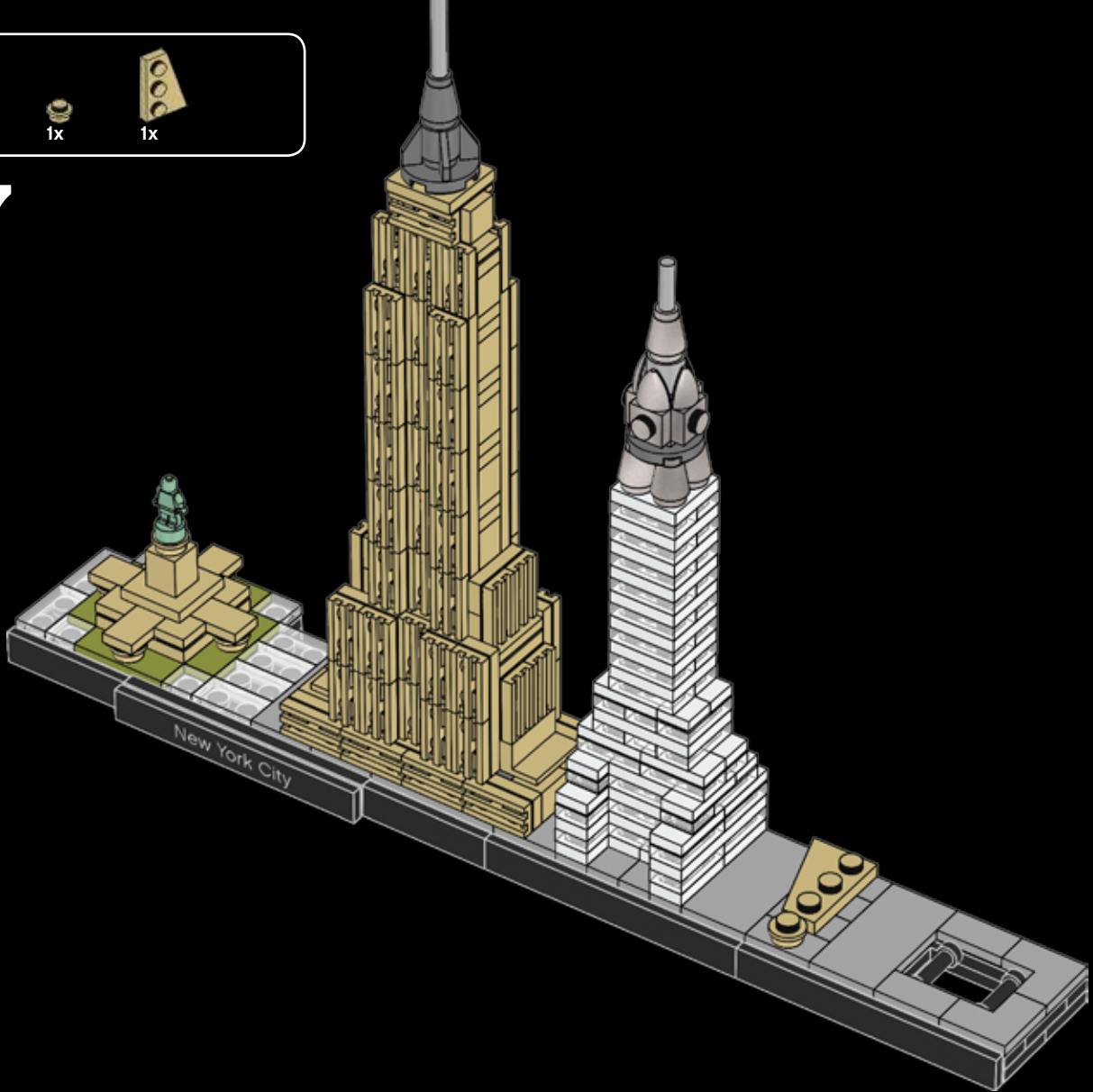

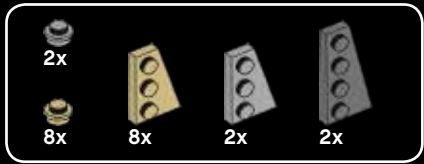

68

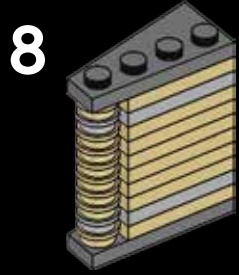
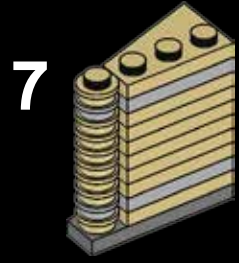
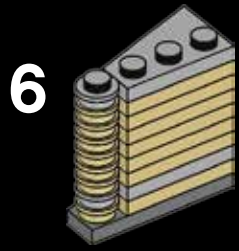
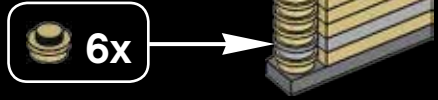
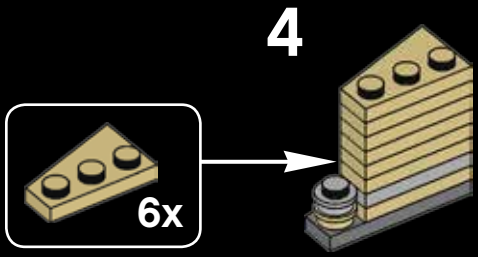
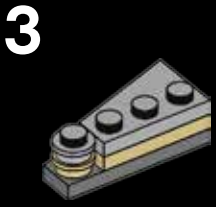
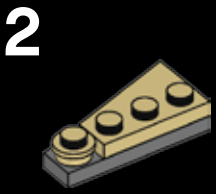
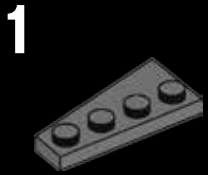

"I found myself agape,
admiring a sky-scraper...
plowing up through
the traffic of Broadway
and Fifth Avenue in the
afternoon light." H. G. Wells



© Shutterstock

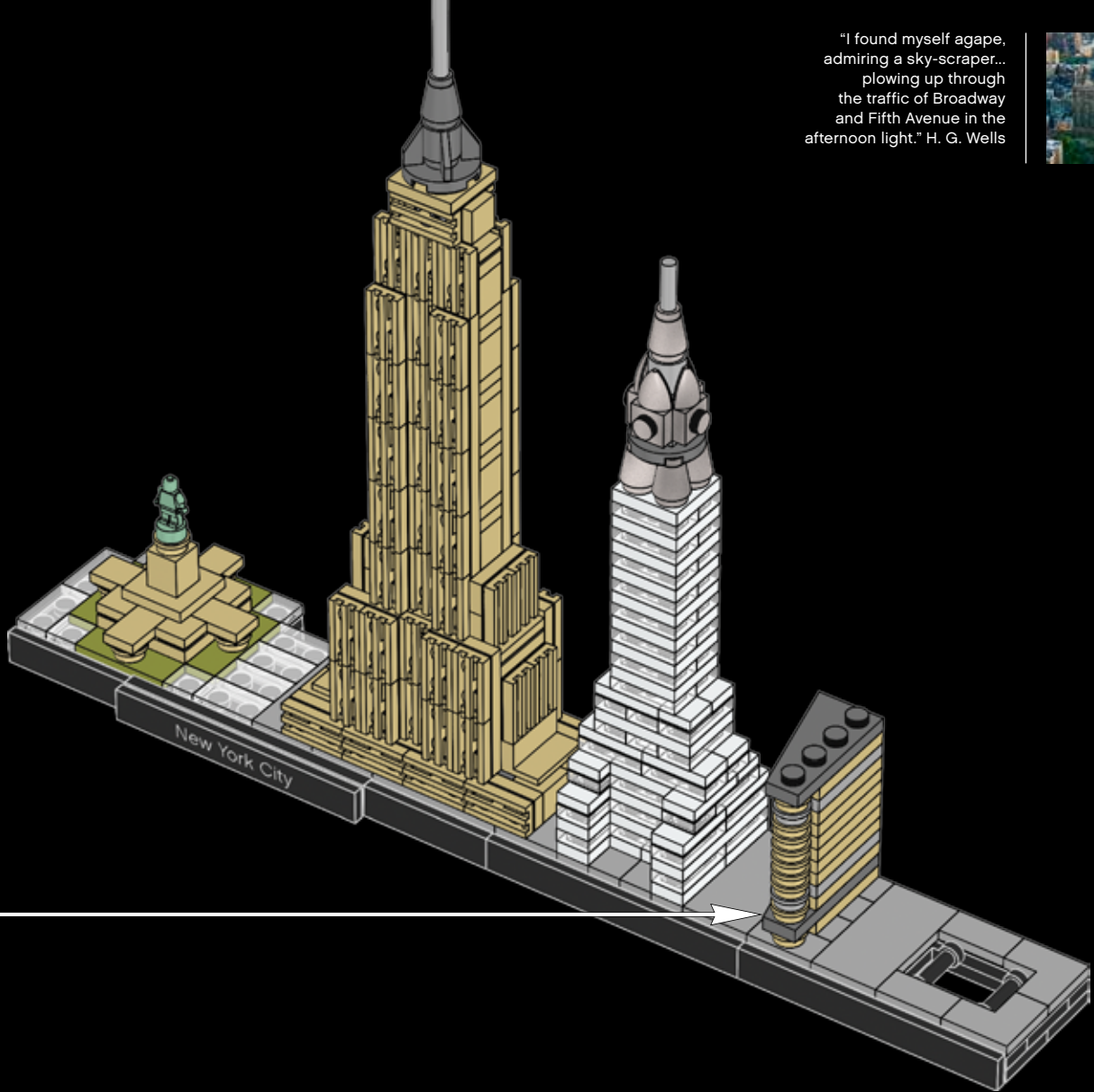

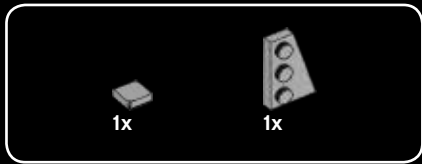

69

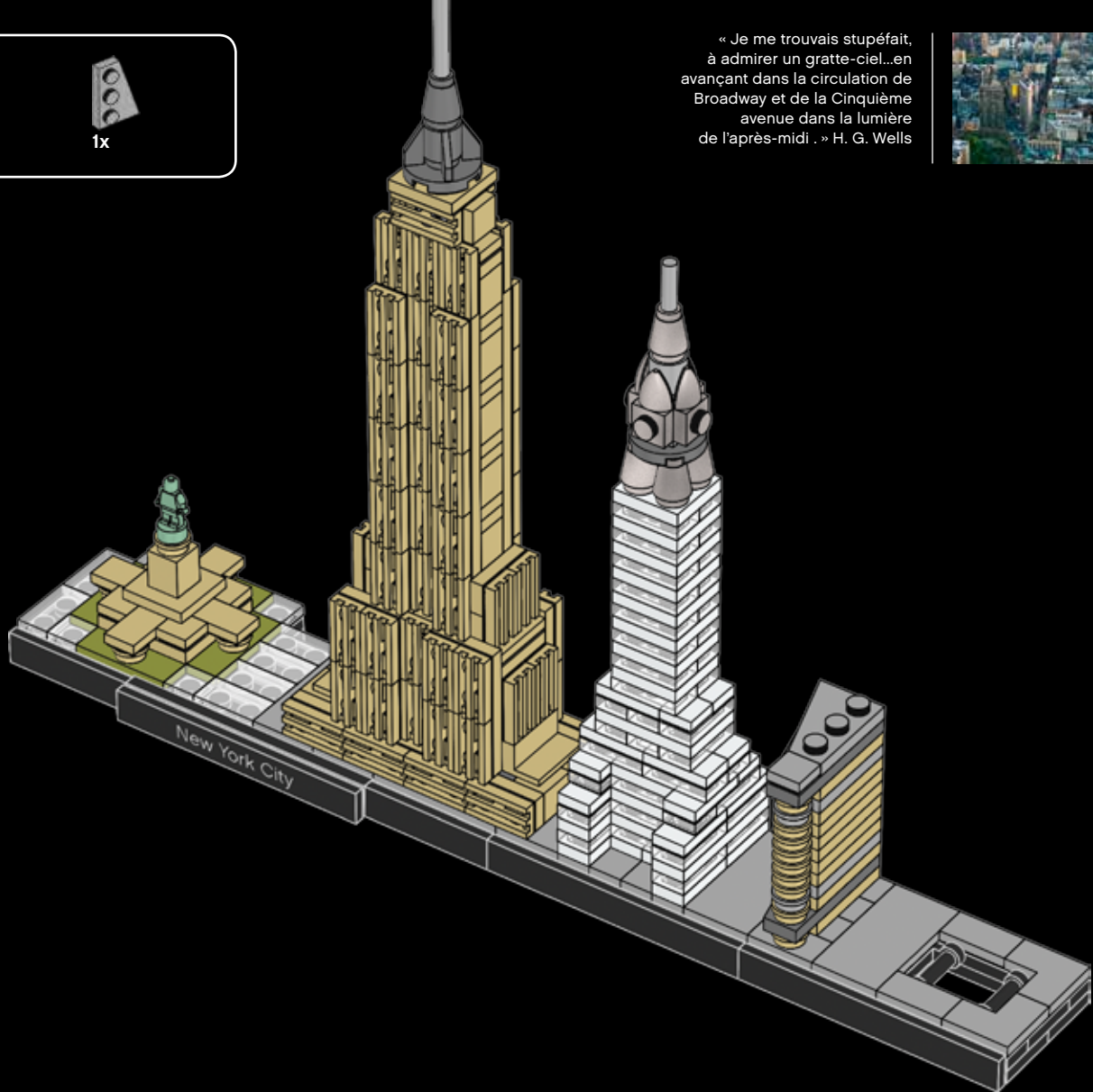

« Je me trouvais stupéfait, à admirer un gratte-ciel...en avançant dans la circulation de Broadway et de la Cinquième avenue dans la lumière de l'après-midi . » H. G. Wells



© Shutterstock

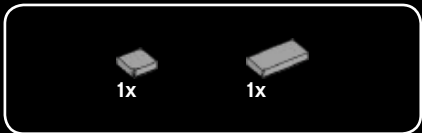

70

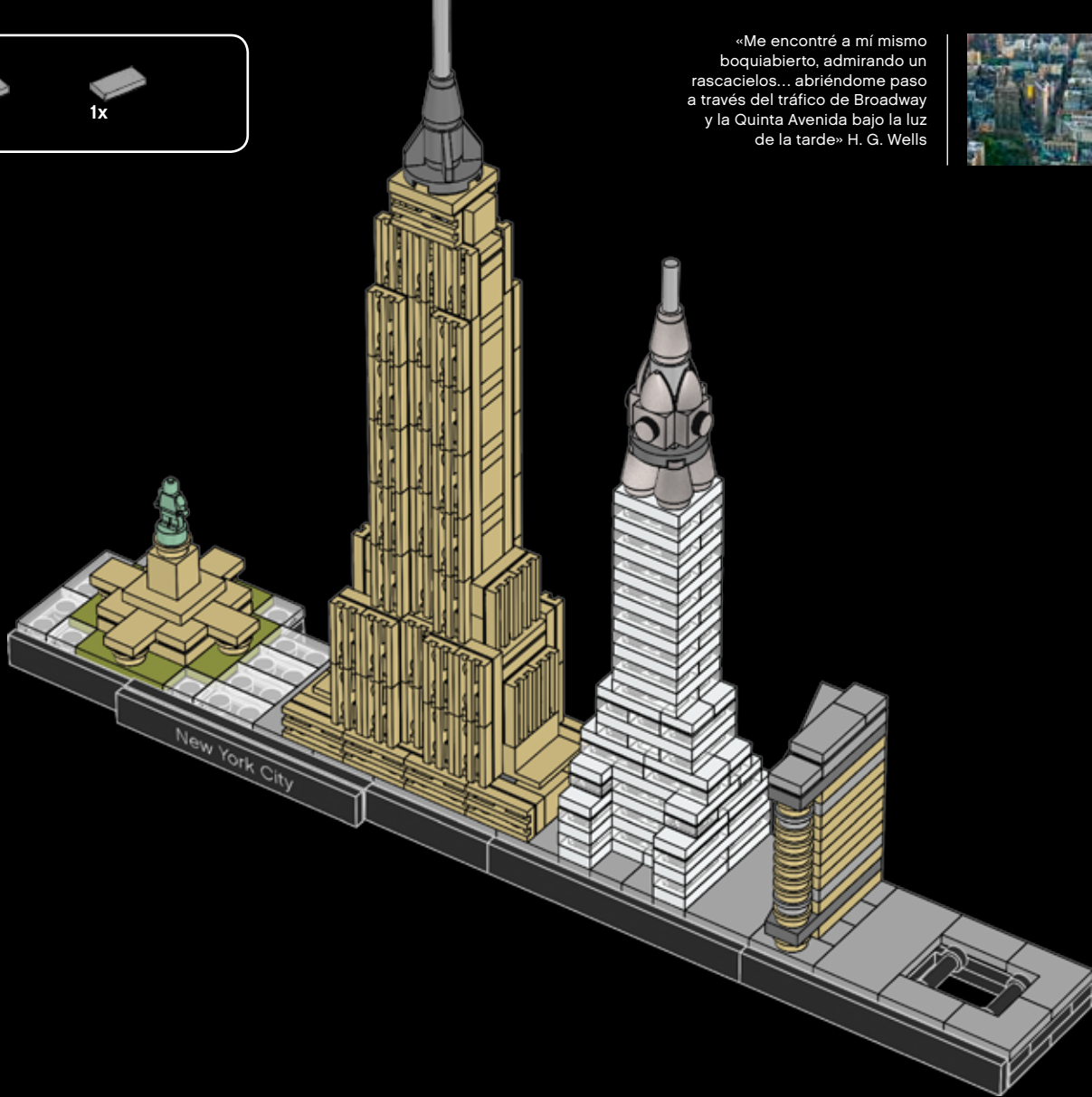

«Me encontré a mí mismo boquiabierto, admirando un rascacielos... abriéndome paso a través del tráfico de Broadway y la Quinta Avenida bajo la luz de la tarde» H. G. Wells



© Shutterstock



1

1



2



3



4



5



6

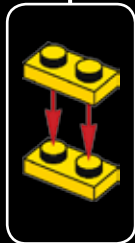

1

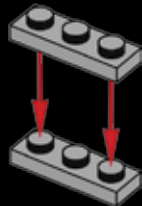

2



3



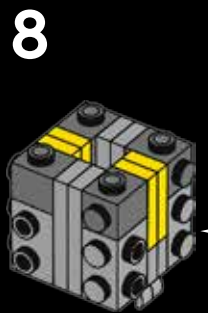
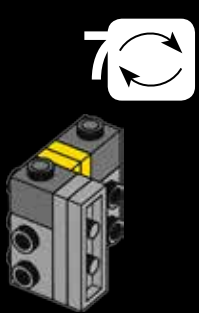
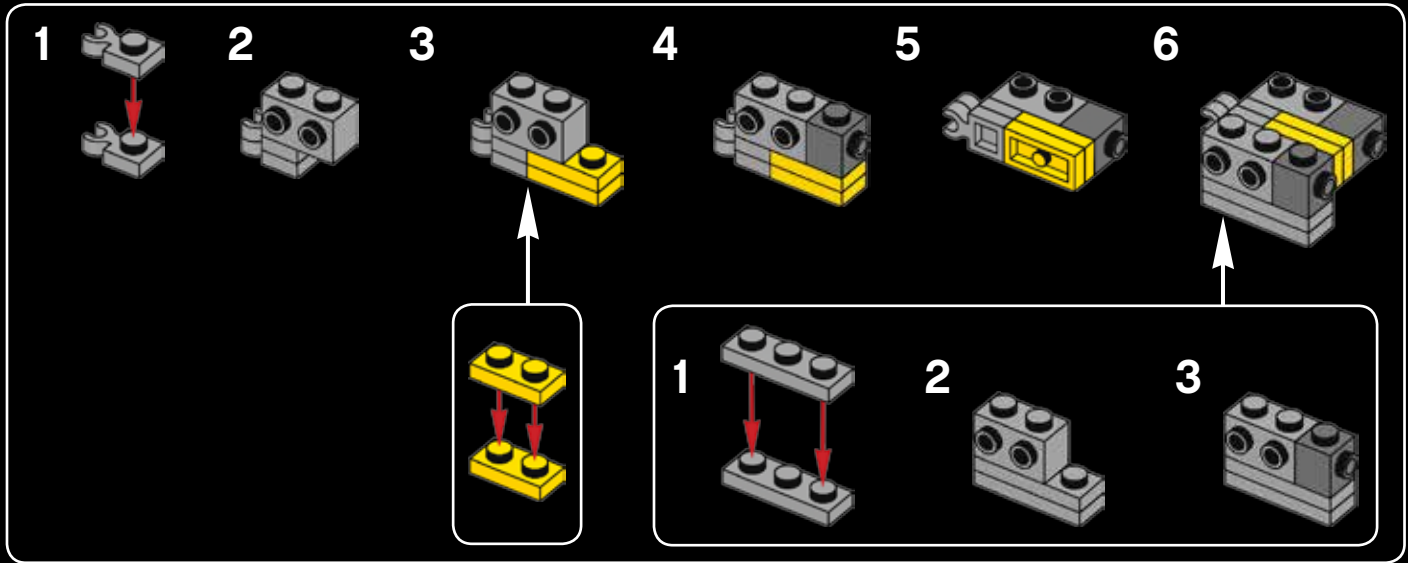



2x

9

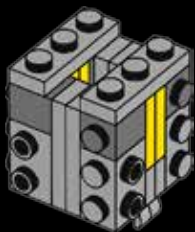

1x

10

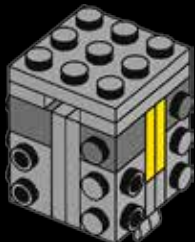

1x

11

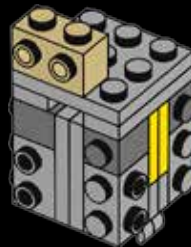

3x

12

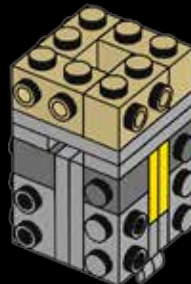

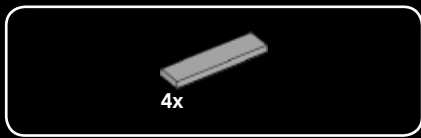

13

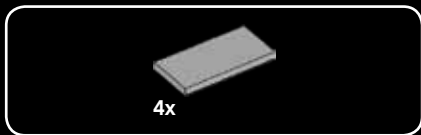
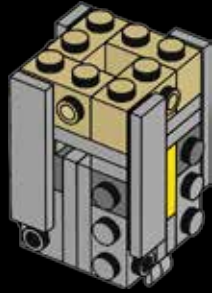

14



15

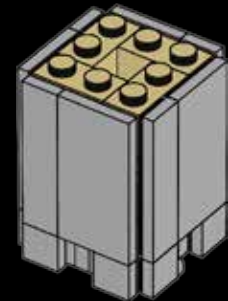

71

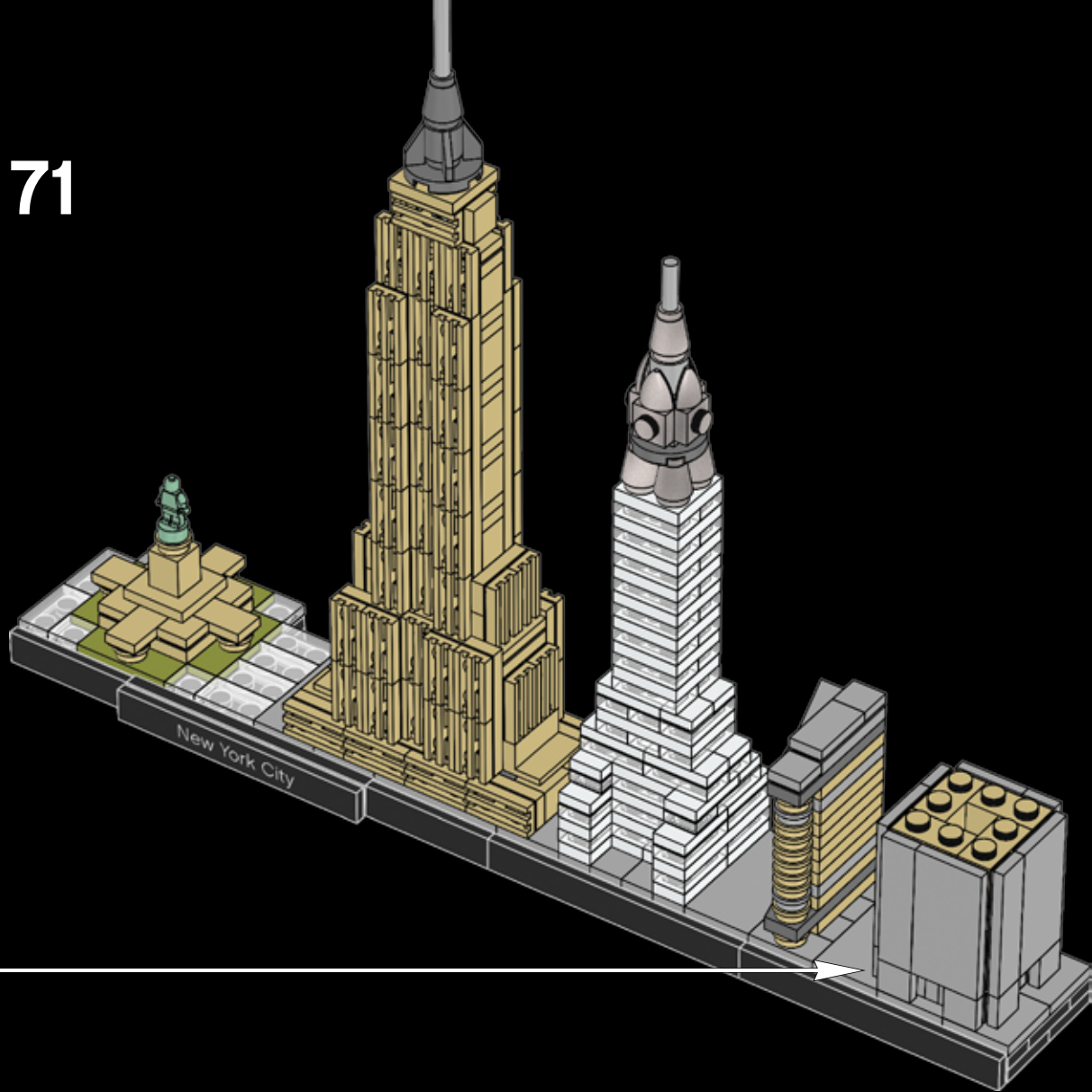

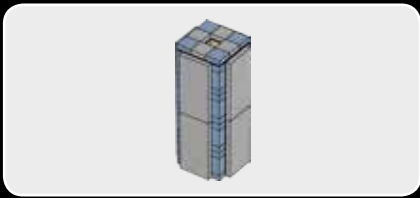

1

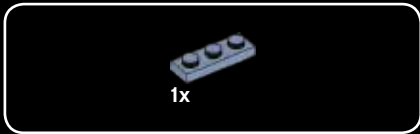

2



3

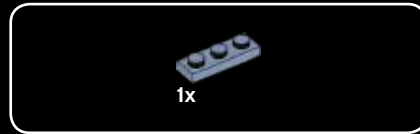

4



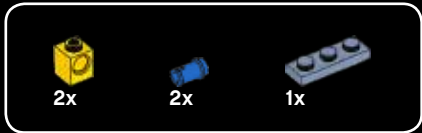

5

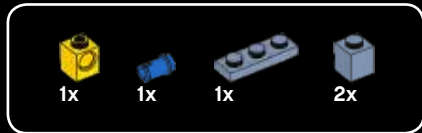
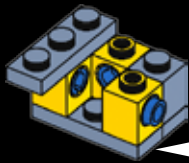
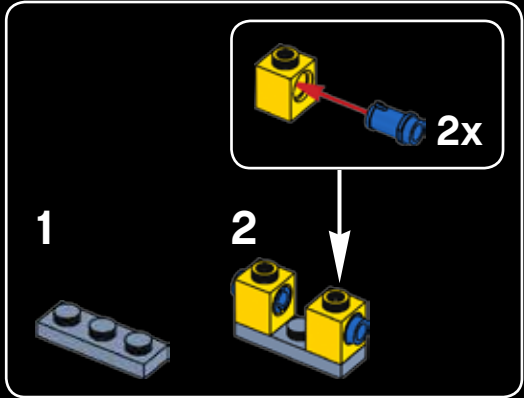

6

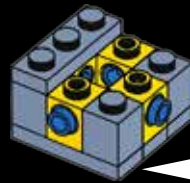
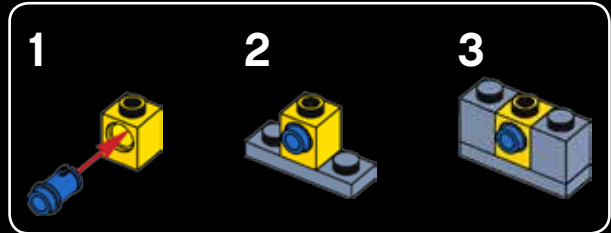



7



8

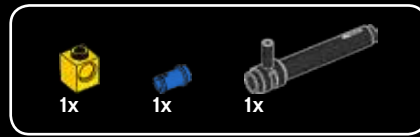
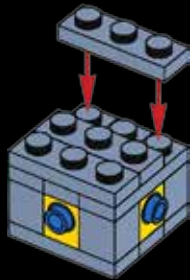

9

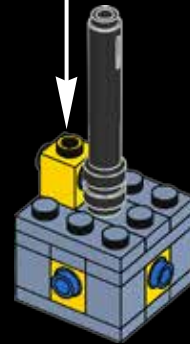
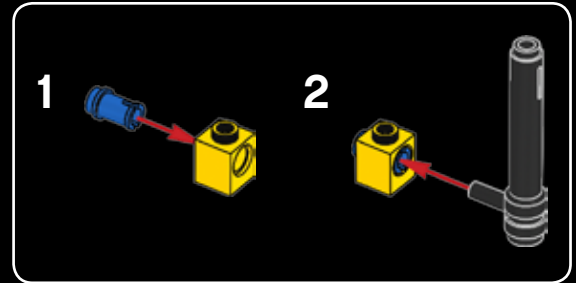



3x



3x

10

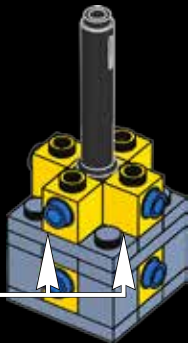
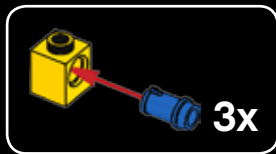

4x

11



2x



2x

12



2x



2x

13





14

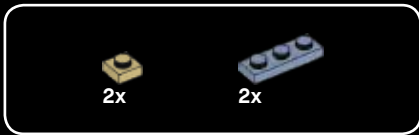
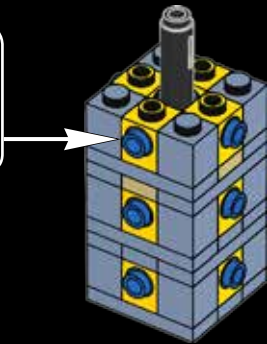
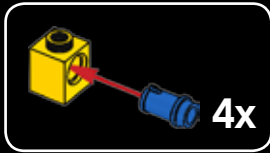

15

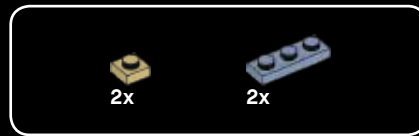

16



17

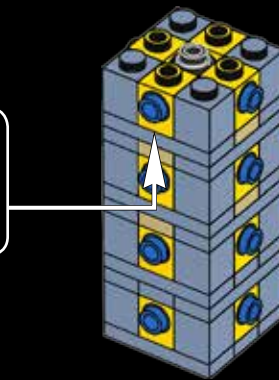
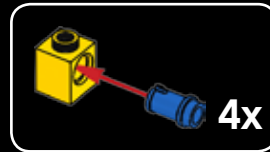



18

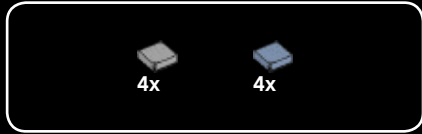
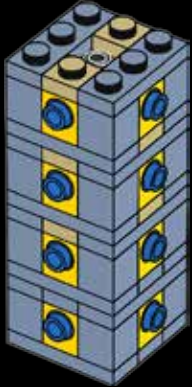

19

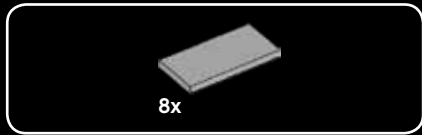
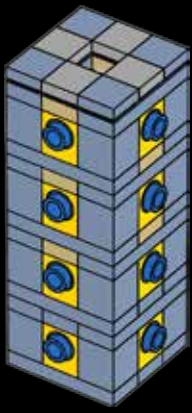

20

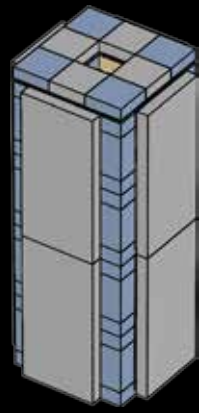

72

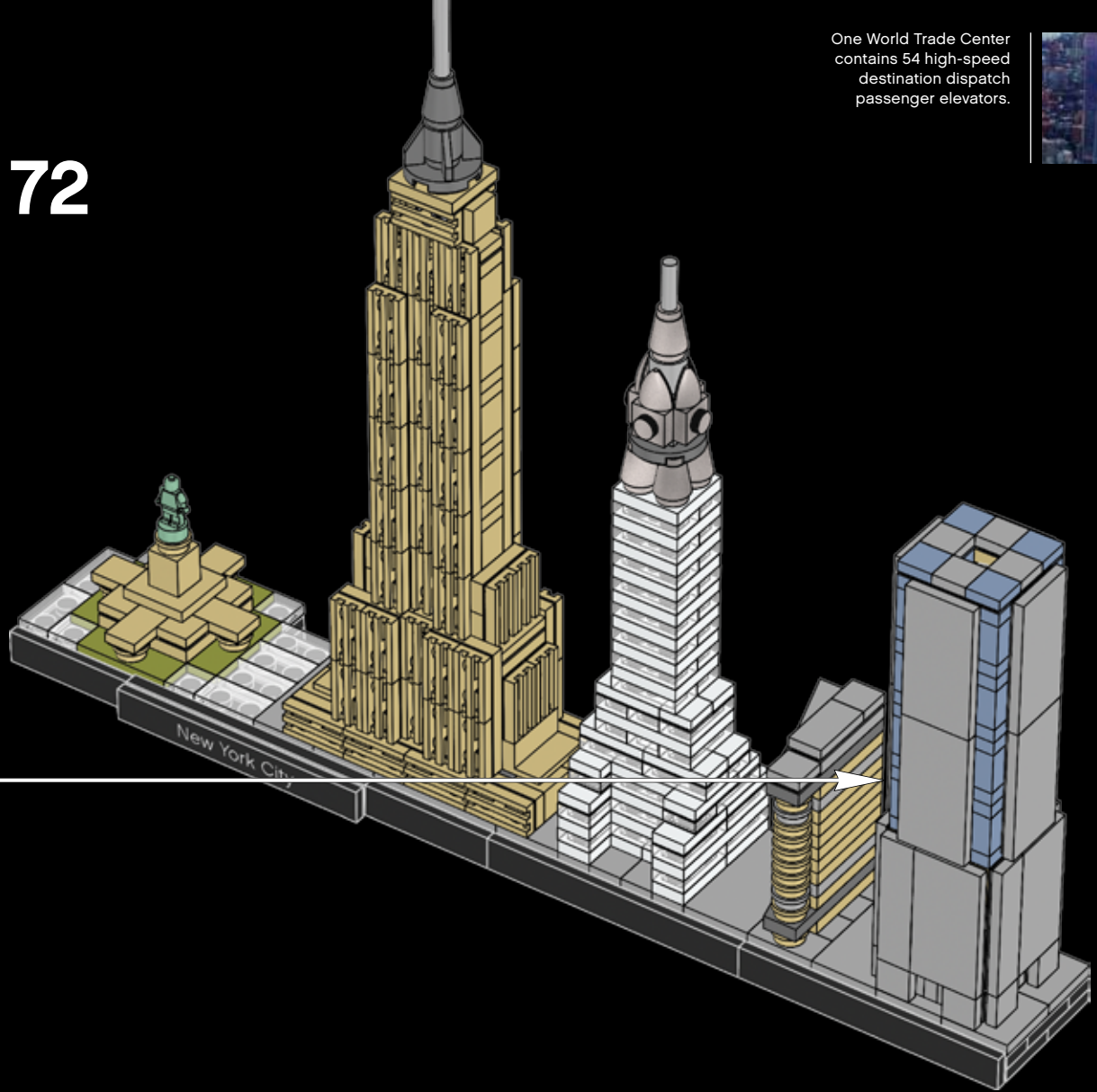

One World Trade Center contains 54 high-speed destination dispatch passenger elevators.



© One World Trade Center

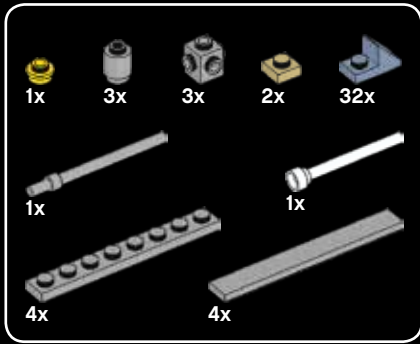

La tour contient 54 ascenseurs ultra rapides.



© One World Trade Center

73

1



2



3



4



5



6



La torre contiene 54
elevadores de alta
velocidad para la
distribución de pasajeros.



© One World Trade Center

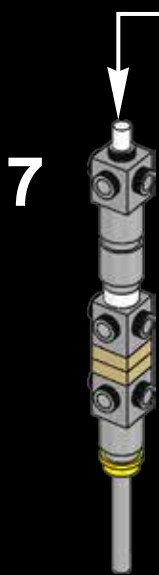
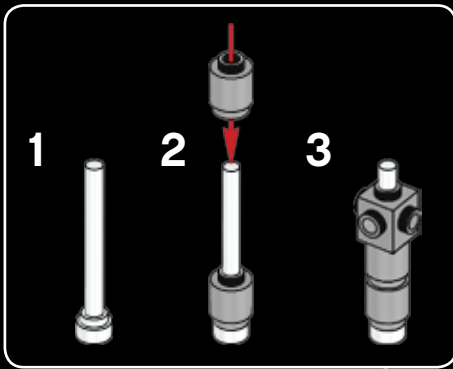

8

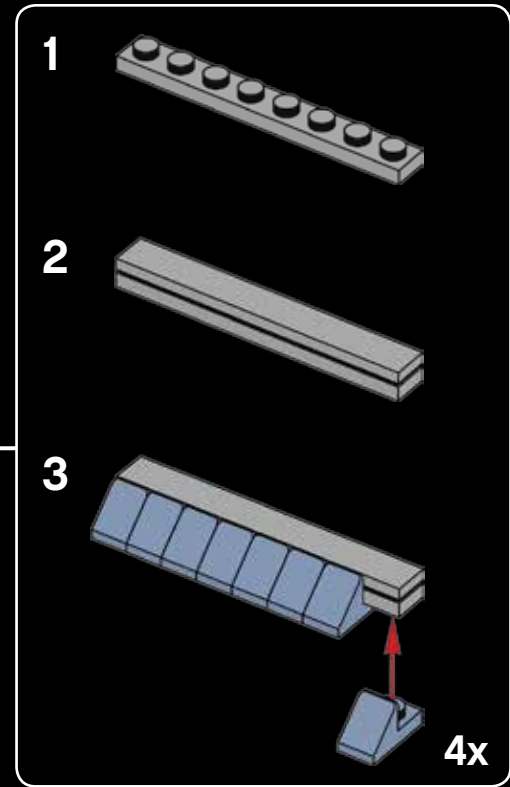
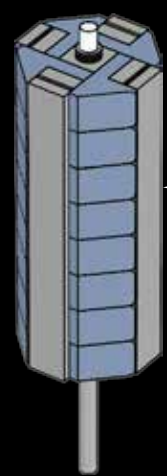

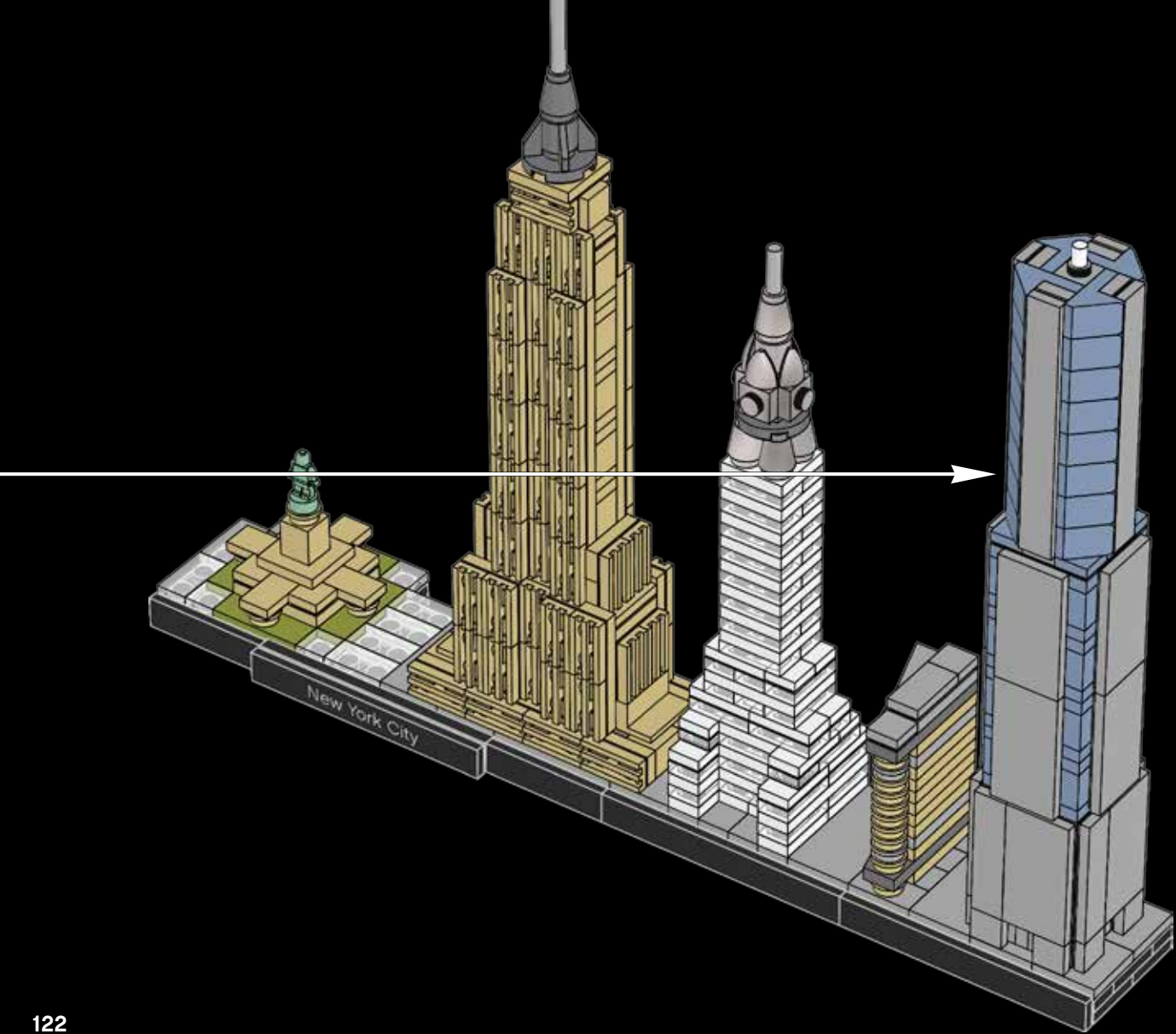

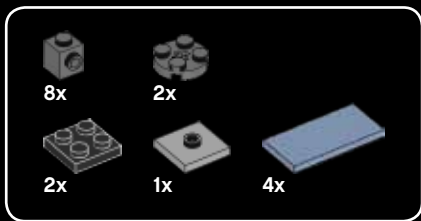

74

1



2



3

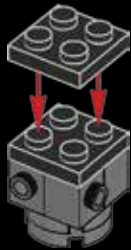

4



5



6



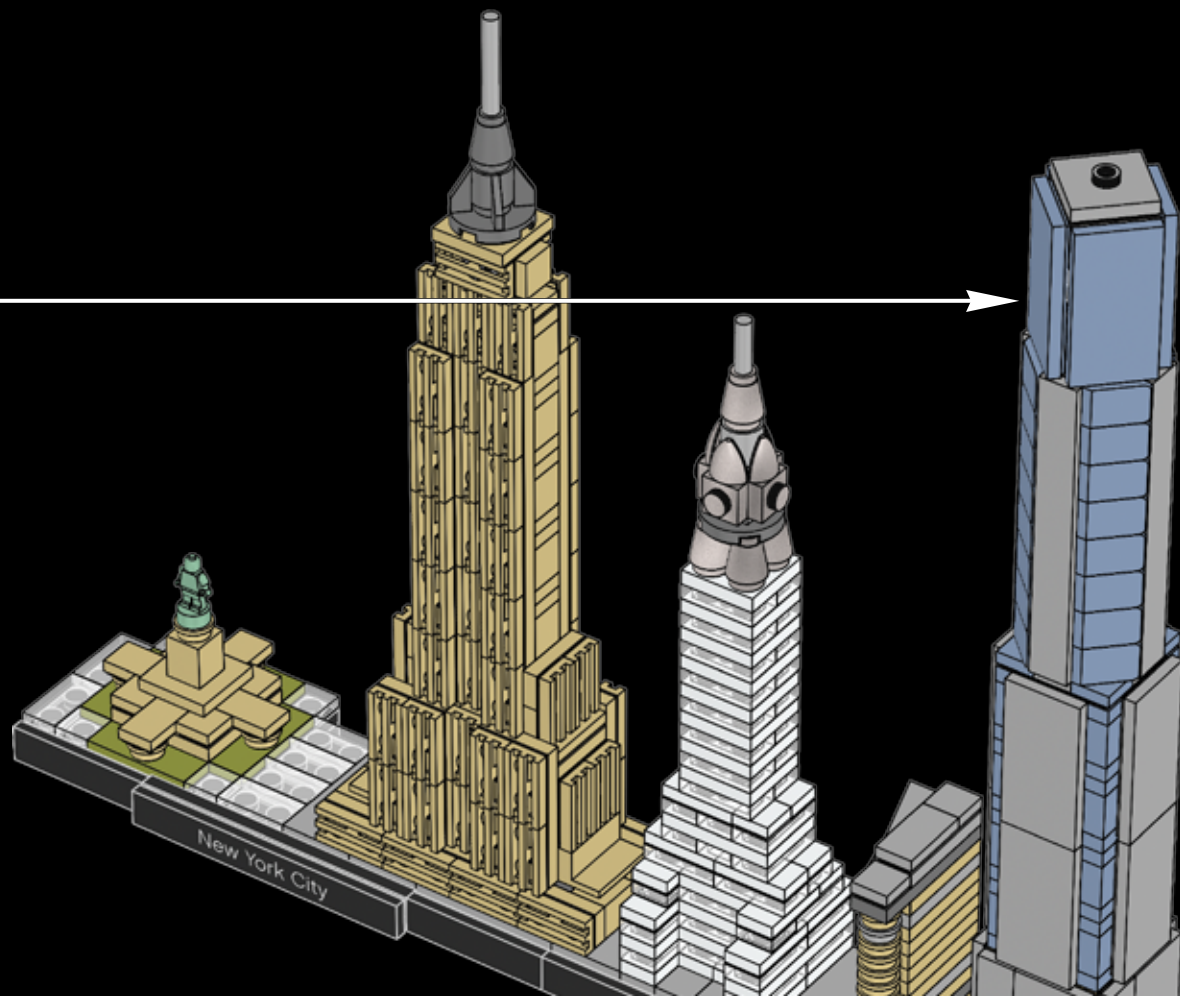

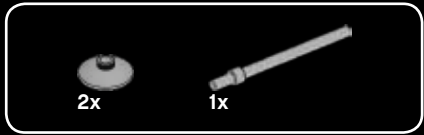

75

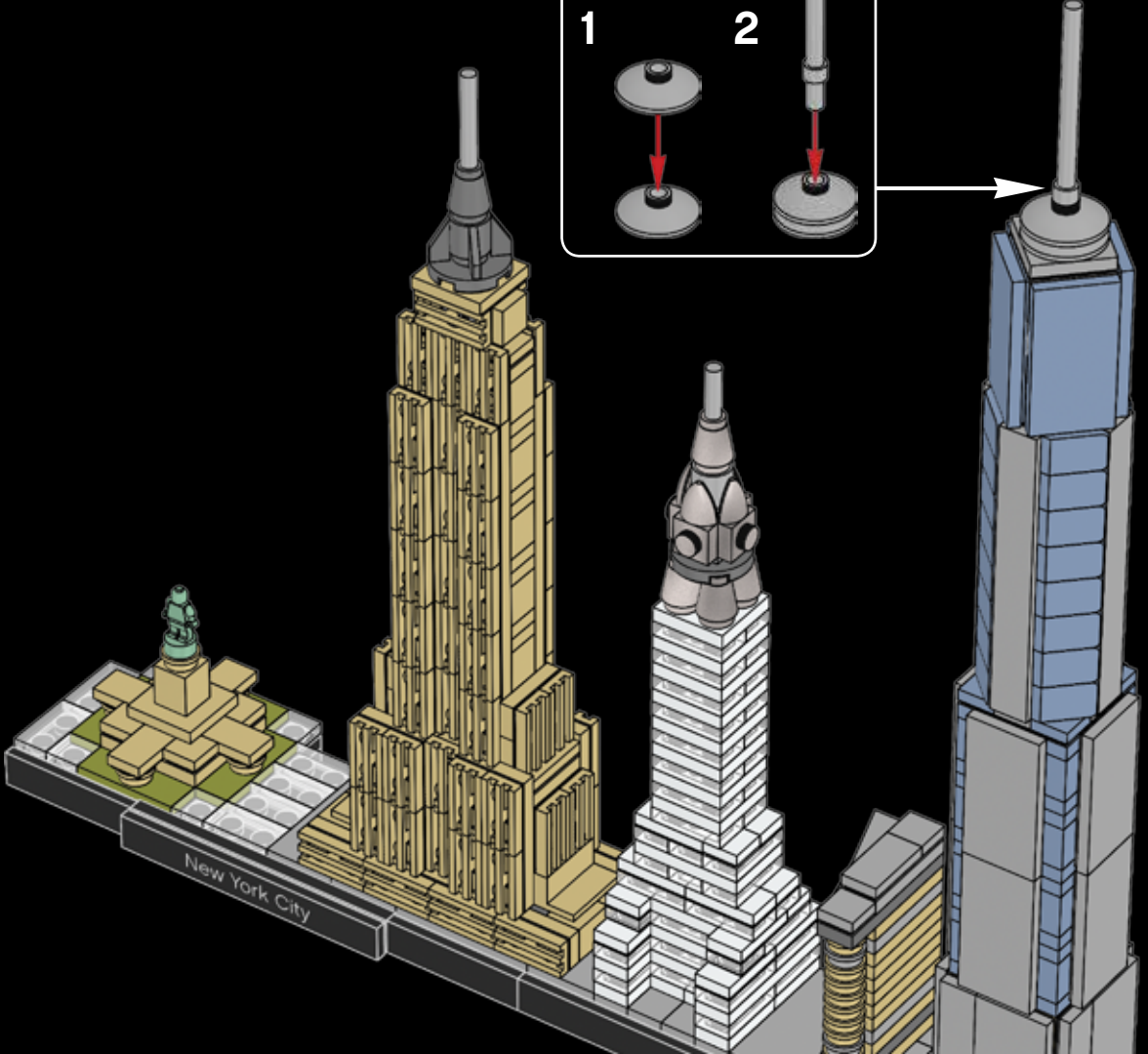
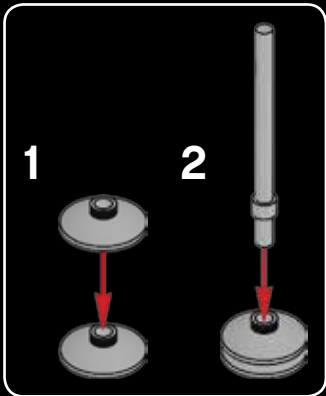





RAISING A BABY IN
AN NYC APARTMENT
IS LIKE GROWING
AN OAK TREE IN A
THIMBLE. Available
at
212-633-4343

LEGO® Architecture—then and now

There has always been a natural connection between the LEGO® brick and the world of architecture. Fans who build with LEGO elements instinctively develop an interest in the form and function of the structures they create. At the same time, many architects have discovered that LEGO bricks are the perfect way of physically expressing their creative ideas.

This connection was confirmed in the early 1960s with the launch of the LEGO 'Scale Model' line. It matched the spirit of the age where modern architects were redefining how houses look and people were taking an active interest in the design of their new homes. These sets were designed to be different from the normal, brightly colored LEGO boxes; they also included a book on architecture as a source of inspiration.

Decades later, architect and LEGO fan Adam Reed Tucker revived the idea of expressing architecture using LEGO bricks and in partnership with the LEGO

Group, launched the LEGO Architecture line that we know today. His first models, and the original sets in the current LEGO Architecture series, were interpretations of famous skyscrapers from his hometown of Chicago. Since then LEGO Architecture has developed and evolved, first with well-known buildings from other cities in the United States, and now with iconic structures from Europe, the Middle East and Asia.

The introduction of our LEGO Architecture Studio set echoes the ambitions of the earlier LEGO 'Scale Model' line and widens the potential of the LEGO Architecture series. Now you can enjoy building and learning about specific landmark buildings, or create exciting architectural models from your own fantasy. An inspiring 270-page book, featuring a number of renowned architects from around the world, guides you through the principles of architecture and encourages you in your own creative building.

LEGO® Architecture – Hier et aujourd'hui

Il y a toujours eu une connexion naturelle entre la brique LEGO® et le monde de l'architecture. Les fans qui construisent avec des éléments LEGO développent instinctivement un intérêt pour la forme et la fonction des structures qu'ils créent. De nombreux architectes ont quant à eux découvert que les briques LEGO sont la façon idéale de matérialiser leurs idées de création.

Cette connexion a été confirmée au début des années 1960 avec le lancement de la gamme « Maquettes à l'échelle » LEGO. Cette gamme correspondait à l'esprit de l'époque, alors que les architectes modernes redéfinissaient les maisons, et que les gens s'intéressaient activement à la conception de leur résidence. Ces ensembles originaux étaient conçus pour être différents des boîtes LEGO habituelles aux couleurs vives, et incluaient aussi un livret d'architecture comme source d'inspiration.

Quelques décennies plus tard, l'architecte et fan de LEGO Adam Reed Tucker a fait revivre l'idée d'exprimer l'architecture en utilisant des briques LEGO. En partenariat avec le Groupe LEGO, il lança la gamme

LEGO Architecture que nous connaissons aujourd'hui. Ses premiers modèles, et les ensembles originaux de la gamme LEGO Architecture actuelle, étaient des interprétations de célèbres gratte-ciel de sa ville natale de Chicago. La gamme LEGO Architecture a depuis évolué et s'est élargie, tout d'abord avec des bâtiments célèbres d'autres villes des États-Unis, puis avec de célèbres monuments d'Europe, du Moyen-Orient et d'Asie.

L'introduction de notre ensemble LEGO Architecture Studio fait écho aux ambitions de la précédente gamme « Maquettes à l'échelle » LEGO et accroît le potentiel de la gamme LEGO Architecture. Vous pouvez maintenant découvrir et construire des monuments célèbres ou créer de passionnants modèles architecturaux nés de votre imagination. Un livret d'inspiration de 270 pages, présentant plusieurs architectes célèbres du monde entier, vous guide parmi les principes de l'architecture et vous encourage dans votre propre construction créatrice.

LEGO® Architecture: entonces y ahora

Siempre ha existido una conexión natural entre el brick LEGO® y el mundo de la arquitectura. Los fans que construyen con elementos LEGO desarrollan instintivamente un interés por la forma y las funciones de las estructuras que crean. Al mismo tiempo, muchos arquitectos han descubierto que los bricks LEGO son una forma perfecta de expresar físicamente sus ideas creativas.

Esta relación se confirmó a principios de la década de 1960, con el lanzamiento de la línea «Scale Model» de LEGO. Encajaba bien con el espíritu de la época: un tiempo en el que los arquitectos modernos redefinían el aspecto de las casas y la gente se interesaba cada vez más por el diseño de su nuevo hogar. Los sets se diseñaron para que se diferenciaban de los normales, que se comercializaban en cajas de brillantes colores, e incluían un libro sobre la arquitectura que proporcionaba inspiración a sus usuarios.

Décadas más tarde, el arquitecto y fan de LEGO Adam Reed Tucker reavivó la idea de expresar la

arquitectura usando bricks LEGO y, en colaboración con The LEGO Group, lanzó la línea LEGO Architecture que hoy conocemos. Sus primeros modelos, y los sets originales de la actual serie LEGO Architecture, eran interpretaciones de los rascacielos más famosos de su ciudad natal, Chicago. Desde entonces, LEGO Architecture se ha desarrollado y ha evolucionado, primero incorporando edificios célebres de otras ciudades de Estados Unidos y, ahora, estructuras emblemáticas de Europa, Oriente Próximo y Asia.

La introducción del set LEGO Architecture Studio recupera las ambiciones de la antigua línea «Scale Model» de LEGO y amplía el potencial de la serie LEGO Architecture. Hoy puedes disfrutar mientras construyes y aprendes sobre edificios célebres, o crear tus propios modelos arquitectónicos a partir de tu imaginación. Un instructivo libro de 270 páginas con materiales creados por arquitectos internacionales de gran reputación te guiará a través de los principios de la arquitectura y te animará a dar tus primeros pasos en el mundo de la construcción creativa.



21050
Studio

Celebrate the world of architecture and collect all the models
Célébrez le monde de l'architecture et collectionnez tous les modèles
Celebra el mundo de la arquitectura y colecciona todos los modelos

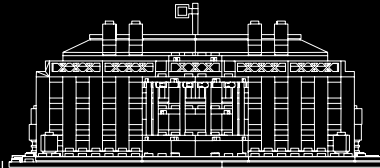

21006
The White House
La Maison-Blanche
La Casa Blanca

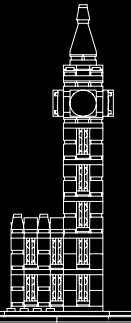

21013
Big Ben

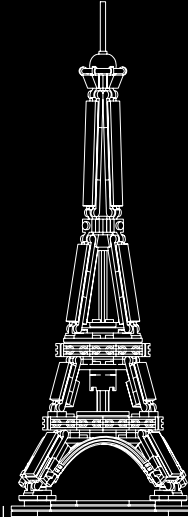

21019
The Eiffel Tower
La tour Eiffel
La torre Eiffel

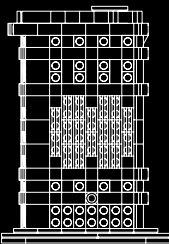

21023
Flatiron Building
Le Flatiron Building
Edificio Flatiron



21024
Louvre



21020
Trevi Fountain
La fontaine de Trevi
Fontana de Trevi

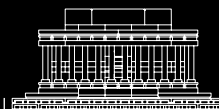

21022
Lincoln Memorial
Le monument de Lincoln
Monumento a Lincoln



21027
Berlin
Berlín

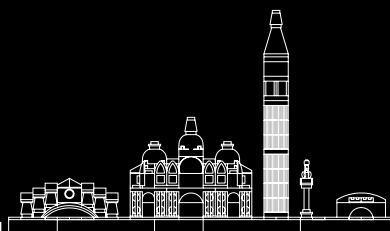

21026
Venice
Venise
Venecia

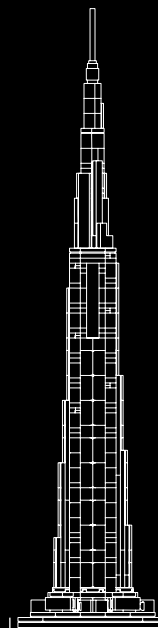

21031
Burj Khalifa

References

Photo Credits -

© Shutterstock

© Chrysler Building

© Empire State Realty Trust, Inc.

© Everett Historical

Text -

www.nycgo.com

www.wtc.com

www.esbnyc.com

www.nps.gov

www.flatirondistrict.nyc

Références

Crédits photographiques -

© Shutterstock

© Chrysler Building

© Empire State Realty Trust, Inc.

© Everett Historical

Texte -

www.nycgo.com

www.wtc.com

www.esbnyc.com

www.nps.gov

www.flatirondistrict.nyc

Referencias

Fotografías -

© Shutterstock

© Chrysler Building

© Empire State Realty Trust, Inc.

© Everett Historical

Texto -

www.nycgo.com

www.wtc.com

www.esbnyc.com

www.nps.gov

www.flatirondistrict.nyc

Customer Service
Kundenservice
Service Consommateurs
Servicio Al Consumidor
LEGO.com/service or dial



00800 5346 5555 :



1-800-422-5346 :



6x
4558952

4x
307001

12x
6051511

4x
242001

12x
302201

1x
302101

2x
371001

1x
395701

14x
4161734

22x
4159553

5x
4113915

8x
4125253

16x
421356

9x
6138230

74x
4124456

6x
4114026

3x
6092587

2x
4124460

12x
6024495

4x
4113917

2x
4565387

3x
4114084

11x
4121921

5x
4118790

4x
4114309

2x
4114324

4x
4143409

16x
4143005

1x
6050850

16x
654124

4x
302324

2x
302426

7x
302326

2x
4225201

3x
302226

2x
242026

1x
6052126

2x
362326

2x
243126

2x
371026

1x
302026

1x
4569407

4x
4653049

2x
416226

4x
346026

1x
6135412

3x
303426

6x
6047501

42x
4167842

6x
4569297

4x
6138232

16x
4620077

32x
6139519

19x
6142245

4x
6124349

1x
6138781

4x
4211412

2x
4211525

14x
4211415

5x
4211511

4x
4594238

3x
4211791

4x
4657459

2x
4211512

10x
6066097

5x
4211414

1x
6126082

2x
6065824

6x
4211429

2x
6116608

8x
4211356

2x
4211445

1x
6015347

16x
4560183

2x
6081975

1x
4211452

4x
4211481

4x
4211425

1x
4529240

12x
4558955

1x
4212352

2x
4210782

2x
4211042

2x
6115080

6x
6000606

5x
6121350

4x
4625146

4x
6046903

1x
4654448

2x
6001494

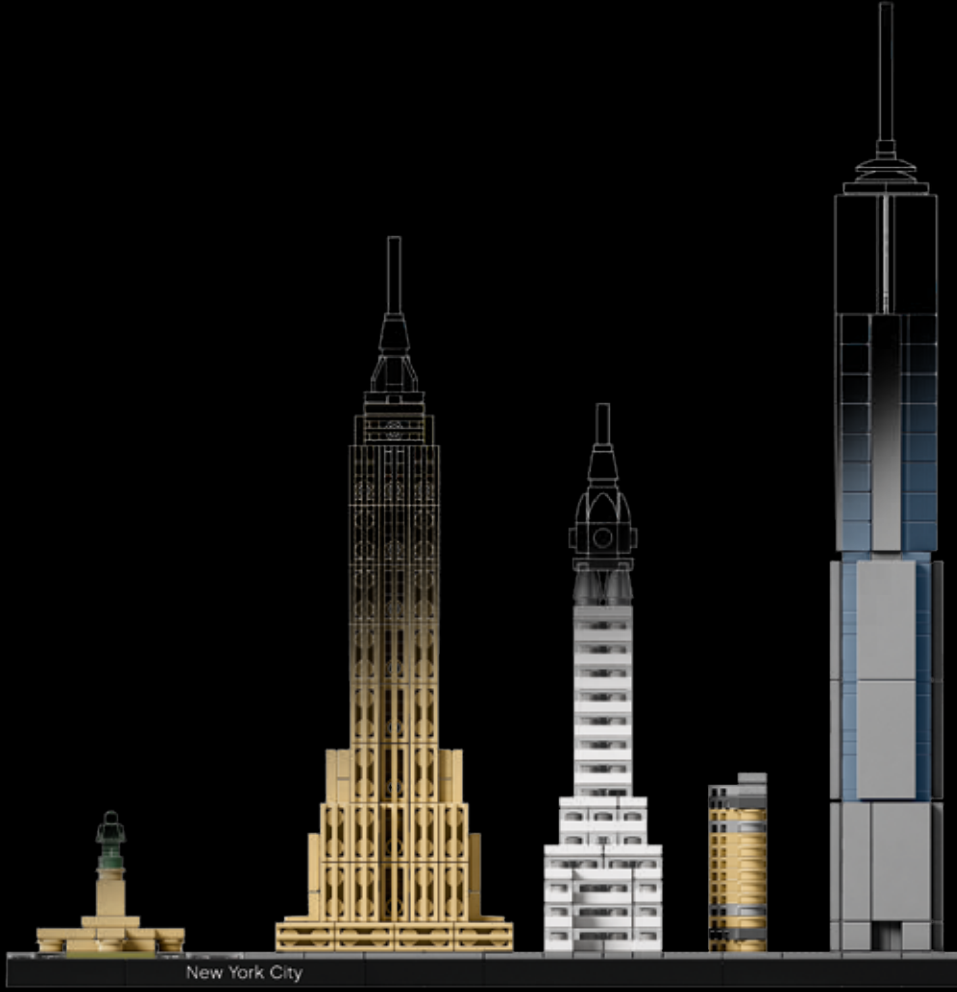

LEGO and the LEGO logo are trademarks of the/son't des marques de commerce du/son marcas registradas de LEGO Group. ©2016 The LEGO Group. 6172682

One World Trade Center building design is a copyright of WTC Tower 1 LLC. Used under license. The Empire State Building Image® is a registered trademark of ESRT Empire State Building, L.L.C. and is used with permission.

Le design du bâtiment One World Trade Center est un copyright de WTC Tower 1 LLC. Utilisé sous licence. L'image de l'Empire State Building® est une marque déposée d'ESRT Empire State Building, L.L.C. et est utilisée avec autorisation.

Los derechos de autor sobre el diseño del edificio del edificio One World Trade Center pertenecen a WTC Tower 1 LLC. Su uso en esta publicación tiene lugar con autorización. La imagen del edificio Empire State Building® es una marca comercial registrada de ESRT Empire State Building, L.L.C. cuyo uso en esta publicación tiene lugar con permiso.

