



Architecture

21041

Great Wall of China

China

La Grande Muraille de Chine

La Chine

Gran Muralla China

China



[LEGO.com/architecture/booklet](https://www.LEGO.com/architecture/booklet)





*“There in the mist, enormous,
majestic, silent and terrible,
stood the Great Wall of China.”*

W. Somerset Maugham

The Great Wall

For over 2000 years the Great Wall has wound its formidable way across the hills and mountains of the Chinese countryside. Its construction helped unify a new empire and strengthened the idea of China as a single nation. As an enduring symbol of China's national pride, the wall remains one of the most impressive feats in the history of architecture.



Many people imagine the Great Wall to be one long uninterrupted structure. In reality it is more a 13,000 miles (21,000 km) network of walls that reflect the rise and fall of numerous kingdoms and dynasties. As such the story of the Great Wall is also the story of China as the nation we recognize today.

In the 3rd Century B.C., Emperor Qin Shi Huang conquered his six neighboring kingdoms, establishing the Qin Dynasty and becoming the first Emperor of China. As well as linking together the many defensive walls the smaller kingdoms had built, he ordered the building of a new northern wall to protect his new empire from marauding tribes.

The following dynasties extended the wall further, but it was during the Ming Dynasty that much of the wall that we recognize today was constructed. In a period that stretched over 100 years, over 5,500 miles (8,850 km) of wall was added. Unlike the first walls that had often been built using compacted earth or wood, these latest sections were made of carved stone or brick. Forts, flanking towers and ramparts were added to create a formidable defensive line.

The end of the Ming Dynasty in 1644 also signaled the end of any construction or maintenance of the Great Wall. This would continue until sections of the wall were restored and opened to the public by the government of the People's Republic of China in the 1950s.

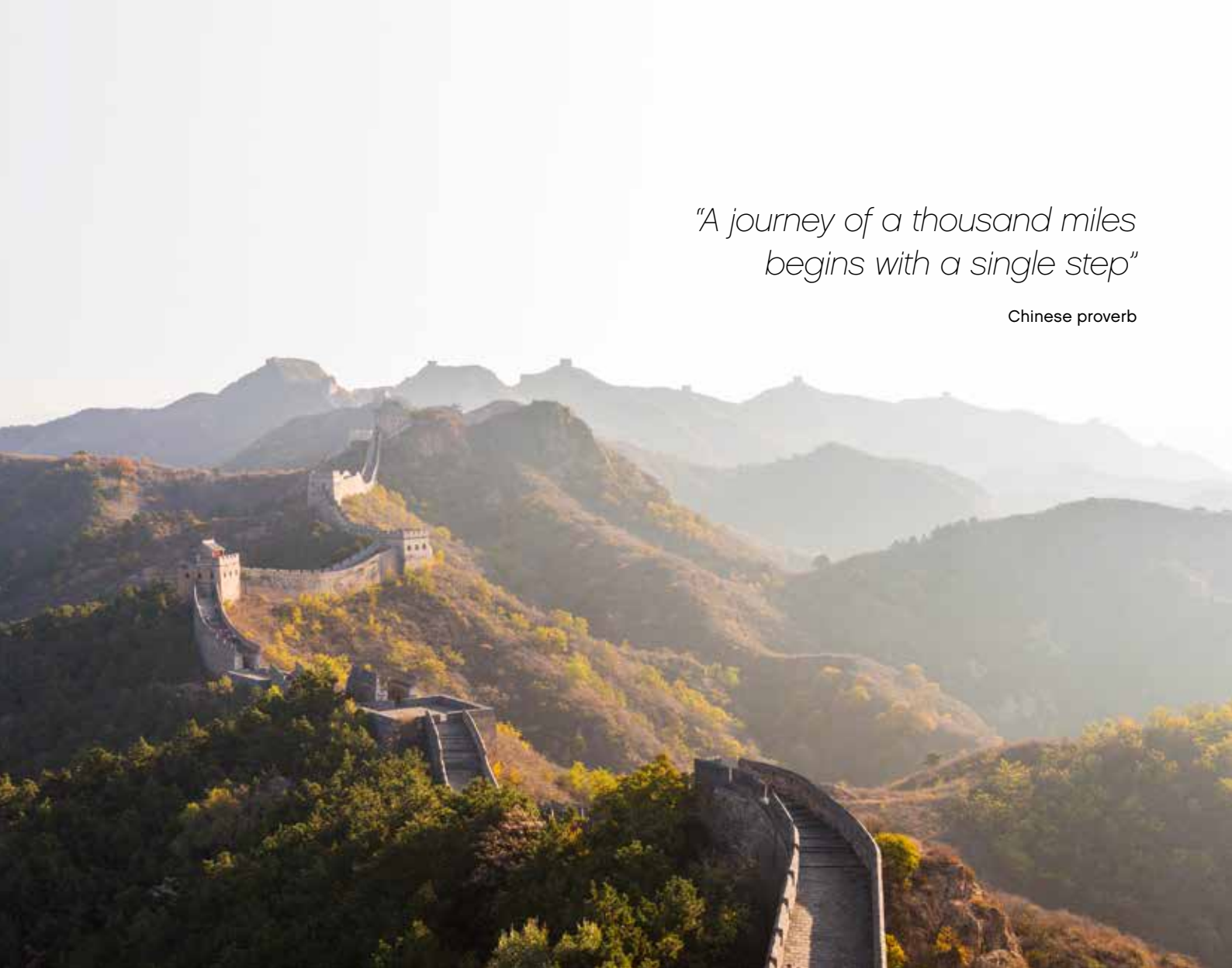
A scenic view of the Great Wall of China winding across rolling hills and mountains under a clear sky. The wall is the central focus, curving through the landscape. The hills are covered in green and yellow foliage, suggesting an autumn setting. The sky is a pale, clear blue.

*"A journey of a thousand miles
begins with a single step"*

Chinese proverb

From then to now

It took several different Dynasties and over 2000 years to create the Great Wall we recognize today.

770 - 476 BC

The Spring & Autumn Period

Seven warring kingdoms built the first walls to protect their borders.

221 - 206 BC

The Qin Dynasty

Qin Shi Huang becomes the first Emperor of China and builds a northern wall to defend his new empire from Mongol harassment.

206 - 220 AD

The Han Dynasty

Extended the wall westward to protect the growing trade travelling via the Silk Road.

618 - 907 AD

The Tang Dynasty

Was one of the most prosperous and peaceful dynasties in Chinese history with little construction to the wall.



960 - 1279 AD

The Song Dynasty

Enlarged and improved the wall in an attempt to stop invasion by the Manchus and Mongols.

1271 - 1368 AD

The Yuan Dynasty

The wall fails to stop the Mongol invasion and China comes under the control of the Mongol Empire.

1368 - 1644 AD

The Ming Dynasty

The Chinese regain control of the country and set about systematically rebuilding and strengthening the Great Wall.

1644 - Present

Post-Ming

The Manchus breach the wall and end the last Chinese dynasty. The wall falls into disrepair.



*“Until you reach the Great Wall,
you are no hero”*

Chairman Mao

While foreign travelers have always marveled at the Great Wall, the Chinese themselves only started to appreciate the massive structure midway through the 20th century. This was partly due to the historical financial and human costs of building the wall: heavy taxes had been imposed to pay for it and it's estimated that hundreds of thousands of soldiers, laborers and convicts died during its construction. But also because it had failed to stop the invasions it was built to hinder.

Today the wall plays a major part in the Chinese national identity, and the restored sections, especially around Badaling, have become a major tourist destination with over 10 million visitors each year. The wall was made a UNESCO World Heritage Site in 1987, and has long been regarded as one of the seven modern wonders of the world.







*"He who has never been to the
Great Wall is not a true man."*

Chinese poem

Many myths and legends have emerged about the Great Wall. Unfortunately, the most famous one, that it is the only man-made structure on earth that can be seen with the naked eye from outer space, is untrue. At best, the wall can be spotted during a low orbit, but even then only if sunlight and weather permits it.







« La Grande Muraille de Chine s'élevait dans la brume, majestueuse, énorme, silencieuse et terrifiante. »

W. Somerset Maugham

La Grande Muraille

Depuis plus de 2 000 ans, la Grande Muraille dresse son imposante silhouette parmi les collines et les montagnes de la campagne chinoise. Sa construction a contribué à unifier un nouvel empire et a renforcé l'idée d'une nation unique. En tant que symbole impérissable de la fierté chinoise, la muraille demeure l'un des chefs-d'œuvre les plus impressionnants de l'histoire de l'architecture.



De nombreuses personnes pensent que la Grande Muraille est composée d'une seule longue structure ininterrompue. En réalité, il s'agit plutôt d'un réseau de fortifications s'étendant sur près de 21 000 km, reflétant la montée et la chute de nombreux royaumes et dynasties. De ce fait, l'histoire de la Grande Muraille est aussi celle de la Chine alors qu'elle devient la nation que l'on connaît aujourd'hui.

Au III^e siècle av. J.-C., l'empereur Qin Shi Huang conquiert six royaumes avoisinant le sien, fondant ainsi la dynastie Qin et devenant le premier empereur chinois. En plus de relier les nombreux remparts érigés par les petits royaumes, il ordonne la construction d'un nouveau mur à la frontière nord afin de protéger son empire des tribus nomades.

Les dynasties suivantes agrandissent le mur, mais ce n'est que sous la dynastie Ming que la majeure partie de la muraille que nous connaissons aujourd'hui est construite. Au cours d'une période de plus de 100 ans, les fortifications sont prolongées sur plus de 8 850 km. Contrairement aux premiers murs, souvent faits de terre compressée ou de bois, les nouvelles sections sont construites en pierres taillées ou en briques. Des forts, tours fortifiées et remparts sont ajoutés pour créer une imposante ligne de défense.

La fin de la dynastie Ming en 1644 signale la fin des travaux de construction et d'entretien de la Grande Muraille. Il en sera ainsi jusqu'à ce que certaines sections des fortifications soient restaurées et ouvertes au public par le gouvernement de la République populaire de Chine dans les années 1950.

*« Un voyage de mille lieues
commence toujours par un premier pas. »*

Proverbe chinois



D'hier à aujourd'hui

L'édification de la Grande Muraille telle qu'on la connaît aujourd'hui s'est étendue sur plus de 2 000 ans, sous le règne de différentes dynasties.

770 à 476 av. J.-C.

Période des Printemps et Automnes

Sept royaumes en guerre construisent les premières fortifications pour protéger leurs frontières.

221 à 206 av. J.-C.

Dynastie Qin

Qin Shi Huang devient le premier empereur chinois et construit un mur dans le nord de son royaume afin de le protéger des invasions mongoles.

206 à 220

Dynastie Han

Le mur s'agrandit vers l'ouest pour protéger le nombre croissant de marchandises transitant par la route de la soie.

618 à 907

Dynastie Tang

Il s'agit de l'une des dynasties les plus prospères et pacifiques de l'histoire chinoise, qui contribua peu à l'édification de la muraille.



960 à 1279

Dynastie Song

Sous ce règne, la muraille est agrandie et renforcée, dans l'espoir d'empêcher les invasions des Mandchous et des Mongols.

1271 à 1368

Dynastie Yuan

Le mur ne parvient pas à arrêter l'invasion et la Chine passe sous le contrôle de l'empire mongol.

1368 à 1644

Dynastie Ming

Les Chinois reprennent le contrôle du pays et s'affairent à reconstruire et à renforcer la Grande Muraille.

1644 à nos jours

Après la dynastie Ming

Les Mandchous réussissent à percer une brèche dans la muraille et mettent fin au règne des Ming. Le mur commence à se détériorer.



« Celui qui n'a pas gravi la Grande Muraille n'est pas un homme brave. »

Mao Zedong

Même si les voyageurs étrangers s'émerveillent depuis toujours devant la Grande Muraille, les Chinois n'ont pour leur part commencé à admirer l'imposante structure qu'au milieu du XX^e siècle. Cela était en partie dû aux coûts qu'elle avait entraînés sur le plan financier et humain. De lourdes taxes avaient été imposées à la population pour financer le projet et l'on estime que des centaines de milliers de soldats, d'ouvriers et de prisonniers sont morts durant la construction. De plus, les fortifications avaient été érigées pour stopper les invasions, ce à quoi elles avaient failli.

De nos jours, la muraille occupe un rôle central dans l'identité nationale chinoise et les sections restaurées, particulièrement celle de Badaling, sont devenues des attractions touristiques majeures, attirant plus de 10 millions de visiteurs chaque année. La muraille a été inscrite au patrimoine mondial de l'UNESCO en 1987 et est depuis longtemps considérée comme l'une des sept nouvelles merveilles du monde.







*« L'on n'est point homme tant
que l'on n'a pas atteint la
Grande Muraille. »*

Poème chinois

De nombreux mythes et légendes entourent la Grande Muraille. Malheureusement, le mythe le plus célèbre voulant qu'il s'agisse de la seule structure construite par l'homme visible à l'œil nu depuis l'espace est inexact. Dans le meilleur des cas, elle peut être aperçue depuis une orbite basse, si la lumière du soleil et la météo le permettent.







“Allí, entre la niebla, enorme, majestuosa, silenciosa y terrible, se alzaba la Gran Muralla de China”.

W. Somerset Maugham

La Gran Muralla

La Gran Muralla se abre paso imponente por las colinas y montañas de la China rural desde hace más de 2000 años. Su construcción contribuyó a unificar un nuevo imperio y fortaleció el concepto de China como nación. Símbolo constante de China y orgullo nacional, la muralla sigue siendo una de las obras arquitectónicas más impresionantes de la historia de la arquitectura.



Mucha gente cree que la Gran Muralla es una sola estructura continua de enorme longitud. En realidad, es más una especie de red de murallas de unos 21.000 kilómetros que refleja el ascenso y la caída de numerosos reinos y dinastías. De este modo, la historia de la Gran Muralla es también la historia de la China que conocemos en la actualidad.

En el siglo III a. C., el emperador Qin Shi Huang conquistó los seis reinos que colindaban con el suyo, creando la dinastía Qin y convirtiéndose en el primer emperador de China. Además de unir las muchas murallas defensivas que los reinos menores habían construido, ordenó la construcción de una nueva muralla en el norte para proteger su nuevo imperio de las tribus que lo acosaban.

Las dinastías que le sucedieron ampliaron aún más la muralla, pero fue durante la dinastía Ming que se construyó gran parte de la muralla tal y como es hoy. Durante un período de más de 100 años, se agregaron más de 8.850 kilómetros de muralla. A diferencia de las primeras murallas, la mayoría de ellas construidas a partir de tierra compactada o madera, estas últimas secciones estaban edificadas en piedra tallada o ladrillo. Además, se agregaron fuertes, torres defensivas y baluartes para crear una infranqueable línea defensiva.

El fin de la dinastía Ming en 1644 trajo consigo el abandono de las ampliaciones y el mantenimiento de la Gran Muralla. La situación perduraría hasta que se restauraron algunas secciones y el gobierno de la República Popular China volvió a abrir la muralla al público en los años 50.

*“Un camino de mil millas
comienza con un solo paso”.*

Proverbio chino



Desde entonces hasta ahora

Fueron necesarias varias dinastías y más de 2000 años para crear la Gran Muralla que hoy conocemos.

770-476 a. C.

Período de Primavera y Otoño

Siete reinos en guerra construyeron las primeras murallas para proteger sus fronteras.

221-206 a. C.

La dinastía Qin

Qin Shi Huang se convierte en el primer emperador de China y construye una muralla en el norte para defender su nuevo imperio del acecho mongol.

206-220 d. C.

La dinastía Han

Amplió la muralla hacia el oeste para proteger el comercio que recorría la Ruta de la Seda.

618-907 d. C.

La dinastía Tang

Fue una de las dinastías más prósperas y pacíficas de la historia de China, por lo que apenas contribuyó a ampliar la muralla.



960-1279 d. C.

La dinastía Song

Amplió y mejoró la muralla, tratando de impedir así la invasión de los manchúes y mongoles.

1271-1368 d. C.

La dinastía Yuan

La muralla no detiene la invasión de los mongoles y China cae bajo el control del Imperio mongol.

1368-1644 d. C.

La dinastía Ming

China recupera el control del país y se propone reconstruir y fortalecer la Gran Muralla casi sistemáticamente.

De 1644 a la actualidad

Luego de la dinastía Ming

Los manchúes atraviesan la muralla y ponen fin a la dinastía Ming. La muralla se deteriora.



“No serás un héroe hasta que llegues a la Gran Muralla”.

Jefe Mao

Aunque los viajeros extranjeros siempre se han maravillado ante la Gran Muralla, los propios chinos no comenzaron a apreciar la enorme estructura hasta mediados del siglo XX. Esto se debió, en parte, al histórico costo financiero y humano de la construcción de la muralla: se impusieron altos impuestos para pagarla y se estima que murieron cientos de miles de soldados, trabajadores y convictos durante su edificación. Además, no logró detener las invasiones para cuya contención fue construida.

Hoy, la muralla interpreta un importante papel en la identidad nacional de China y las secciones restauradas (en particular las cercanas a Badaling) se han convertido en importantes destinos turísticos, recibiendo más de 10 millones de visitantes al año. La muralla fue declarada Patrimonio de la Humanidad por la UNESCO en 1987 y siempre ha sido considerada una de las siete maravillas del mundo.







*“No puede llamarse hombre
quien no ha estado nunca
en la Gran Muralla”.*

Poema chino

Numerosos mitos y leyendas han nacido alrededor de la Gran Muralla. Por desgracia, el más famoso, según el cual es la única estructura creada por el hombre en la Tierra que puede verse a simple vista desde el espacio exterior, es falso. En el mejor de los casos, es posible ver la muralla orbitando a baja altura, y sólo si la luz solar y el tiempo lo permiten.



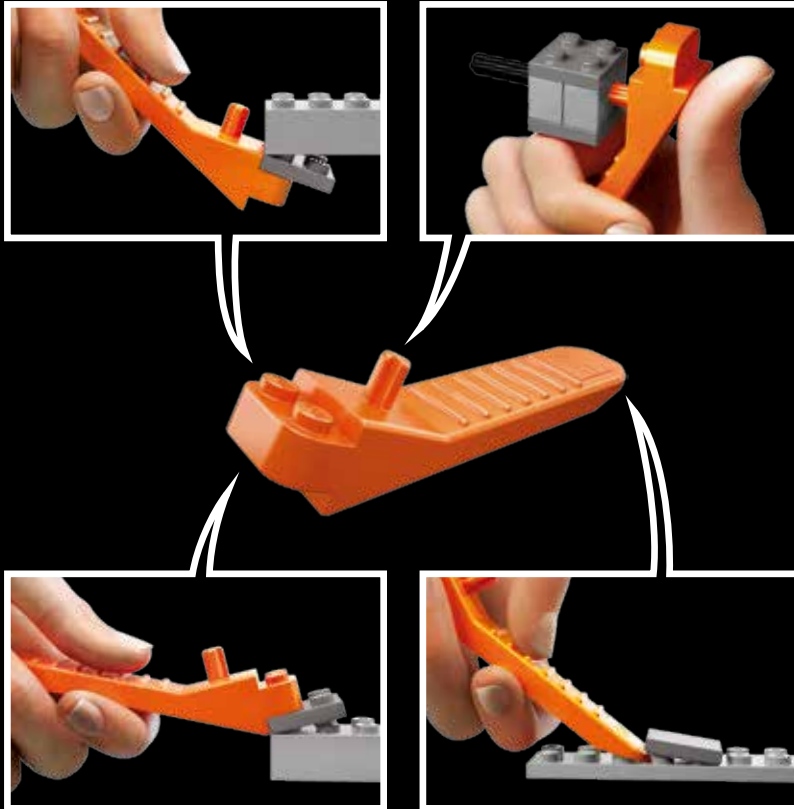

[LEGO.com/brickseparator](https://www.lego.com/brickseparator)

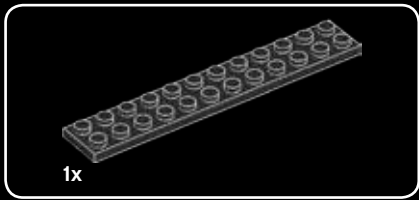

1

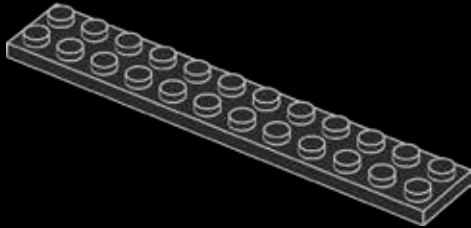

2

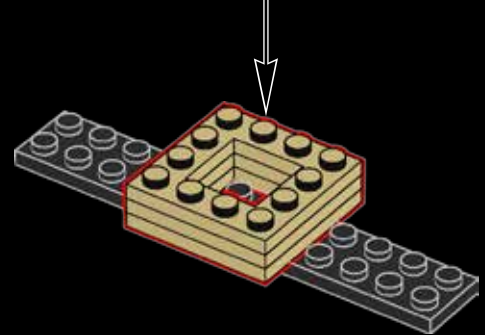
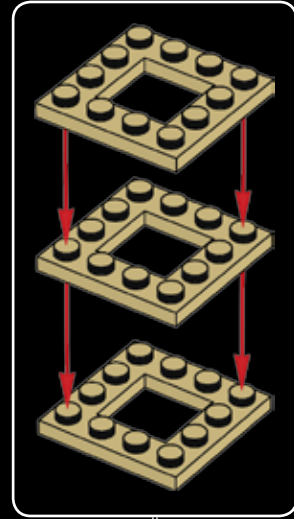

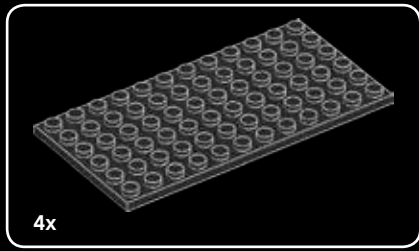

3

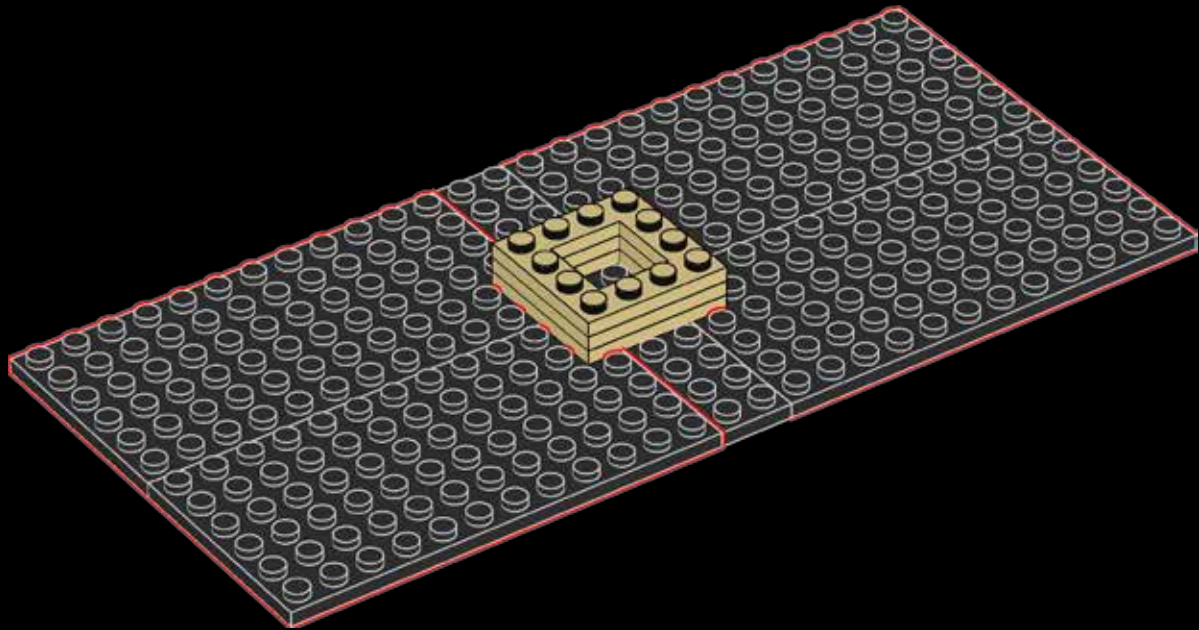

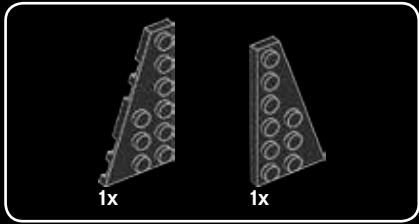

4

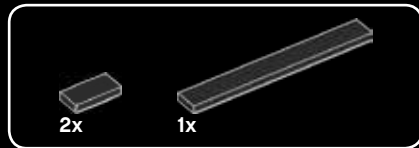
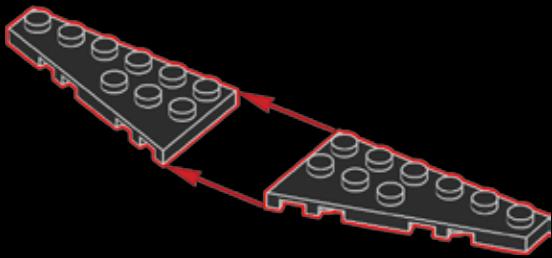

5

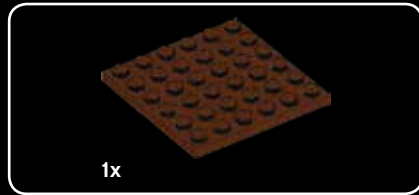
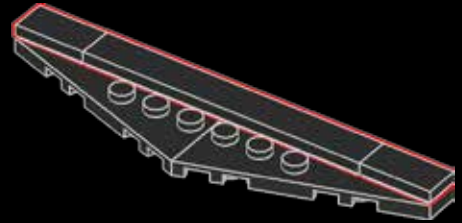

6

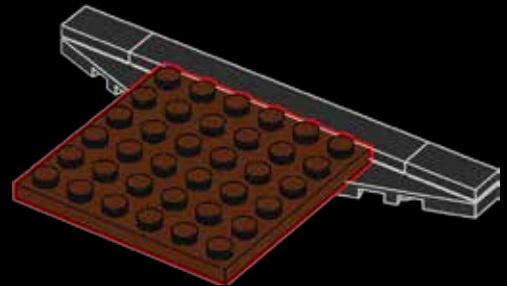

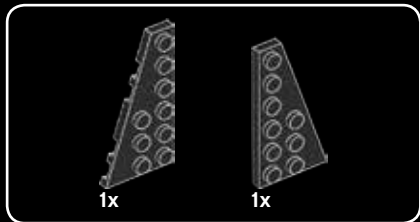

7

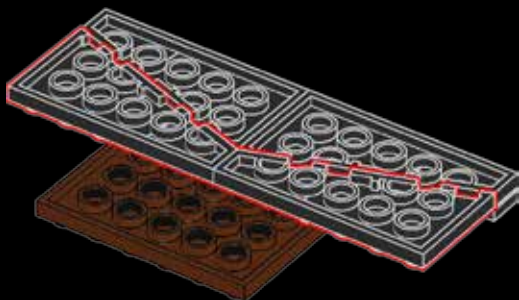

8

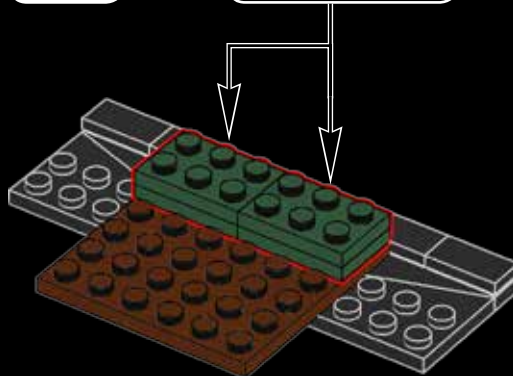
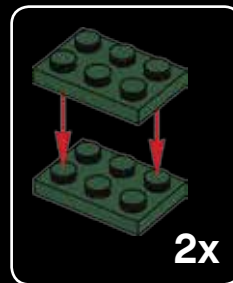

2x

The average width of the wall is 21.3 ft. (6.5 m)
La largeur moyenne de la muraille est de 6,5 m.
La anchura media de la muralla es de 6.5 m.



9

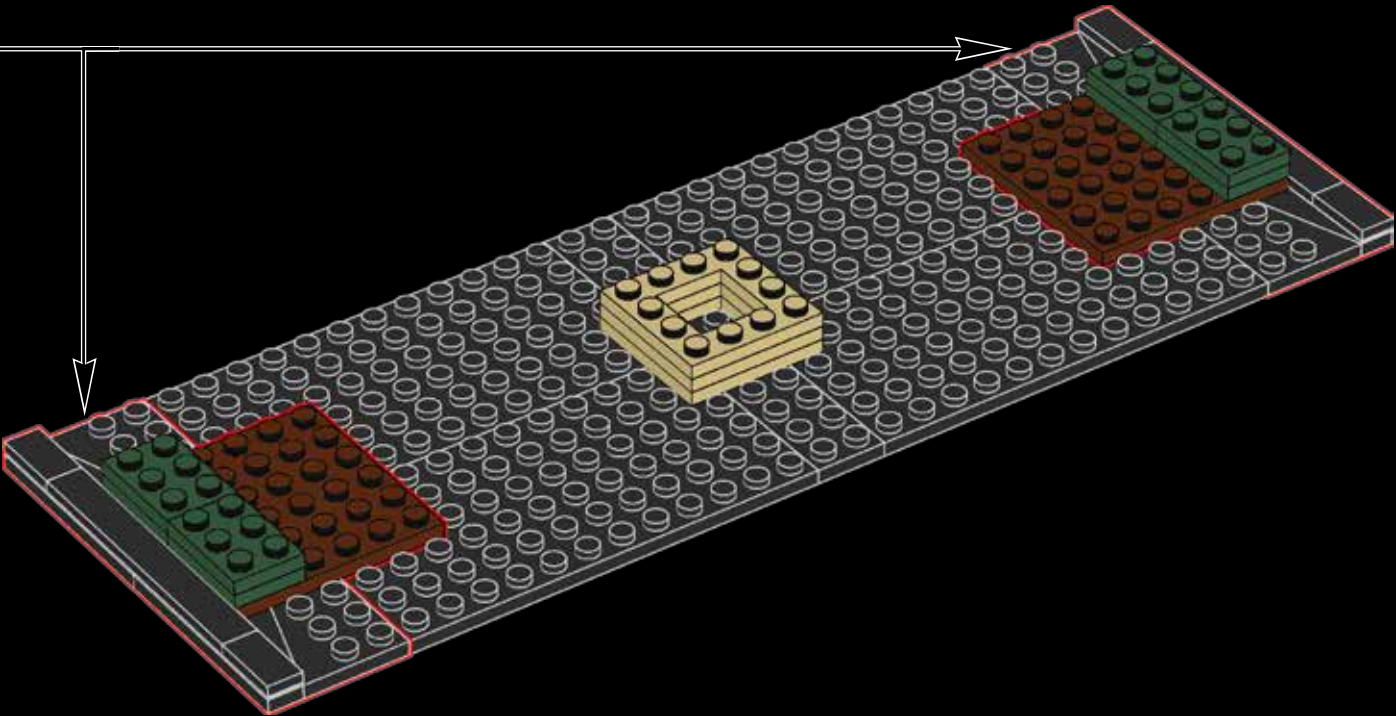

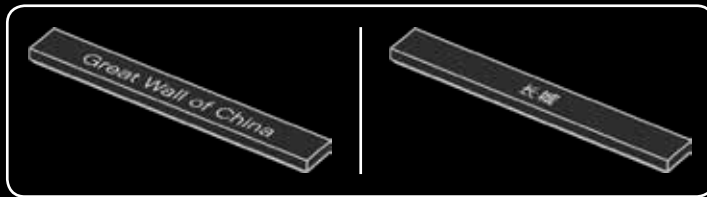
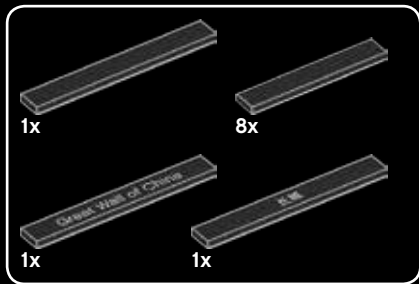

10

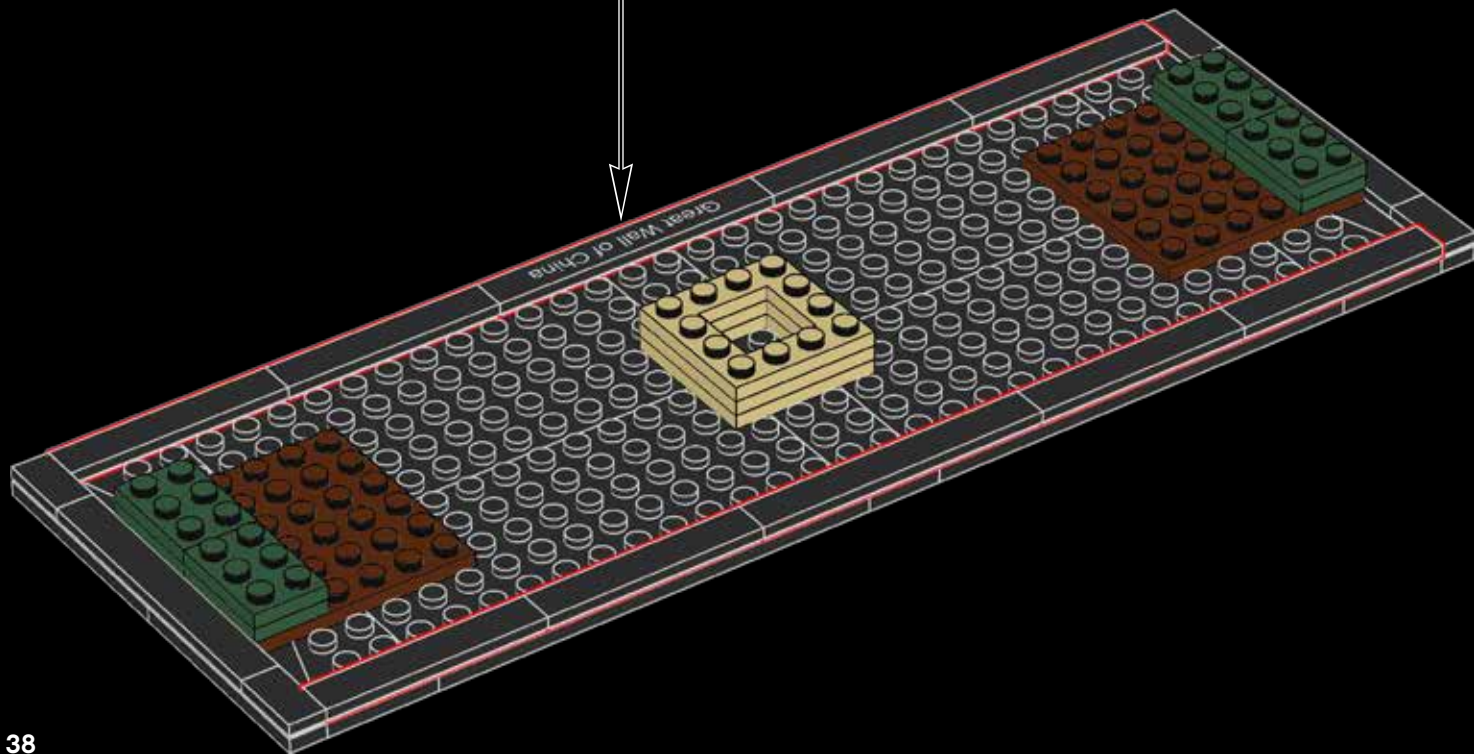

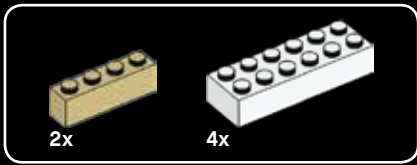

11

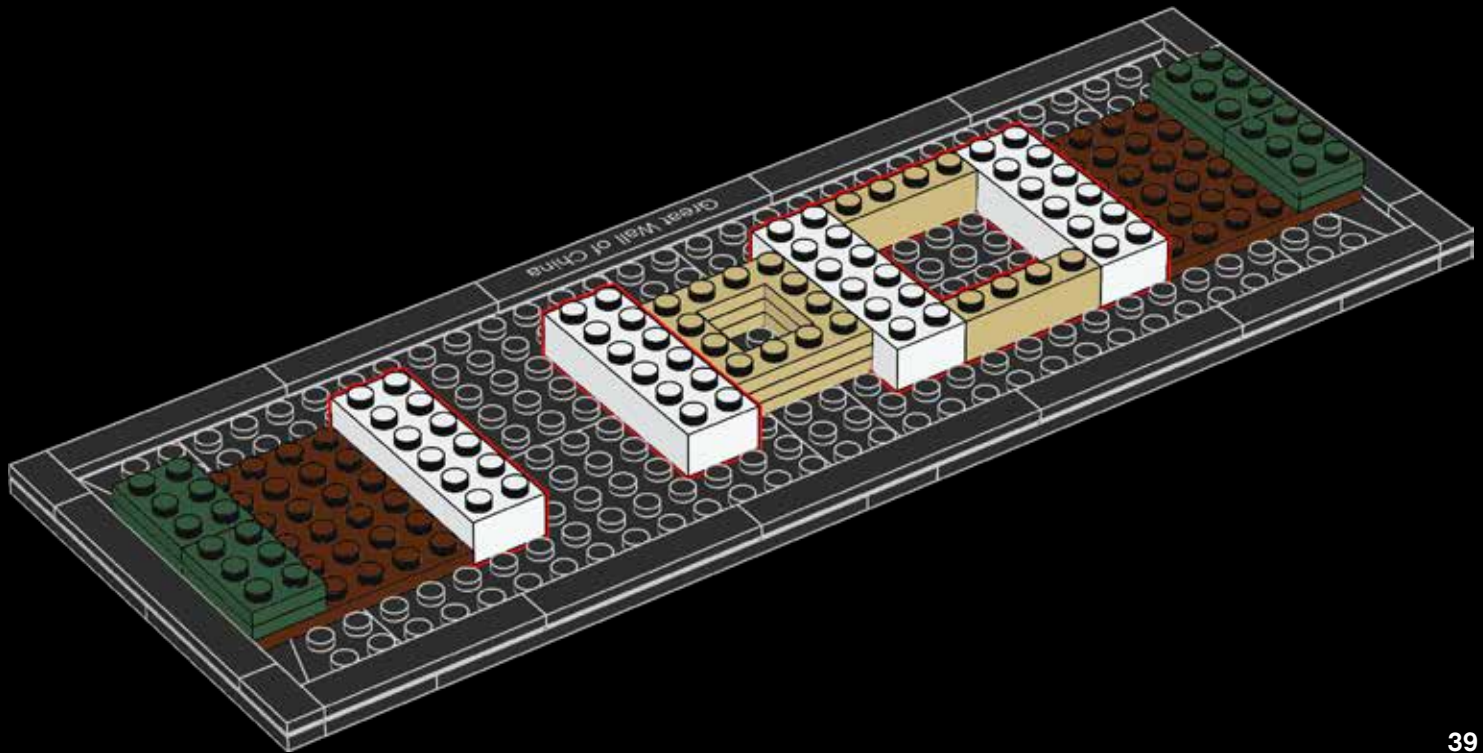



12

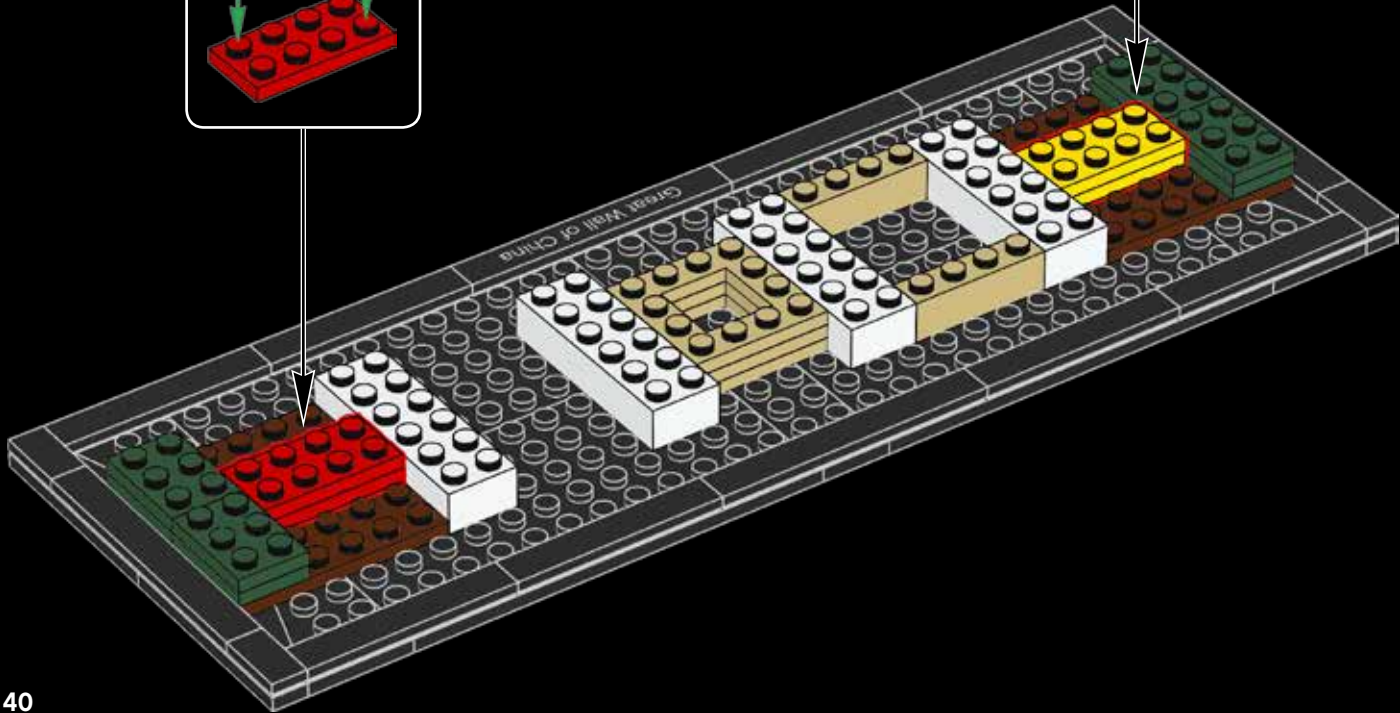
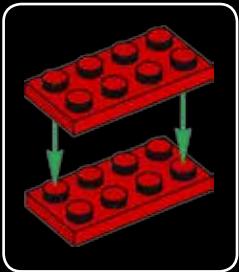
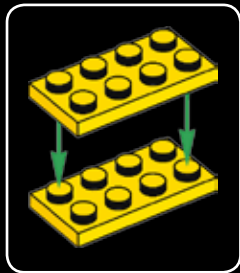

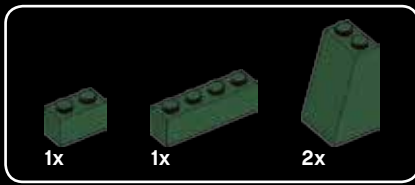

13

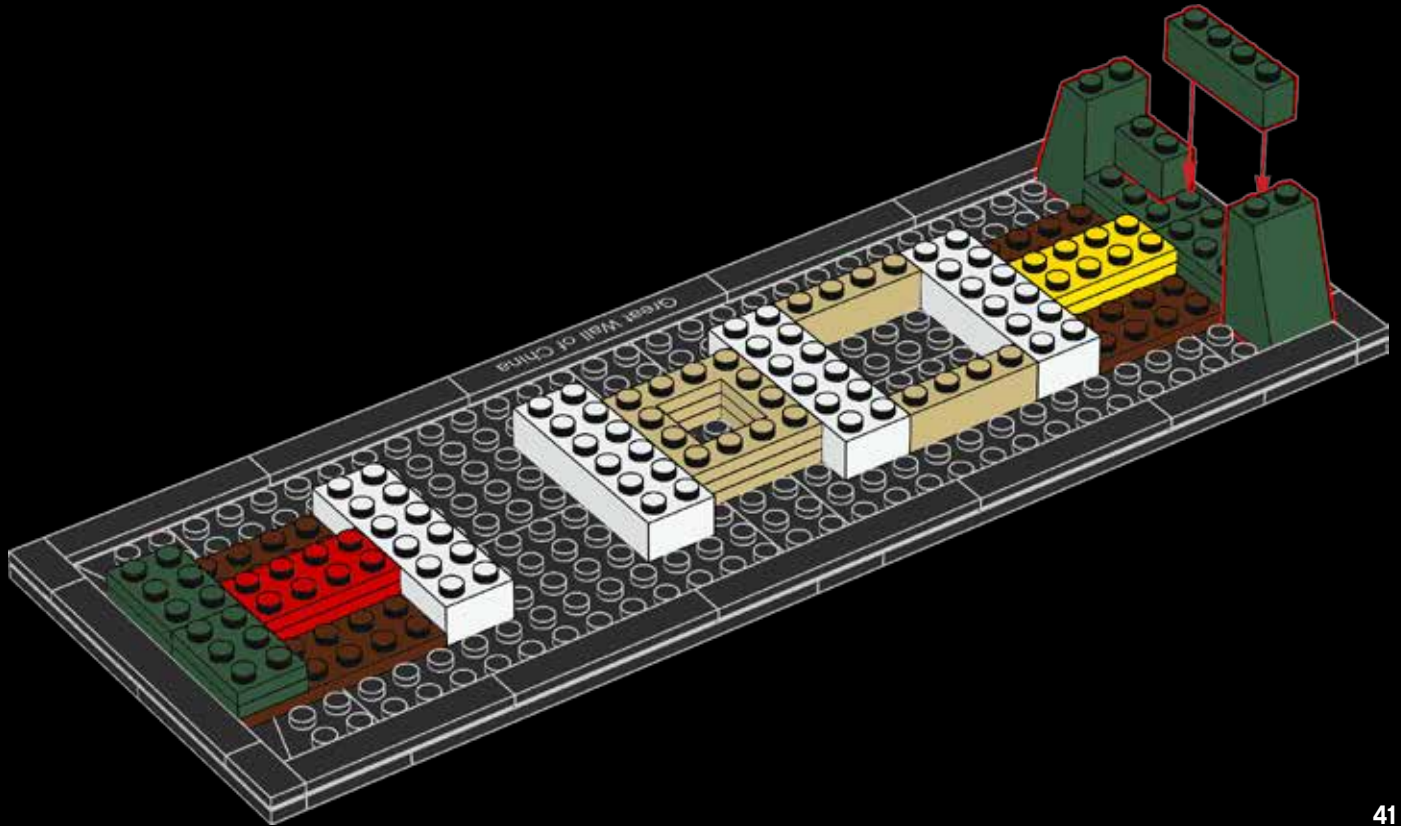



14

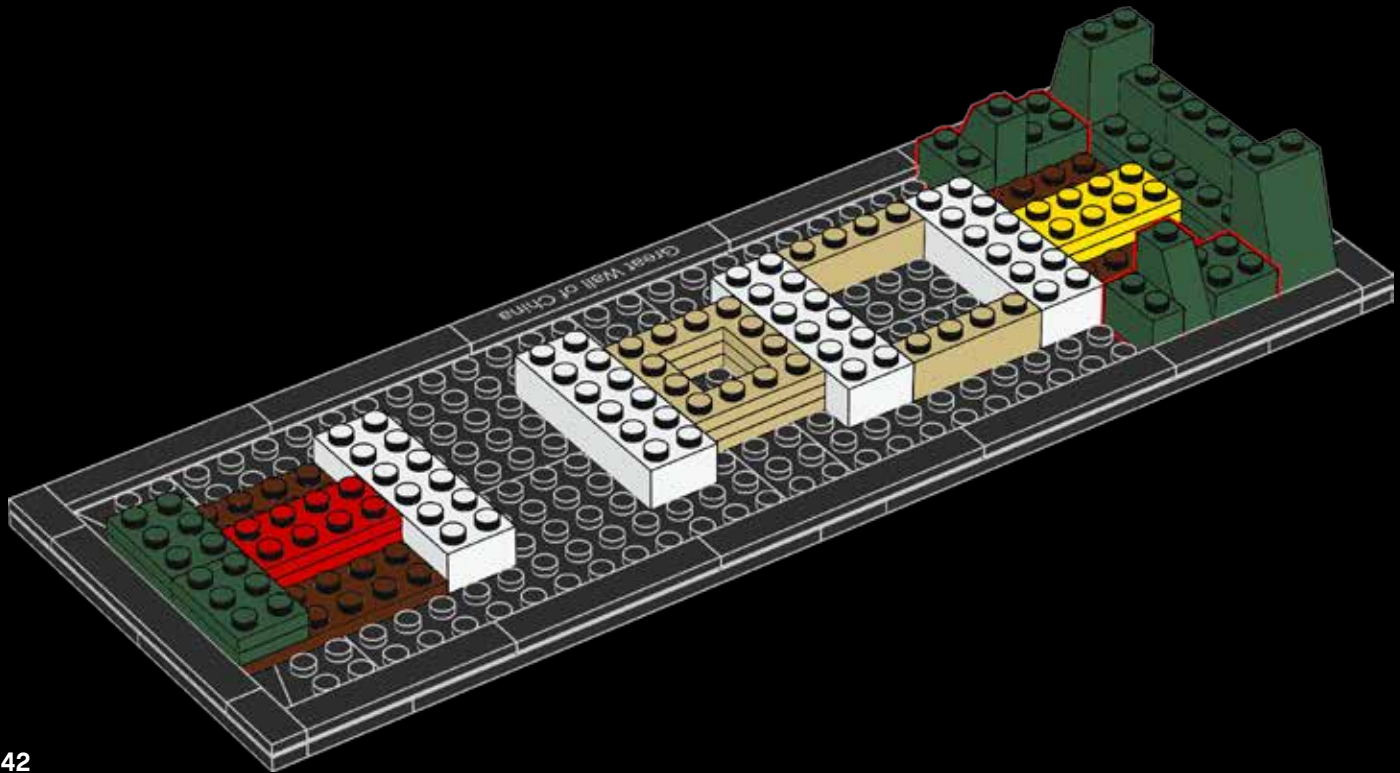

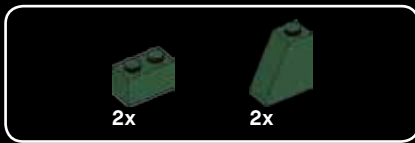

15

New sections of the wall continue to be discovered, especially around the border of present-day Mongolia.
On continue à découvrir de nouvelles sections de la muraille, particulièrement autour de la frontière avec l'actuelle Mongolie.
Todavía se siguen descubriendo secciones de la muralla, especialmente en la frontera con la actual Mongolia.

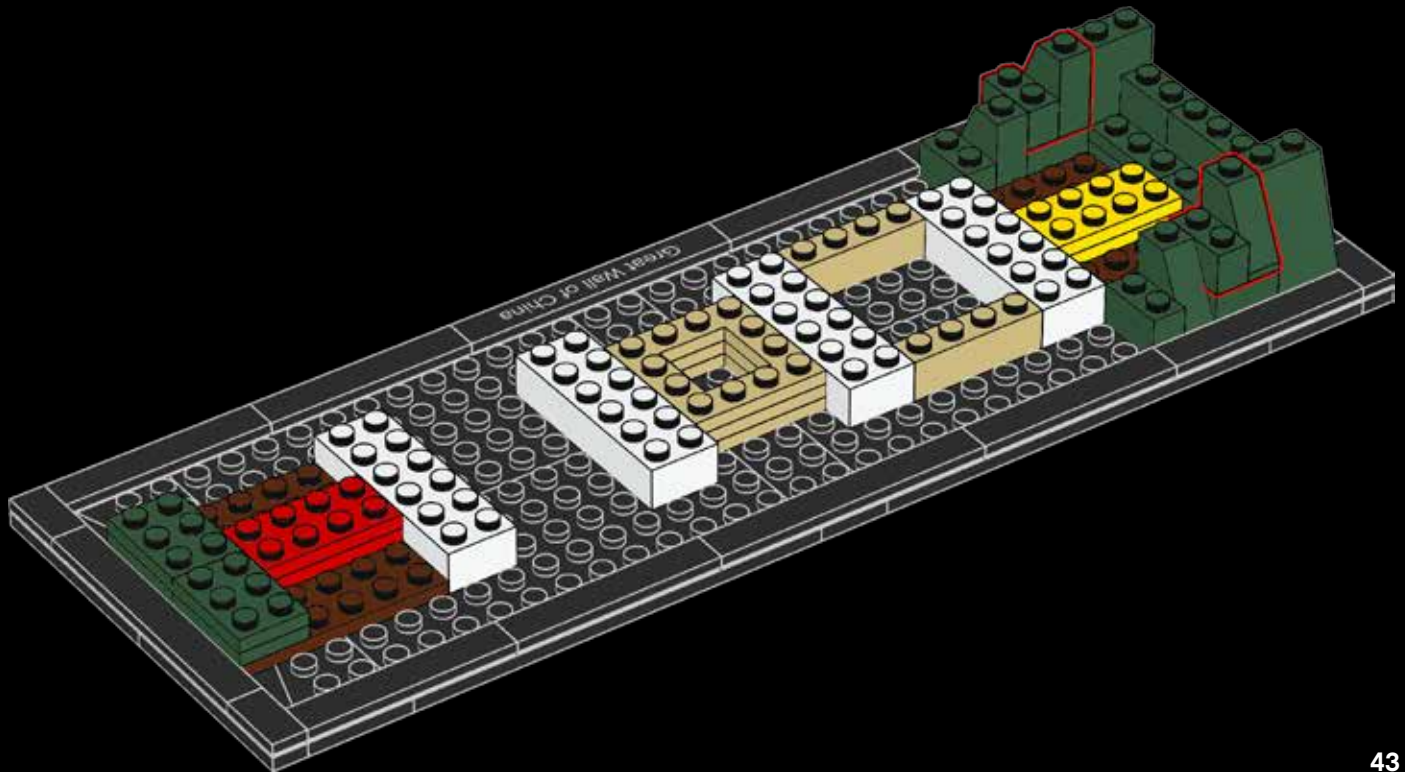



16

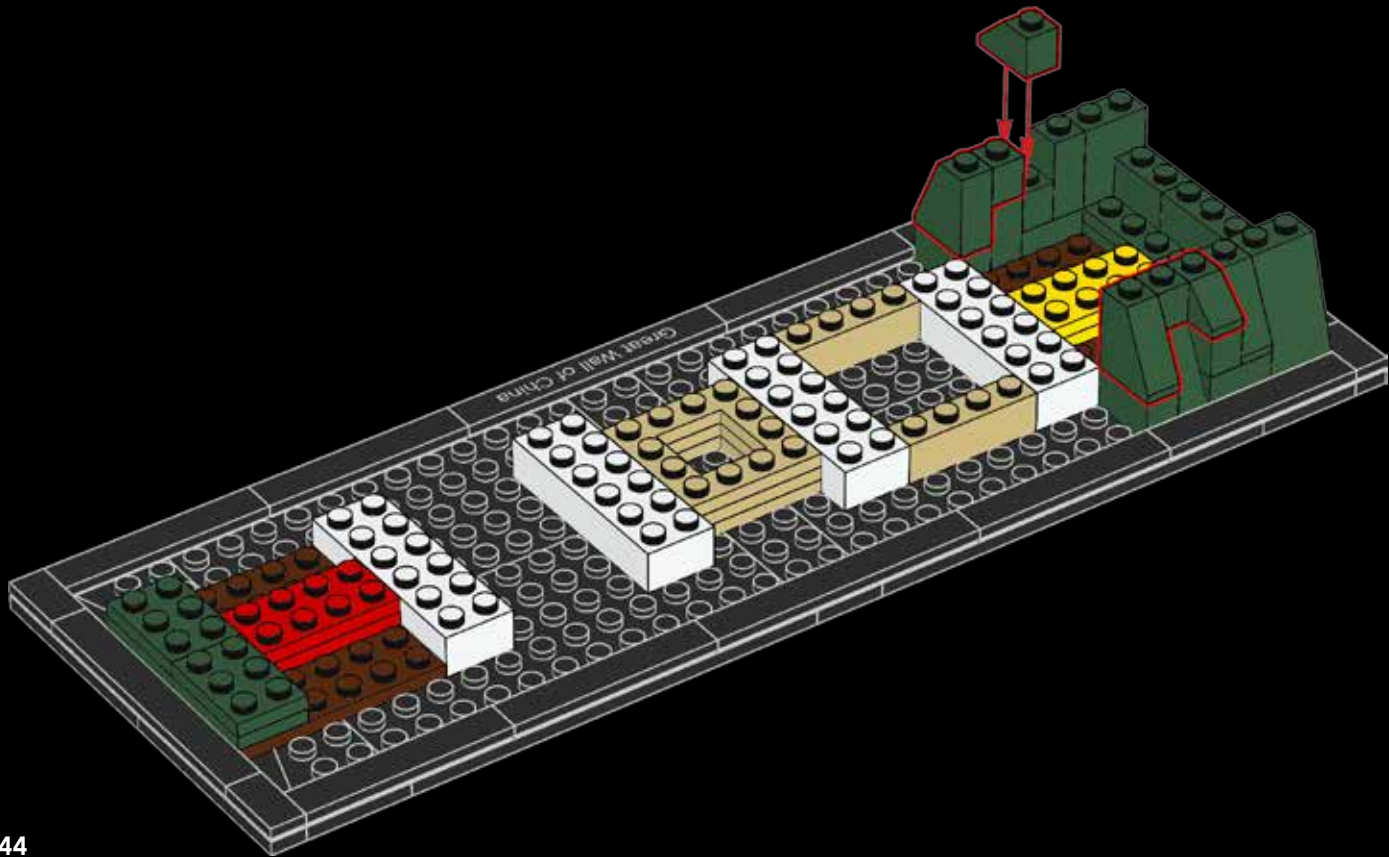



17

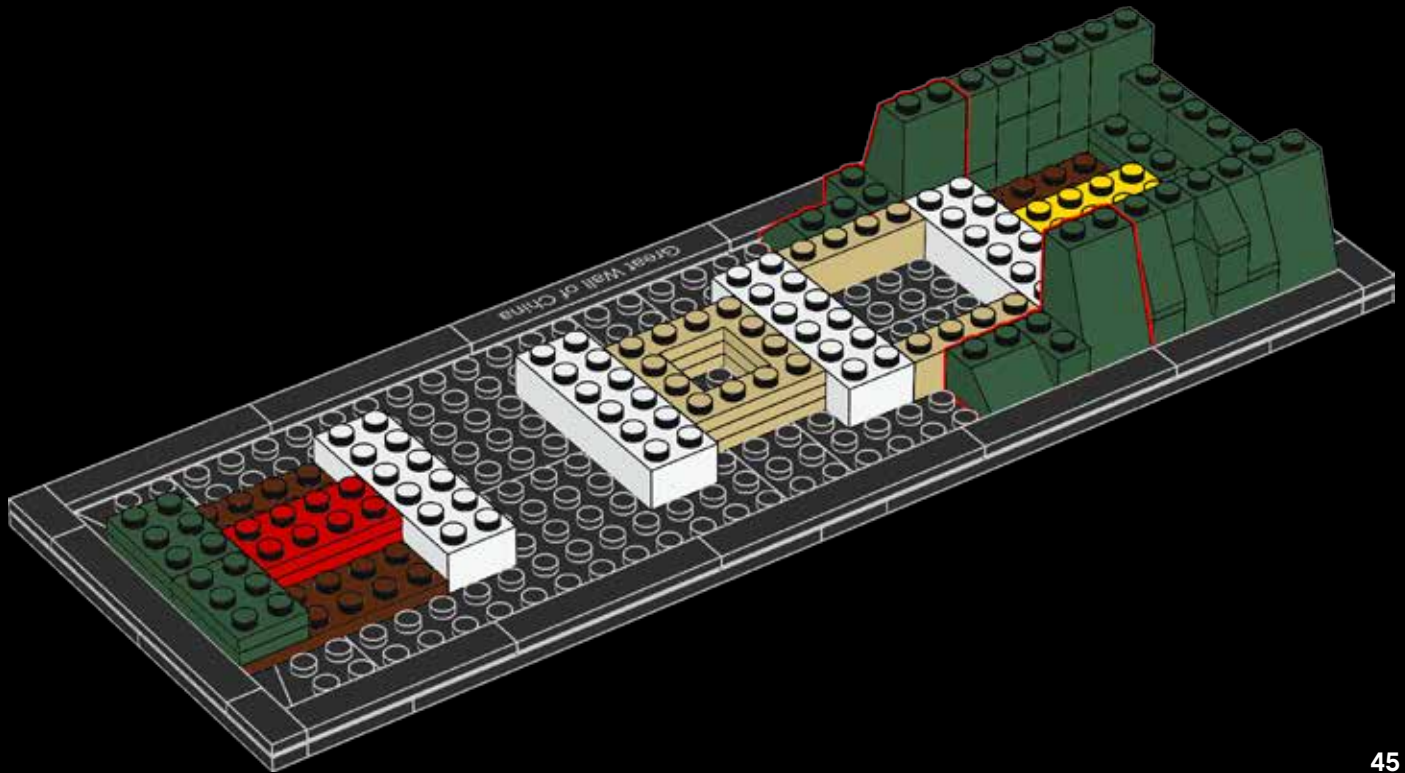

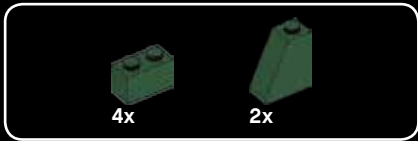

18

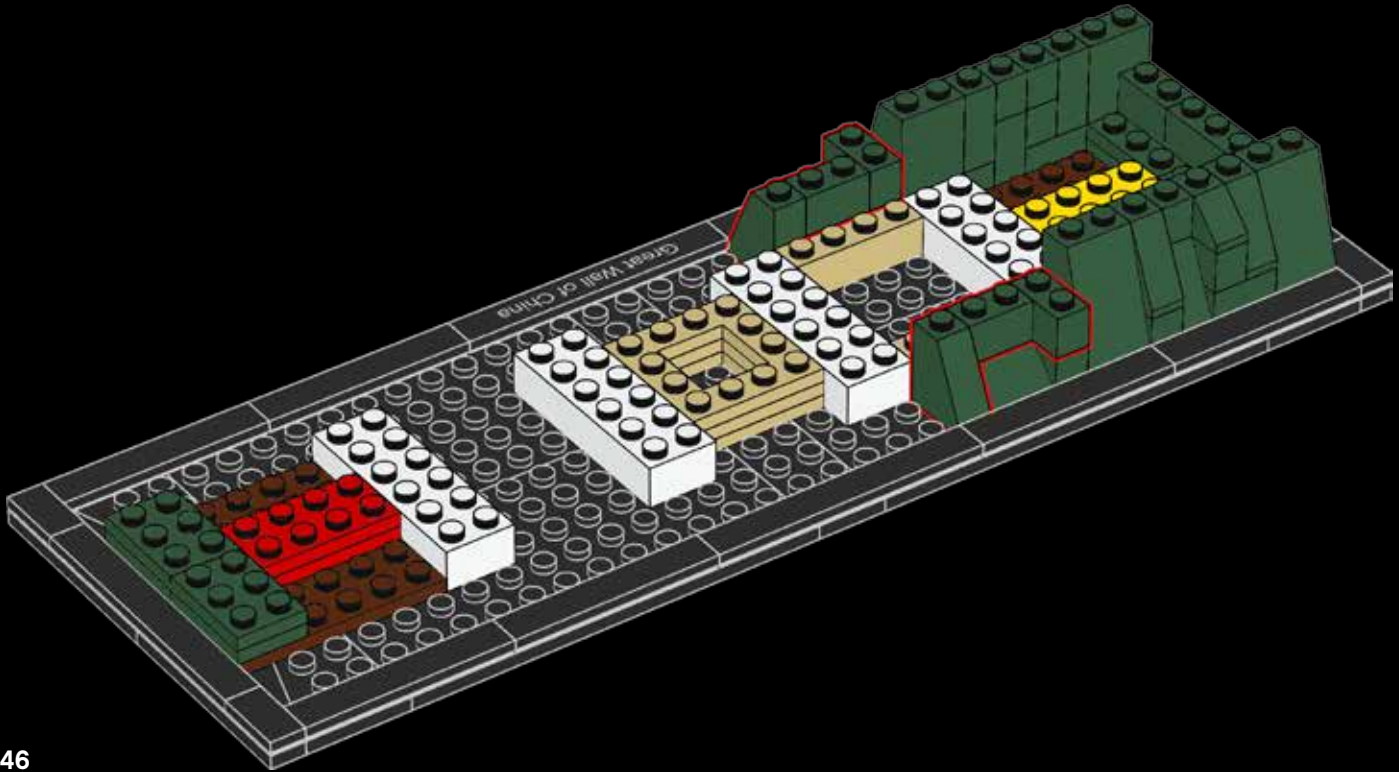

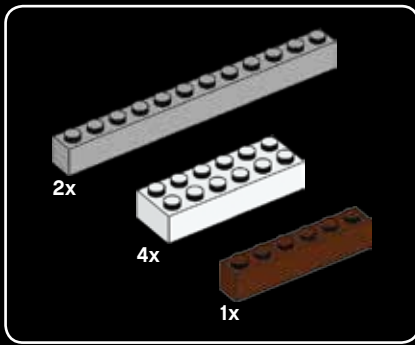

19

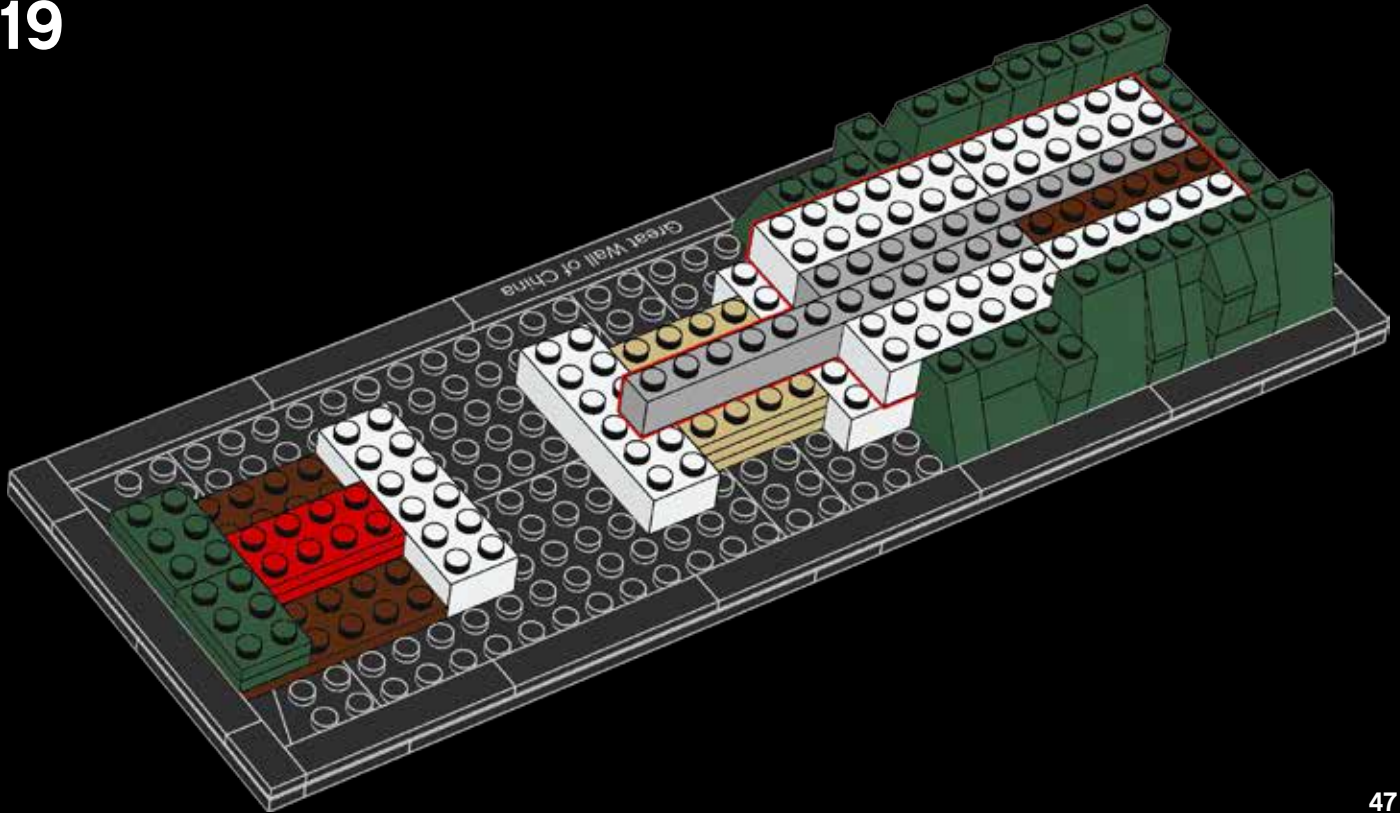



20

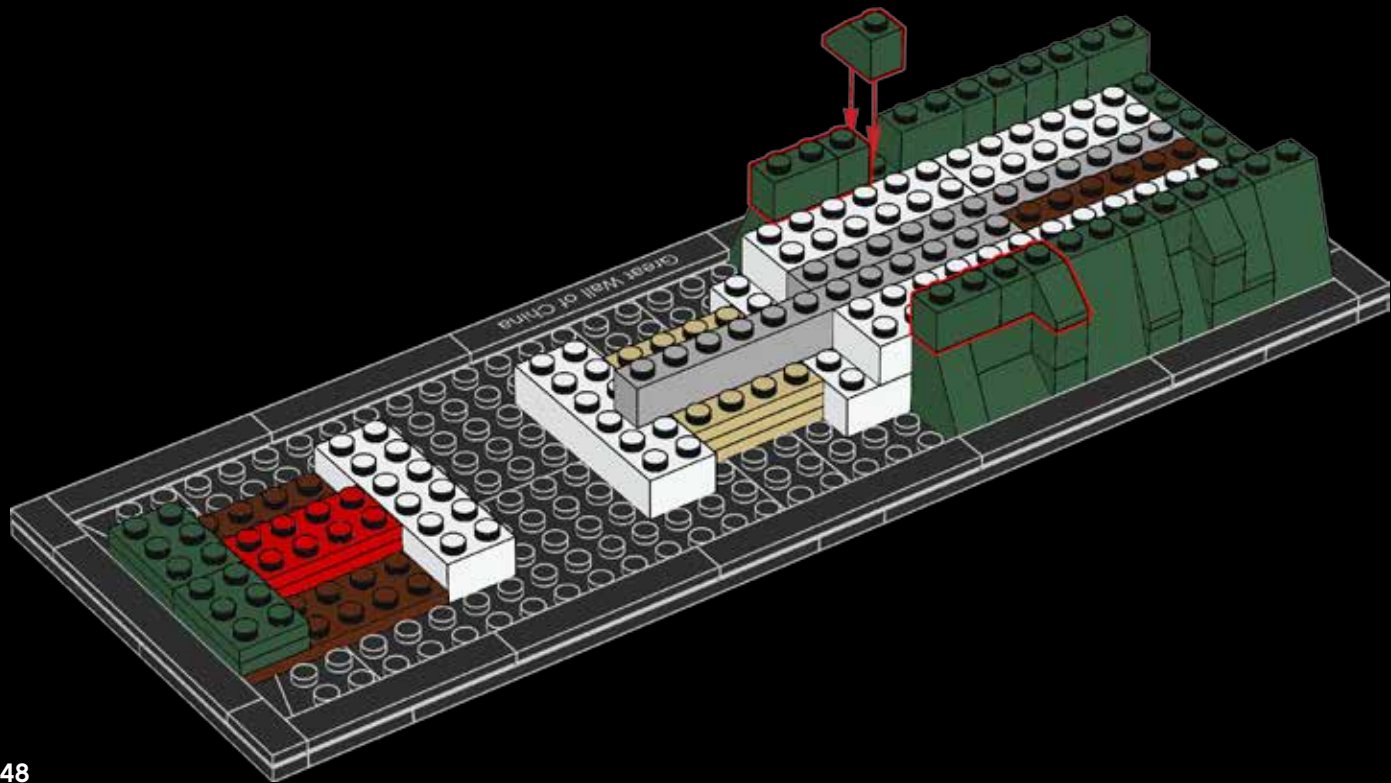



21

During the 1960s and 1970s miles of the wall were stripped of bricks to build civilian housing.
Dans les années 1960 et 1970, on retire des briques de la muraille sur plusieurs kilomètres afin de construire des logements civils.
Durante las décadas de 1960 y 1970, kilómetros de la muralla fueron despojados de ladrillos para construir viviendas civiles.

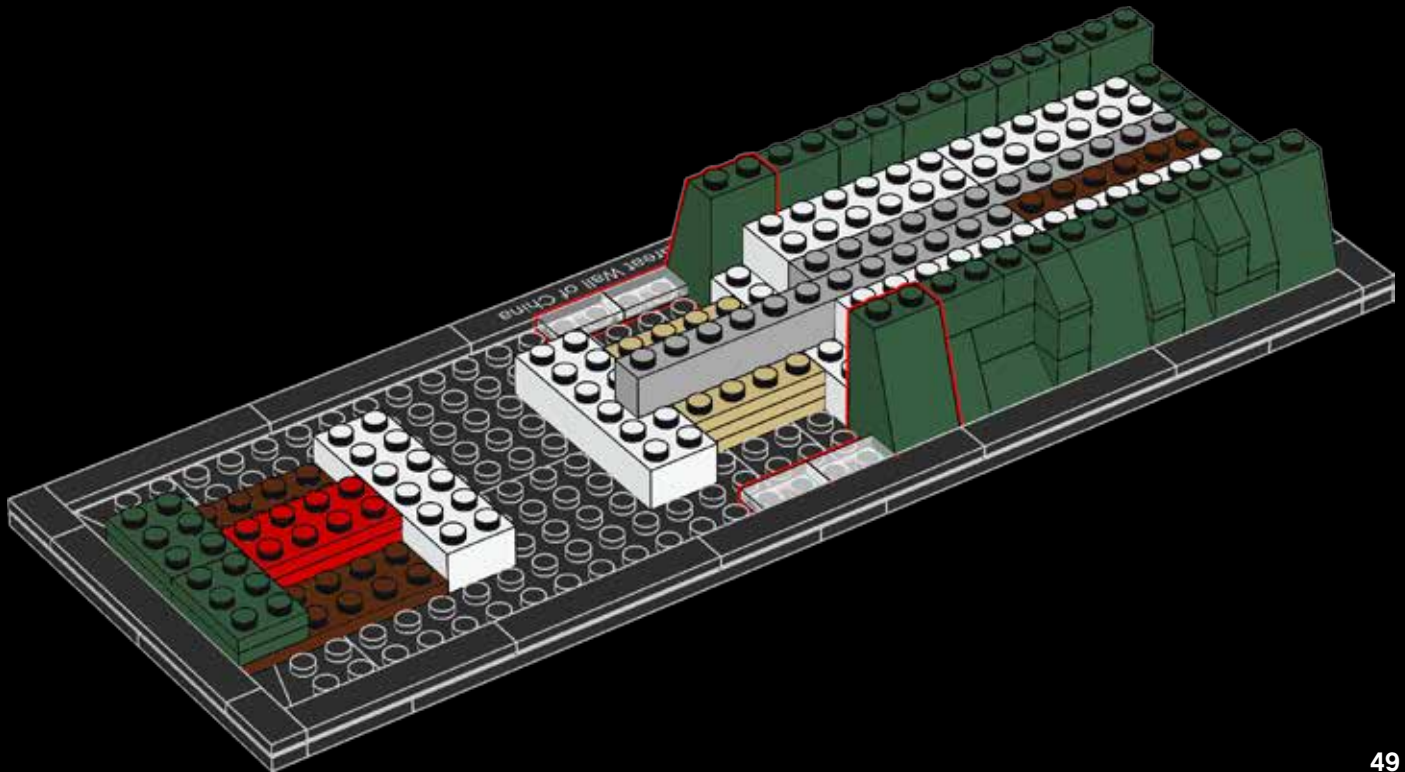

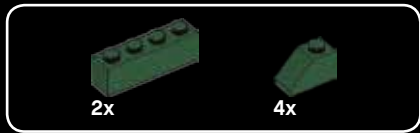

22

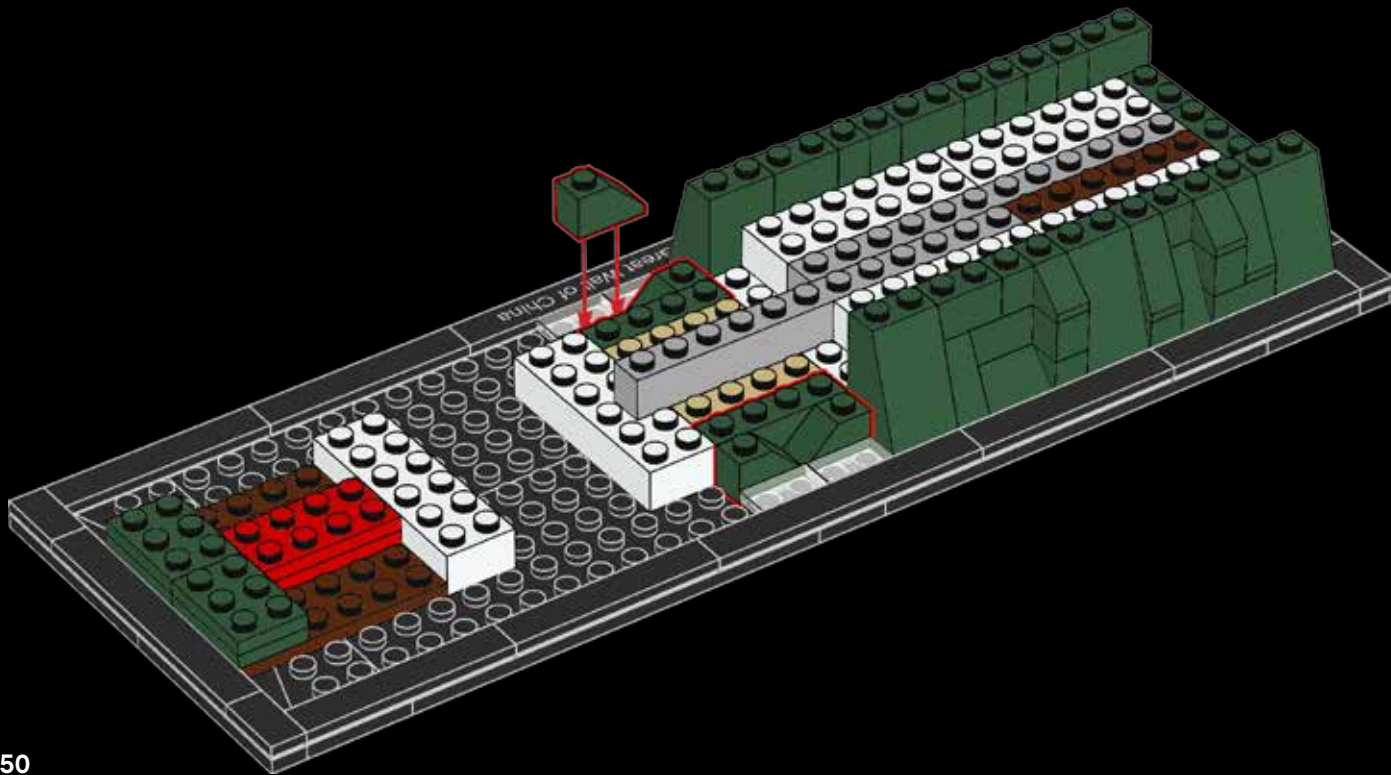

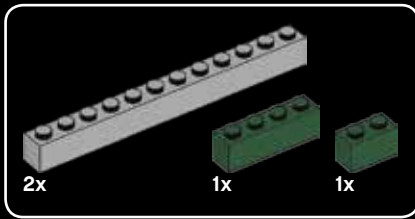

23

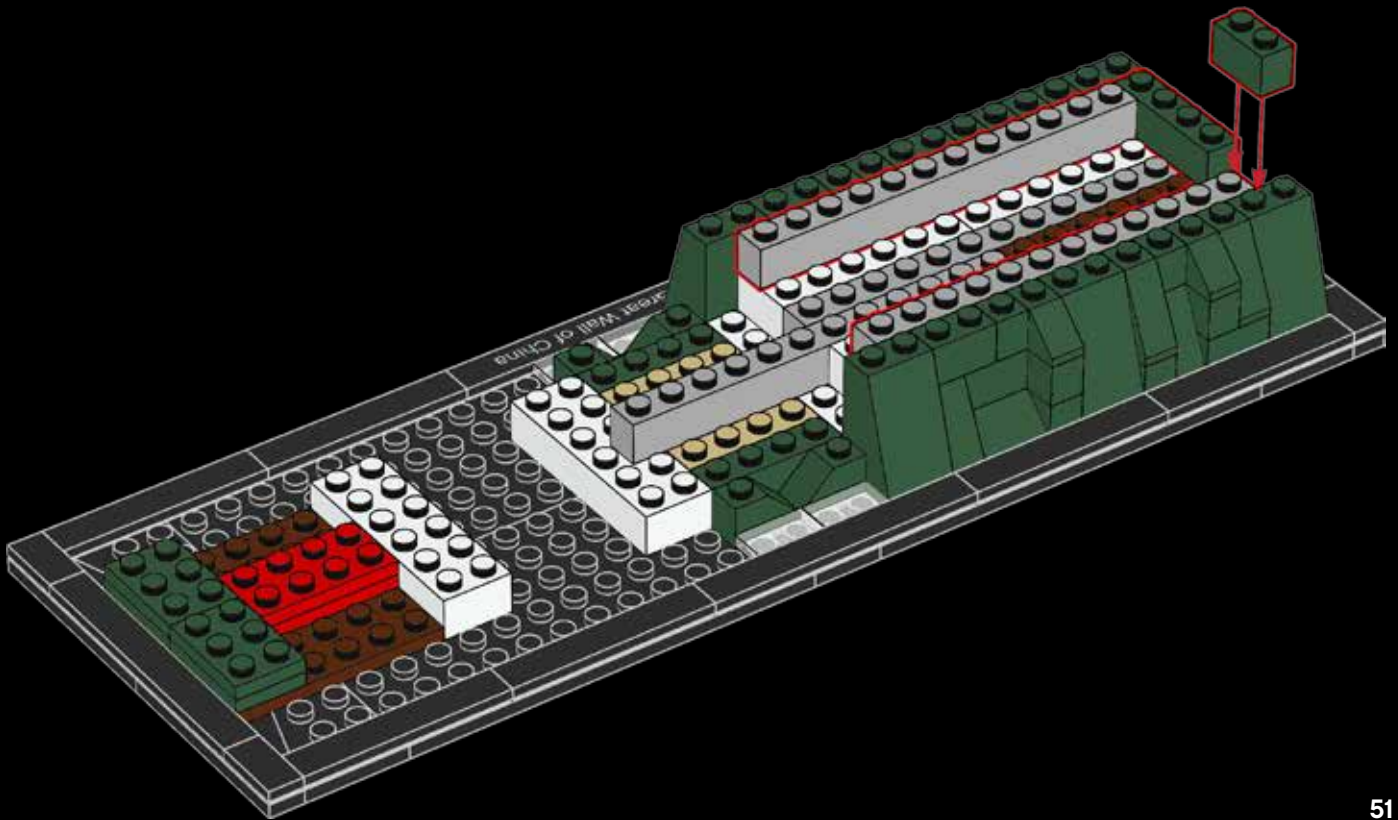



3x

24

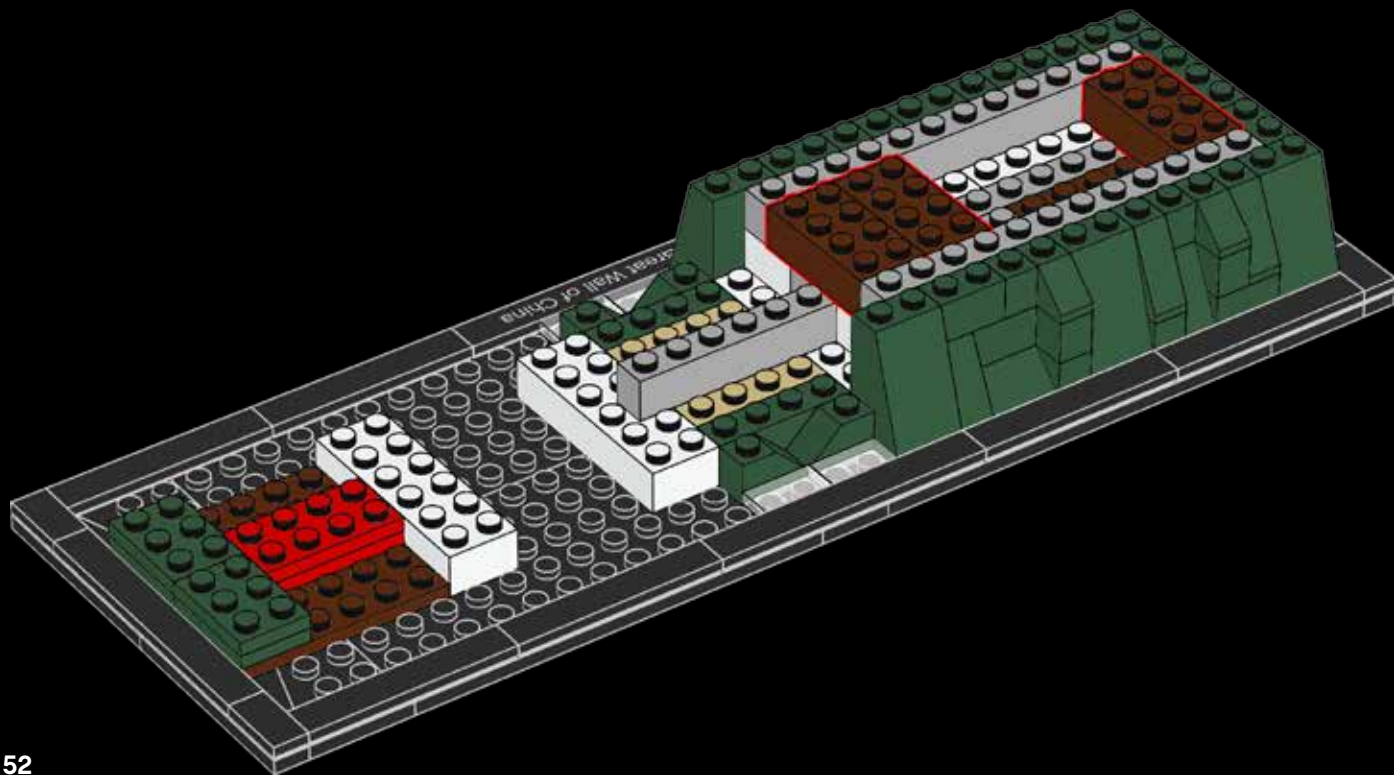



25

It is believed that almost one third of the wall has disappeared without trace.
On estime que près d'un tiers de la muraille a disparu sans laisser de traces.
Se cree que casi una tercera parte de la muralla ha desaparecido sin dejar rastro.

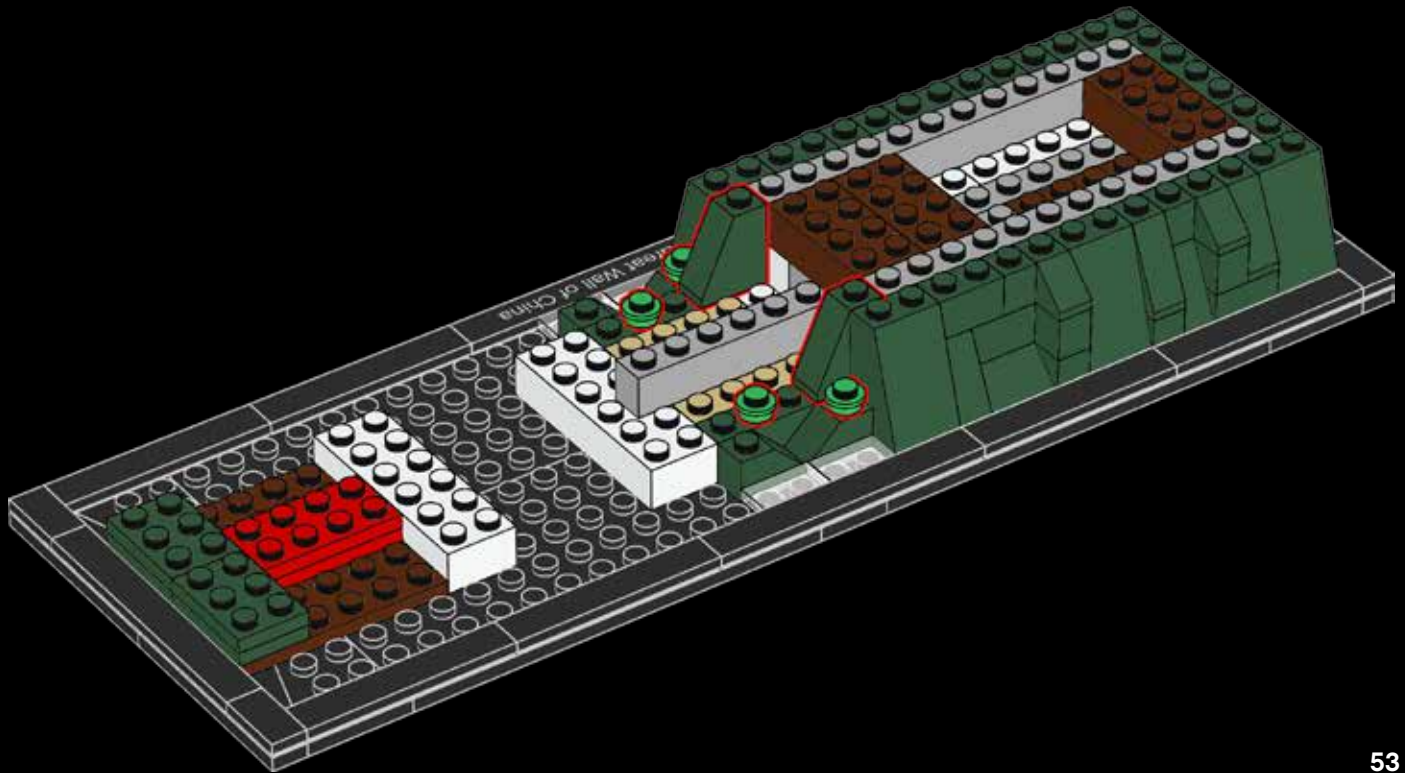



6x

26



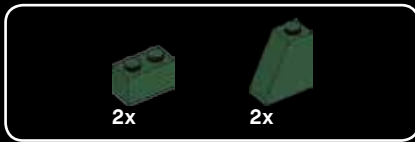

27

The first mention of the wall outside China came in the early 16th century when a Portuguese writer wrote about a solid wall with a strong garrison.
La première mention de la muraille à l'extérieur de la Chine date du début du XVI^e siècle, lorsqu'un écrivain portugais décrit un mur solide défendu par une forte garnison.

La primera mención a la muralla fuera de China es de principios del siglo XVI, cuando un escritor portugués escribió acerca de una muralla sólida con una fuerte guarnición.

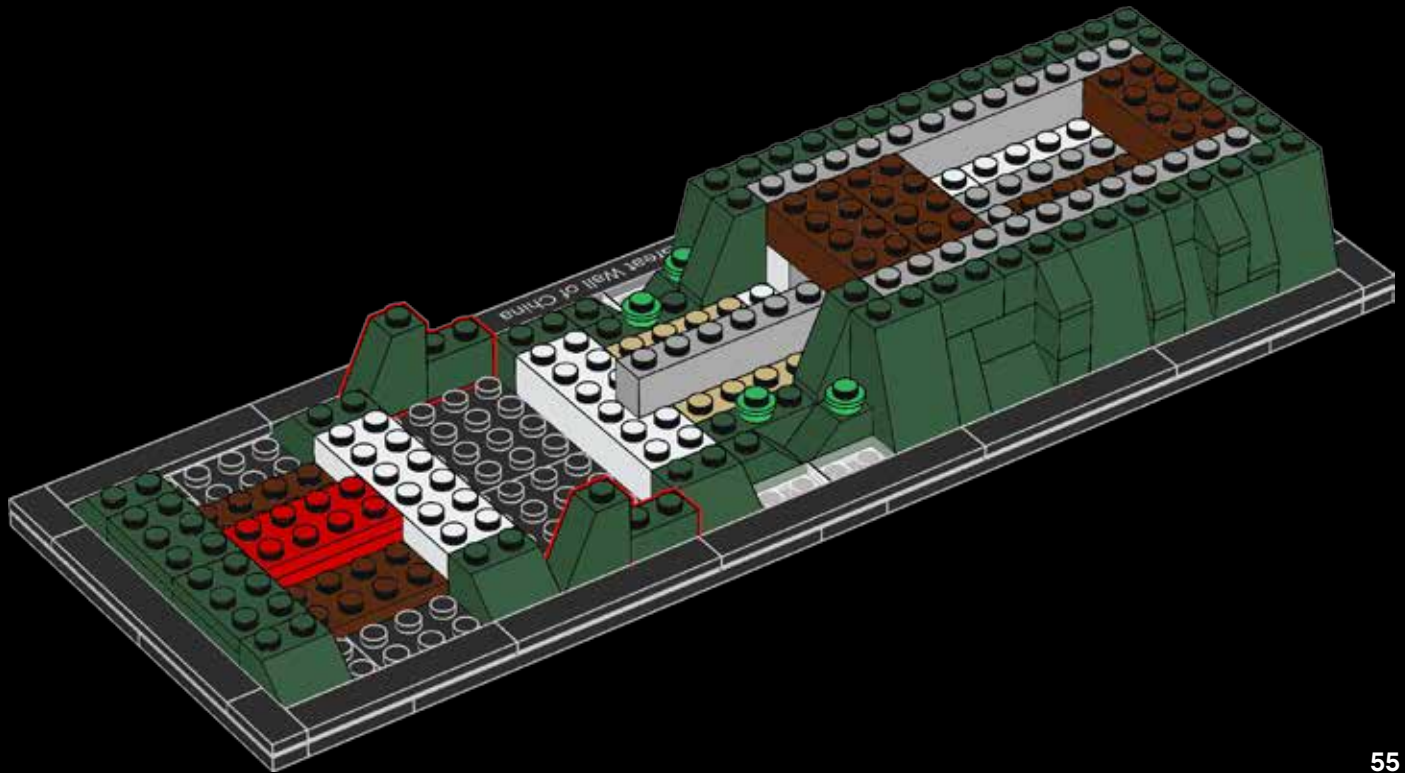



28

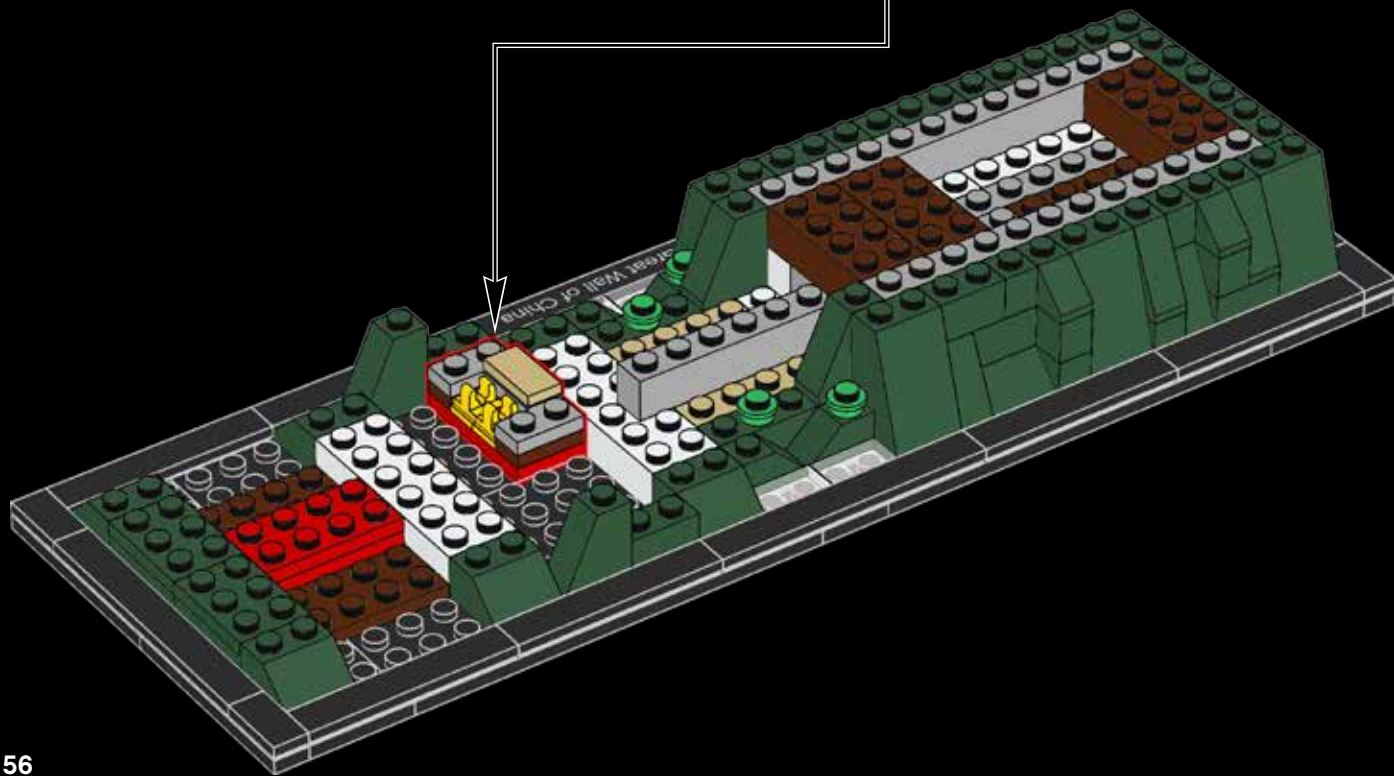
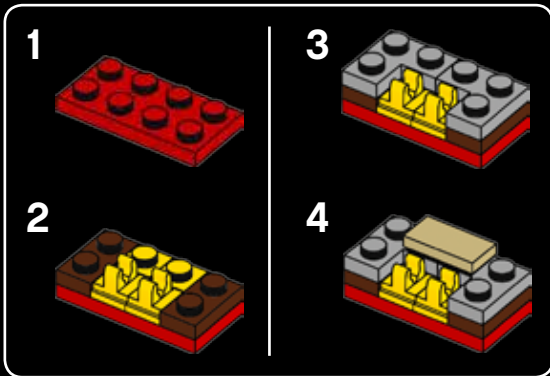

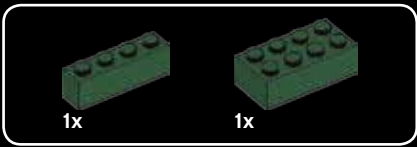

29



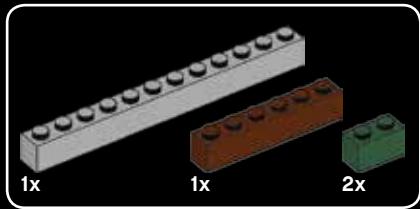

30

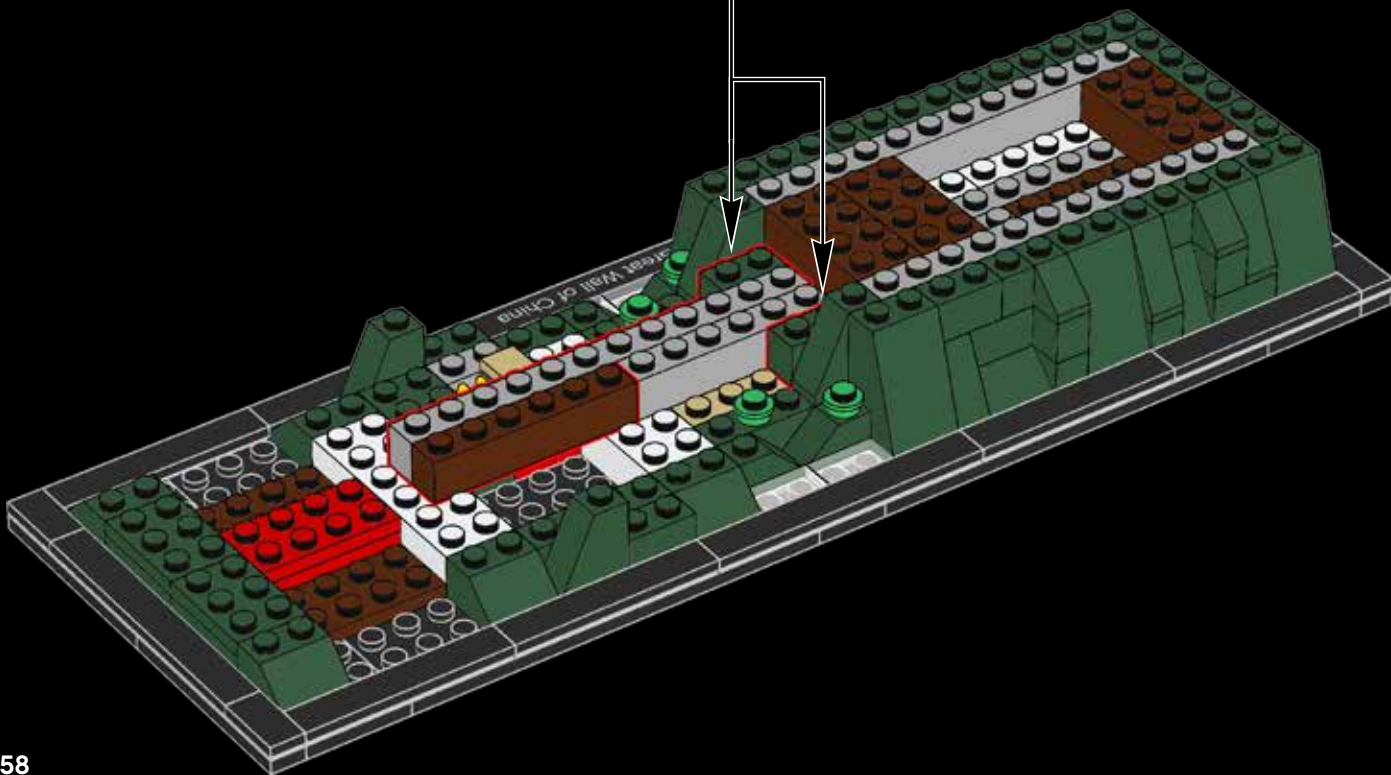
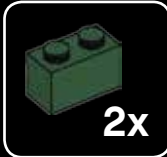



31

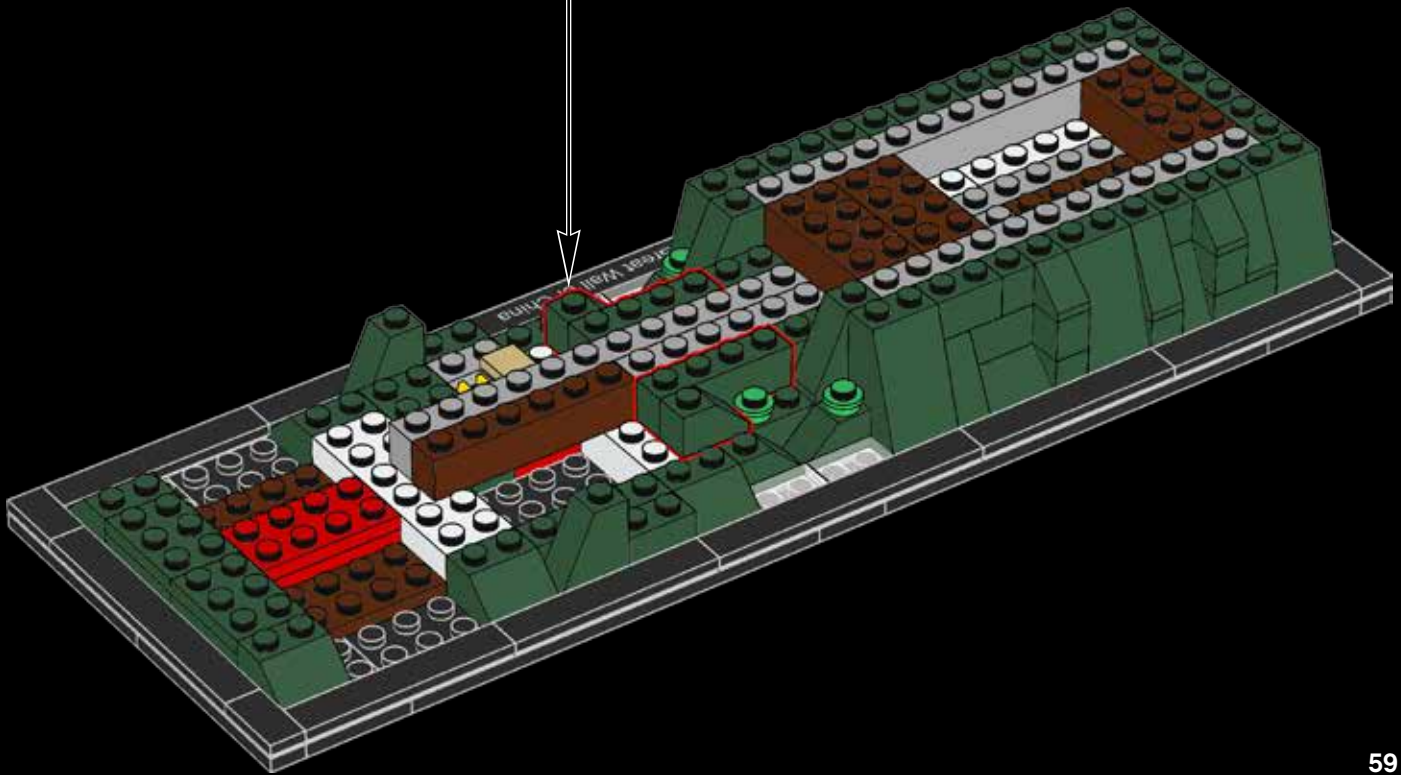

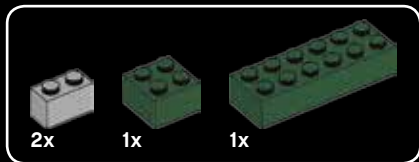

32

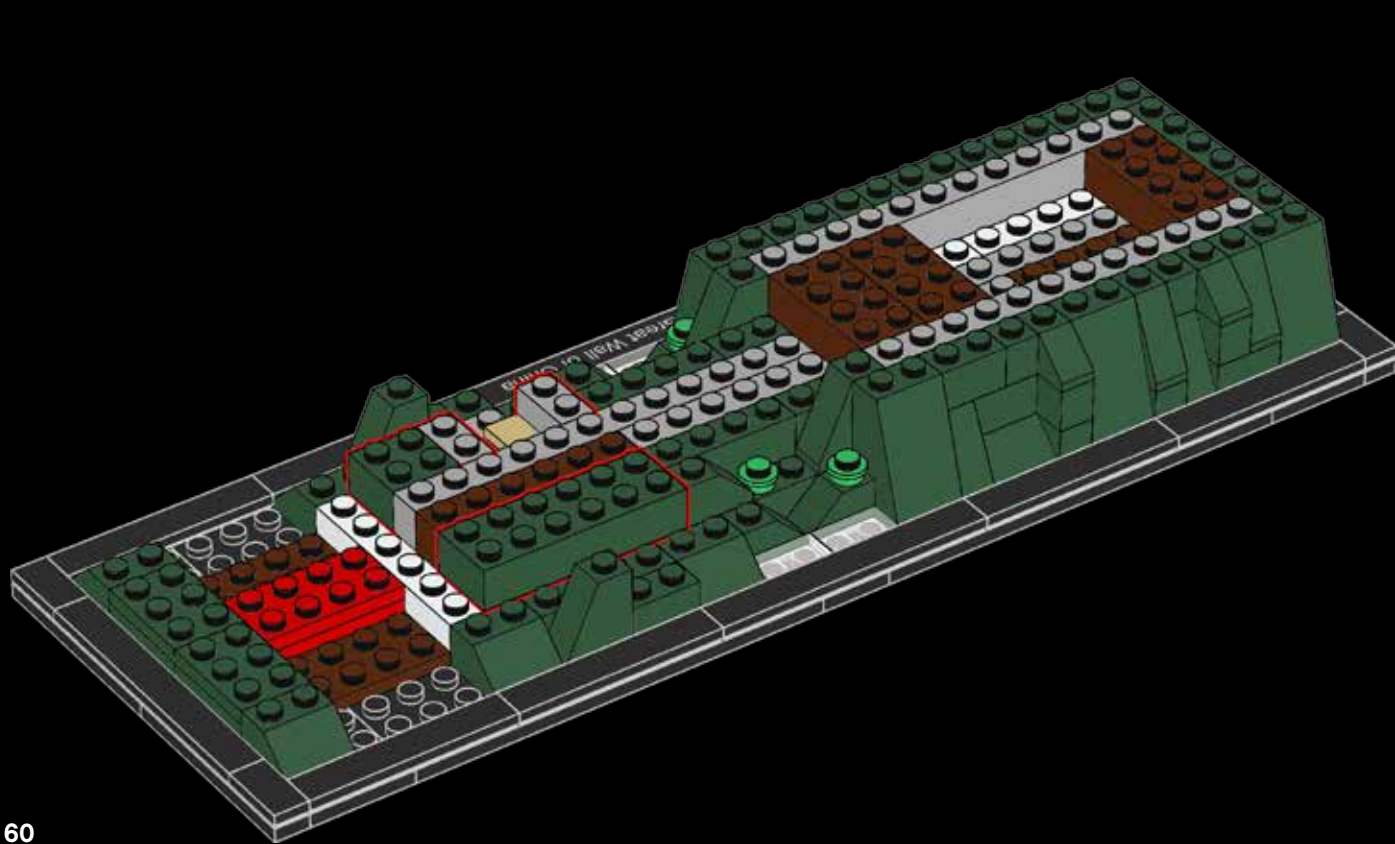



33

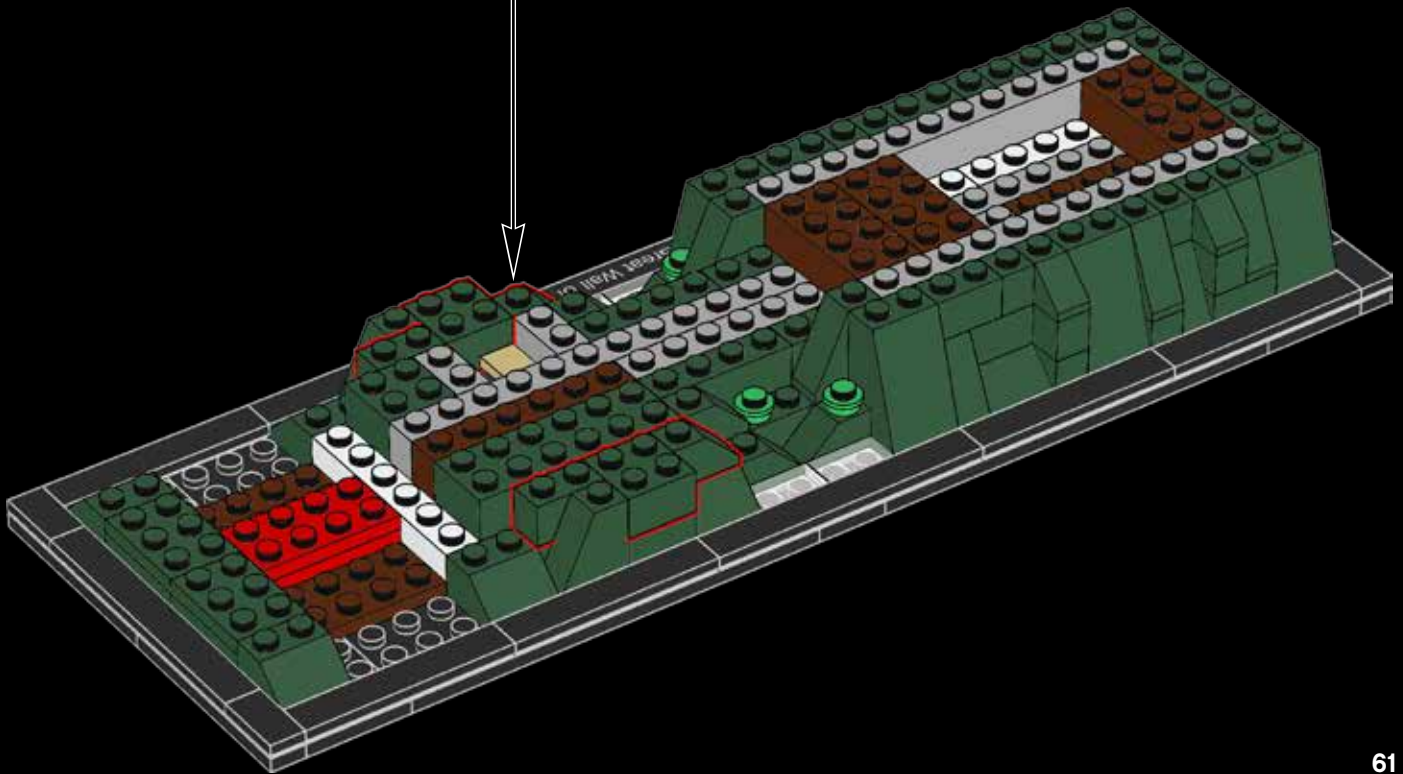



34

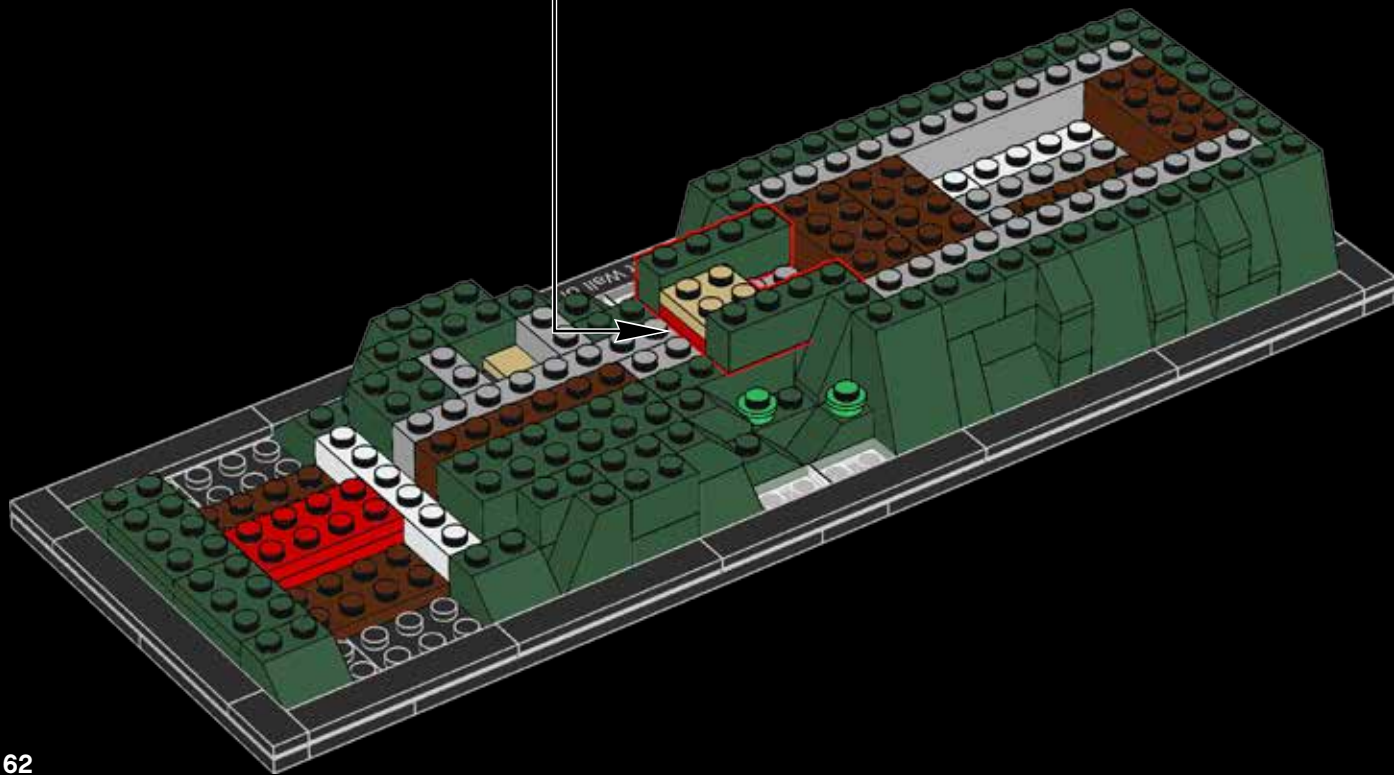
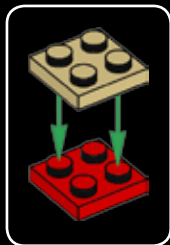

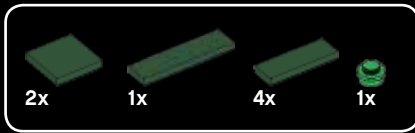

35

Until the 20th century the Chinese themselves never spoke of a single Great Wall.
Avant le XX^e siècle, les Chinois ne parlaient jamais d'une seule et unique Grande Muraille.
Hasta el siglo XX, los mismos chinos jamás habían hablado de una sola Gran Muralla.

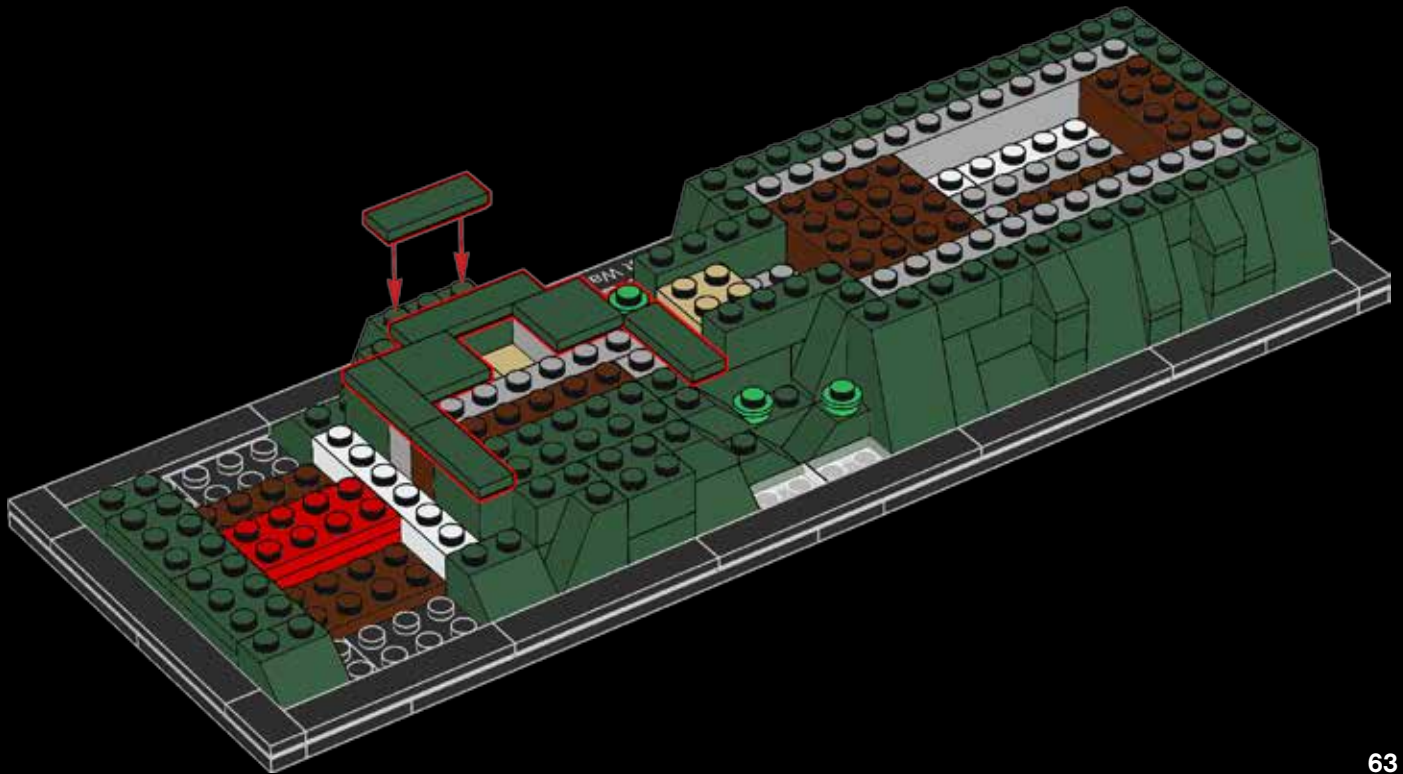

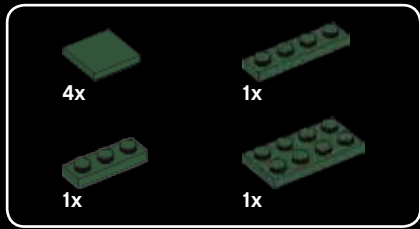

36

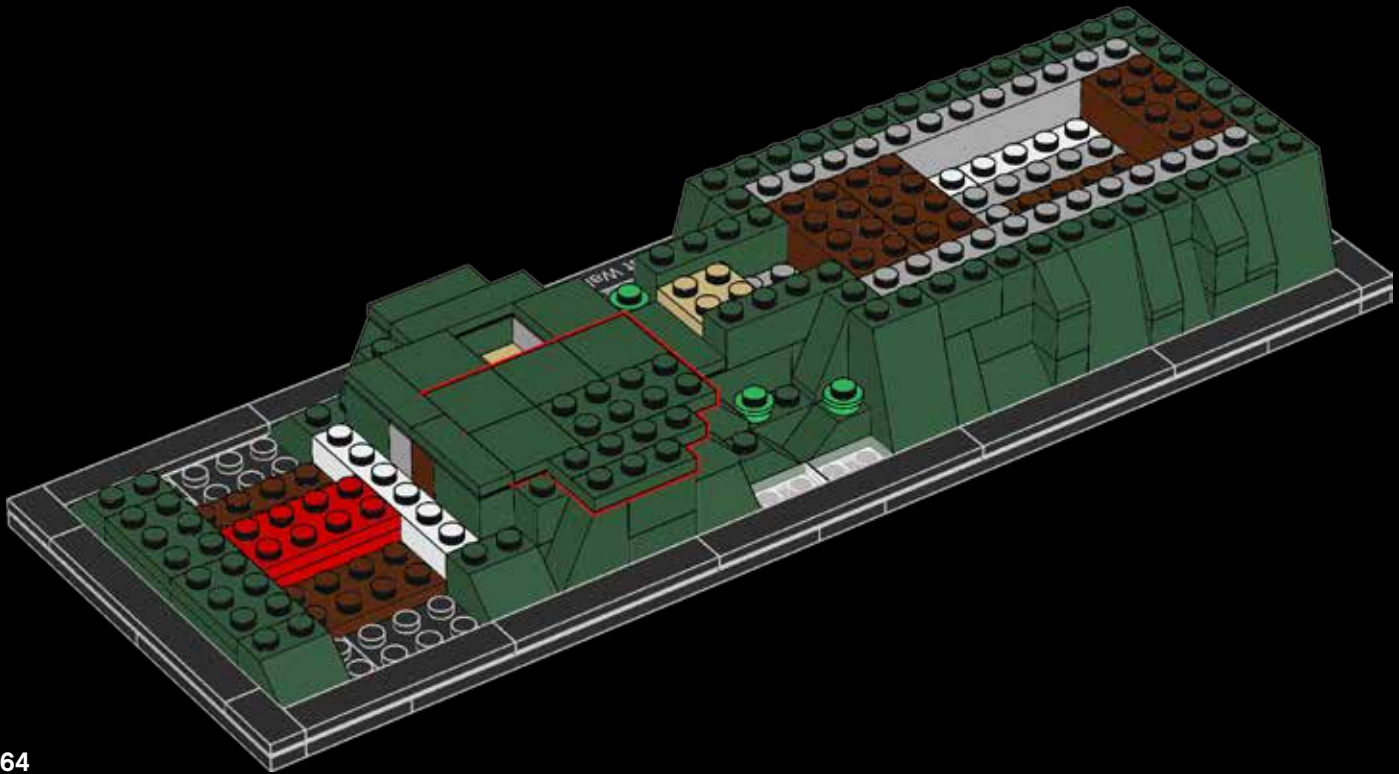



37

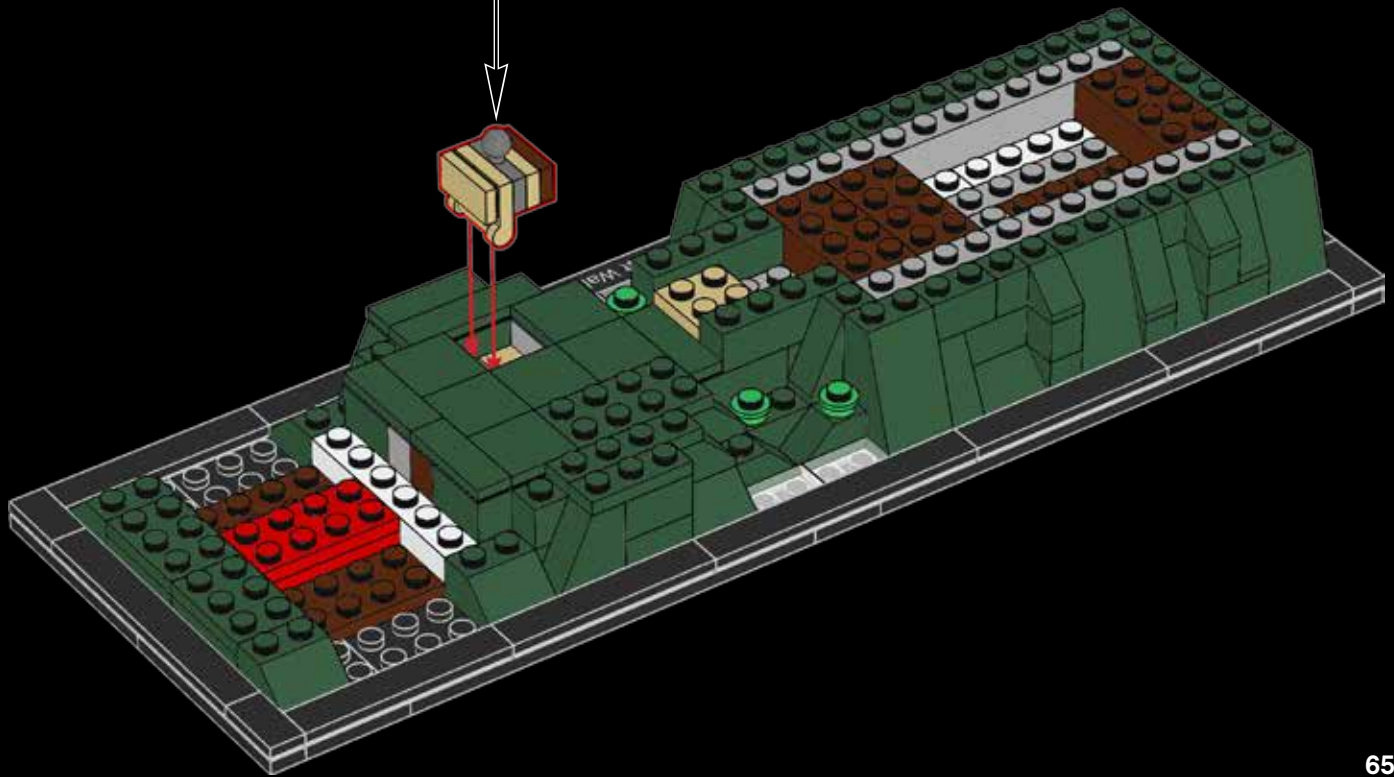
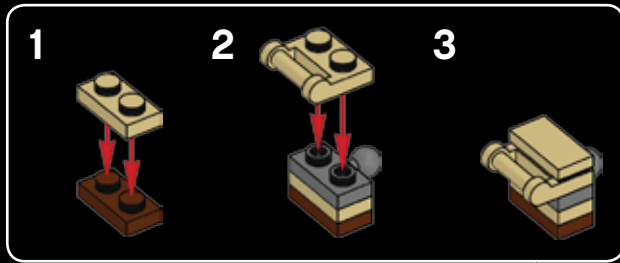



38

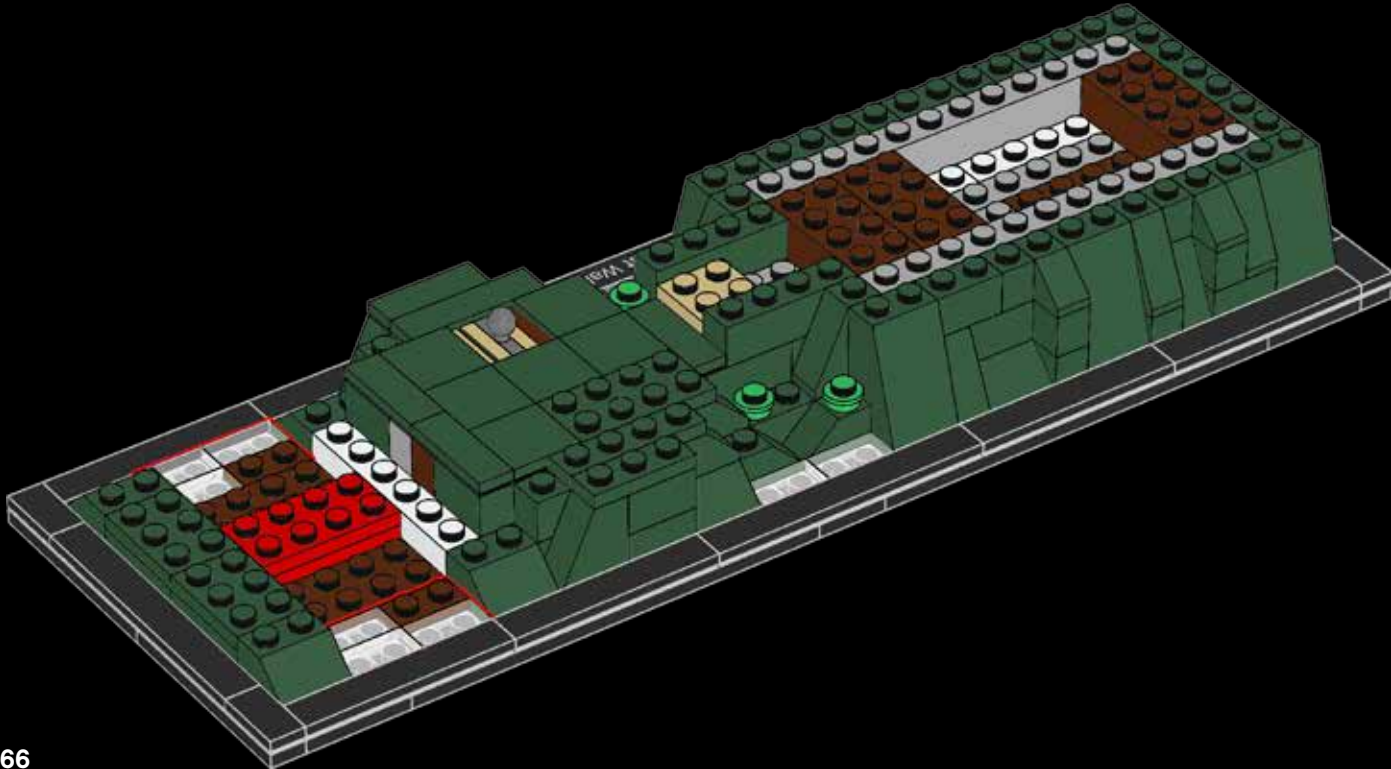

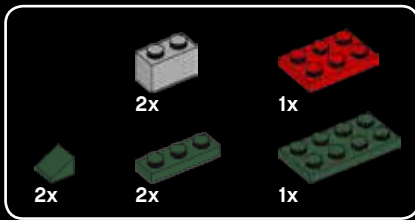

39

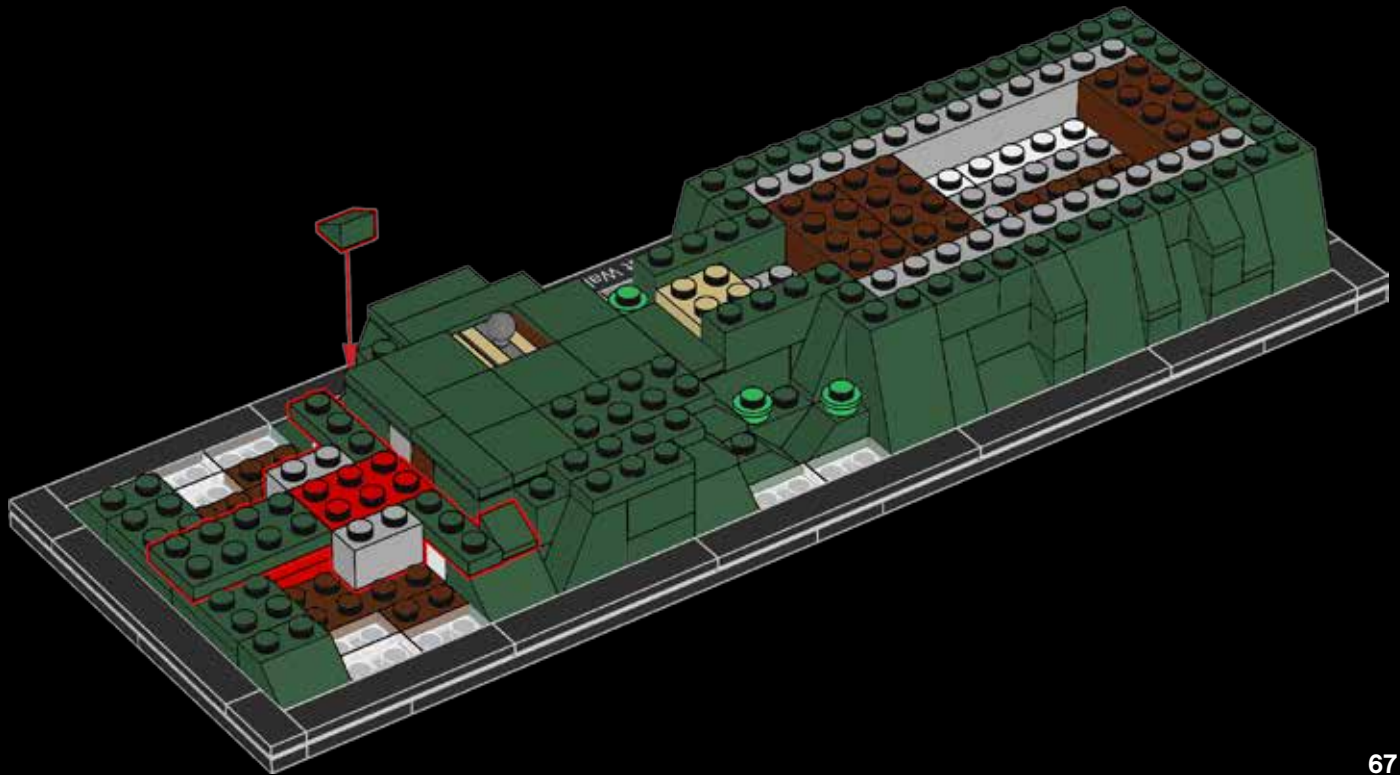

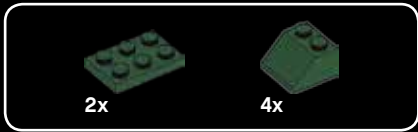

40





The wall's strength and endurance has been put down to the use of "sticky rice" in the mortar that holds the stones and bricks in place.

La solidité et la durabilité de la muraille sont attribuées à l'utilisation de « riz collant » incorporé au mortier qui maintient les pierres et les briques en place. Se cree que la fortaleza y resistencia de la muralla se deben a la incorporación de "arroz pegajoso" al mortero que mantiene unidas las piedras y ladrillos.



41



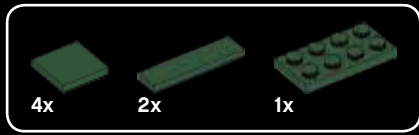

42

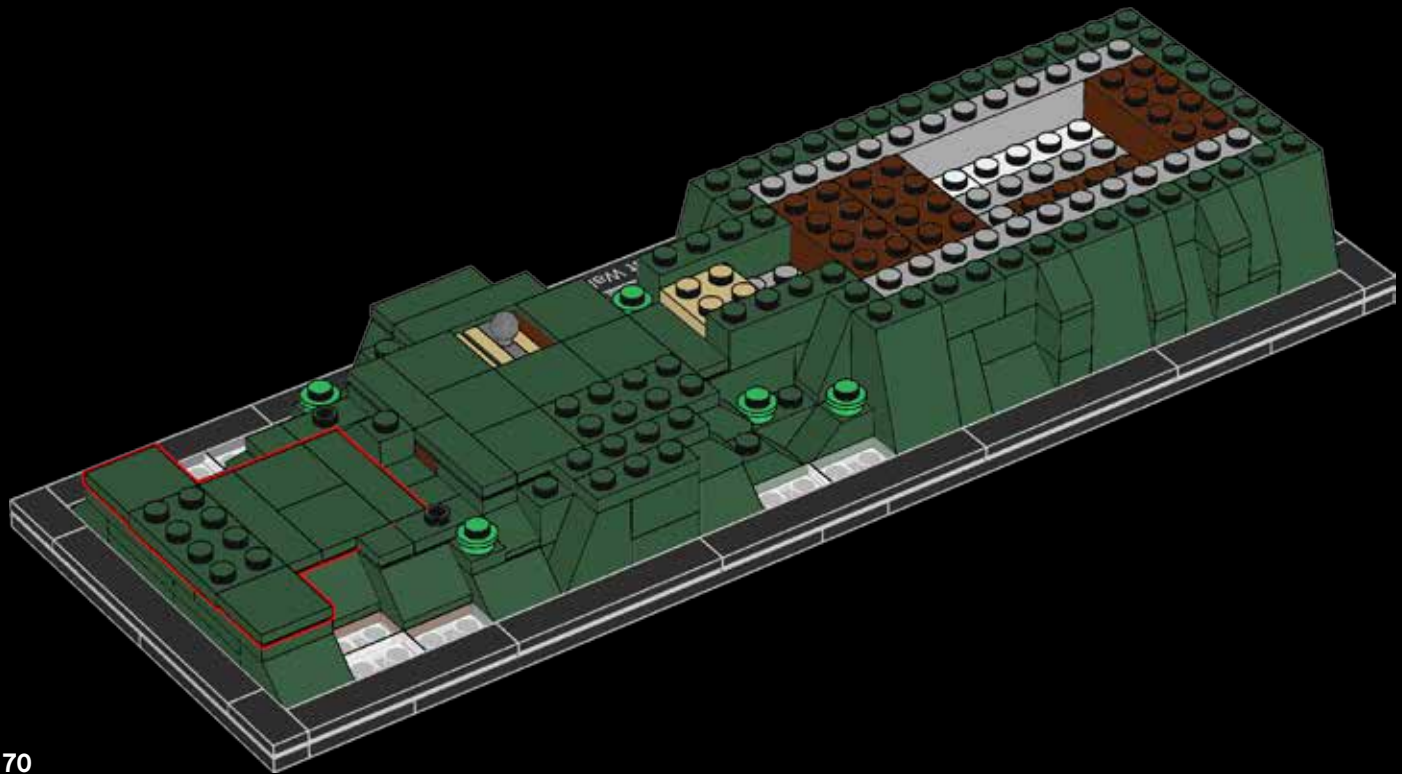

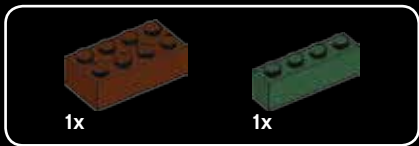

43

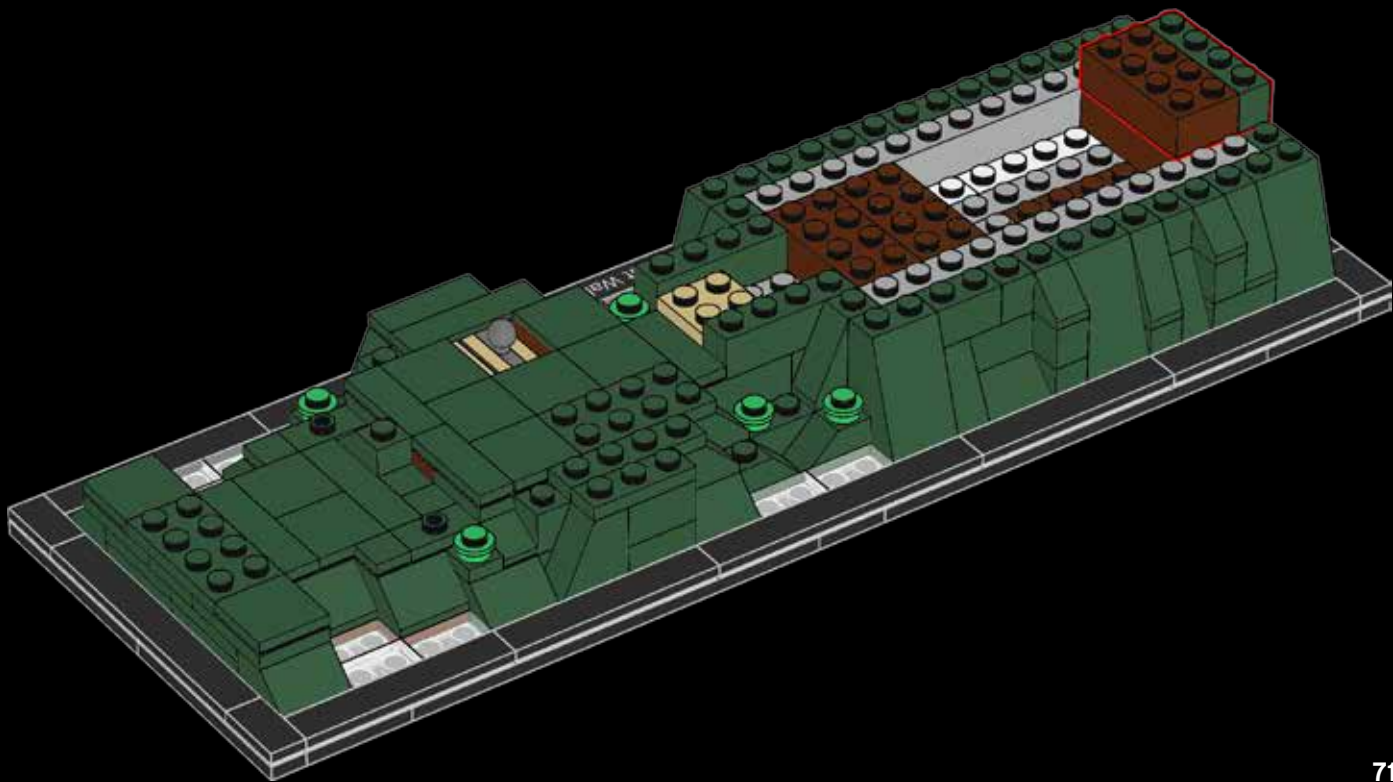

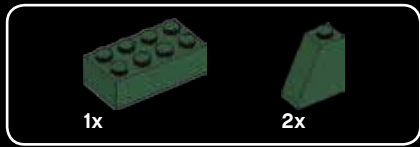

44



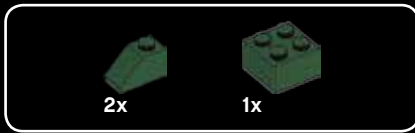

45

The Great Wall is also a "must-see" for VIPs and over 300 heads of states have visited the impressive structure.

La Grande Muraille est également un incontournable pour les grands de ce monde : plus de 300 chefs d'État ont visité l'impressionnante structure.

La Gran Muralla es también una "visita obligada" para las grandes celebridades: más de 300 jefes de estado han visitado la impresionante estructura.



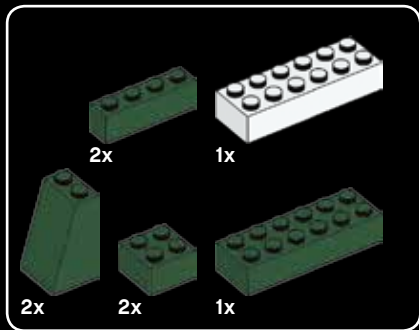

46



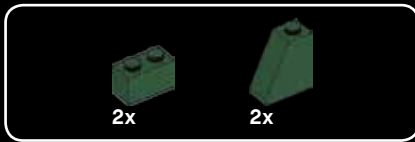

47

The wall spans across 15 different regions in northern China.
La muraille traverse 15 régions distinctes dans le nord de la Chine.
La muralla recorre 15 regiones diferentes del norte de China.

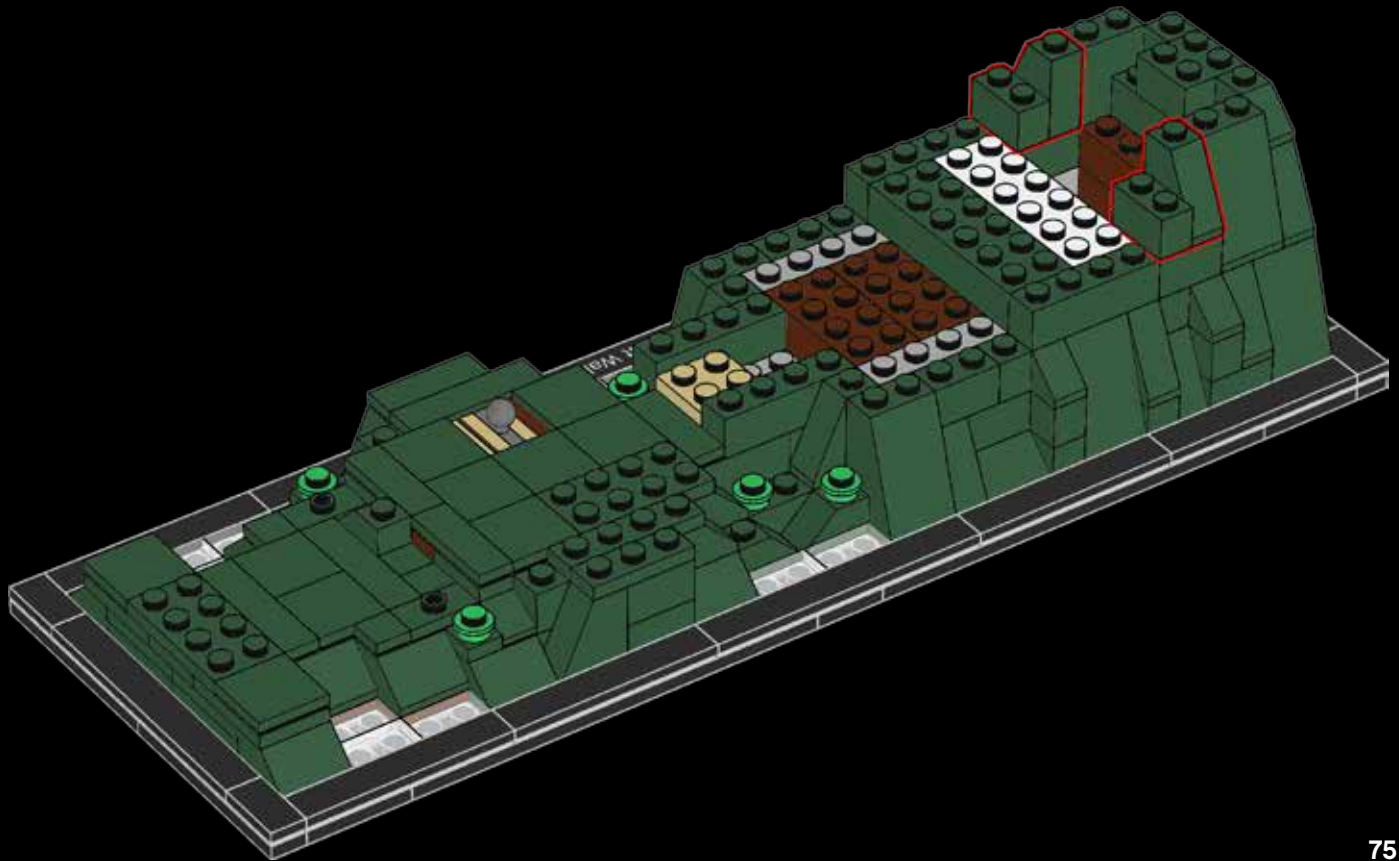

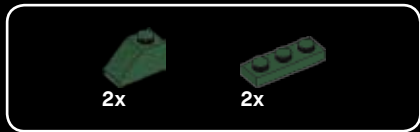

48



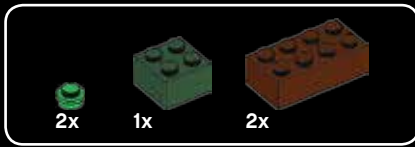

49

At its highest, the wall is 46 ft. (14 m) tall.
À son point le plus élevé, la muraille atteint 14 m de hauteur.
En su punto más alto, la muralla mide 14 m de altura.

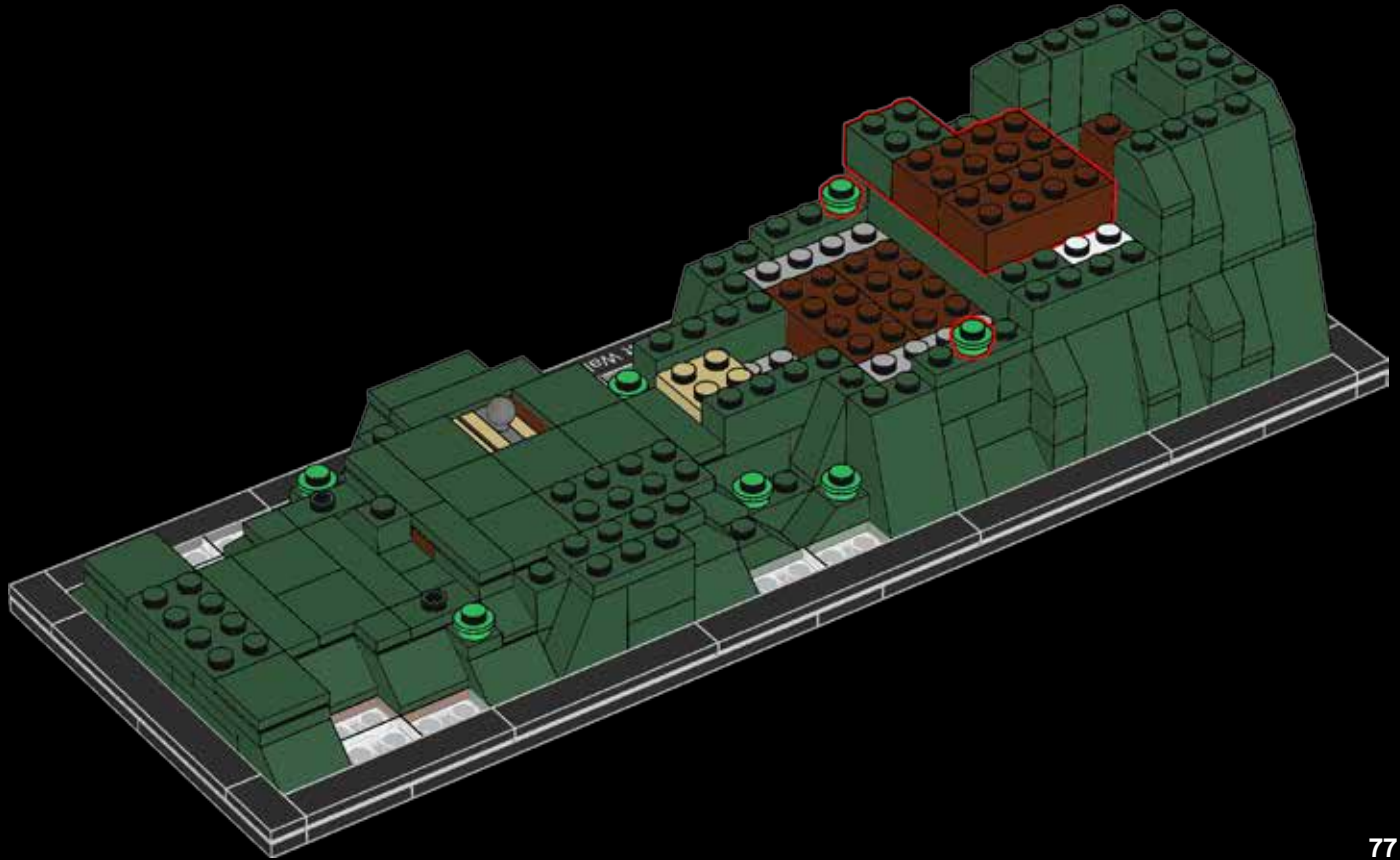

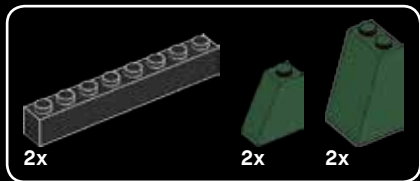

50



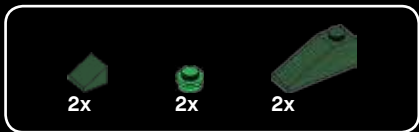

51

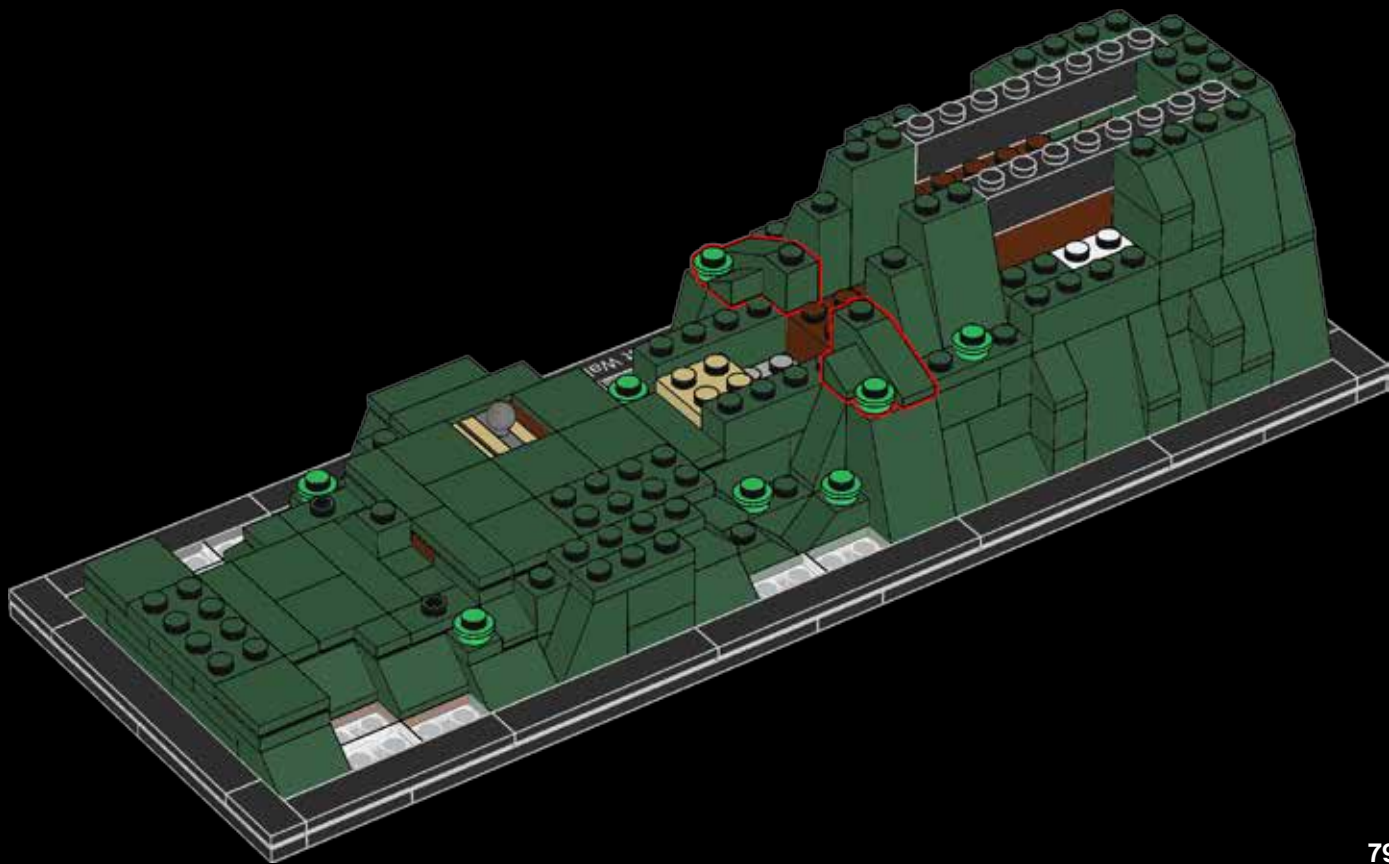

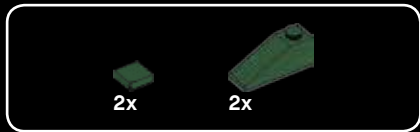

52

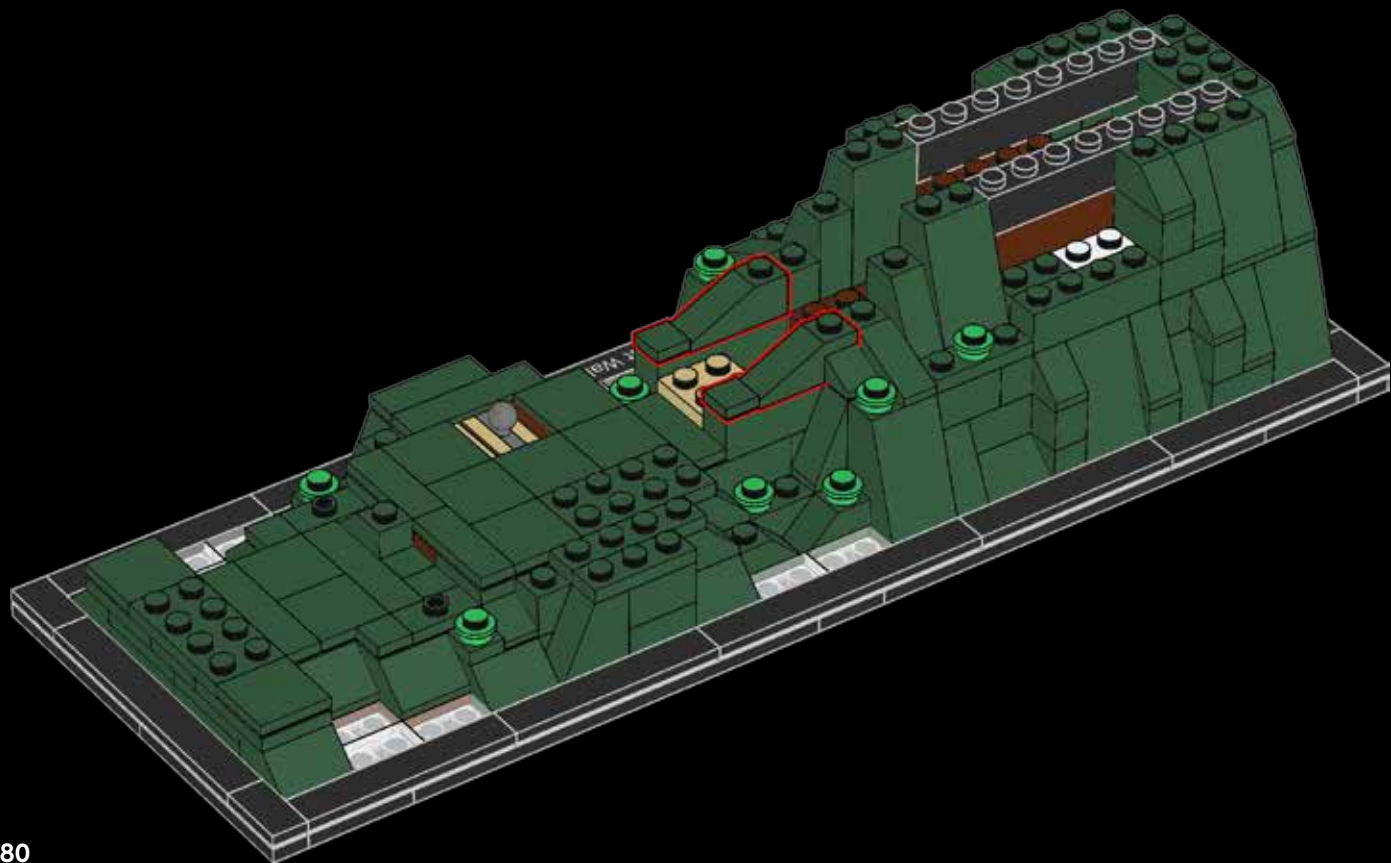



53

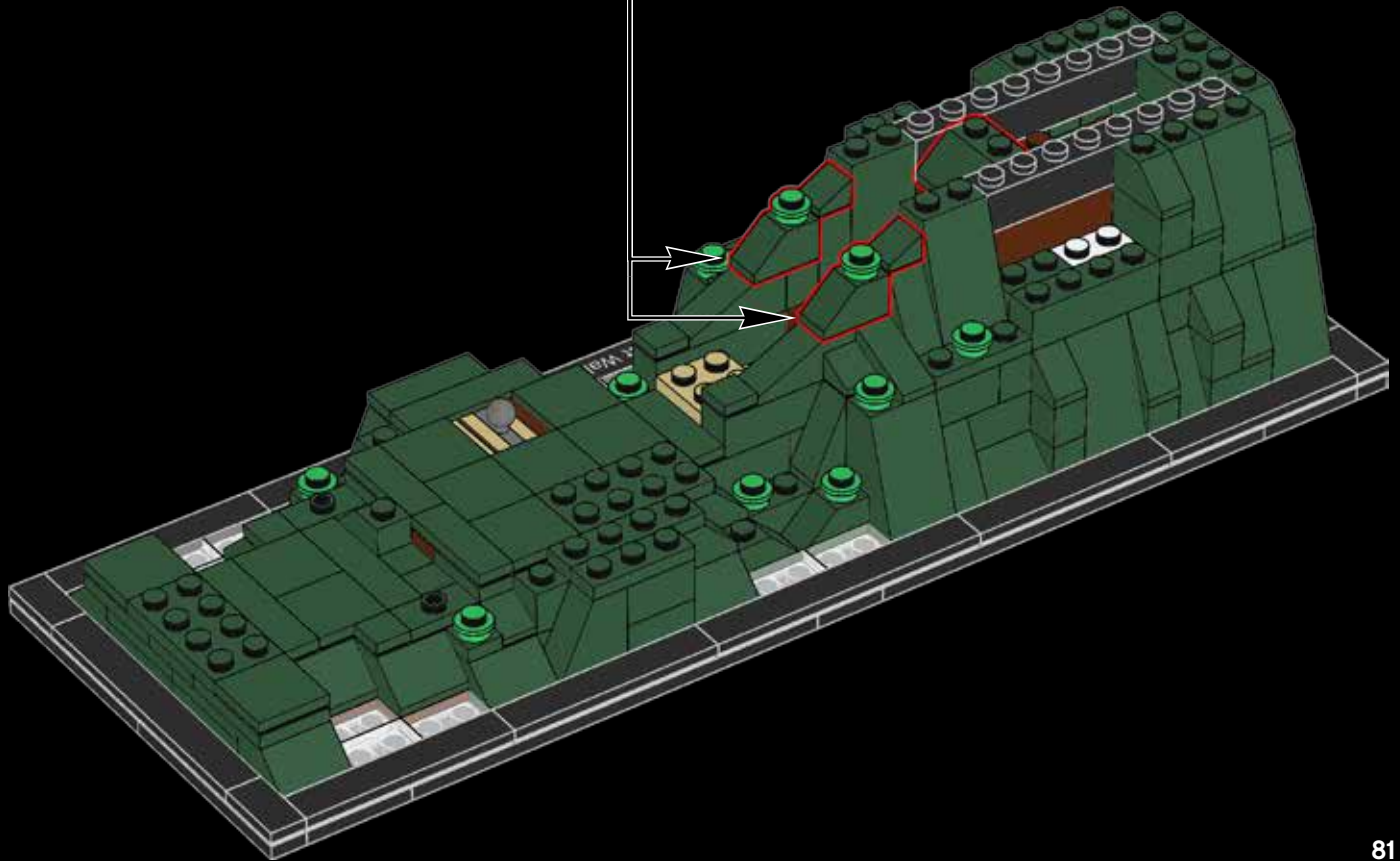
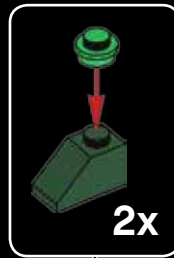



54



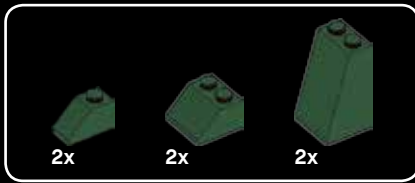

The Great Wall is the world's longest defensive fortification.
La Grande Muraille est le plus long ouvrage de défense dans le monde.
La Gran Muralla es la fortificación defensiva más larga del mundo.



55

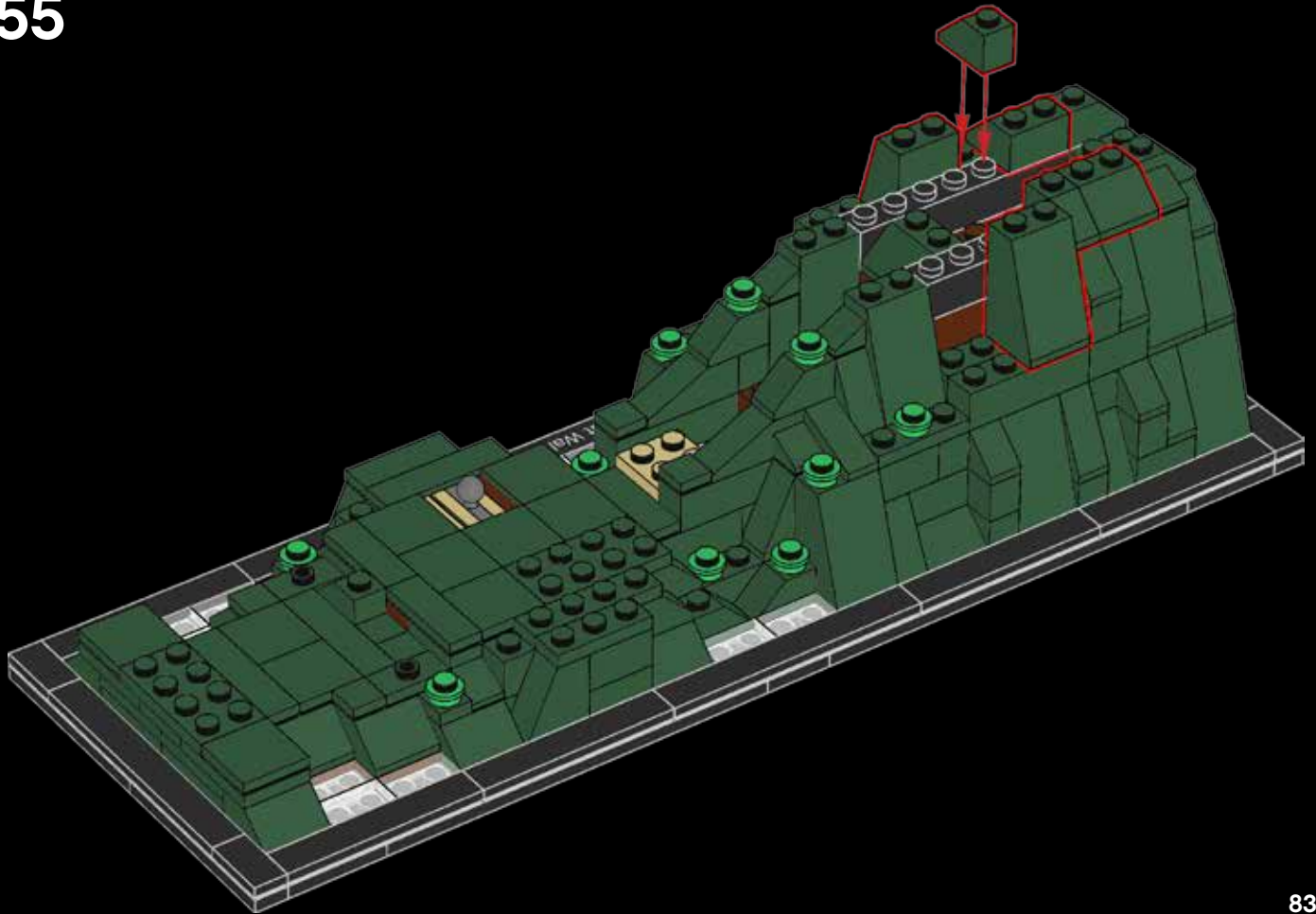



56

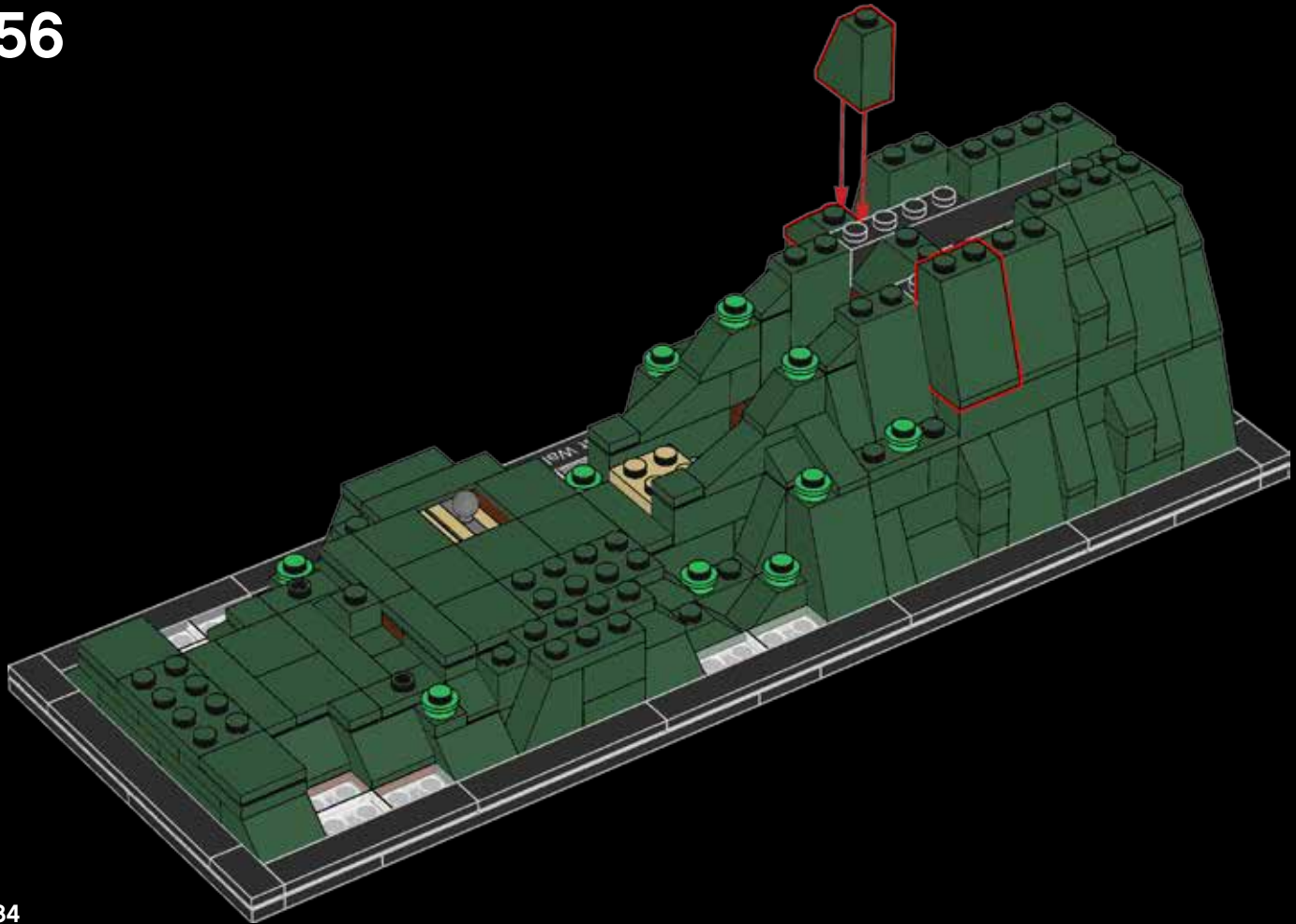



57

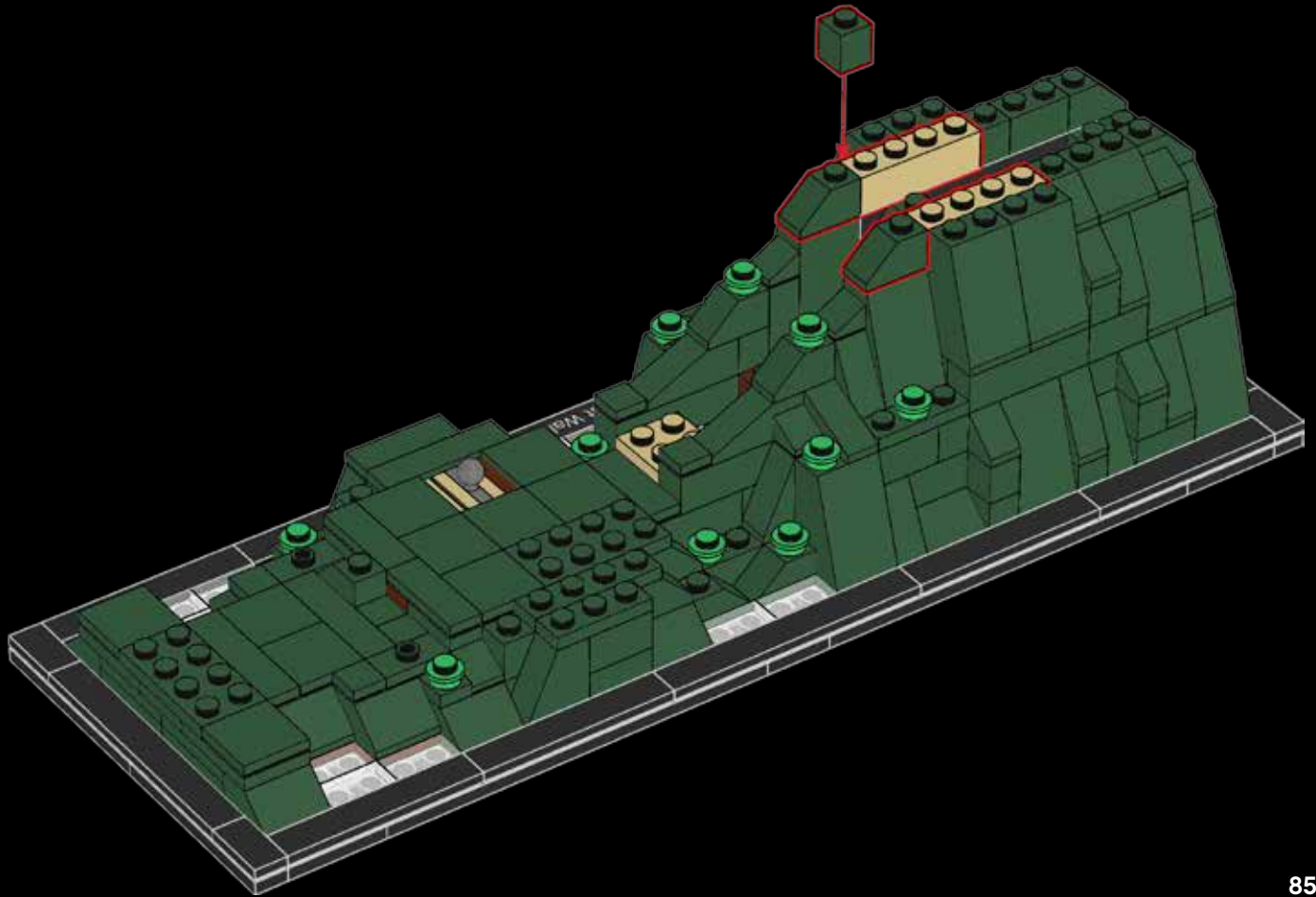

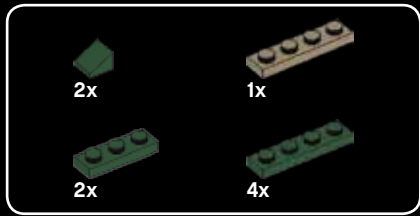

58





59

Throughout its history the wall has been called "The Purple Frontier", "The Earth Dragon" and most recently "The Long Wall."
Tout au long de son histoire, la muraille a porté divers surnoms, dont « la frontière pourpre », « le dragon de terre » et, plus récemment, « la longue muraille ».
A lo largo de su historia, la muralla ha sido llamada "La Frontera Púrpura", "El Dragón de la Tierra" y, más recientemente, "La Larga Muralla".





6x

60



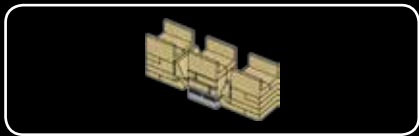

61



62



63

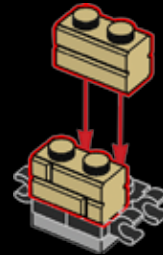

64





65

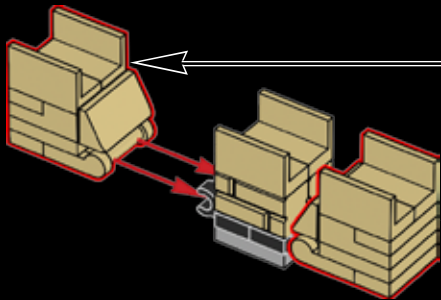
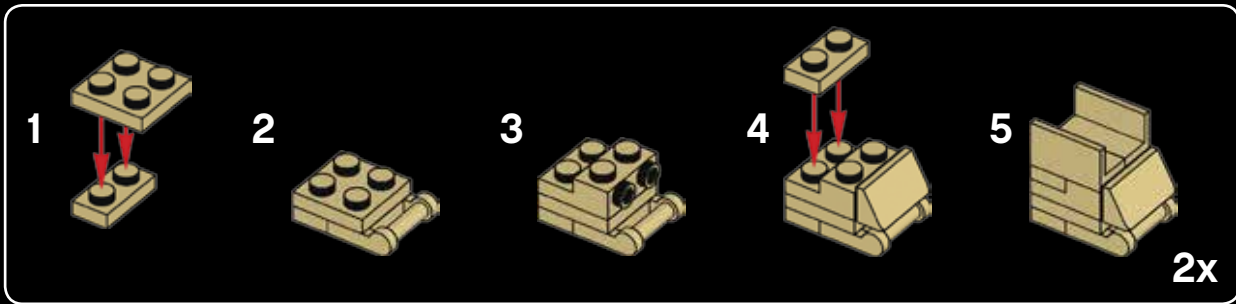

66

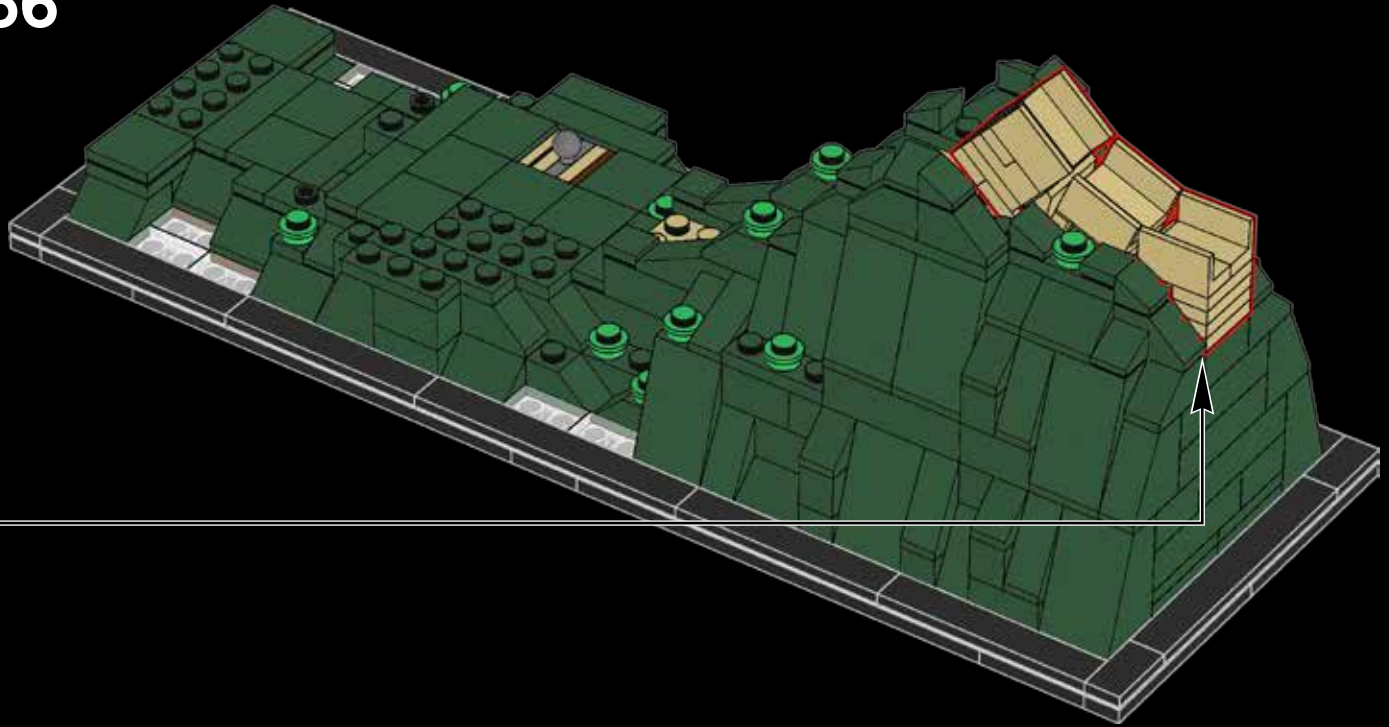

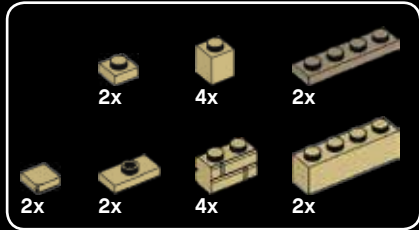

67

1

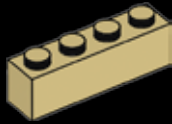

2

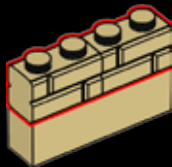

3

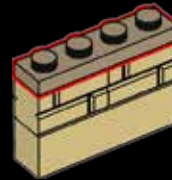

4

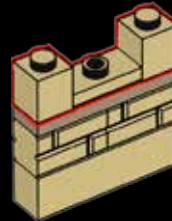

5

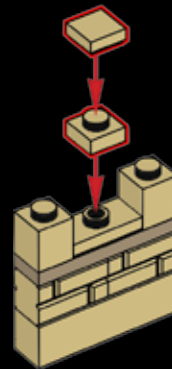

2x

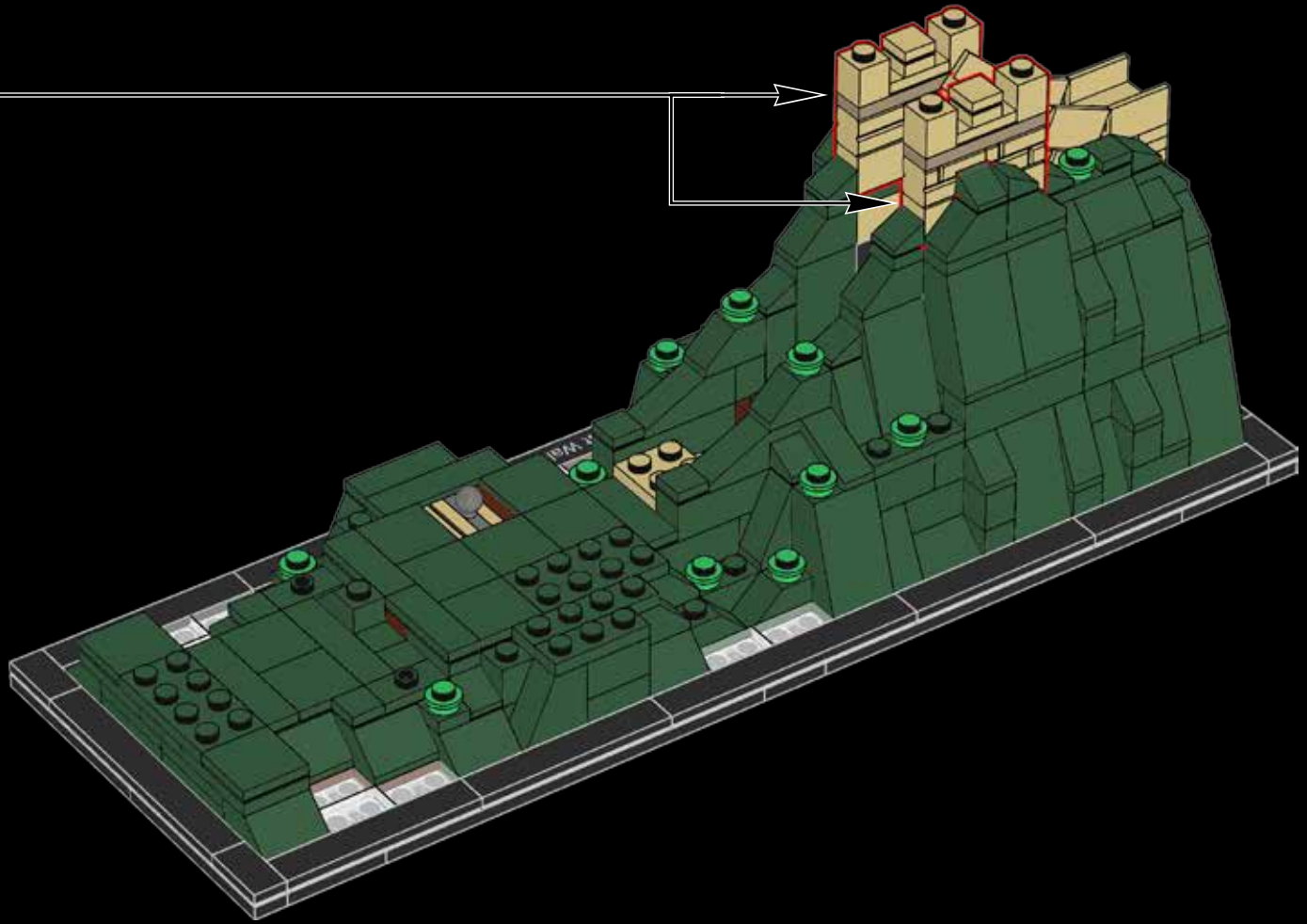

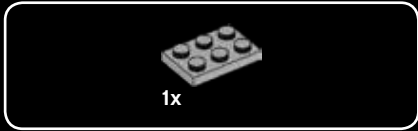
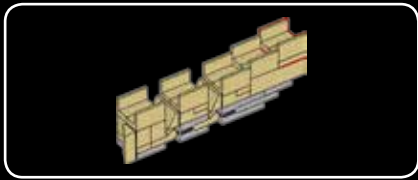

1x

68

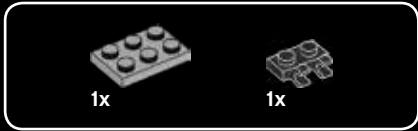

1x

1x

69

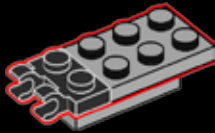

1x

1x

1x

70

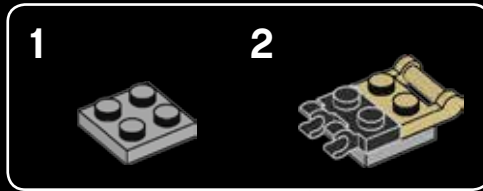

1

2

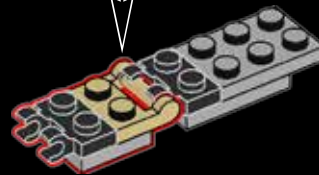



71

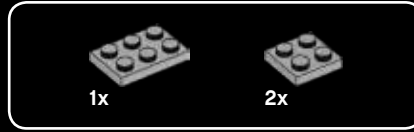
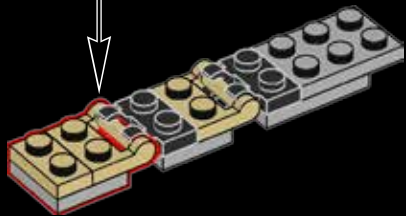
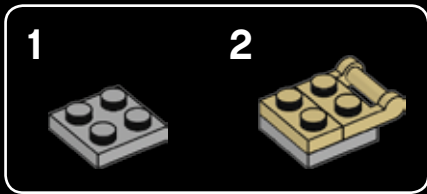

72

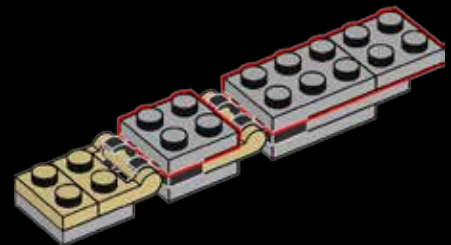



73

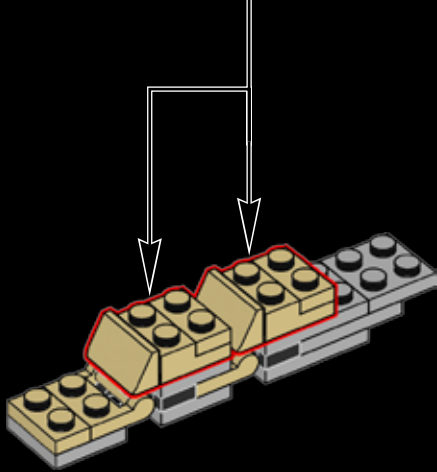
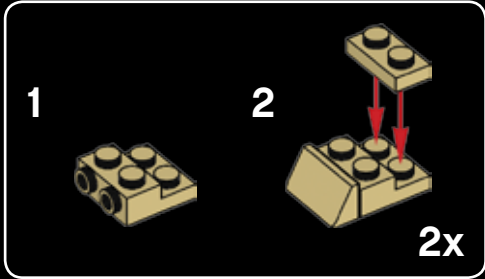

74

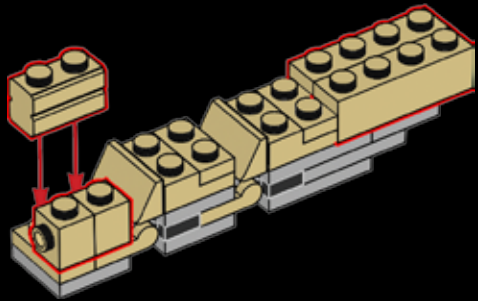



75

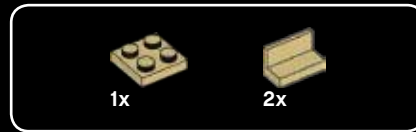
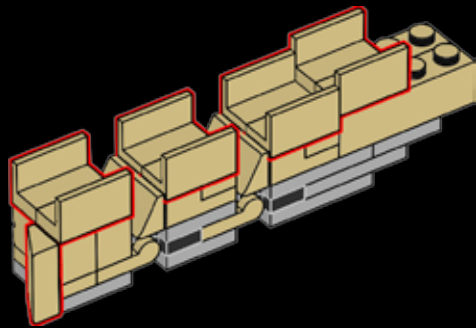

76

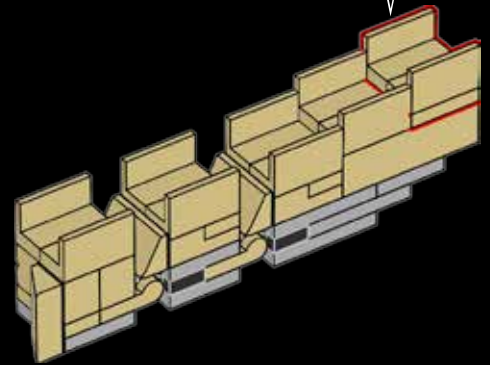
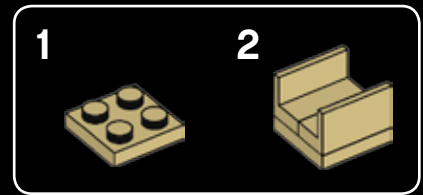

77

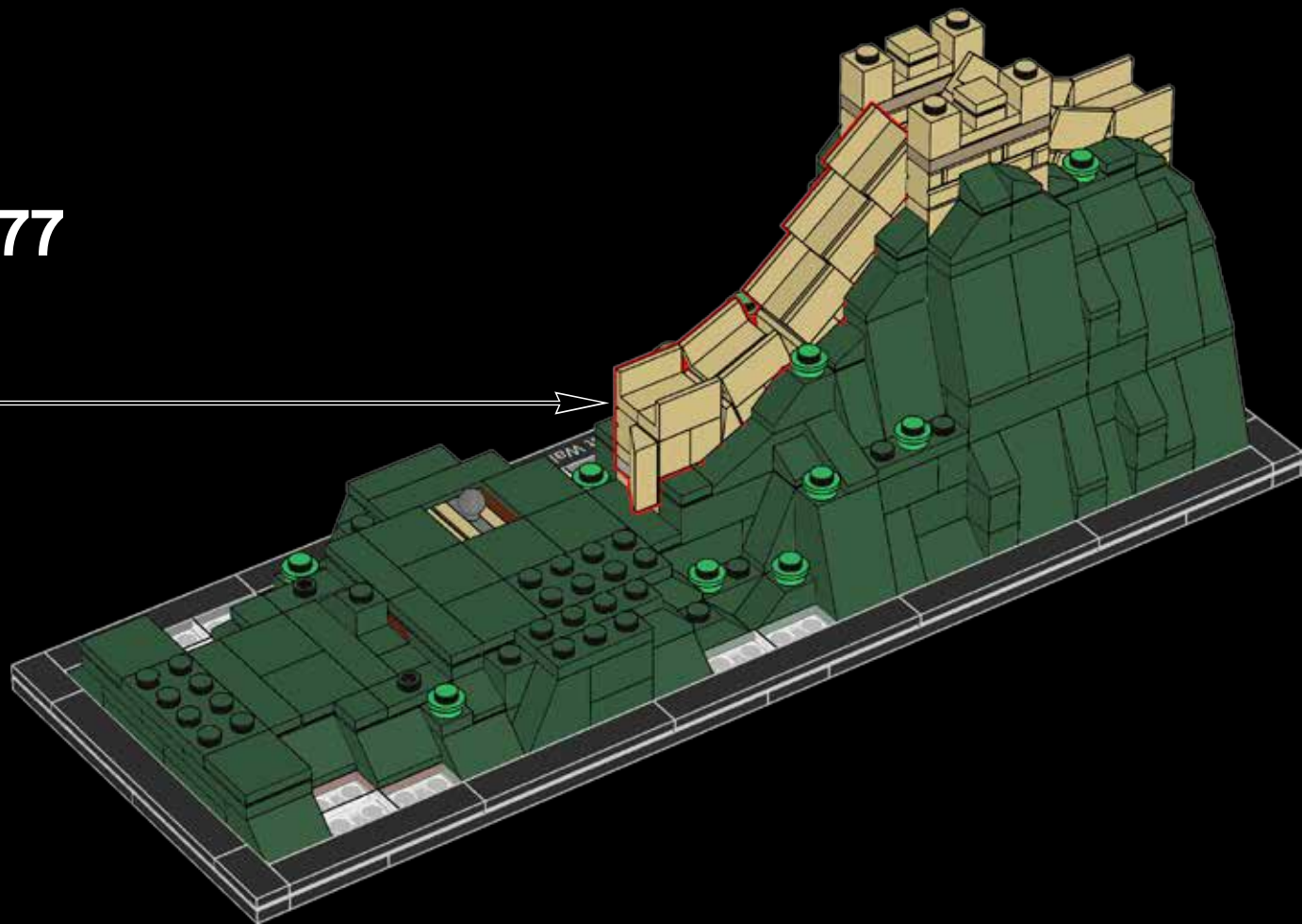

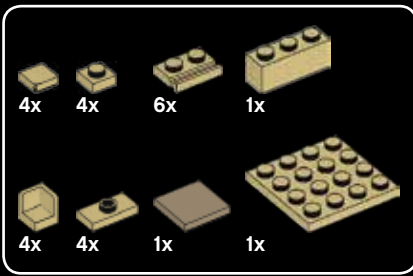

78

1

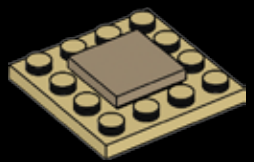

2

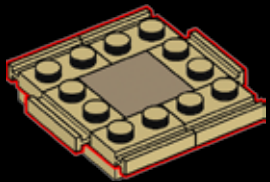

3

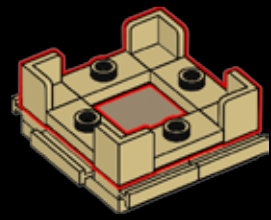

4

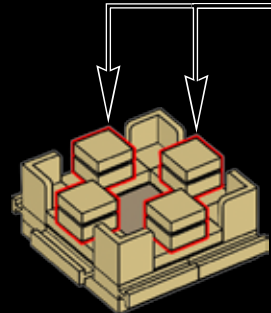

5

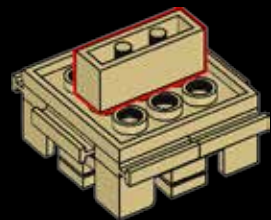
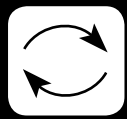

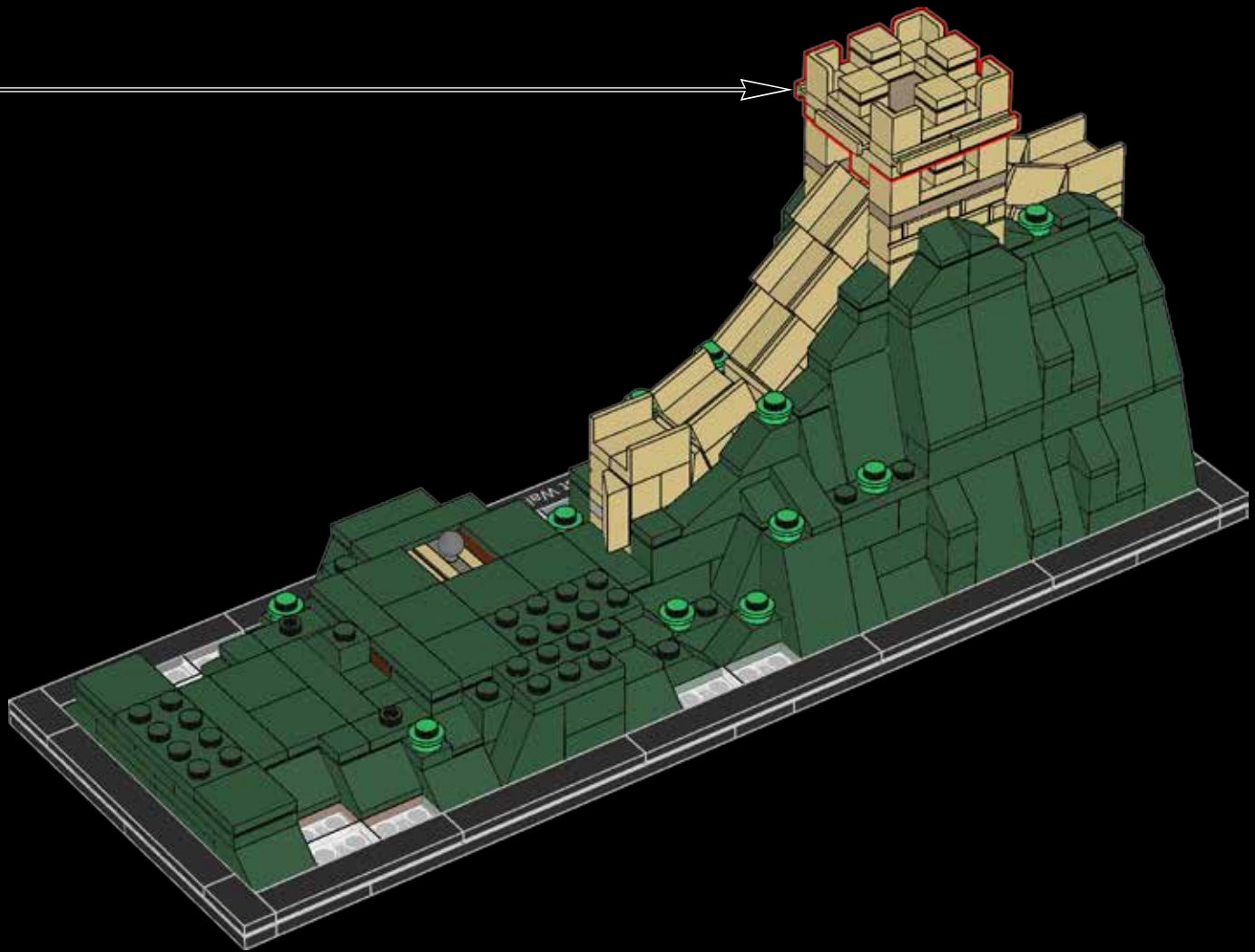

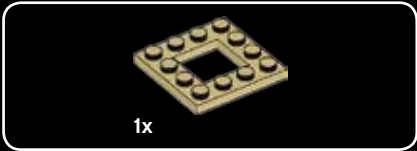
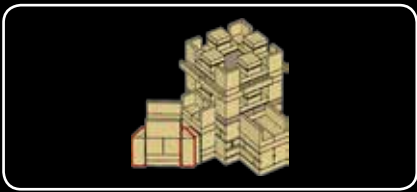

79

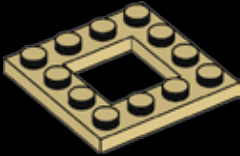

80

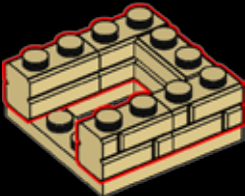

81

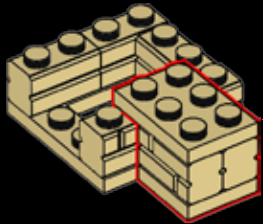
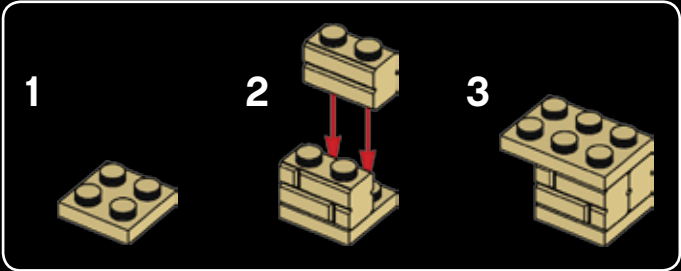



2x

82

1



2

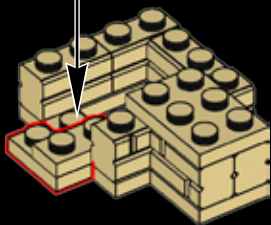

1x



1x



1x

83

1



2



3

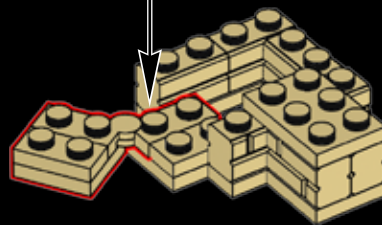



84

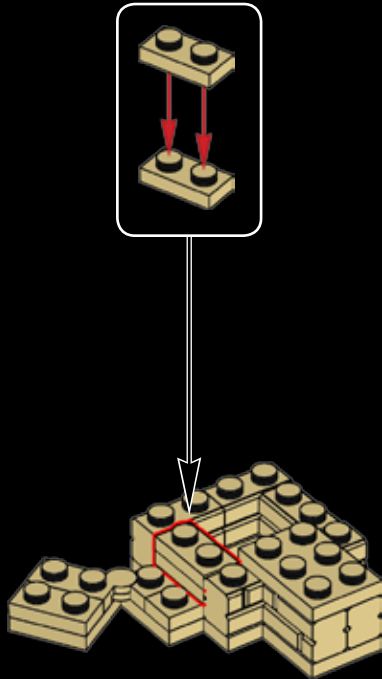

85

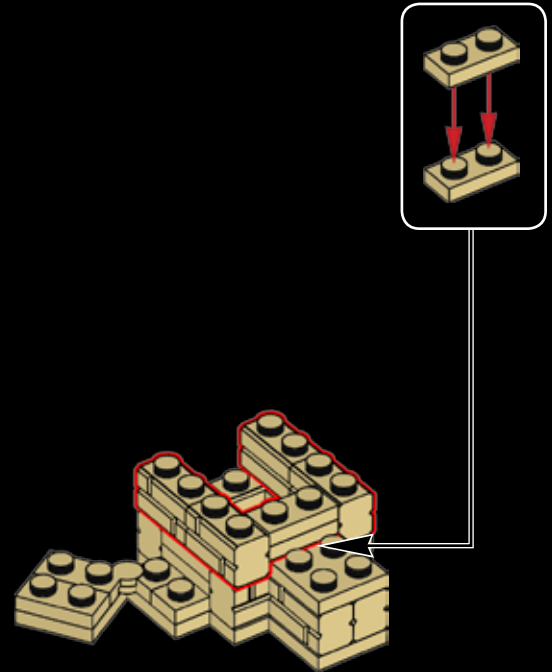

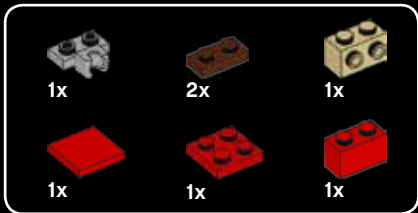

86

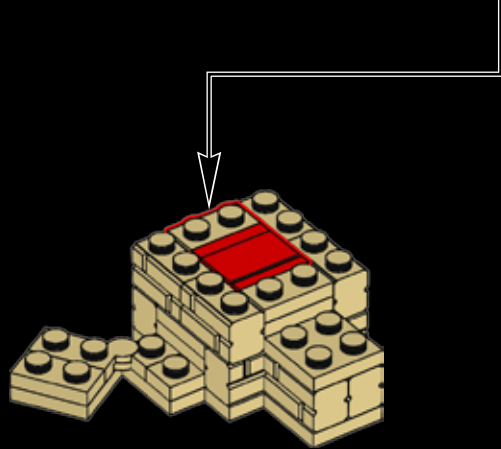
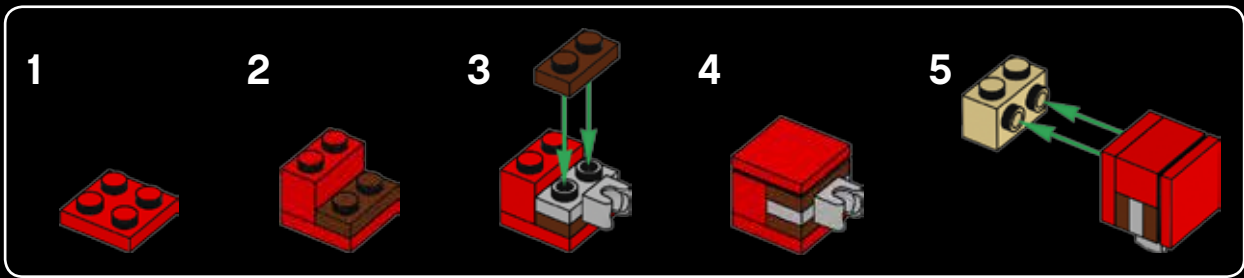

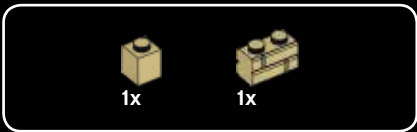

87

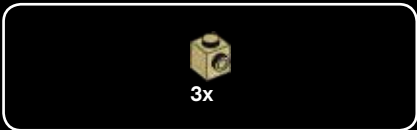
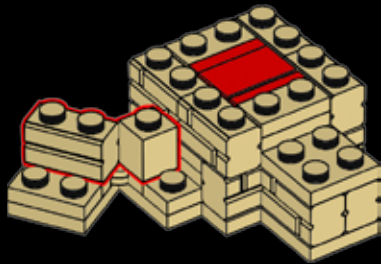

88

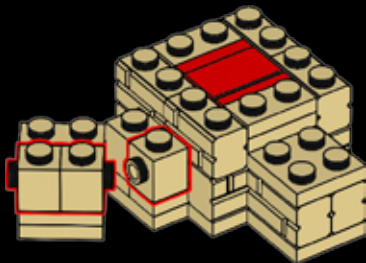

89

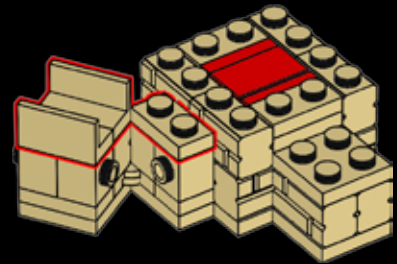

90

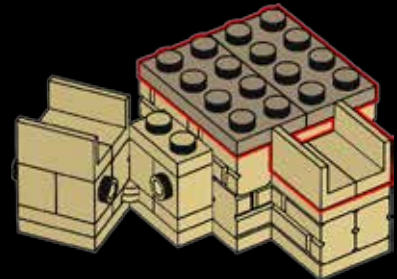



2x



4x

91

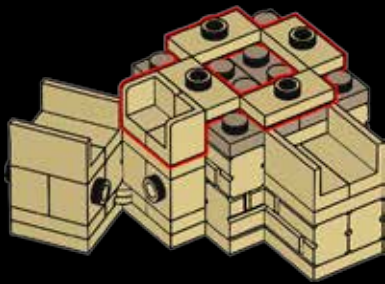

4x

92

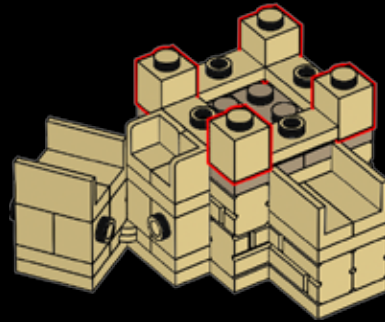



93

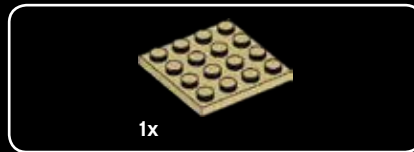
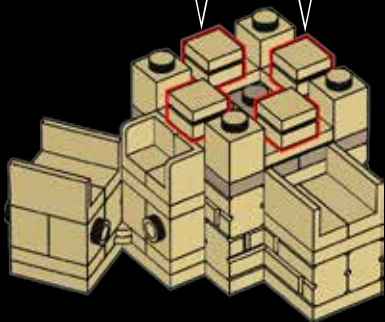
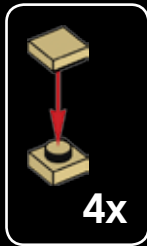

94

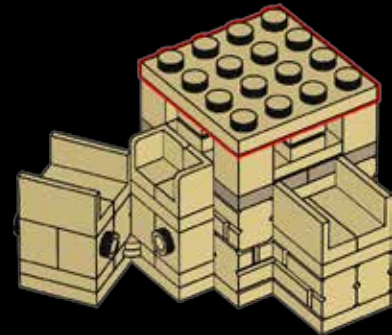



6x



1x

95

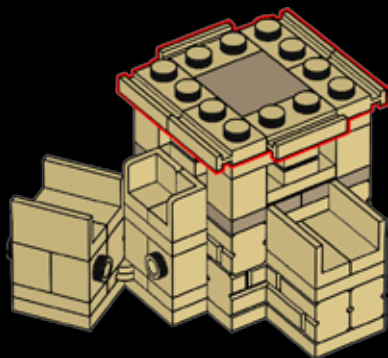

4x



4x

96

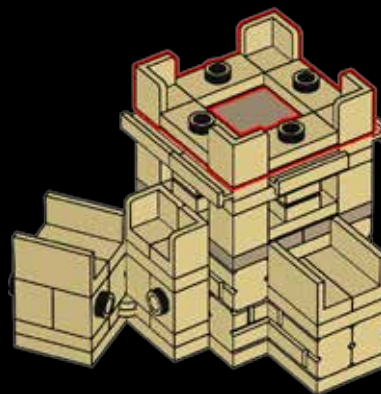



97

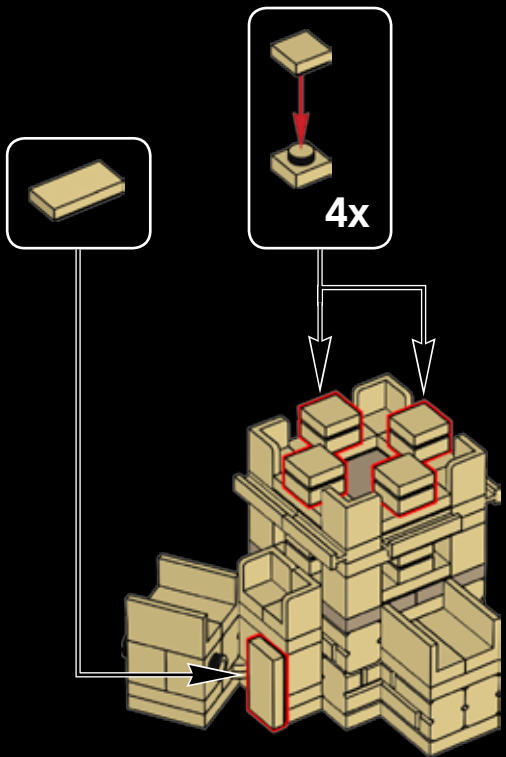

98

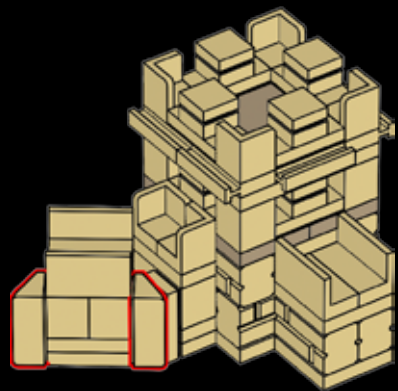

99

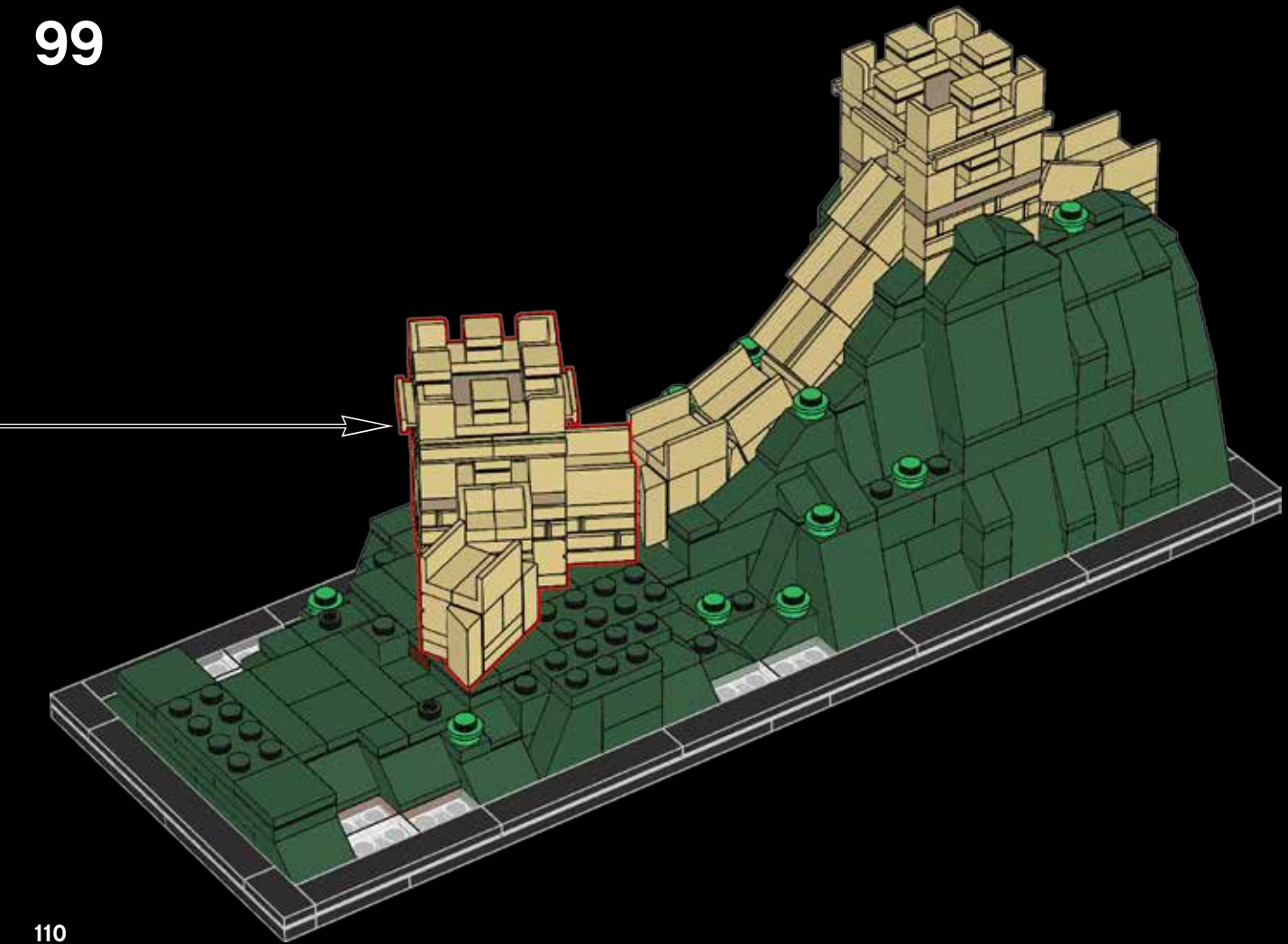

110

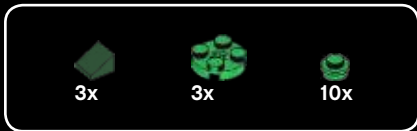

100

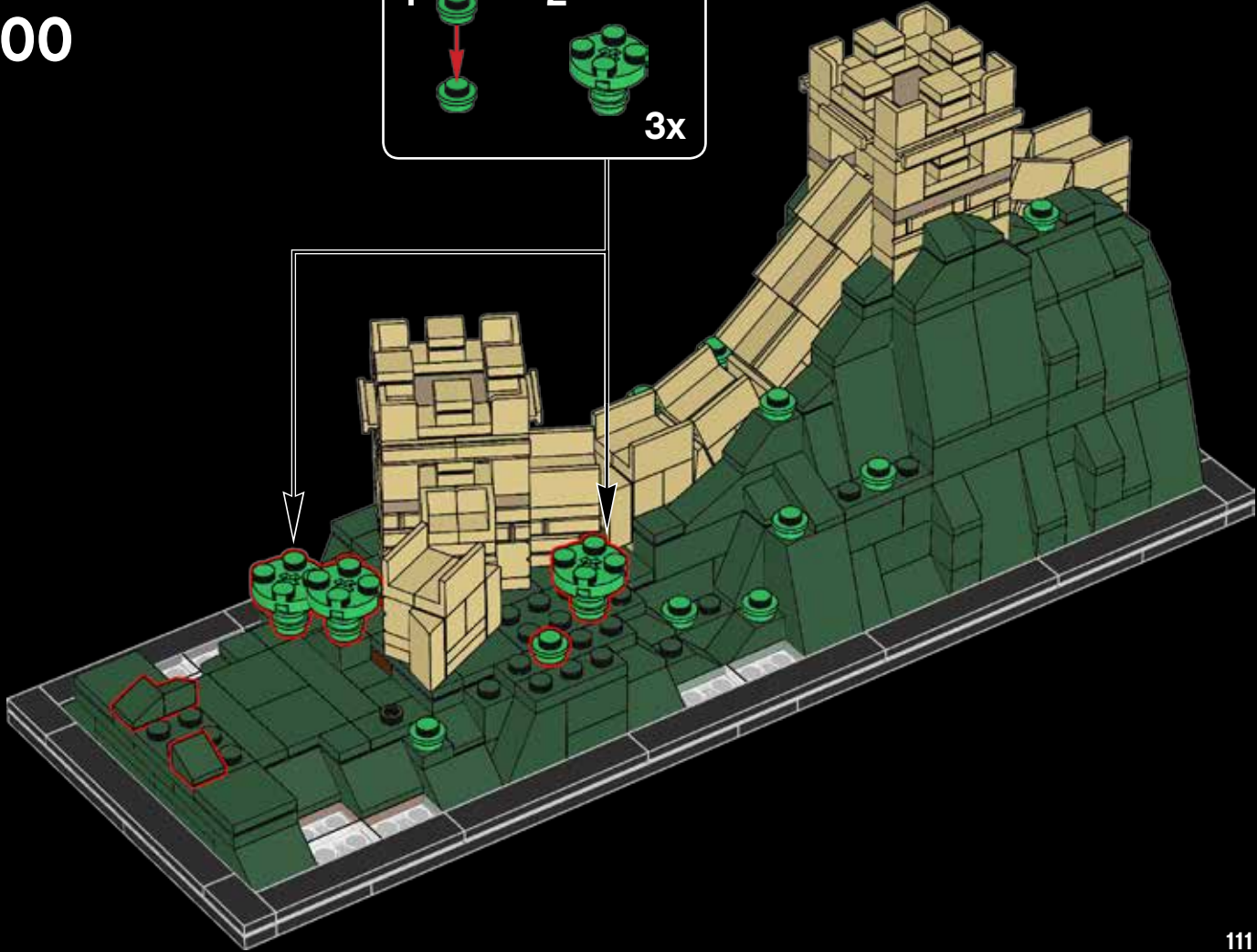
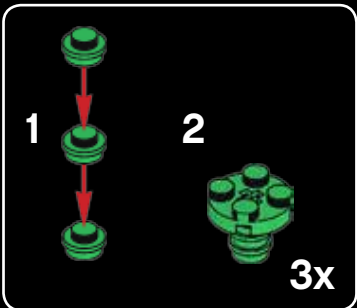



101



102

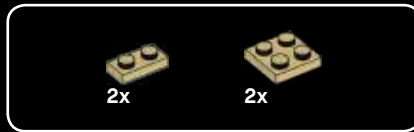

103

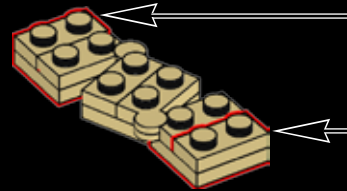
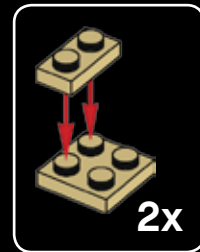

104

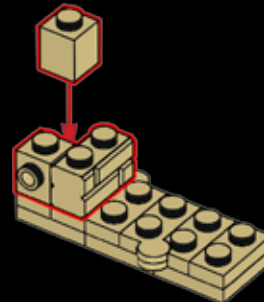



105

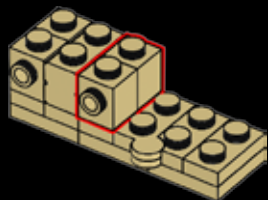

106

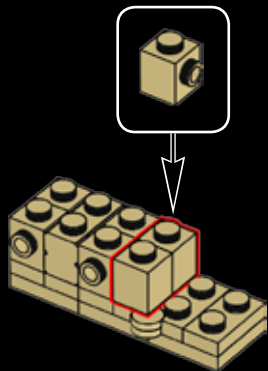

107

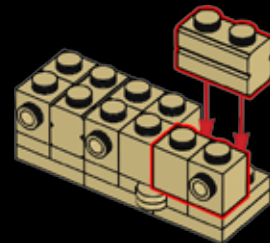

108

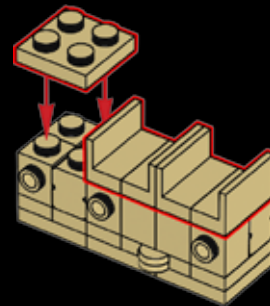



109

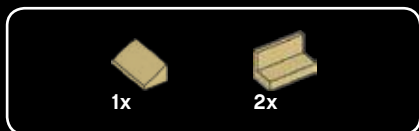
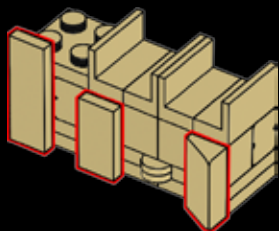

110

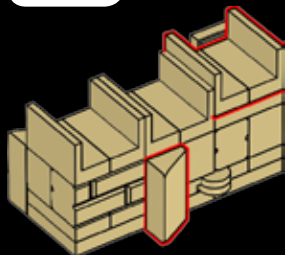

111

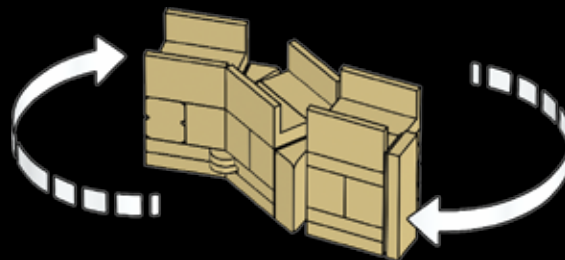

112





LEGO® Architecture – do you like it?

The LEGO Group would like your opinion on the new product you have just purchased. Your feedback will help shape the future development of this product series. Please visit:

[LEGO.com/productfeedback](https://www.lego.com/productfeedback)

By completing our short feedback survey, you will be automatically entered into a drawing to win a LEGO® prize.



Aimez-vous LEGO® Architecture ?

Le Groupe LEGO aimerait connaître votre opinion sur le produit que vous venez d'acheter. Vos commentaires nous aideront à concevoir les futurs produits de cette gamme. Veuillez visiter :

[LEGO.com/productfeedback](https://www.lego.com/productfeedback)

En remplissant ce court sondage sur le produit, vous serez automatiquement inscrit à un tirage au sort pour gagner un prix LEGO®.



LEGO® Architecture: ¿te gusta?

The LEGO Group quiere conocer tu opinión acerca del nuevo producto que acabas de comprar. Tus comentarios nos ayudarán a dar forma a los futuros productos de esta serie. Visita:

[LEGO.com/productfeedback](https://www.lego.com/productfeedback)

Al contestar este breve cuestionario de opinión, participarás automáticamente en el sorteo de un producto LEGO®.





Sujeto a términos y condiciones.

LEGO® Architecture

The LEGO® Architecture series creatively captures the essence of many of the world's most iconic landmarks while giving you an enjoyable and engaging LEGO building experience.

Whether your interest is in travel, design, history or architecture, these sets are a physical memento of great trip abroad, a famous building you know well, or a city you still dream of visiting.

Every LEGO Architecture set is designed to be displayed. Much more than just a photo, building and displaying your model on your desk, in the bookcase or on the shelf, lets you be transported every time you admire the view.

Follow us on  

Adam Reed Tucker is the co-developer of the LEGO Architecture product line.





LEGO® Architecture

La série LEGO® Architecture capture l'essence de nombreux monuments parmi les plus célèbres du monde tout en vous offrant une expérience agréable et stimulante de construction LEGO.

Que votre intérêt porte sur les voyages, le design, l'histoire ou l'architecture, ces ensembles constituent un souvenir tangible d'un voyage mémorable, d'un célèbre bâtiment que vous connaissez bien ou d'une ville que vous rêvez de visiter.

Chaque ensemble LEGO Architecture est conçu pour être exposé. Construire votre modèle et l'exposer sur votre bureau, une bibliothèque ou une tablette vous fera voyager à chaque coup d'œil, bien plus qu'une simple photo ne pourrait le faire.

Suivez-nous sur  



Adam Reed Tucker est le codéveloppeur de la gamme de produits LEGO Architecture.

LEGO® Architecture

La línea LEGO® Architecture captura con creatividad la esencia de muchos de los monumentos más populares del mundo y pone a tu alcance una experiencia de construcción gratificante y cautivadora con el sello característico de LEGO.

Ya sea que te guste viajar o sientas atracción por el diseño, la historia o la arquitectura, estos sets expresan físicamente tus recuerdos de aquel fantástico viaje al extranjero, ese famoso edificio que conoces tan bien o la ciudad que sueñas con visitar algún día.

Todos los sets LEGO Architecture están diseñados para exhibirse. Mucho más que una simple fotografía, construir y exponer un modelo en tu escritorio, un librero o una repisa te traslada a otro lugar al admirar las vistas.

Síguenos en  

Adam Reed Tucker es el codesarrollador de la línea de productos LEGO Architecture.



Celebrate the world of architecture and collect all the models
Célébrez le monde de l'architecture et collectionnez tous les modèles
Celebra el mundo de la arquitectura y colecciona todos los modelos

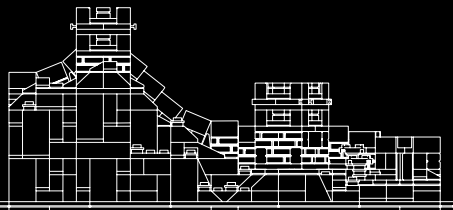

21041
Great Wall of China
La Grande Muraille de Chine
Gran Muralla China

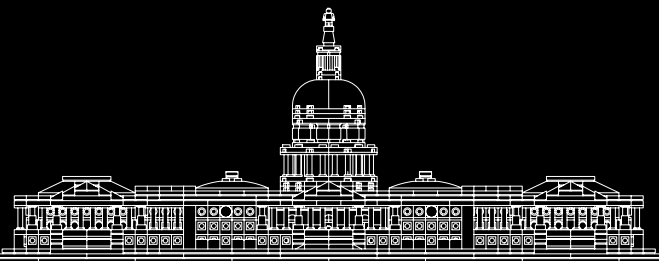

21030
United States Capitol Building
Le Capitole des États-Unis
Edificio del Capitolio de Estados Unidos

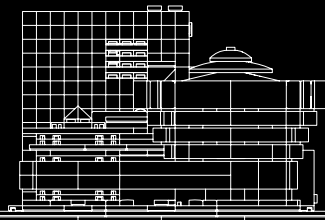

21035
Solomon R. Guggenheim Museum®
Musée Solomon R. Guggenheim®
Museo Solomon R. Guggenheim®



21042
Statue of Liberty
La statue de la Liberté
Estatua de la Libertad

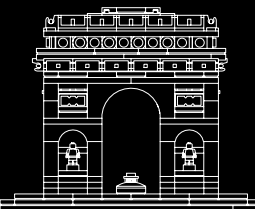

21036
Arc de Triomphe
L'Arc de Triomphe
Arco del Triunfo

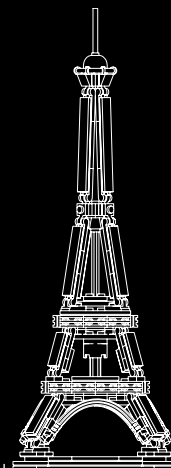

21019
The Eiffel Tower
La tour Eiffel
La Torre Eiffel

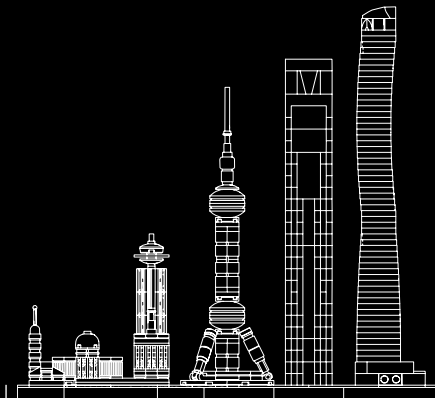

21039
Shanghai
Shanghái

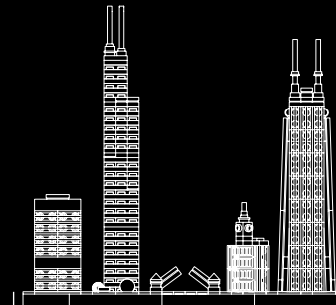

21033
Chicago

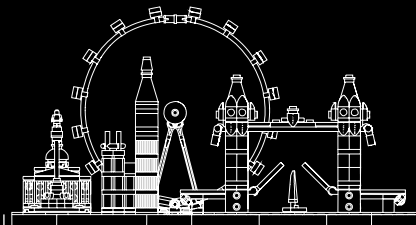

21034
London
Londres



21028
New York City
New York
Nueva York

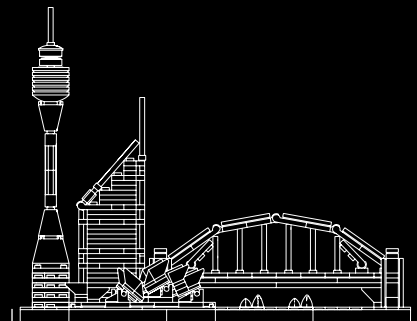

21032
Sydney
Sídney

References

Références

Referencias

*Pictures -
Photos :
Fotografias:*

© Shutterstock

© Offset

Customer Service
Kundenservice
Service Consommateurs
Servicio Al Consumidor
LEGO.com/service or dial

 00800 5346 5555 ;
 1-800-422-5346 ;

14x
4159553

14x
4125253

14x
4113915

10x
4612603

9x
4624086

21x
6148262

14x
6092587

26x
6146221

1x
6024495

4x
4114026

2x
4507045

3x
4626904

2x
4267874

8x
4579260

18x
4113917

12x
4160483

5x
4217562

10x
4114084

4x
6132769

1x
6131896

1x
4162465

1x
4118790

8x
4113916

3x
6102772

4x
6223291

2x
4243824

1x
300421

1x
306821

2x
302221

1x
302121

3x
302021

4x
306926

4x
4556158

4x
4283047

4x
4283046

1x
6226753

1x
6226753

1x
6226753

2x
6171814

2x
302024

1x
6240515

8x
663626

3x
416226

1x
6223318

2x
300826

1x
244526

4x
302826

4x
302826

4x
302826

10x
4569297

25x
4569058

3x
403228

5x
4521915

8x
6055171

21x
4504375

19x
6003331

22x
4245570

2x
6192250

30x
4255624

10x
4528778

13x
6226384

15x
6223304

9x
6214611

7x
6013975

4x
6168573

4x
4650622

10x
4650244

12x
4245571

3x
4543949

5x
6020923

3x
4586057

2x
4260493

2x
6215657

7x
4211150

6x
4211201

2x
4211193

2x
4217848

9x
4181142

1x
6039479

1x
6043656

4x
4211388

5x
4211397

2x
4211353

3x
4211396

5x
4211522

