



Booklet available in English on
Livret disponible en français sur
Folleto disponible en español en







THE GREAT PYRAMID OF GIZA

◆ The Great Pyramid of Giza is the defining symbol of ancient Egypt and one of the most iconic architectural structures in the world. Much of the story of how and why these 2.3 million blocks of stone were brought together remains a mystery, even after 140 years of modern archaeological excavations. Believed to have been built as a tomb for Khufu, a pharaoh of the Fourth Dynasty, the 481 ft. (146.5m) tall pyramid took 27 years to construct and would remain the tallest man-made structure in the world for over 3,800 years. This LEGO® Architecture set is a celebration of this extraordinary feat of engineering and architecture and attempts to capture a moment in time when ancient Egyptian civilization was at its pinnacle and the Great Pyramid was nearing completion.

LA PYRAMIDE DE KHÉOPS

◆ La pyramide de Khéops est le plus grand symbole de l'Égypte ancienne et l'une des structures architecturales les plus emblématiques du monde. La façon dont ces 2,3 millions de blocs de pierre ont été assemblés et la raison pour laquelle ils l'ont été demeurent en grande partie un mystère, même après 140 ans de fouilles archéologiques modernes. On croit que la pyramide a été construite pour servir de tombeau à Khéops, un pharaon de la quatrième dynastie. Il a fallu 27 ans pour construire cette pyramide de 146,5 m de haut, qui est restée la plus haute structure artificielle au monde pendant plus de 3 800 ans. Cet ensemble LEGO® Architecture célèbre cet extraordinaire exploit d'ingénierie et d'architecture et vise à immortaliser un moment où la civilisation égyptienne antique était à son apogée, et où la pyramide de Khéops était sur le point d'être achevée.

LA GRAN PIRÁMIDE DE GUIZA

◆ La Gran Pirámide de Guiza es el símbolo que mejor define el carácter del Antiguo Egipto y una de las estructuras arquitectónicas más emblemáticas del mundo. Una gran parte de la historia que explicaría cómo y por qué se reunieron estos 2,3 millones de bloques de piedra sigue siendo un misterio, incluso después de 140 años de excavaciones arqueológicas en la era moderna. La pirámide, que se cree que fue construida para servir como tumba dedicada a Keops, un faraón de la Cuarta Dinastía, mide 146,5 m de altura, y su construcción duró 27 años. Durante más de 3800 años, fue la estructura más alta construida por el hombre. Este set LEGO® Architecture celebra una de las hazañas de ingeniería y arquitectura más extraordinarias e intenta capturar un momento en el tiempo cuando la antigua civilización egipcia estaba en su apogeo y la construcción de la Gran Pirámide estaba a punto de llegar a su fin.

ANDERSON WARD GRUBB

Senior Designer at the LEGO Group
Concepteur principal chez le Groupe LEGO
Diseñador sénior de The LEGO Group

FROM THE DESIGN TEAM

◆ Ancient Egypt has always been a fascination of mine, so having the chance to travel back and imagine the Great Pyramid as it might have been in its own time was a pleasure. It was particularly interesting to recreate both a completed Pyramid and another below that is still under construction. It's an unusual feature for a LEGO® Architecture model to be able show how a structure may have been built. This part of the model can also be lifted away from the main model and displayed separately if you wish.

UN MOT DE L'ÉQUIPE DE CONCEPTION

◆ L'Égypte ancienne m'a toujours fasciné, et je suis ravi d'avoir eu la chance de retourner dans le passé et d'imaginer la pyramide telle qu'elle aurait pu être à son époque. Il était particulièrement intéressant de recréer à la fois une pyramide achevée et une autre en dessous qui est toujours en construction. Montrer comment une structure a pu être construite est une caractéristique inhabituelle pour un modèle LEGO® Architecture. Cette partie du modèle peut également être retirée du modèle principal et exposée séparément si vous le désirez.

IMPRESIONES DEL EQUIPO DE DISEÑO

◆ Siempre he sentido una gran fascinación por el Antiguo Egipto, por lo que remontarme a la época de mayor gloria de la Gran Pirámide para imaginar cómo podría haberse visto fue una experiencia muy gratificante. Algo particularmente interesante es que se recreó tanto una pirámide terminada como otra aún en construcción por debajo de la primera. Si bien es una característica inusual para un modelo LEGO® Architecture, sirve para mostrar cómo puede haberse construido la estructura. Puedes separar esta parte del modelo principal y exhibirla por separado si así lo deseas.

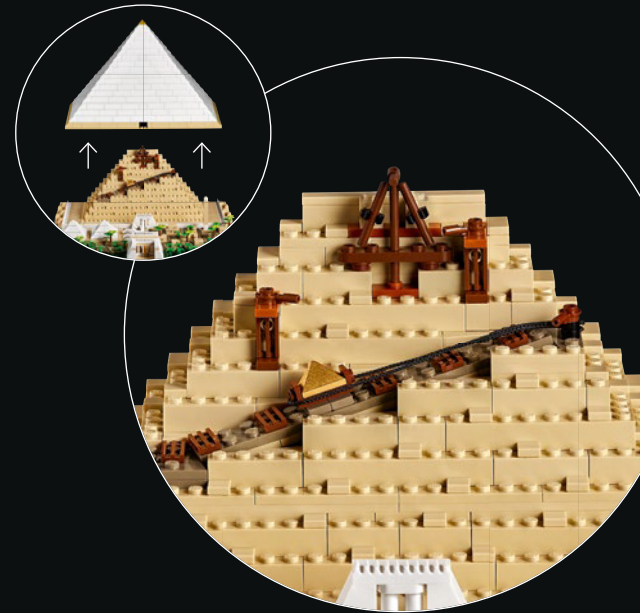

HOW THE PYRAMID WAS CONSTRUCTED

There are many theories on how the pyramid was constructed. Remove the outer shell to see ramps, ropes and sledges being used to move the massive stone blocks, plus a crane to lift smaller materials.

COMMENT LA PYRAMIDE A ÉTÉ CONSTRUITE

Il existe de nombreuses théories sur la façon dont la pyramide a été construite. Retirez le parement pour voir les rampes, les cordes et les traîneaux utilisés pour déplacer les énormes blocs de pierre, ainsi qu'une grue permettant de soulever les matériaux plus petits.

CÓMO SE CONSTRUYÓ LA PIRÁMIDE

Existen muchas teorías sobre cómo se construyó la pirámide. Si retiras la cubierta exterior, verás los enormes bloques de piedra siendo transportados mediante rampas, cuerdas y trineos. También hay una grúa para levantar materiales más pequeños.



FEATURES OF THE PYRAMID CARACTÉRISTIQUES DE LA PYRAMIDE CARACTERÍSTICAS DE LA PIRÁMIDE



OUTER CASING

The outer shell of the pyramid was made from white limestone, polished smooth.

LE PAREMENT EXTÉRIEUR

Le parement extérieur de la pyramide était fait de pierre calcaire blanche, polie et lisse.

EL REVESTIMIENTO EXTERIOR

La pirámide estaba revestida de piedra caliza blanca pulida.



THE SMALLER PYRAMIDS

Here are two of the four smaller pyramids, which likely were tombs for Khufu's family. Three remain intact today.

LES PYRAMIDES PLUS PETITES

Voici deux des quatre plus petites pyramides, qui servaient probablement de tombes à la famille de Khéops. Trois d'entre elles sont encore intactes.

LAS PIRÁMIDES MÁS PEQUEÑAS

Estas son dos de las cuatro pirámides más pequeñas, que probablemente sirvieron como tumbas para los familiares de Keops. Tres de ellas permanecen en pie en la actualidad.

◆ INSIDE

A sloping corridor descends through the Pyramid's interior and branches off to the Queen's Chamber and Grand Gallery. A narrow passageway at the end of the Gallery gives access to the King's Chamber. Two air shafts lead away from the chamber, perhaps to allow the Pharaoh's ka (spirit) to travel to the afterlife.

◆ L'INTÉRIEUR

Un couloir en pente descend à l'intérieur de la pyramide et bifurque vers la chambre de la reine et la grande galerie. Un étroit passage à l'extrémité de la galerie donne accès à la chambre du roi. Deux conduits de ventilation partent de la chambre, peut-être pour permettre au ka (esprit) du pharaon de rejoindre l'au-delà.

◆ EL INTERIOR

Un pasillo inclinado desciende por dentro de la pirámide y se ramifica hasta llegar a la Cámara de la Reina y la Gran Galería, en cuyo extremo se encuentra un estrecho pasadizo que conduce a la Cámara del Rey. De este espacio salen dos conductos de aire que quizá se hayan colocado con el fin de permitir que el ka (espíritu) del faraón viajara al más allá.



THE CAPSTONE

It is believed the Great Pyramid had a capstone covered in gold to make it shine brilliantly in the sun.

LE PYRAMIDION

On croit que la pyramide de Khéops était surmontée d'un pyramidion recouvert d'or pour qu'il brille au soleil.

EL PIRAMIDÓN

Muchos concuerdan en que la Gran Pirámide estaba rematada por un piramidón recubierto de oro con el fin de que reflejara intensamente el brillo del sol.



THE SPHINXES

Carvings of Sphinxes may have lined the main approach to the Pyramid..

LES SPHINX

Des sculptures de sphinx ont peut-être bordé les abords principaux de la pyramide.

LAS ESFINGES

La vía de acceso principal a la pirámide puede haber estado bordeada por esfinges talladas.

THE HIEROGLYPH NAME PLATE

These hieroglyphs show the Great Pyramid's ancient name, 'Khufu's Horizon.'

LA PLAQUE DE NOM EN HIÉROGLYPHES

Ces hiéroglyphes montrent l'ancien nom de la pyramide de Khéops, « l'horizon de Khéops ».

LA PLACA DE IDENTIFICACIÓN CON JEROGLÍFICOS

Los jeroglíficos muestran el antiguo nombre de la Gran Pirámide: Horizonte de Keops.

THE VALLEY TEMPLE

The Valley Temple on the edge of the Nile was where the body of the Pharaoh was received before burial in the Pyramid.

LE TEMPLE DE LA VALLÉE

Le temple de la vallée, au bord du Nil, est le lieu où le corps du pharaon a été déposé avant d'être enterré dans la pyramide.

EL TEMPLO DEL VALLE

Ubicado en la orilla del Nilo, el Templo del Valle fue donde se recibió el cuerpo del faraón antes de darle sepultura en la pirámide.

THE OBELISK

Obelisks were likely invented about 150 years after the Great Pyramid was built. One is included here to acknowledge their broader importance in ancient Egypt.

L'OBÉLISQUE

Les obélisques ont probablement été inventés environ 150 ans après la construction de la pyramide de Khéops. Nous en avons inclus un ici pour souligner leur importance majeure dans l'Égypte ancienne.

EL OBELISCO

Probablemente, los obeliscos se inventaron unos 150 años después de que se construyera la Gran Pirámide. Incluimos uno aquí en reconocimiento a su enorme importancia en el Antiguo Egipto.

WORKERS' VILLAGE

Whole villages would be built to house the artisans and laborers working on the Pyramid.

LE VILLAGE DES OUVRIERS

Des villages entiers ont été construits pour loger les artisans et les ouvriers travaillant sur la pyramide.

LA ALDEA DE LOS OBREROS

Se construían aldeas enteras para albergar a los artesanos y trabajadores que laboraban en la Pirámide.

THE FELUCCA

These ancient boats, which typically had a singular triangular sail, ferried people and goods up and down the Nile.

LA FELOUQUE

Ces bateaux anciens, qui avaient généralement une voile triangulaire singulière, assuraient le transport des personnes et des marchandises sur le Nil.

EL FALUCHO

Estas embarcaciones ancestrales, normalmente equipadas con una sola vela triangular, transportaban personas y mercancías a lo largo del Nilo.

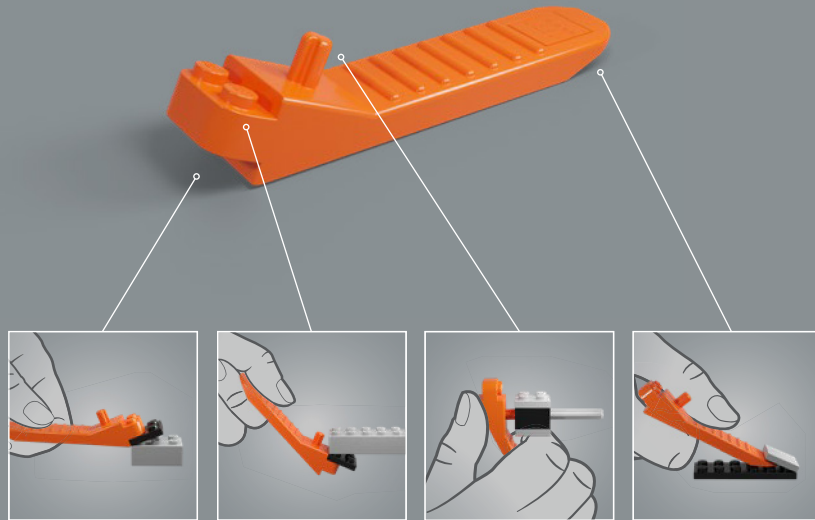

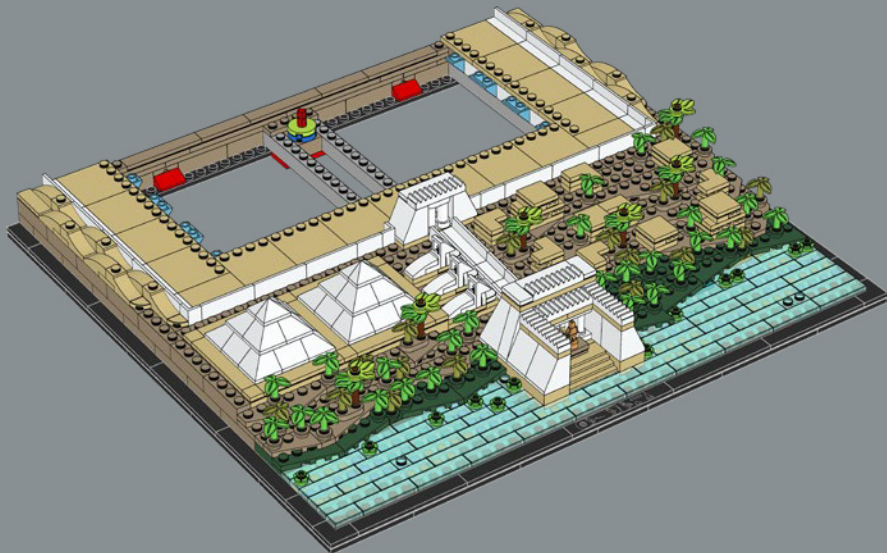

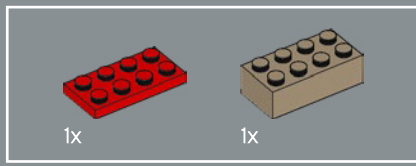

1

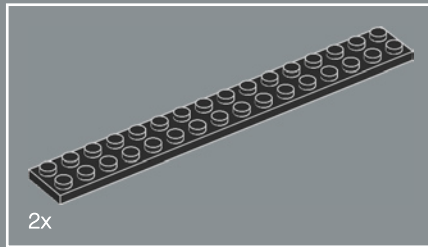
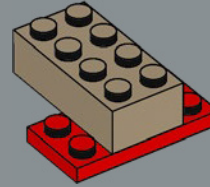

2

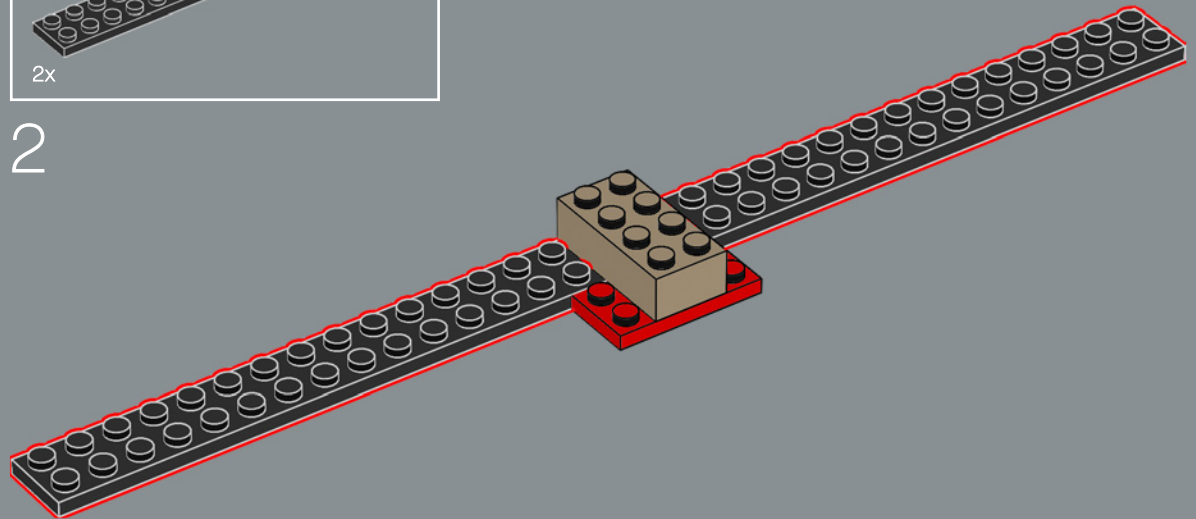

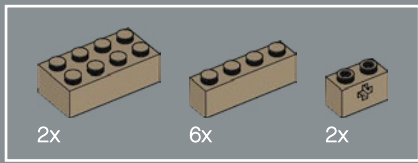

3

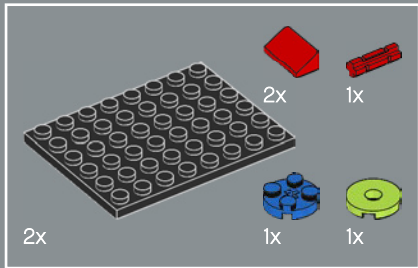
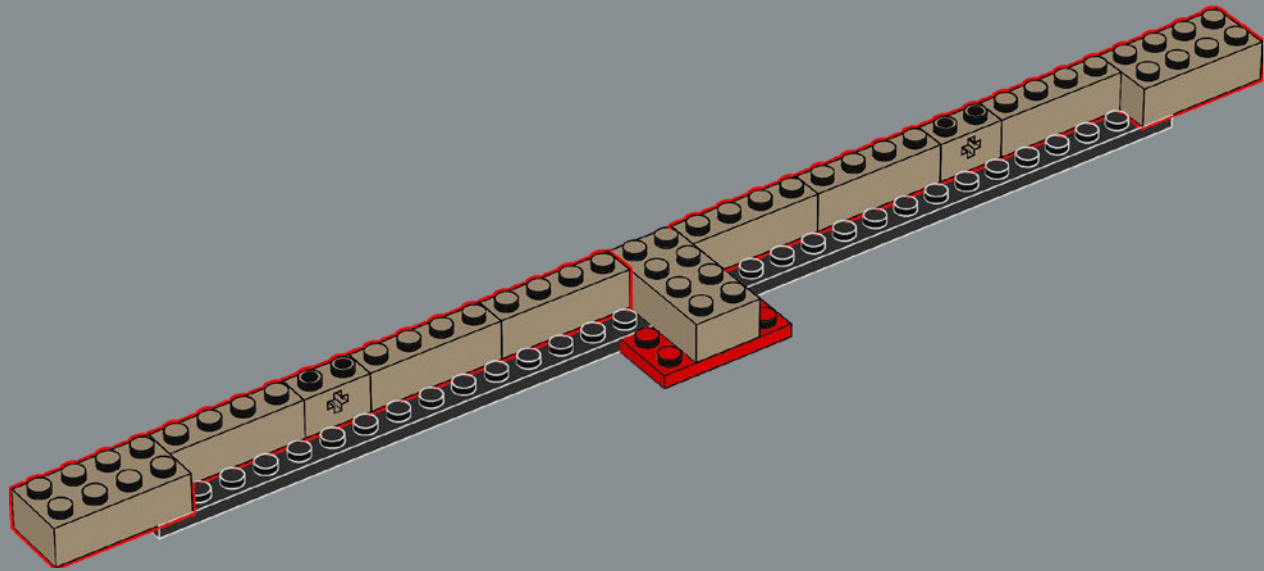

4

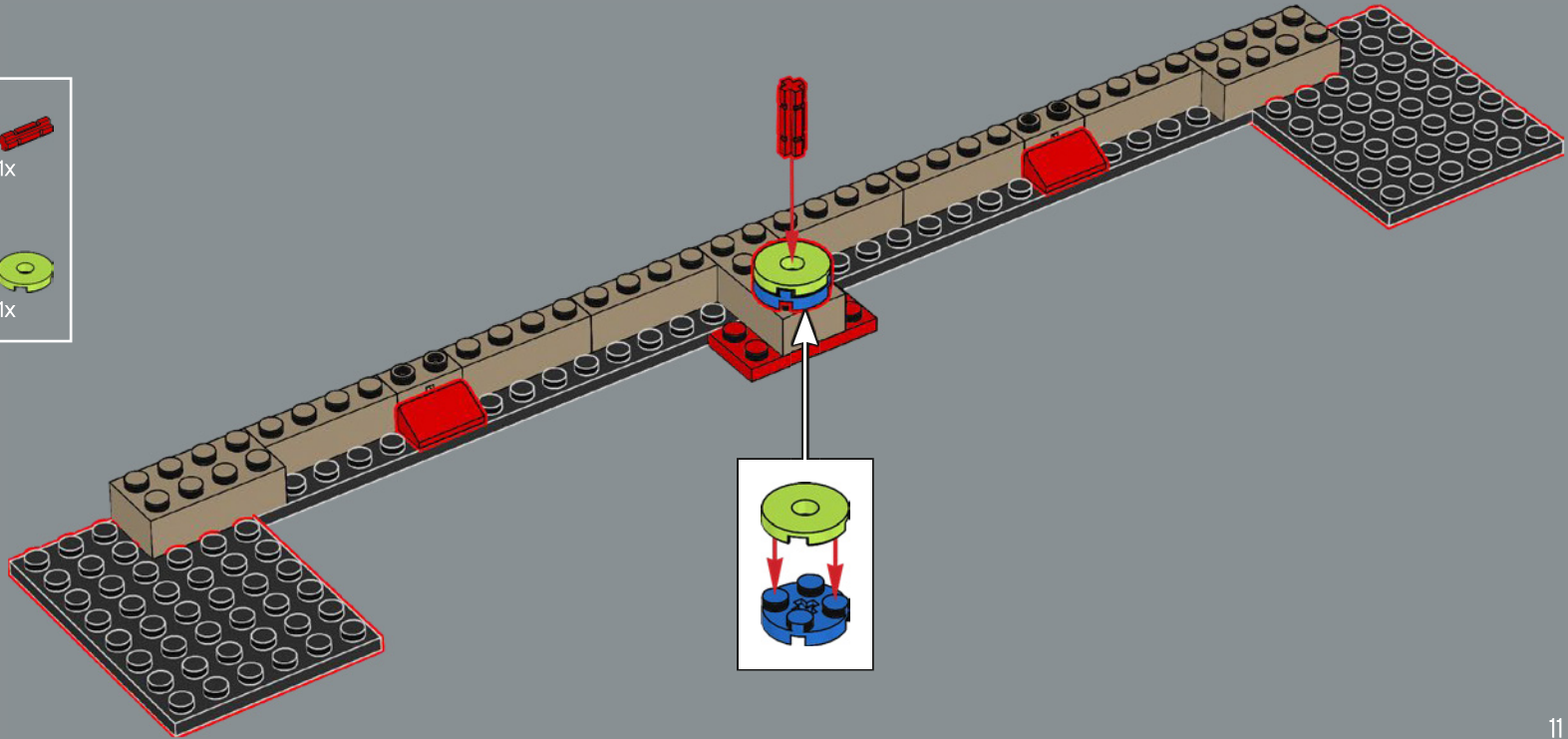

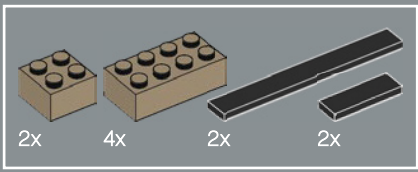

5

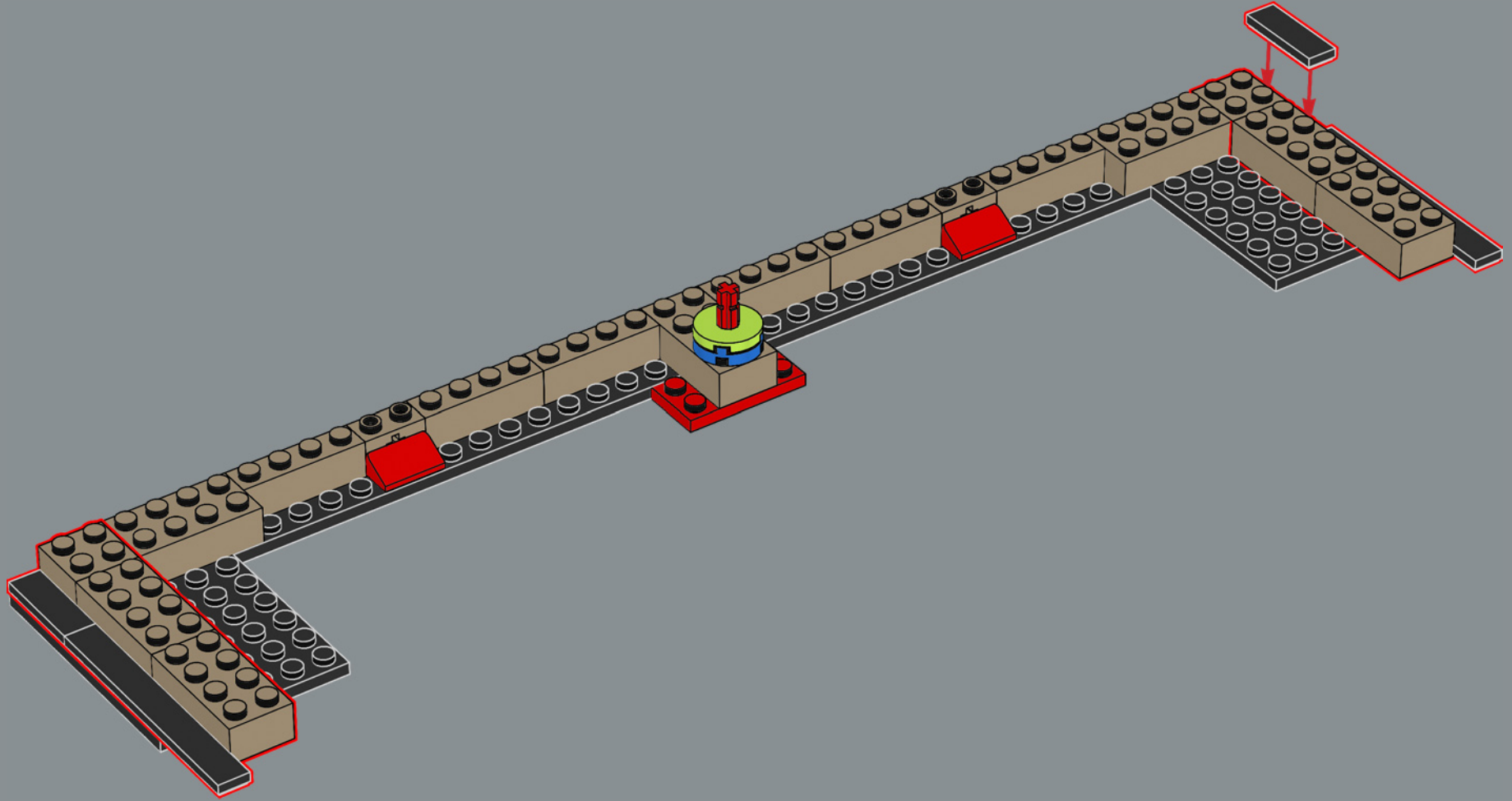

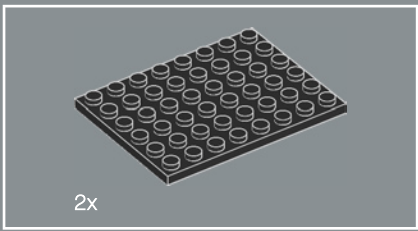

6

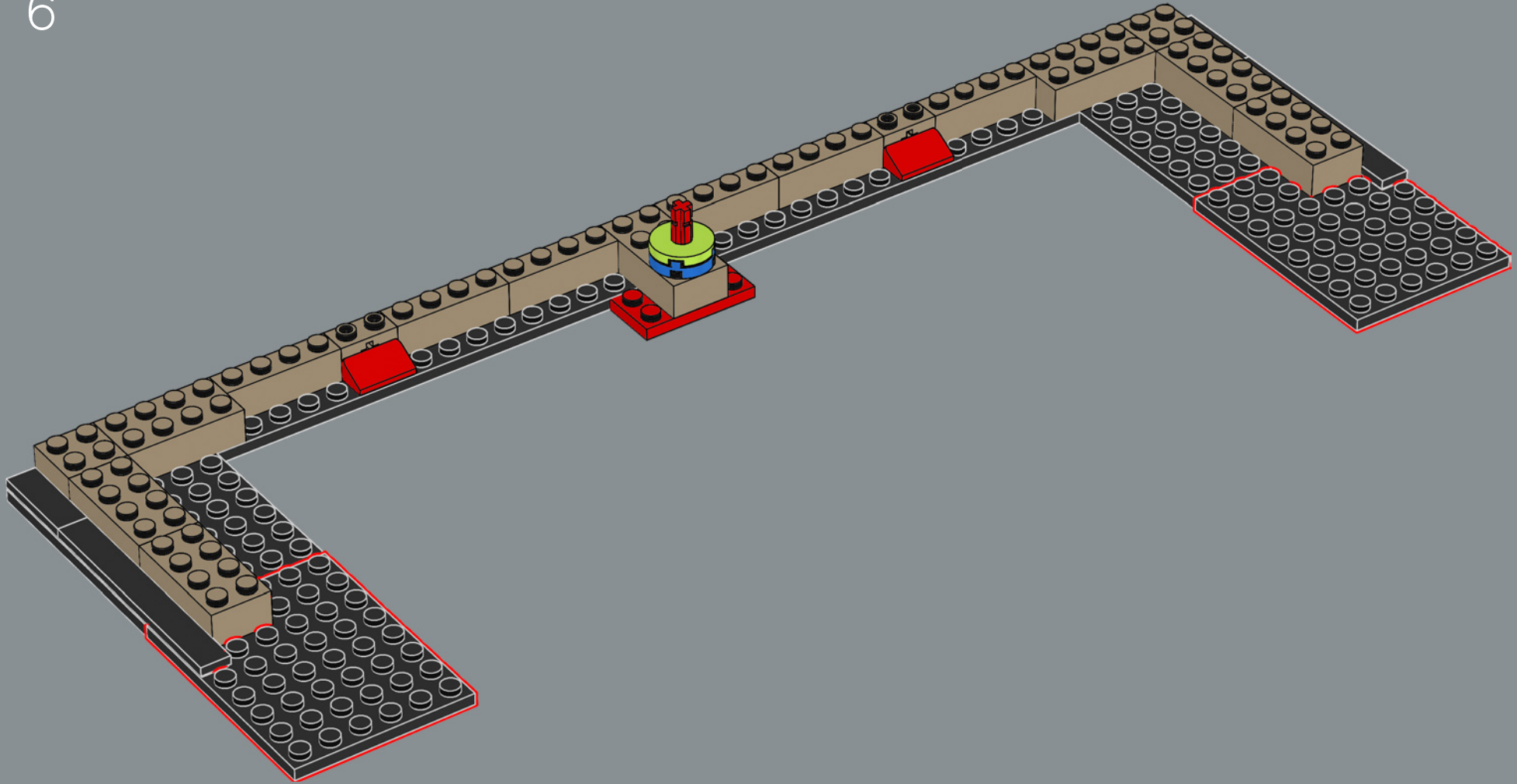

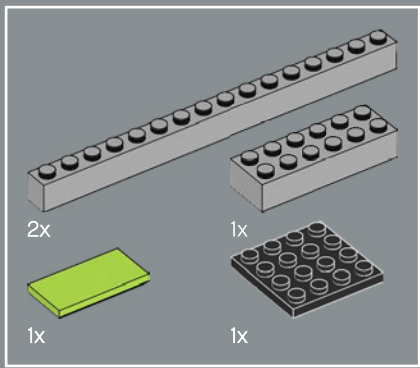

7

1

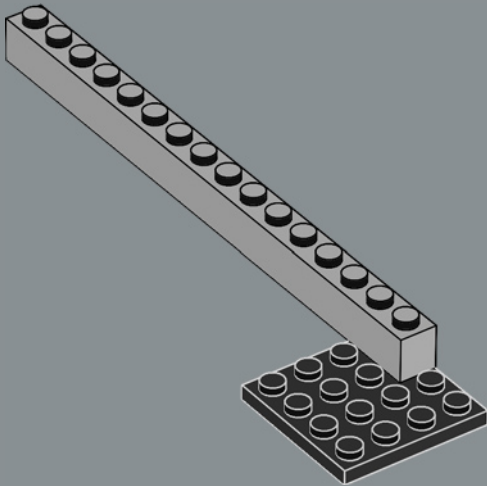

2

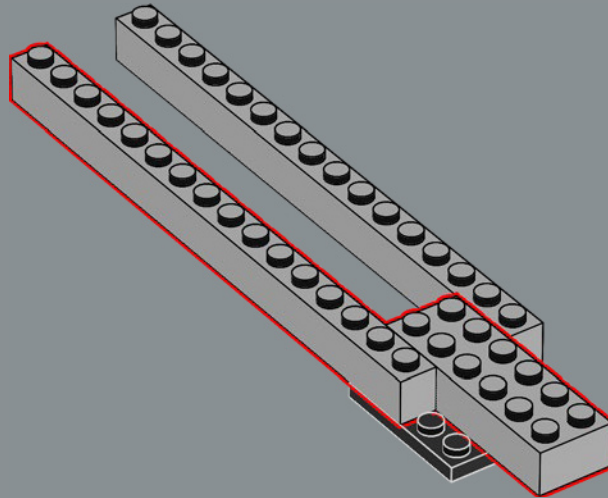

3

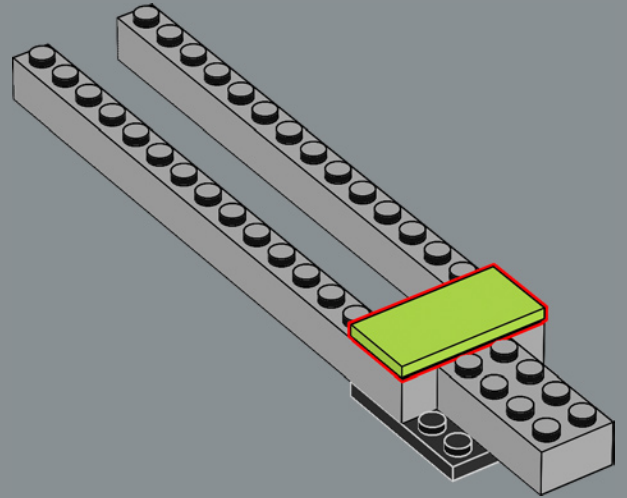

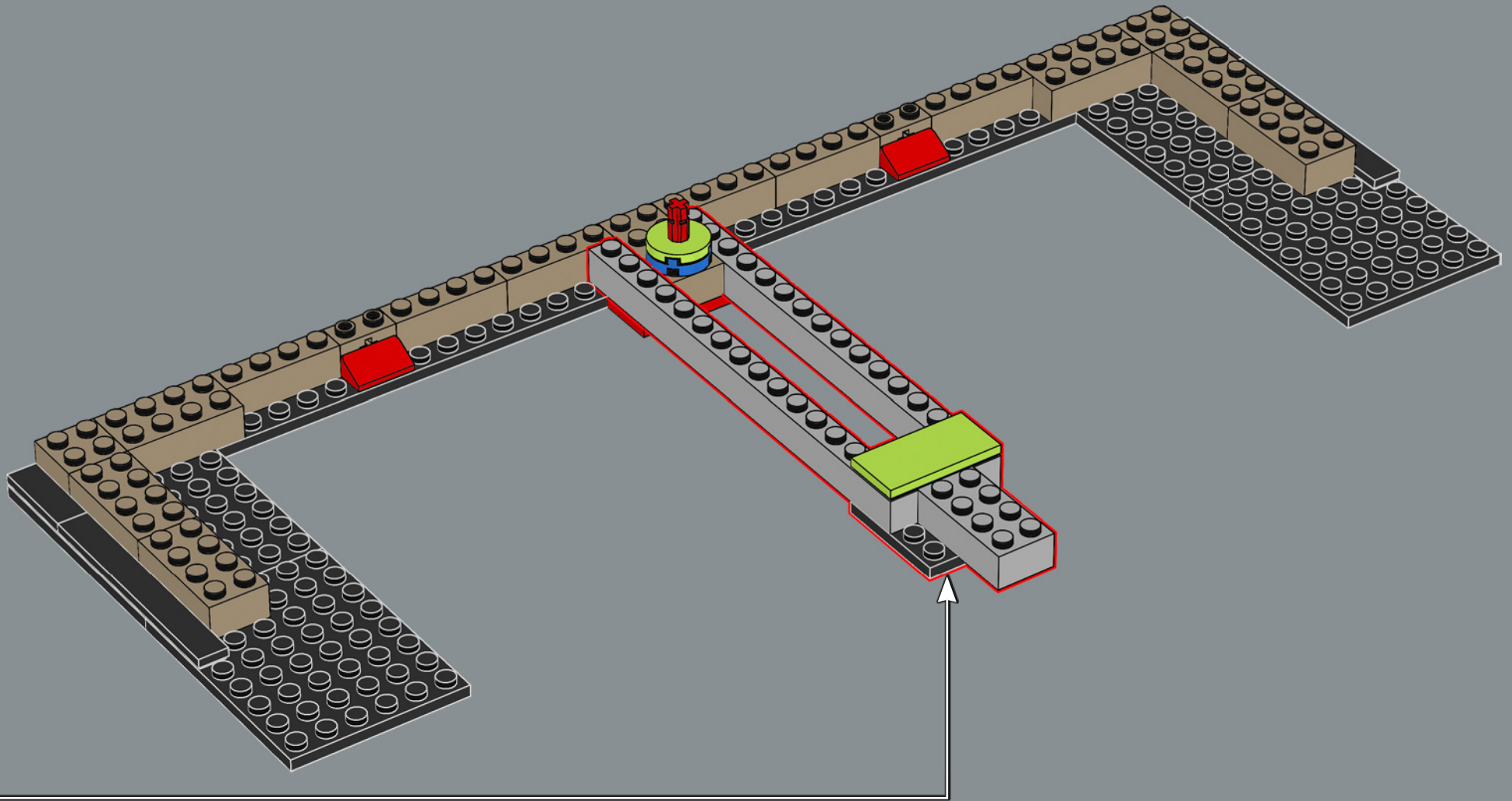

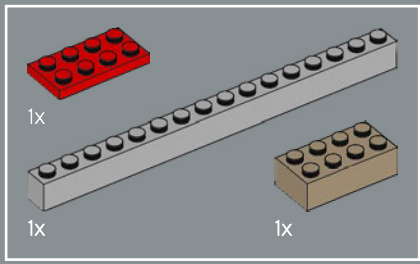

8

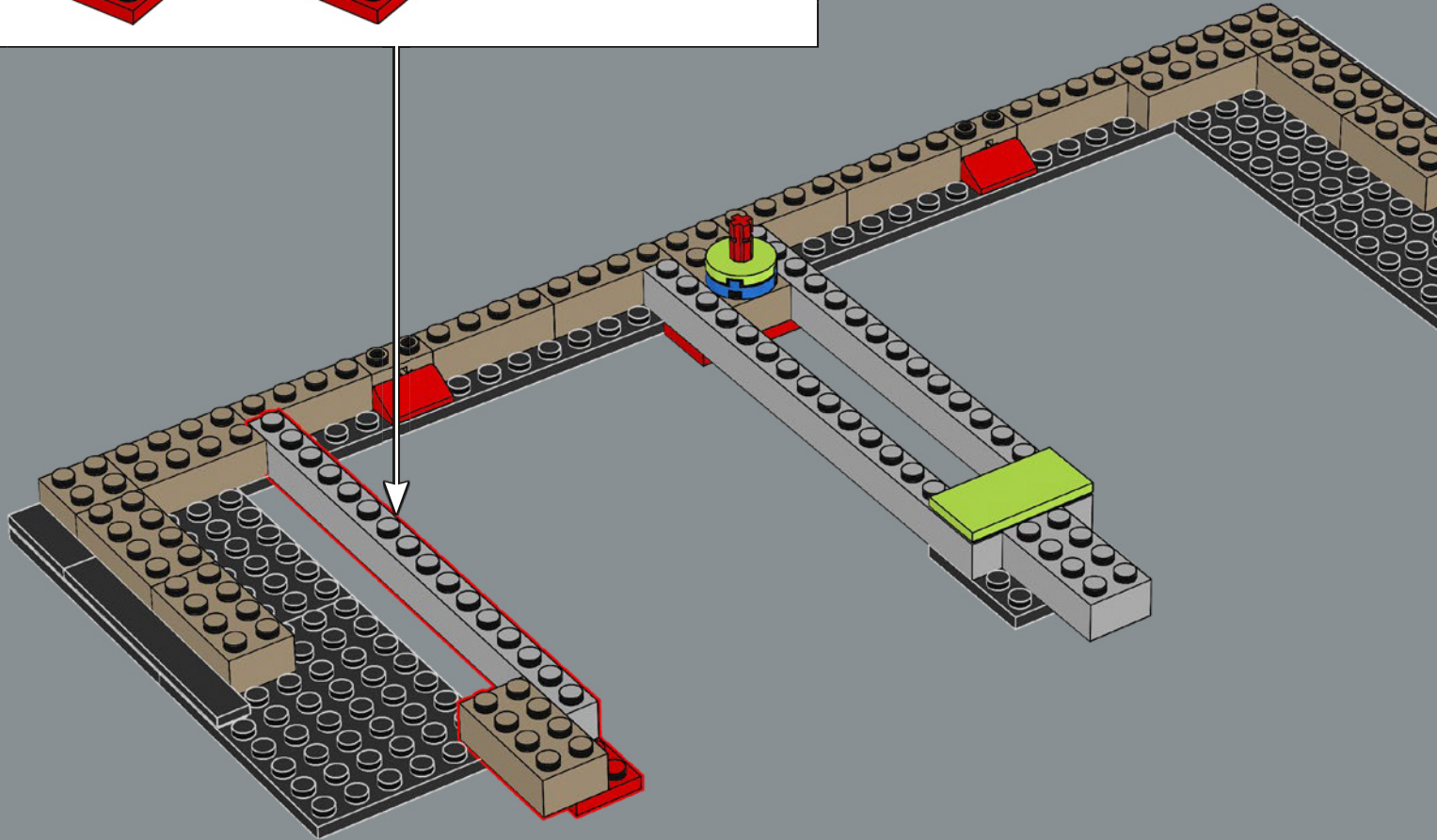
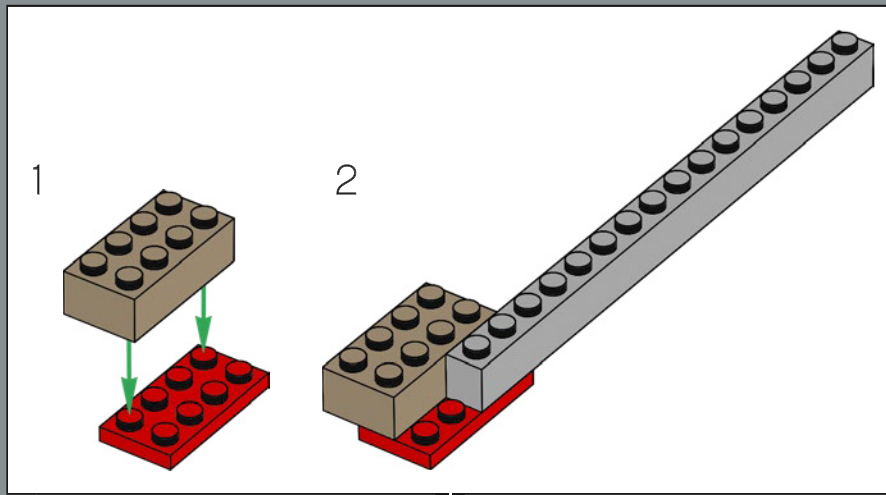

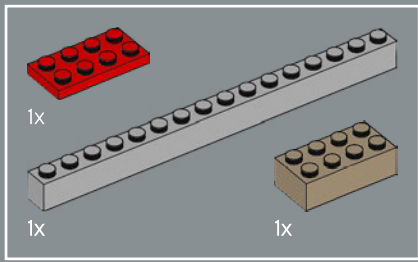

9

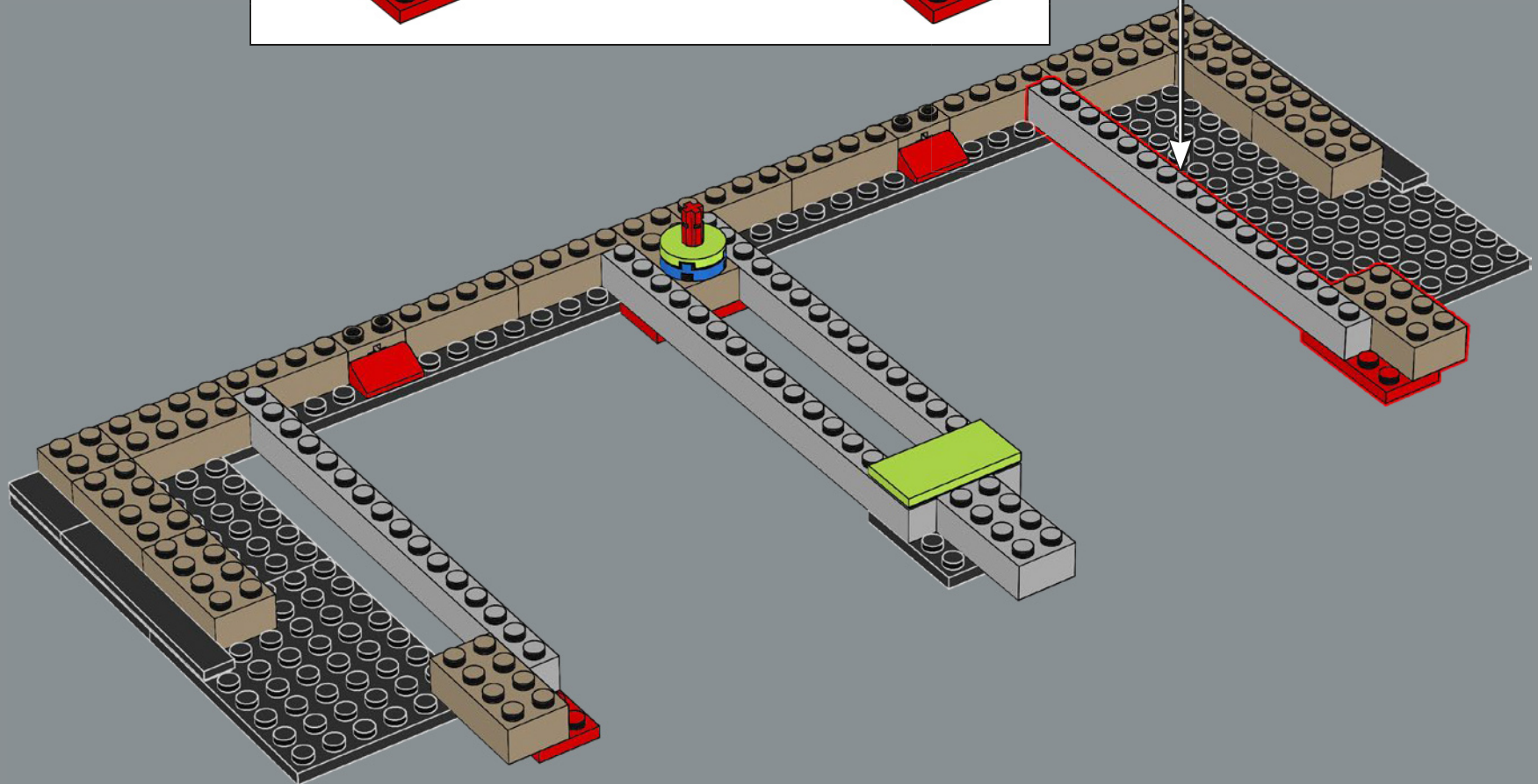
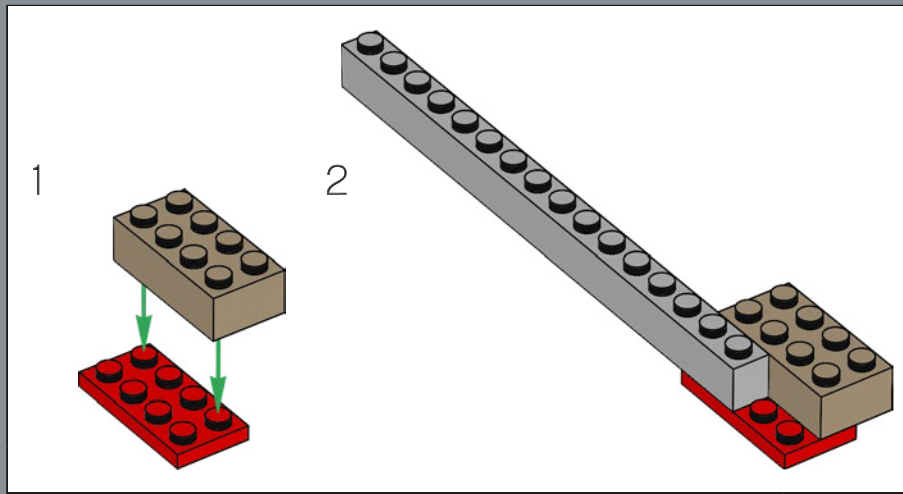

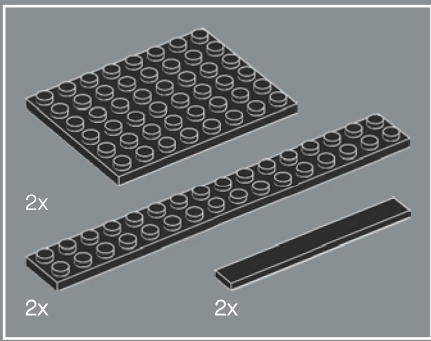

10

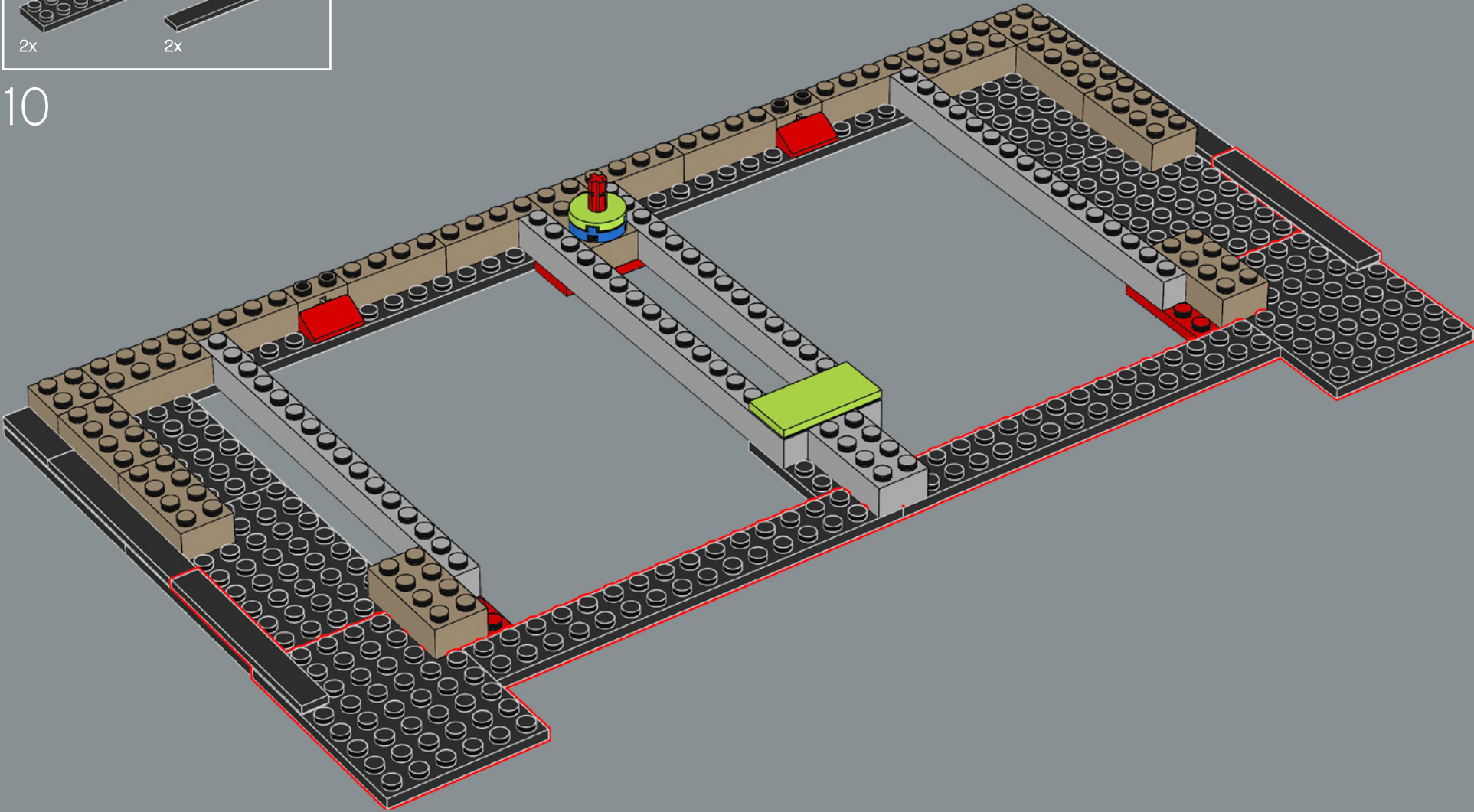

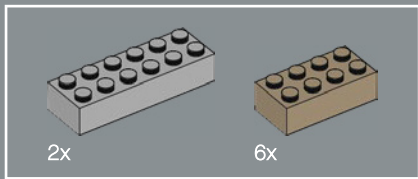

11

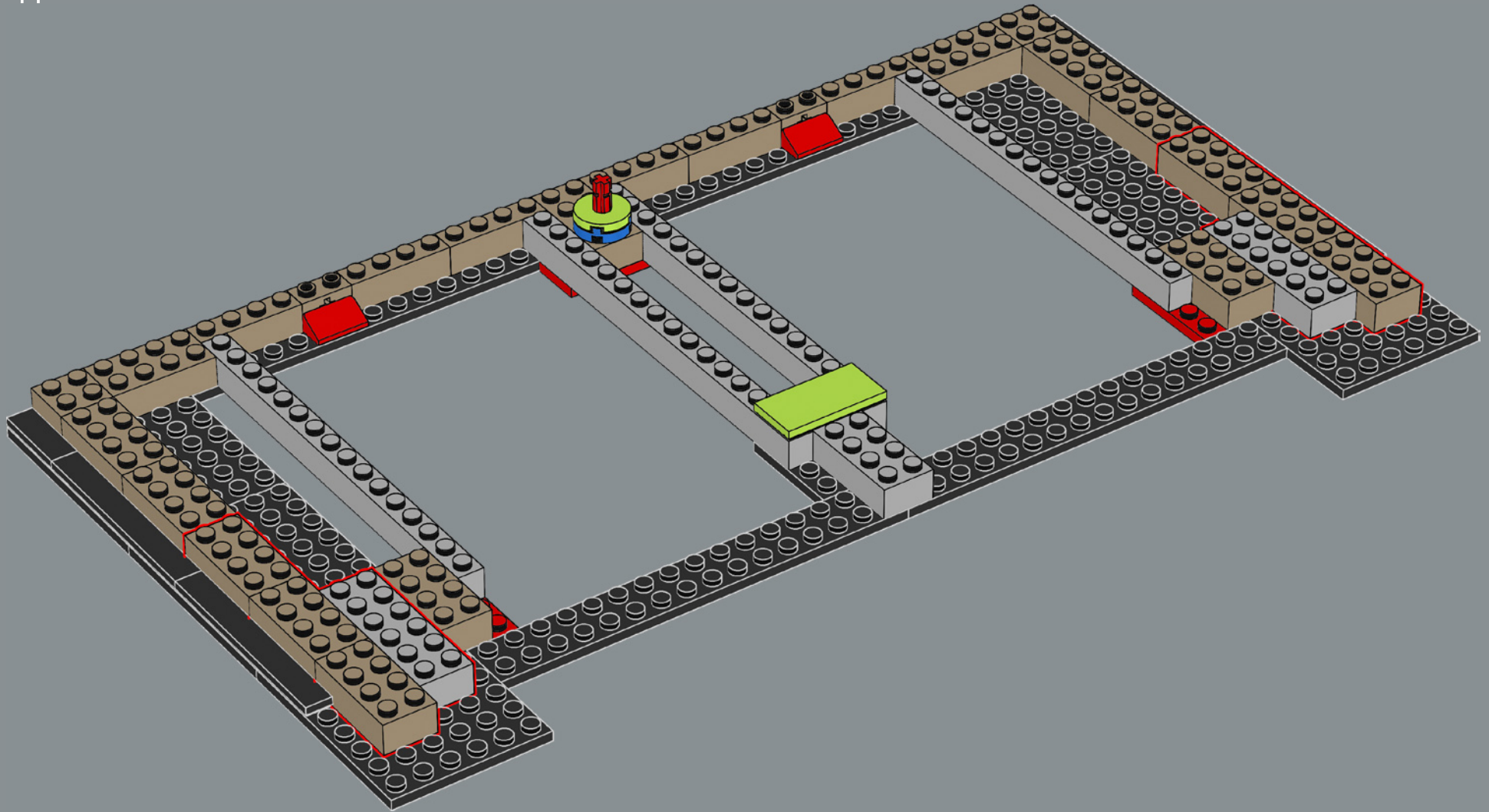

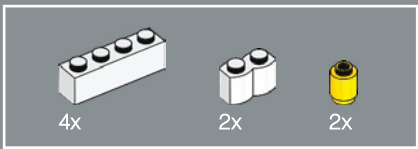

12

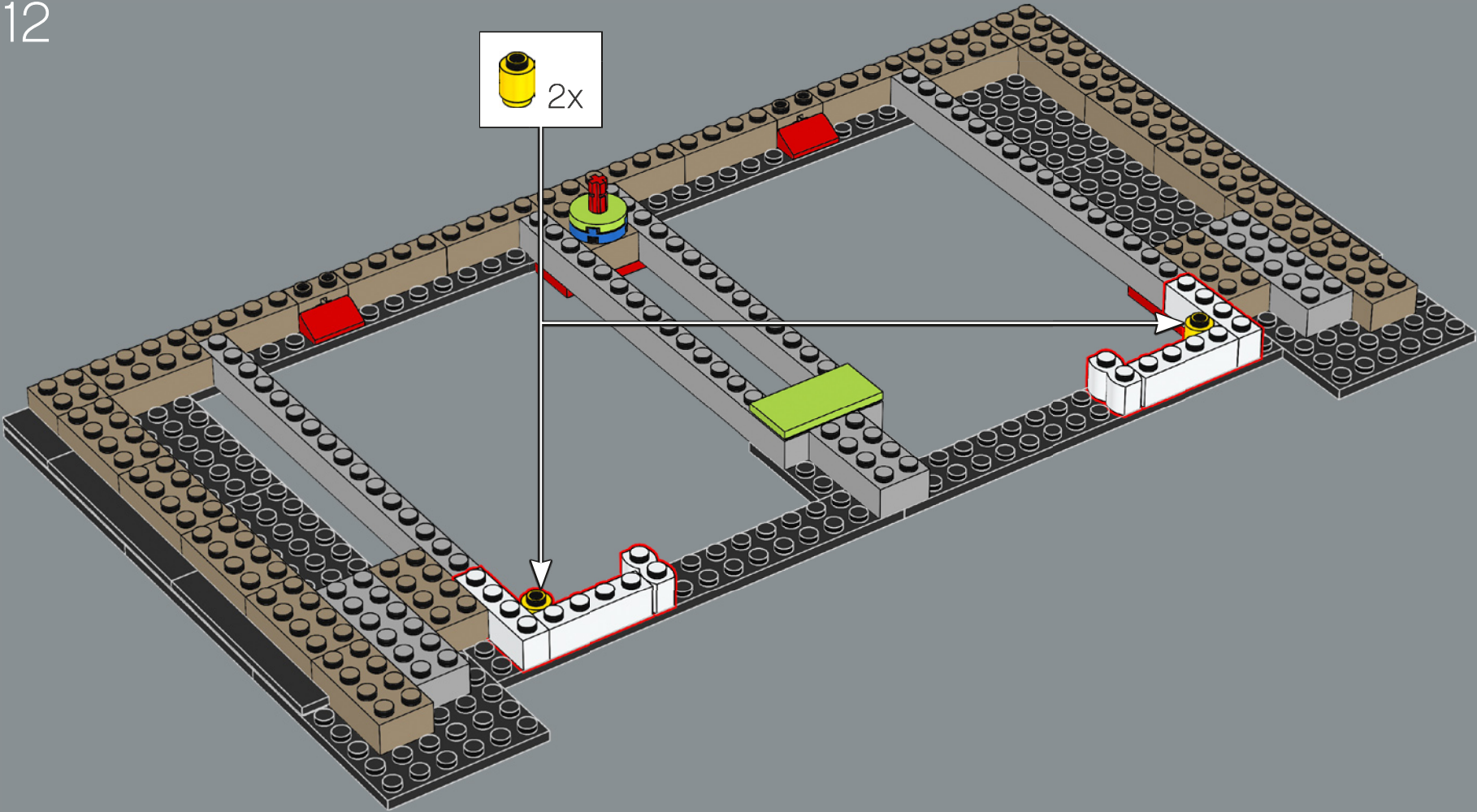

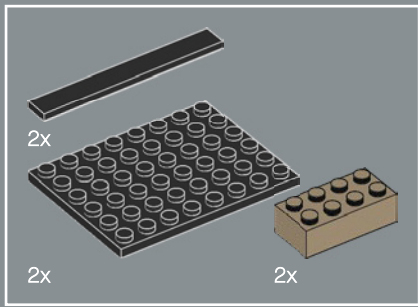

13

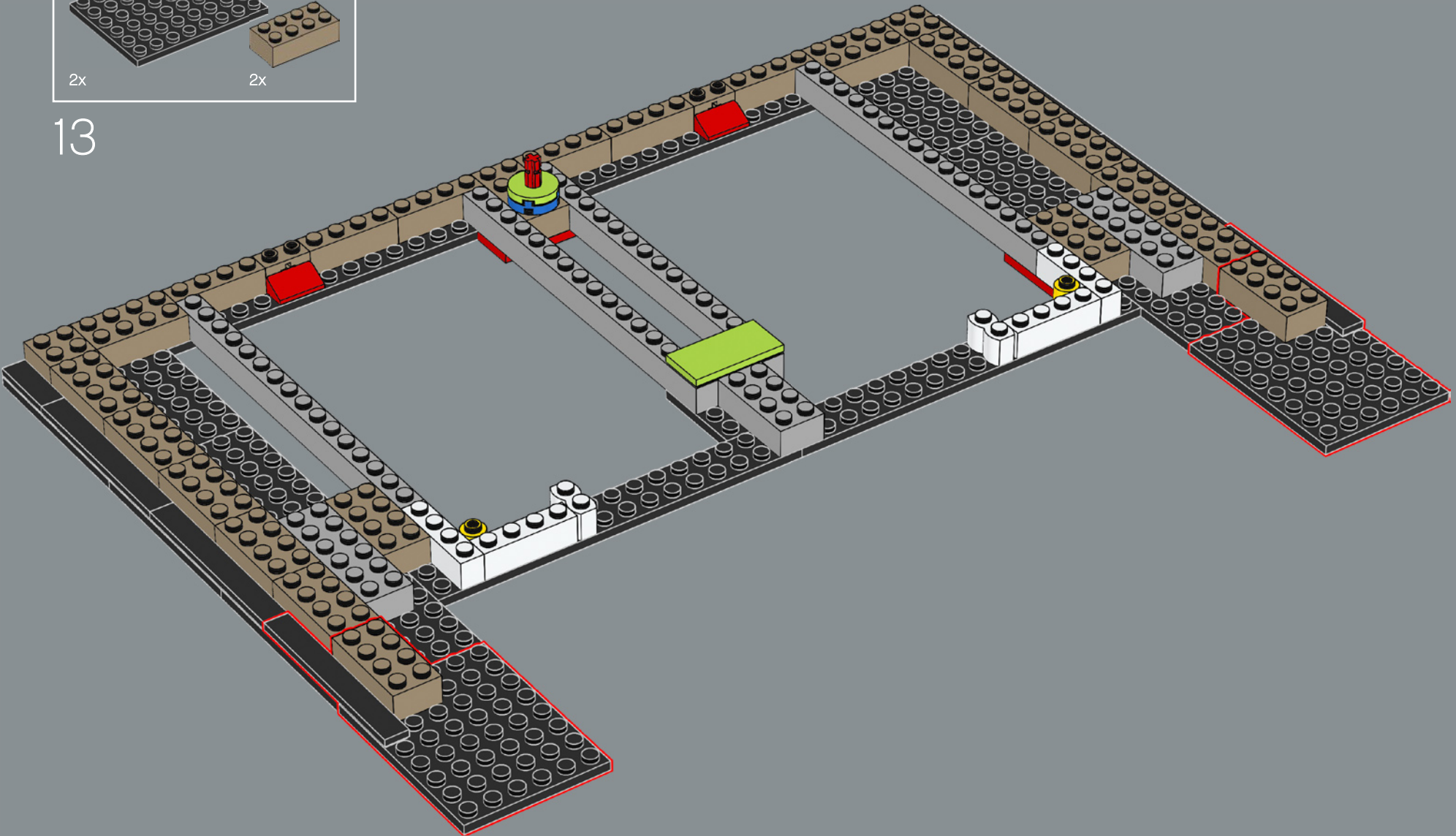

14

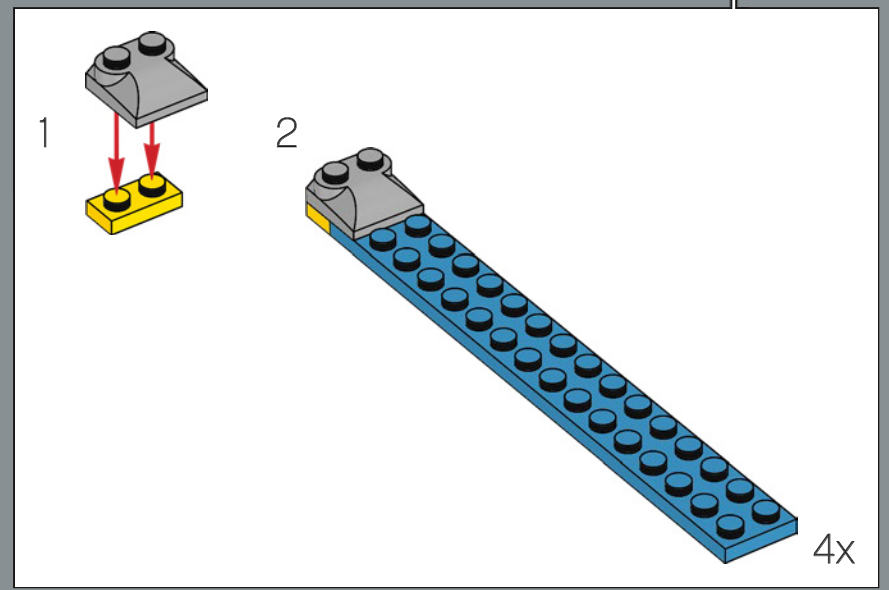
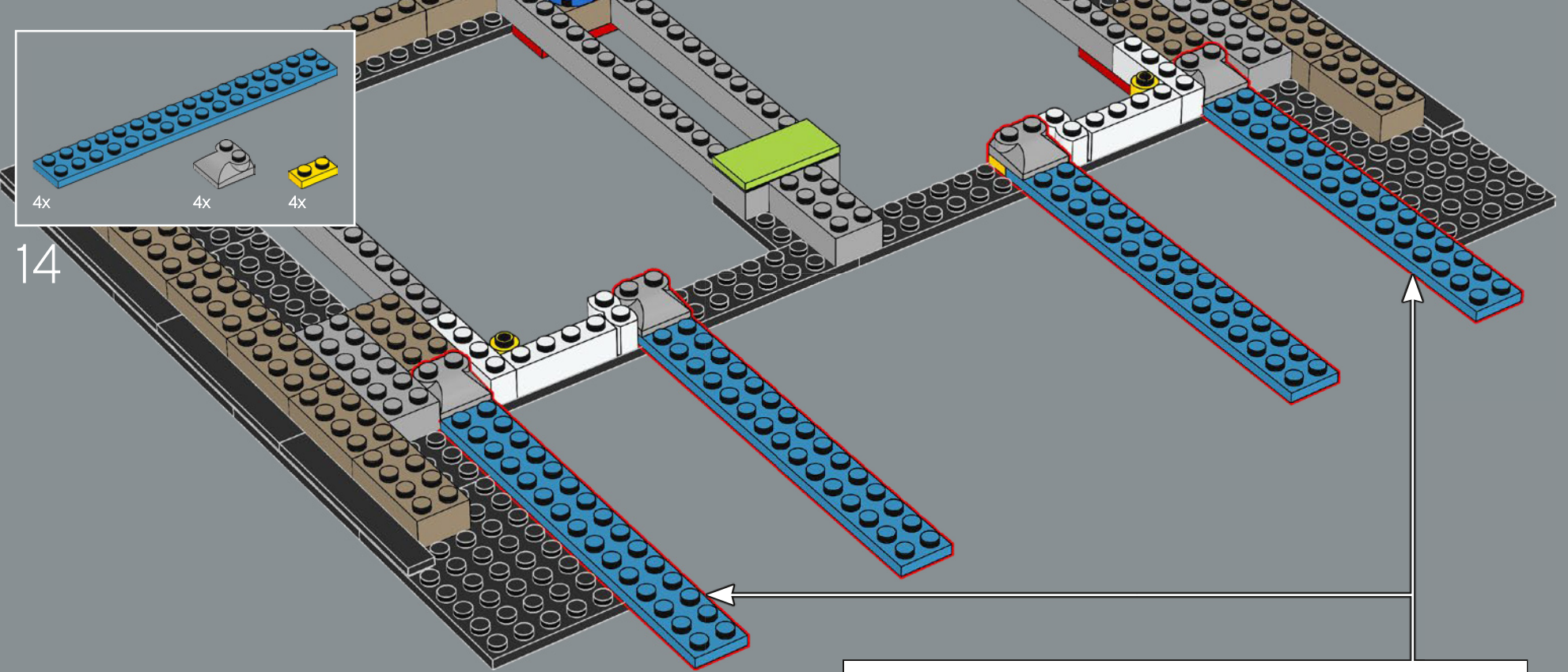
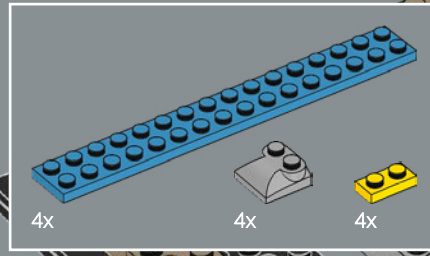

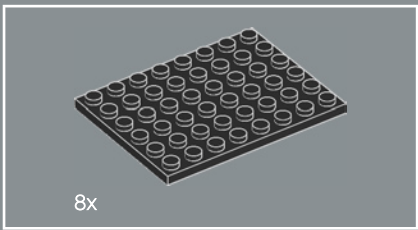

15

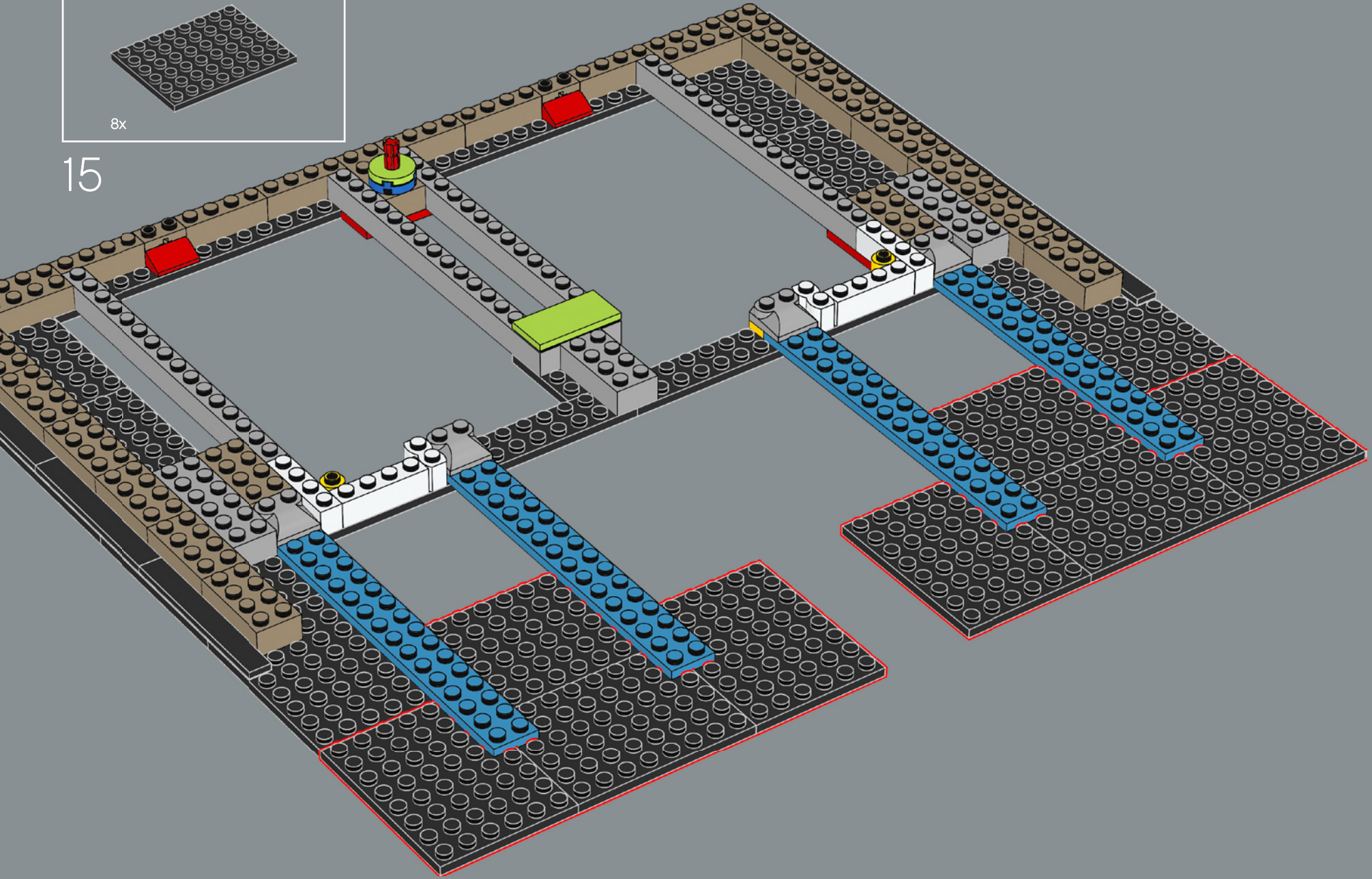

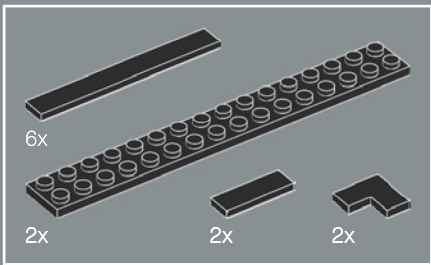

16

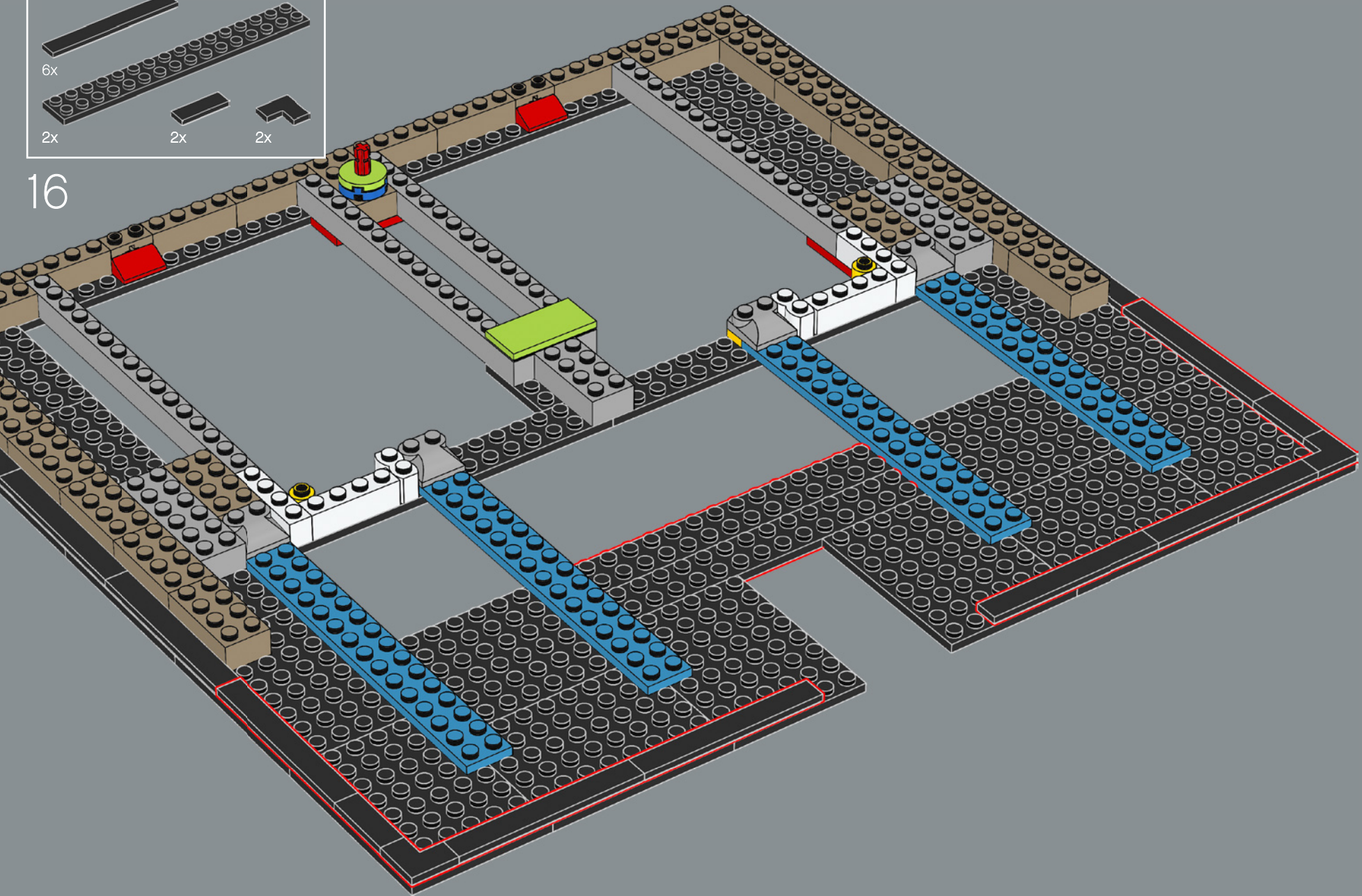

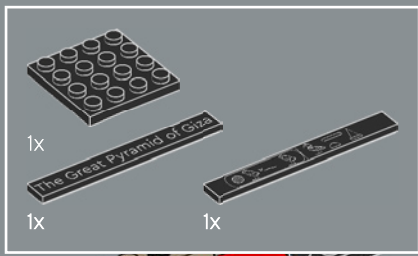

17

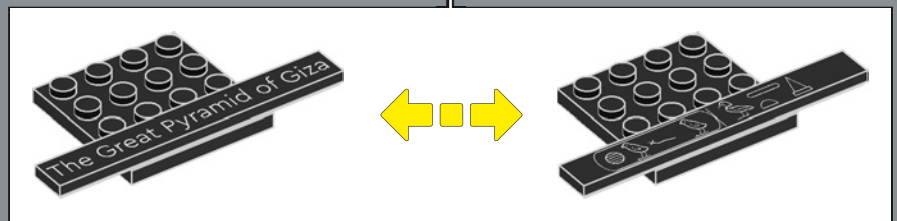
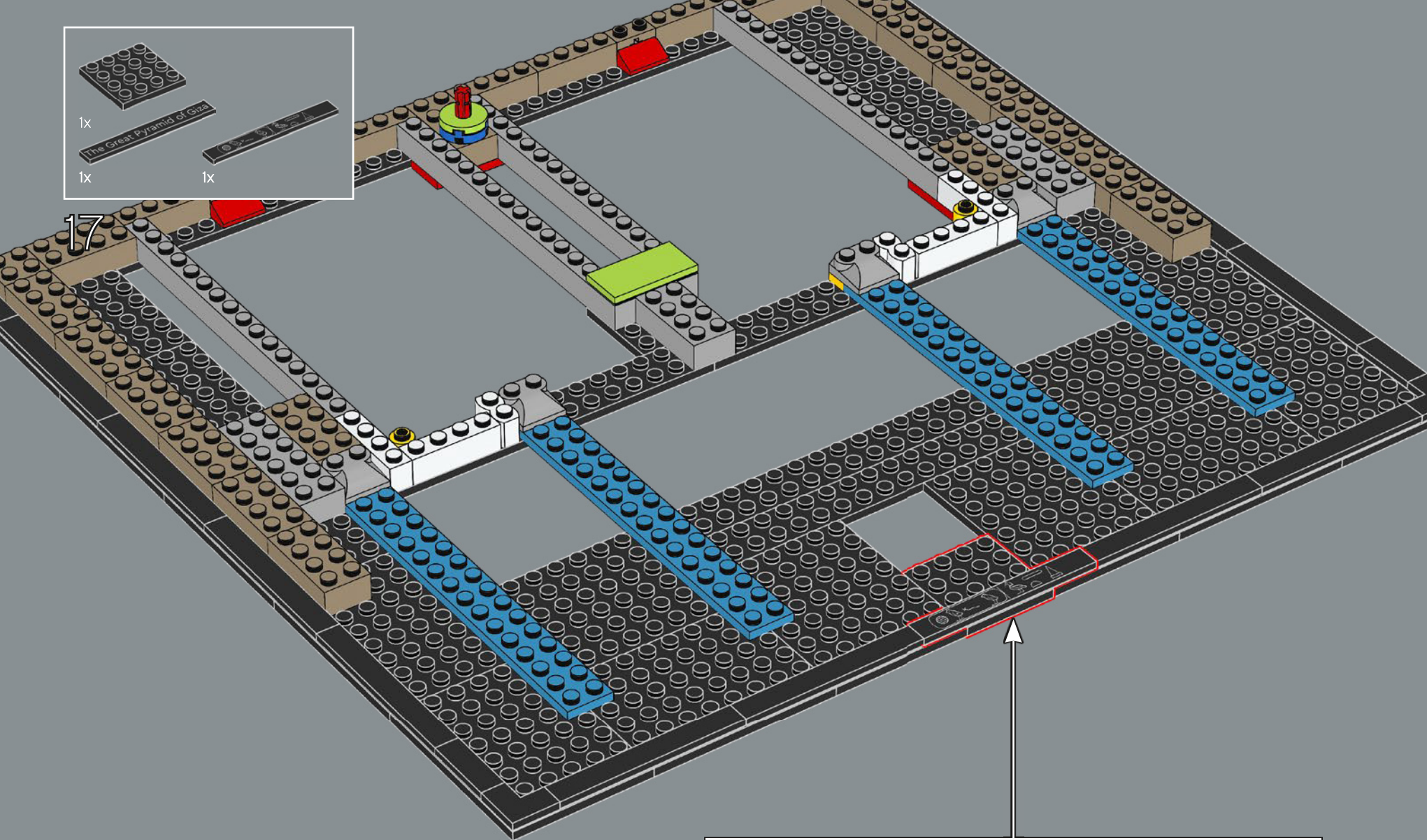

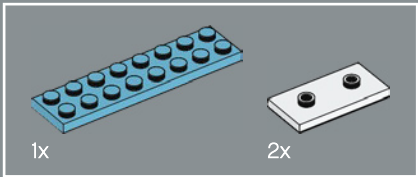

18

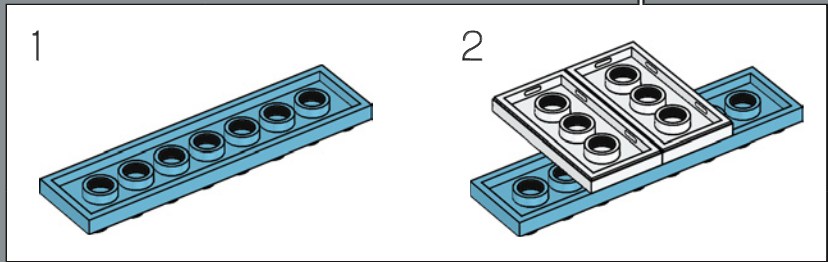
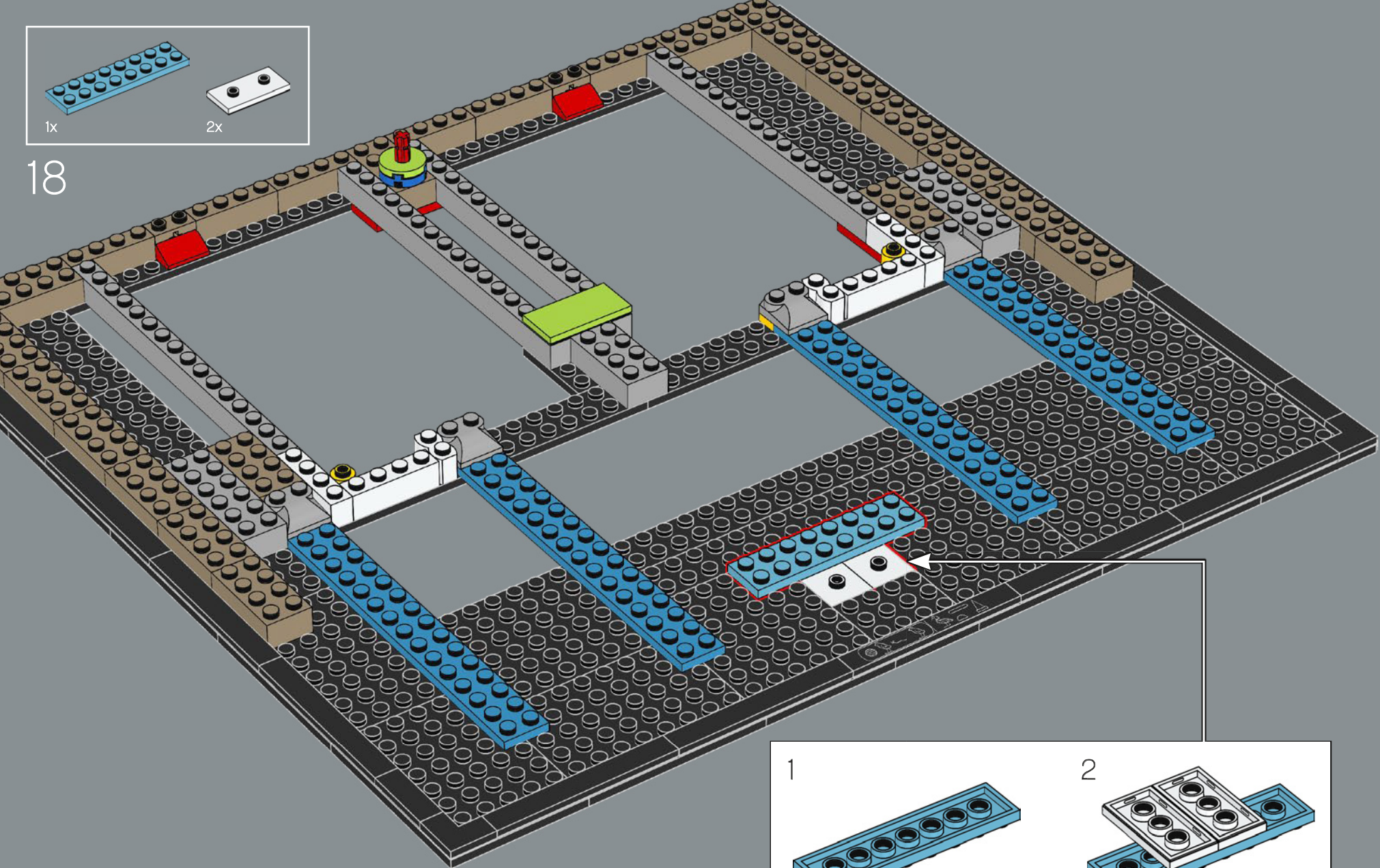

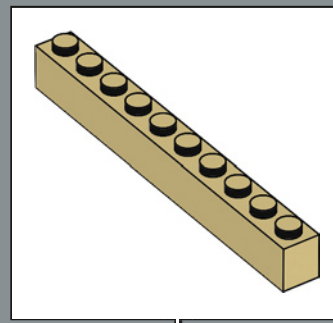
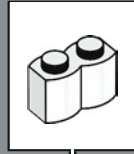
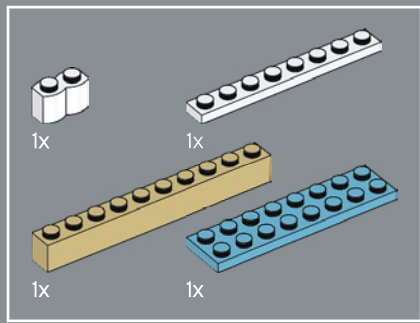

19

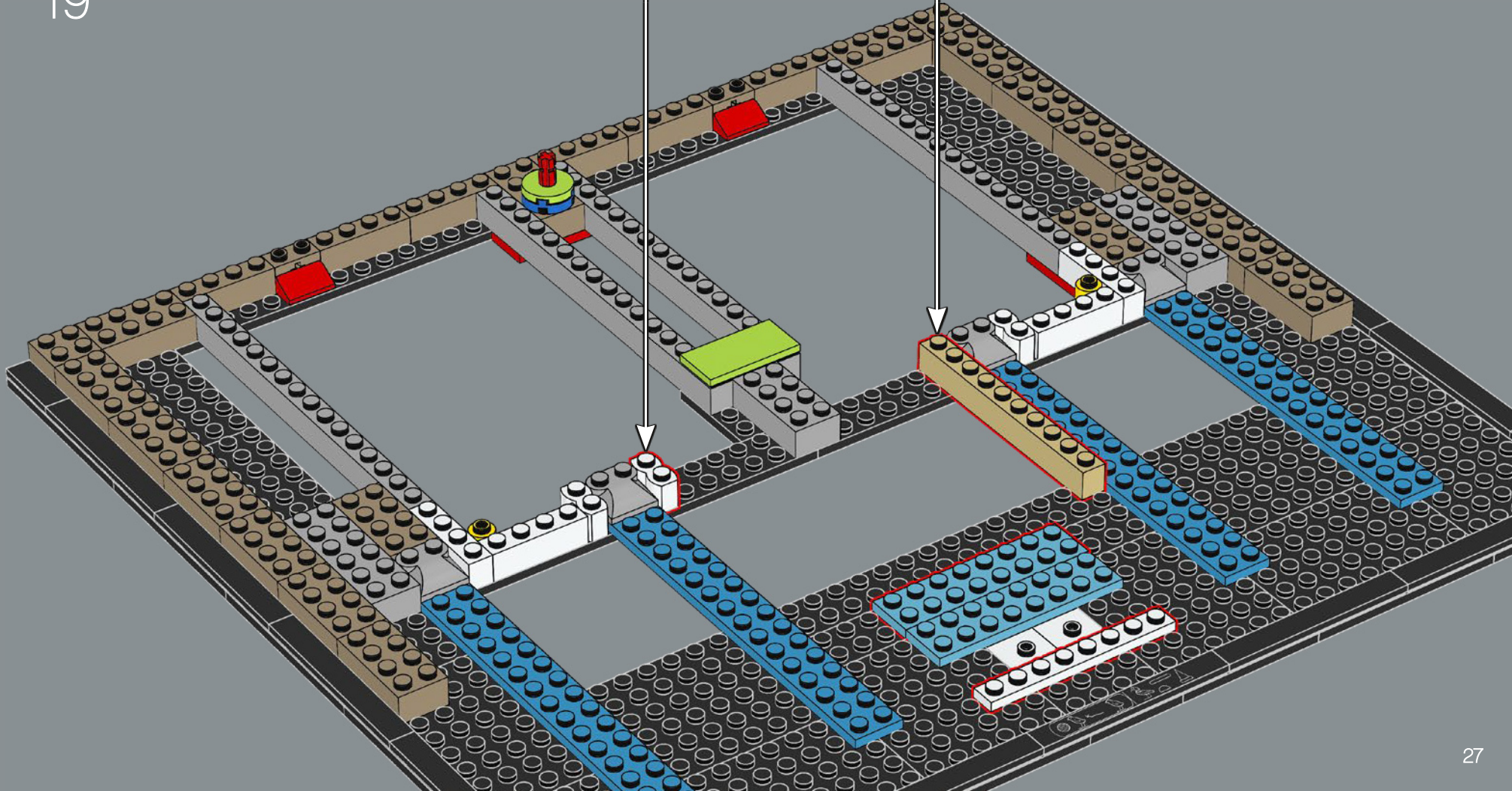

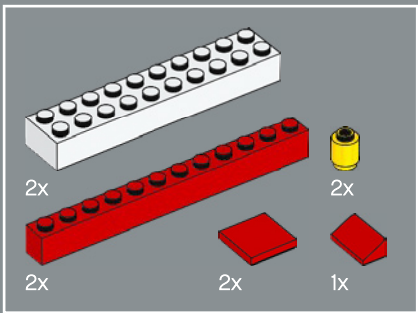

20

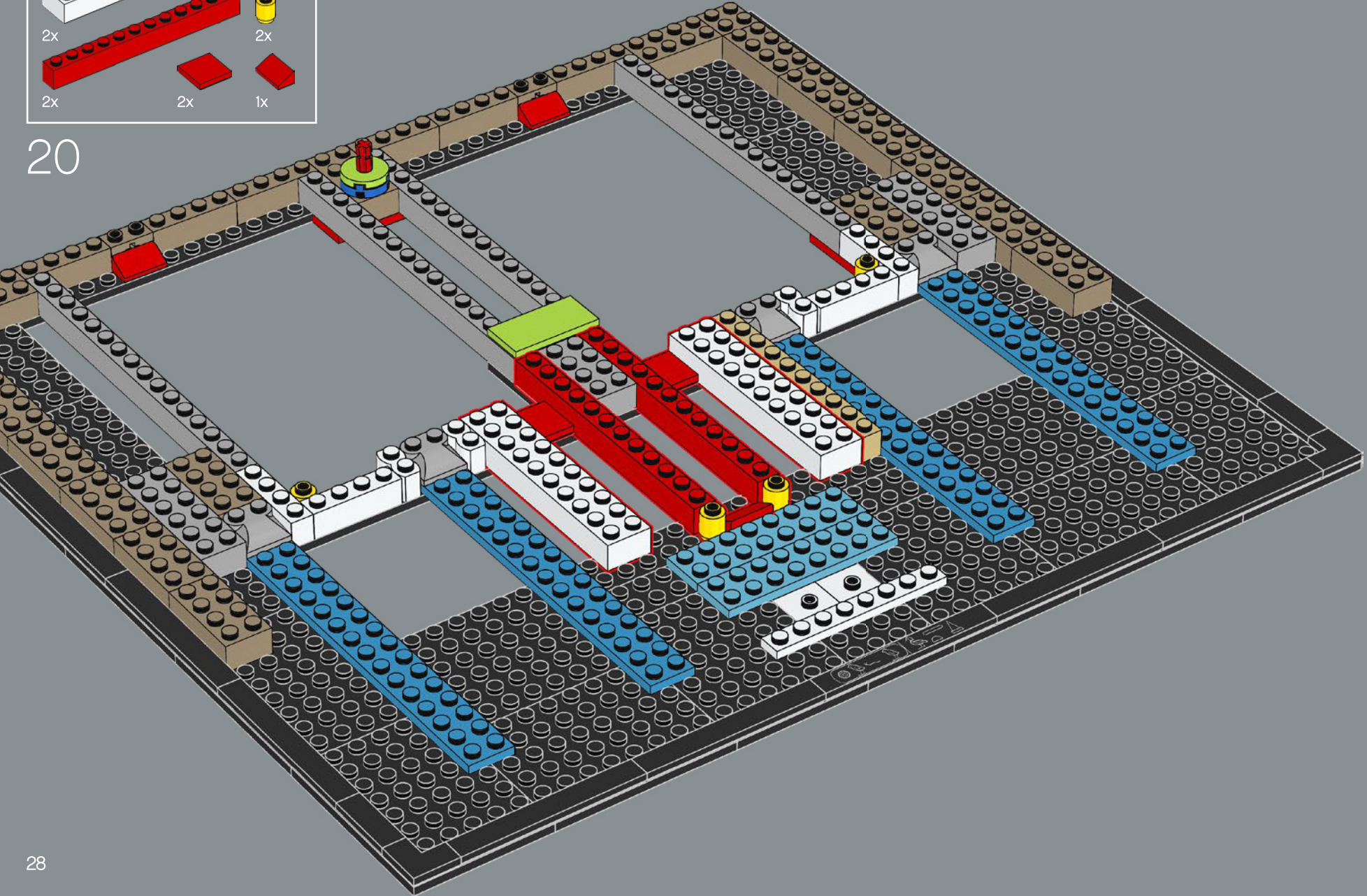

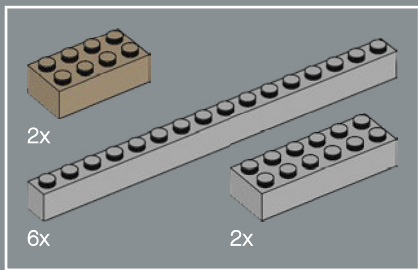

21

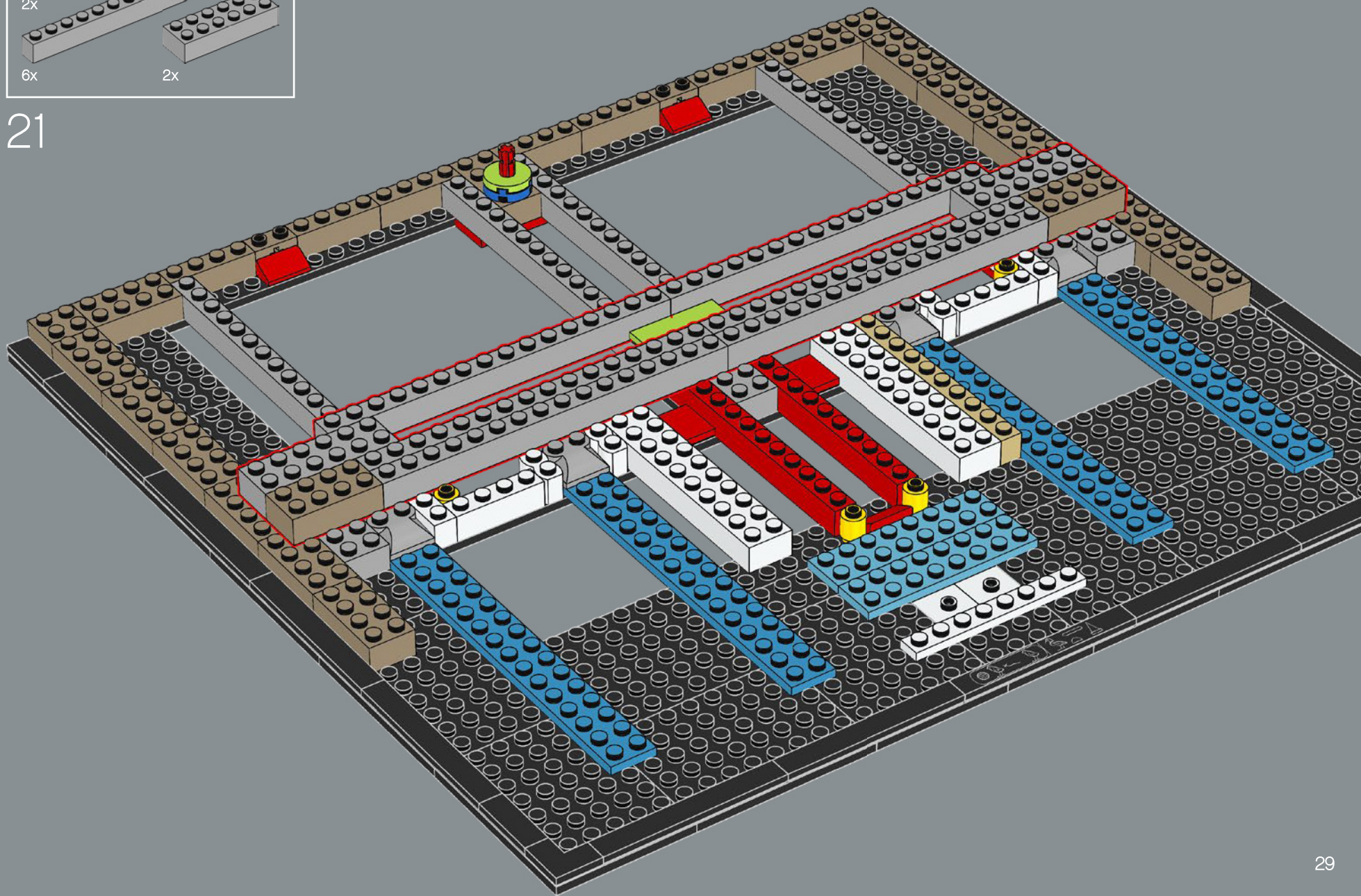

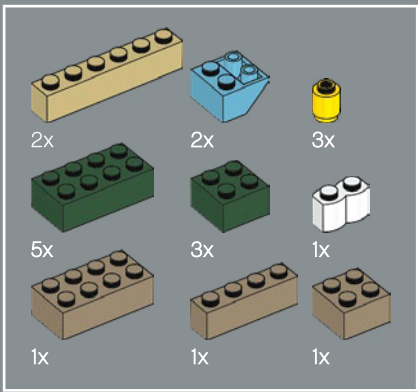

22

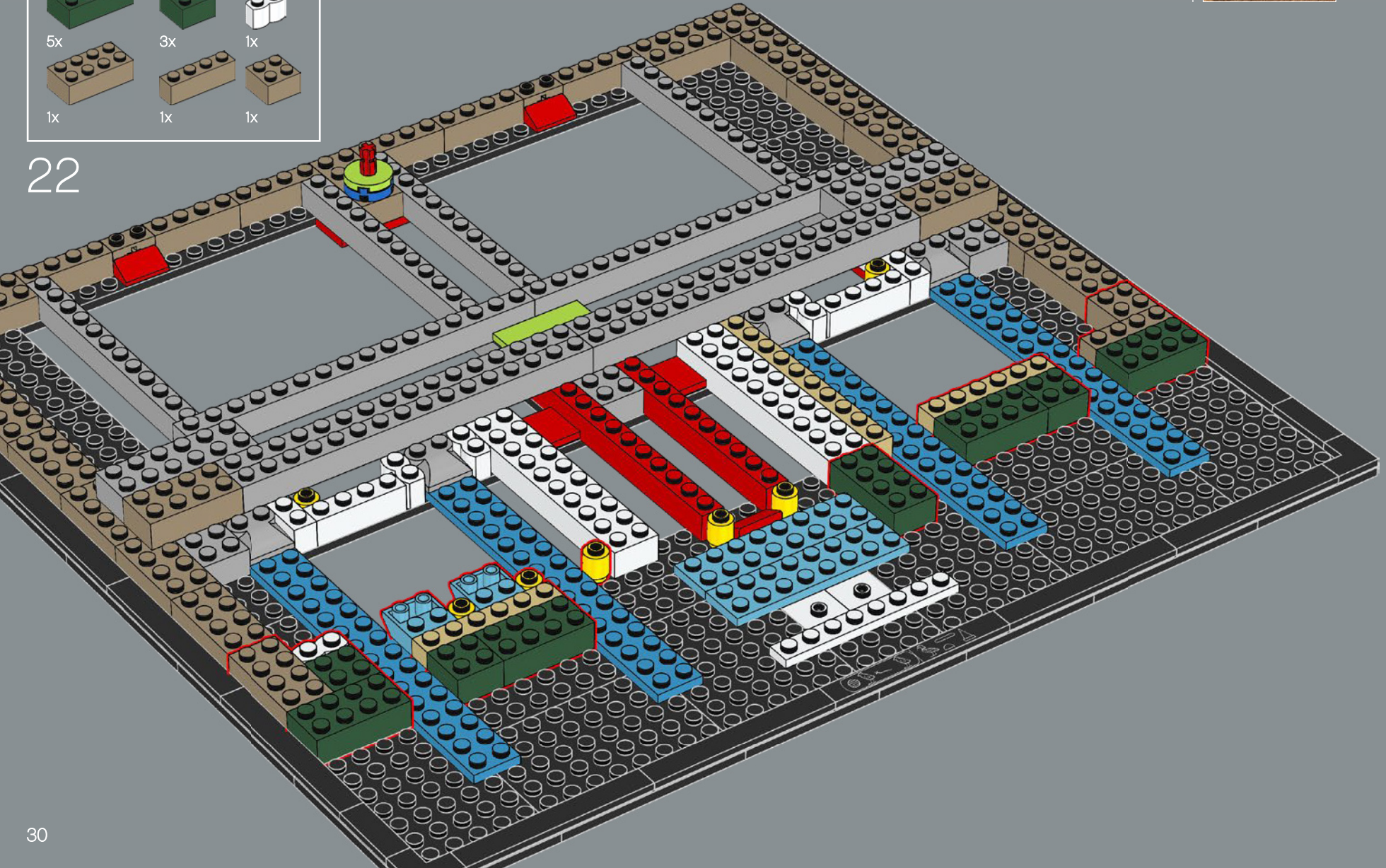

The sides of the Pyramid's base are closely aligned to the four geographic directions of North, South, East and West.

Les côtés de la base de la pyramide sont alignés selon les quatre points cardinaux : nord, sud, est et ouest.

Los lados de la base de la pirámide están alineados con gran exactitud de norte a sur y de este a oeste.





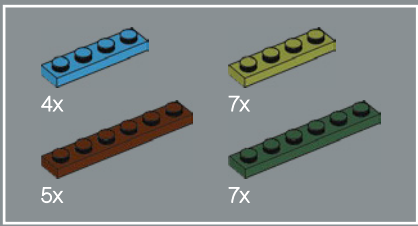

23

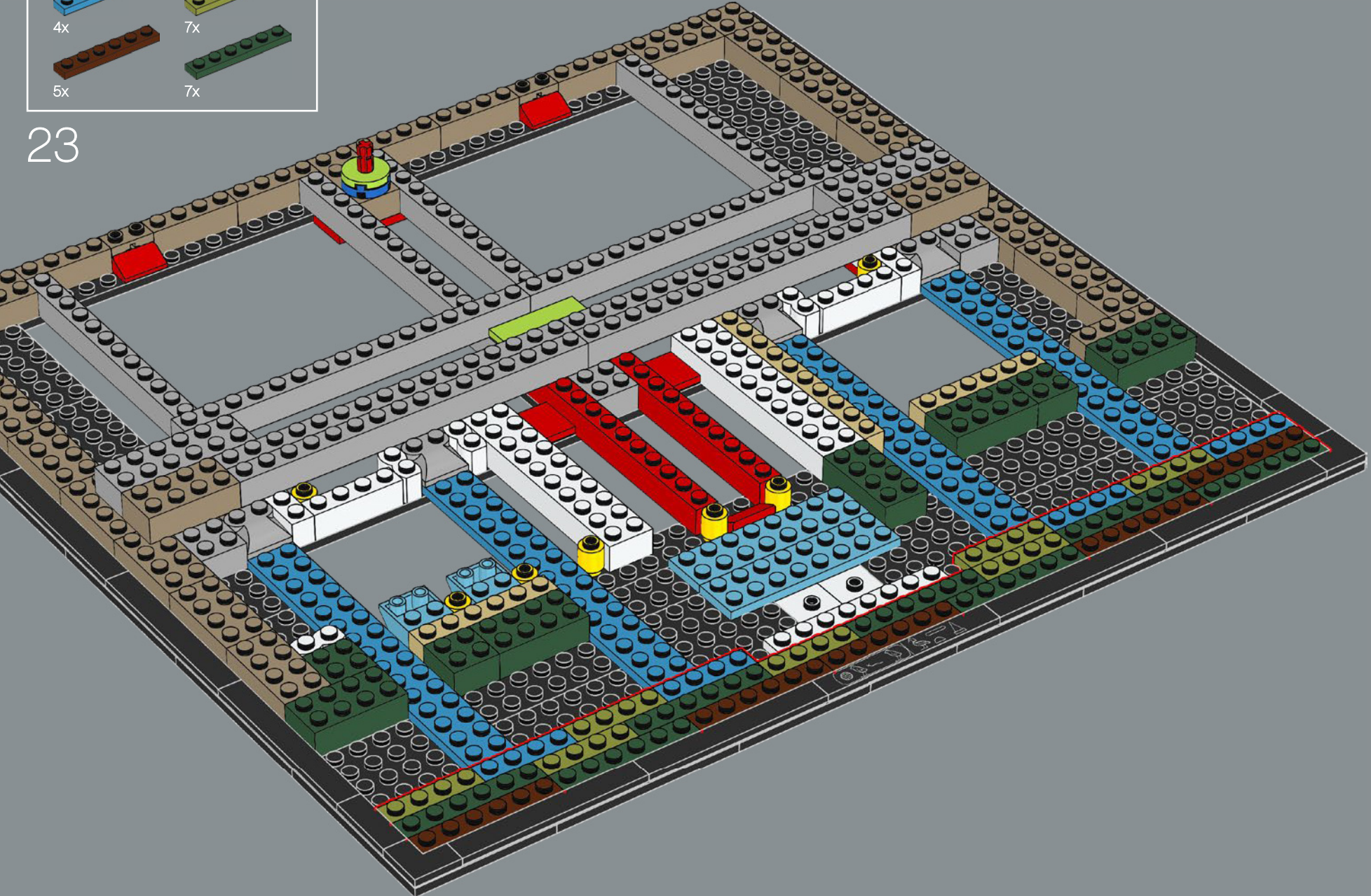

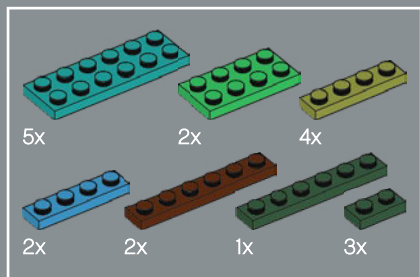

24

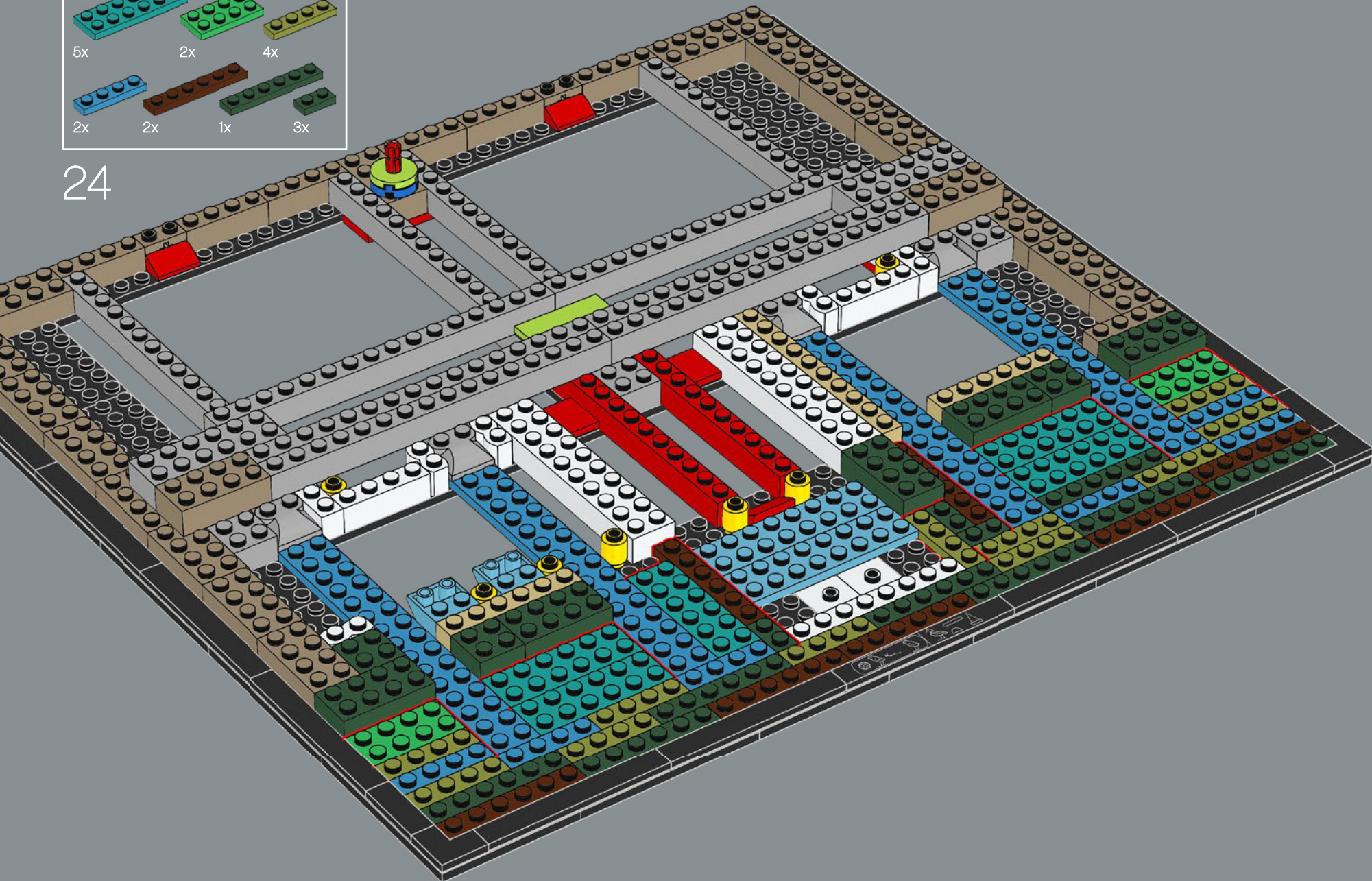

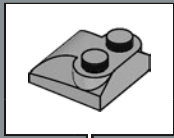
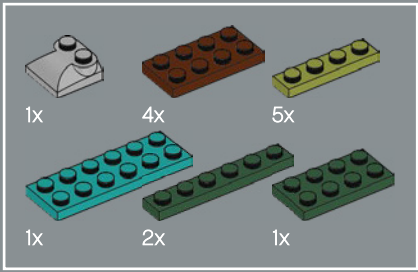

25

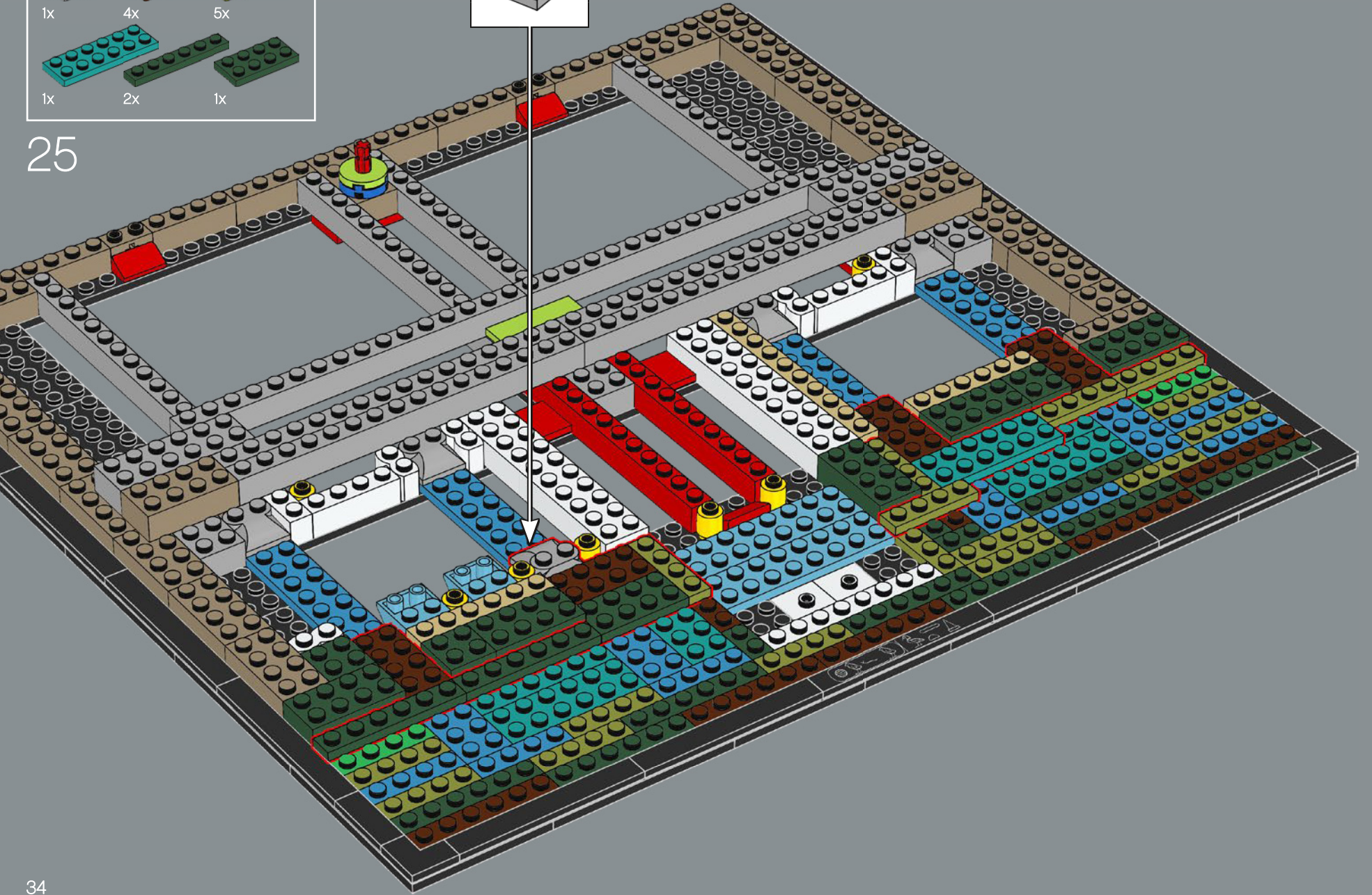

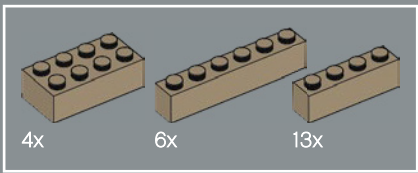

27

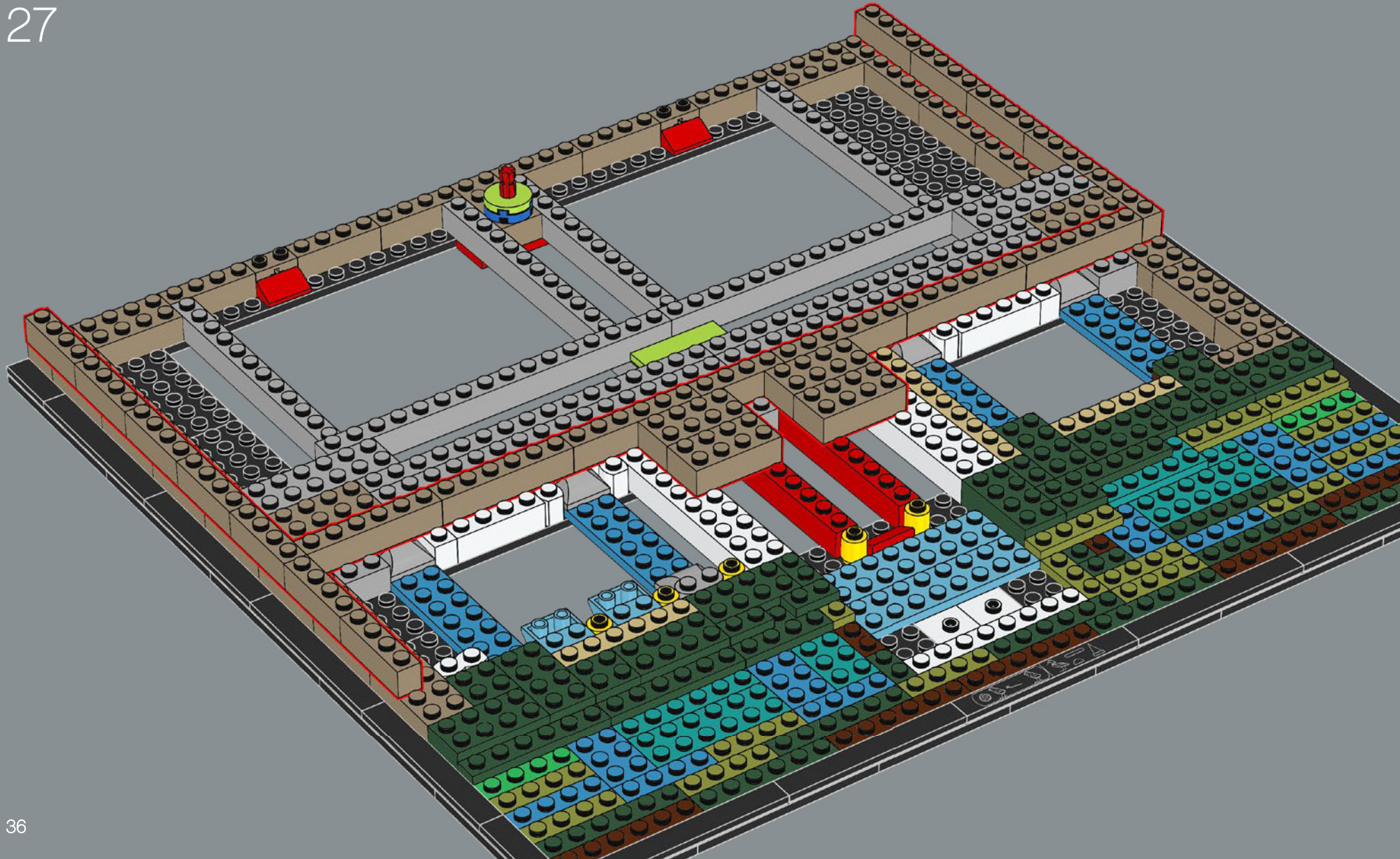

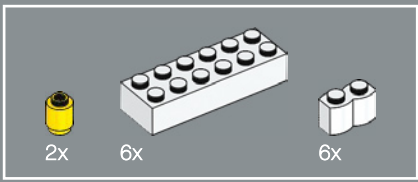

29

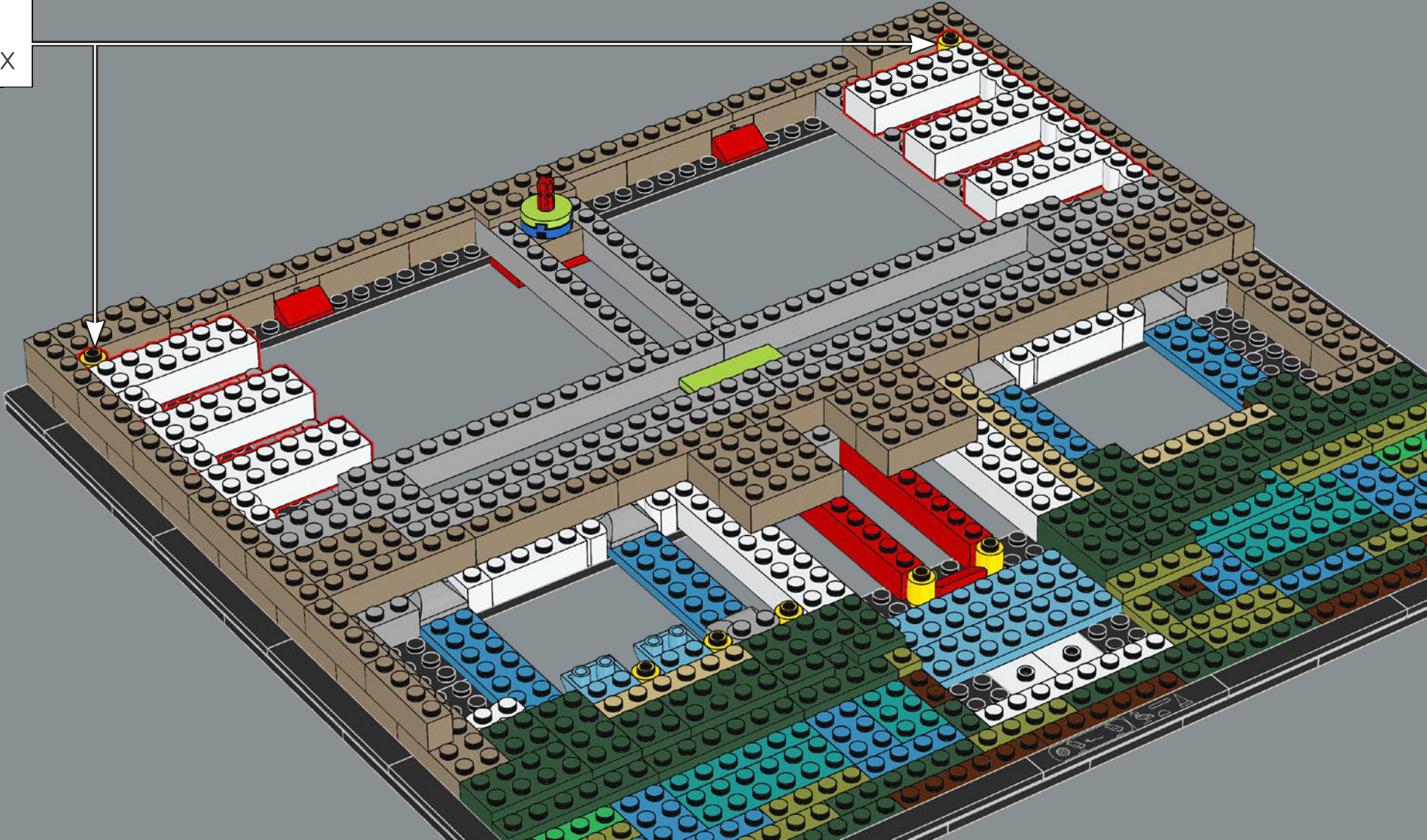

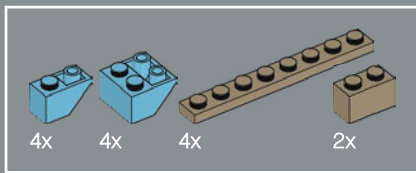

30

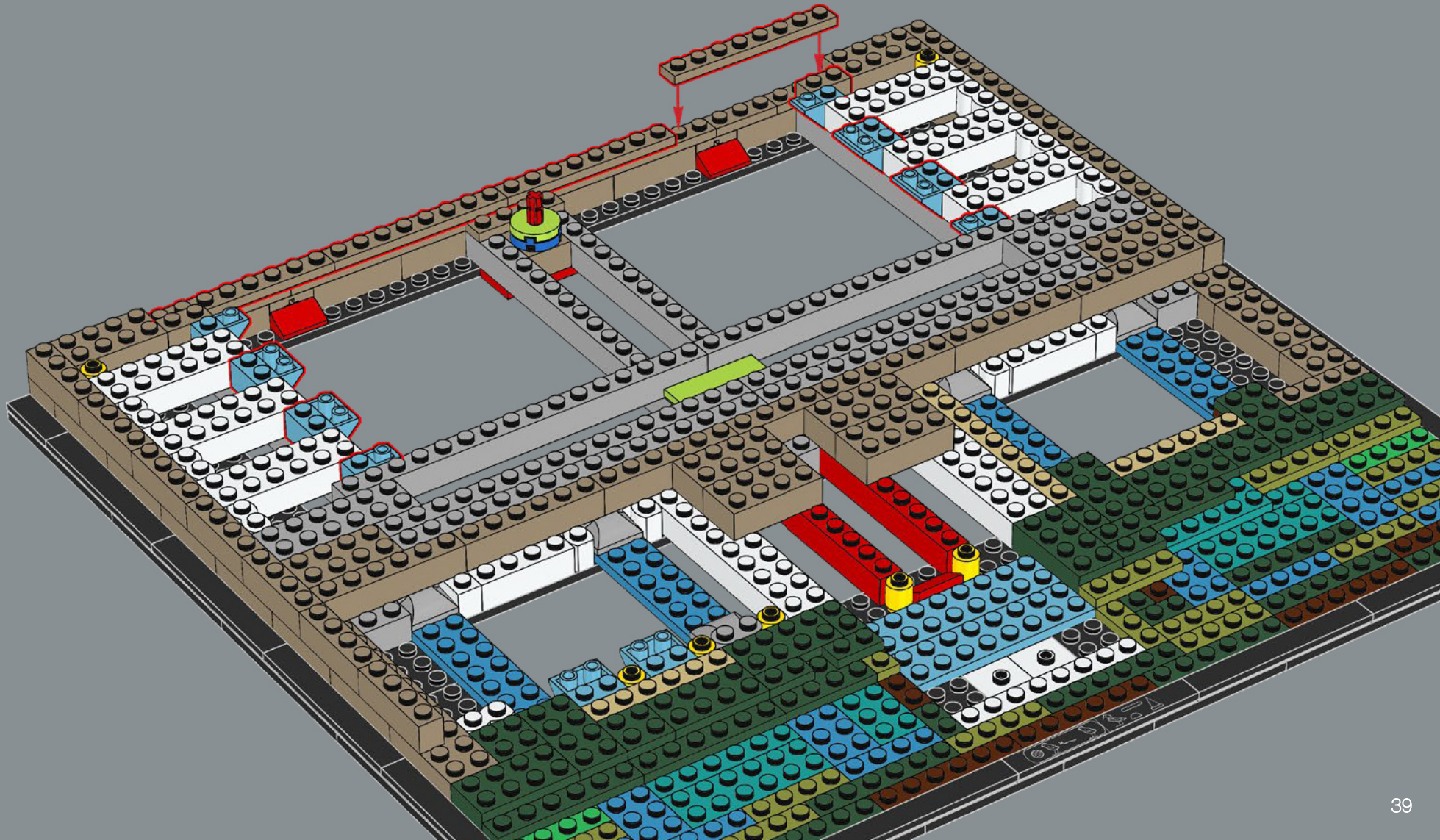

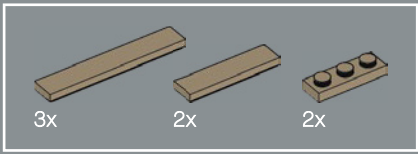

31

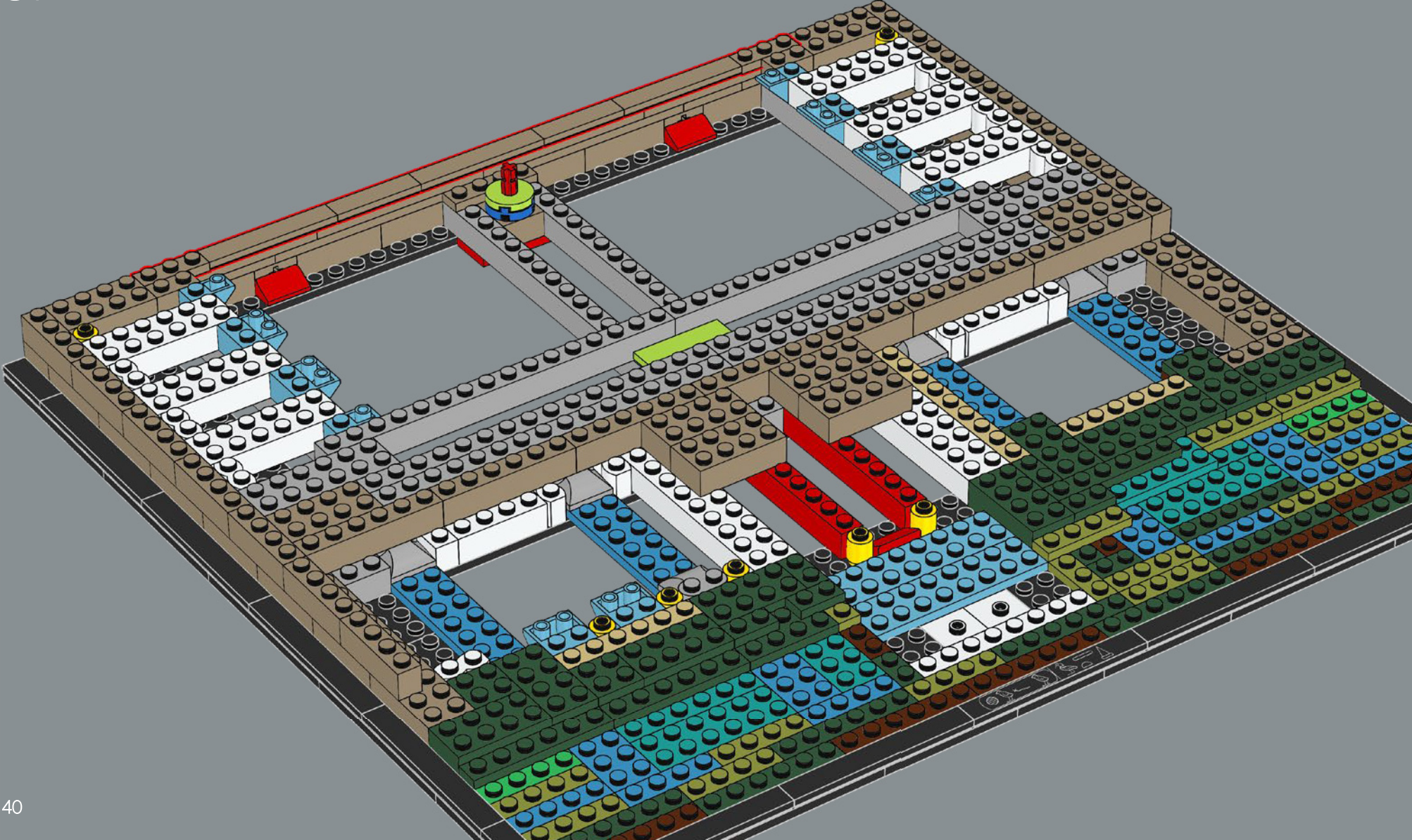

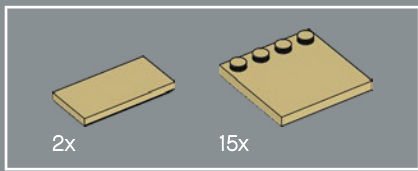

32

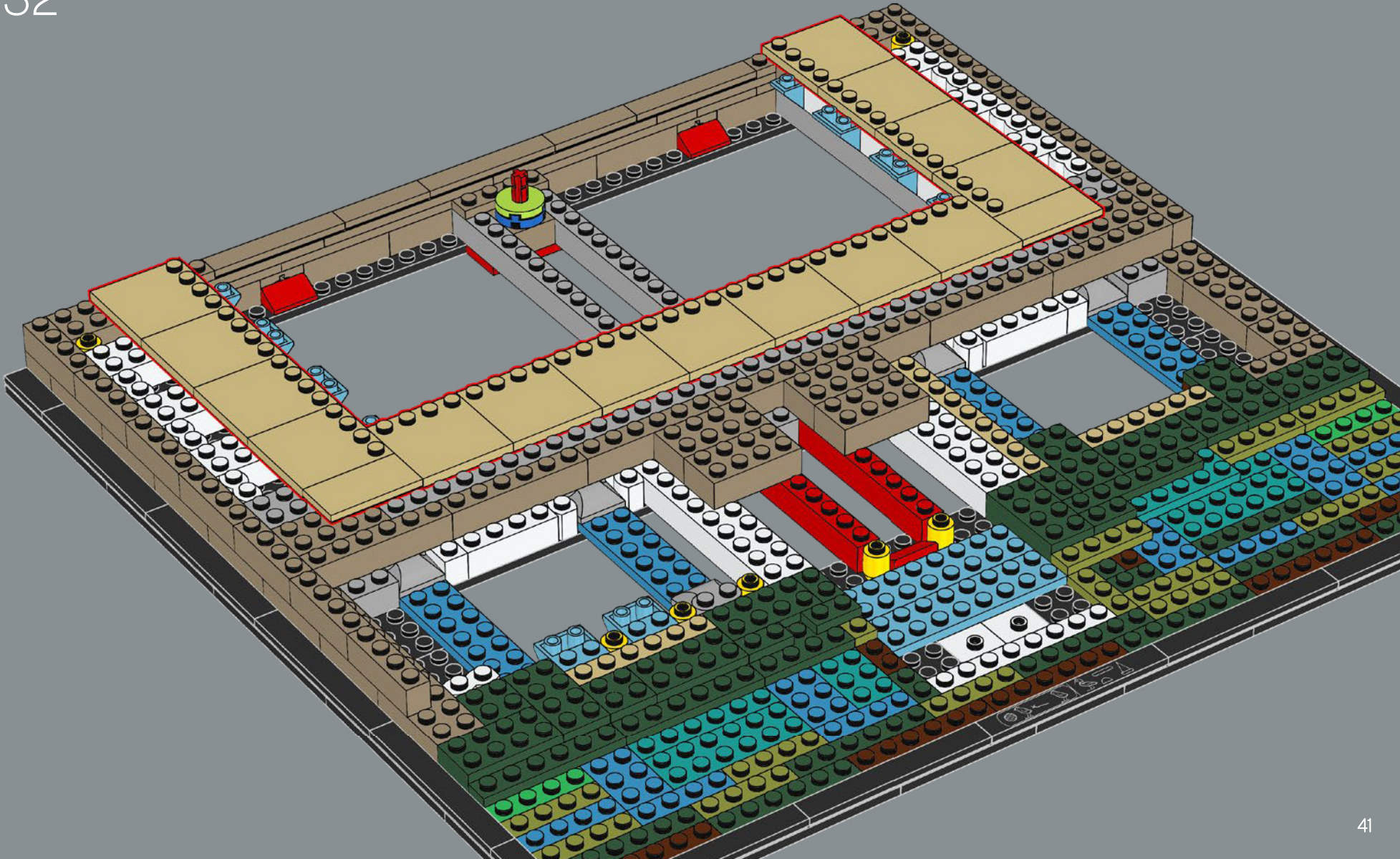

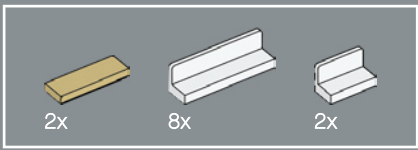

33

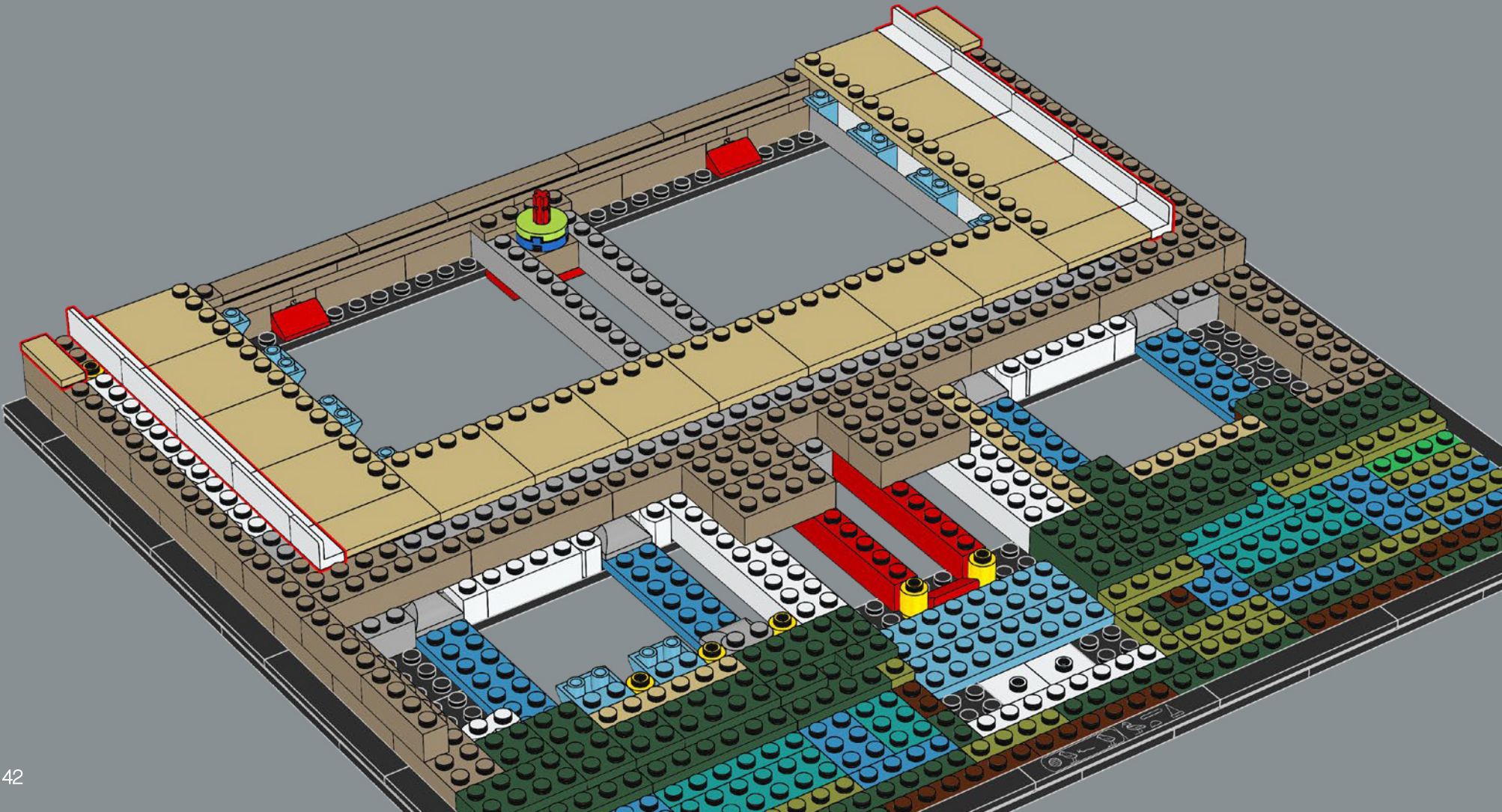

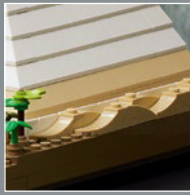
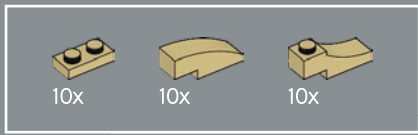

Rolling sand dunes of the nearby desert are placed at the edge of the otherwise lush model scene.

Les dunes de sable ondulées du désert environnant sont placées au bord du décor luxuriant du modèle.

Ondulantes dunas de arena del desierto cercano bordean la escena, de lo más exuberante.

34

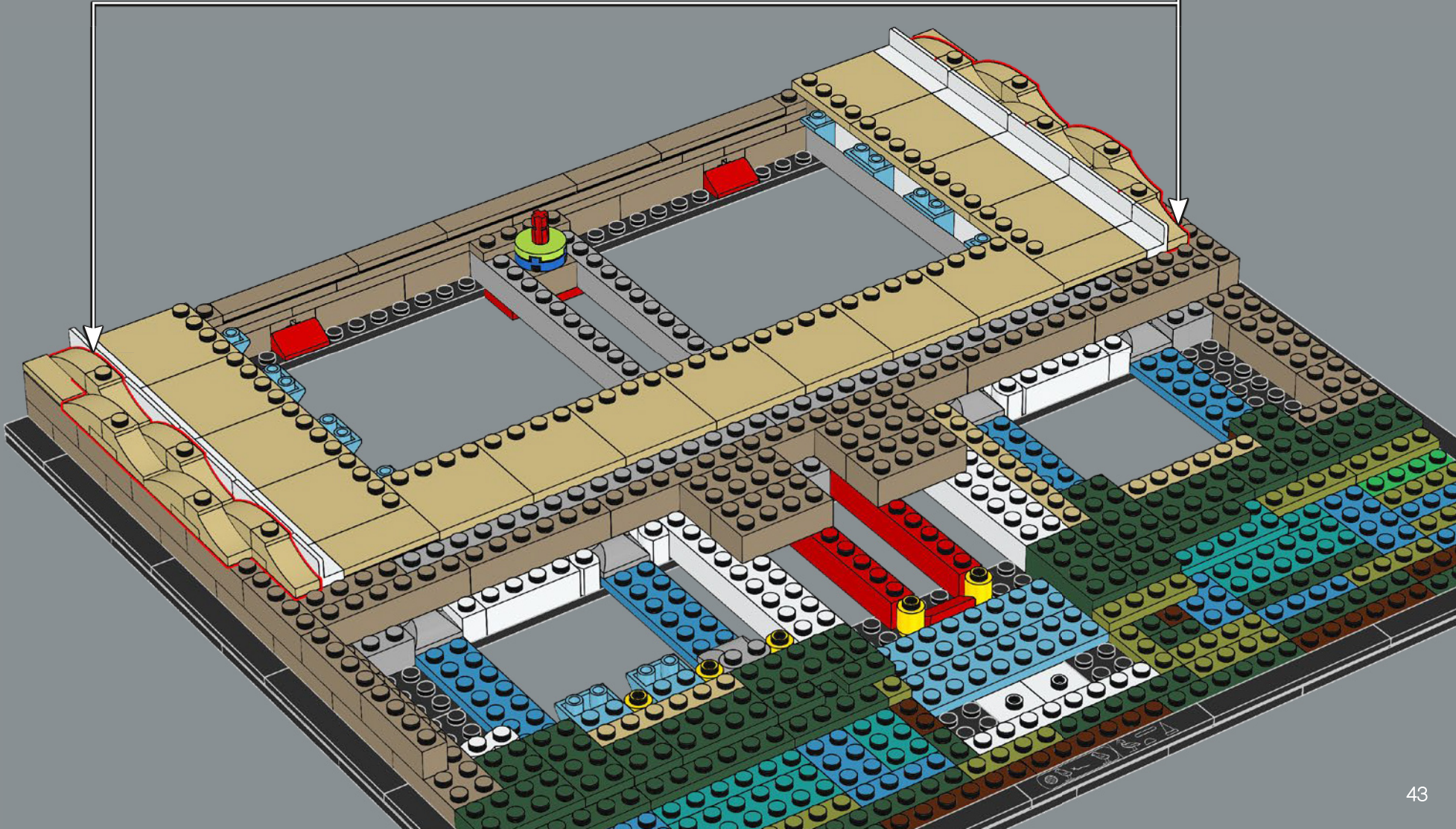
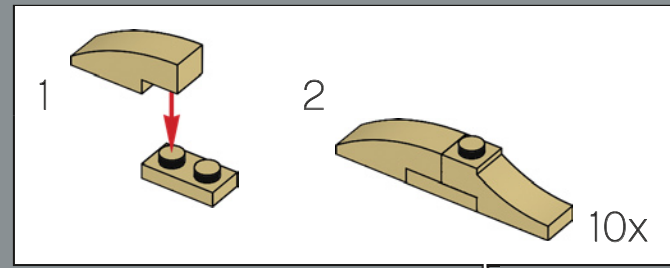

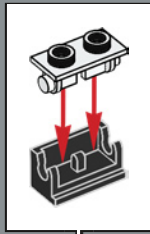
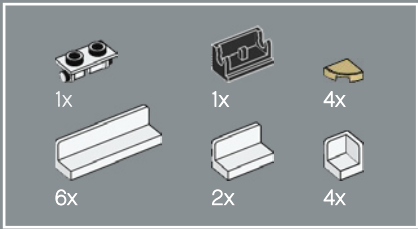

35

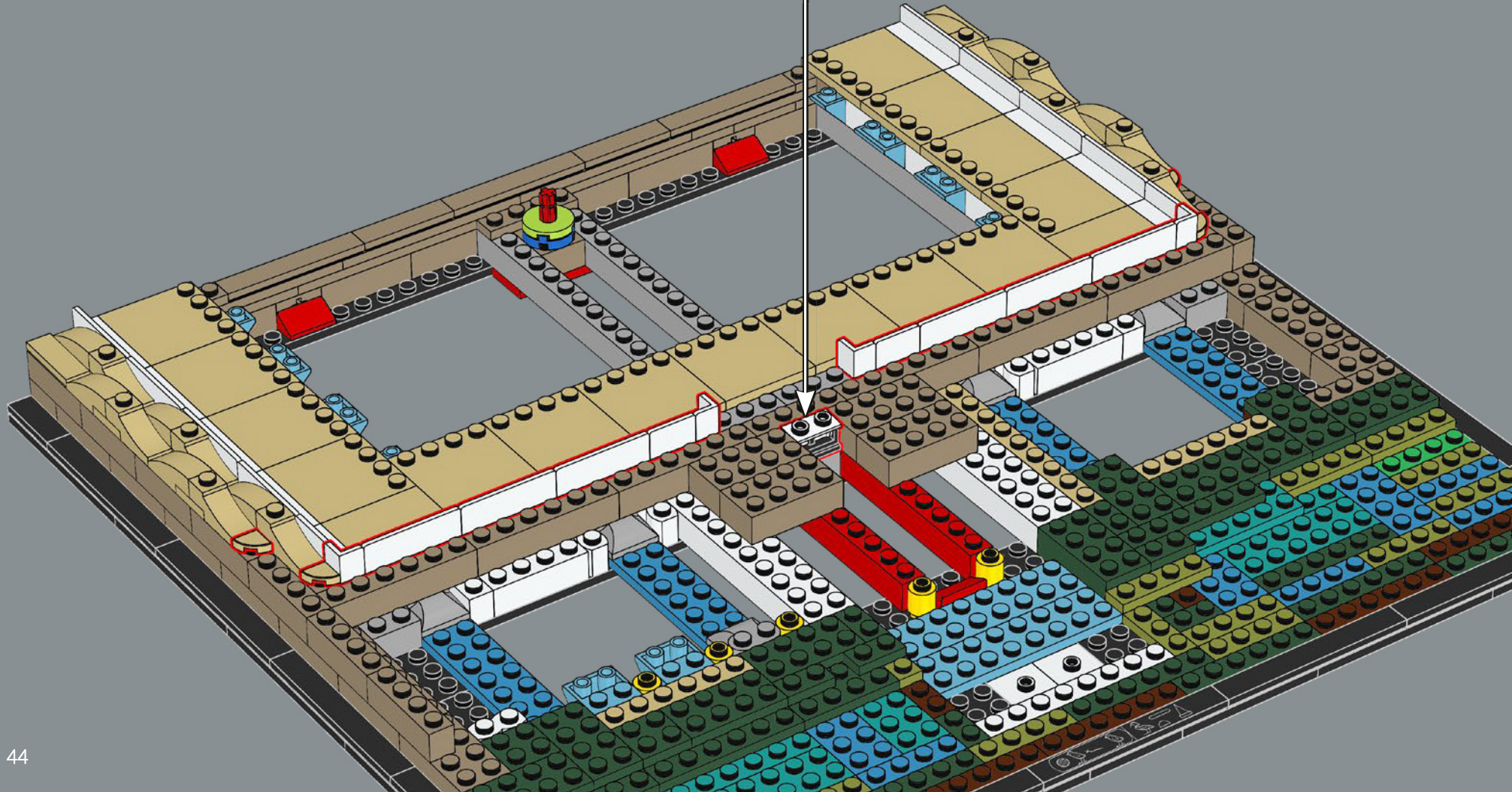

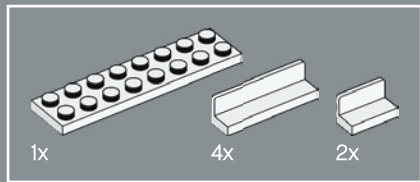

36

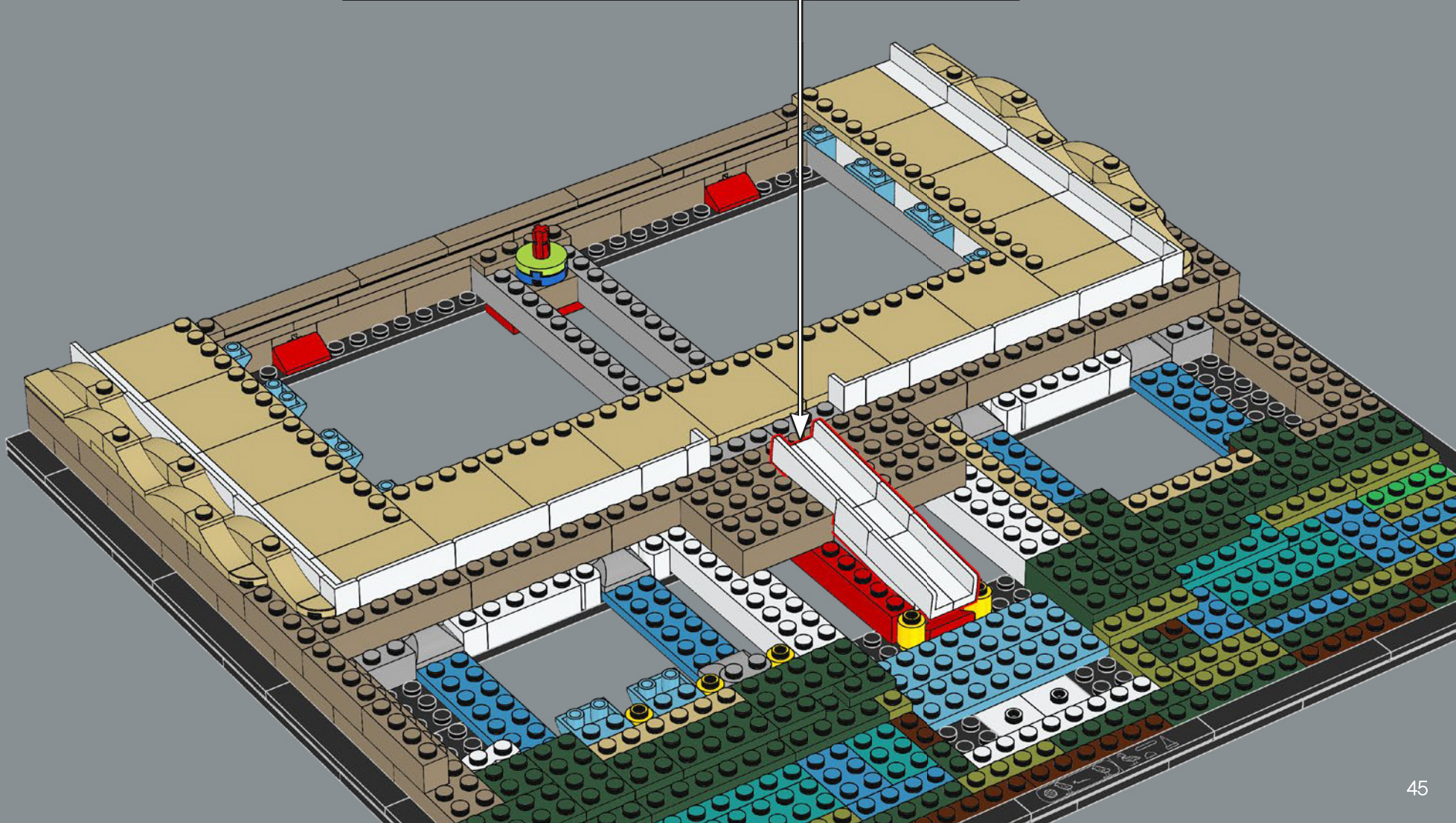
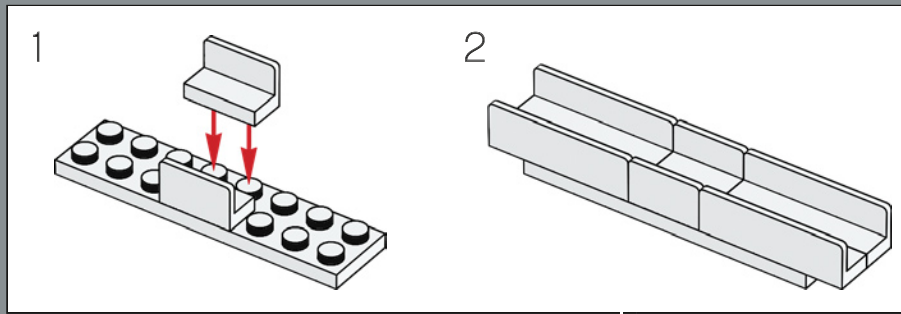



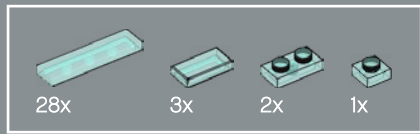

37

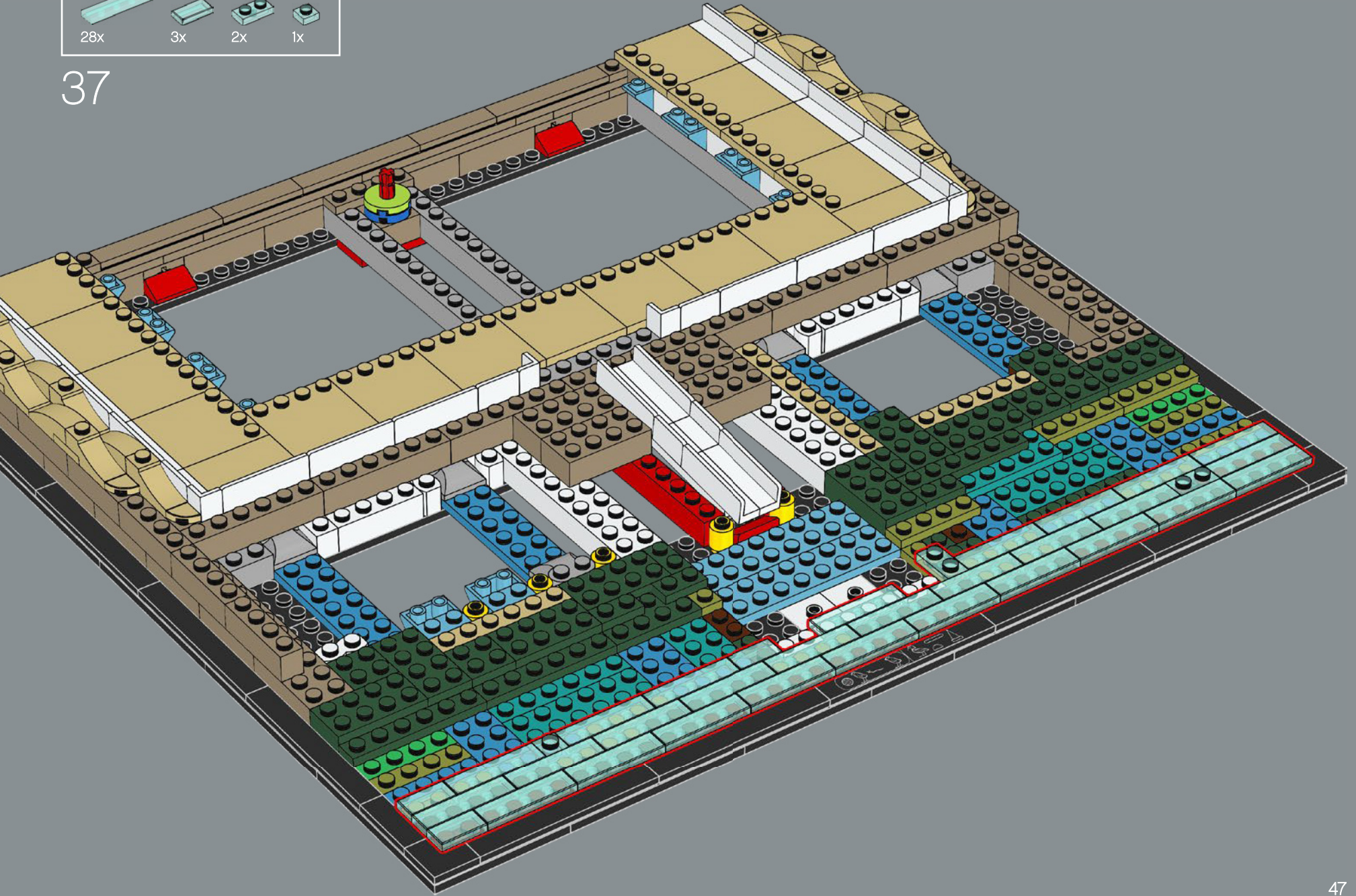

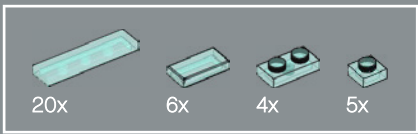

38

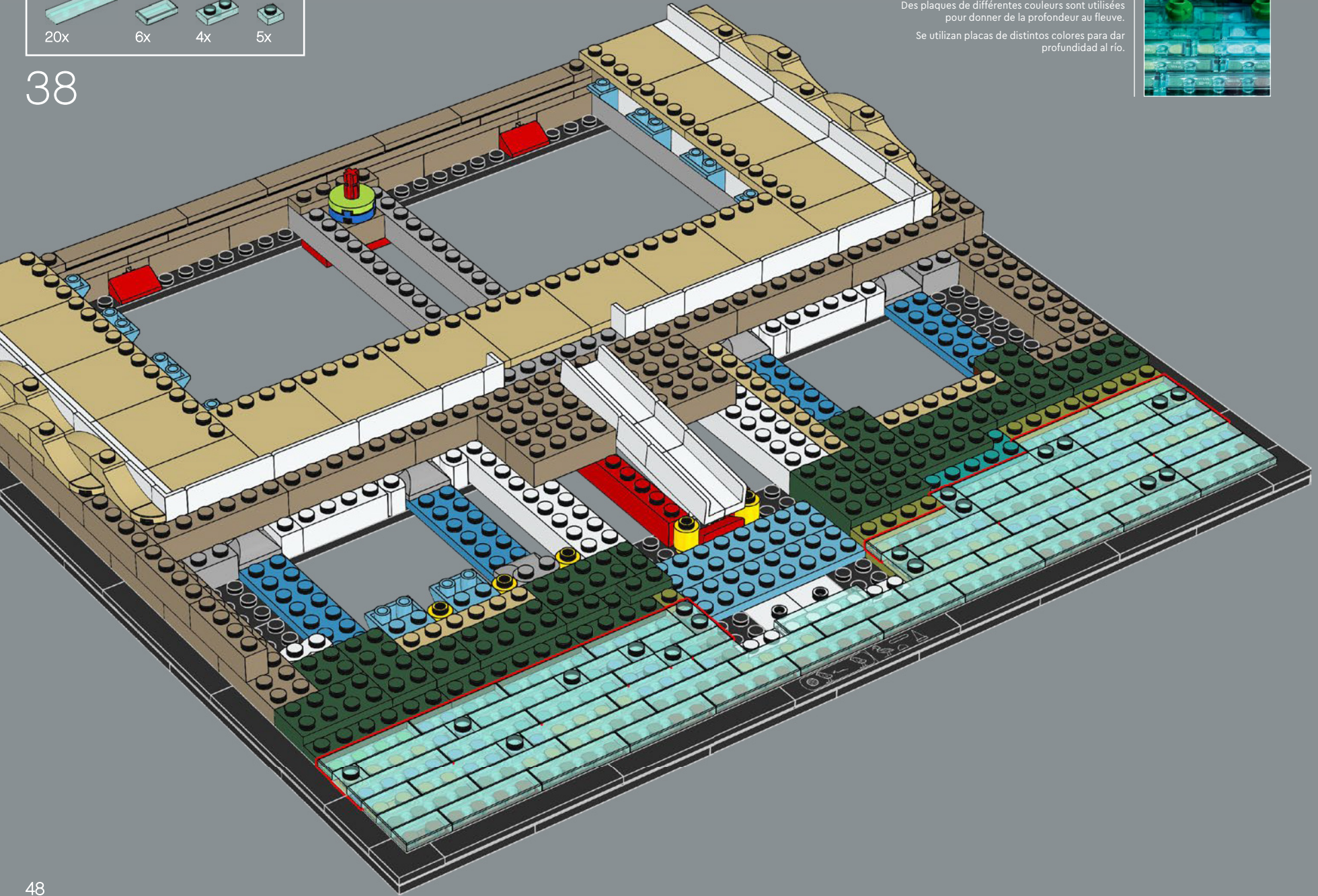

Different colors of plates are used to give depth to the river.
Des plaques de différentes couleurs sont utilisées pour donner de la profondeur au fleuve.
Se utilizan placas de distintos colores para dar profundidad al río.



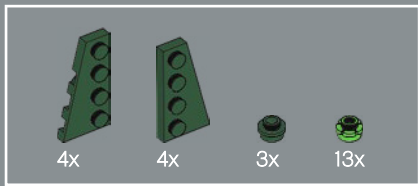

39

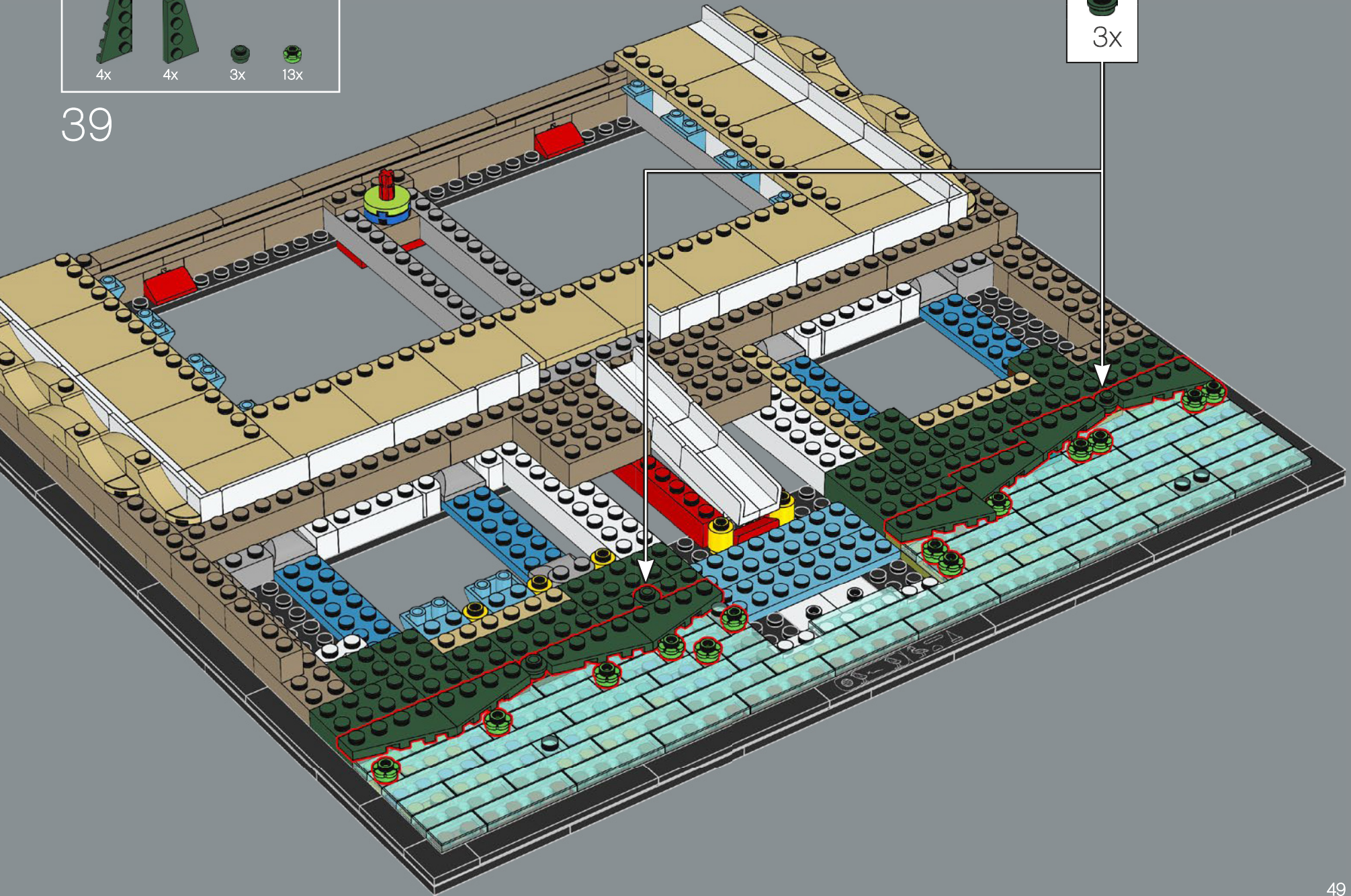

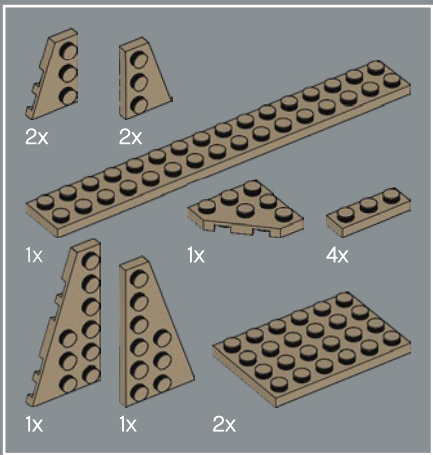

40

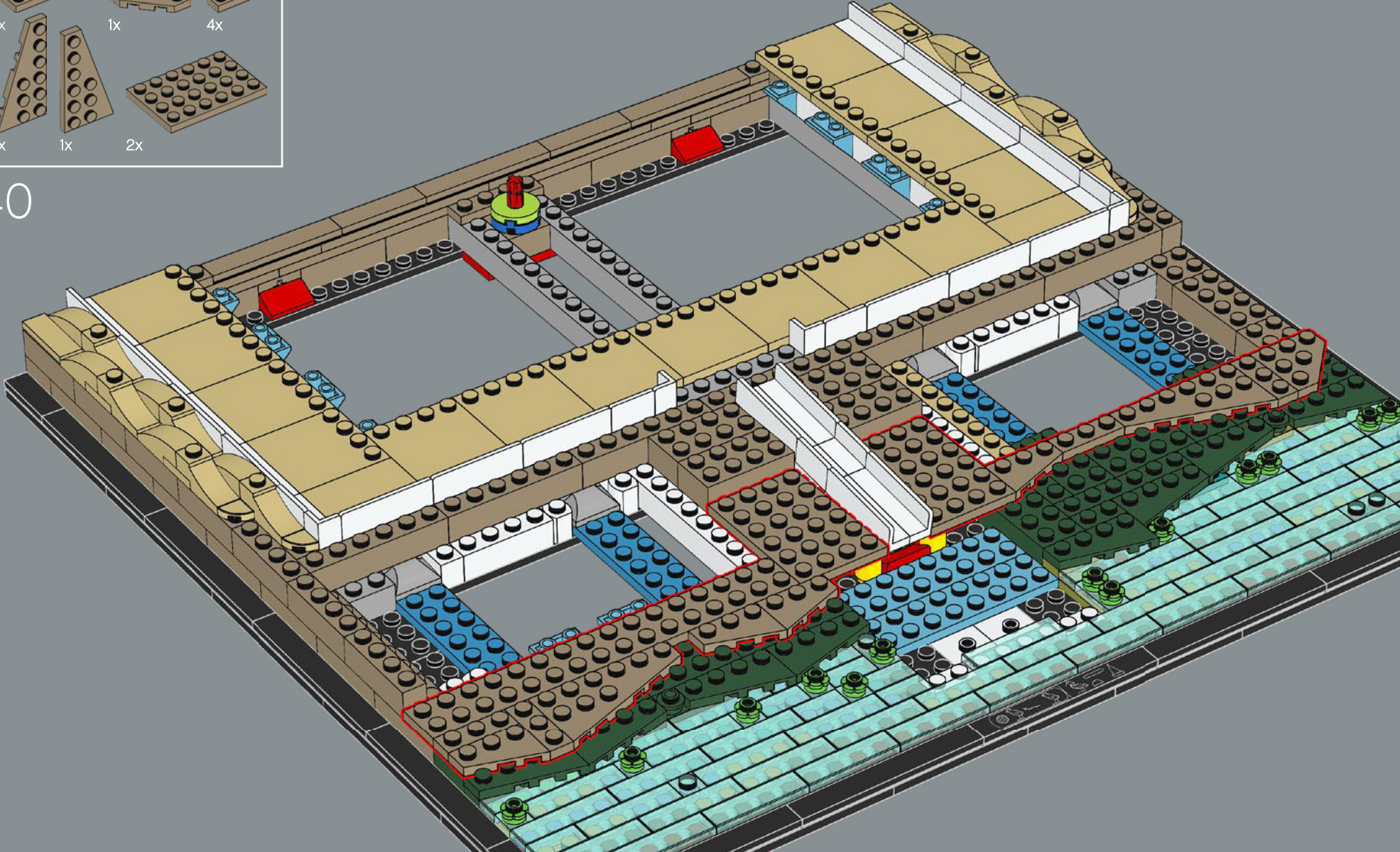

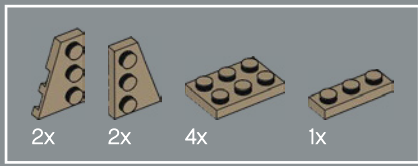

41

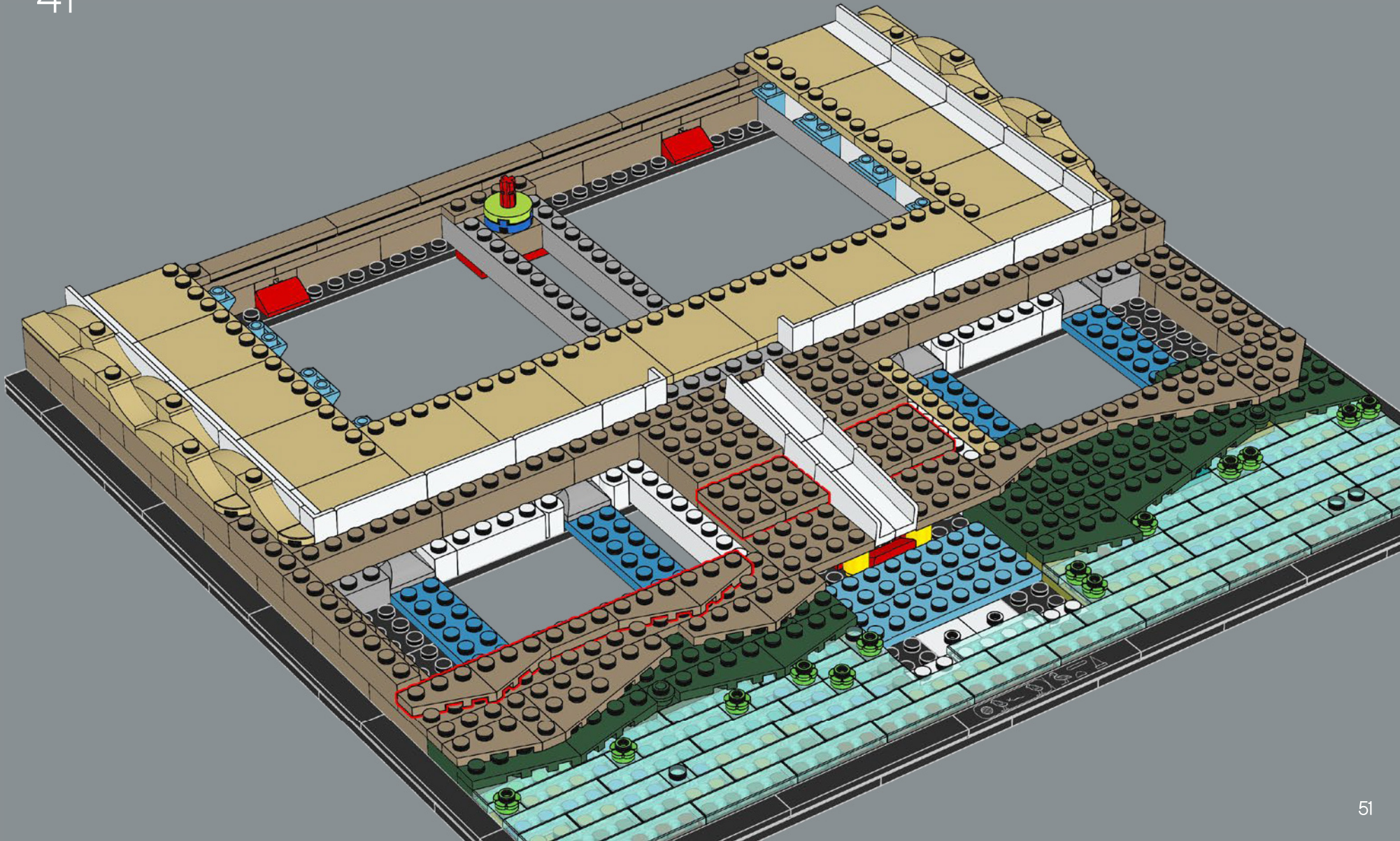



3x



3x



3x



3x



6x

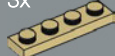

3x



3x



3x



3x

42

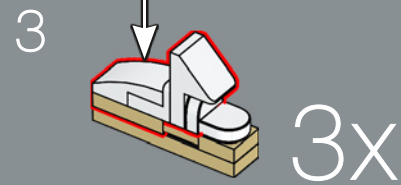
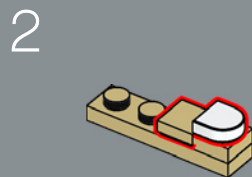
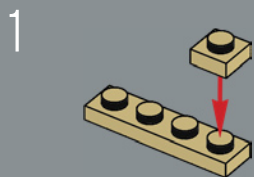
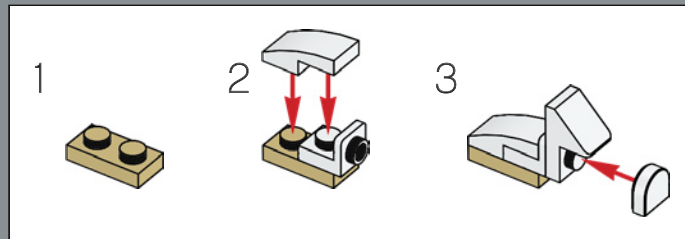

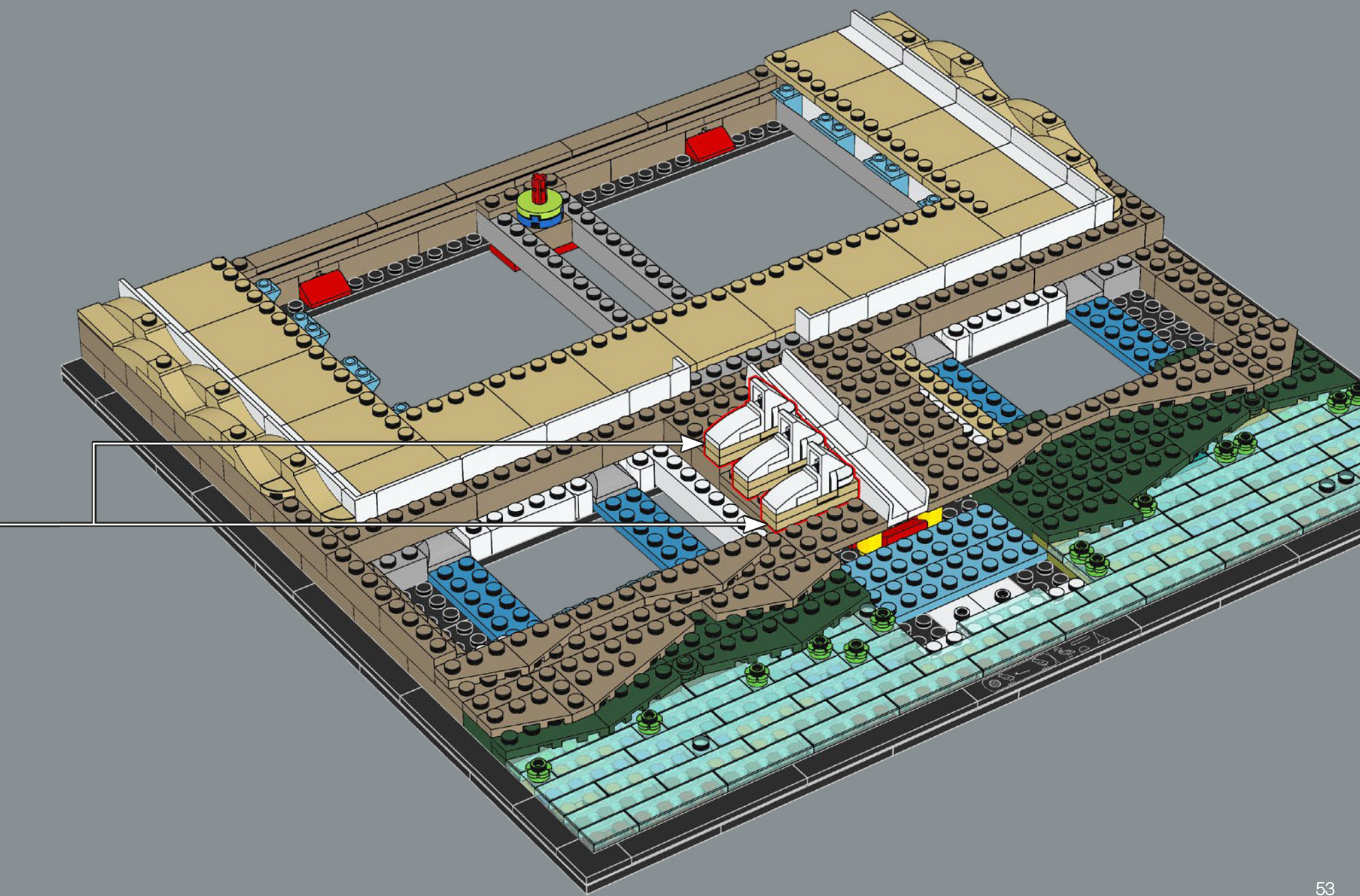

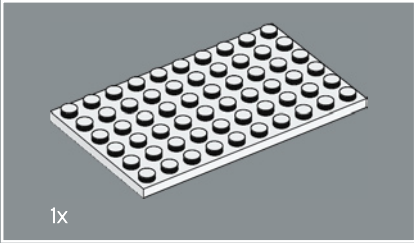
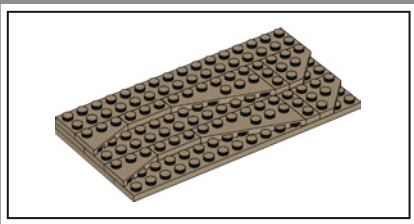

43

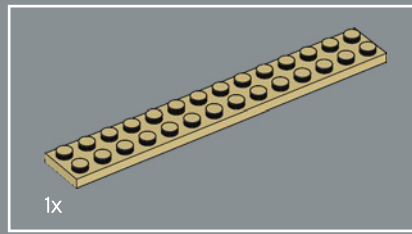
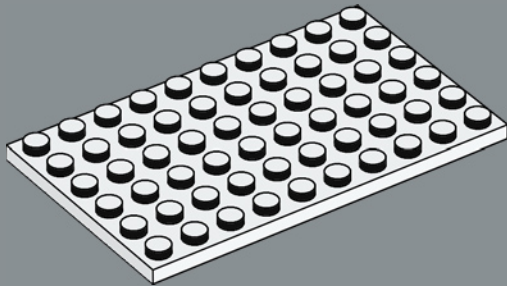

44

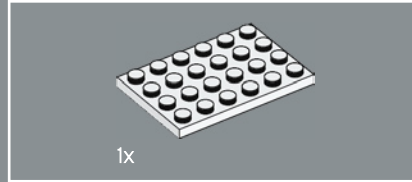
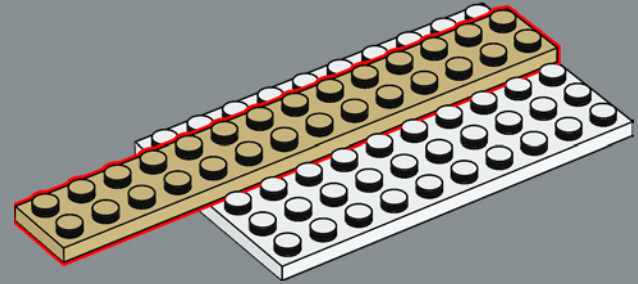

45

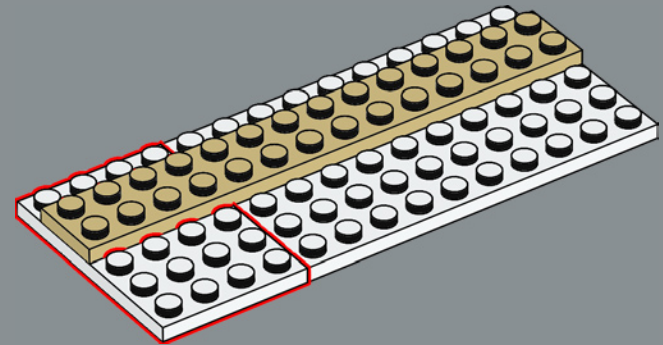

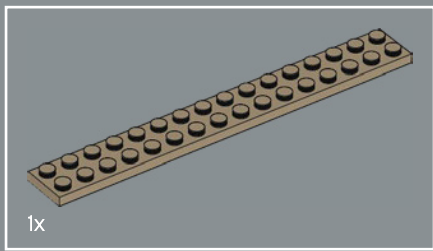

46

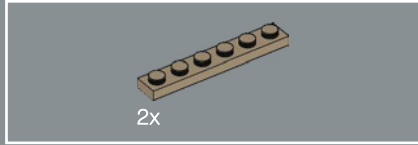
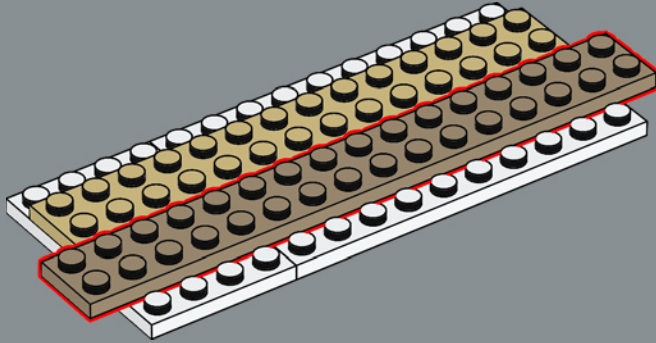

47

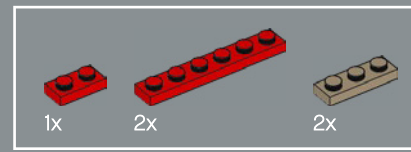
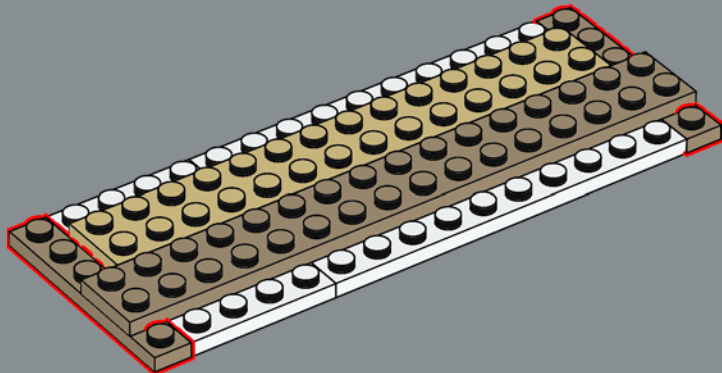

48

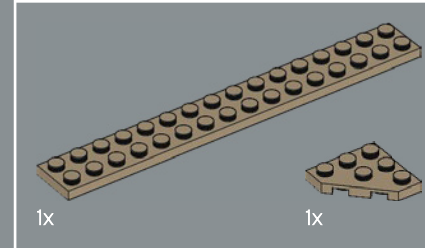
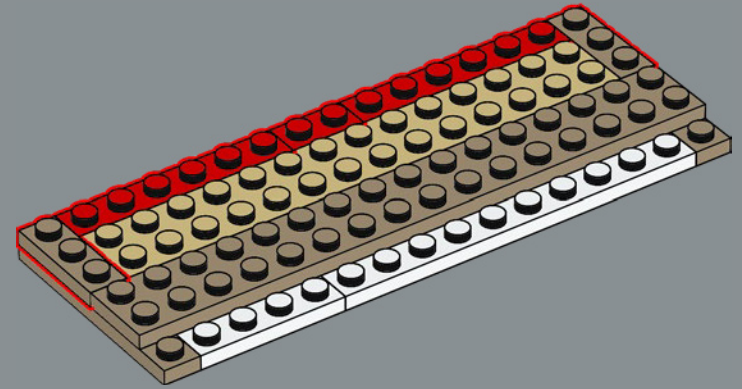

49

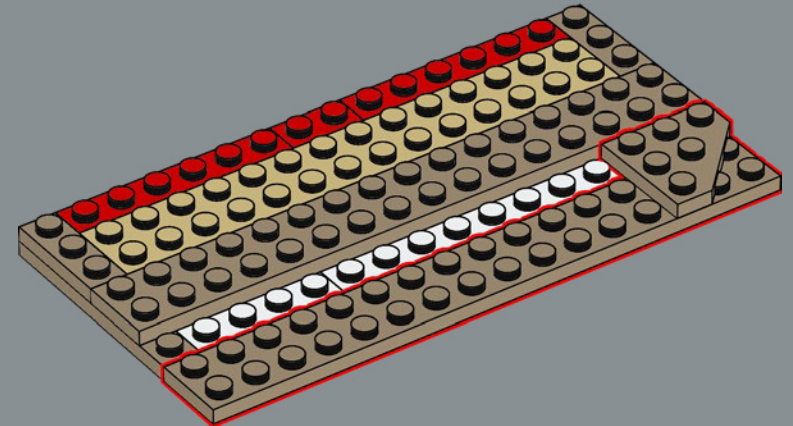

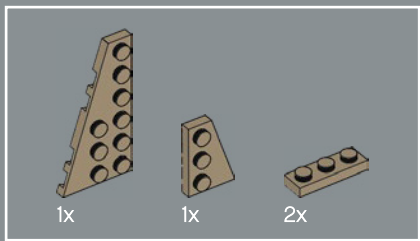

50

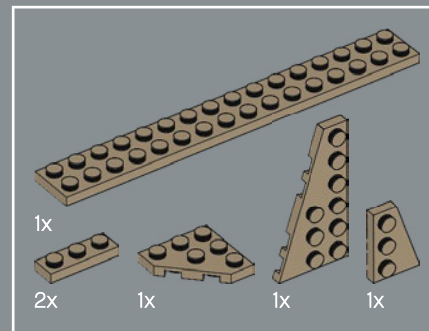
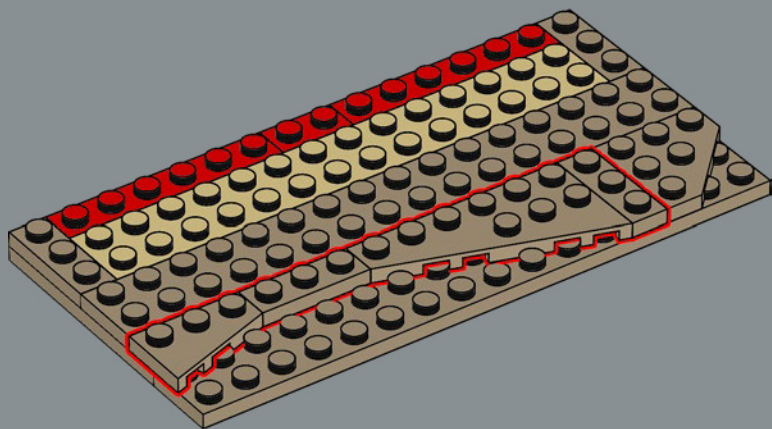

51

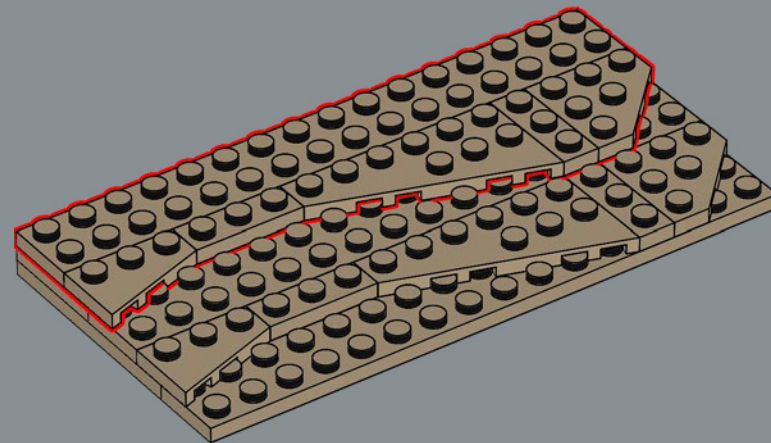

52

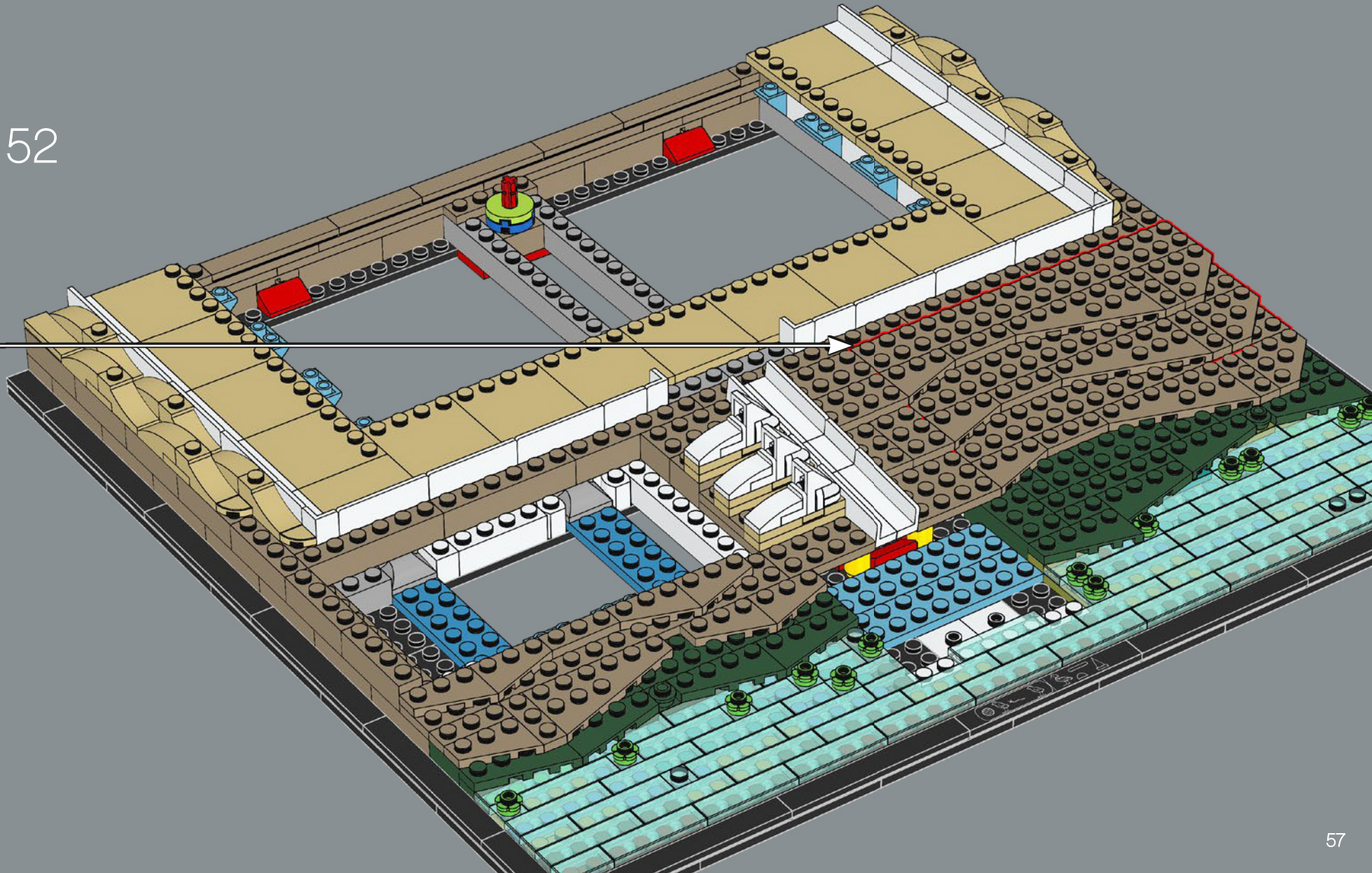

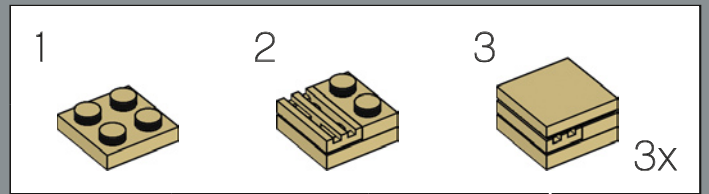
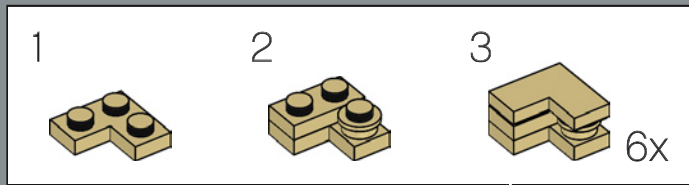
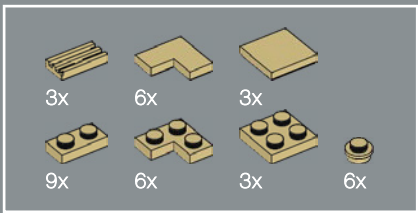

53

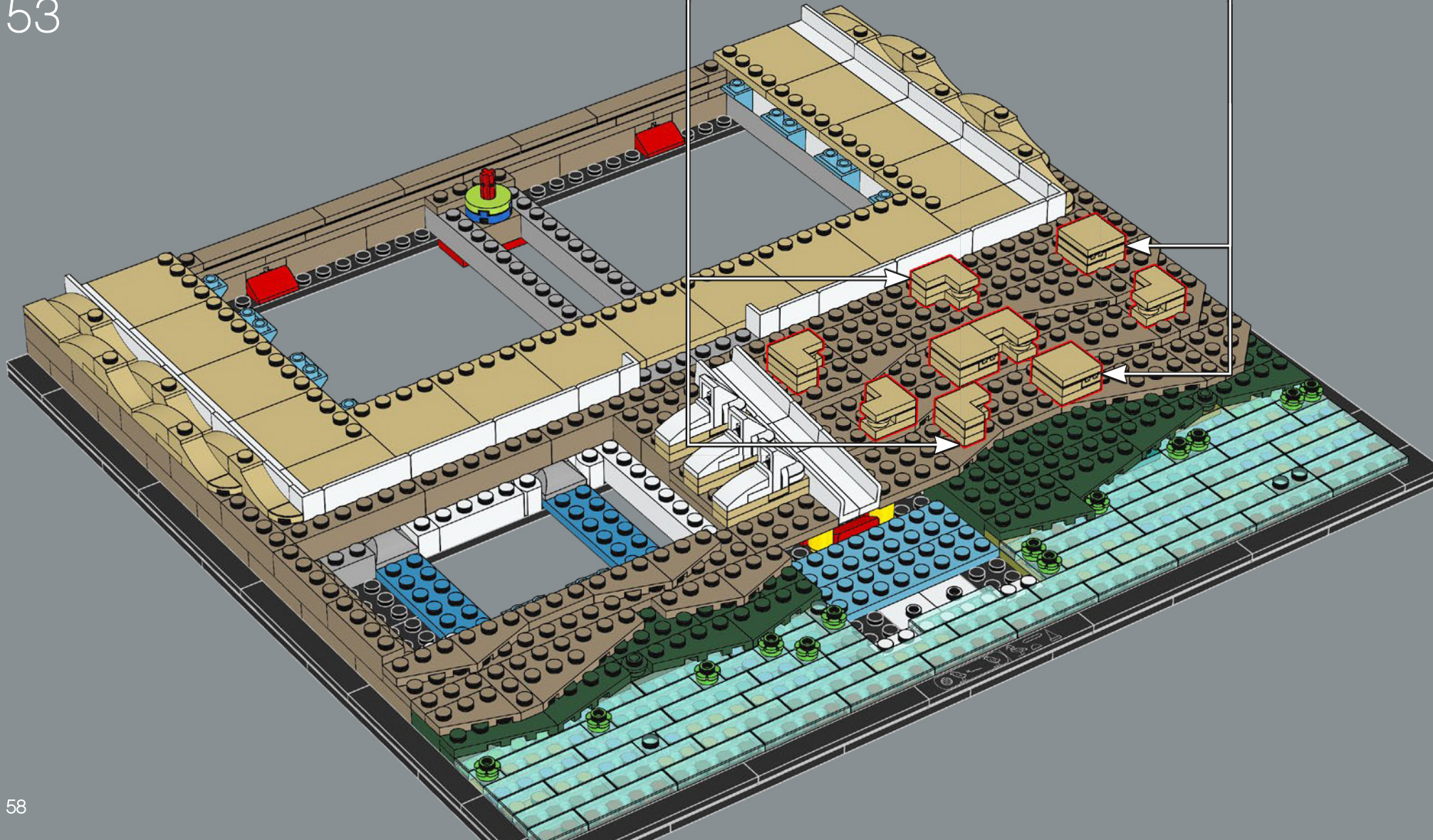

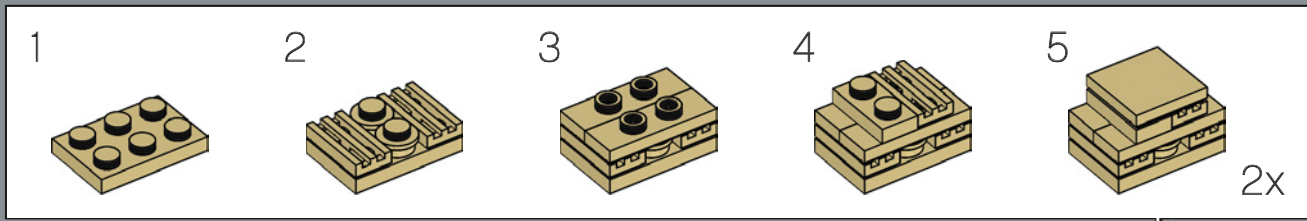
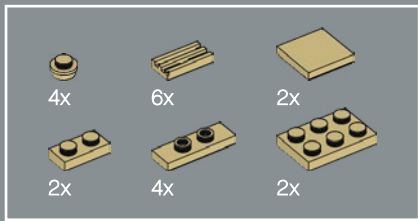

54

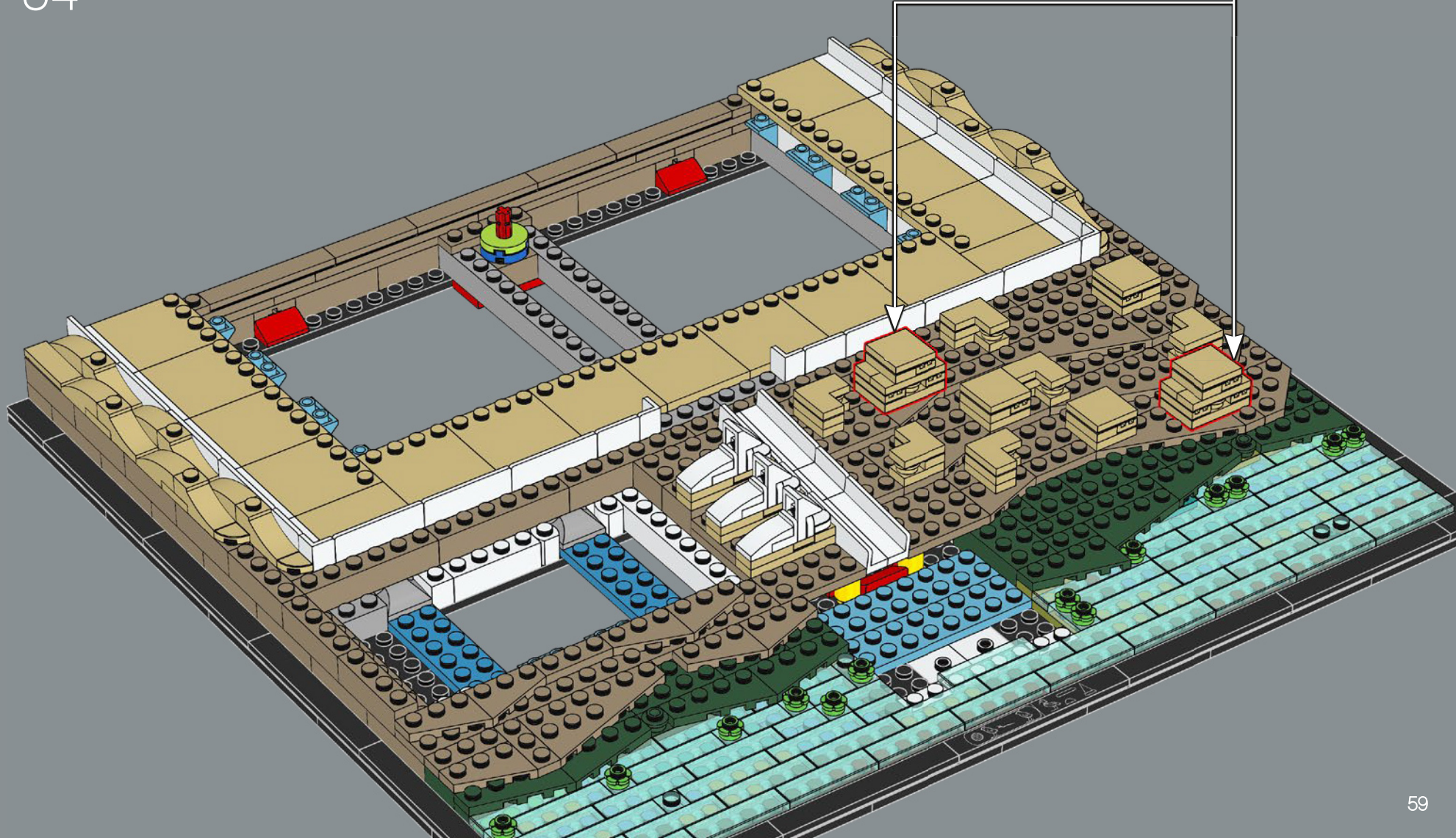

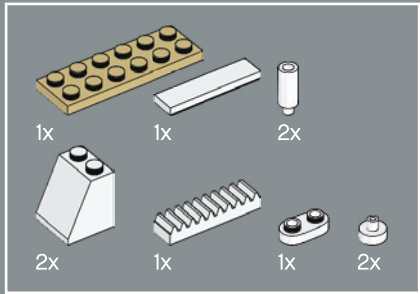

55

1

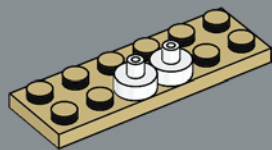

2

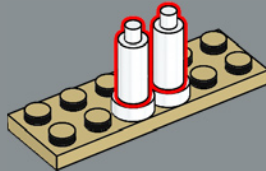

3

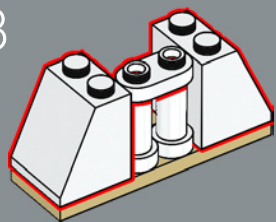

4

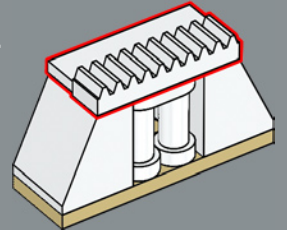

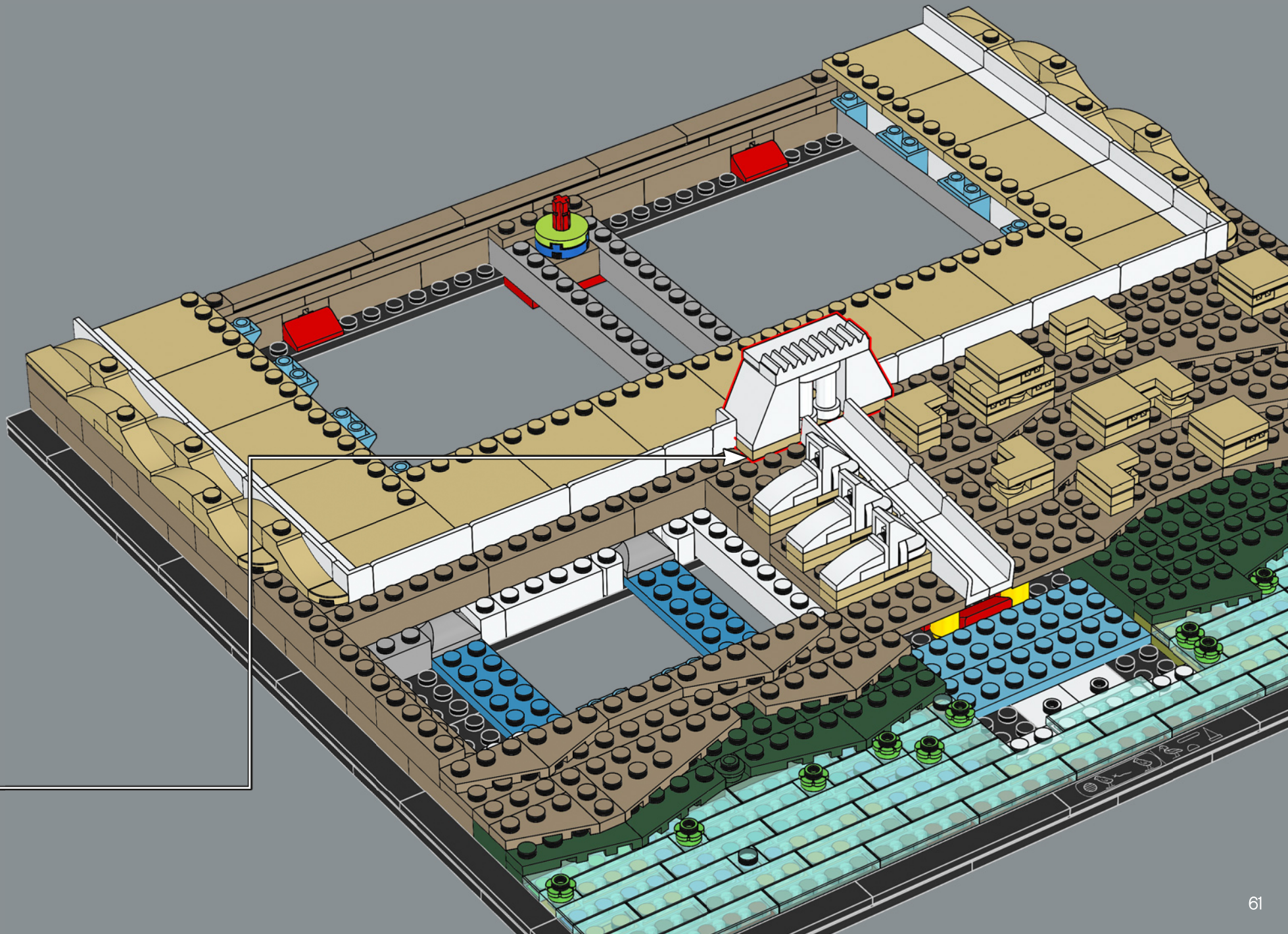

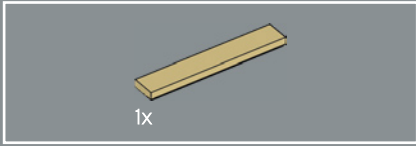
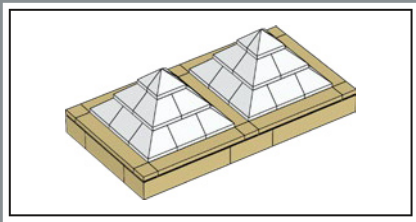

56

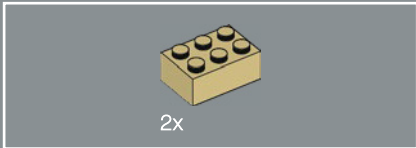
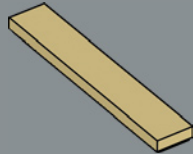

57

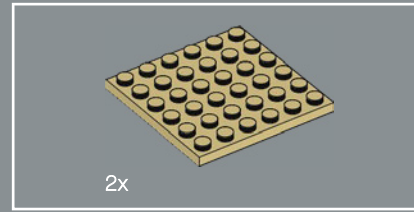
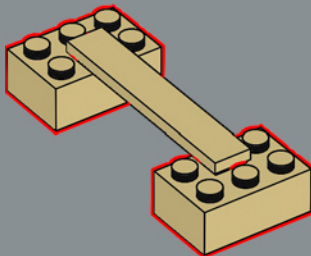

2x

58

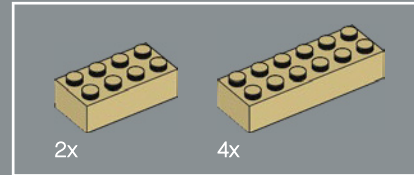
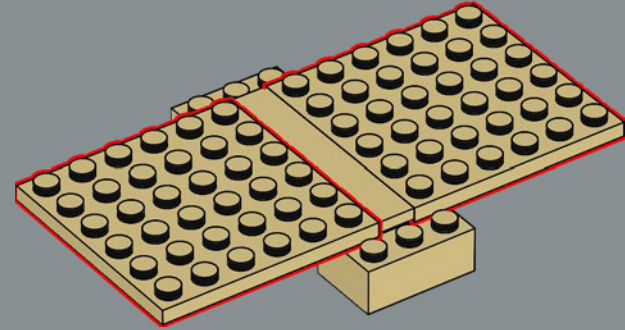

2x

4x

59

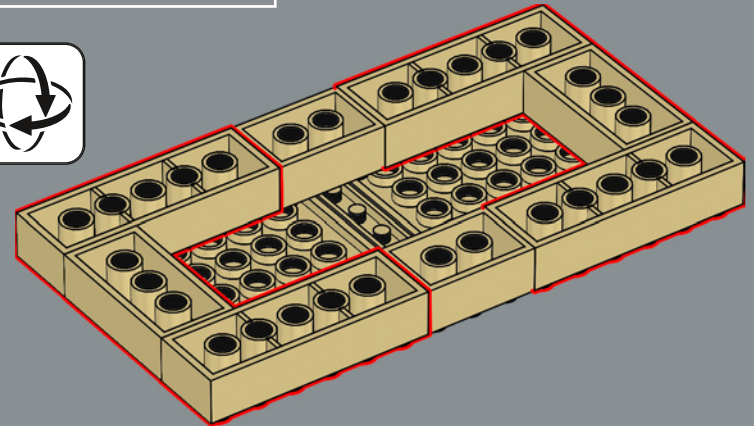

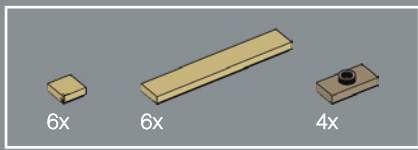

60

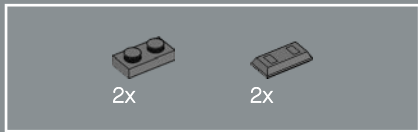
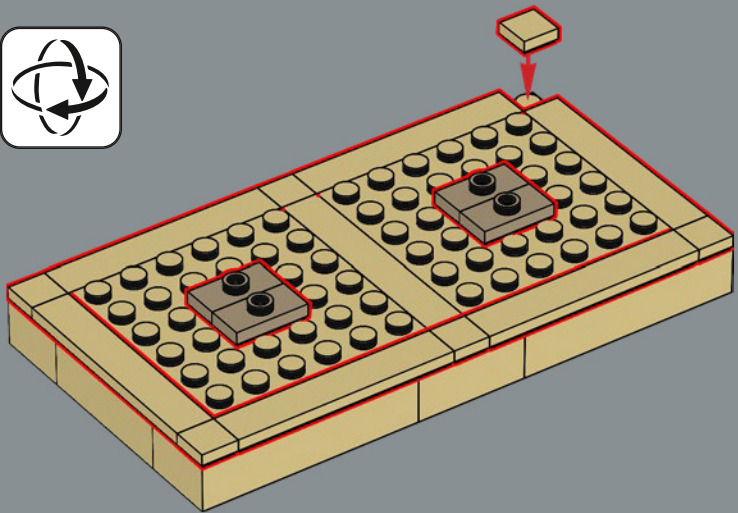

61

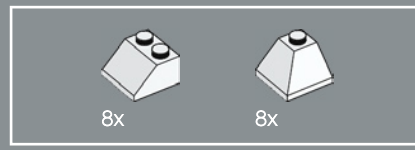
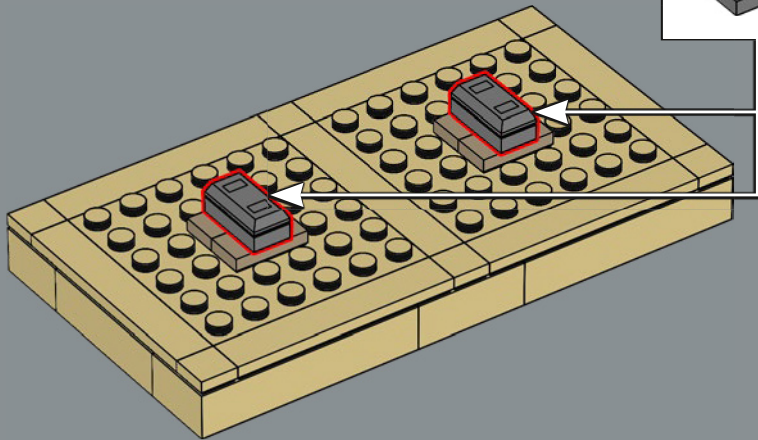
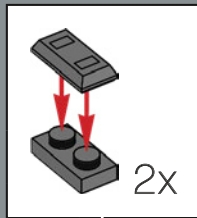

62

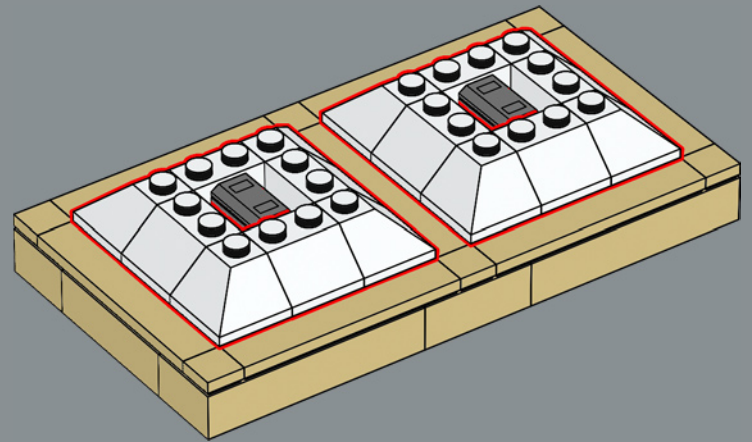



63

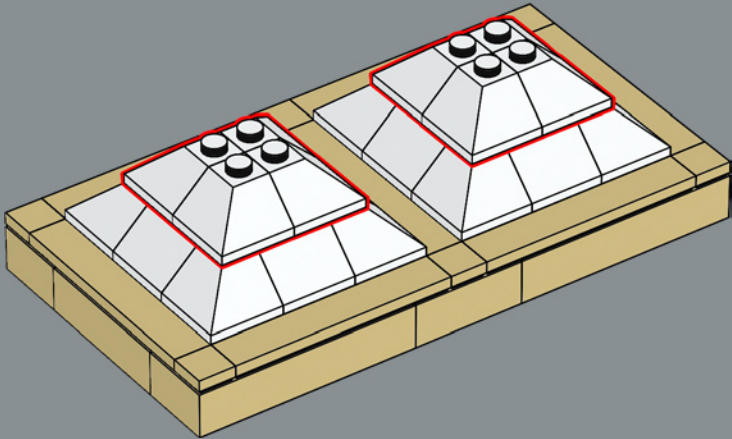

64

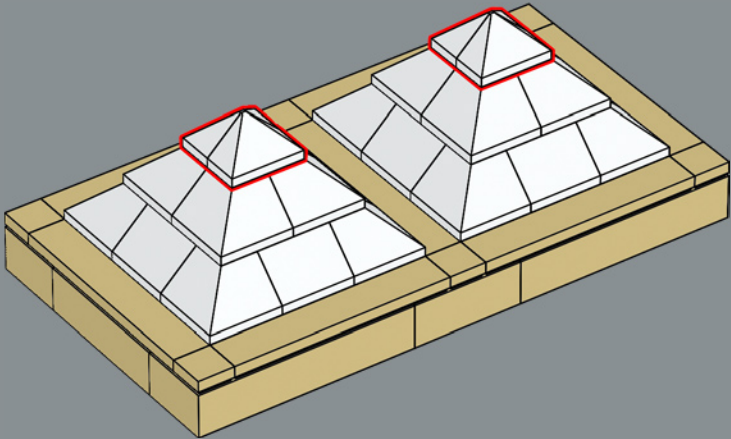

65

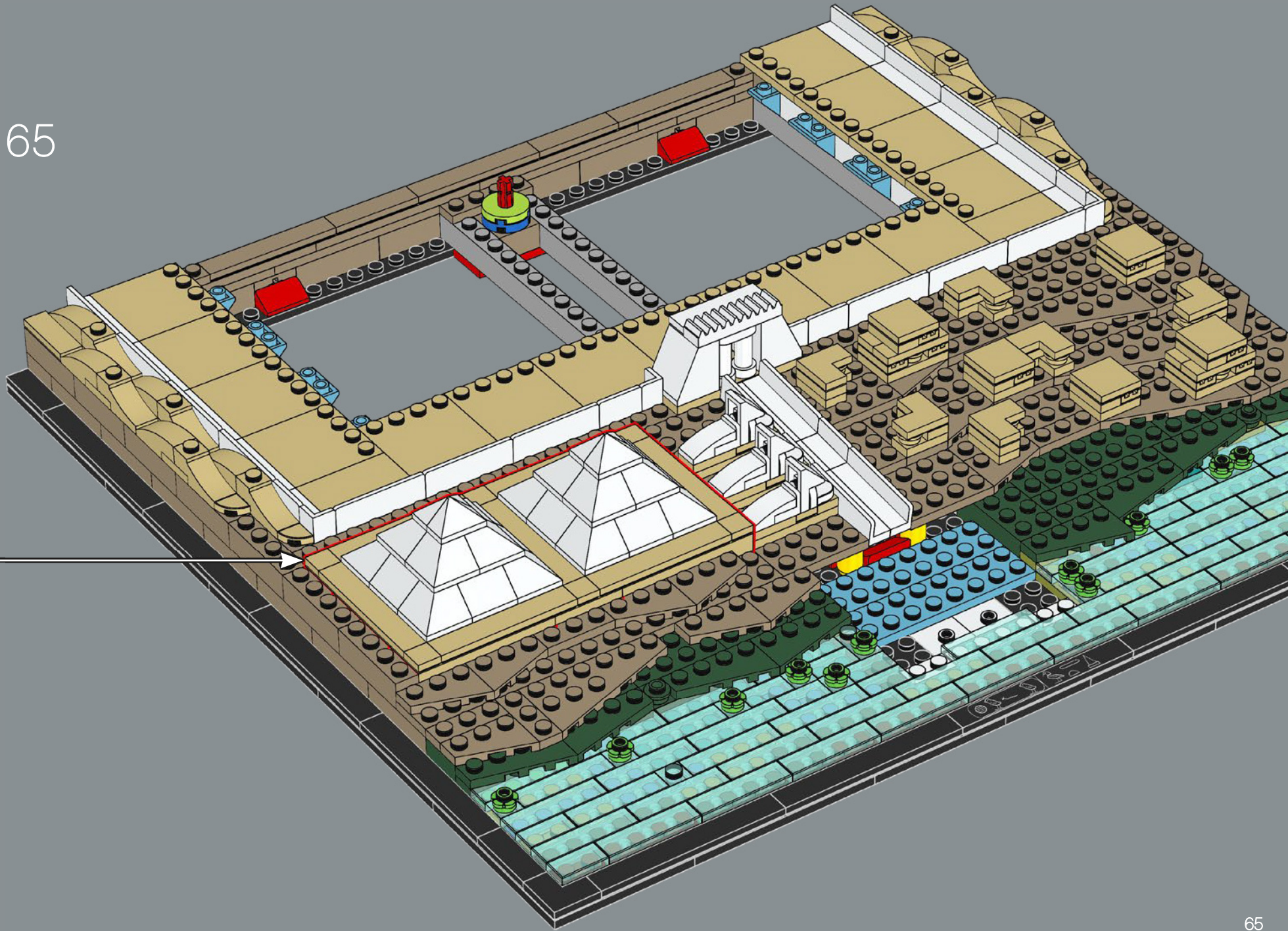

17x 6x 20x

66

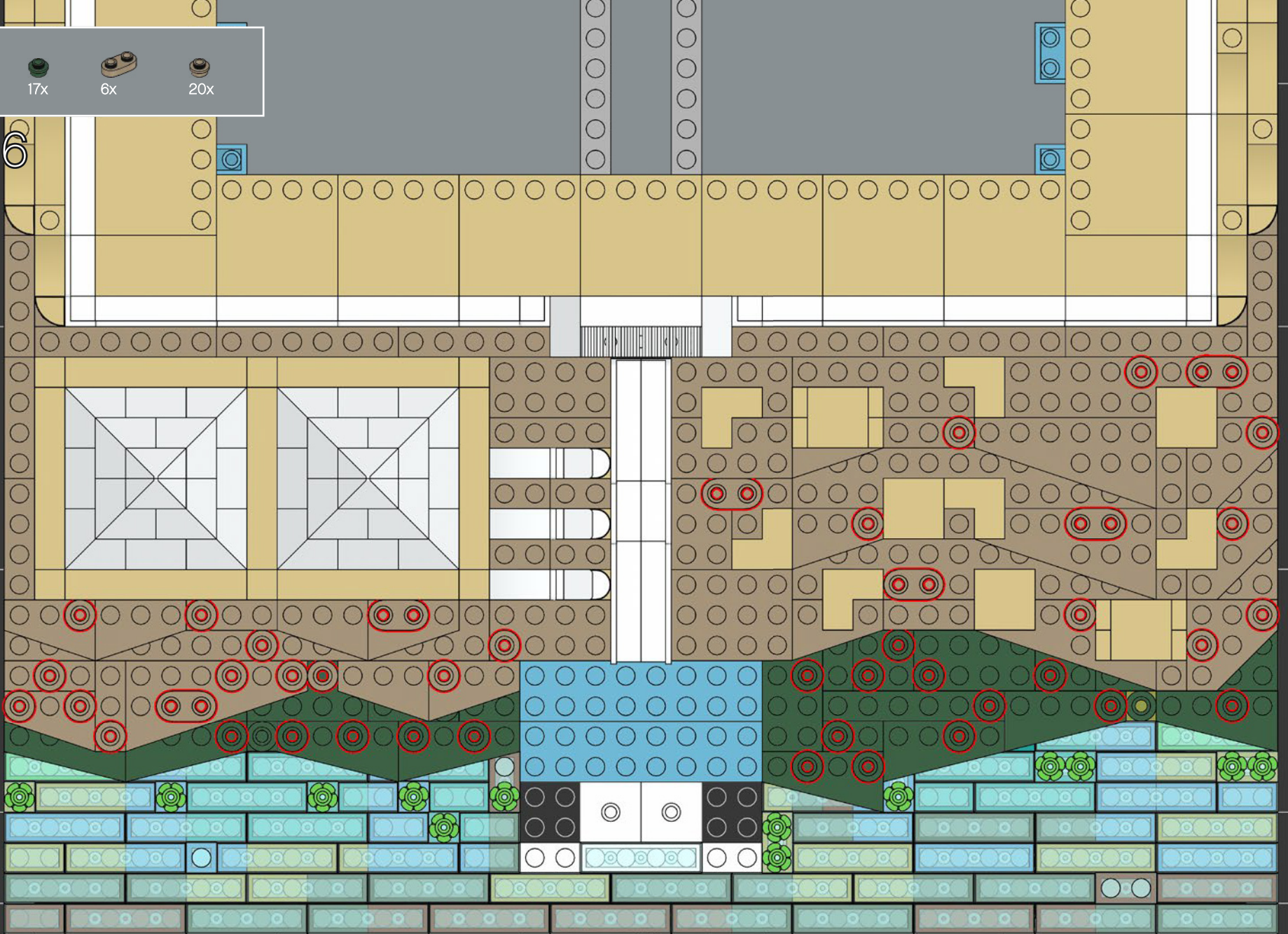



29x



16x

67

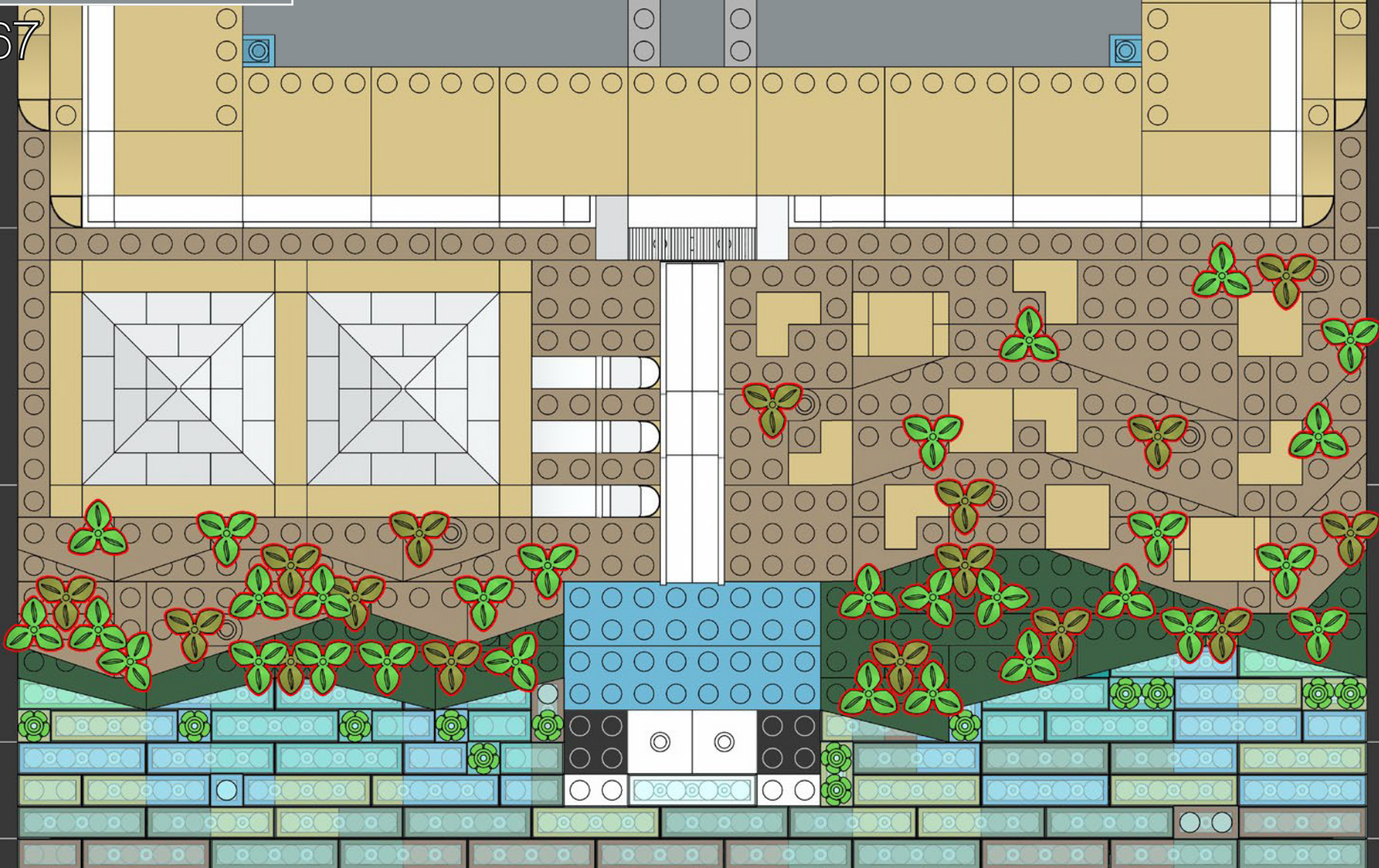

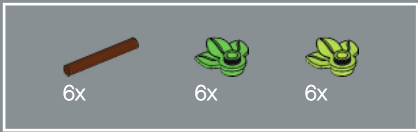

68

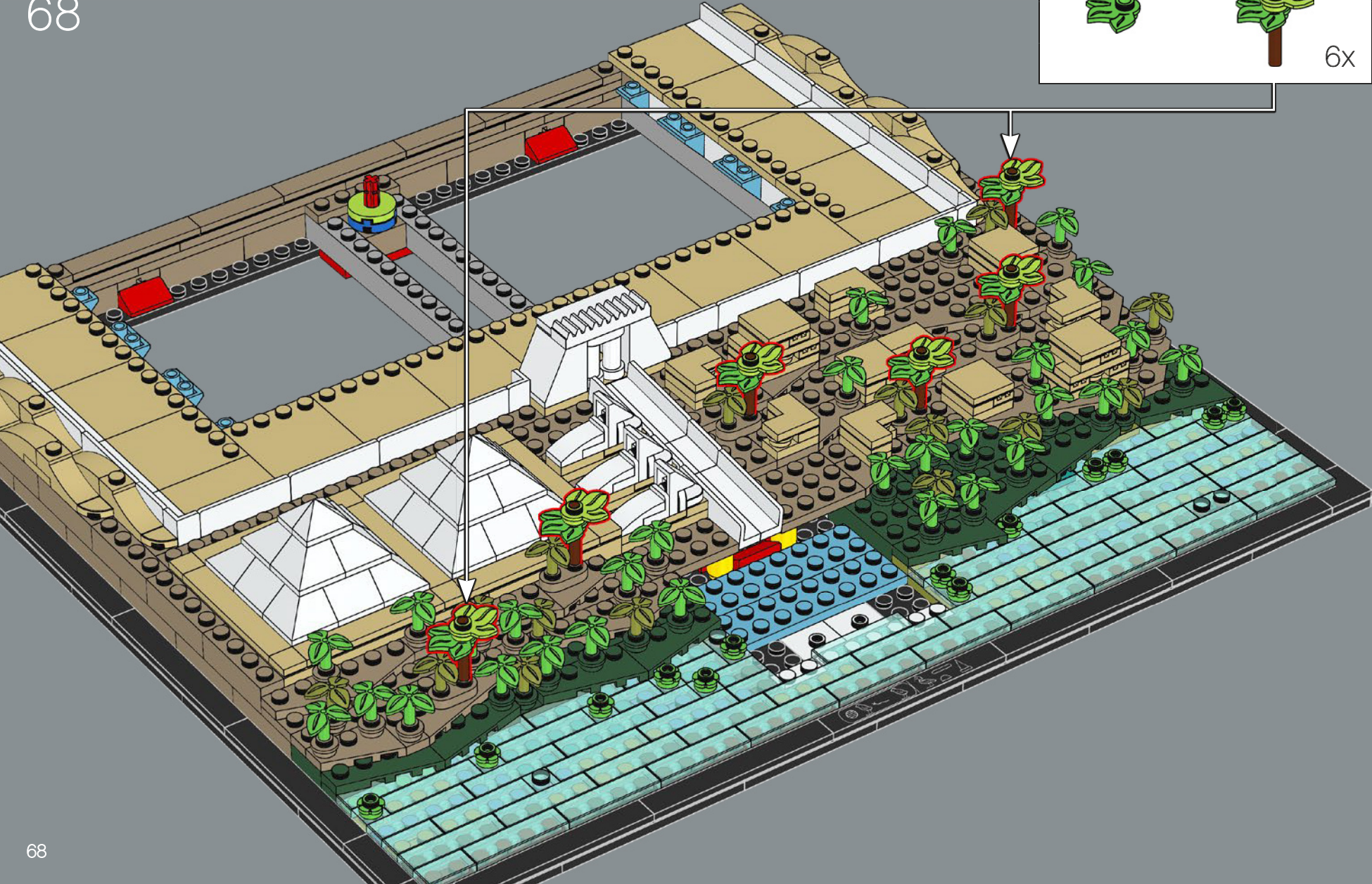
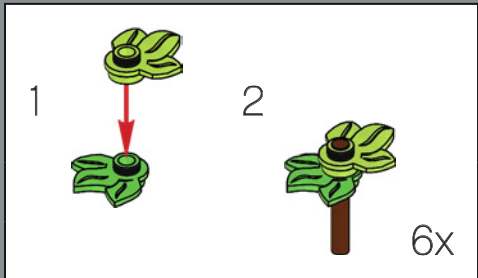

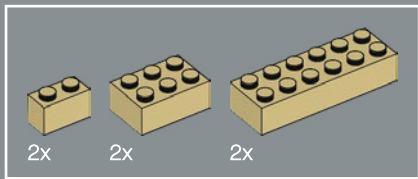

69



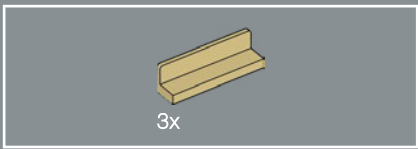

70

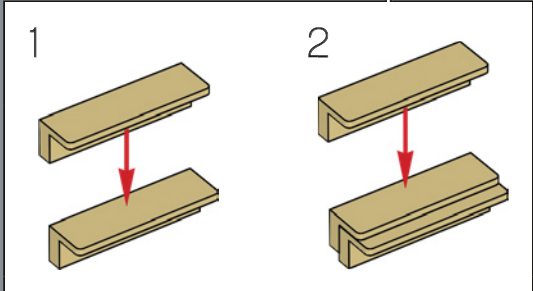
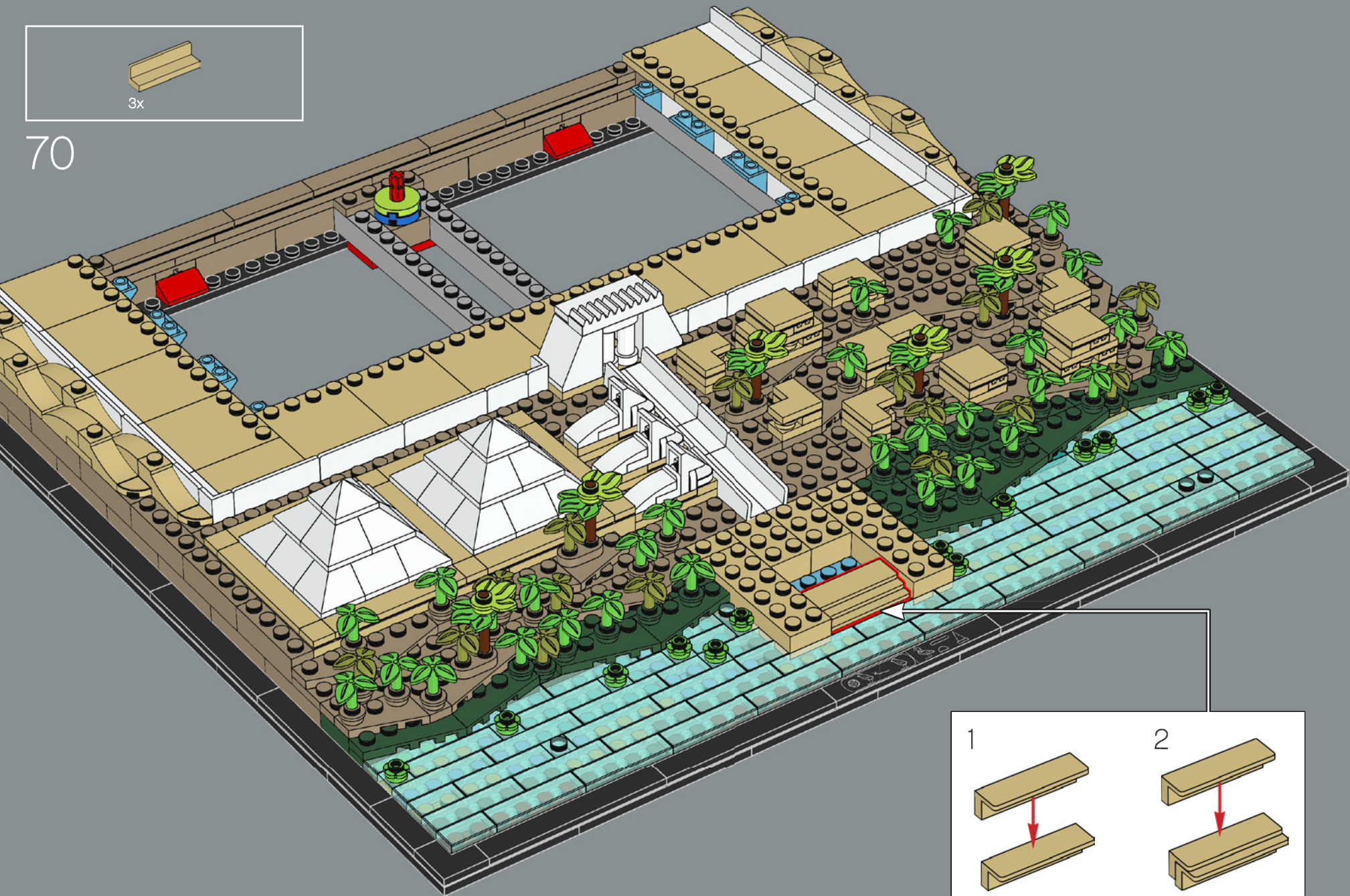

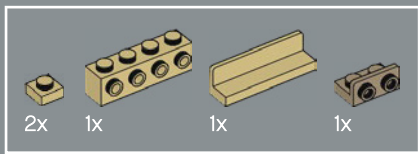

71

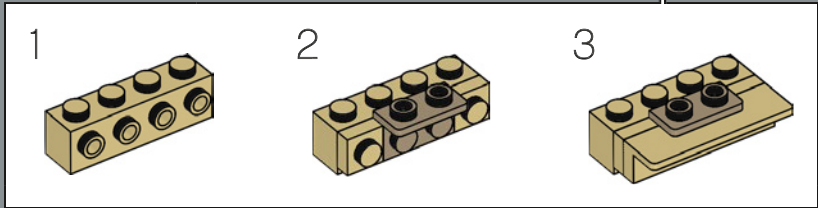
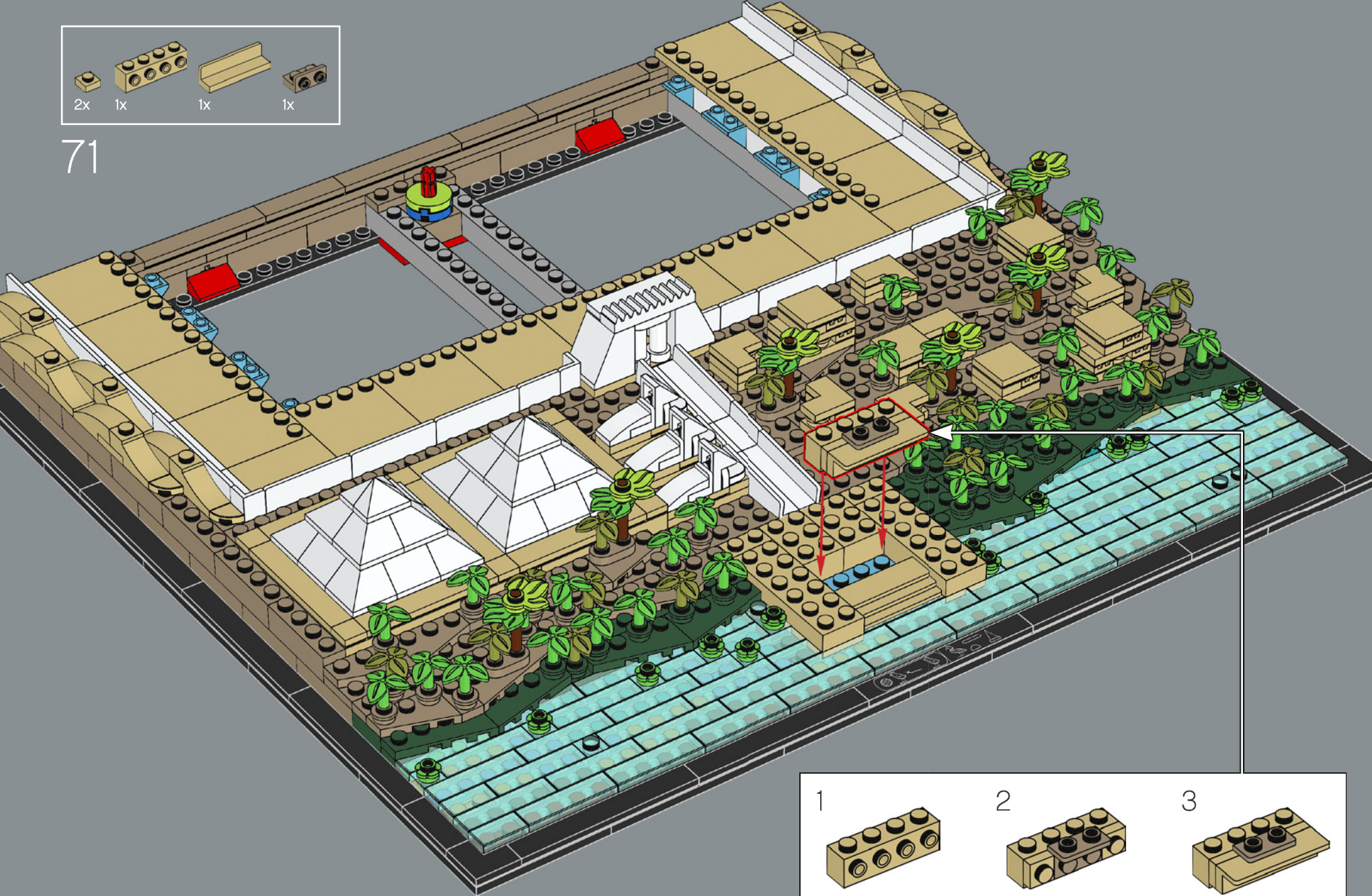

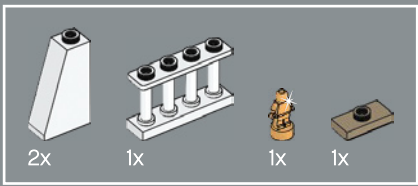

72

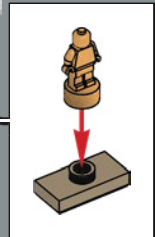

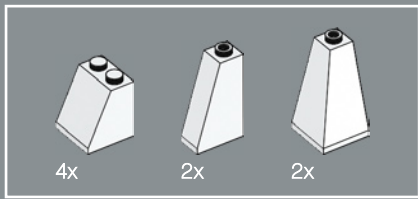

73





74

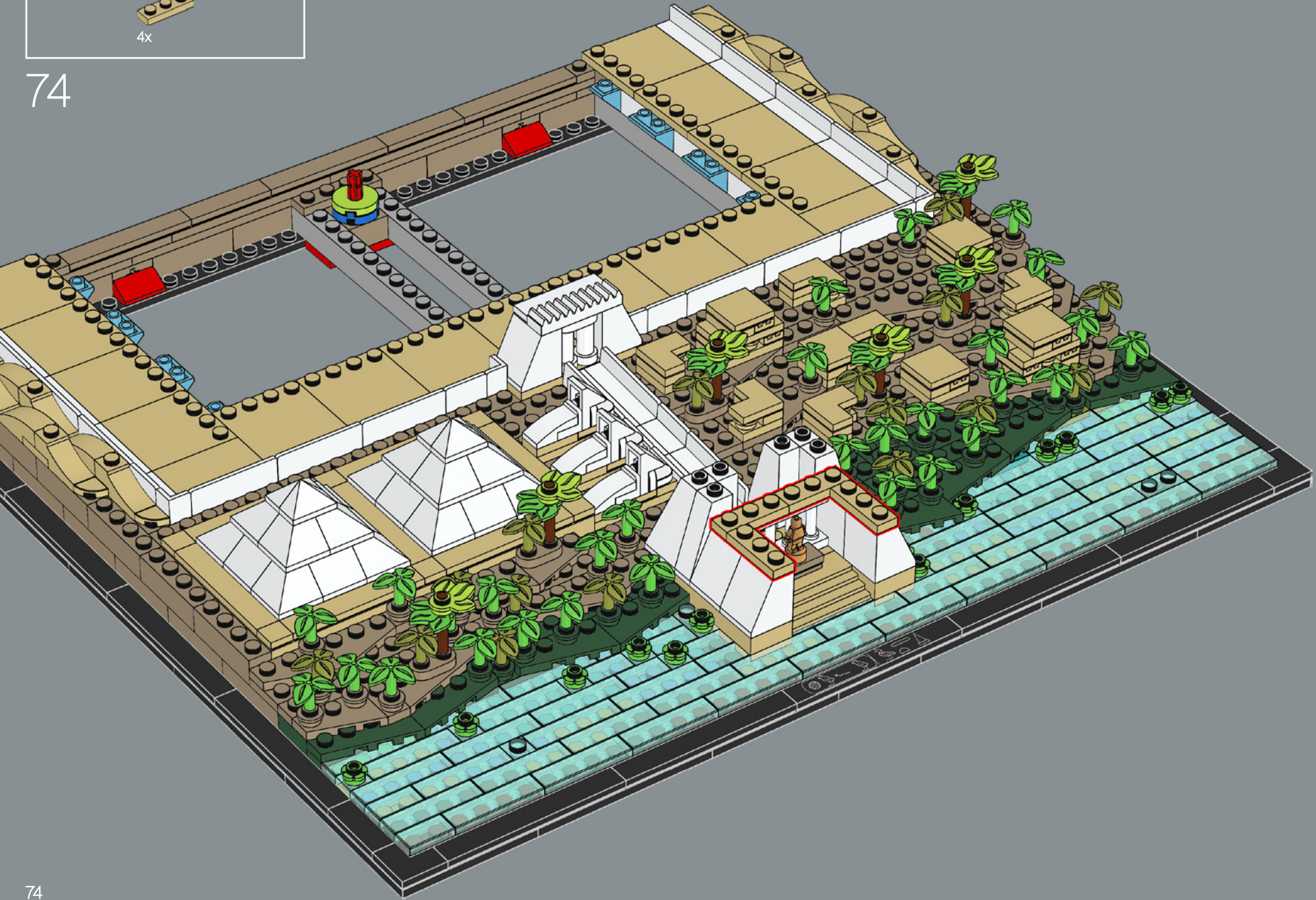

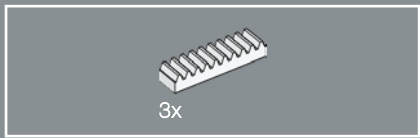

75



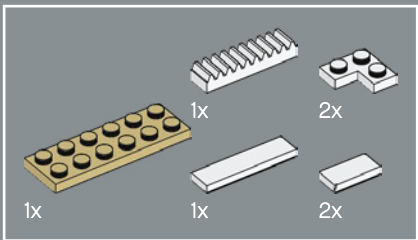

76

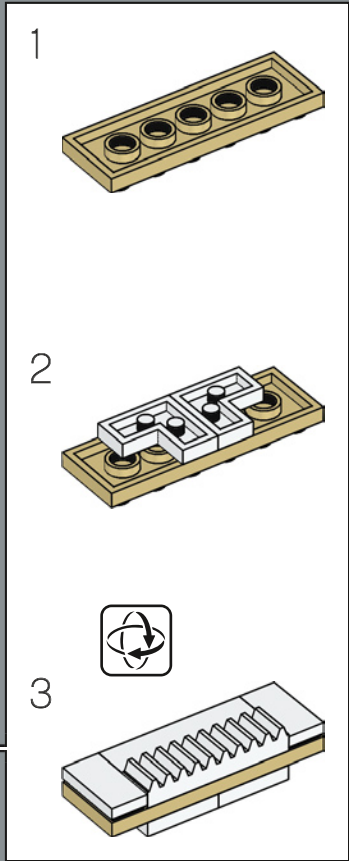

76

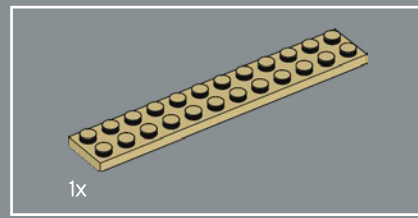

77

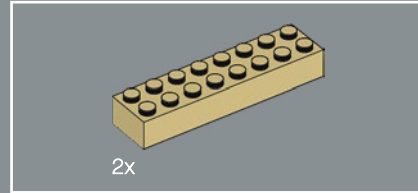
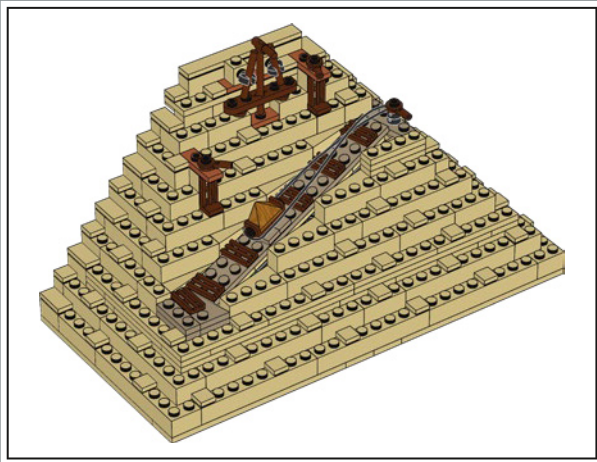
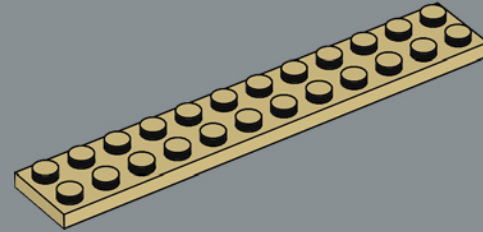

78

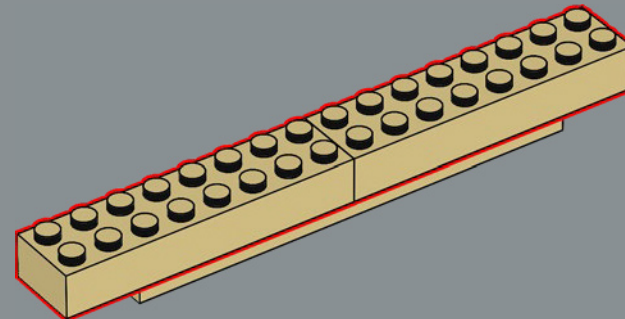

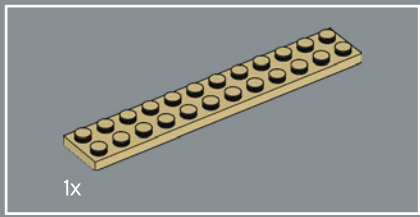

79

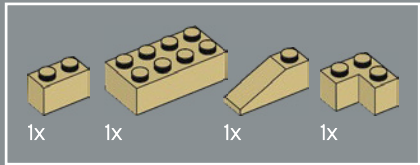
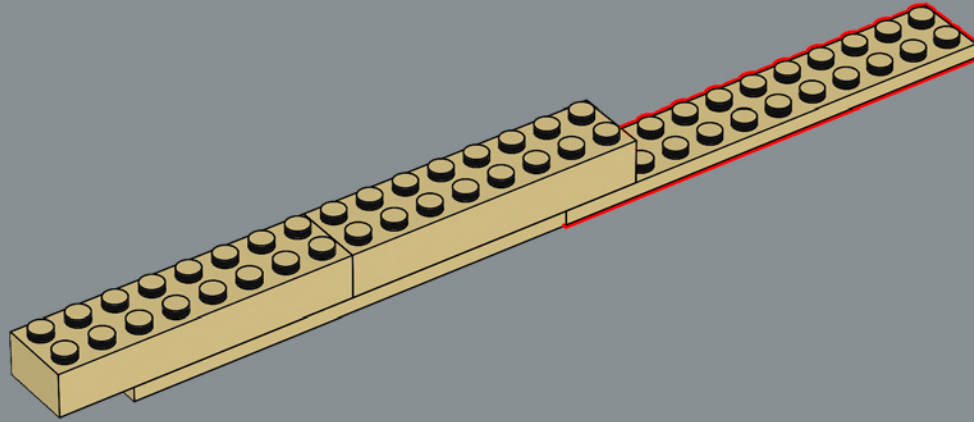

80

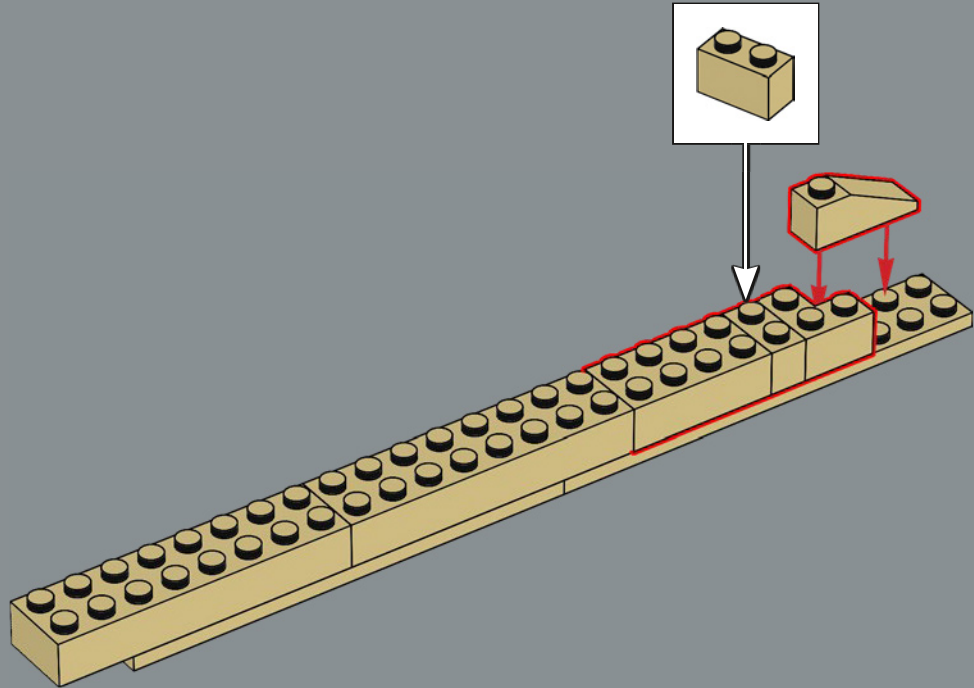

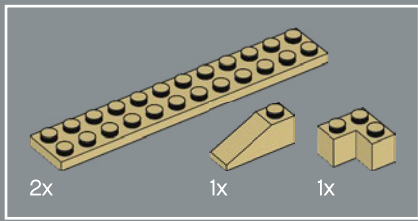

81

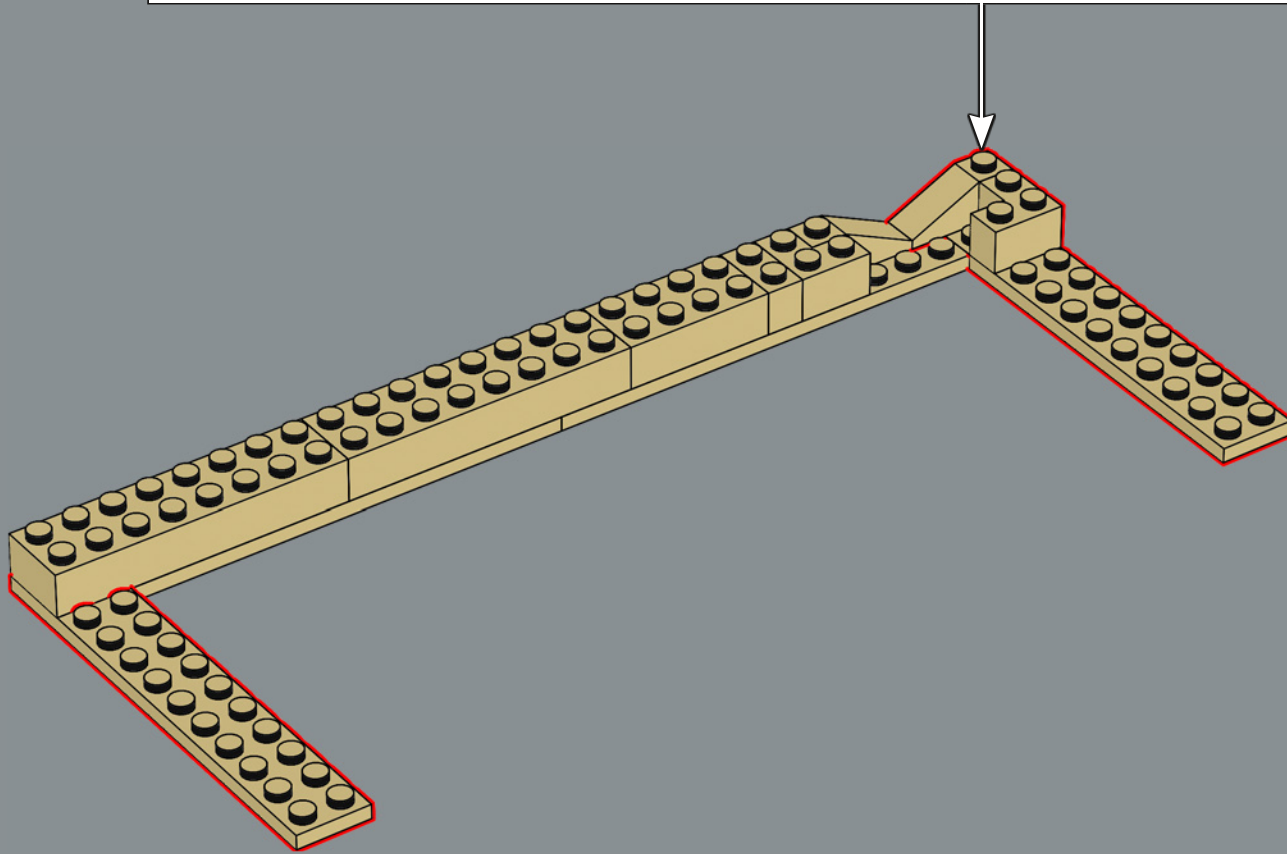
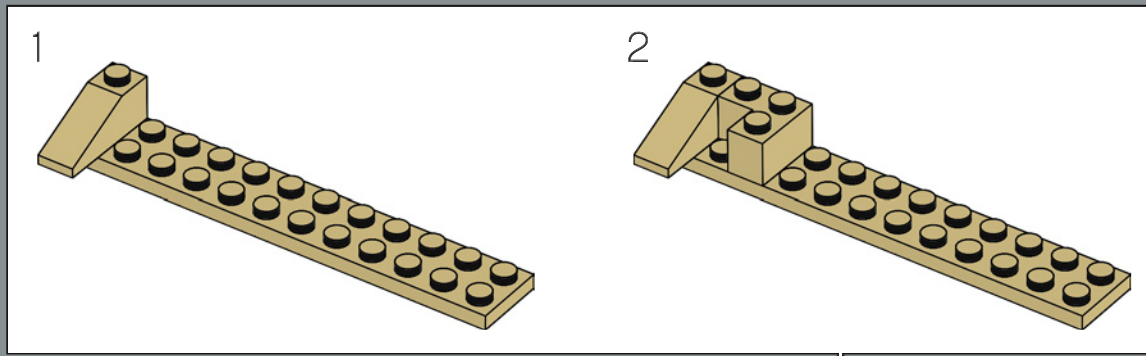

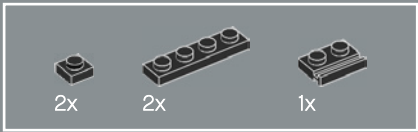

82

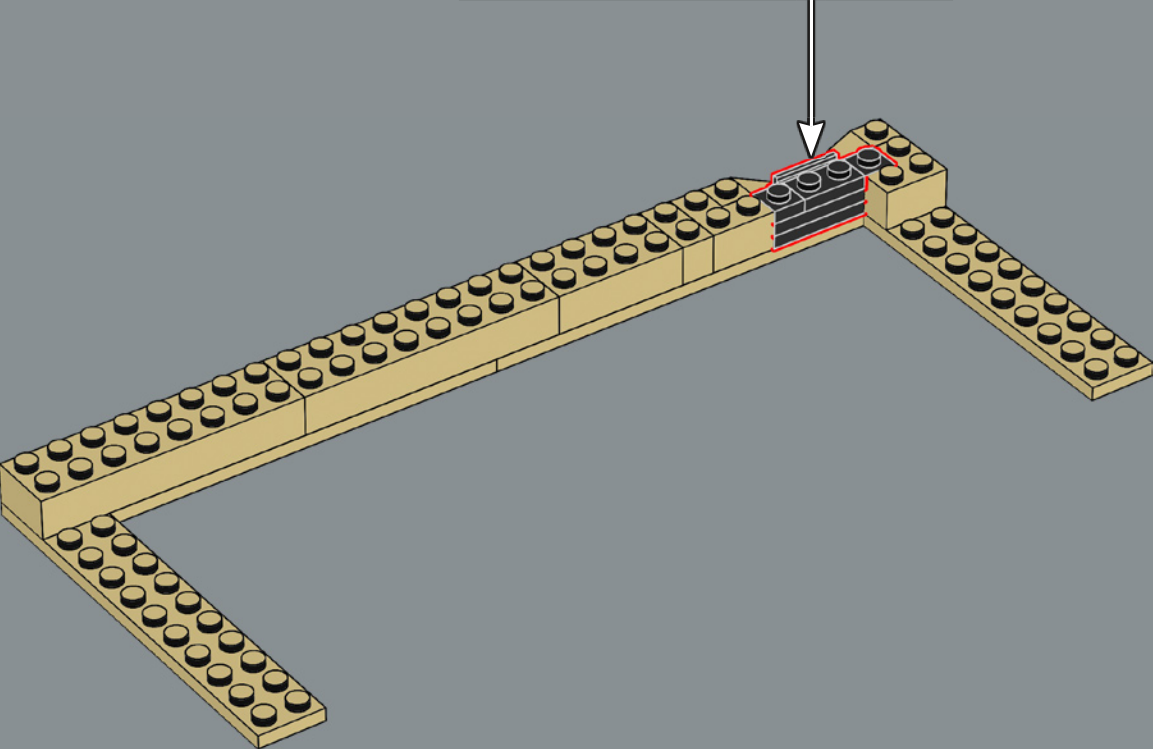
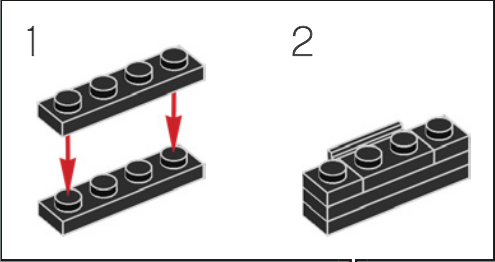

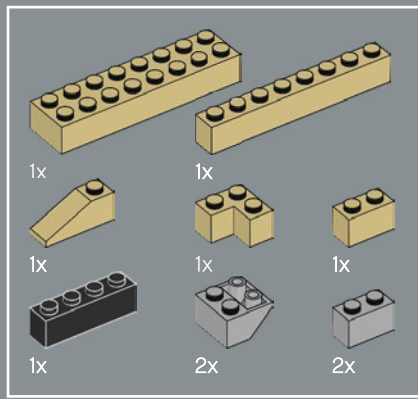

83

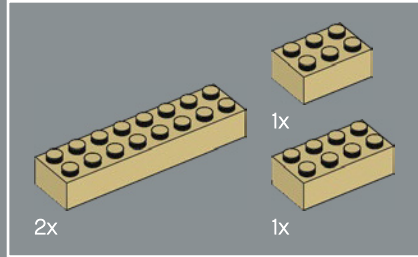
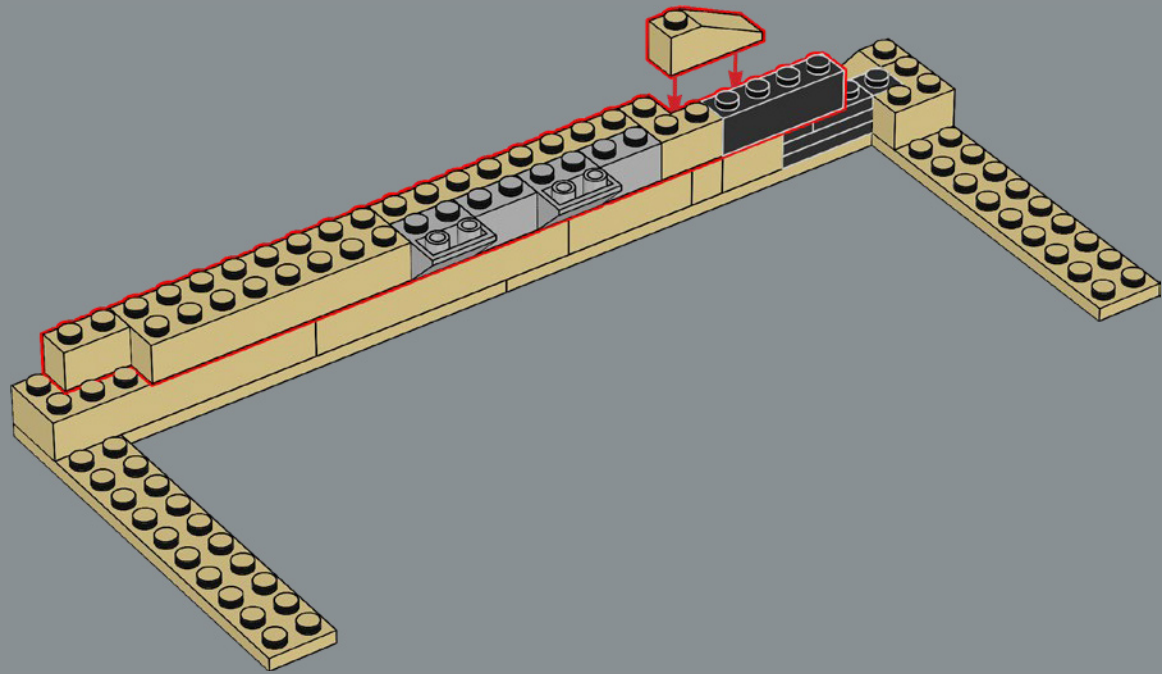

84

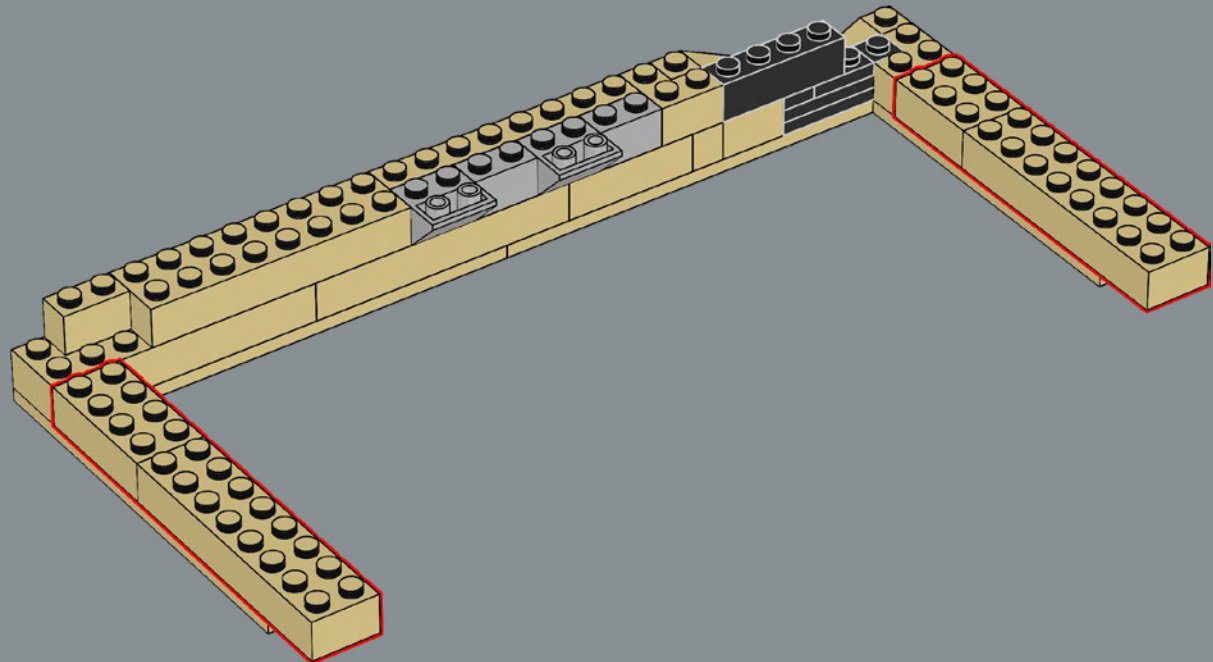

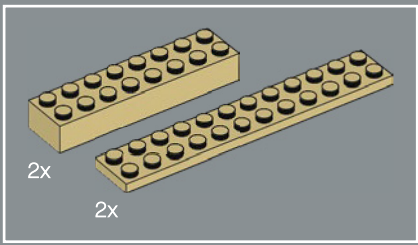

85

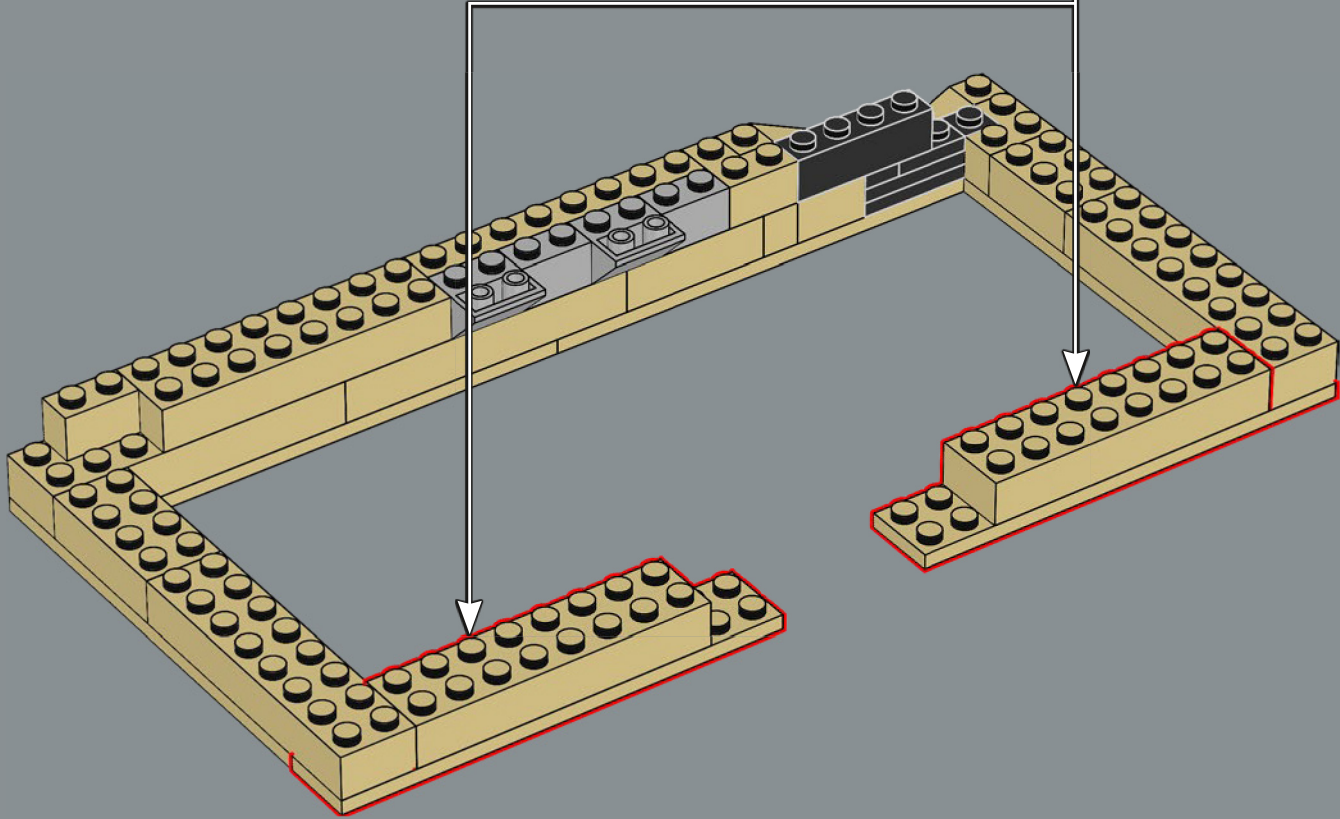
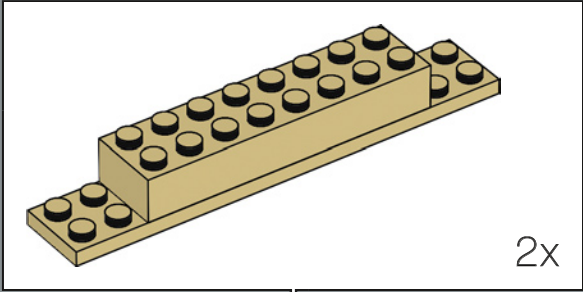

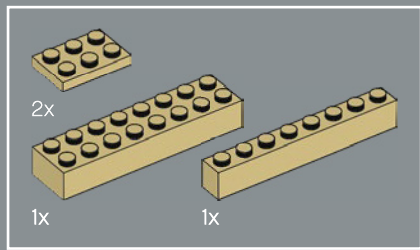

86

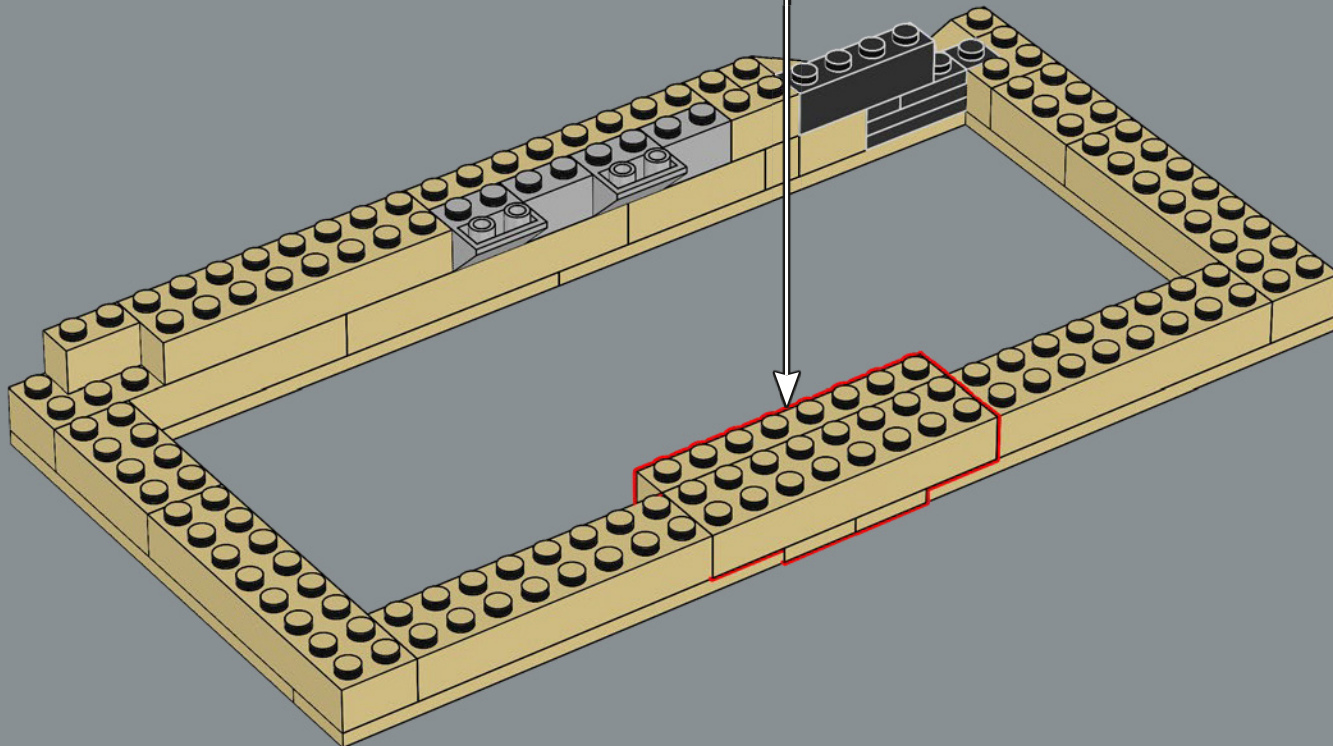
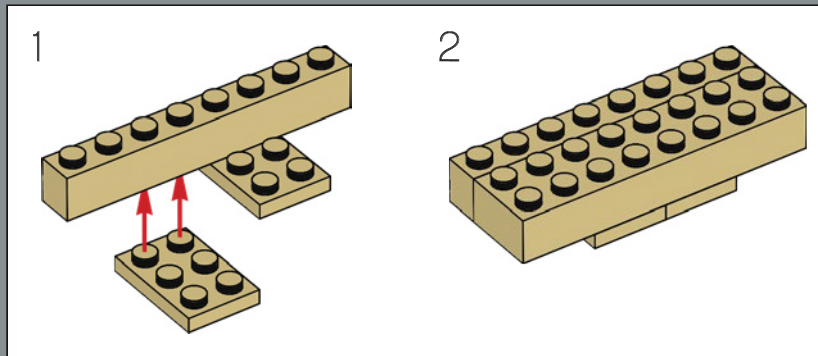

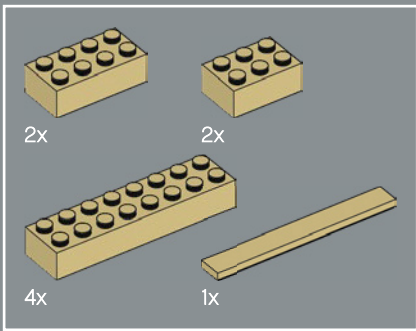

The largest of these blocks that were used to construct the Great Pyramid weighed up to 88.1 tons (80 metric tonnes).

Les plus grands blocs de pierre utilisés pour construire la pyramide de Khéops pesaient jusqu'à 80 tonnes métriques.

De los bloques que se utilizaron para construir la Gran Pirámide, los más grandes llegaban a pesar 80 t.

87

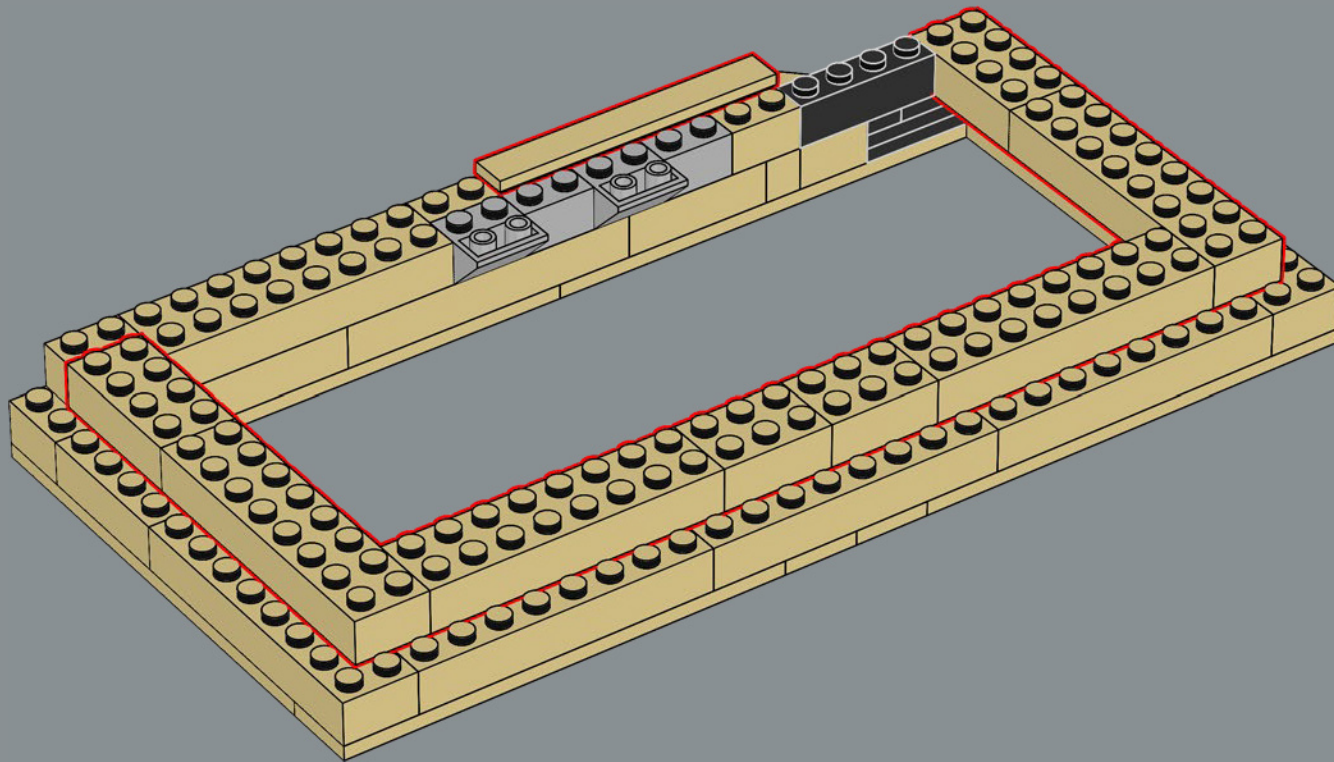

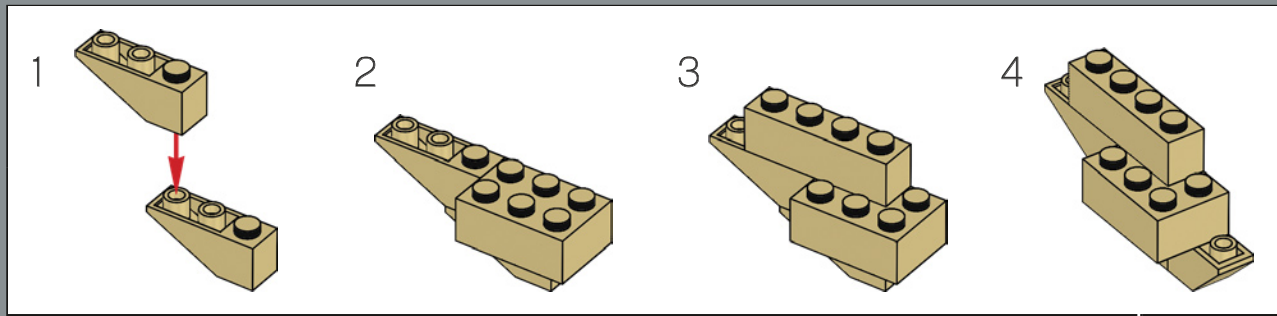
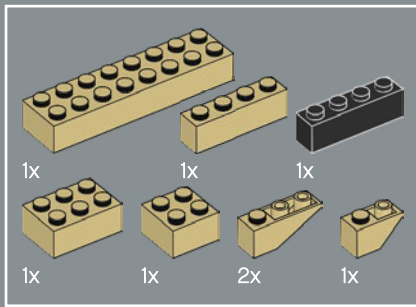

88

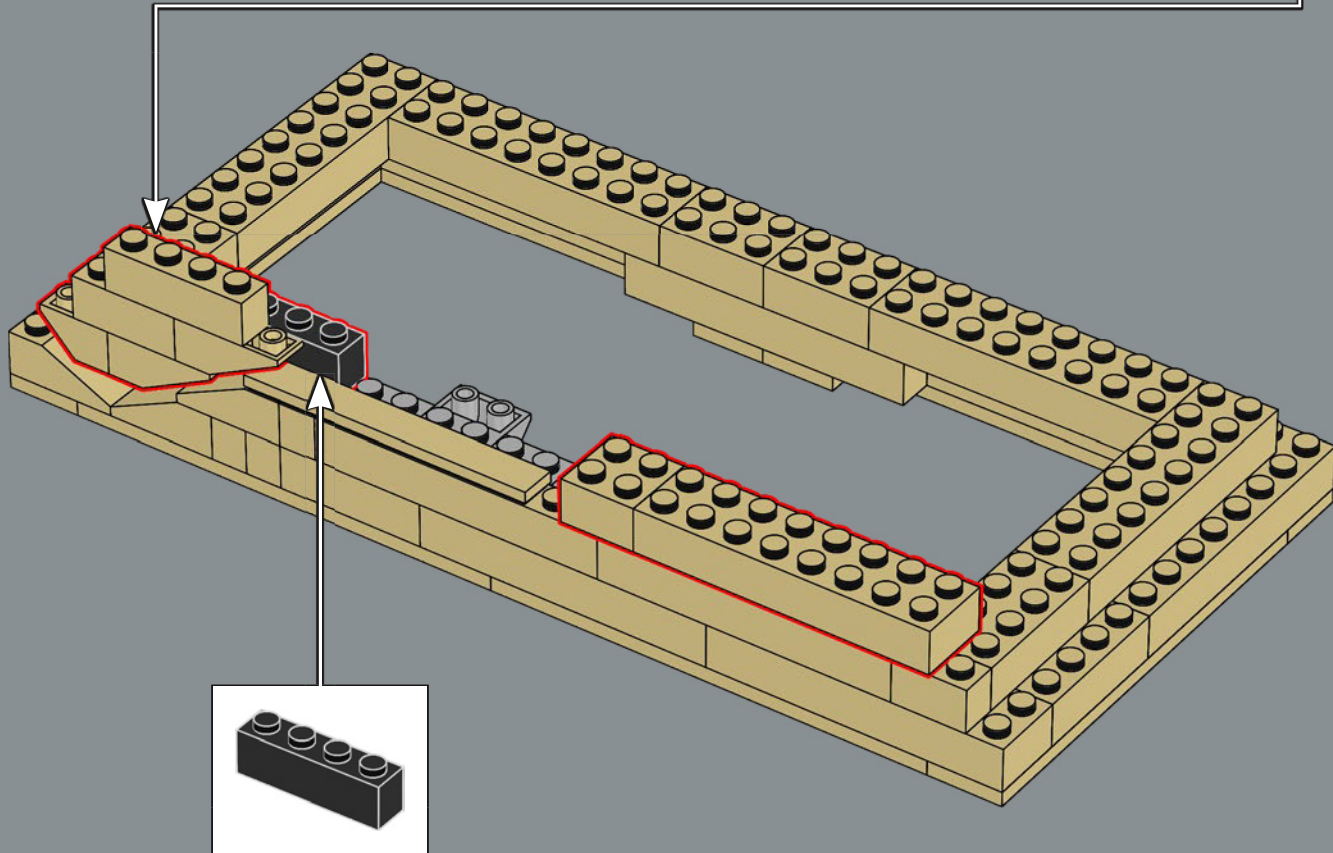

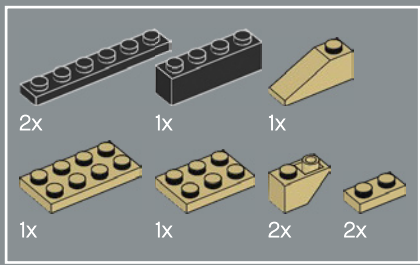

89

1

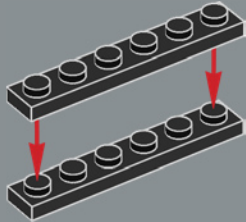

2

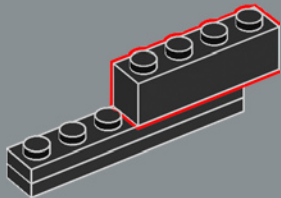

3

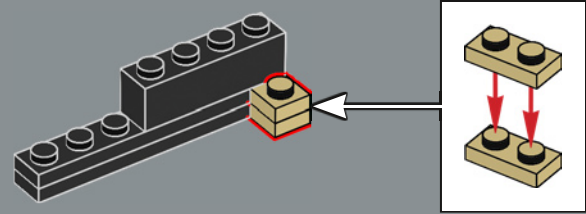

4

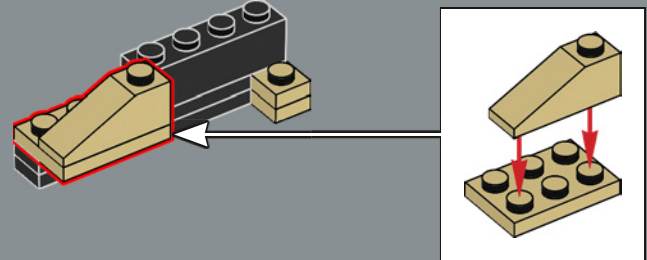

5

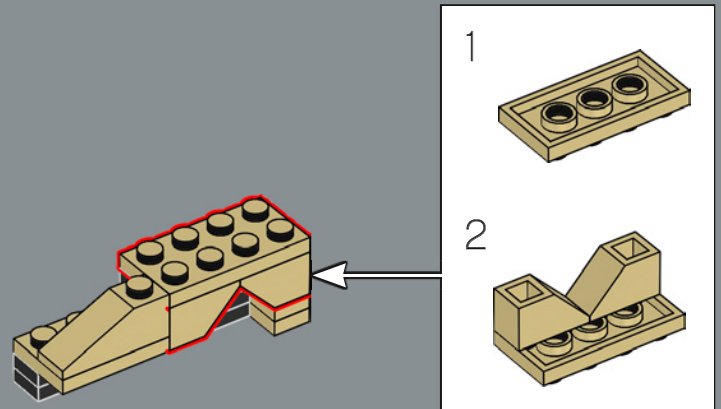

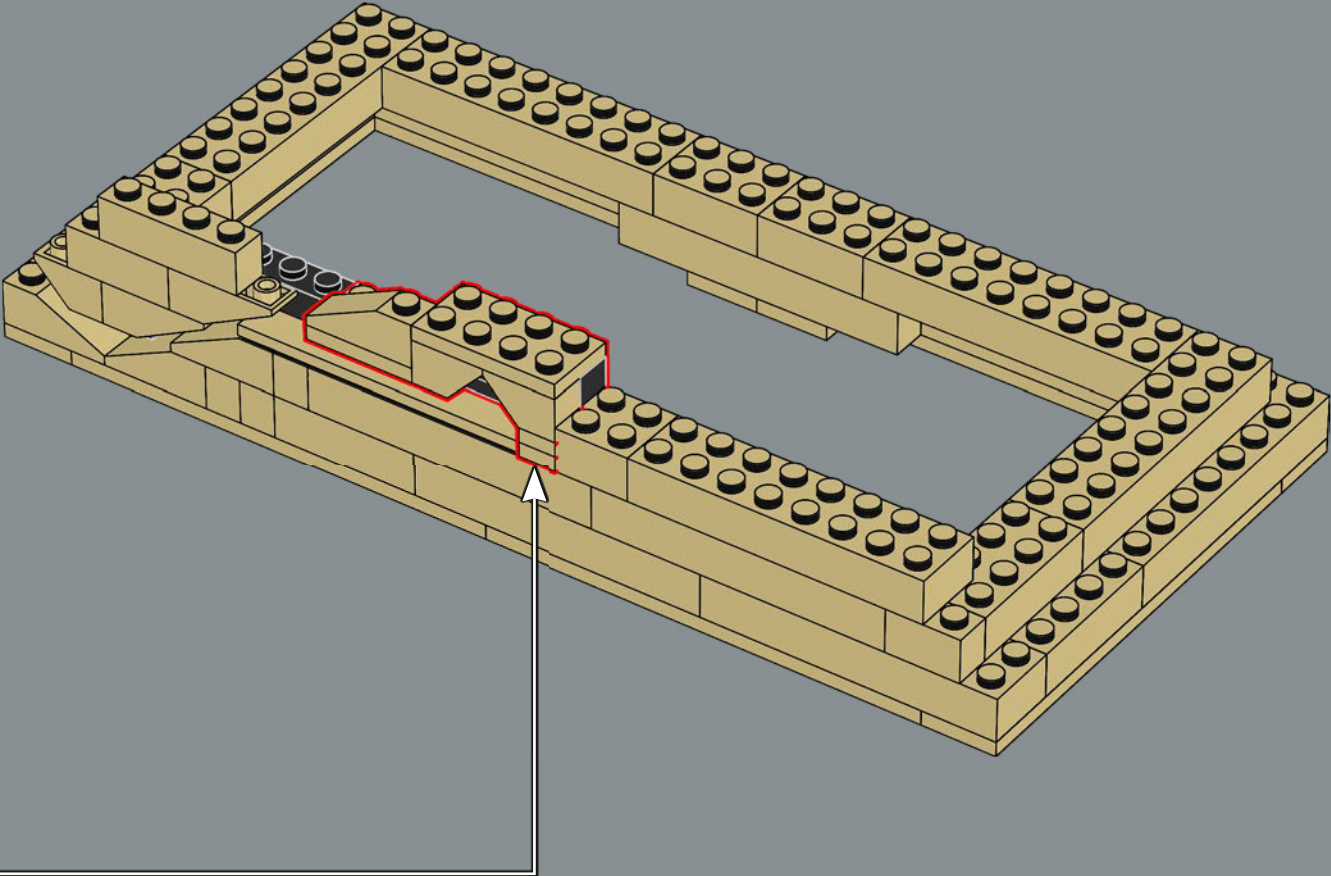

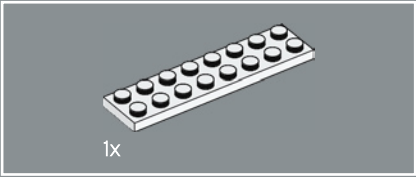
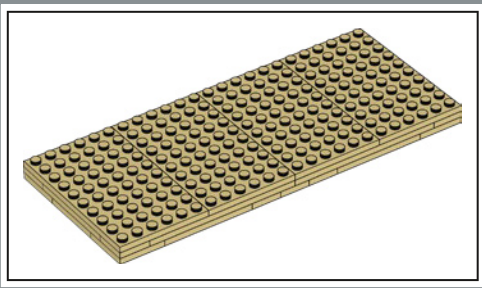

90

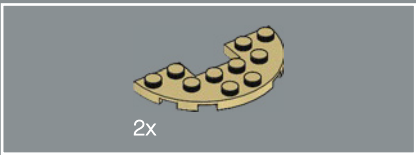
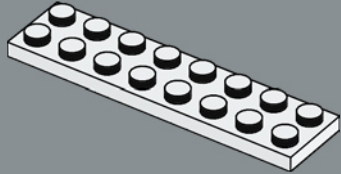

91

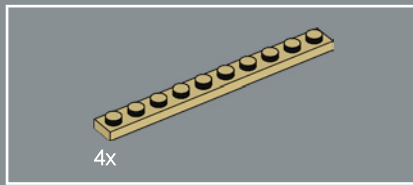
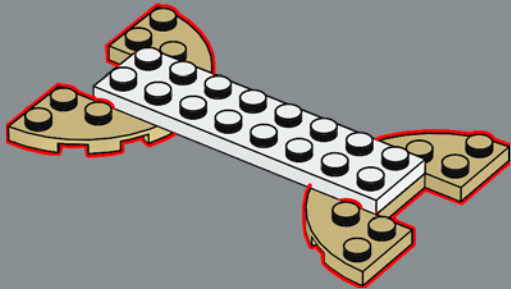

4x

92

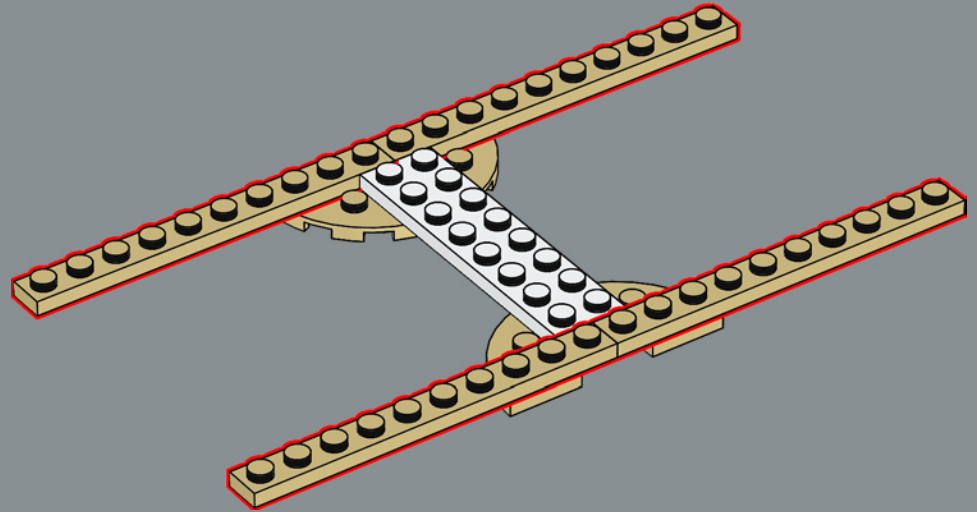

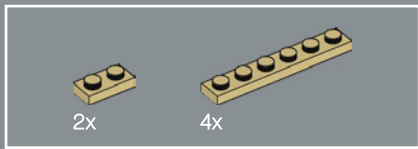

93

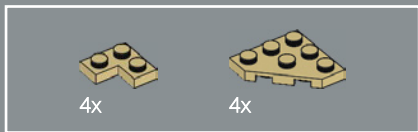
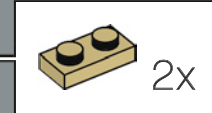
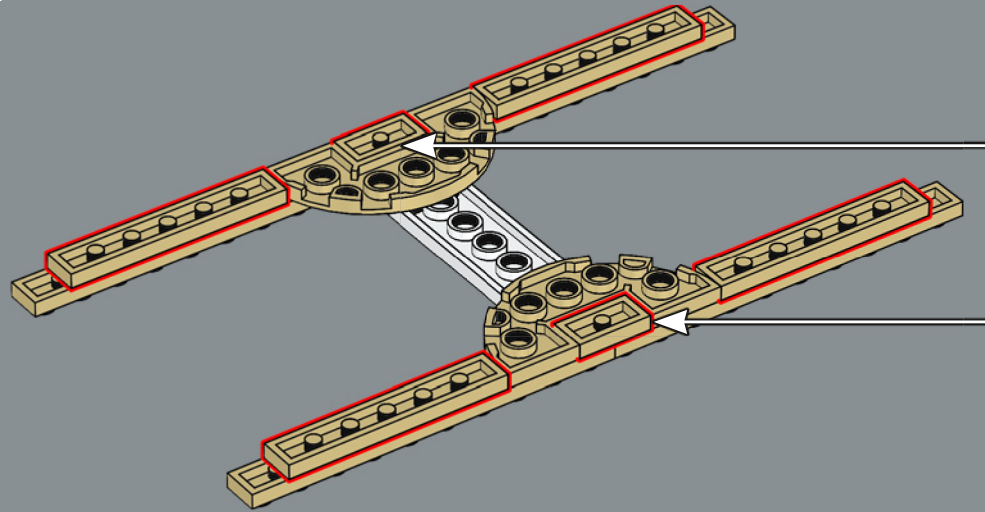

94

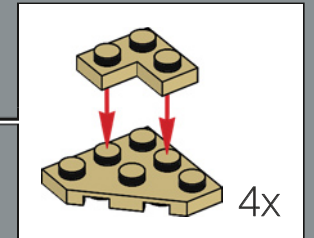
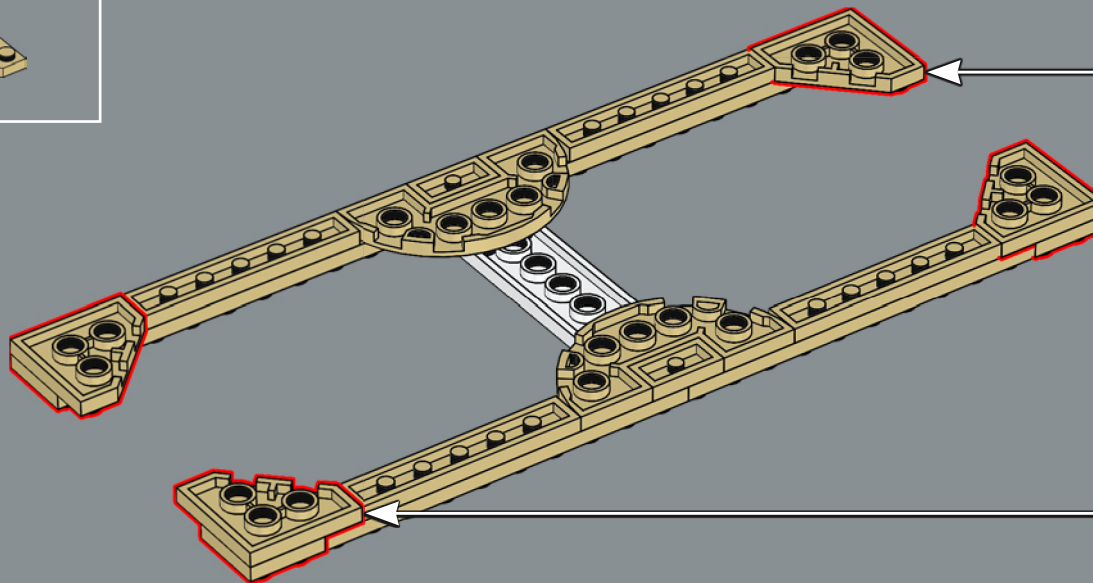

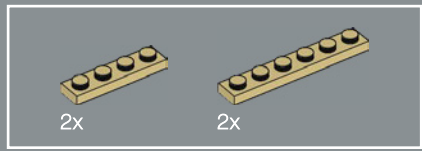

95

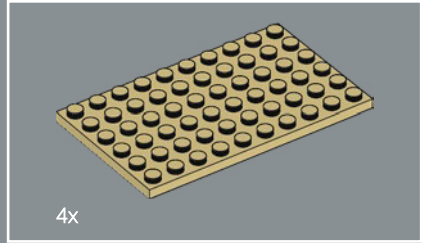
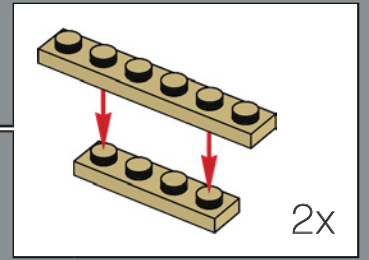
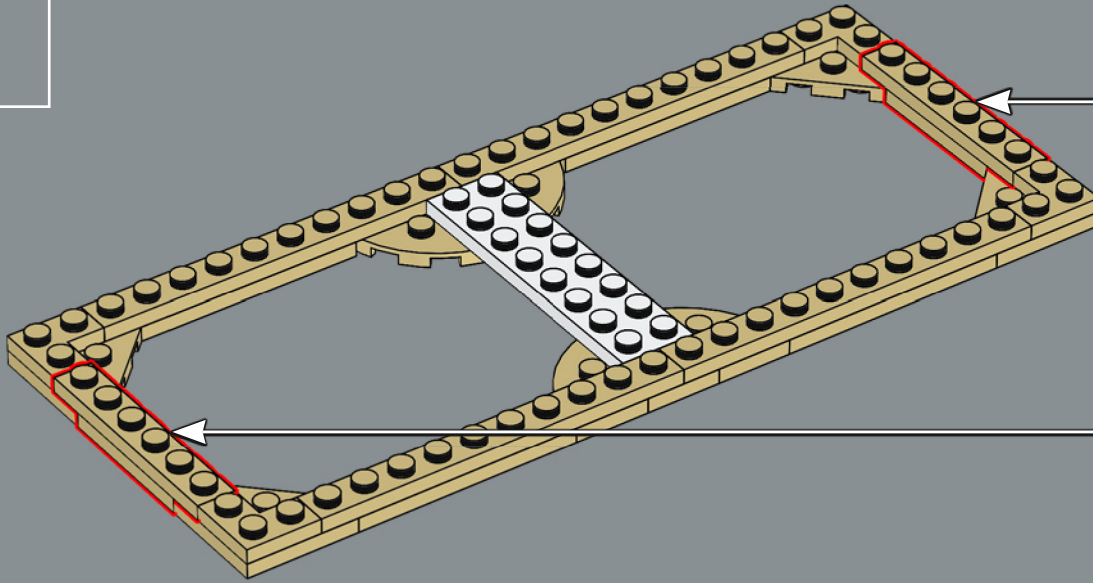

96

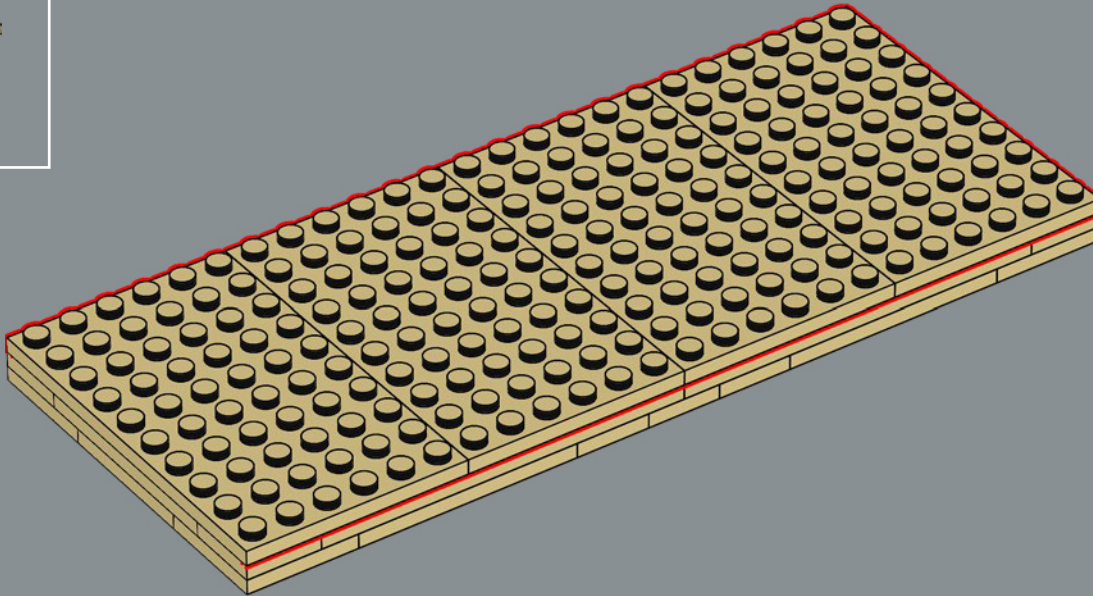

97

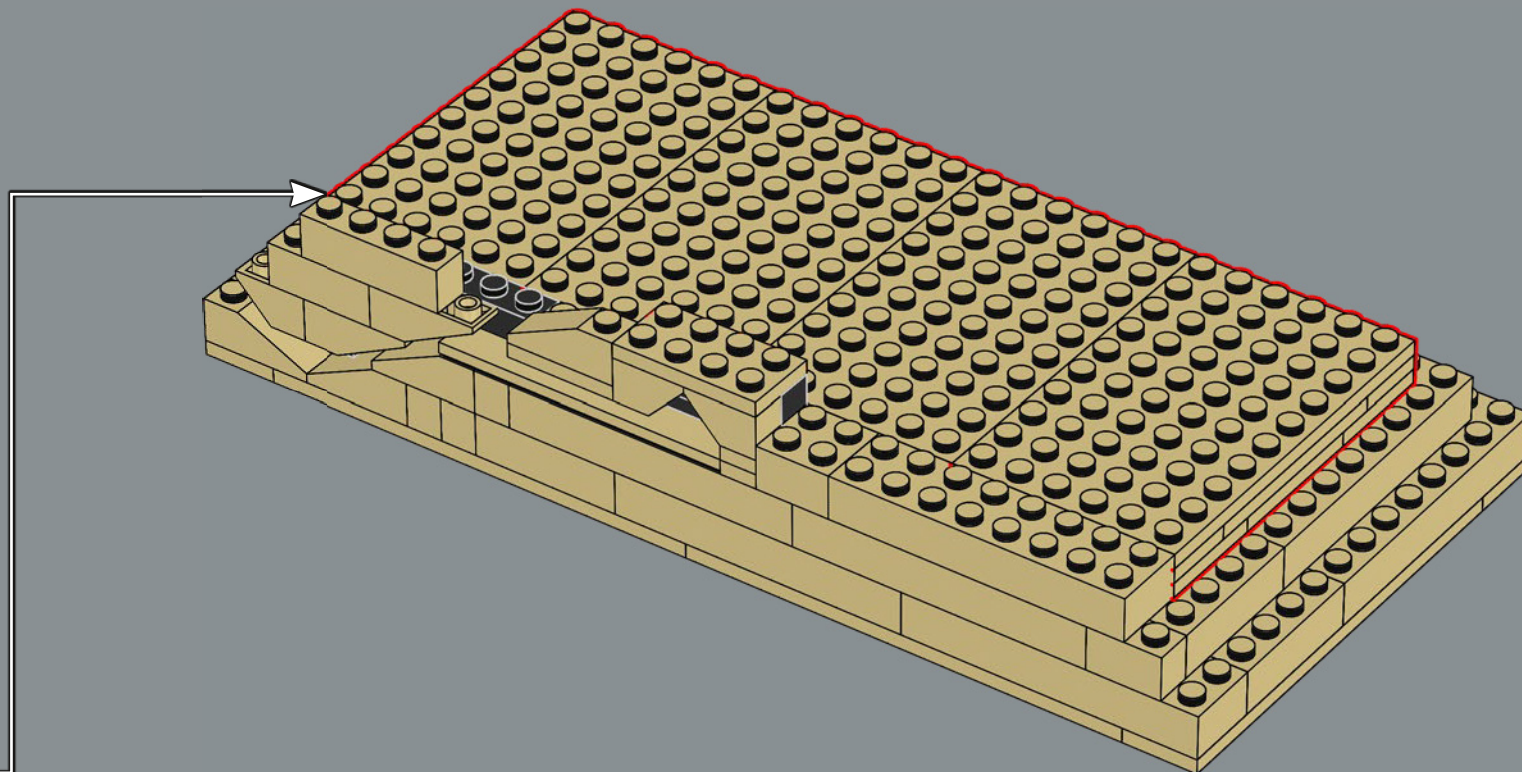

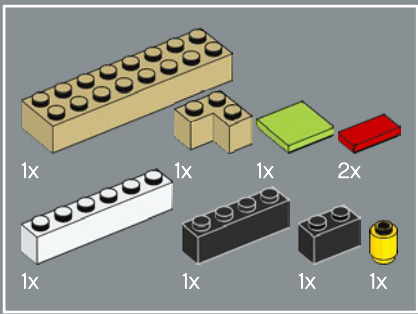

98

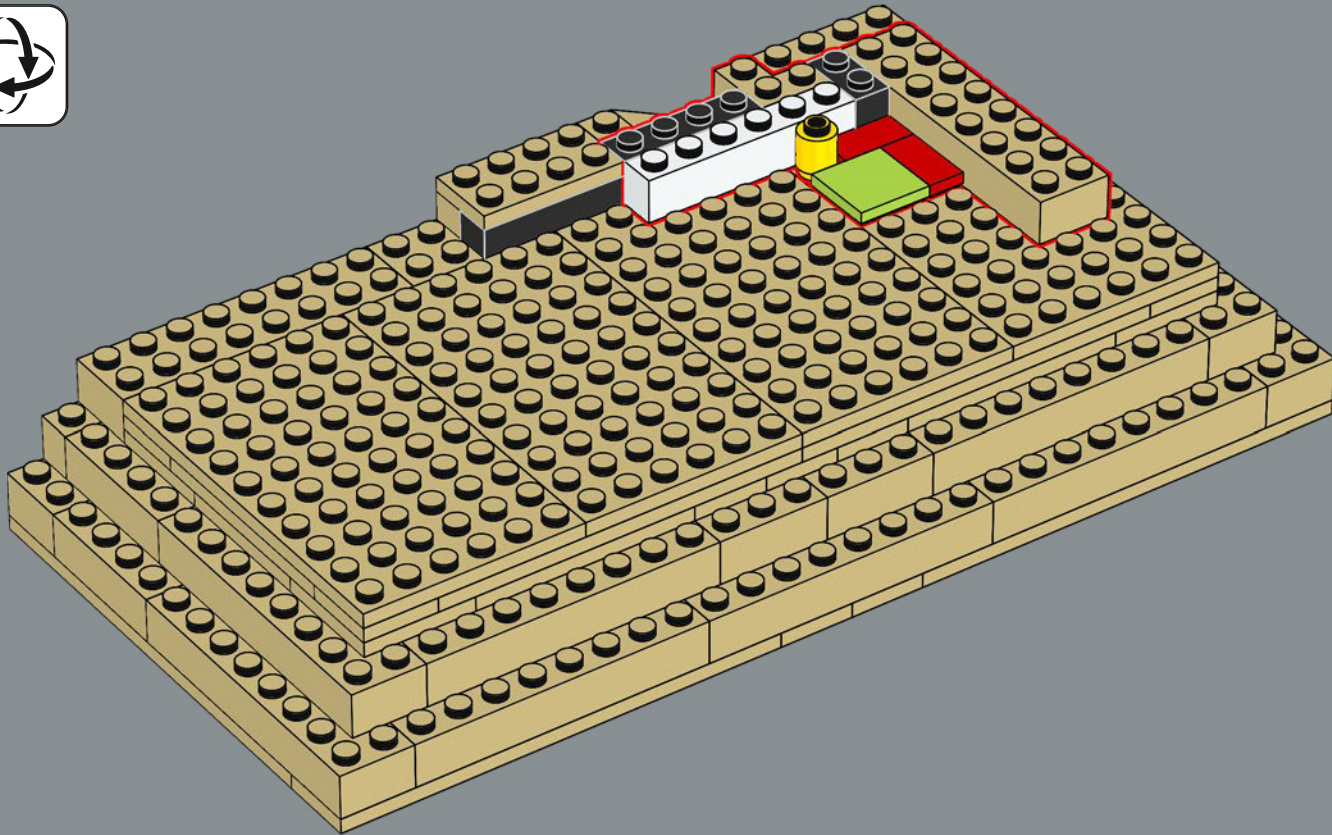

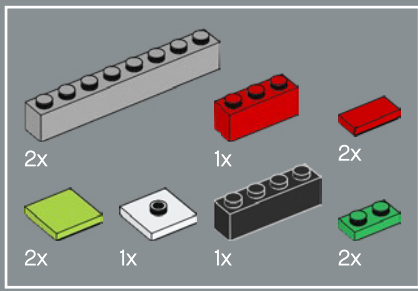

99

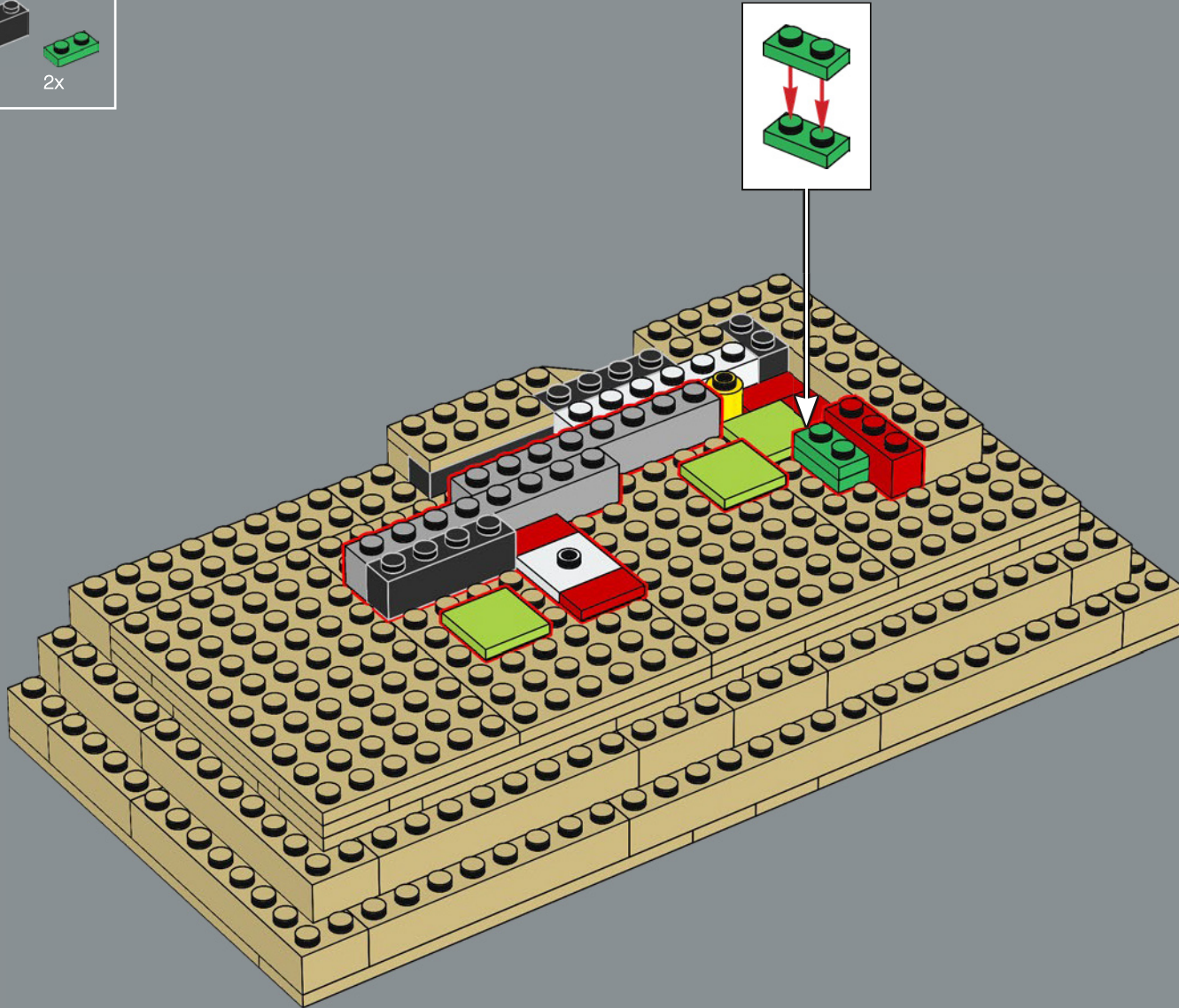

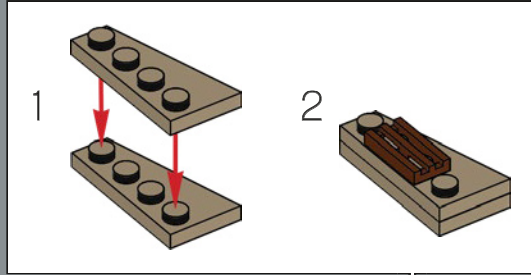
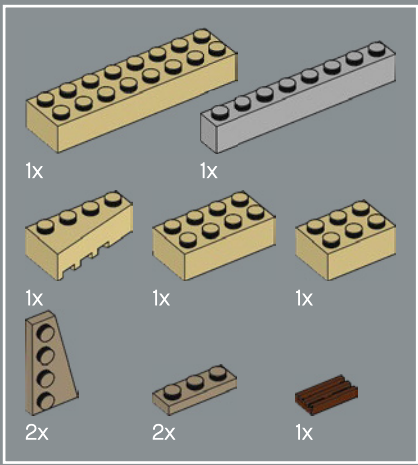

100

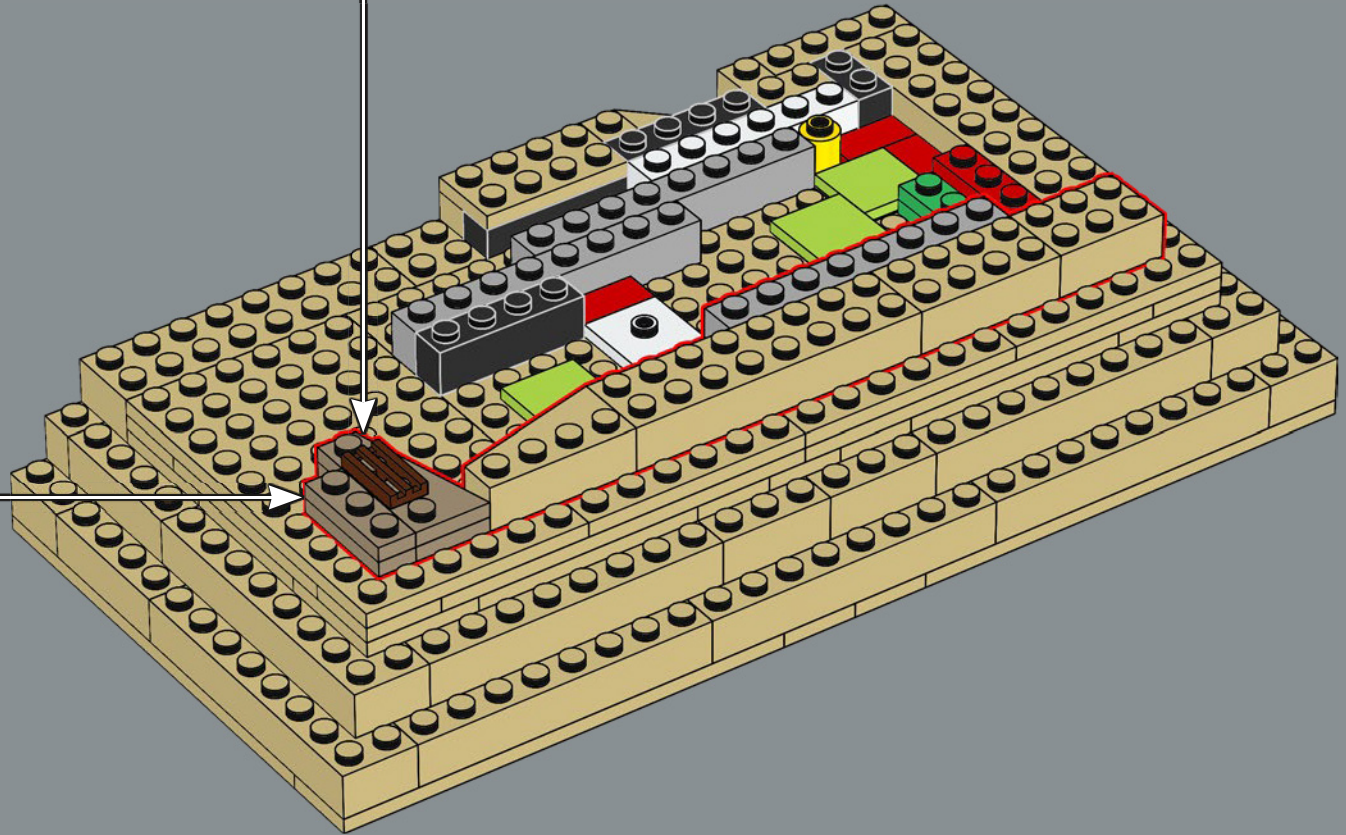
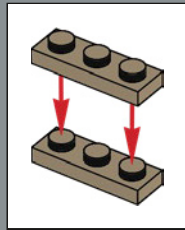

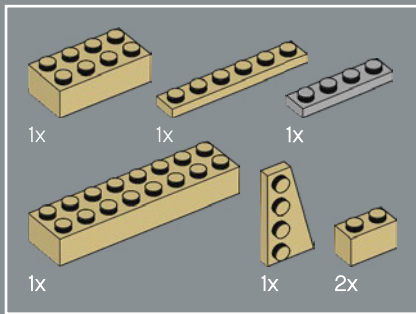

101

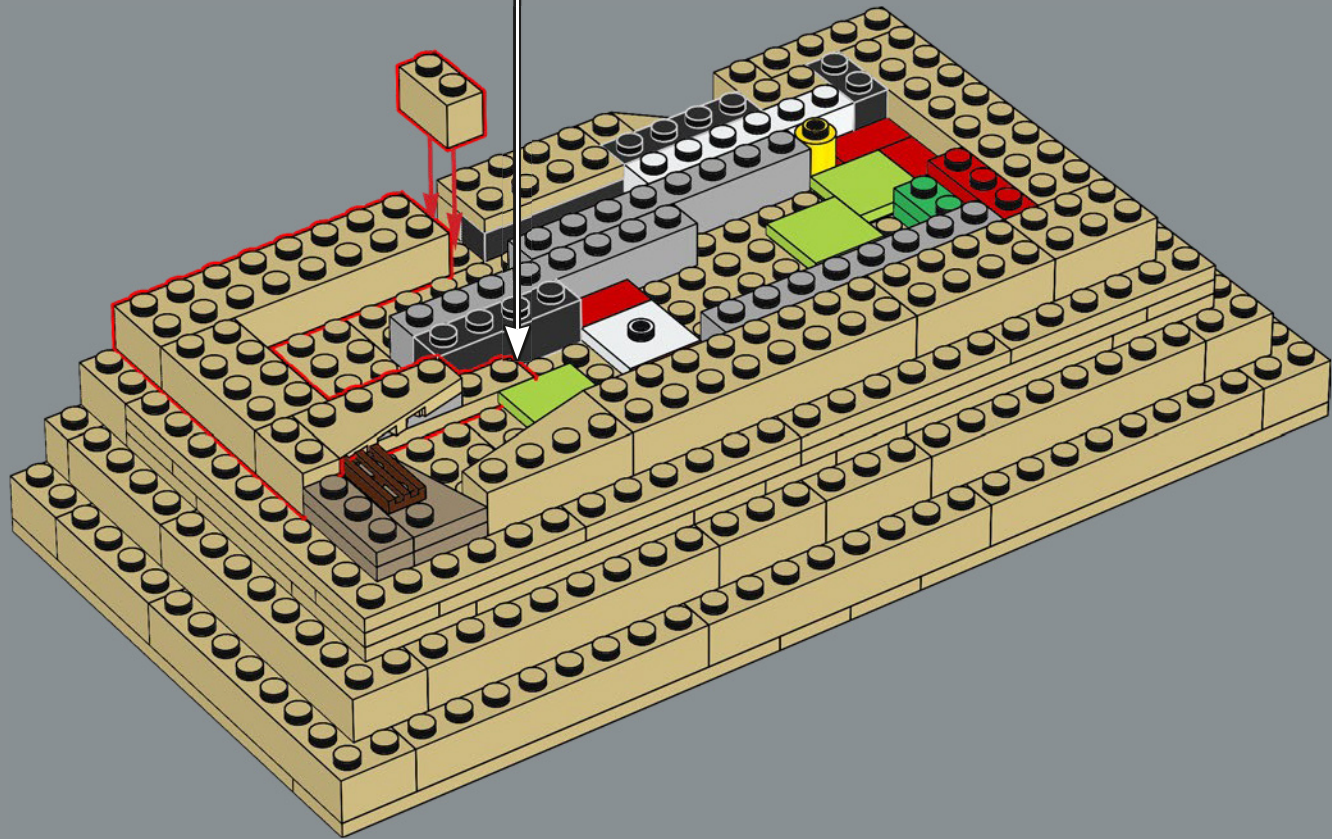
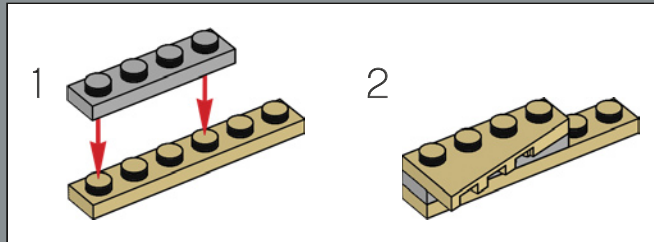

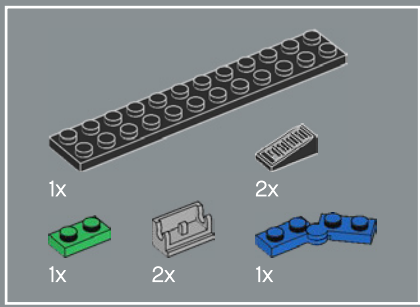

102

1

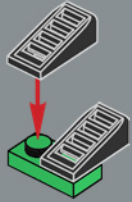

2

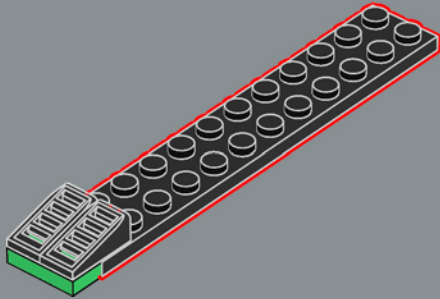

3

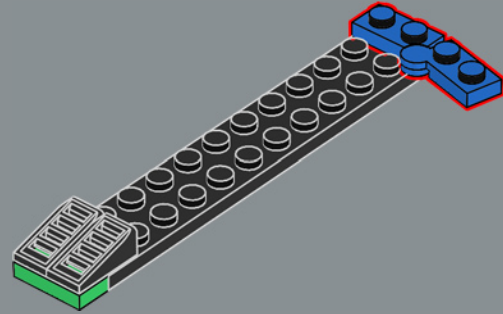

4

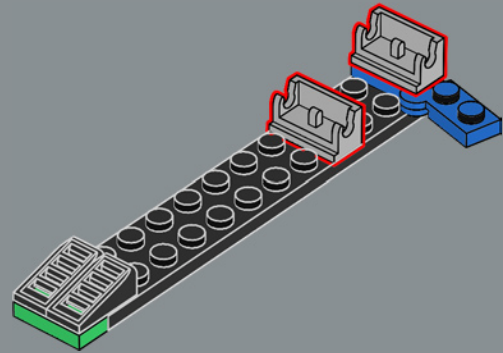

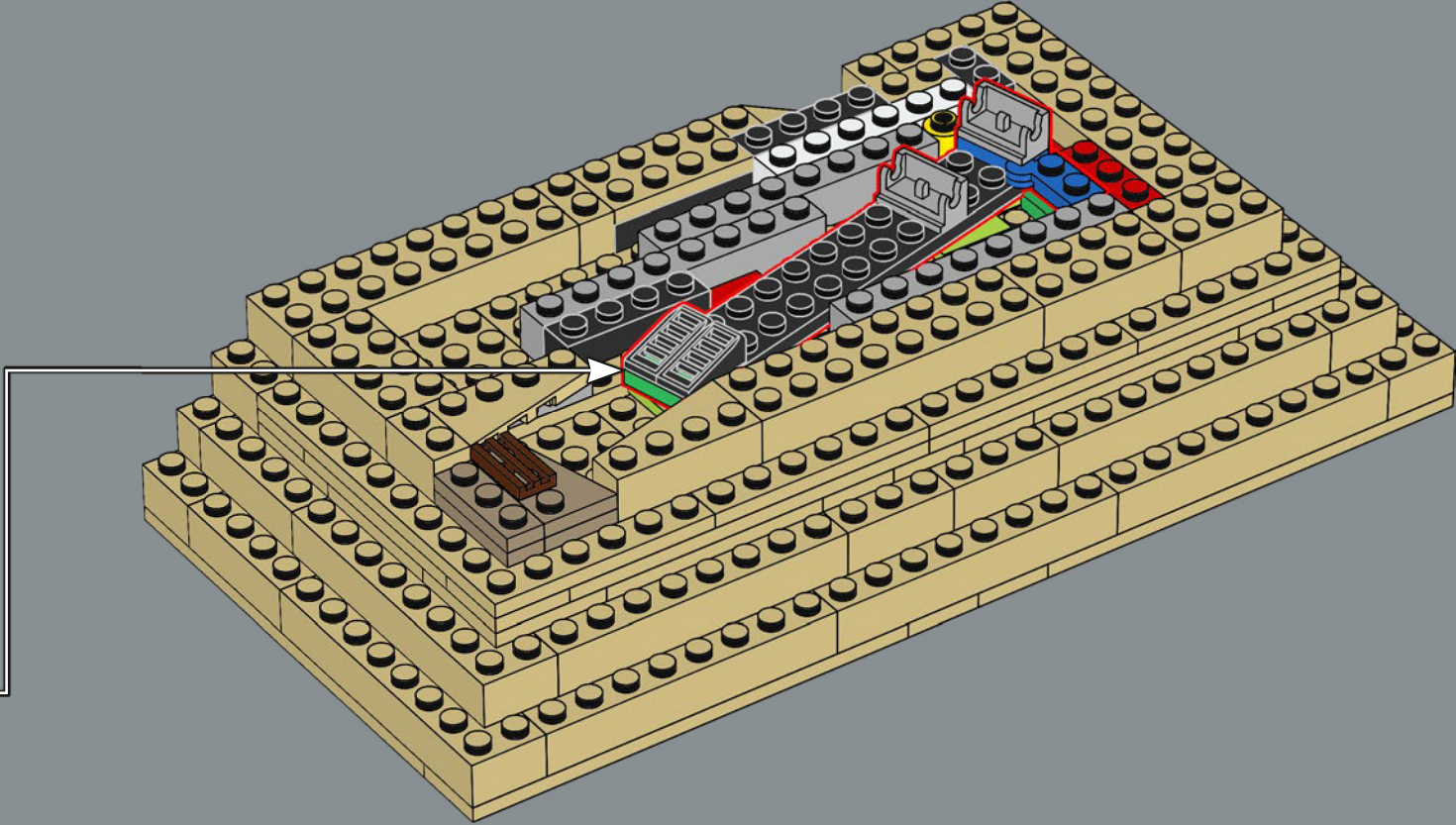

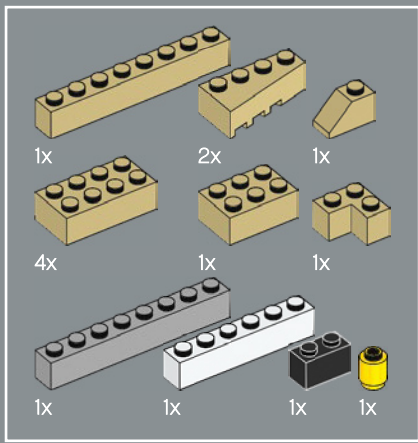

104

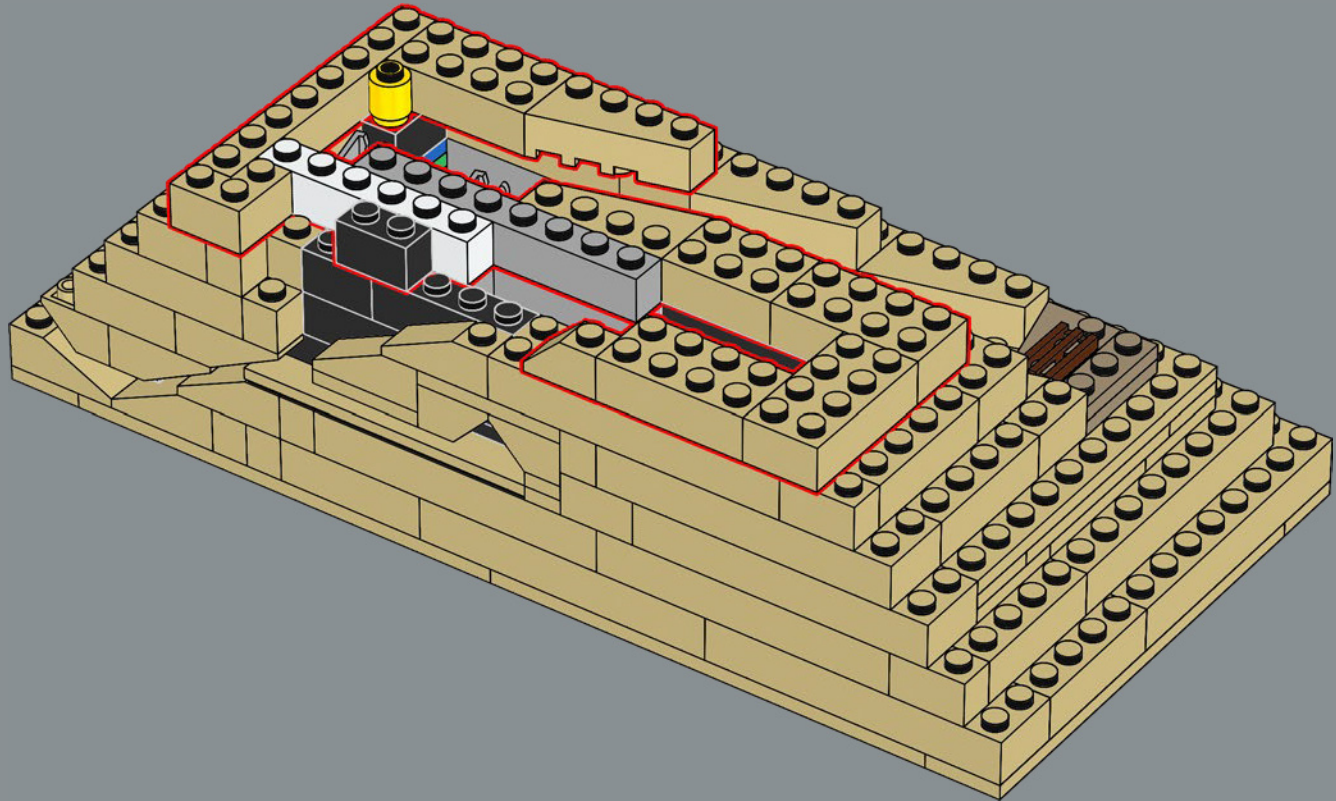

105

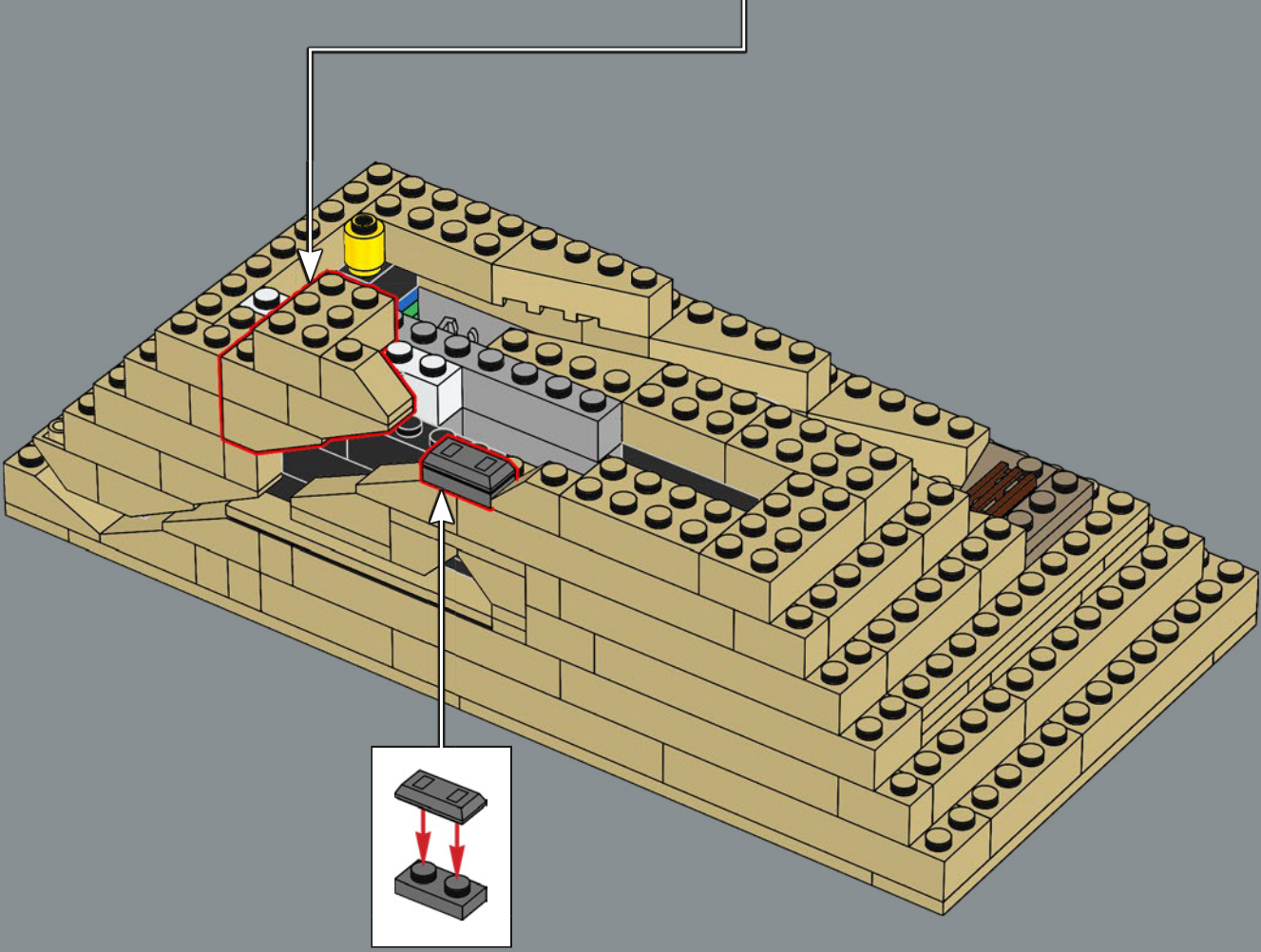
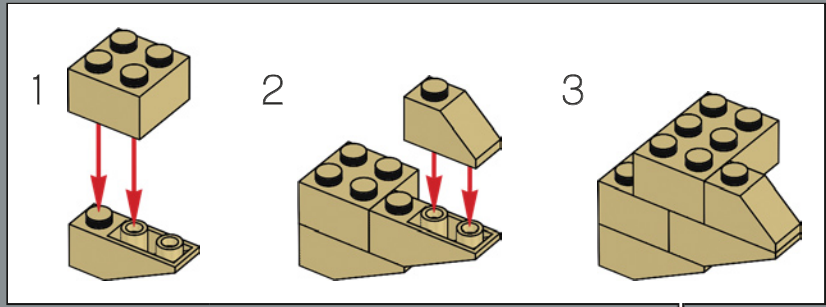
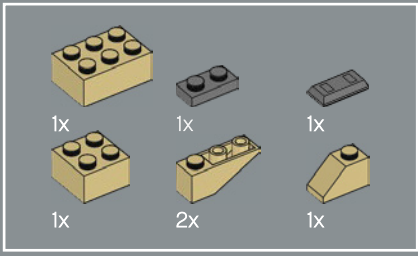

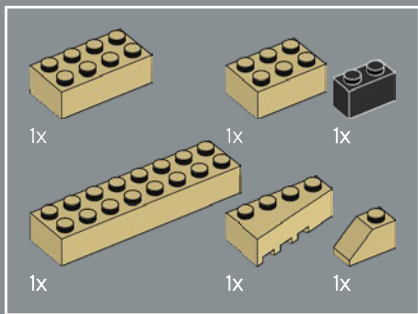

106

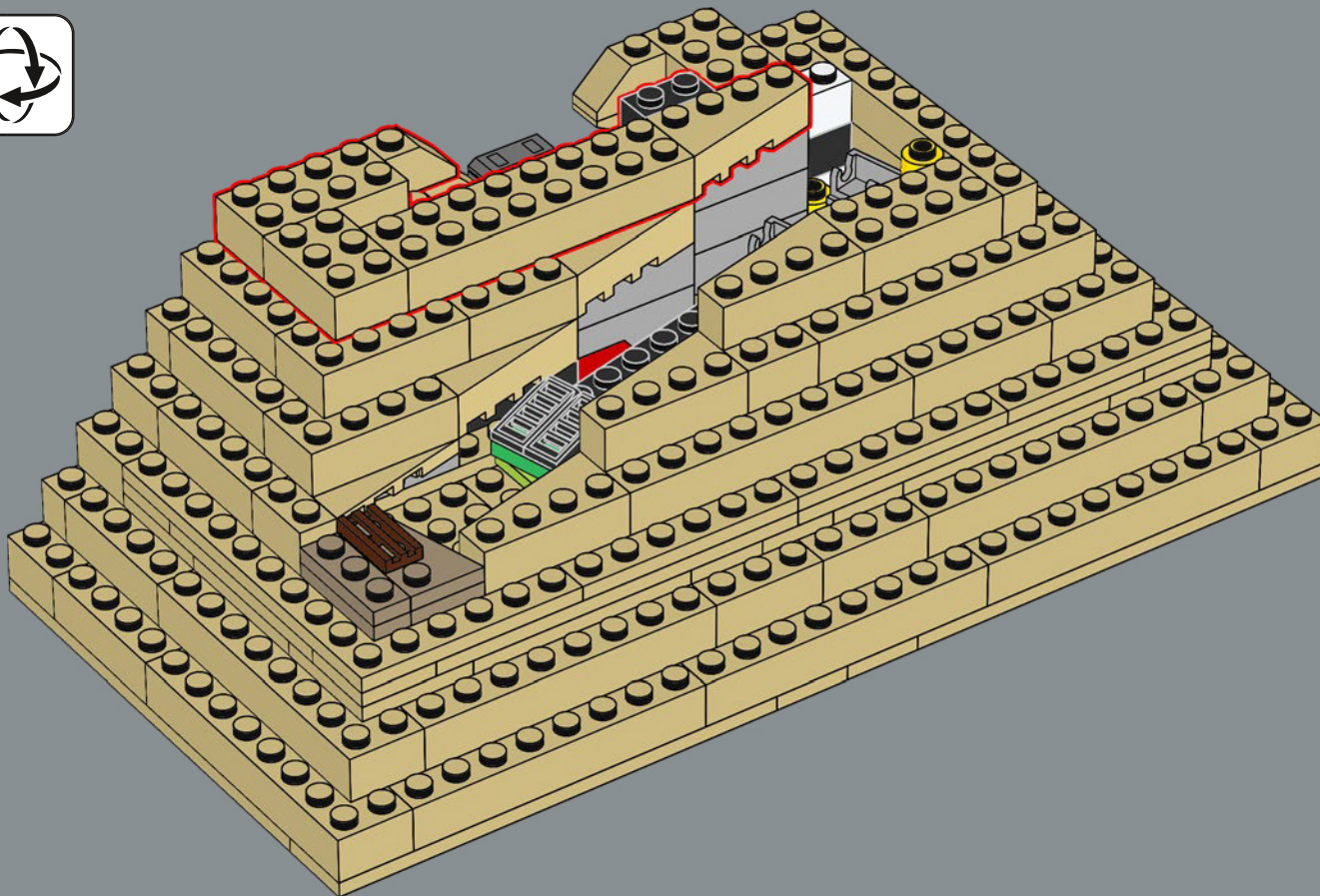

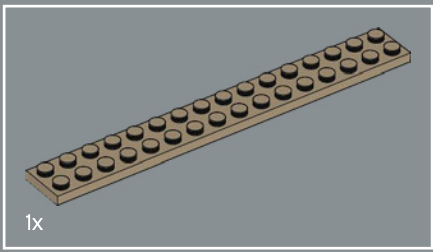

107

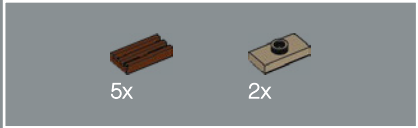
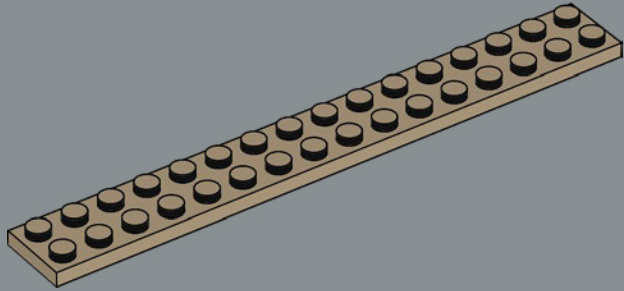

108

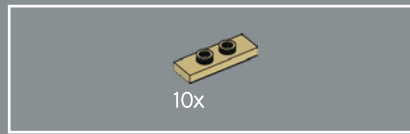
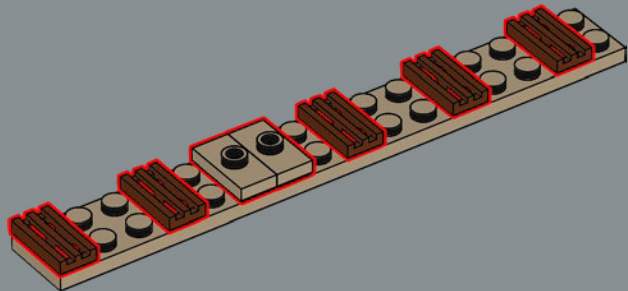

109

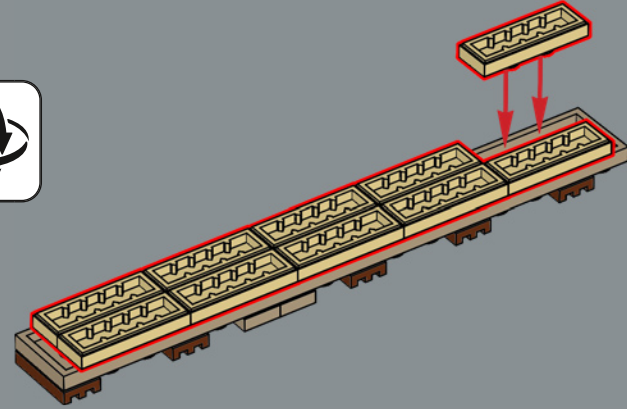

110

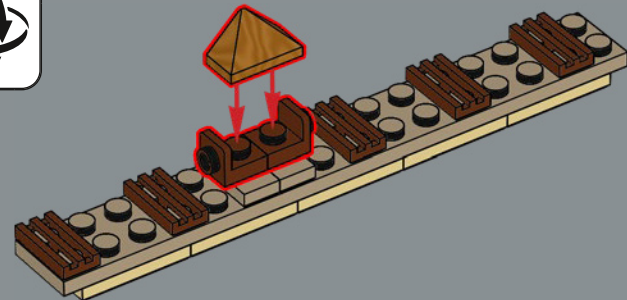

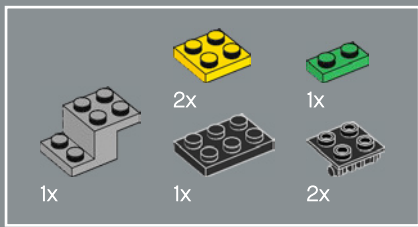

111

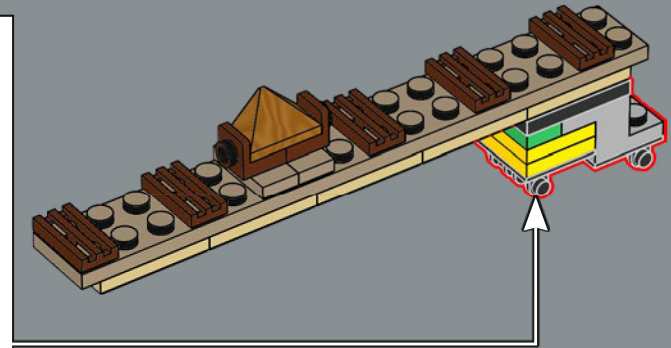
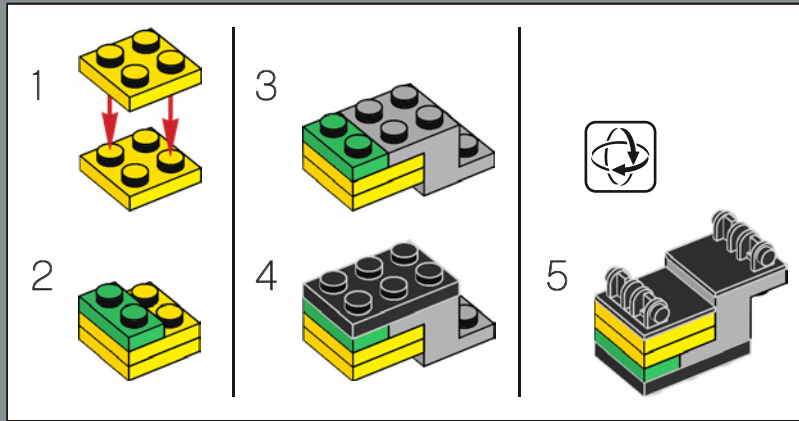

112

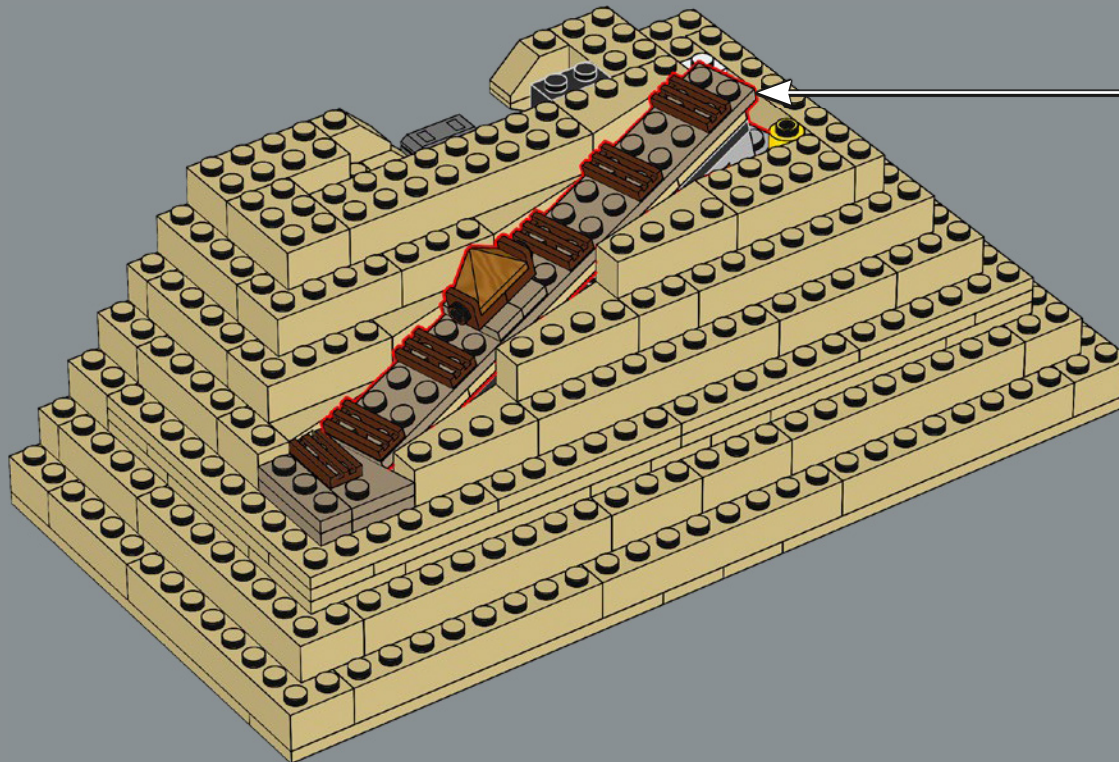

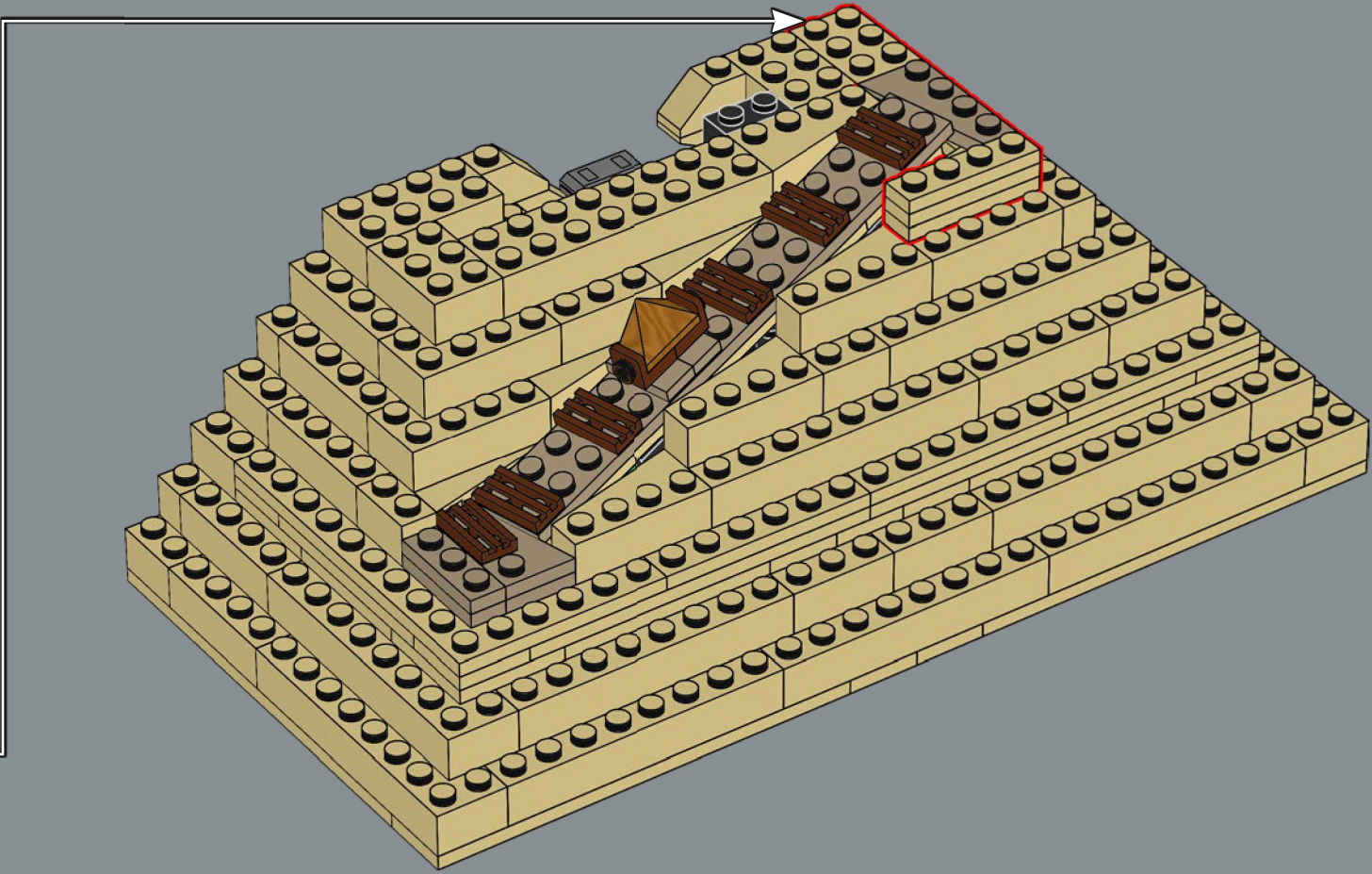

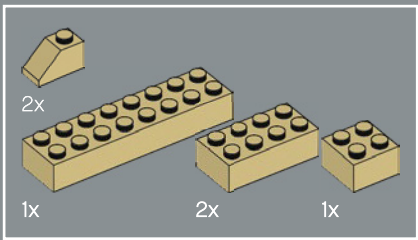

114

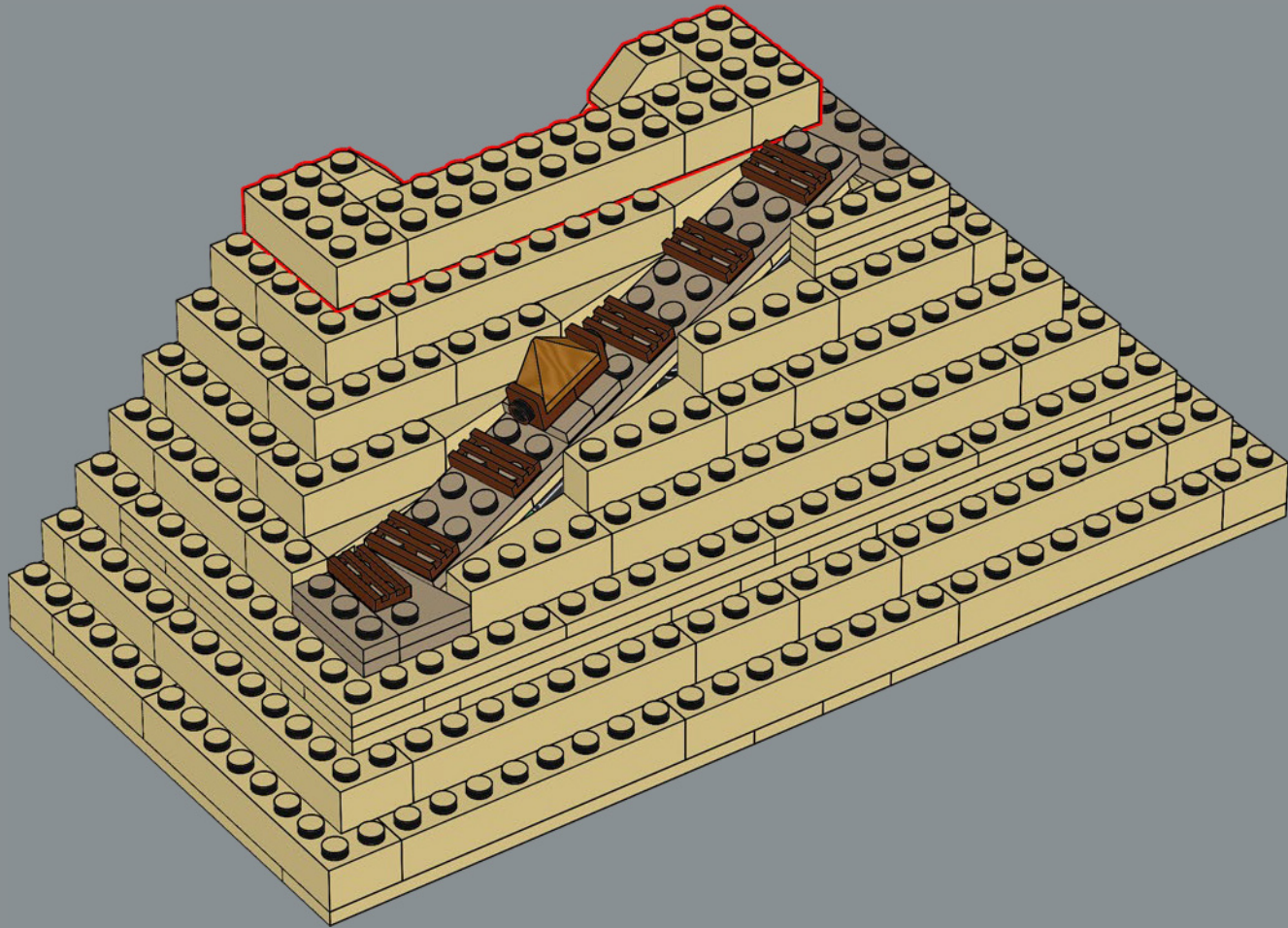



115

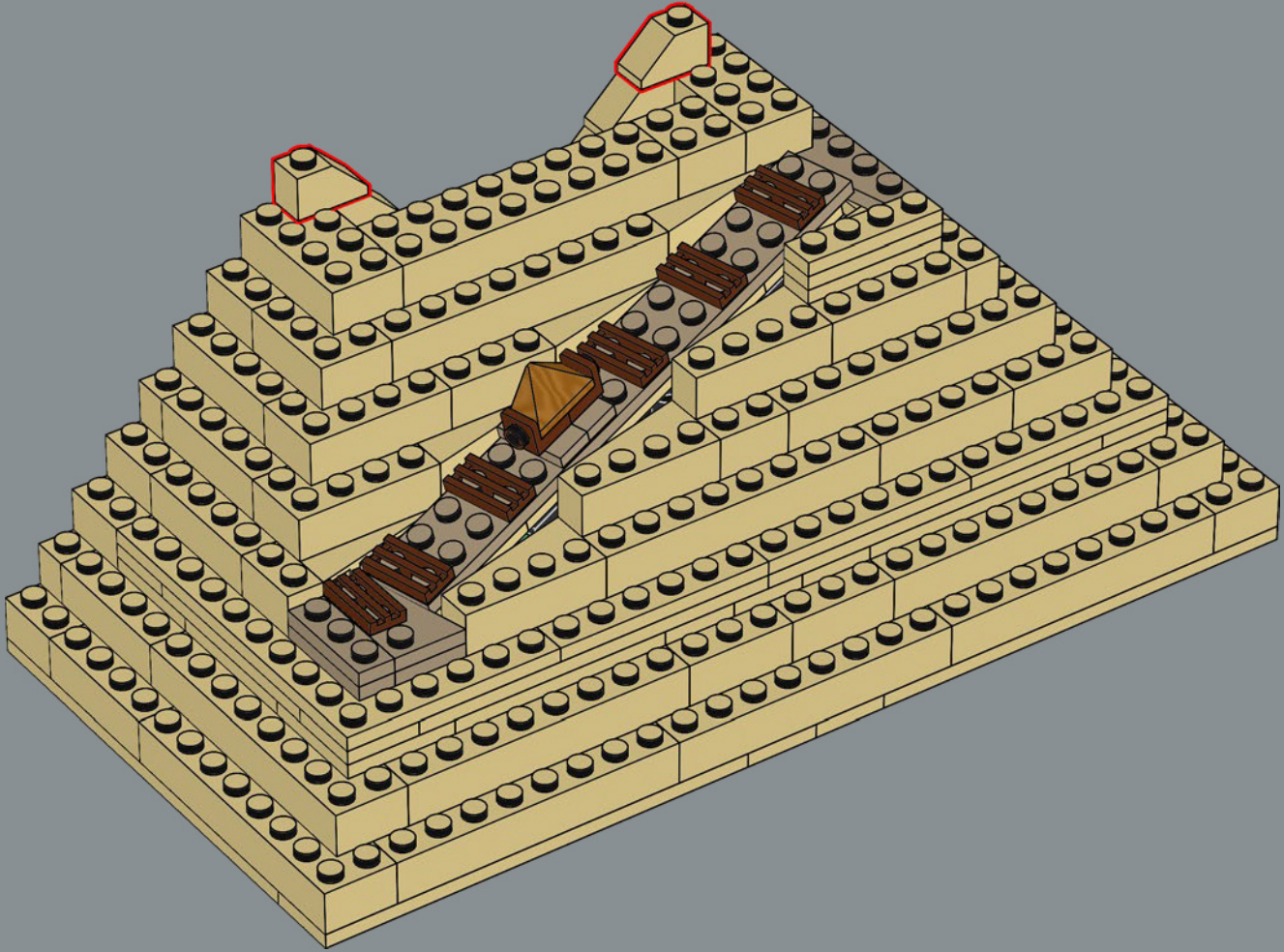



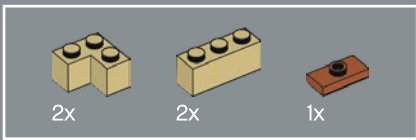

116

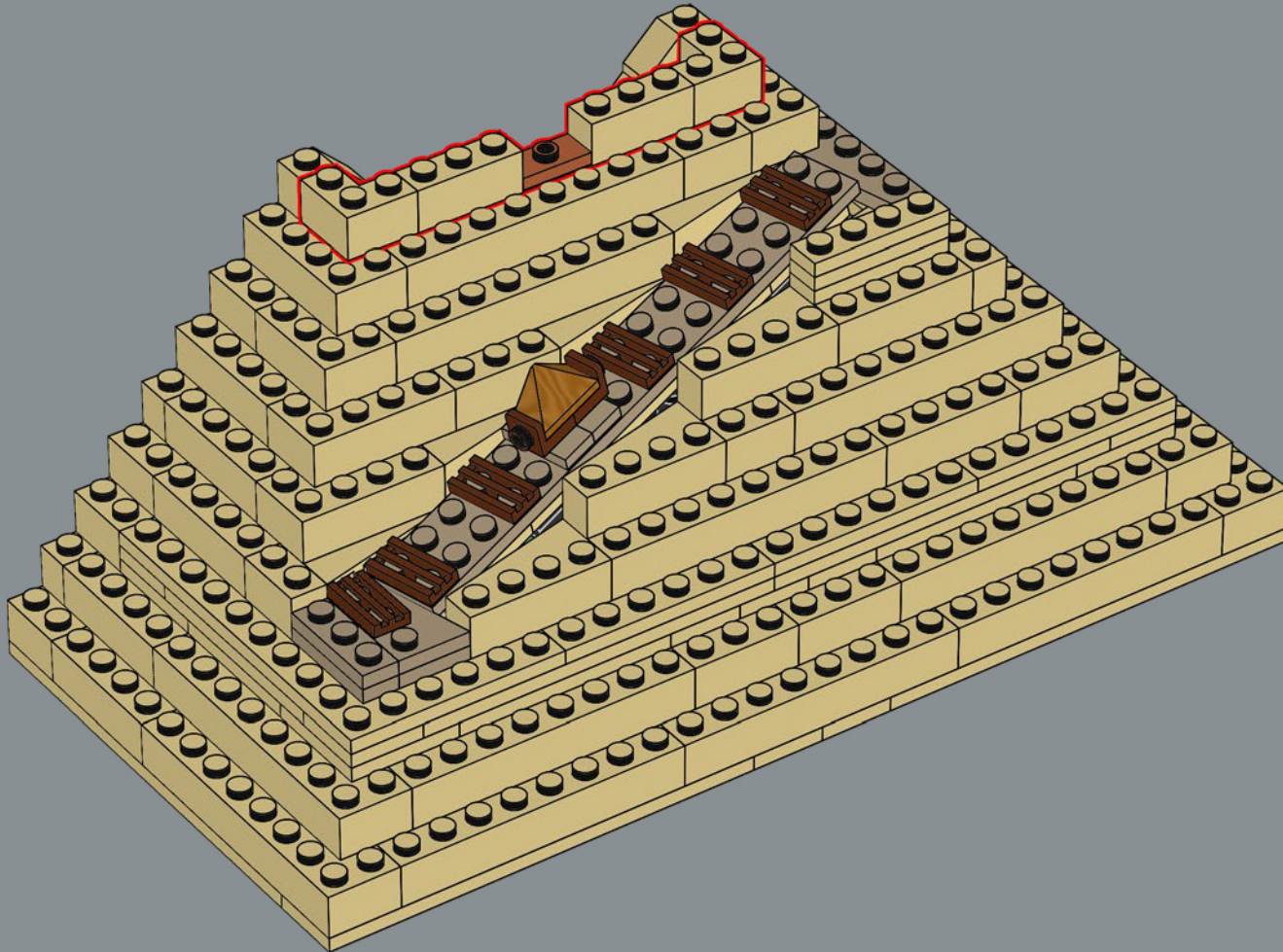

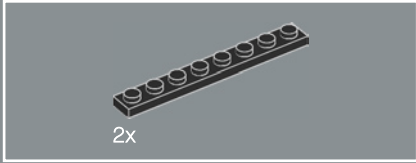
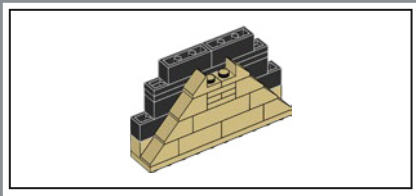

117

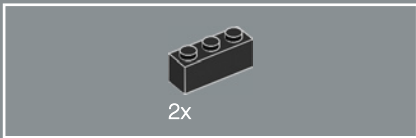
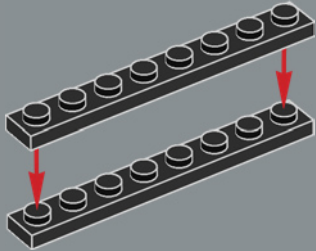

118

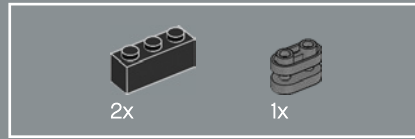
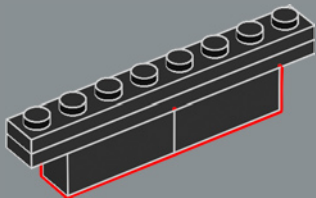

119

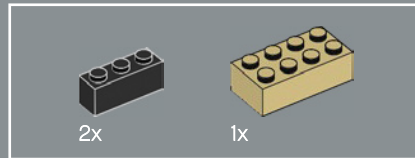
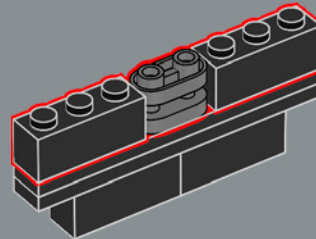

120

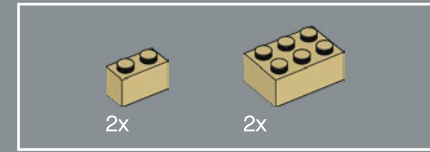
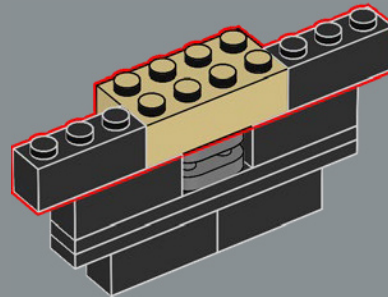

121

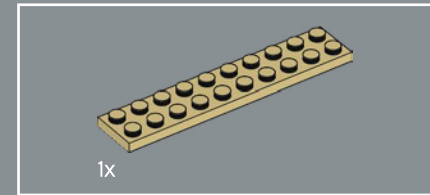
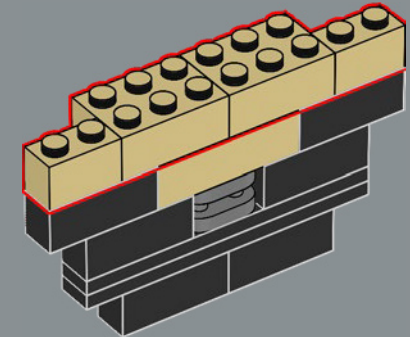

122

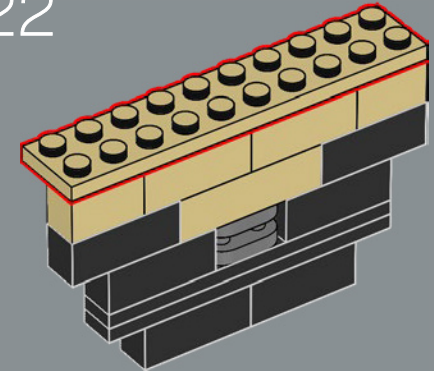

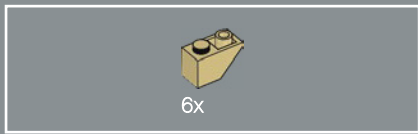

123

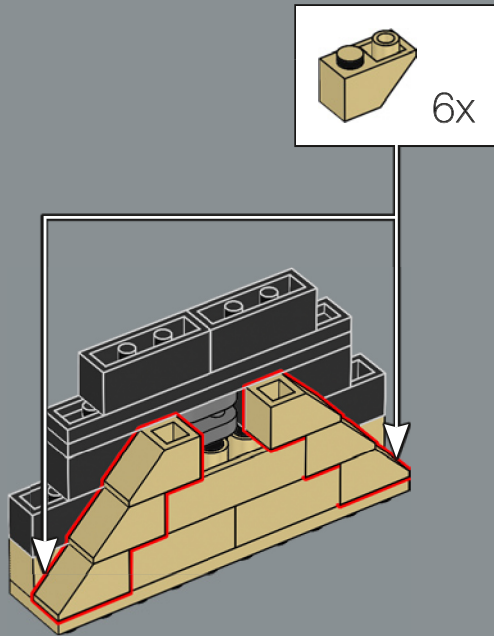

124

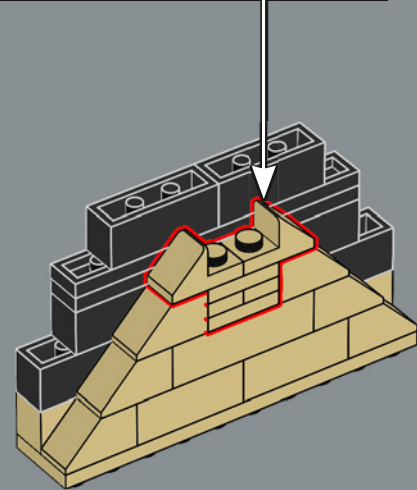
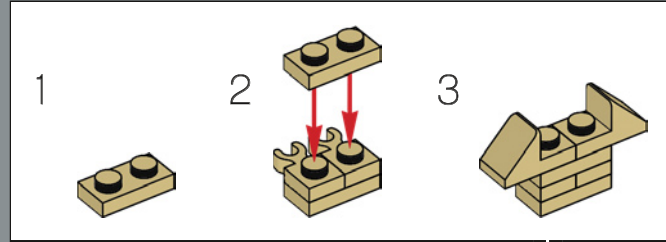

125

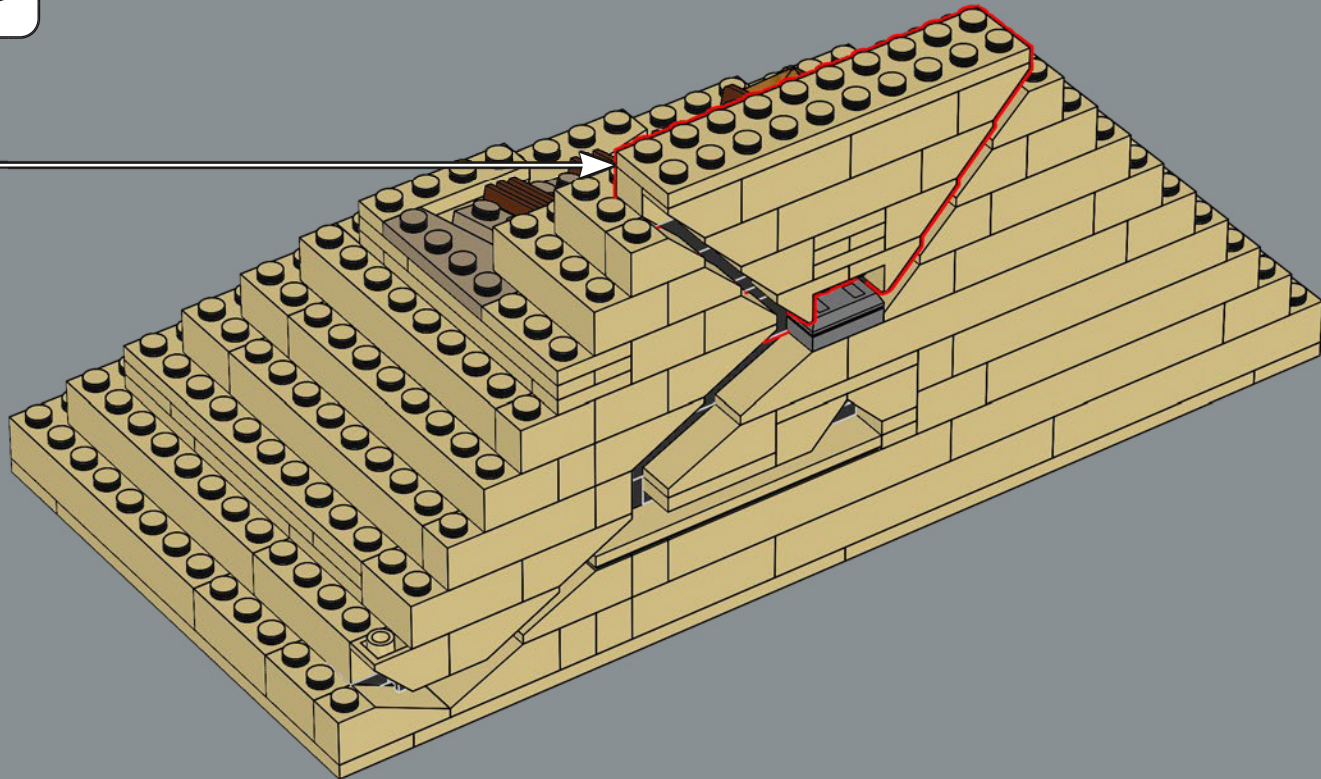

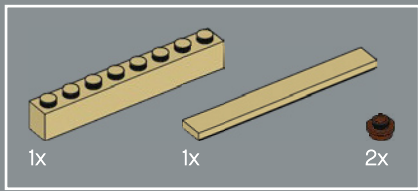

126

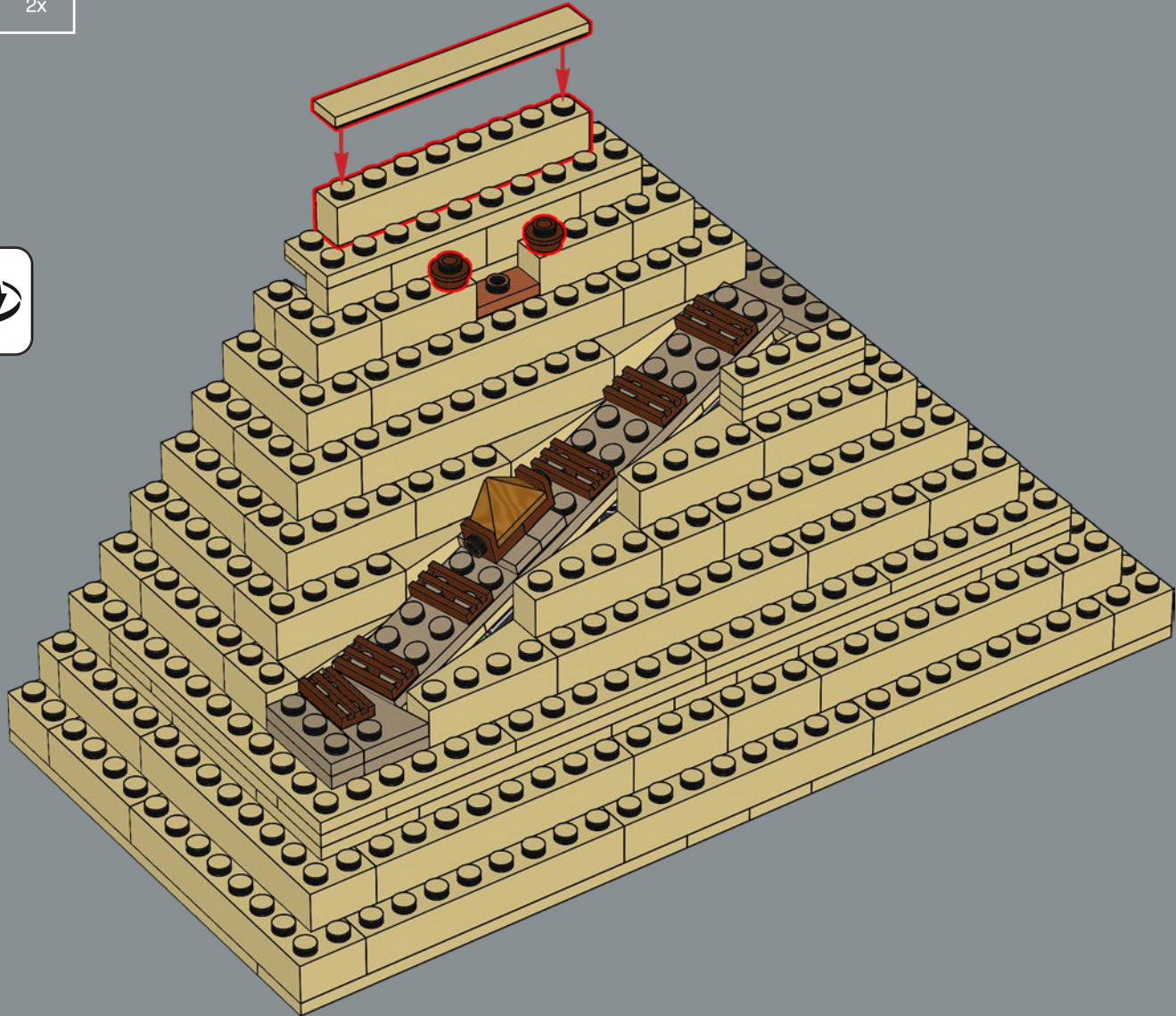

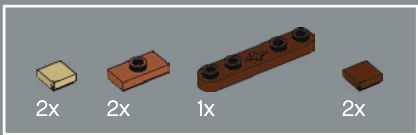

127

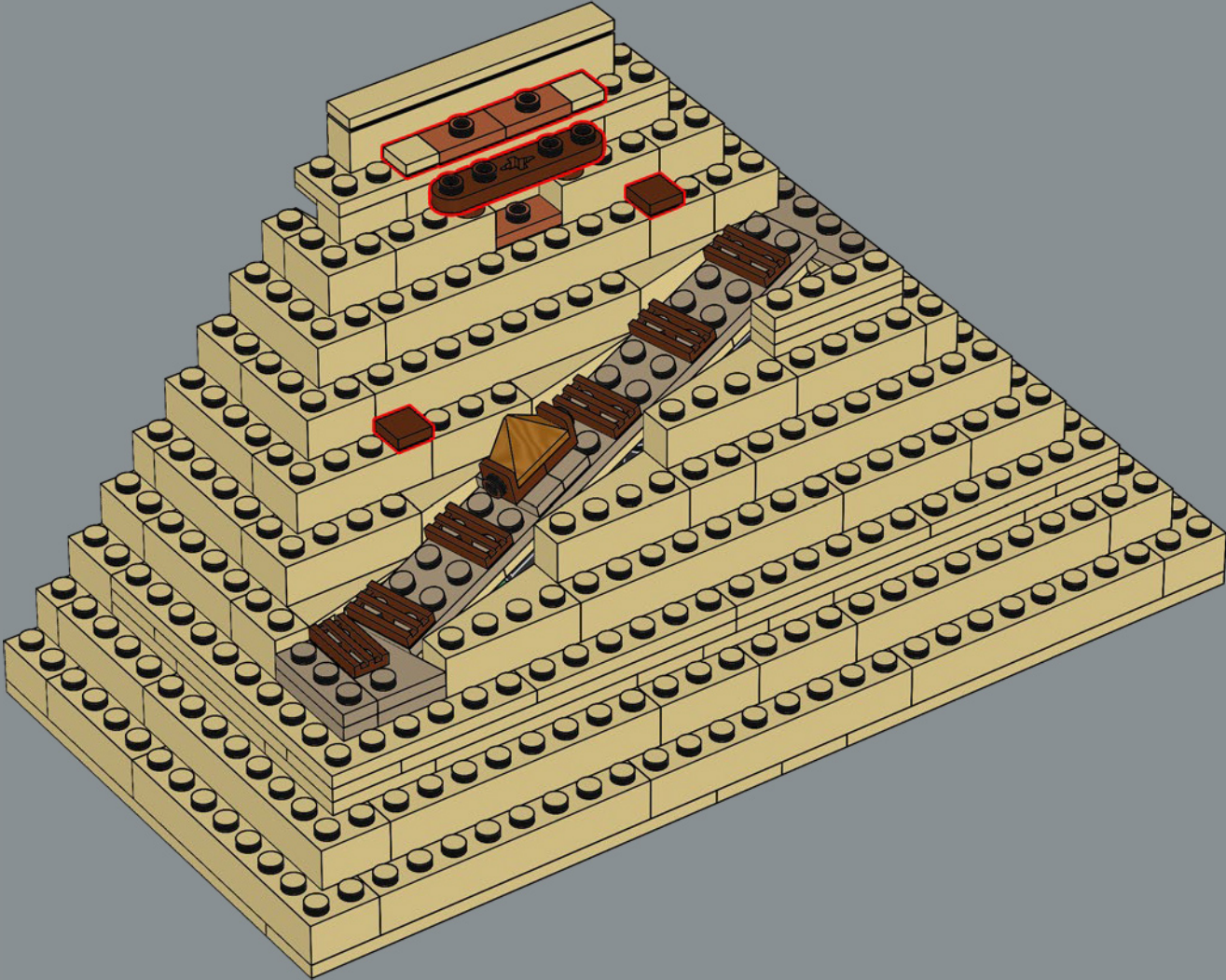

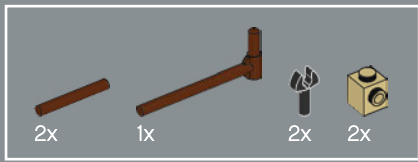

128

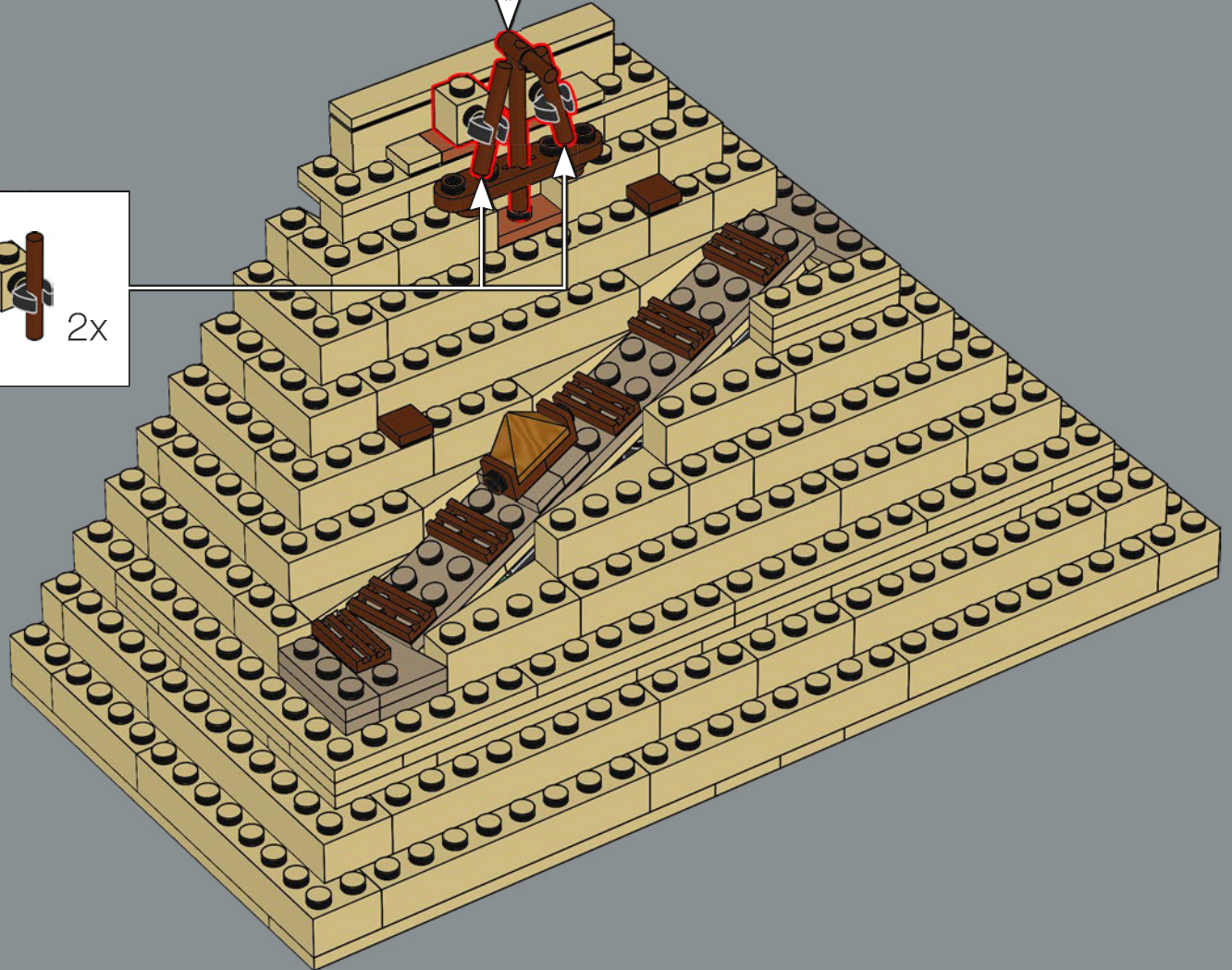
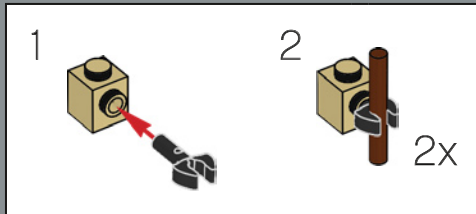



129

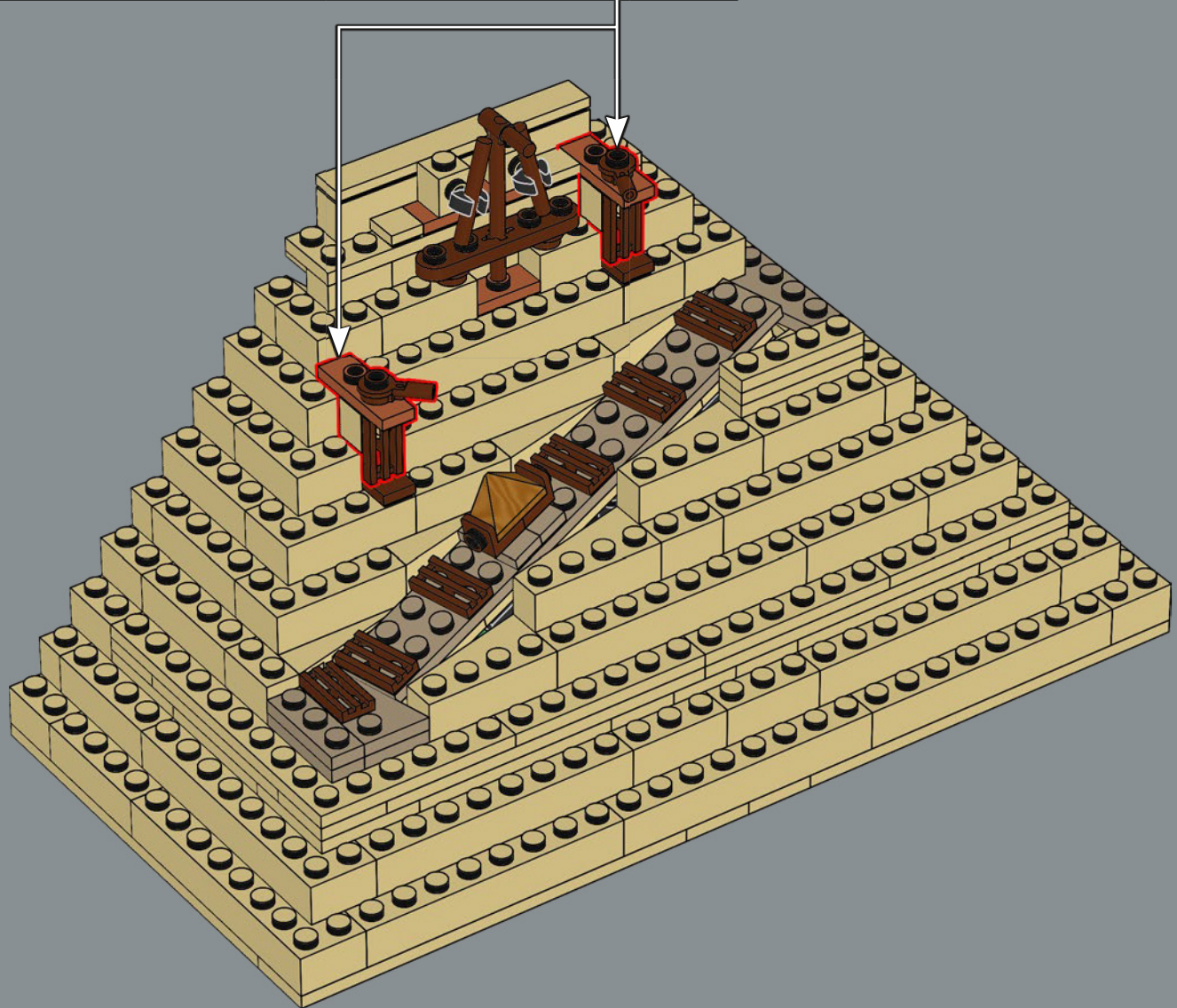
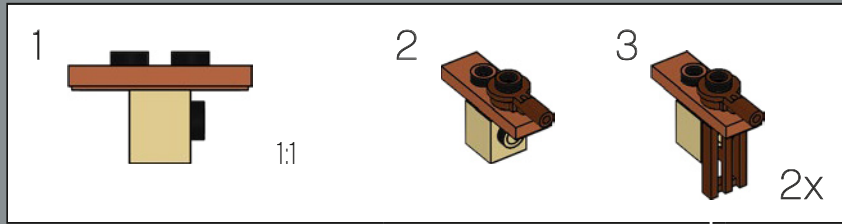

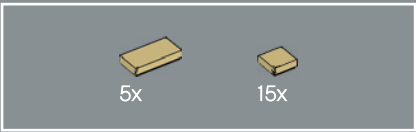

130

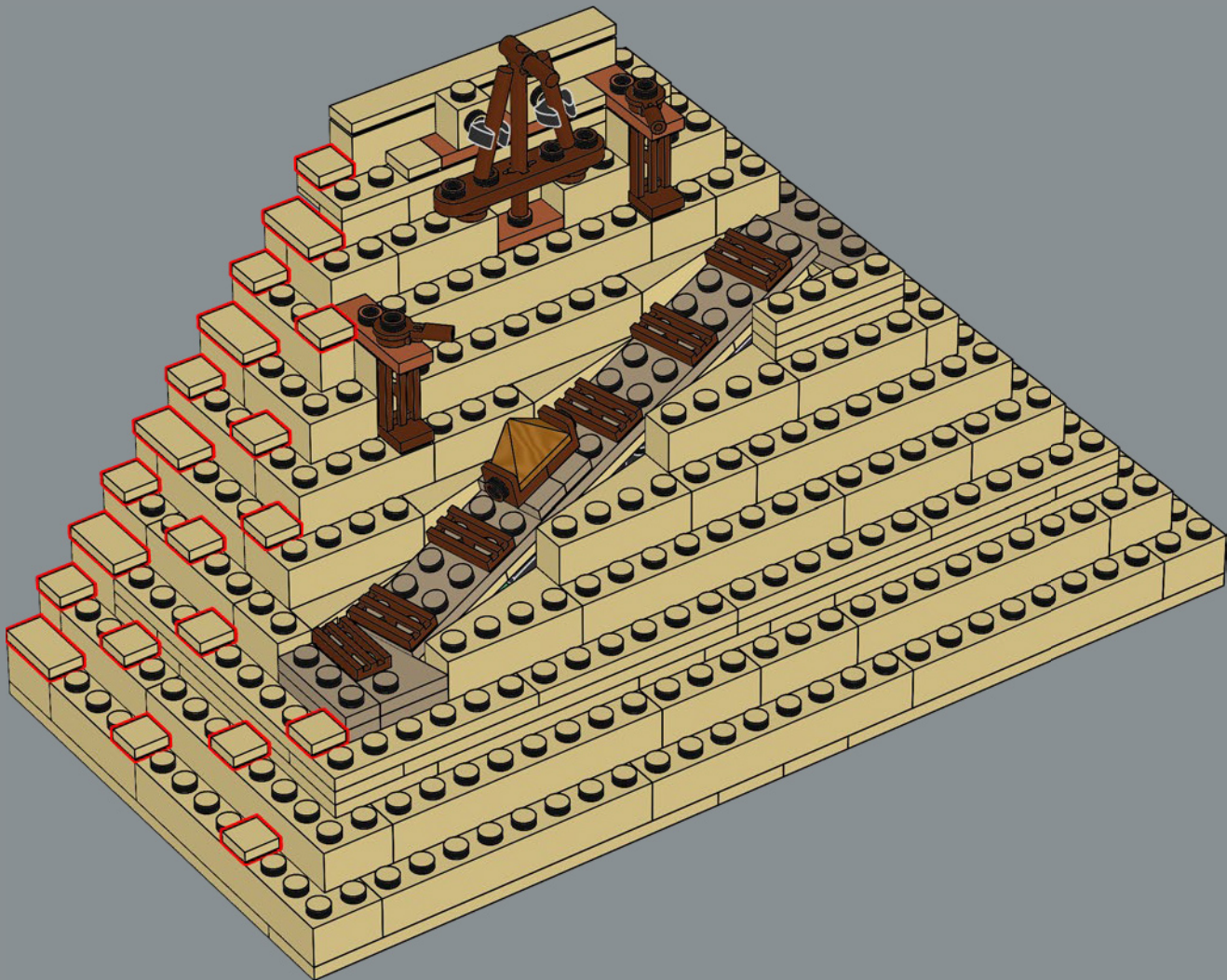



22x

131

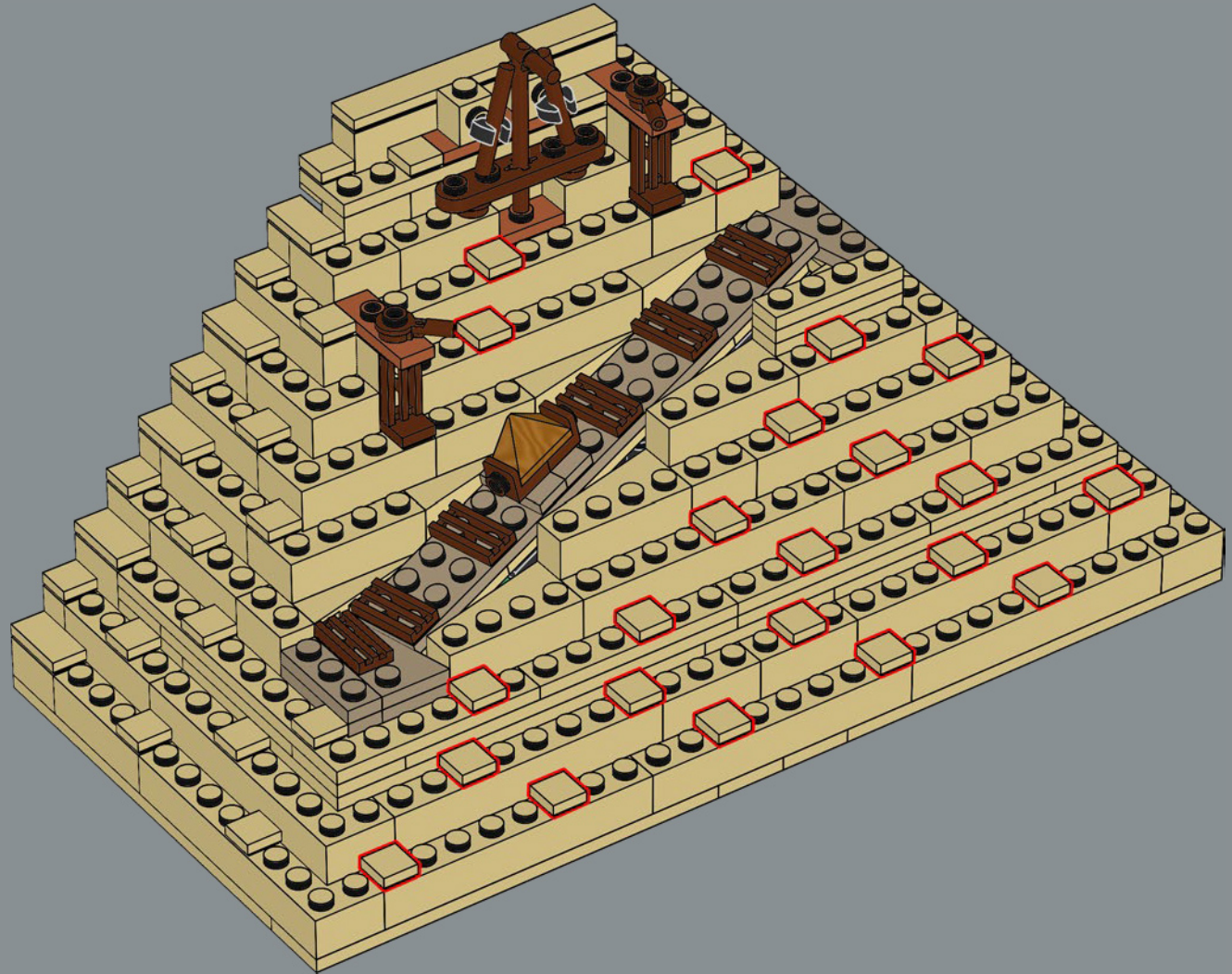

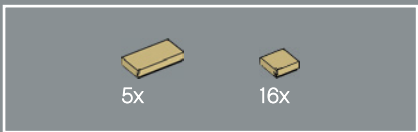

132

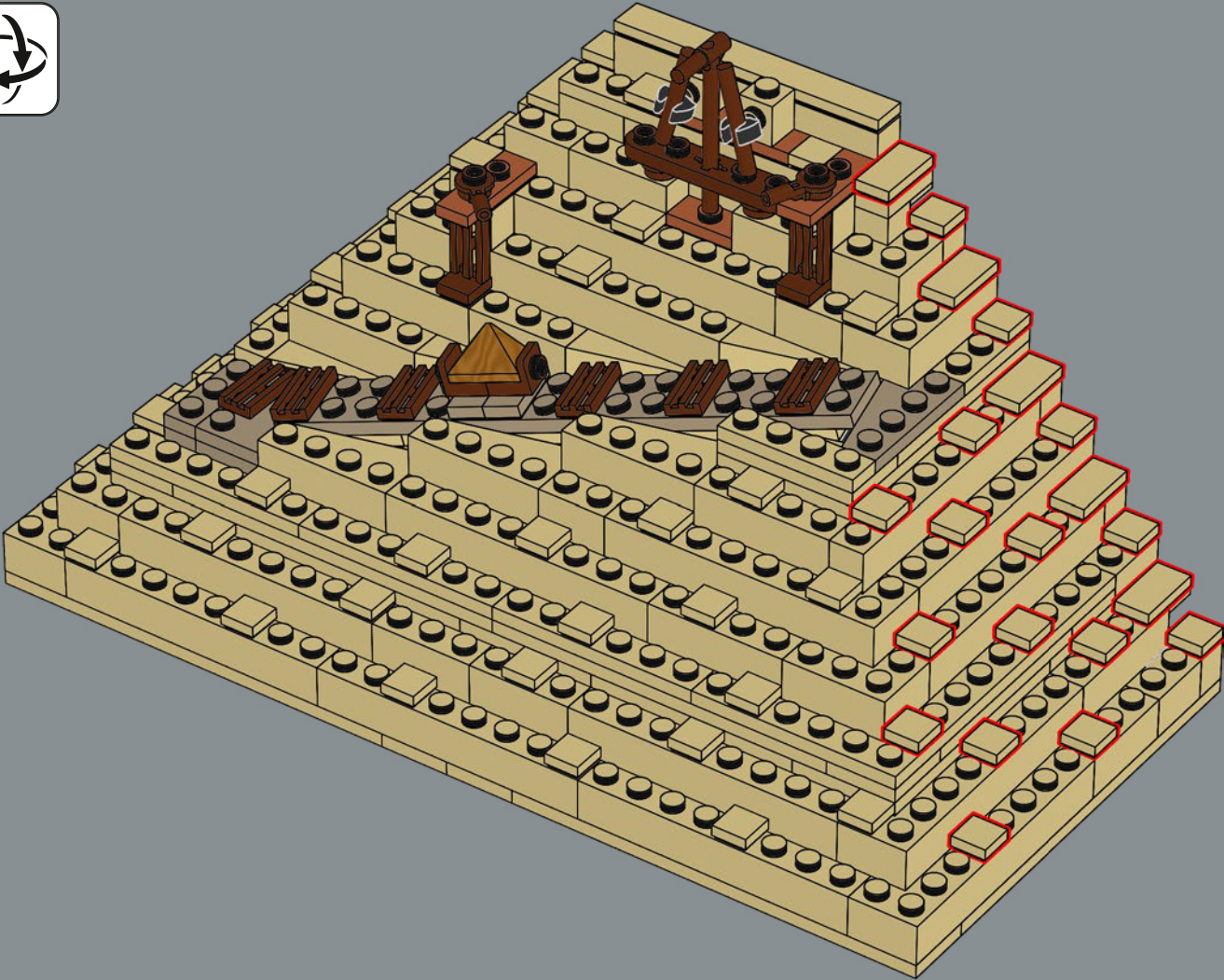



133

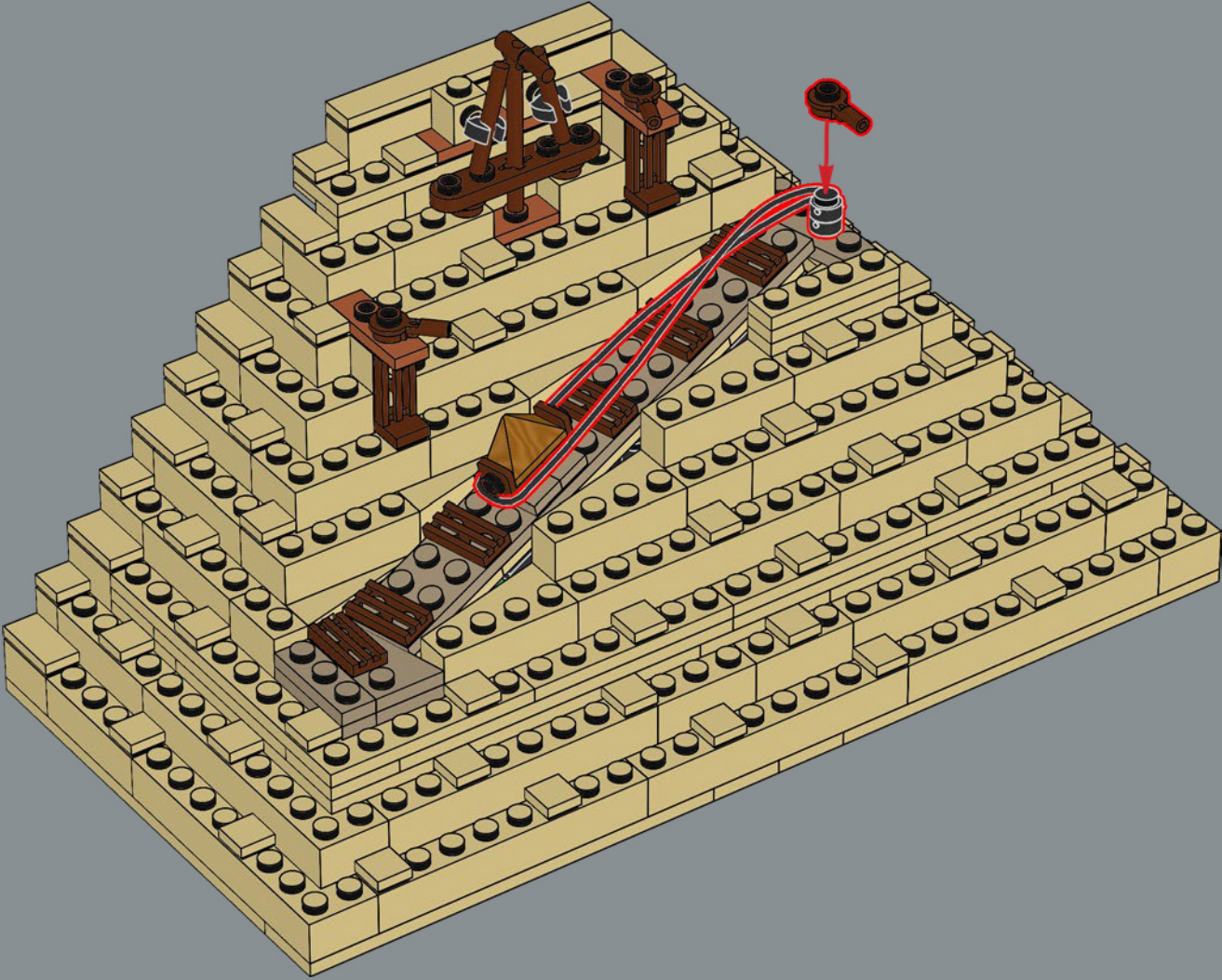

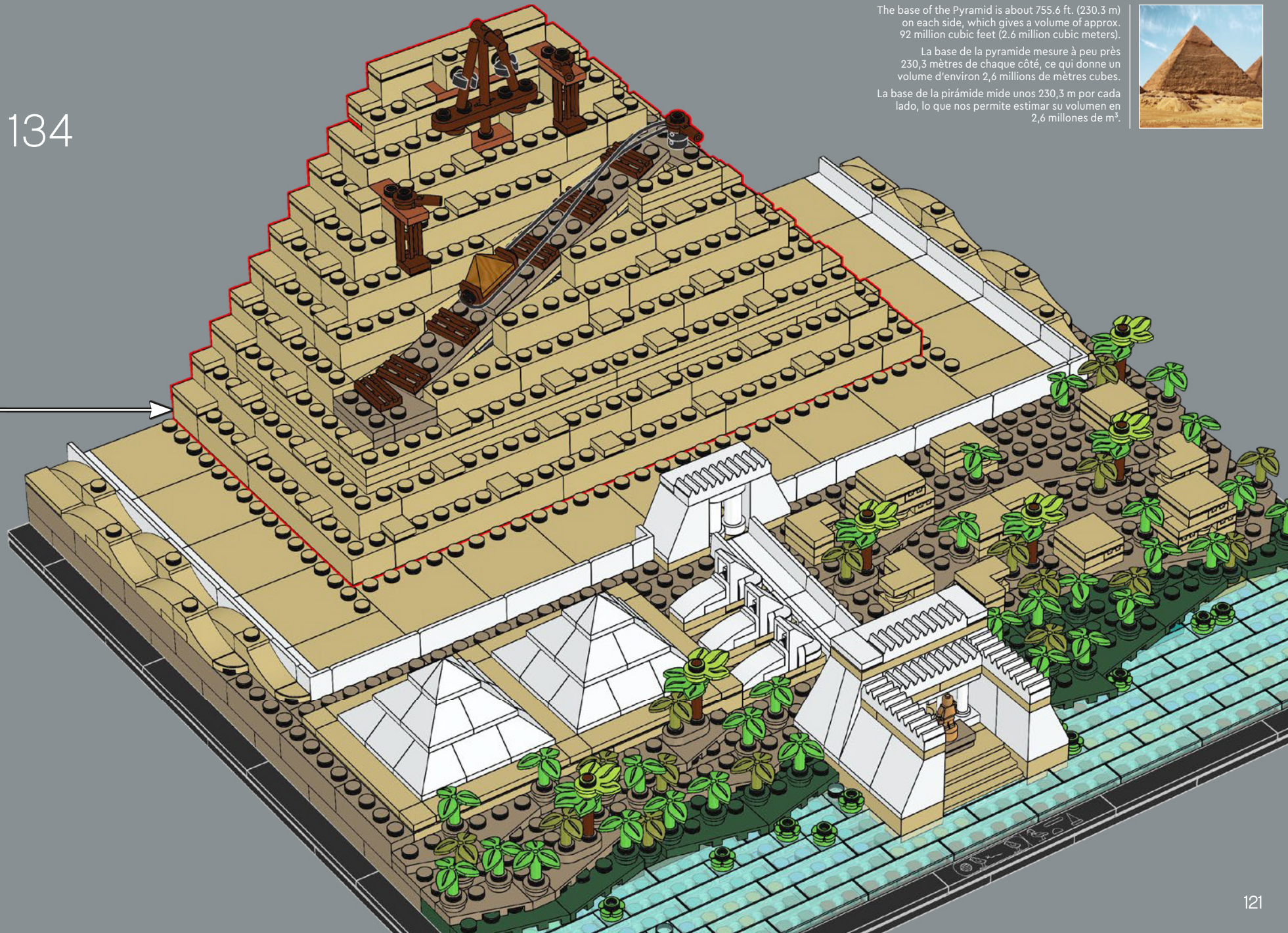

The base of the Pyramid is about 755.6 ft. (230.3 m) on each side, which gives a volume of approx. 92 million cubic feet (2.6 million cubic meters).

La base de la pyramide mesure à peu près 230,3 mètres de chaque côté, ce qui donne un volume d'environ 2,6 millions de mètres cubes.

La base de la pirámide mide unos 230,3 m por cada lado, lo que nos permite estimar su volumen en 2,6 millones de m³.



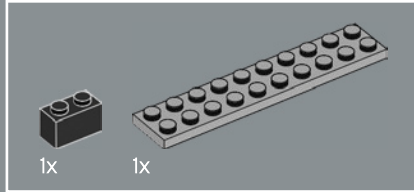
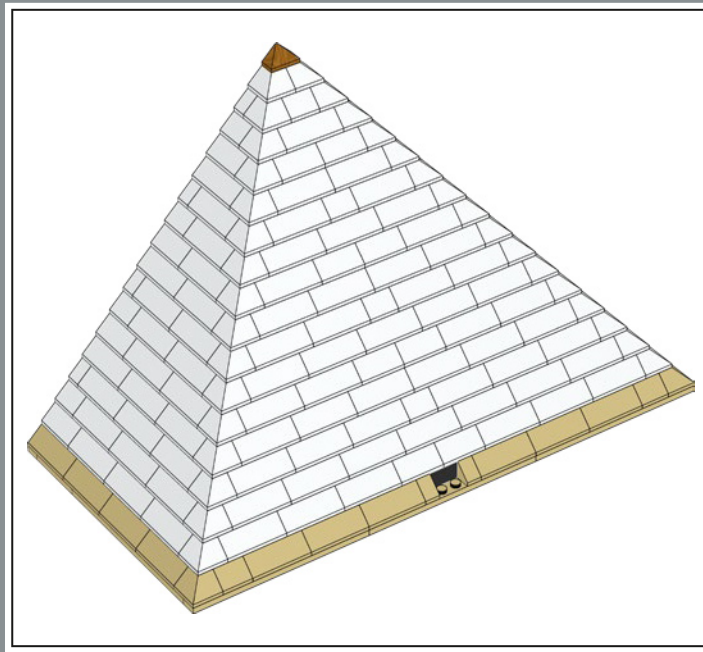

135

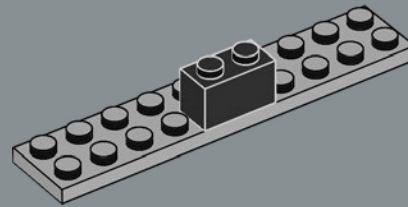



136

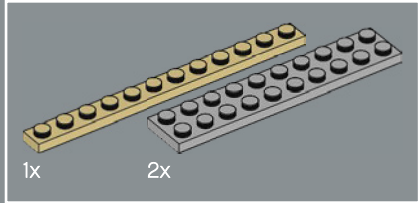
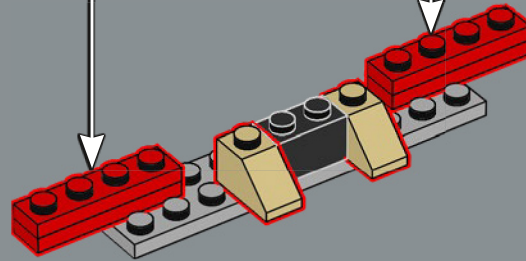
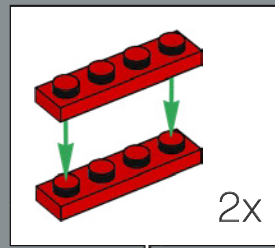

137

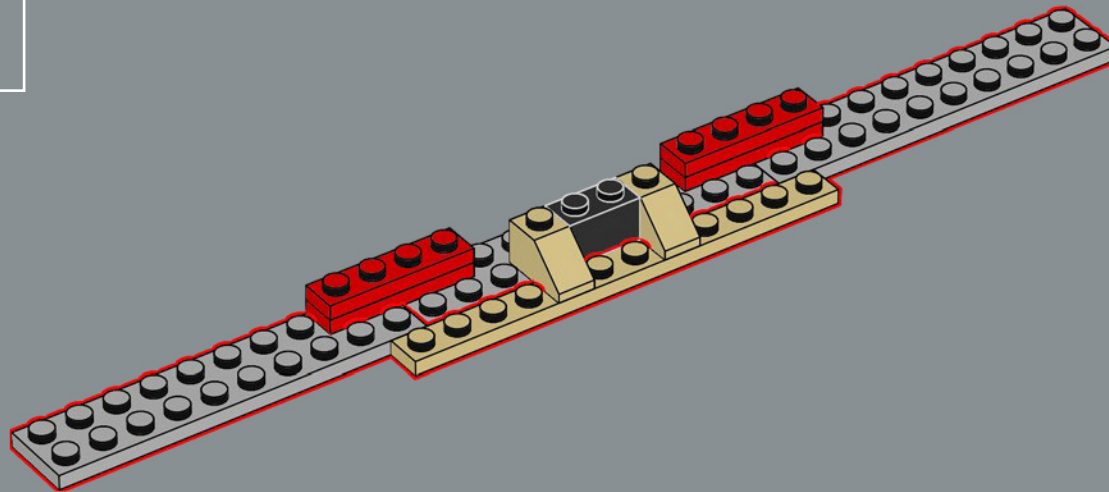

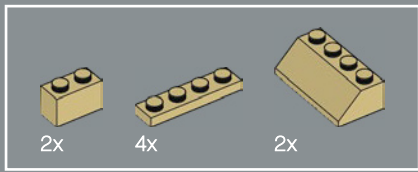

140

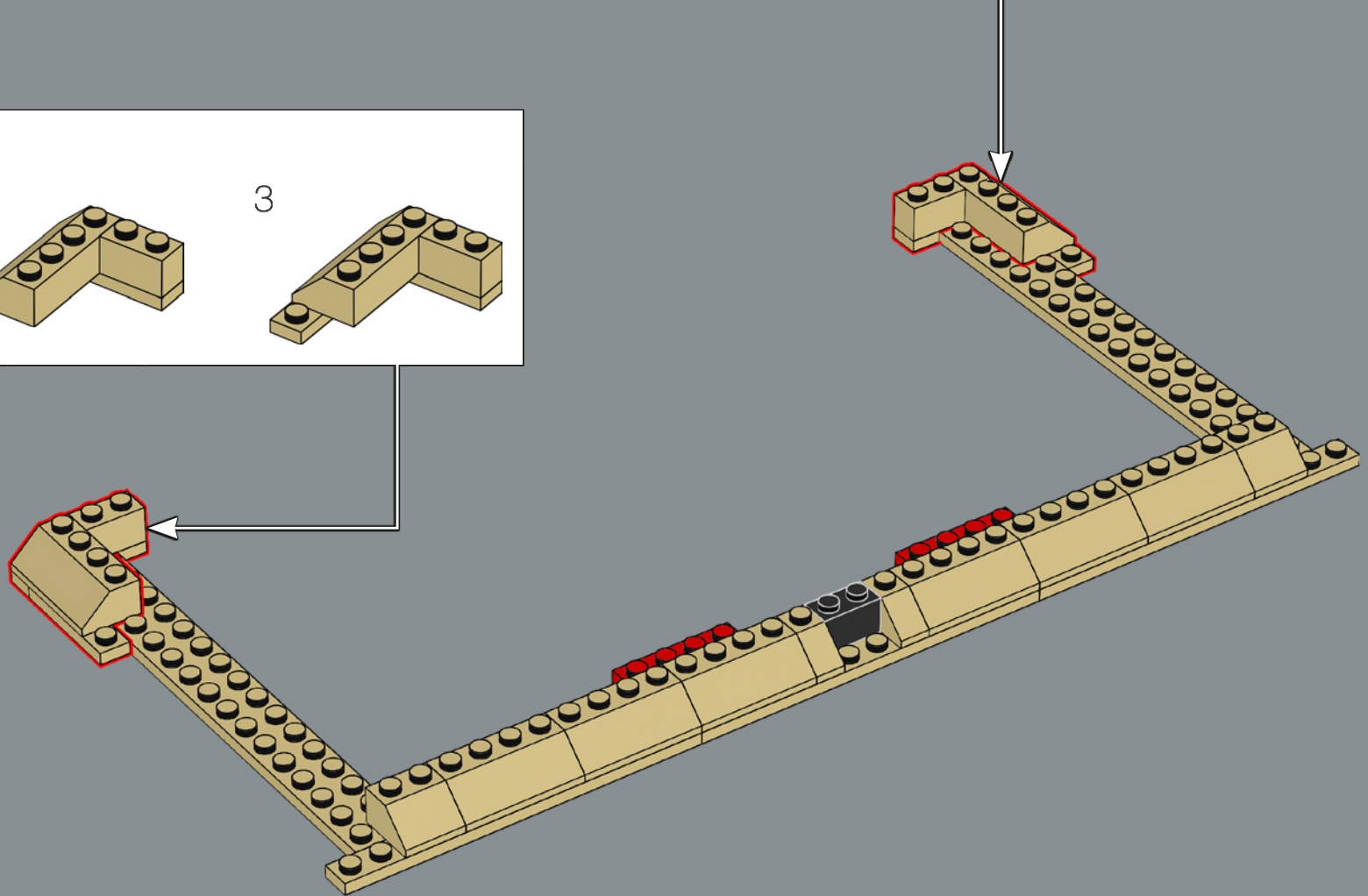
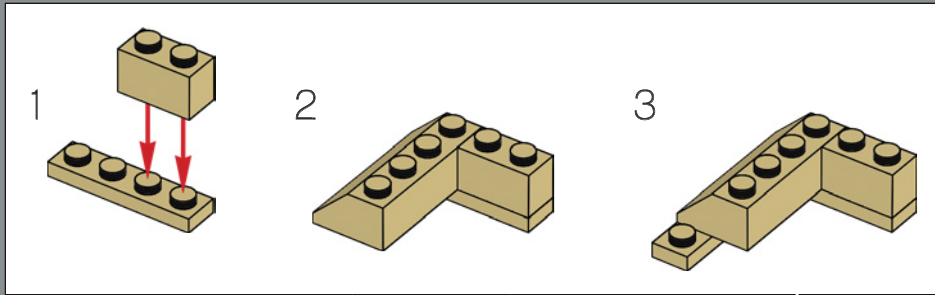
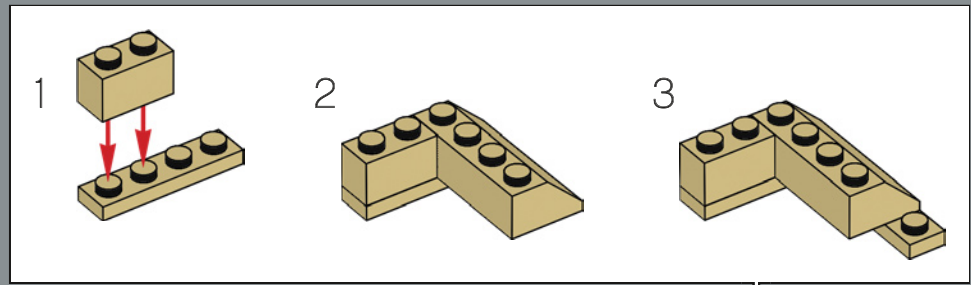

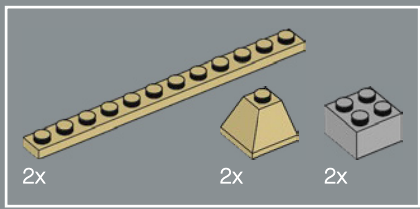

141

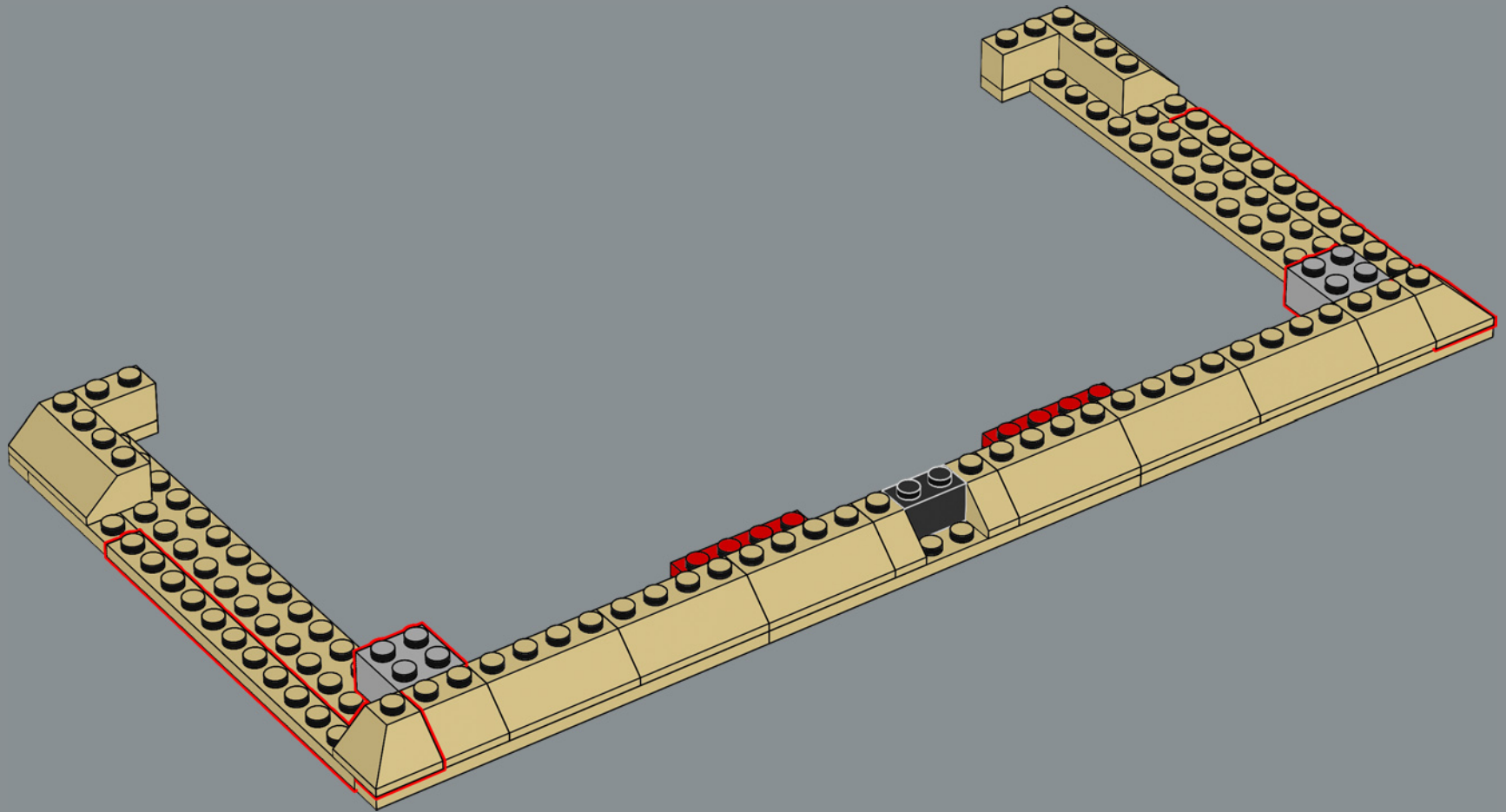

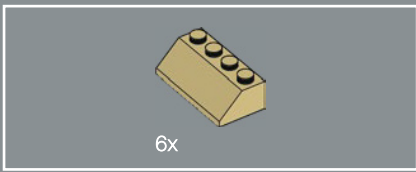

142

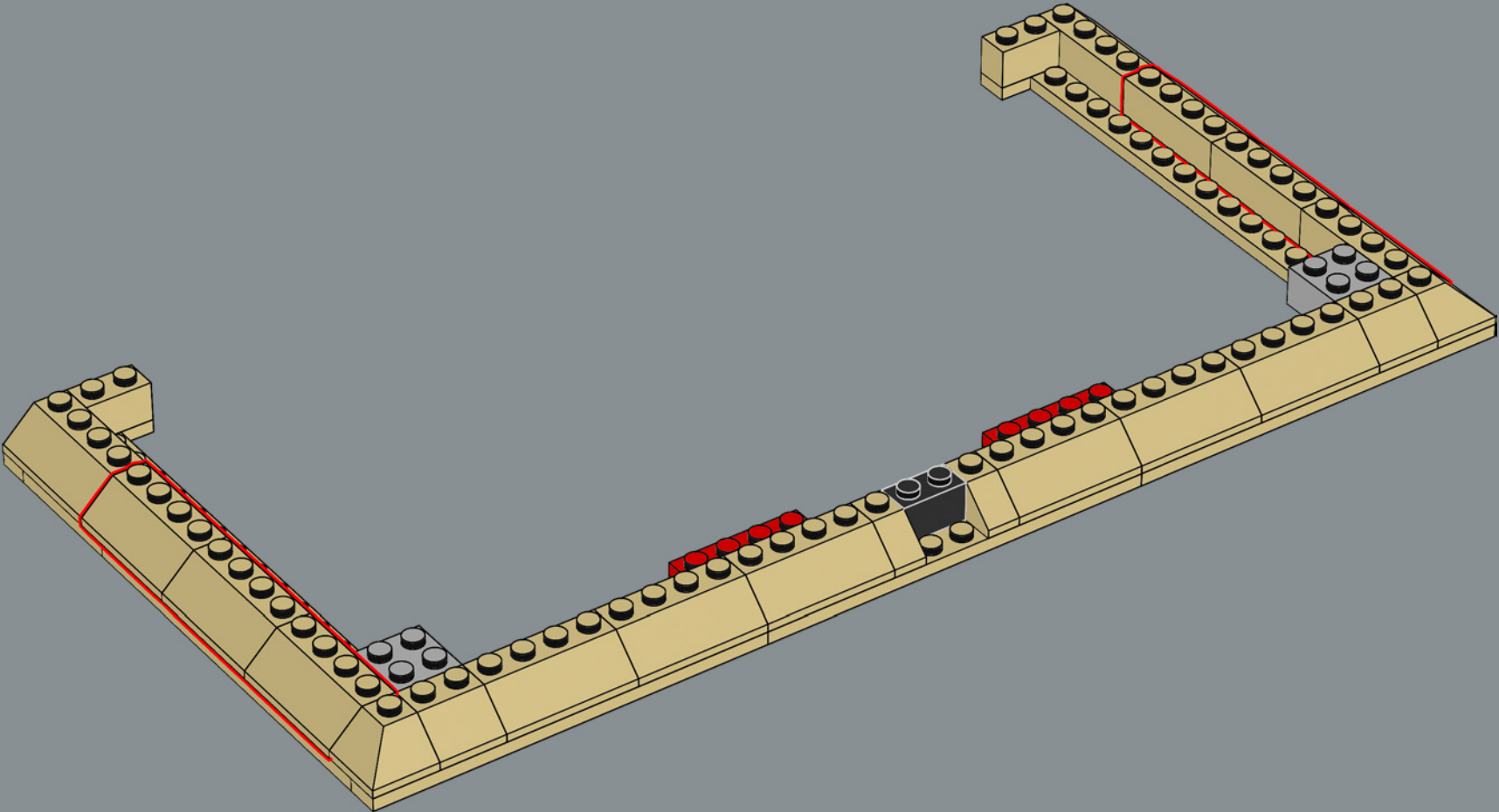

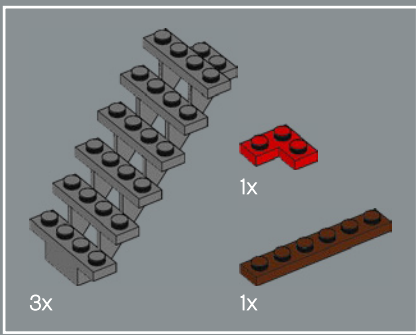

143

The LEGO® element used to support the shell of the Pyramid is more commonly used as a staircase for LEGO minifigures.

L'élément LEGO® utilisé pour soutenir le parement de la pyramide est plus souvent utilisé comme escalier pour les figurines LEGO.

El elemento LEGO® utilizado para sostener la carcasa exterior la pirámide se usa más comúnmente como escalera para minifiguras LEGO.

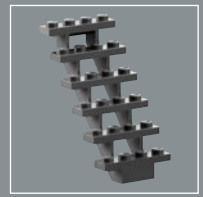

1

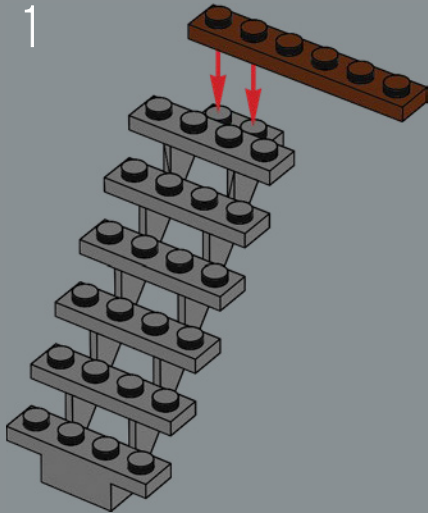

2

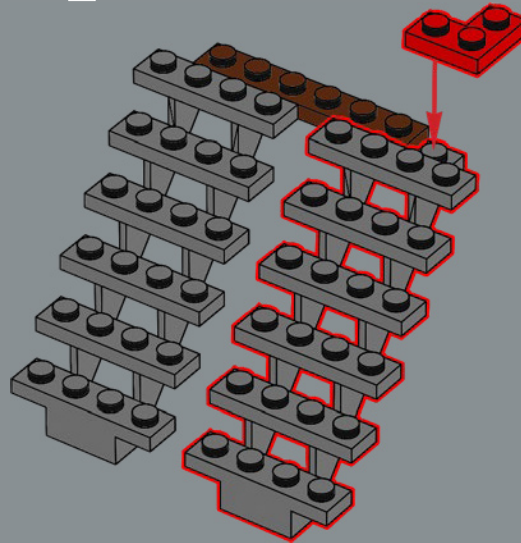

3

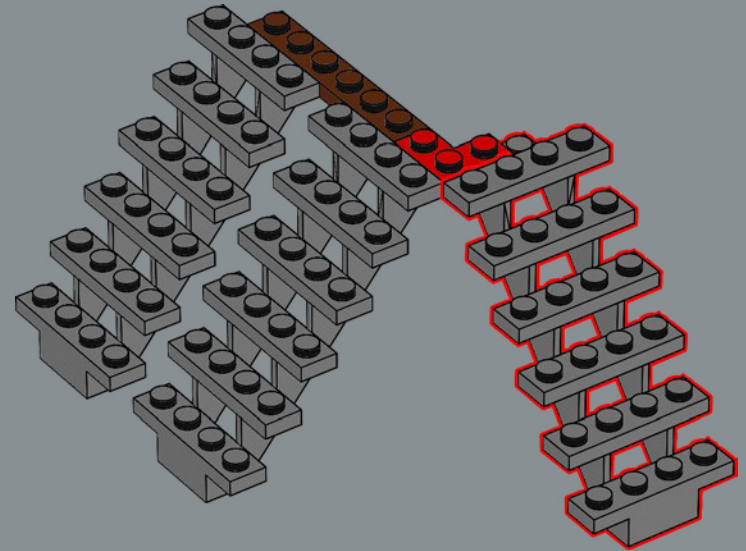

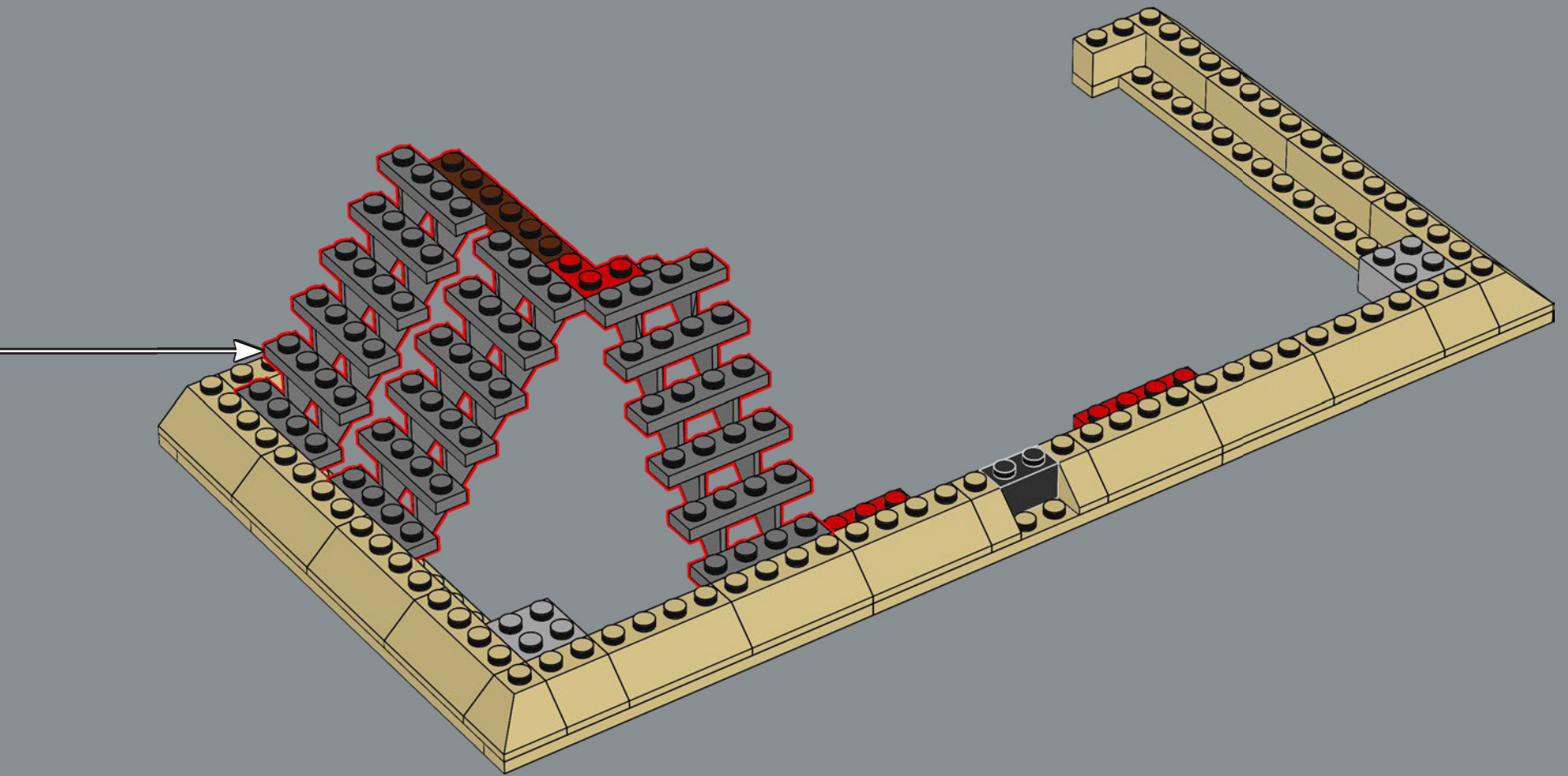

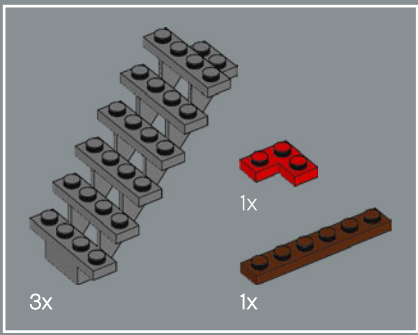

144

1

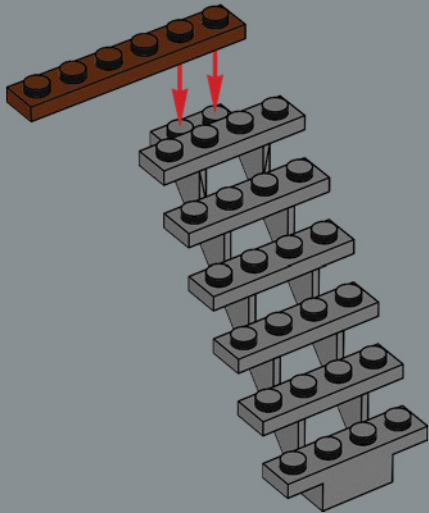

2

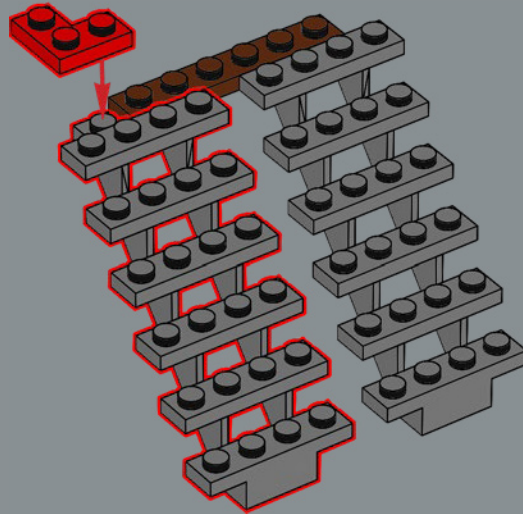

3

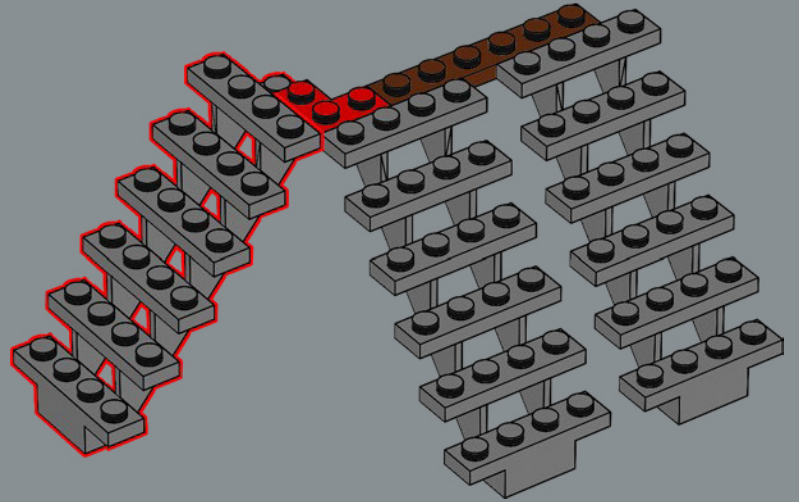

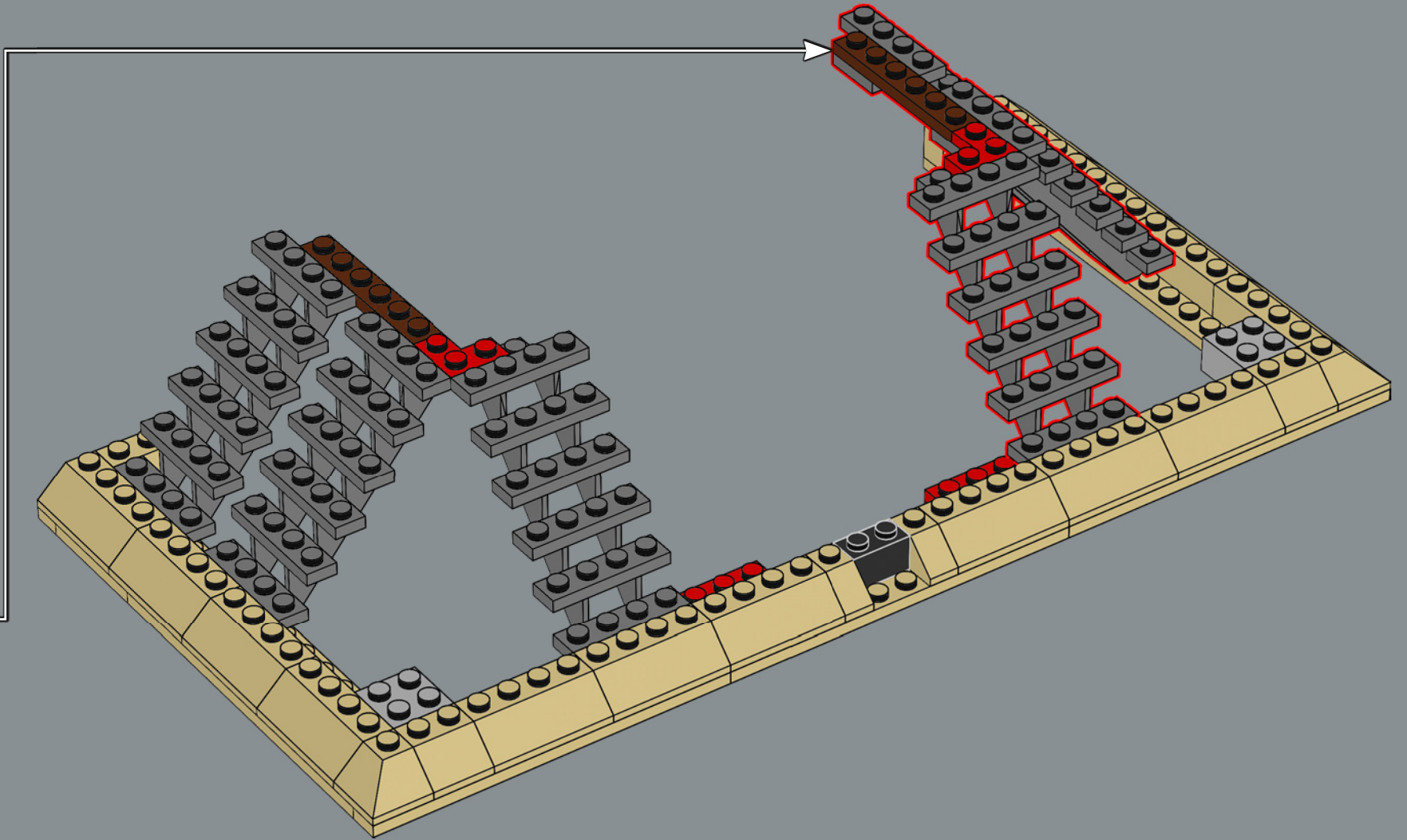

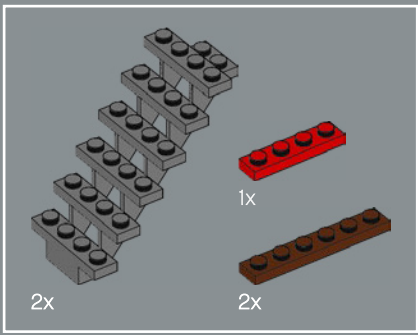

145

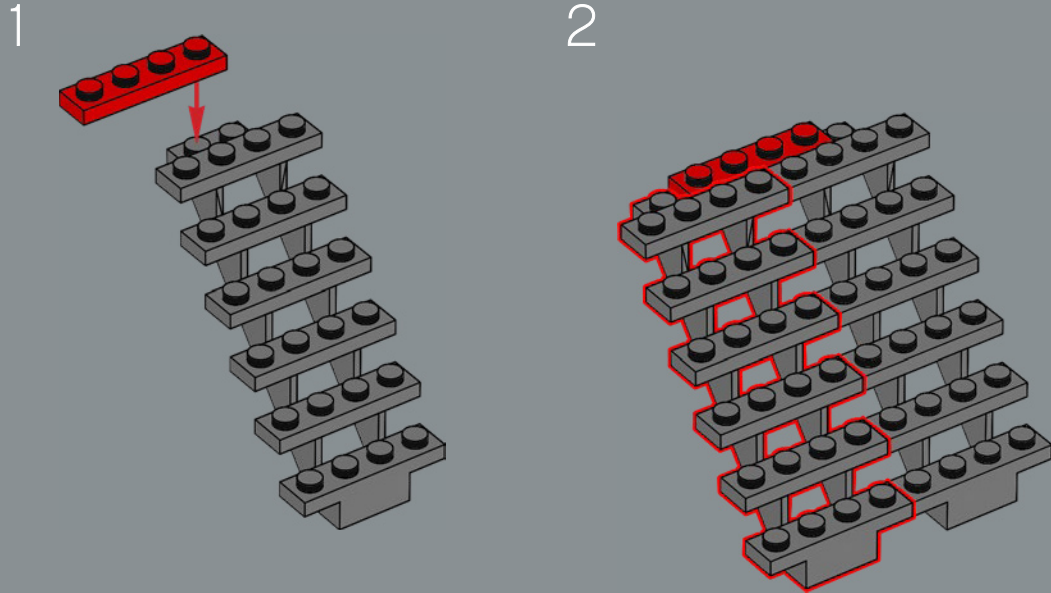

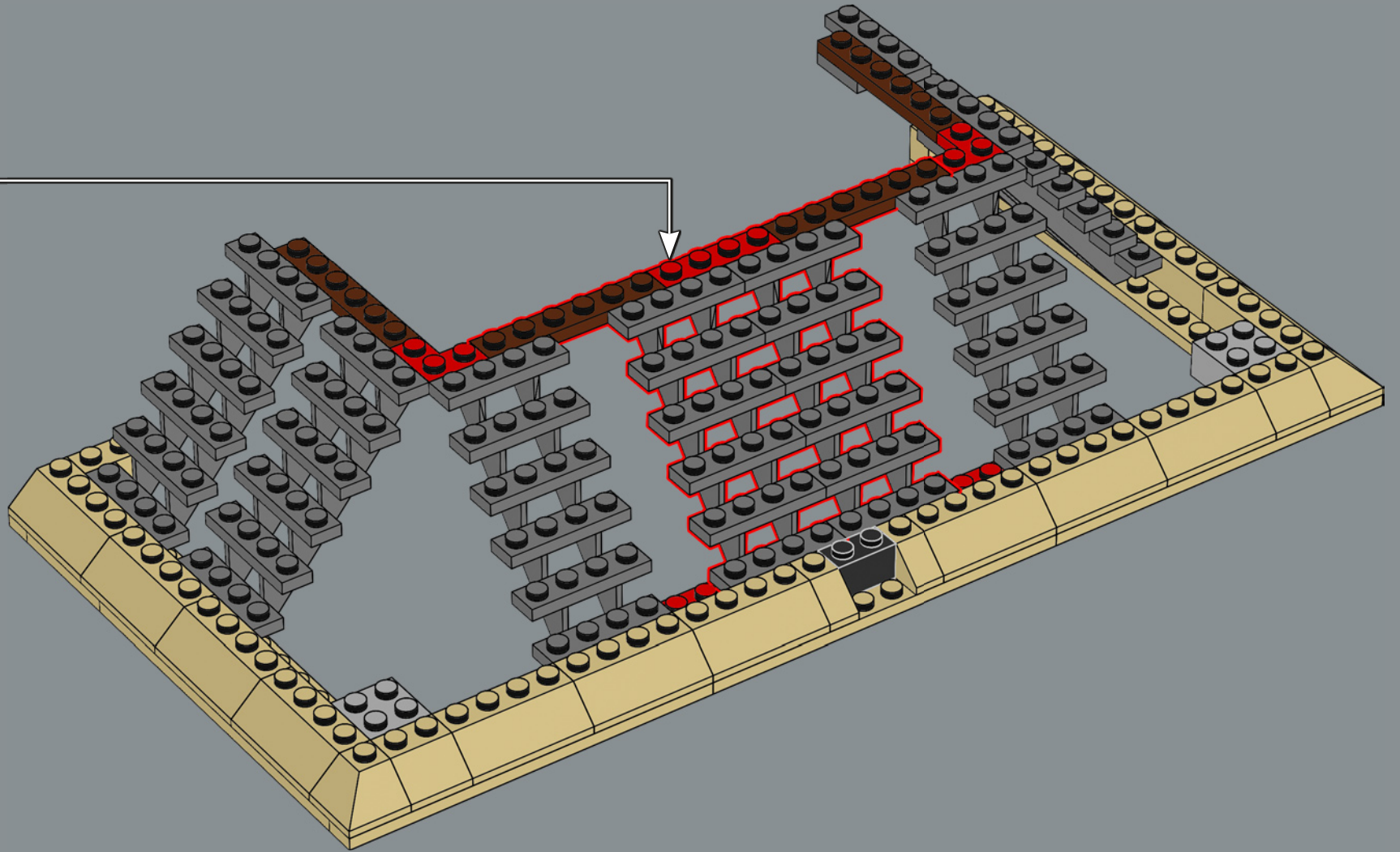

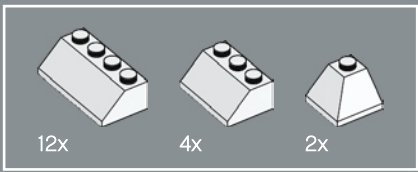

146

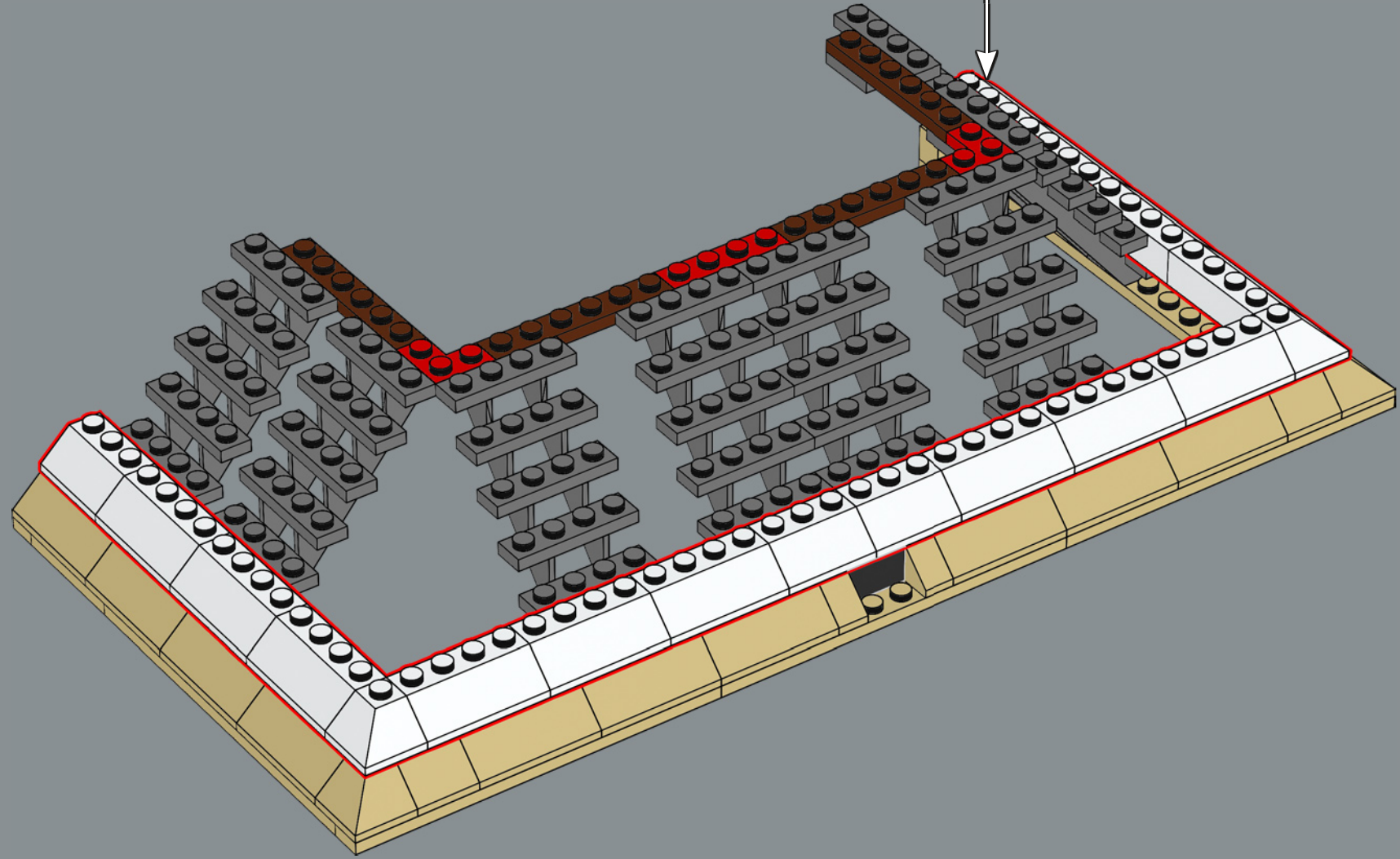
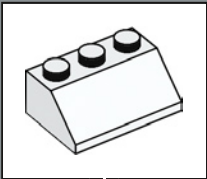

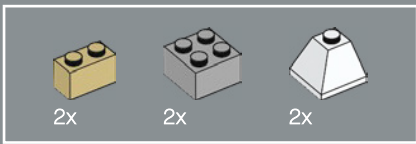

147

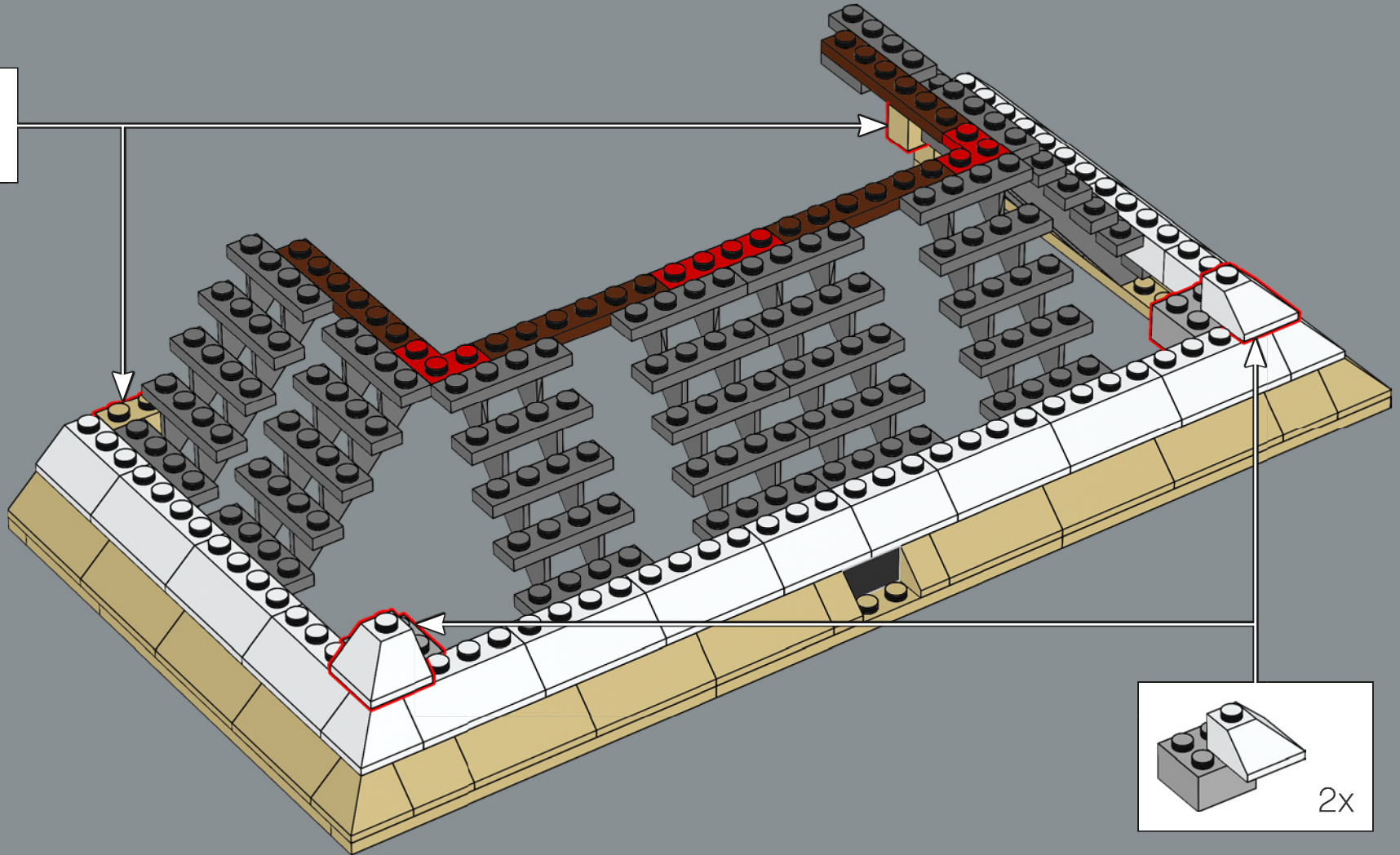
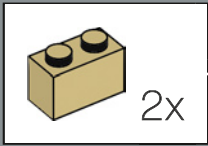

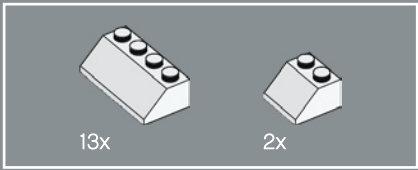

148

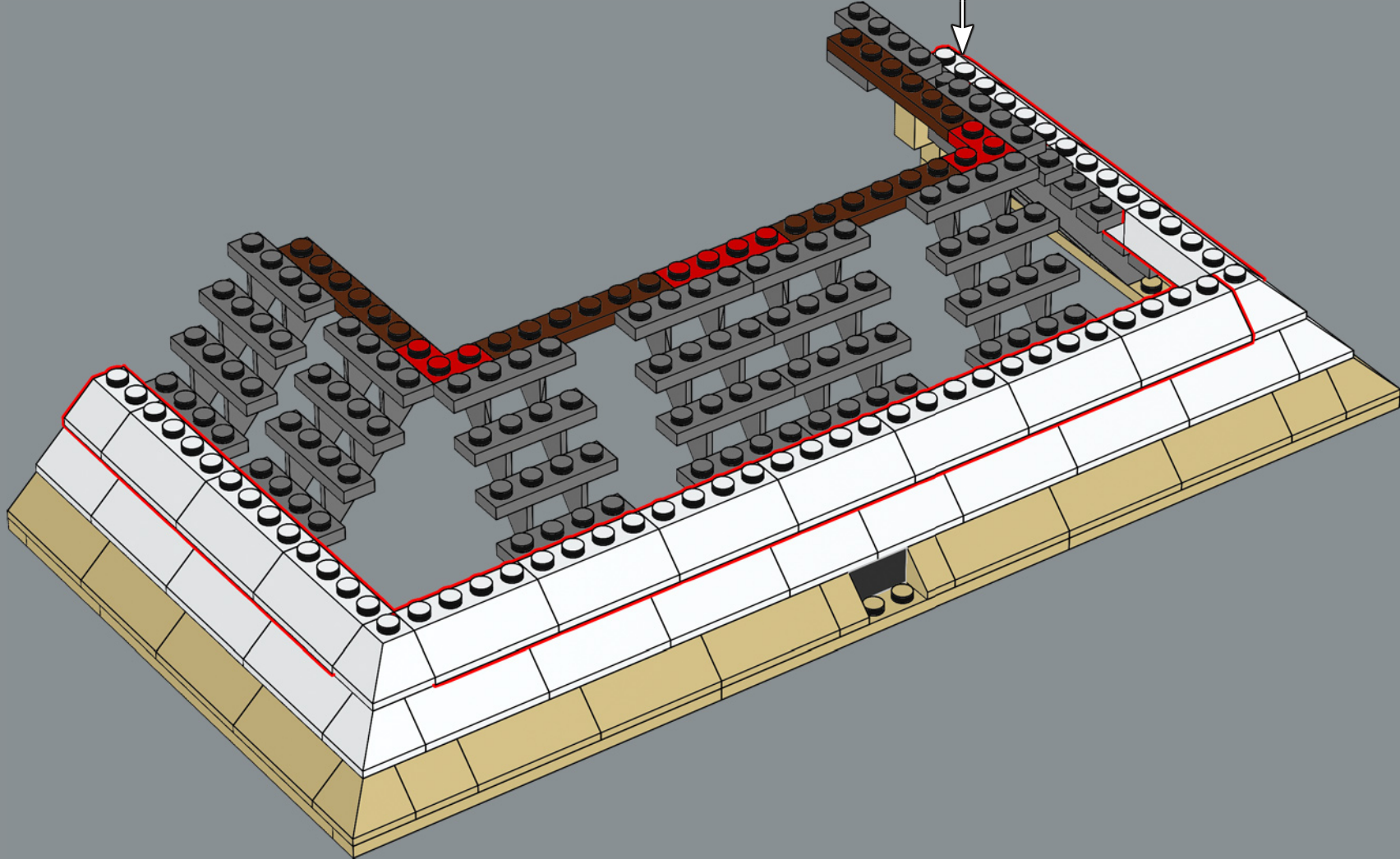
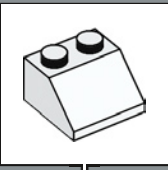

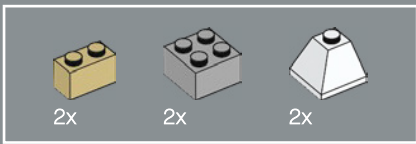

149

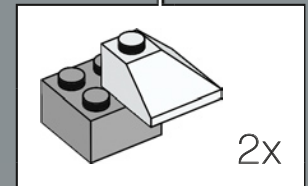
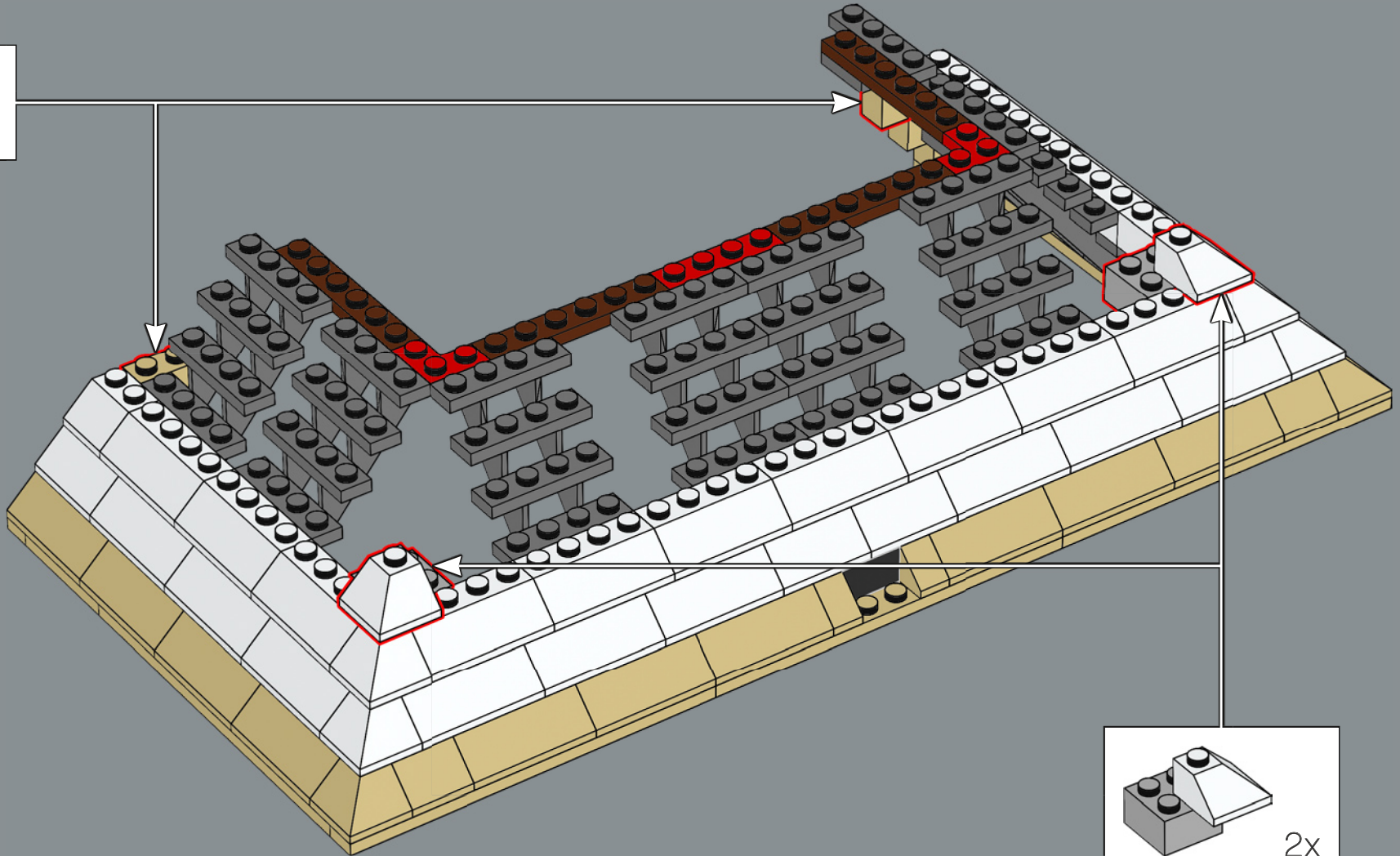
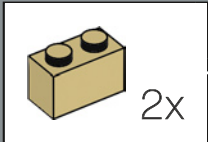

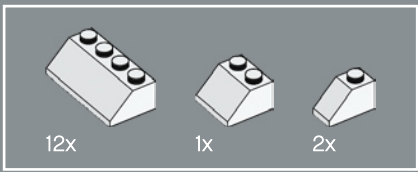

150

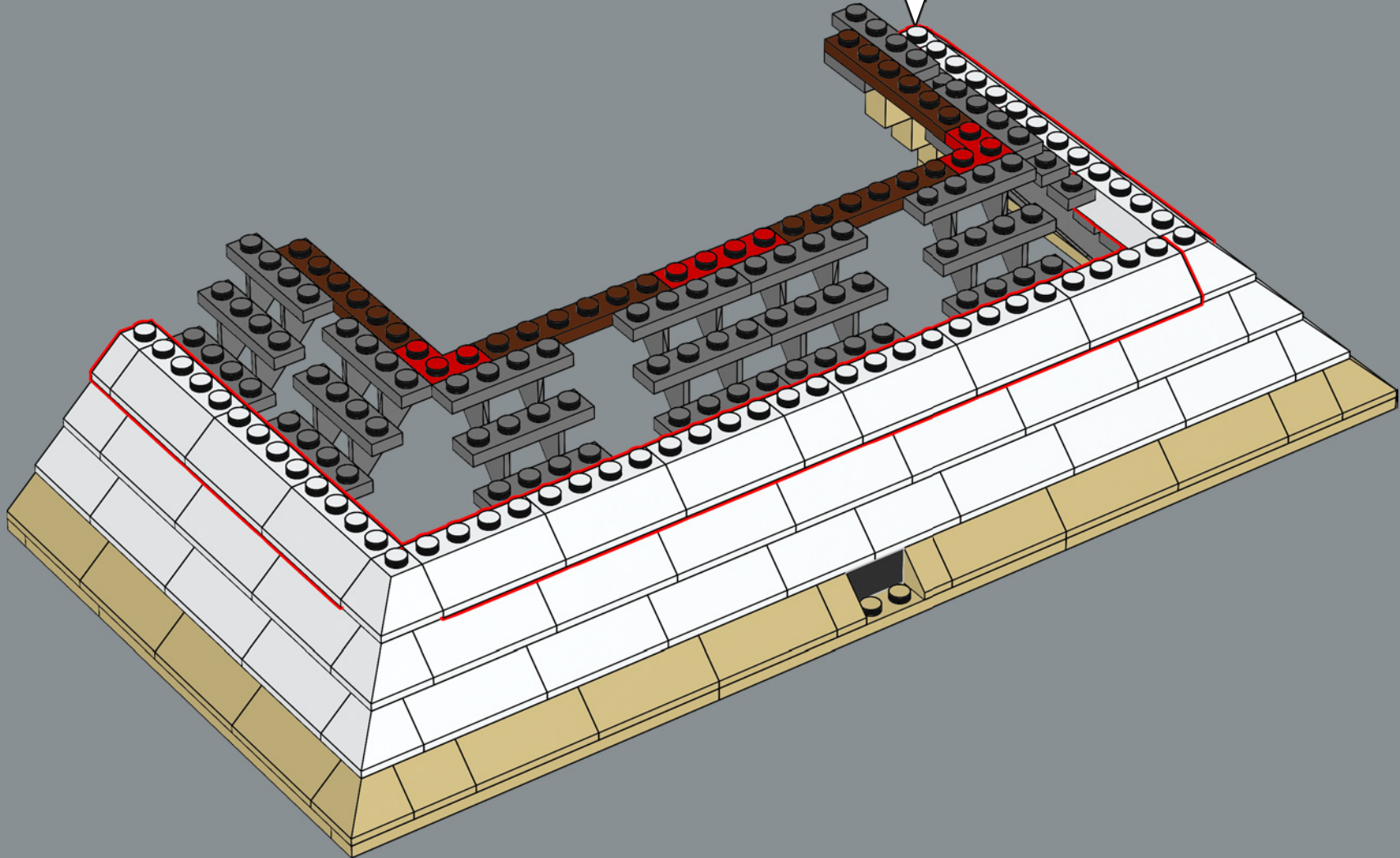
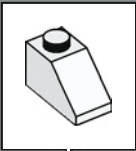

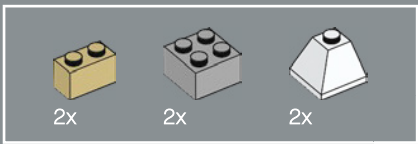

151

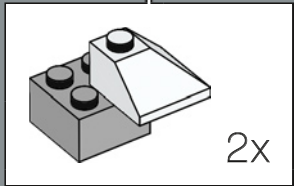
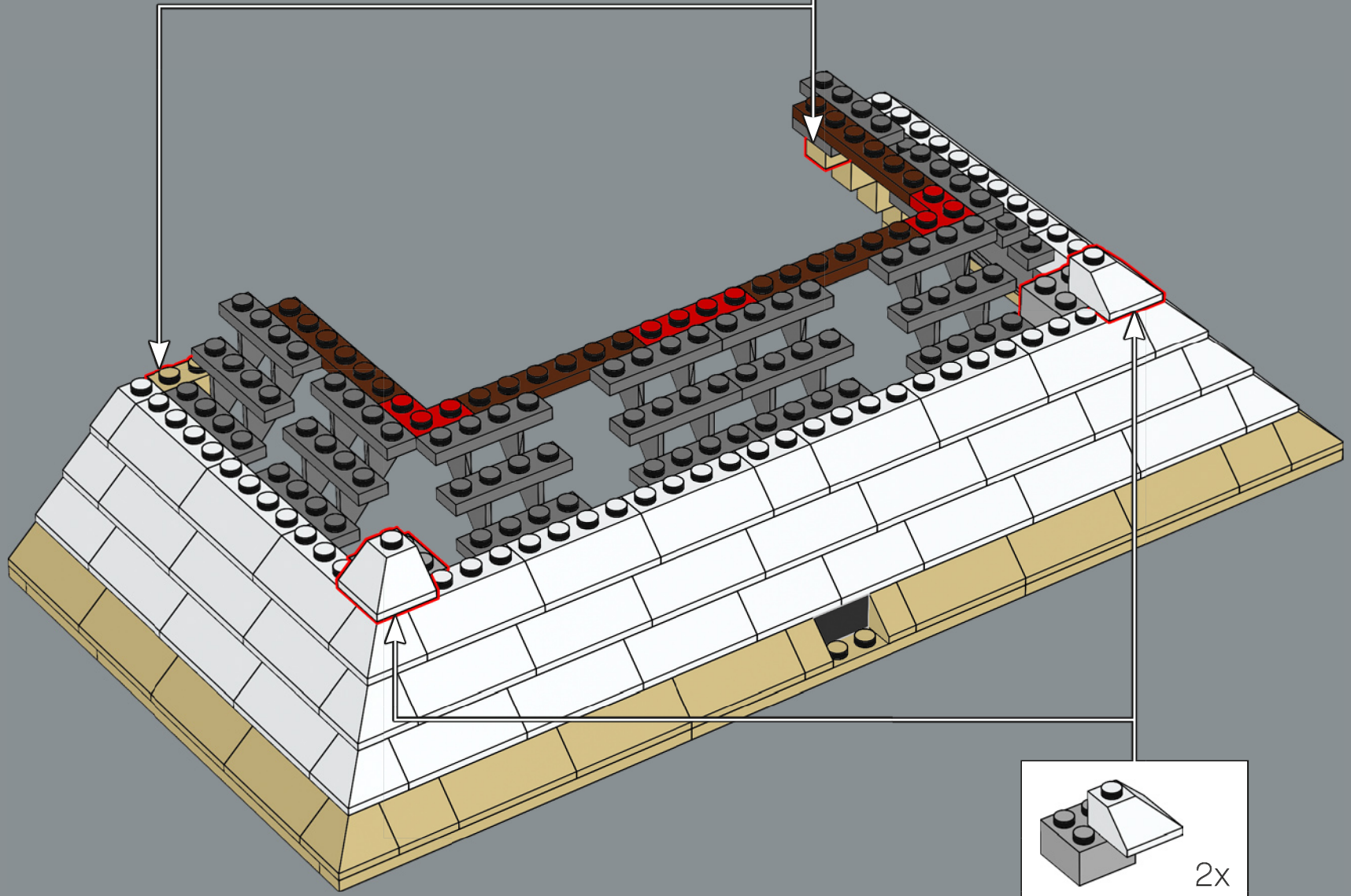
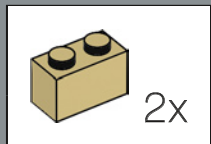

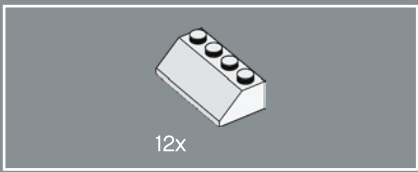

152

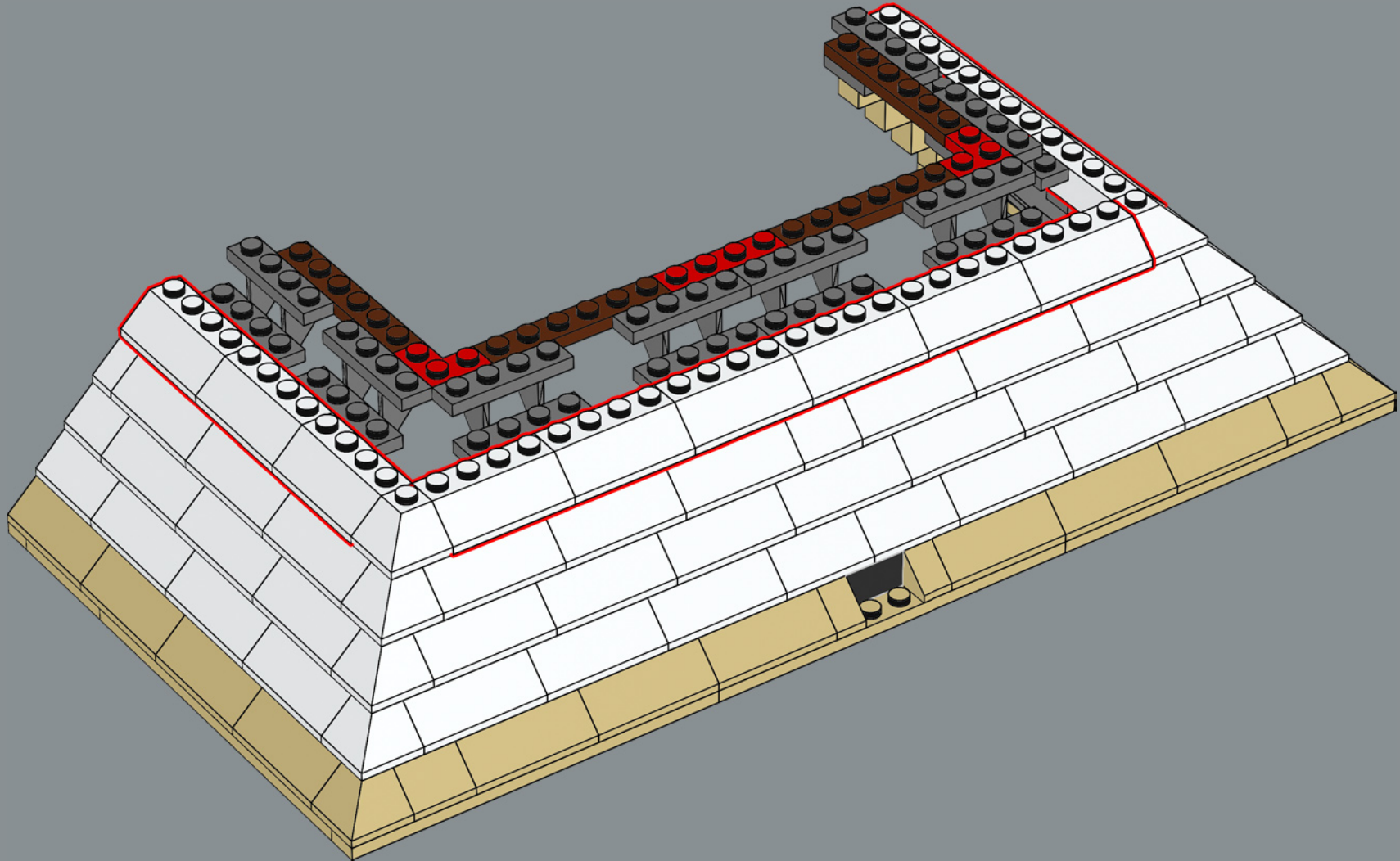

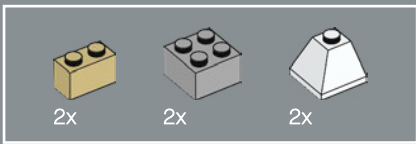

153

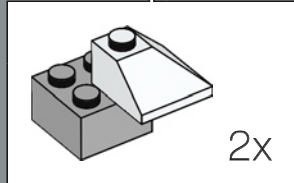
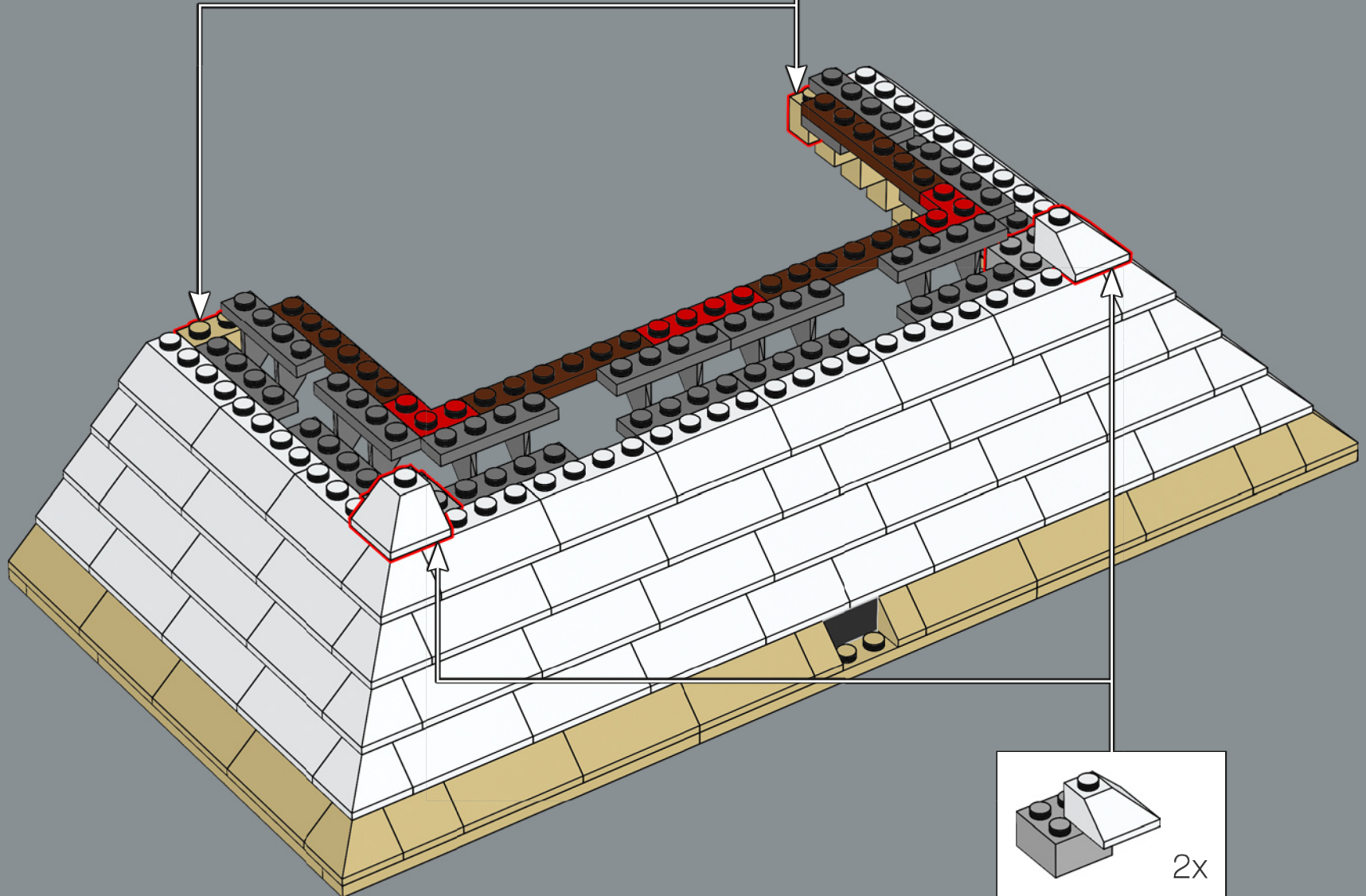
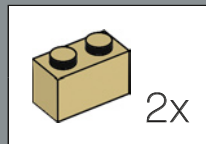

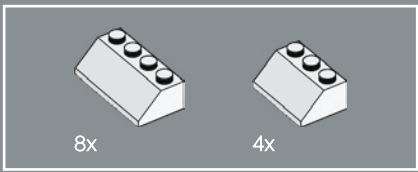

154

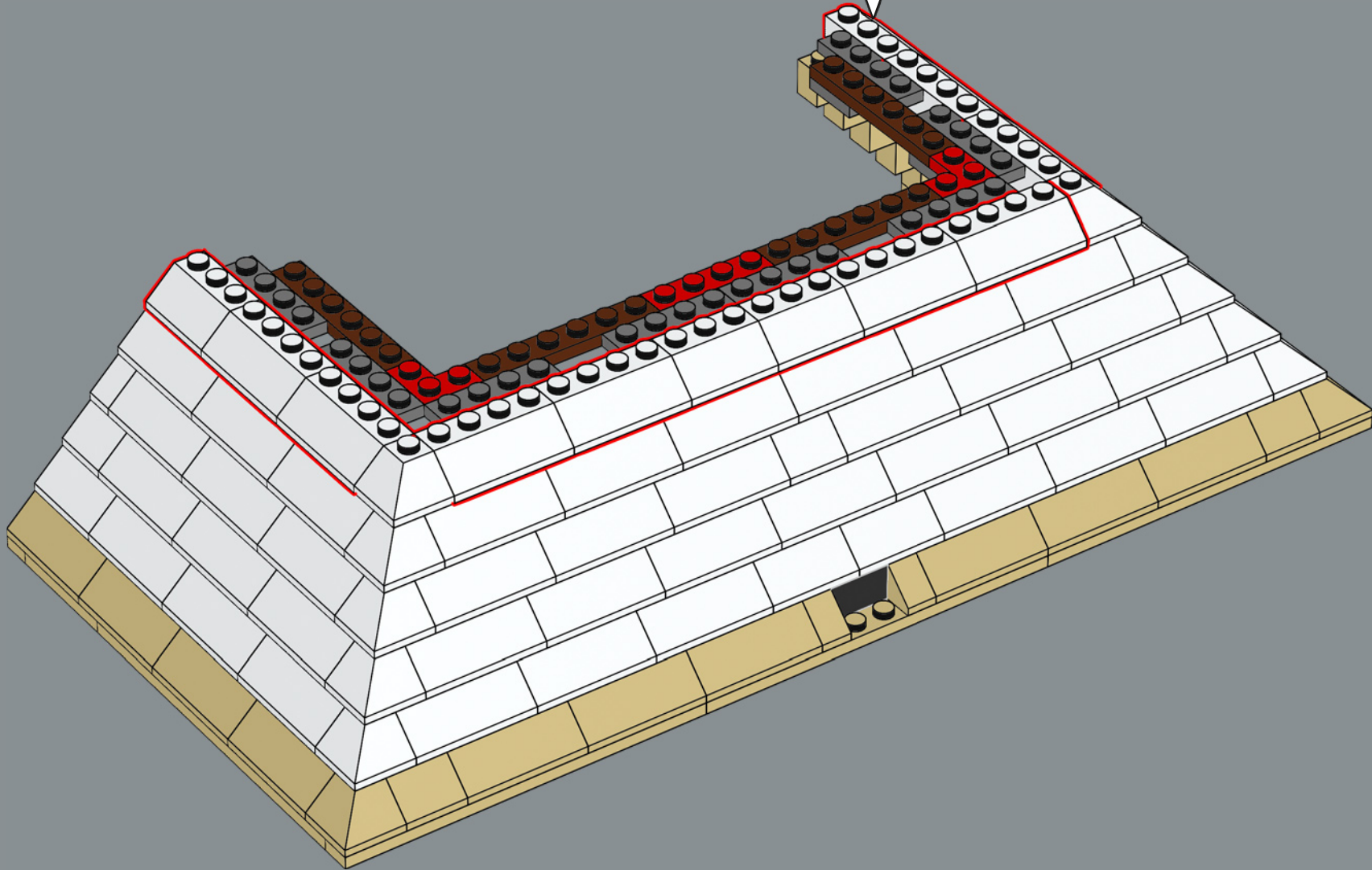
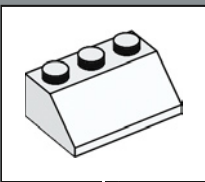

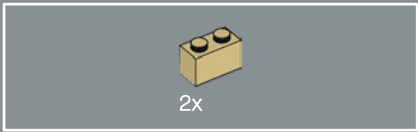

155

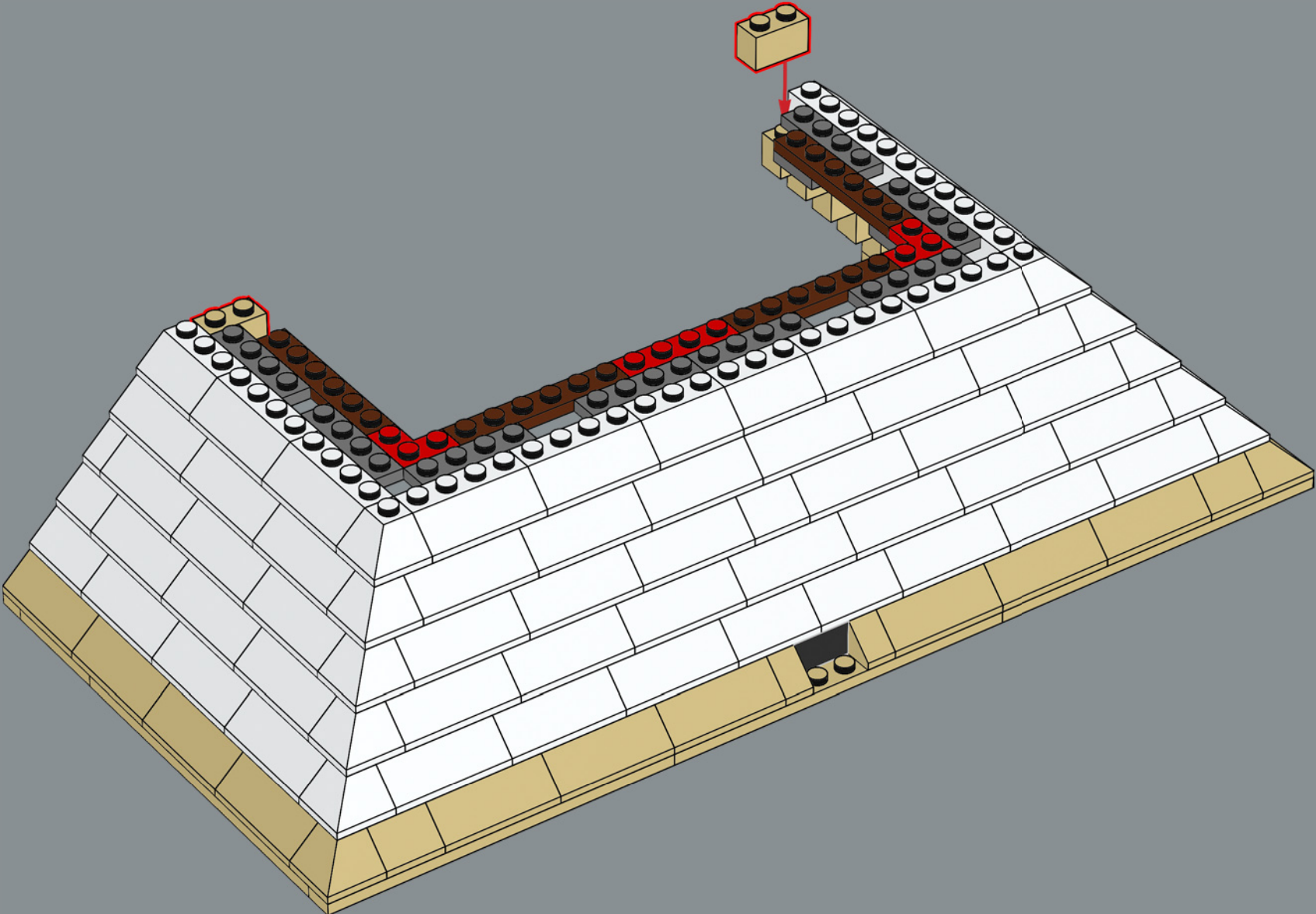



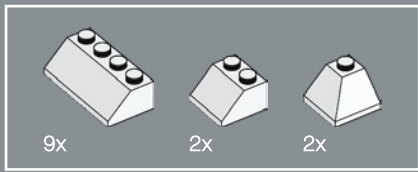

156

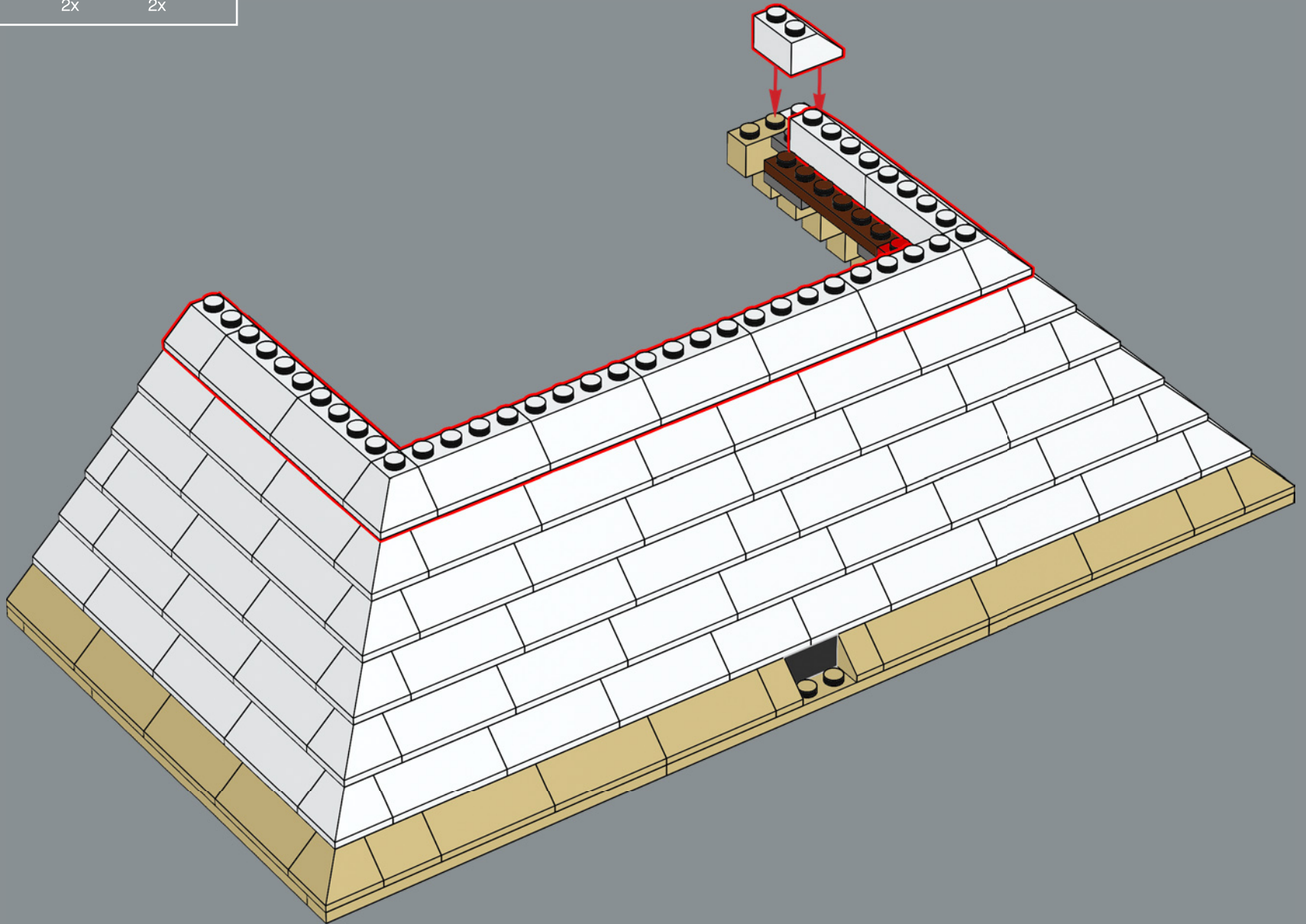

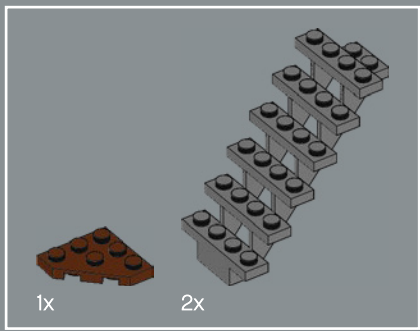

157

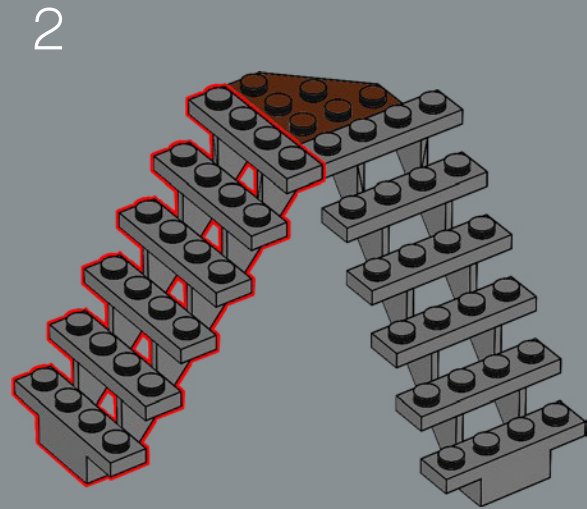
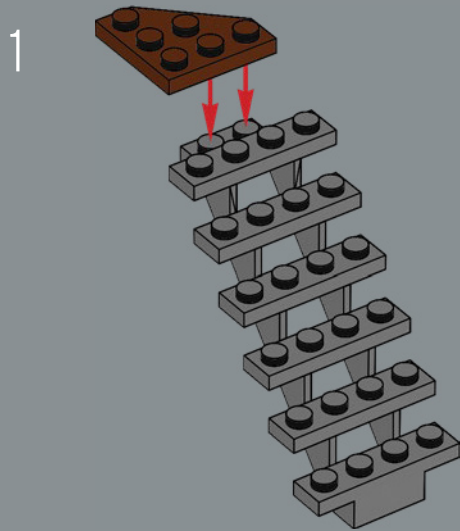

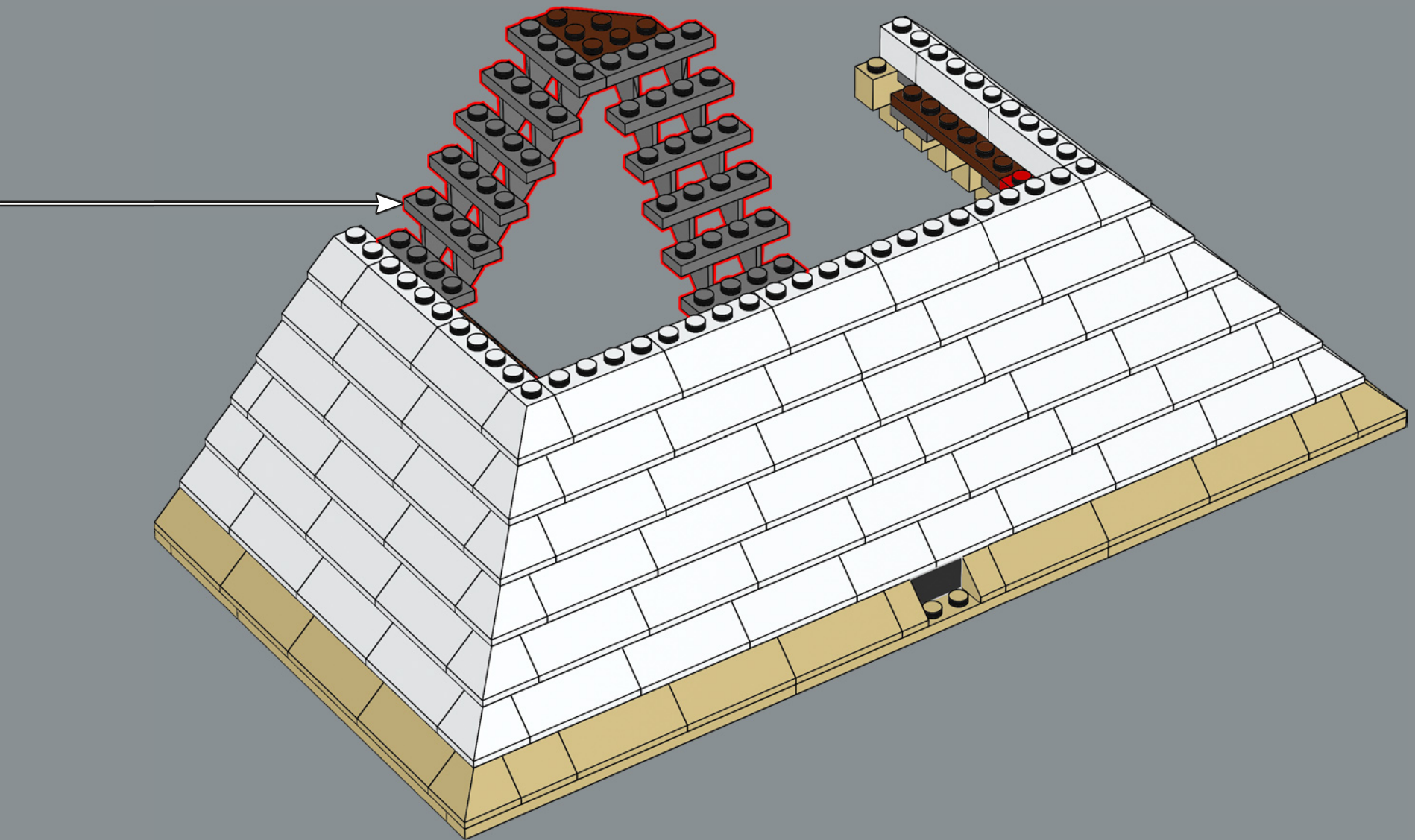

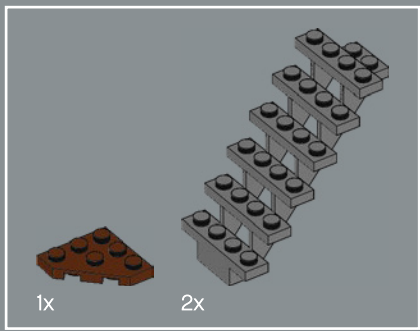

158

1

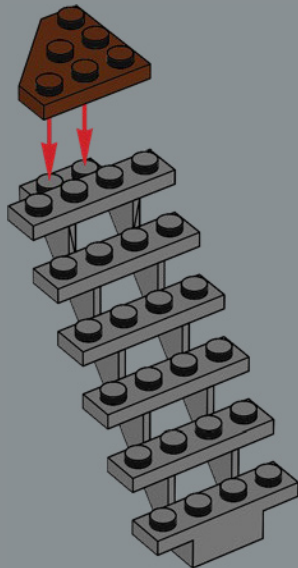

2

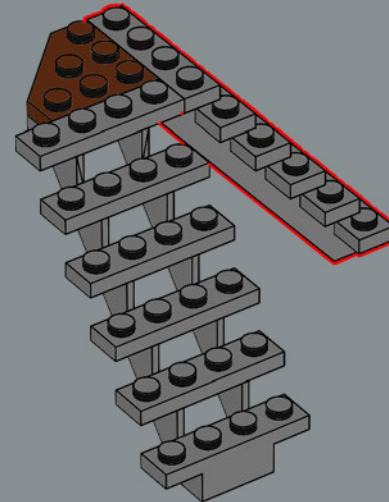

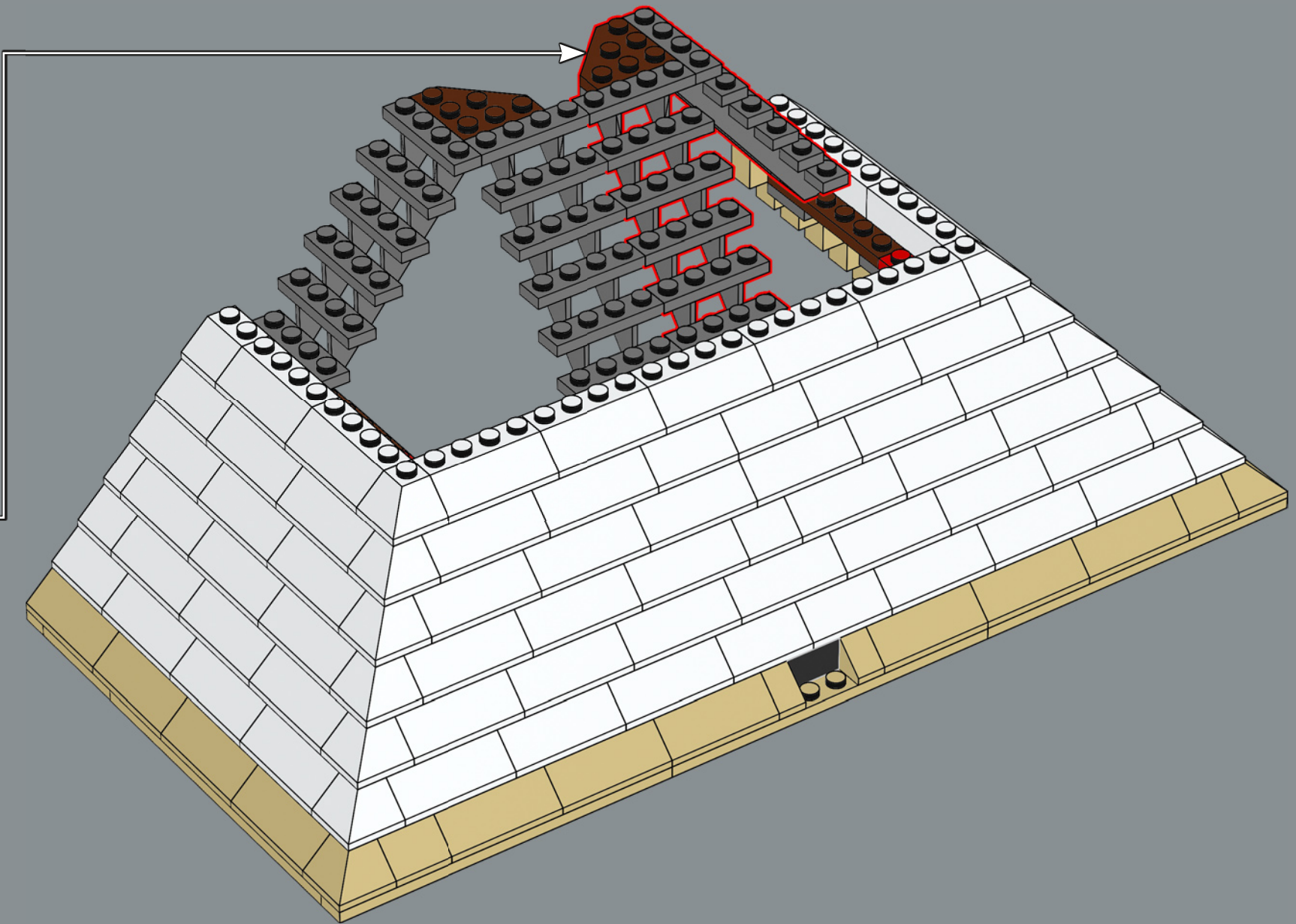

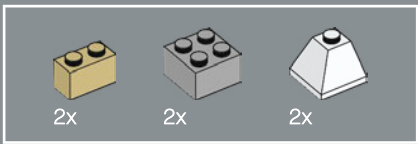

159

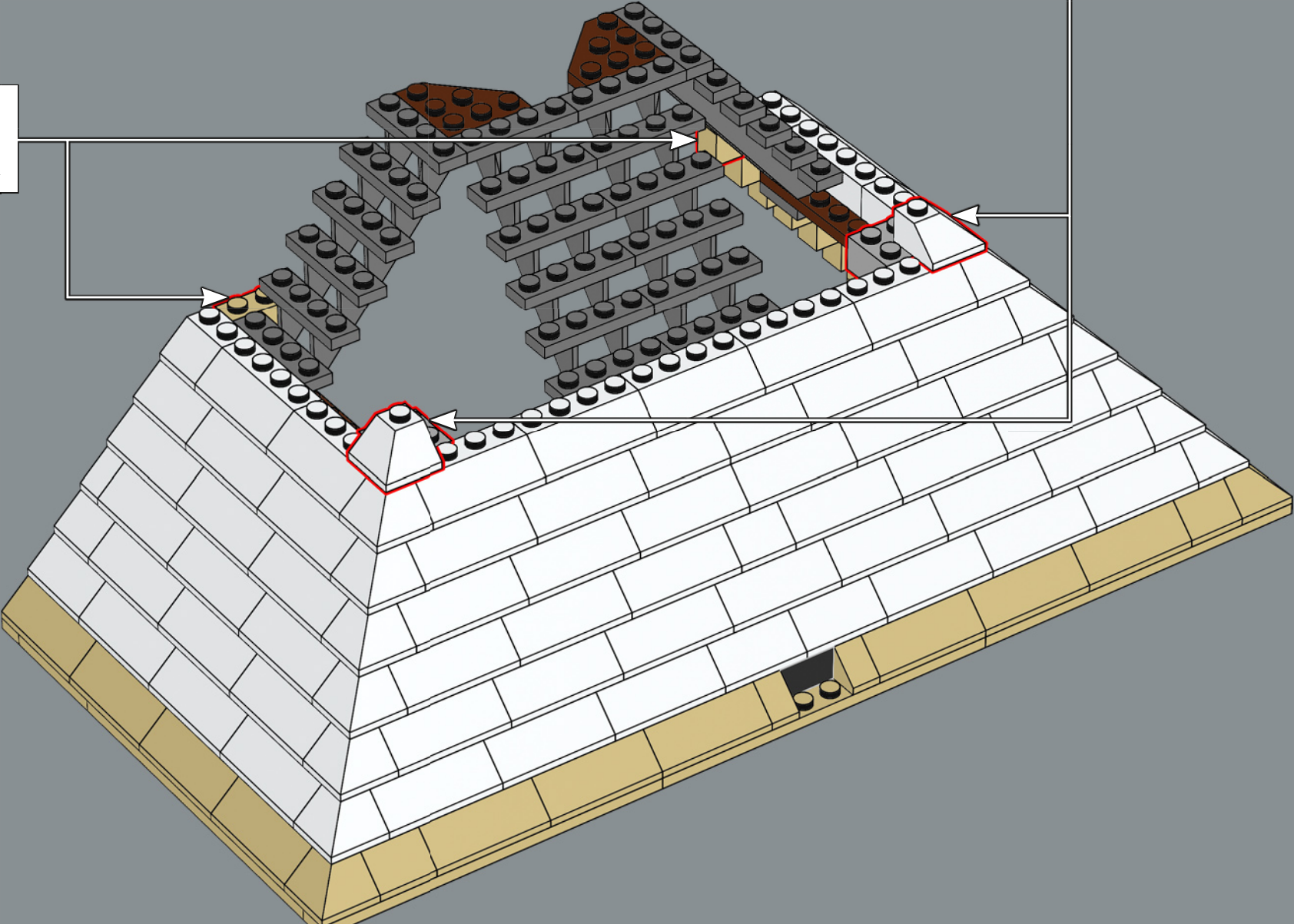
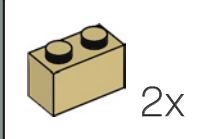
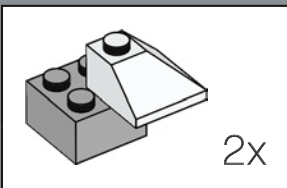

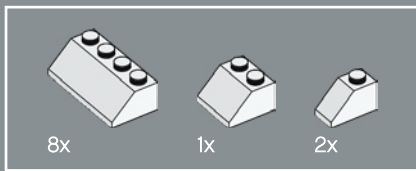

160

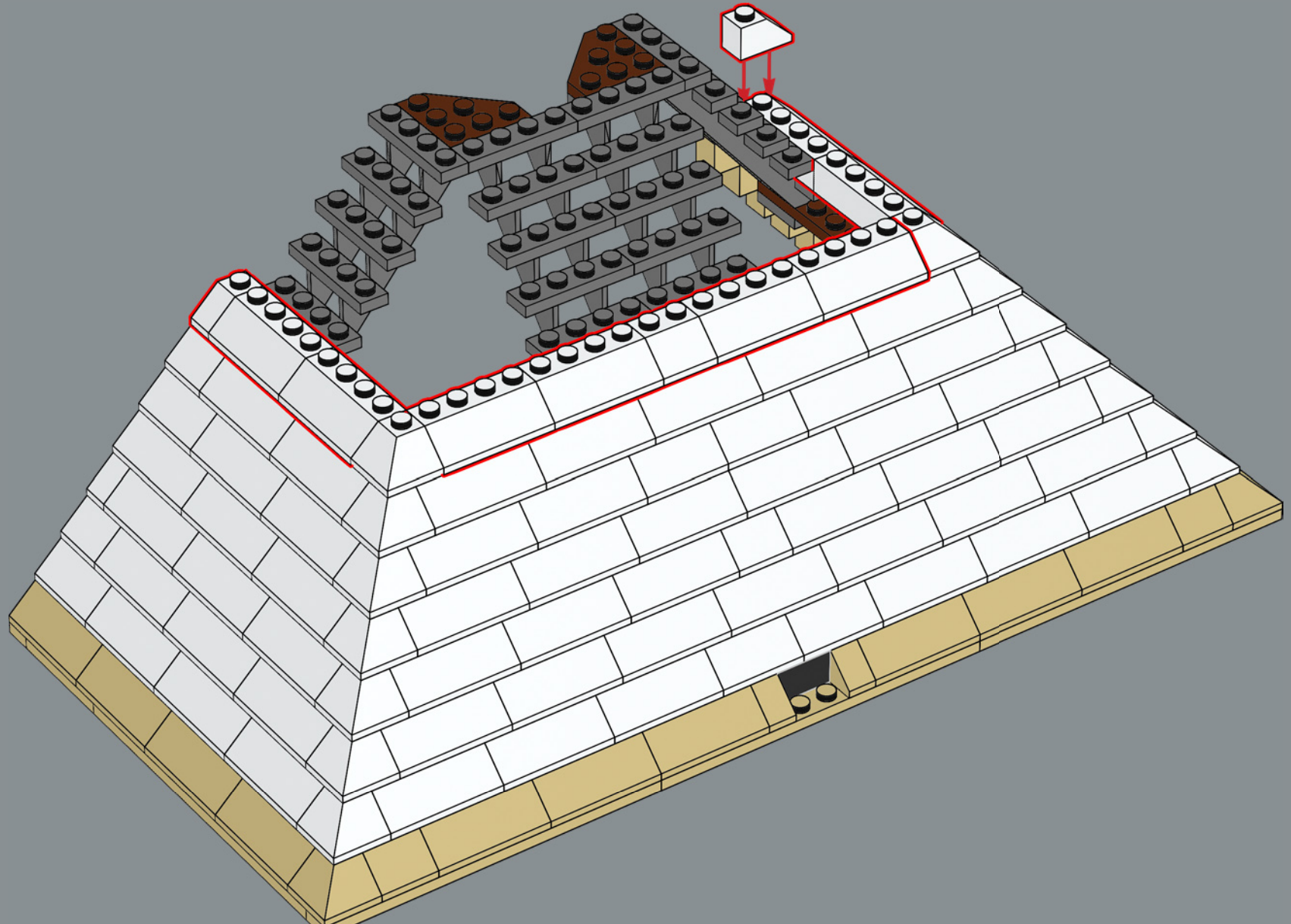

You can use the cross axle and matching holes on the back of the model to connect two of these sets together to create a whole Pyramid.

Vous pouvez utiliser l'axe transversal et les trous correspondants au dos du modèle pour joindre deux de ces ensembles et créer une pyramide complète.

Puedes usar un eje en cruz y los orificios coincidentes de la parte posterior del modelo para conectar dos de estos sets con el objetivo de recrear la pirámide completa.



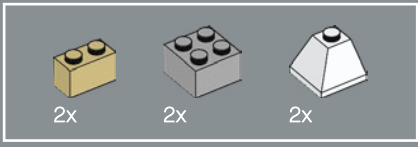

161

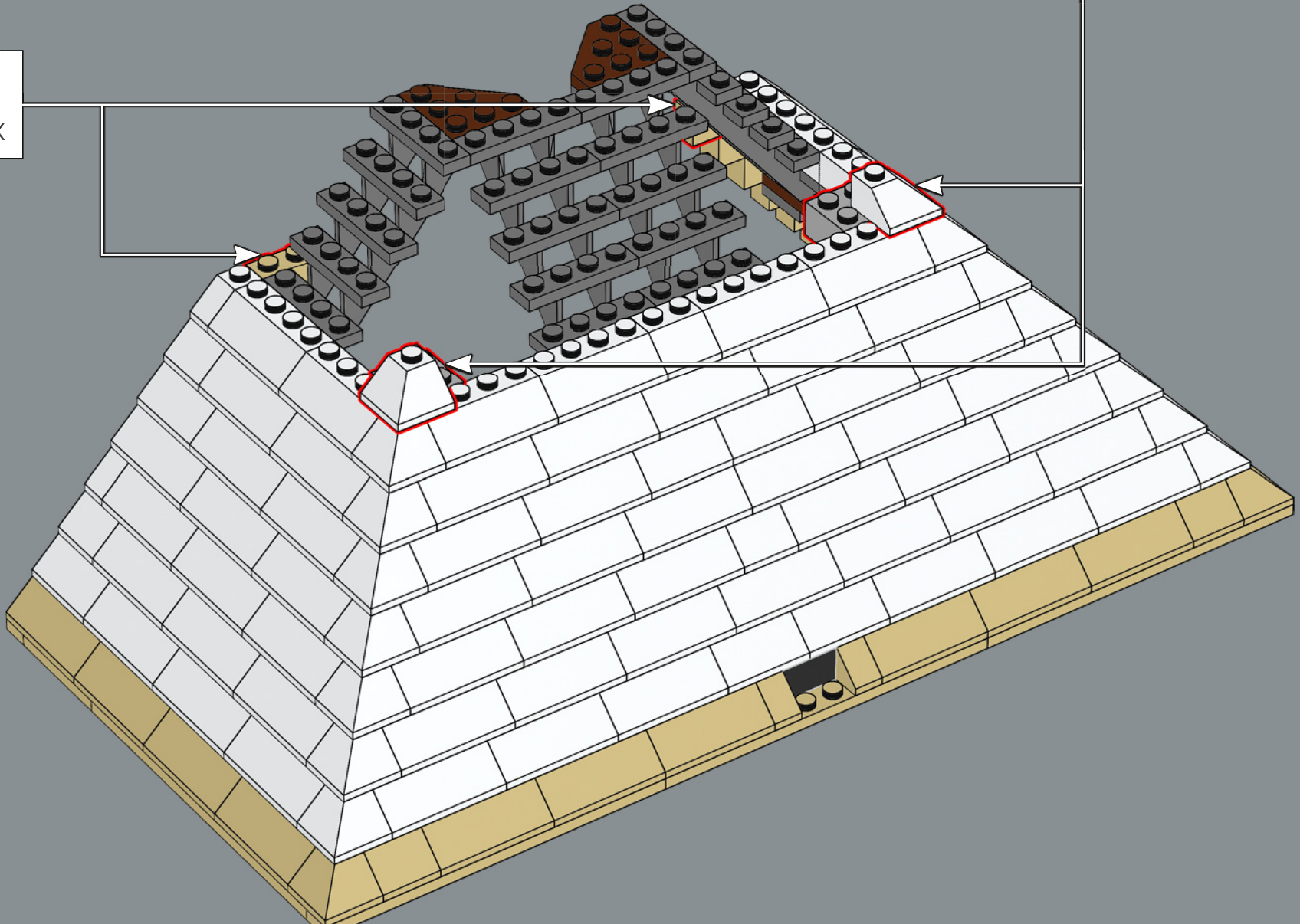
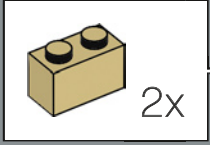
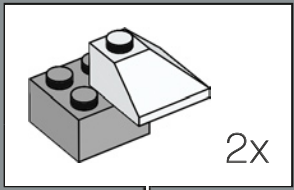

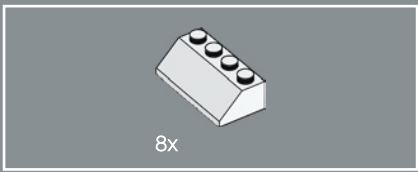

162

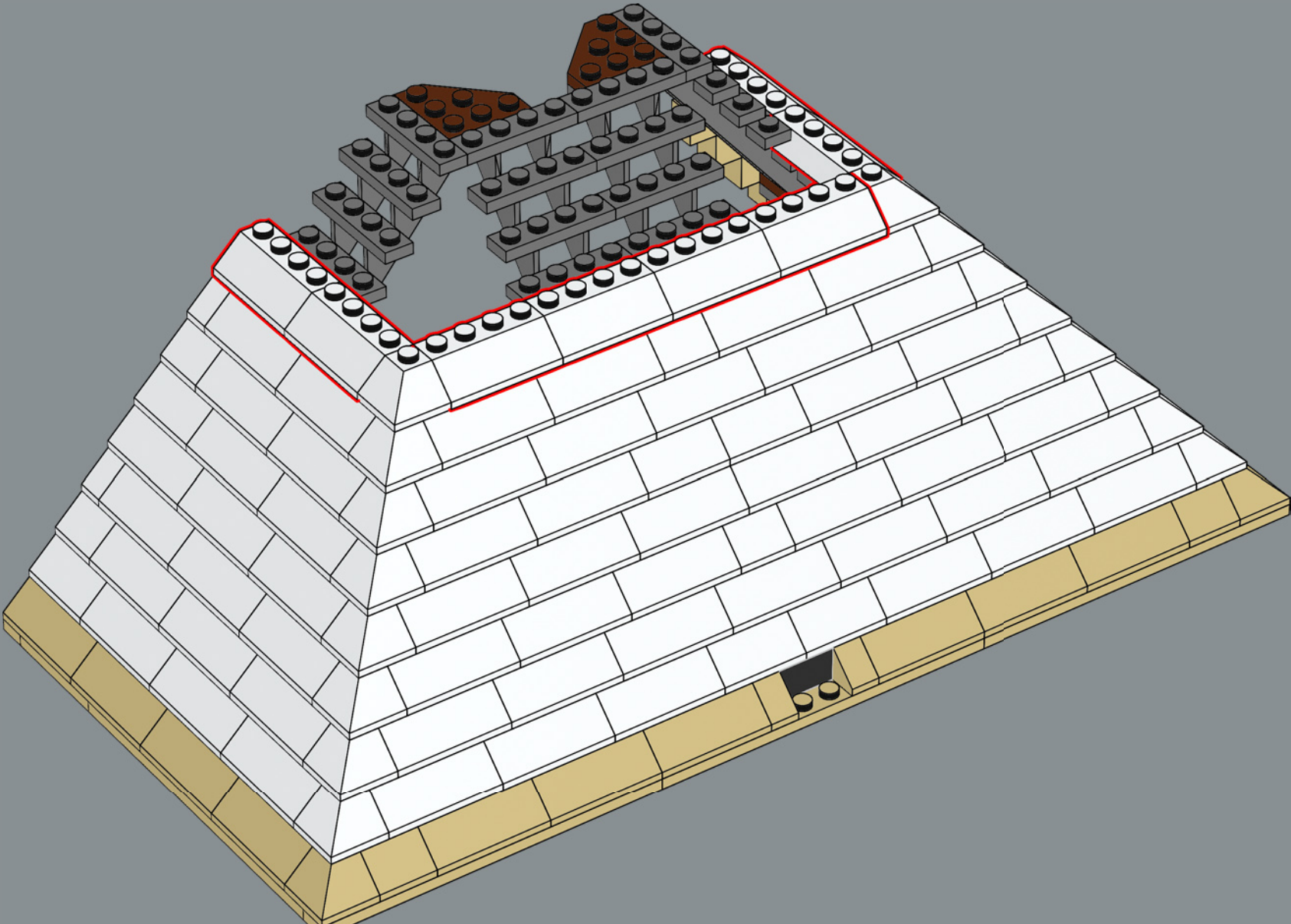

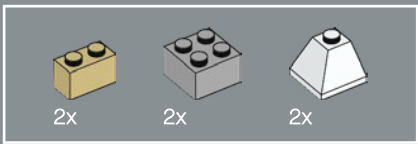

163

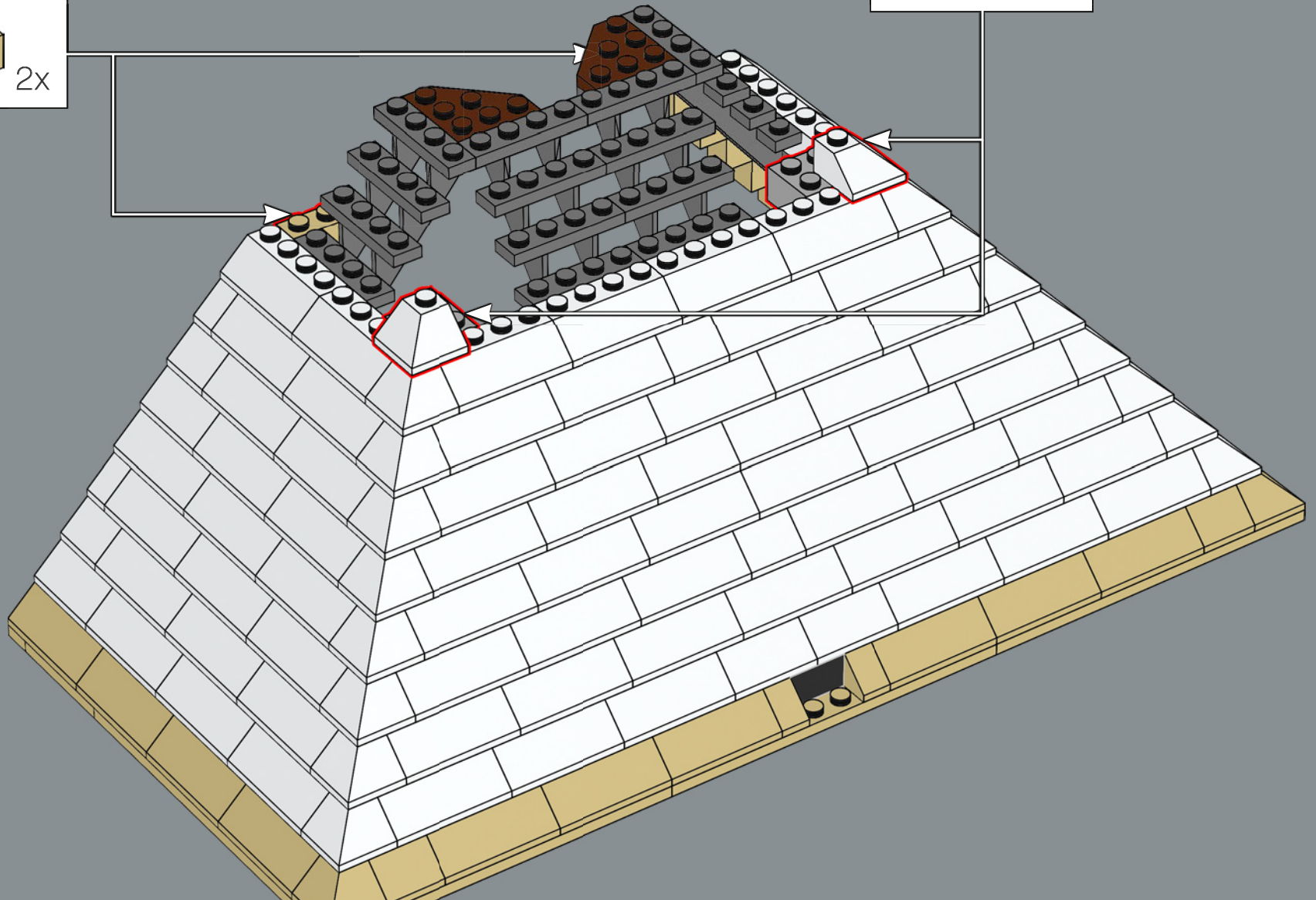
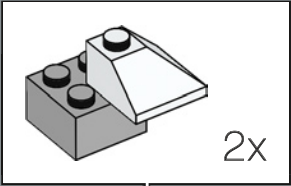
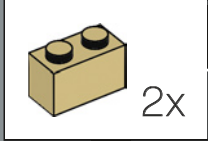

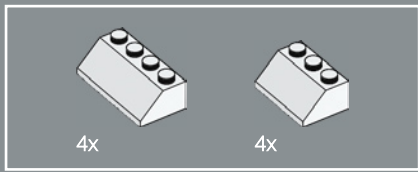

164

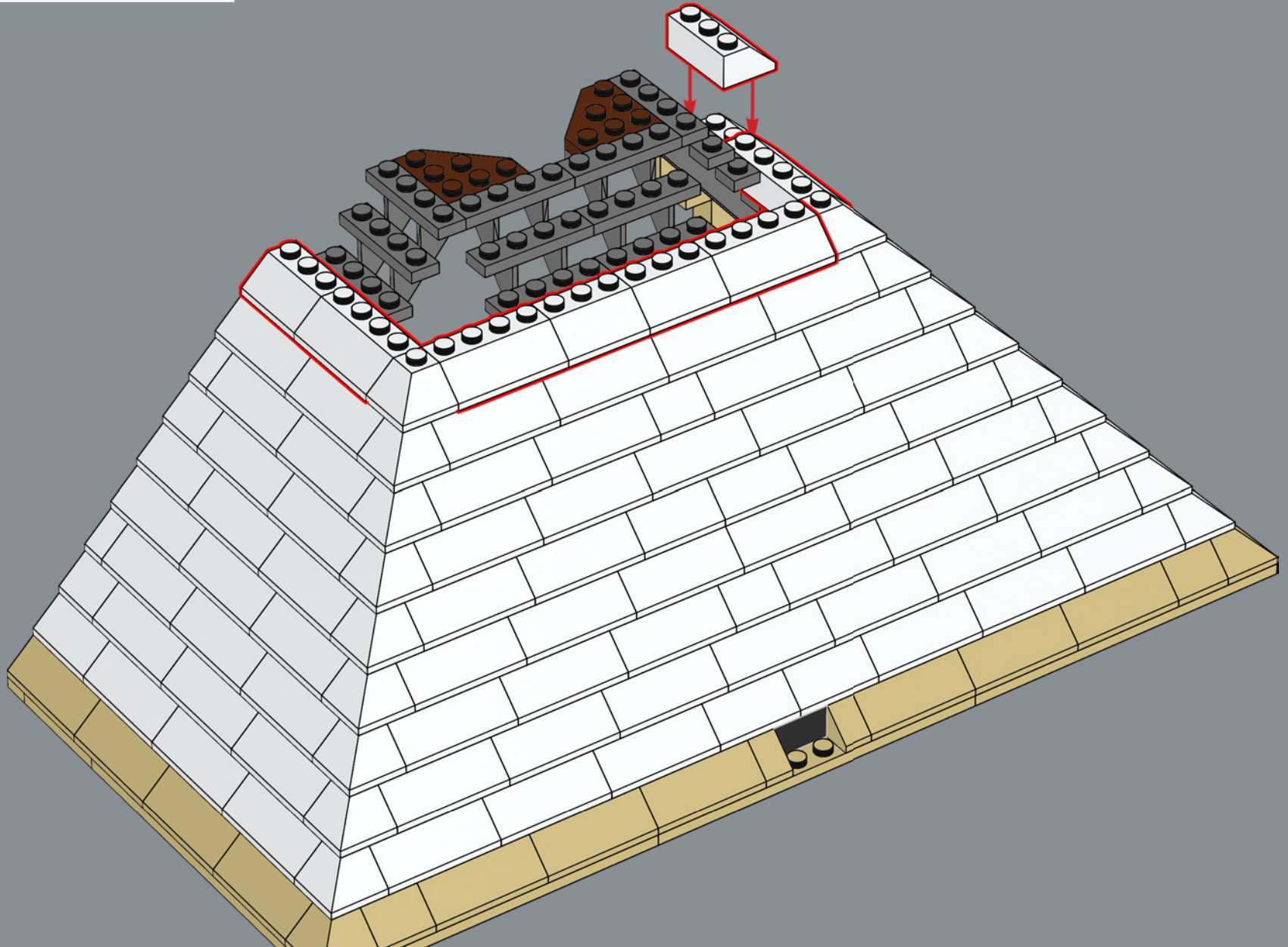

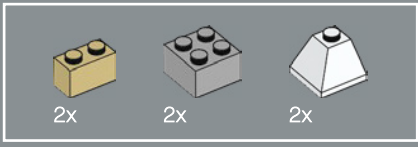

165

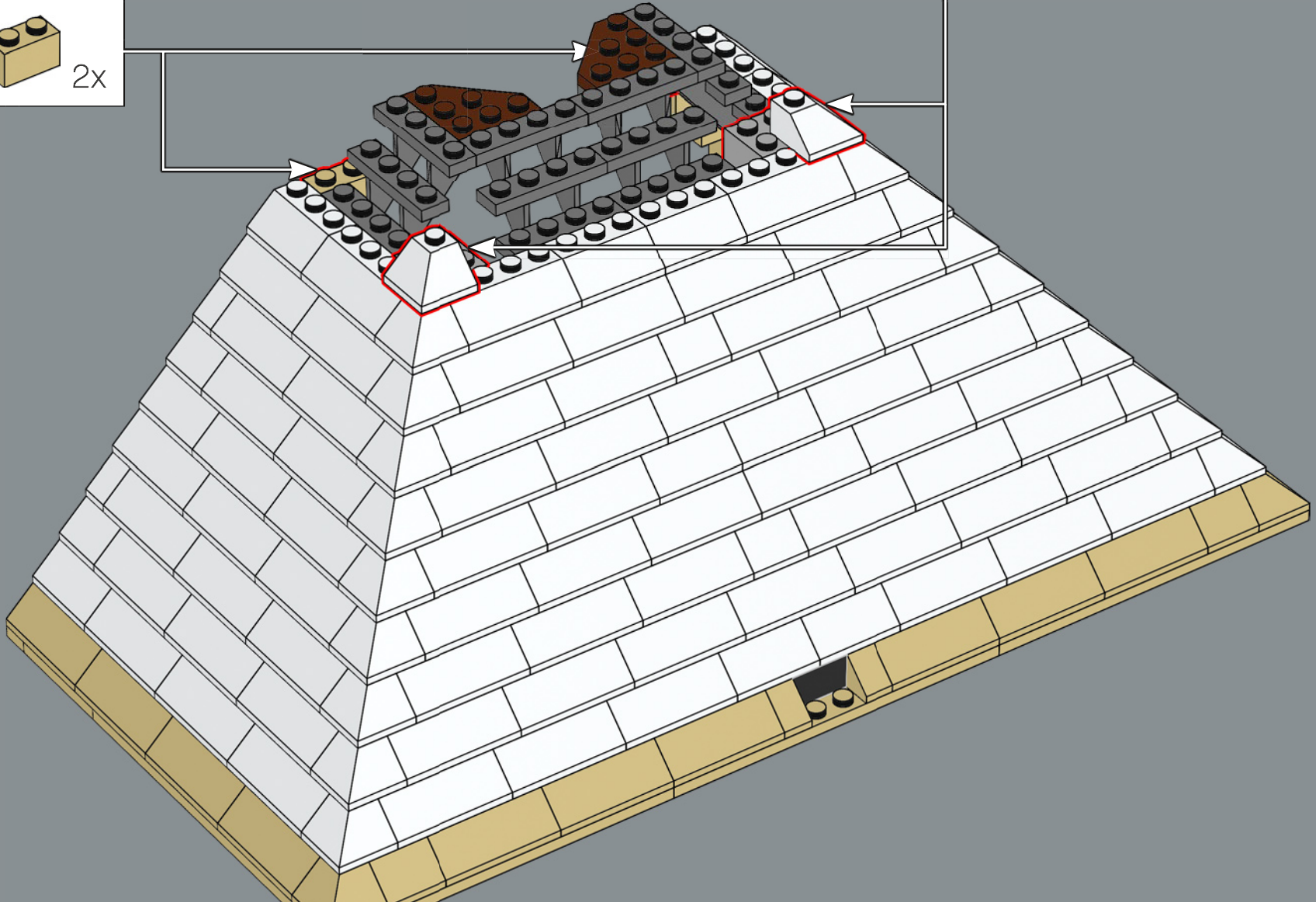
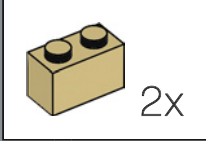
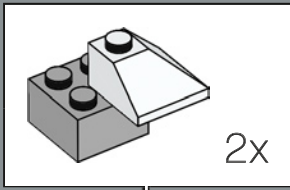

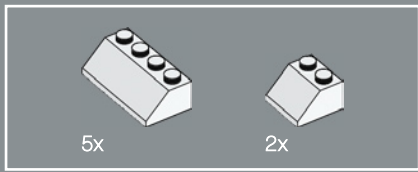

166

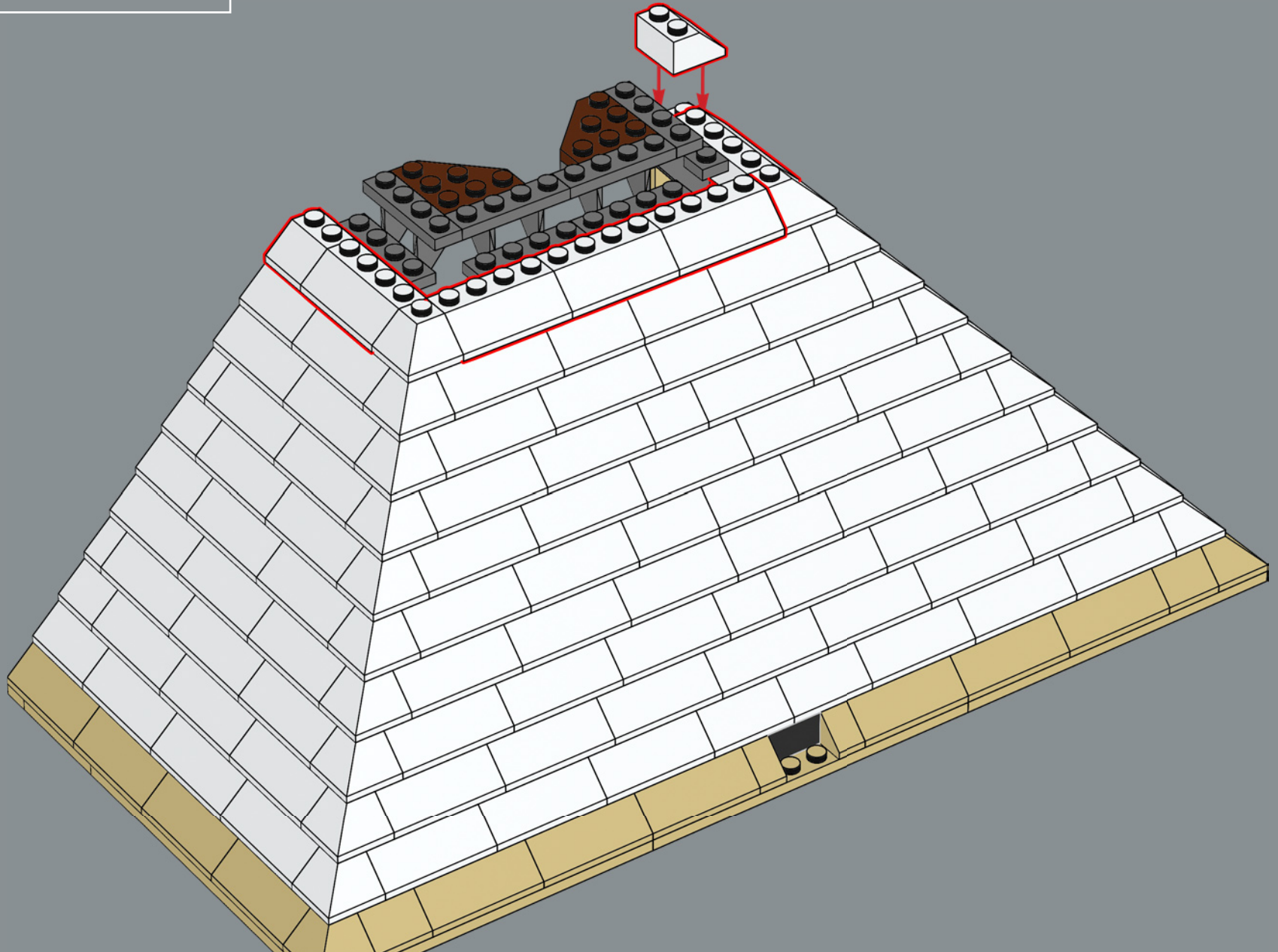



4x

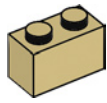

4x

167

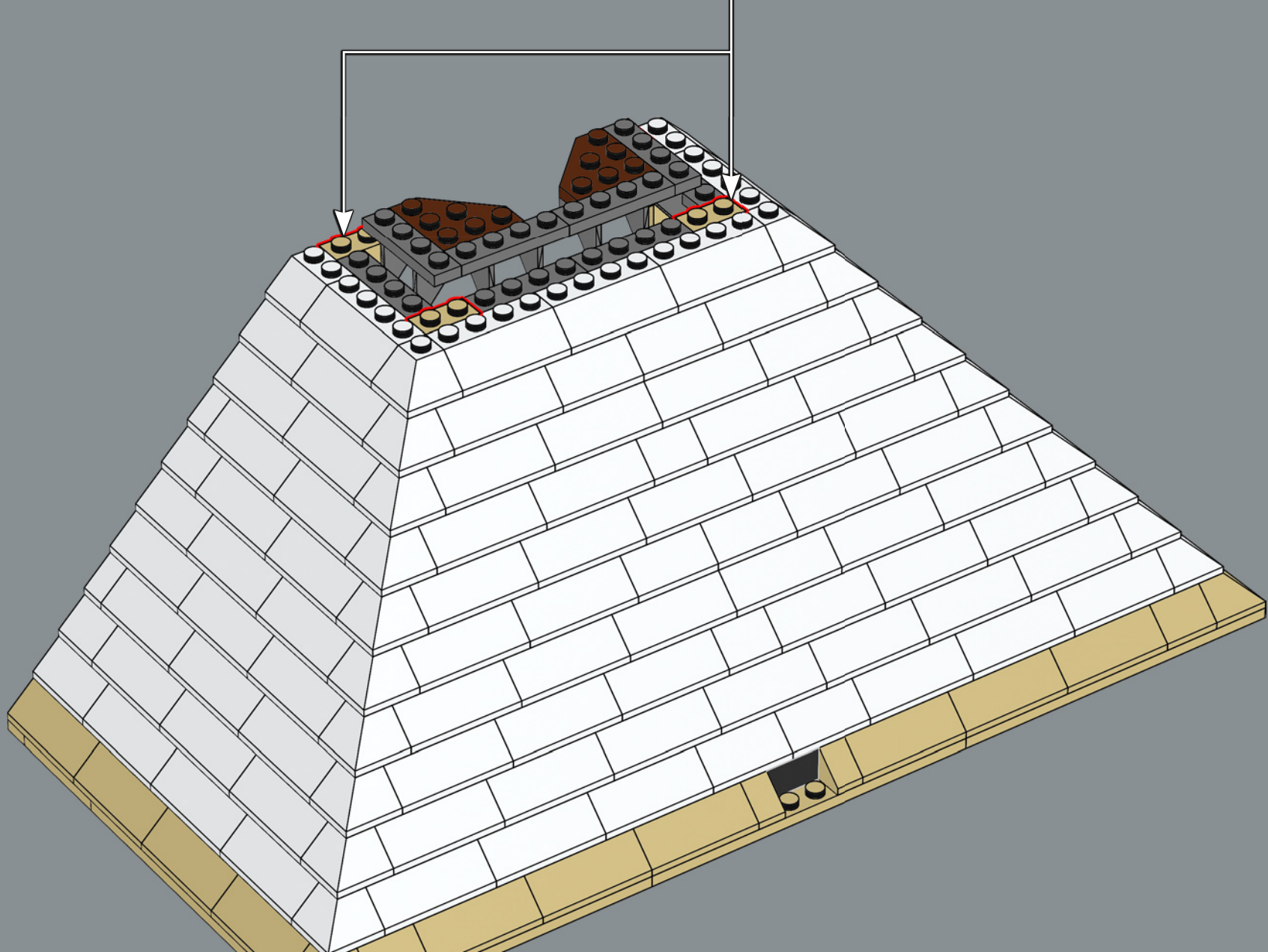

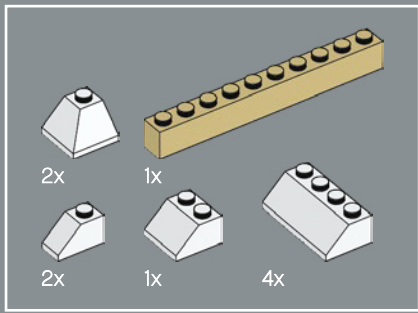

168

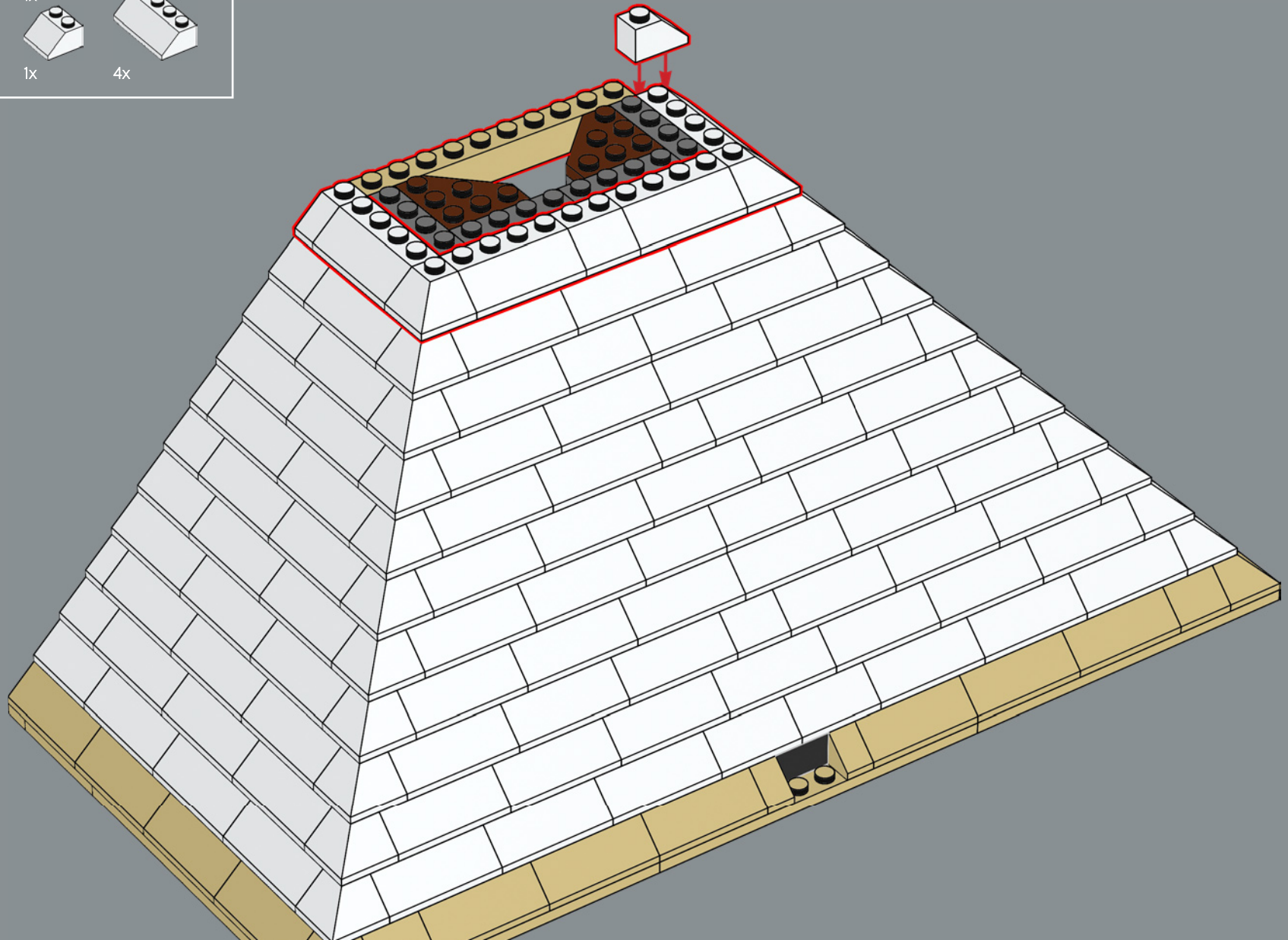

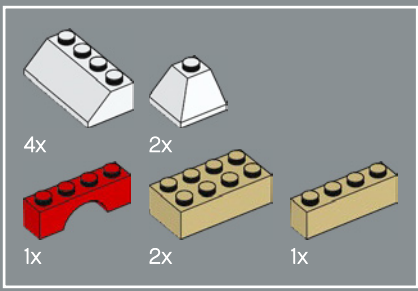

169

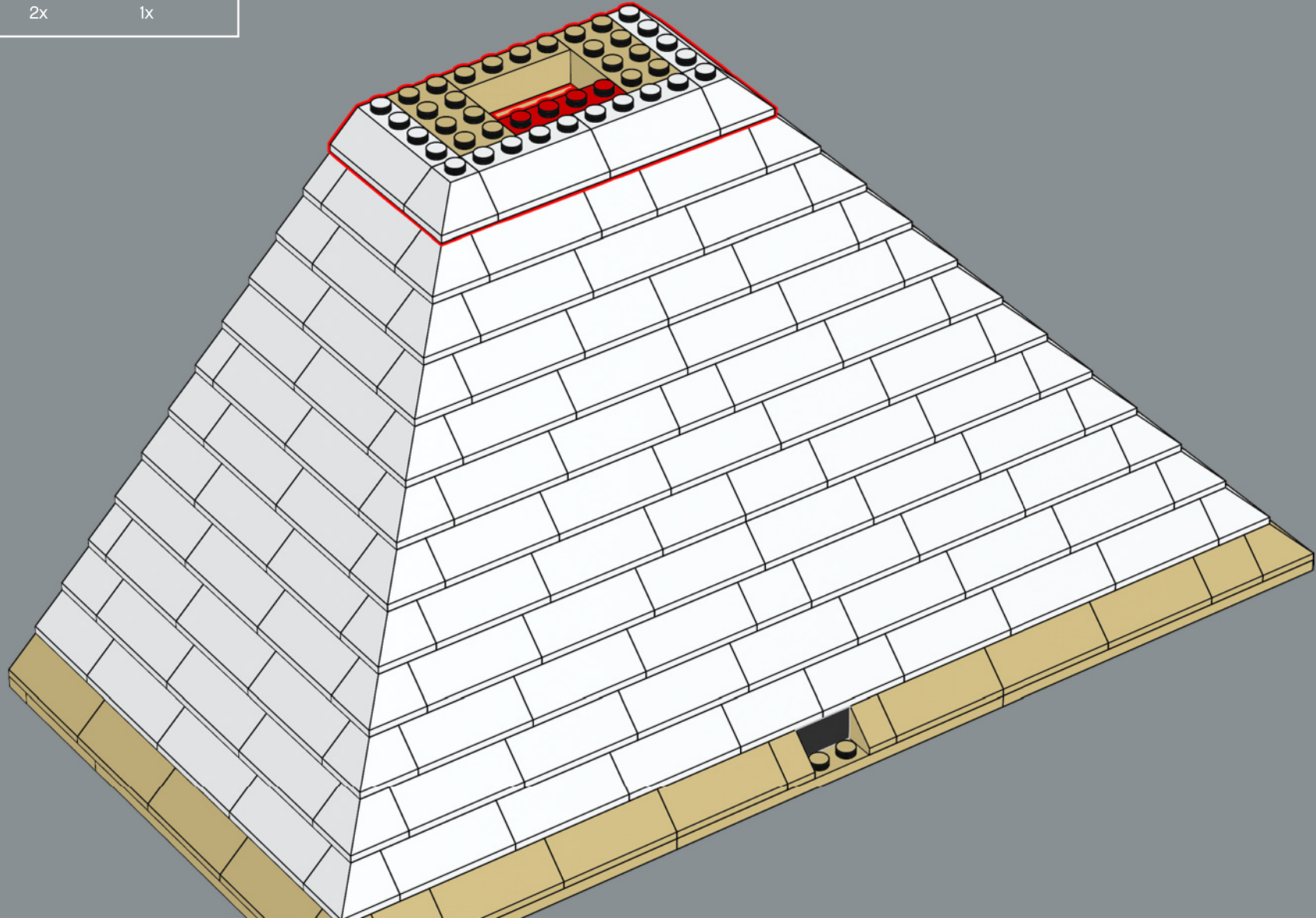

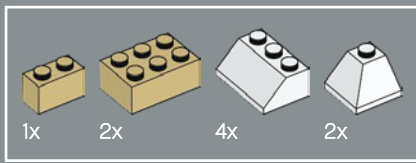

170

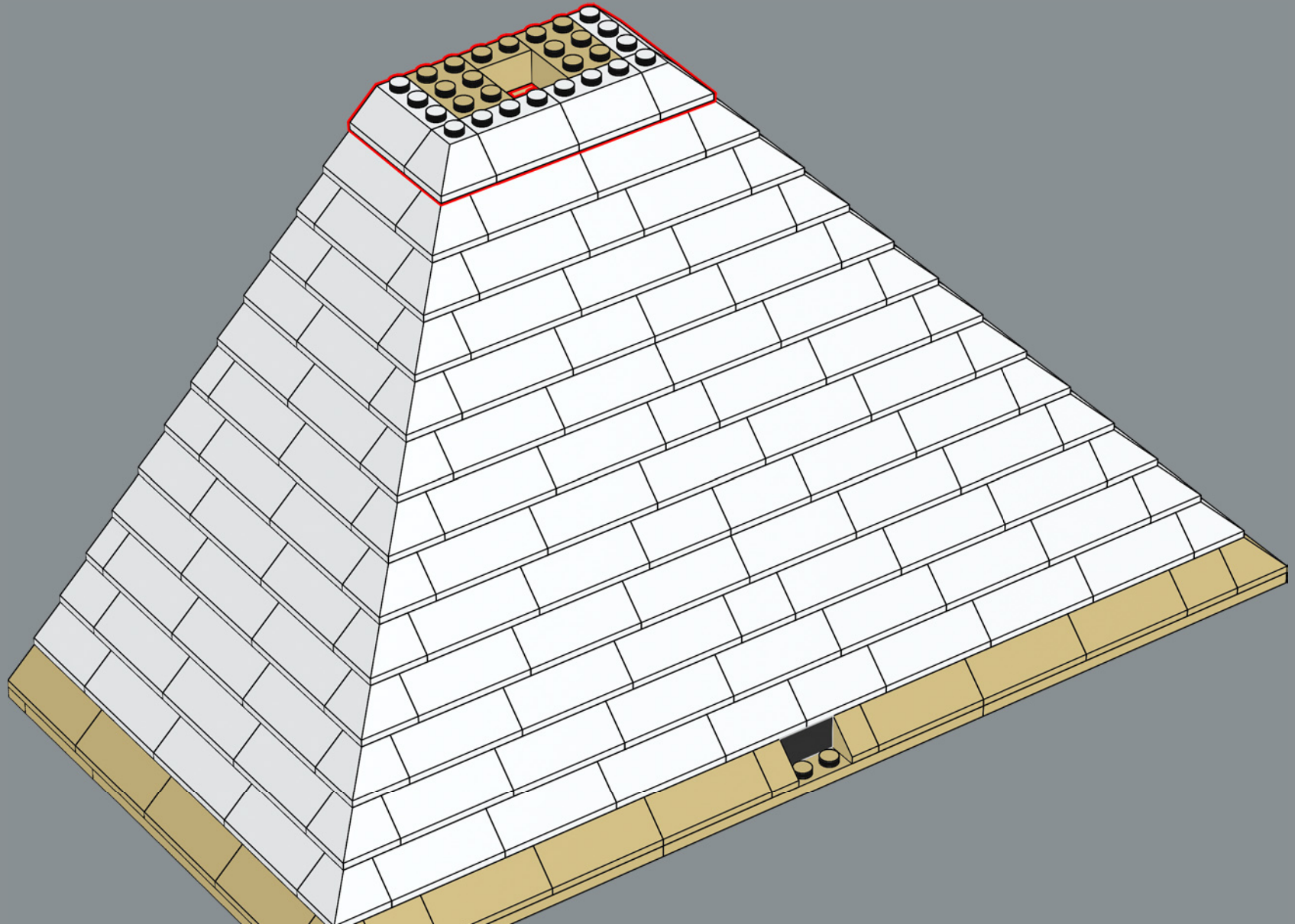

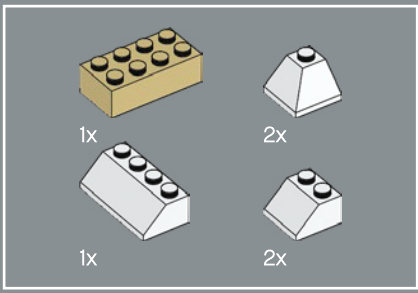

171

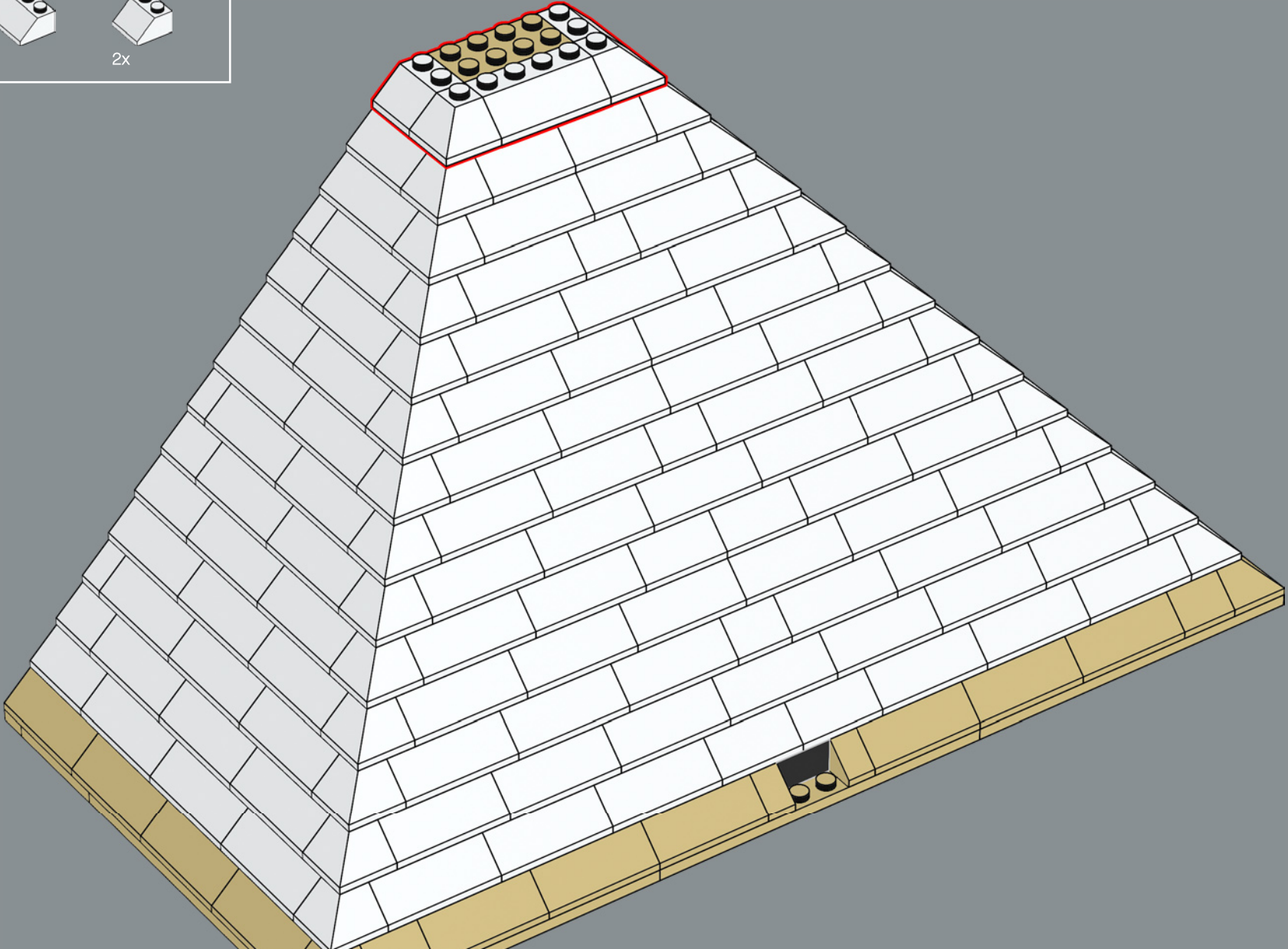

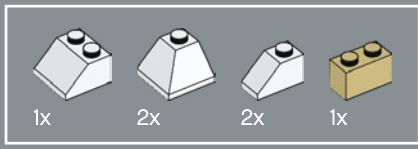

172

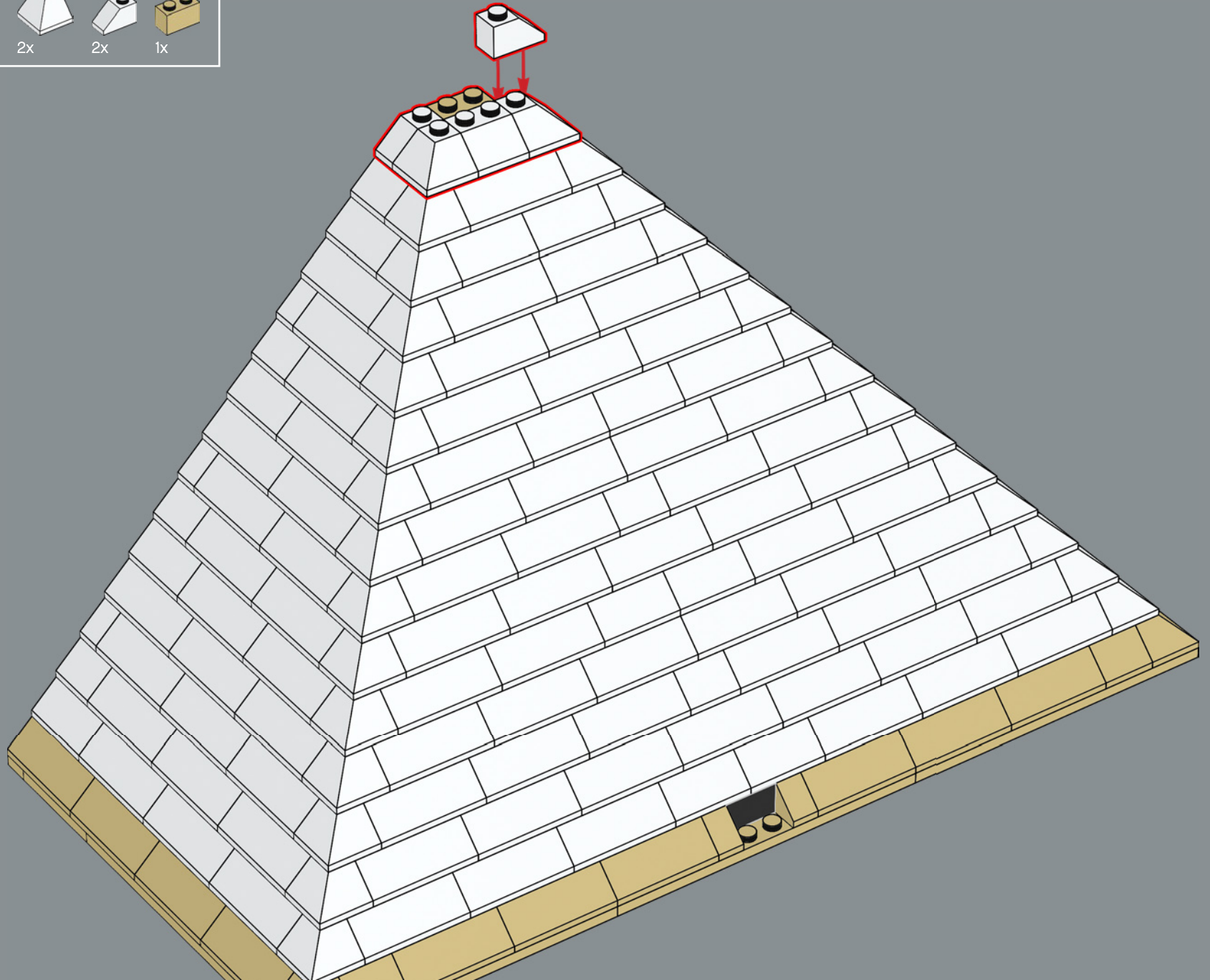

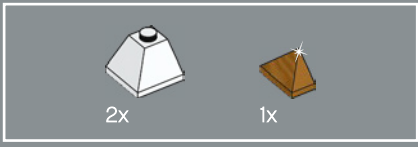

173

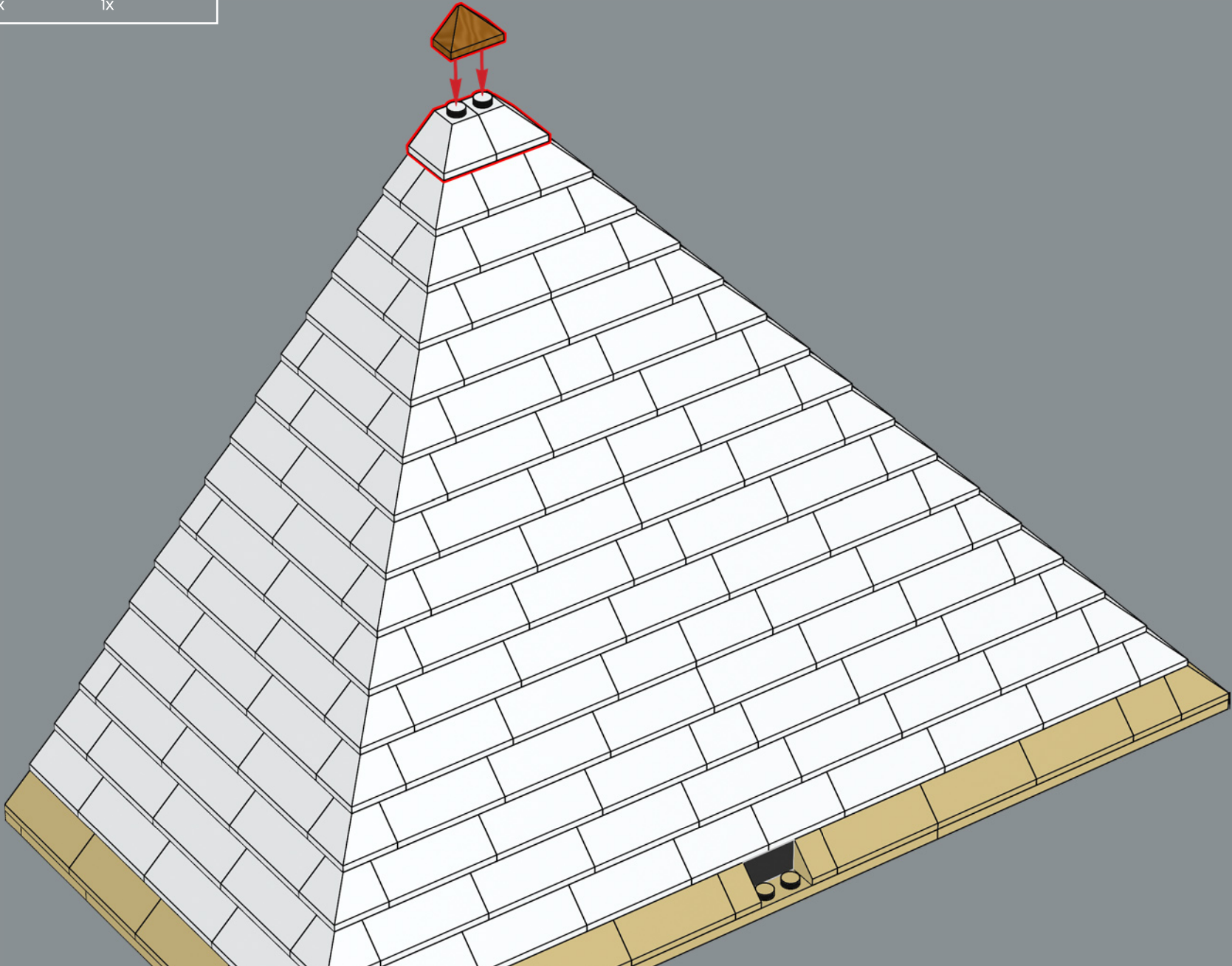

174



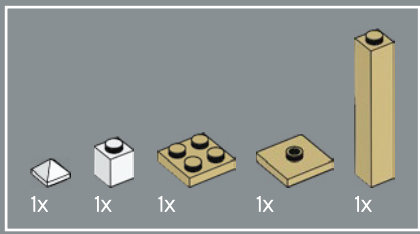

175

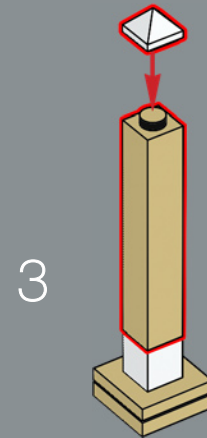
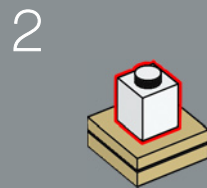
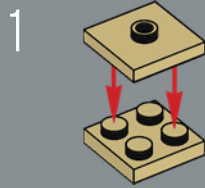



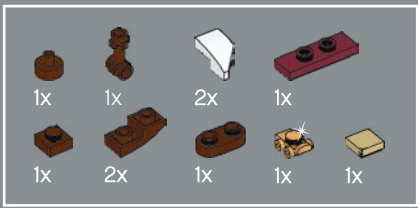

176

The element forming the golden canopy on the rear of the boat is more commonly seen as a roller skate for LEGO® minifigures.

L'élément formant l'auvent doré à l'arrière du bateau est plus communément utilisé comme patin à roulettes pour les figurines LEGO®.

En la mayoría de los sets, el elemento que conforma la cubierta dorada de la parte posterior del bote representa un patin para minifiguras LEGO®.

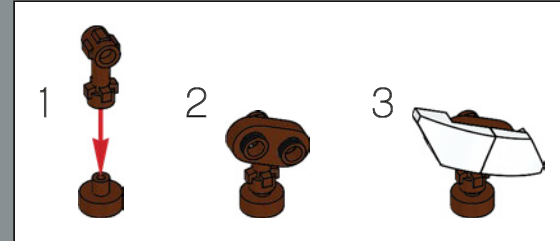
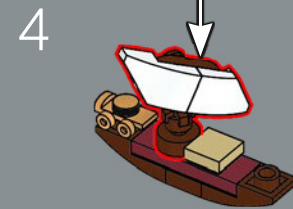
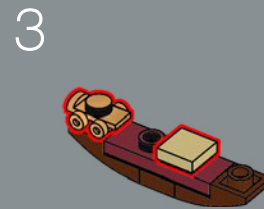
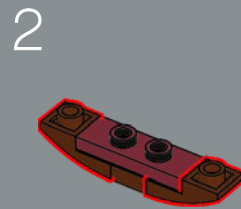
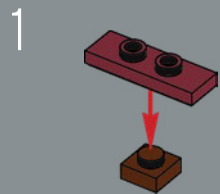



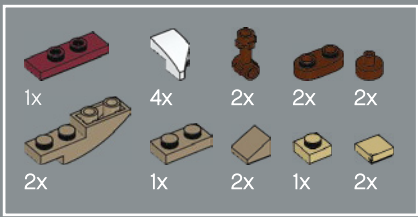

177

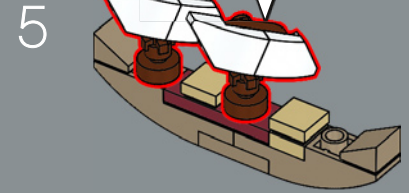
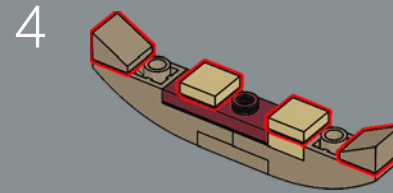
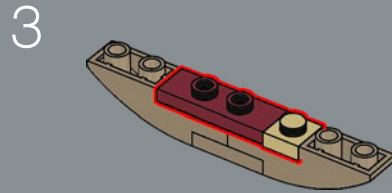
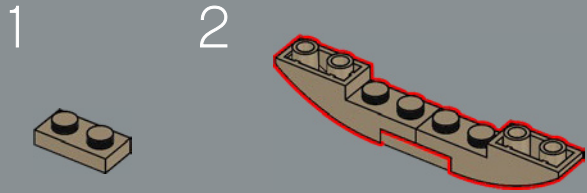
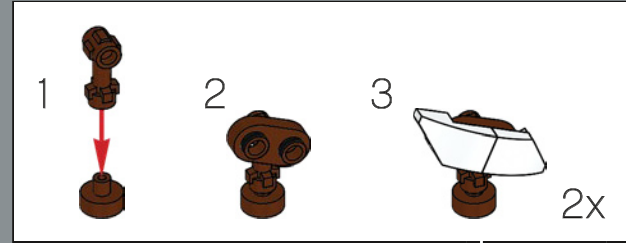

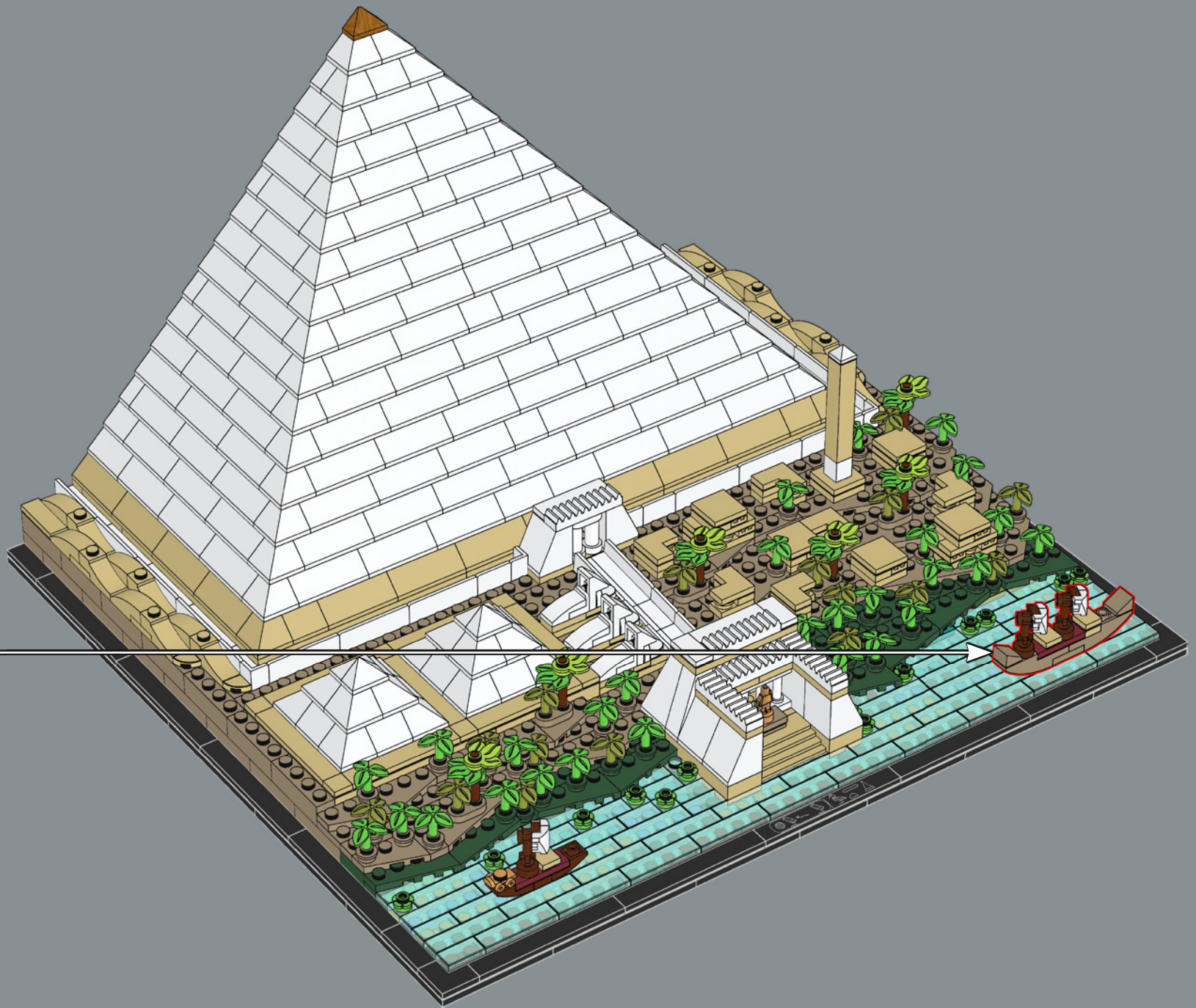



FEEDBACK AND WIN



FEEDBACK AND WIN

Your feedback will help shape the future development of this product series.

Please visit:

FEEDBACK UND GEWINNEN

Dein Feedback trägt zur Weiterentwicklung dieser Produktreihe bei.

Geh auf:

COMMENTEZ ET GAGNEZ

Vos commentaires nous aideront à concevoir les futurs produits de cette gamme.

Rendez-vous sur :

COMENTA Y GANA

Tu opinión nos ayudará a dar forma al desarrollo de esta serie de productos en el futuro.

Visita:

反馈有奖

您的反馈将有助于我们在今后改进本系列产品。

请访问：

[LEGO.com/productfeedback](https://www.lego.com/productfeedback)

By completing, you will automatically enter a drawing to win a LEGO® set.

Terms & Conditions apply.

Durch Ausfüllen nimmst du automatisch an der Verlosung eines LEGO® Preises teil.

Es gelten die Teilnahmebedingungen.

En envoyant vos commentaires, vous serez automatiquement inscrit(e) à un tirage au sort qui vous permettra de remporter un prix LEGO®.

Offre soumise à conditions.

Al contestar, participarás automáticamente en el sorteo y podrás ganar un set LEGO®.

Sujeto a Términos y Condiciones.

完成我们的反馈调查，即可自动进入抽奖环节，赢取乐高®套装。

适用《条款和条件》。

LEGO and the LEGO logo are trademarks of the/son/des marques de commerce du/son marcas registradas de LEGO Group. ©2022 The LEGO Group.

Adam Reed Tucker is the co-developer of the LEGO® Architecture product line.
Adam Reed Tucker est le codéveloppeur de la gamme de produits LEGO® Architecture.
Adam Reed Tucker es el codesarrollador de la línea de productos LEGO® Architecture.

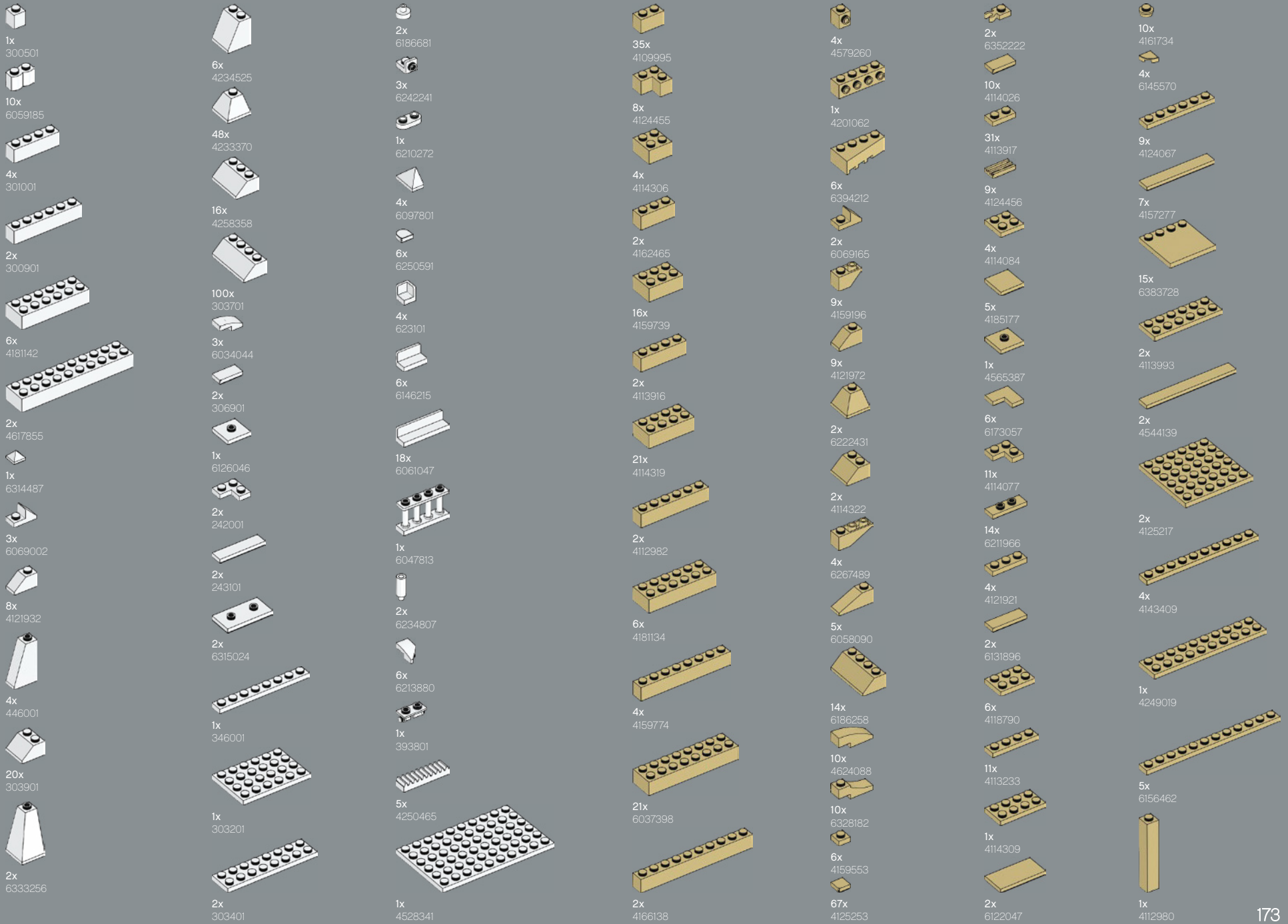



2x
6177890



4x
4208072



2x
6099893



4x
6213676

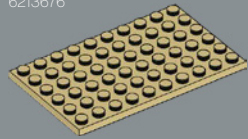

4x
4624185

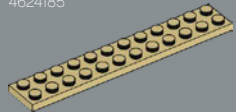

6x
6093864

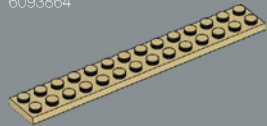

1x
6036487

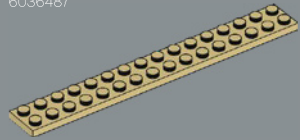

2x
6030980



16x
6186030



16x
6285465



1x
403223



1x
6102759

174



1x
362221

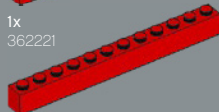

2x
611221



3x
4651524



1x
365921



1x
302321



4x
306921



2x
306821



2x
242021



5x
371021



3x
302021



2x
366621



1x
4142865



11x
306224



4x
302324



2x
302224



7x
300426



6x
362226



7x
301026



2x
302426



2x
6133722



4x
4558170



1x
302126



2x
371026



2x
366626



2x
4243819



1x
6323899



12x
416226



1x
6323898



1x
6323898



1x
6323898



2x
346026

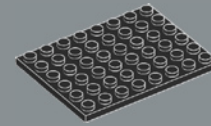

16x
303626

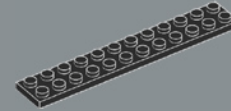

1x
244526

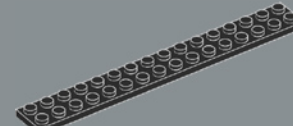

6x
428226



1x
4107761



1x
6096956



2x
4541191



2x
6278152



1x
393726



2x
4124096



4x
302328



2x
302028



13x
6206150



29x
6235080



6x
6182261



3x
6092602



2x
6290986



6x
6252043



9x
6251295



6x
6240222



48x
6252049



1x
6240515



6x
6259794



3x
4518611



1x
6212989



1x
6167483



6x
6286831

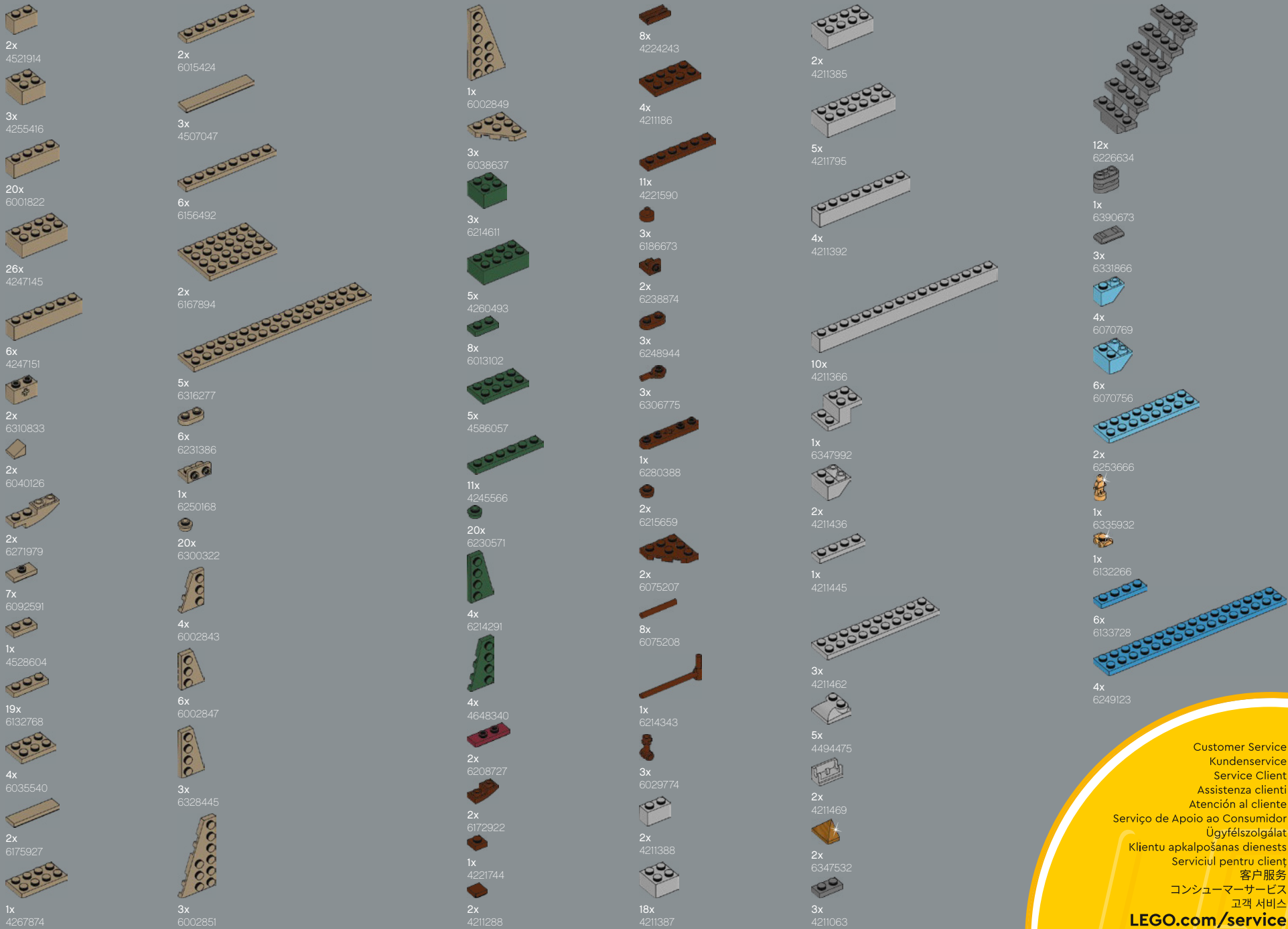

Customer Service
 Kundenservice
 Service Client
 Assistenza clienti
 Atención al cliente
 Serviço de Apoio ao Consumidor
 Ügyfélszolgálat
 Klientu apkalpošanas dienests
 Serviciul pentru clienți
 客户服务
 콘슈어머서비스
 고객 서비스
LEGO.com/service

