

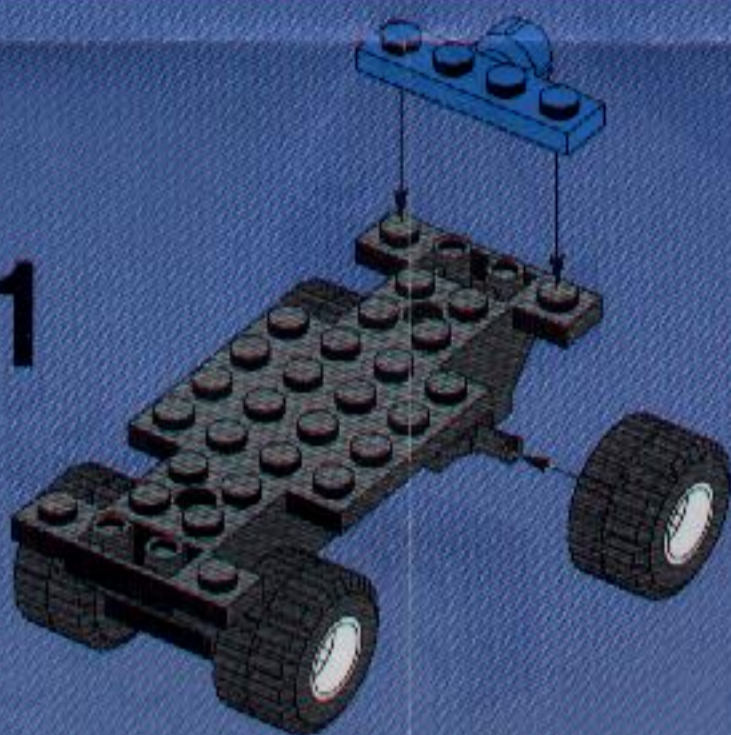

4117707

37

1



2

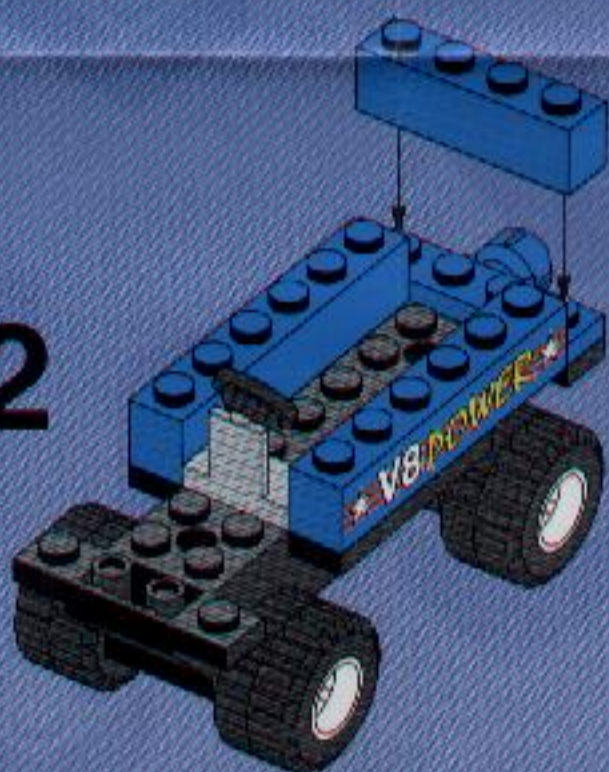

3

