



TECHNIC

30433



6408259

VOLVO

WIN

GO TO WWW.LEGO.COM/RB2022 TO FILL OUT A SHORT SURVEY ON THIS PRODUCT FOR A CHANCE TO WIN A COOL LEGO SET.



Terms & Conditions apply

LEGO.com/RB2022

GAGNEZ

Rendez-vous au www.LEGO.com/RB2022 pour remplir un court questionnaire sur ce produit et courir la chance de gagner un fantastique ensemble LEGO.
Voir Conditions Générales

GANAN

Visita www.LEGO.com/RB2022 y responde una breve encuesta sobre este producto. ¡Puedes ganar un fantástico set LEGO!
Términos y Condiciones aplicables

1

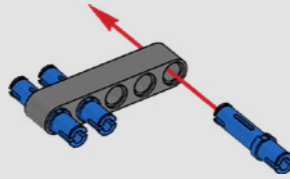

2

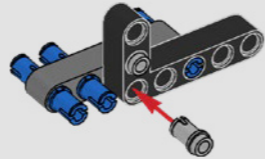

3

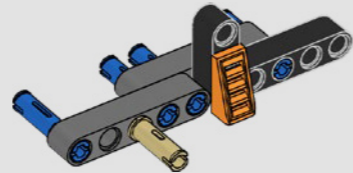

4

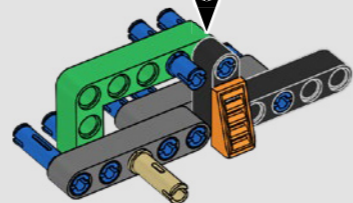
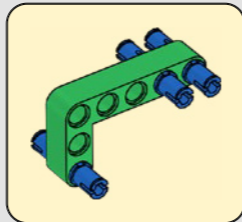

1

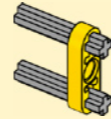

2

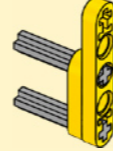

5

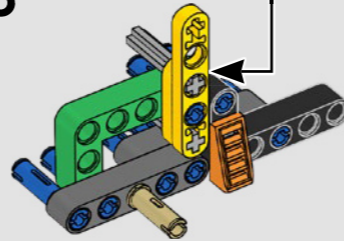

6

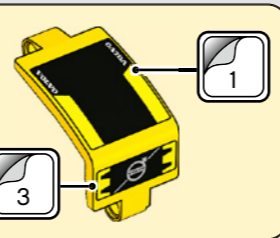

6

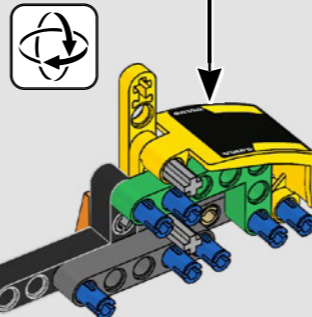

7

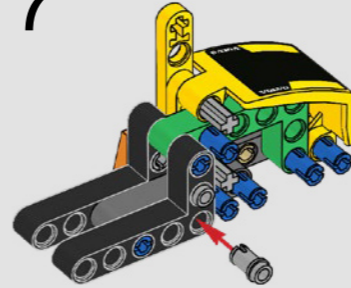

8

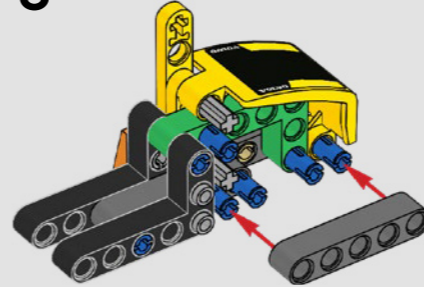

9

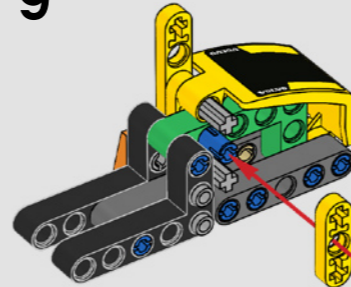

10

1

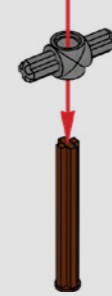

2

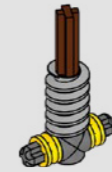

1

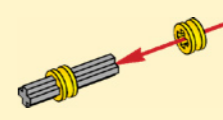

2

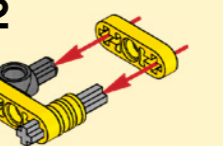

3

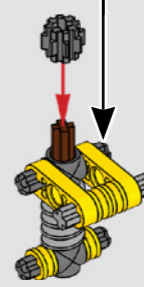

4

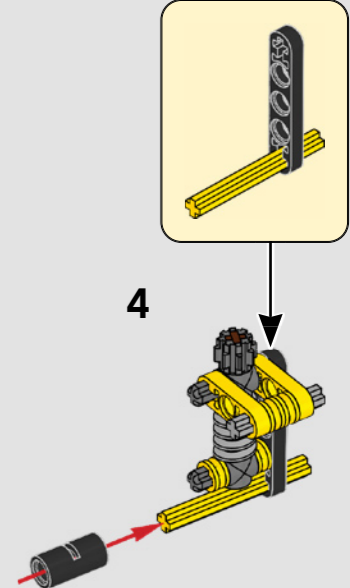

5

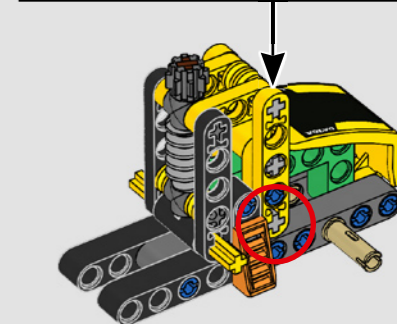
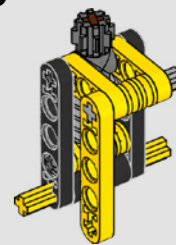

11

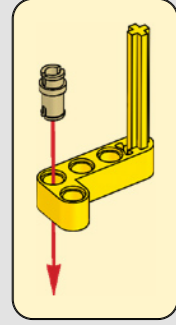
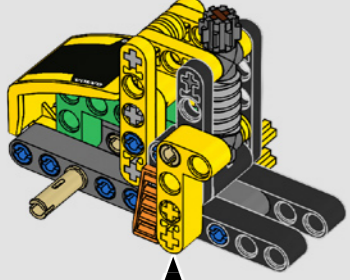

12

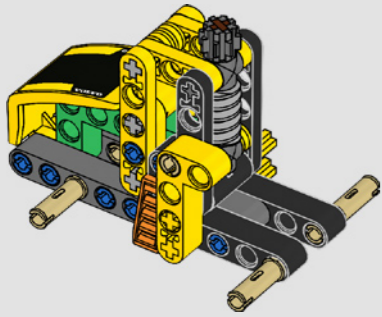

13

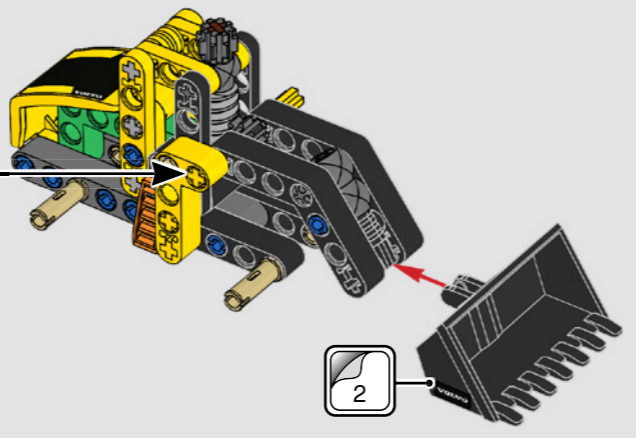
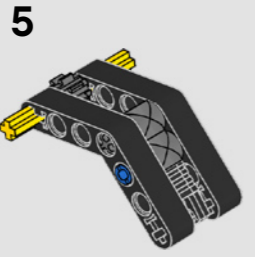
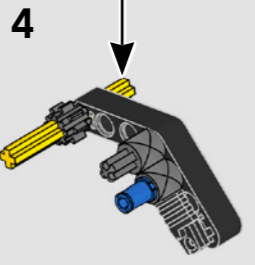
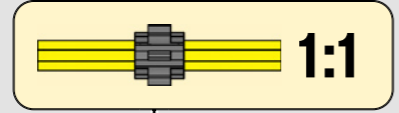
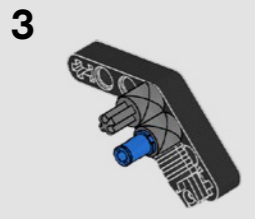
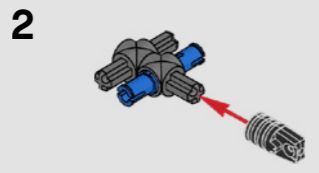
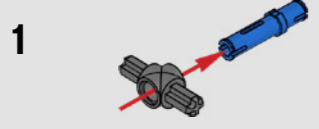

14

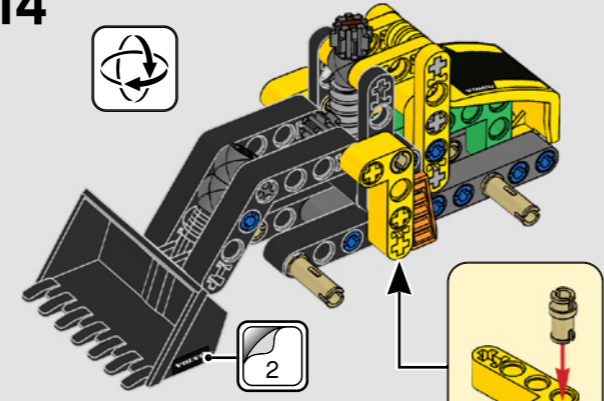

15

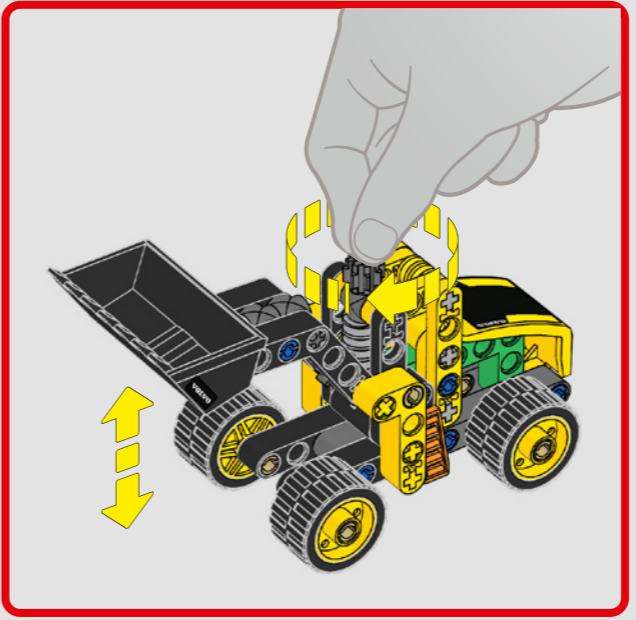
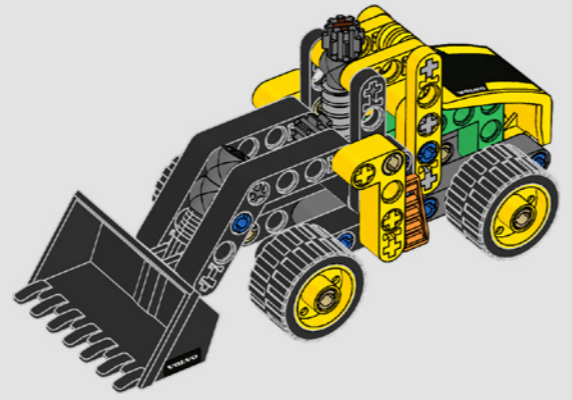

[LEGO.com/service](https://www.lego.com/service)

LEGO and the LEGO logo are trademarks of the/son des marques de commerce du/son marcas registradas de LEGO Group. ©2022 The LEGO Group.

The Volvo trademarks (word and device) are registered trademarks of Volvo Trademark Holding AB and are used pursuant to a license. Other trademarks and trade names are those of their respective owners.

