



CREATOR™

3 IN 1

31140





Get excited about our new packaging!

We're switching from plastic to paper-based packaging. That's why you might find a mix of paper and plastic in our boxes!

Nos nouveaux emballages vous emballeront !

Nous passons des emballages en plastique aux emballages à base de papier. C'est pourquoi vous pourriez trouver un mélange de papier et de plastique dans nos boîtes !

¡Te presentamos nuestros nuevos empaques!

Estamos sustituyendo las bolsas de plástico por bolsas con base de papel. ¡Por eso, puedes encontrar una mezcla de papel y de plástico en nuestras cajas!

[LEGO.com/sustainable-packaging](https://www.lego.com/sustainable-packaging)

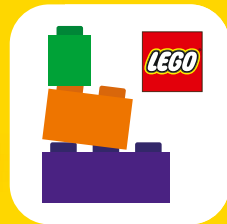

BUILDER



Apple and the Apple logo are trademarks of Apple Inc., registered in the U.S. and other countries and regions. App Store is a service mark of Apple Inc. Google Play and the Google Play logo are trademarks of Google LLC. Tencent and the Tencent logo are trademarks of Tencent Inc.

Q [LEGO.com/devicecheck](https://www.lego.com/devicecheck)

EN Ask parents' permission before going online | **DE** Eltern um Erlaubnis bitten, bevor du online gehst | **FR** Demande l'autorisation d'un parent avant d'aller en ligne | **IT** Chiedi il permesso ai tuoi genitori prima di andare online | **ES** Pídeles permiso a tus papás antes de conectarte a Internet | **PT** Peça autorização aos pais antes de acederes online | **JA** オンラインになる前に ほご者の方のきょかをもらおう | **ZH** 上网前应先征得父母的同意 | **KO** 온라인 접속 전에 보호자 동의가 필요합니다 | **RU** Спроси разрешения у родителей, прежде чем заходить в интернет | **PL** Poproś rodziców o zgodę, zanim wejdiesz do Internetu | **CS** Než půjdeš na internet, požádej rodiče o svolení | **SK** Skôr než pôjdeš na internet, vypýtaj si povolenie od rodičov | **HU** Kérj szülői engedélyt, mielőtt online csatlakoznál! | **RO** Cere permisiunea părinților înainte de a te conecta online | **BG** Поискайте разрешението от родител, преди да влезете онлайн | **LV** Pirms došanās tiešsaistē palūdz atļauju vecākiem | **ET** Enne Interneti kasutamist küsi vanematelt luba | **LT** Prieš prisijungdami prie interneto, atsklauskite tėvų



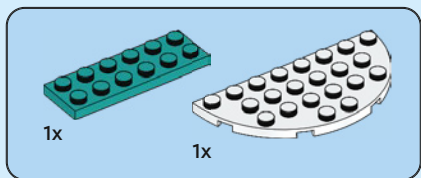

1

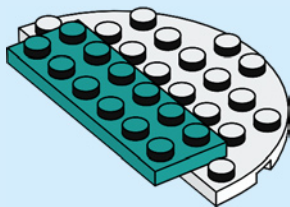

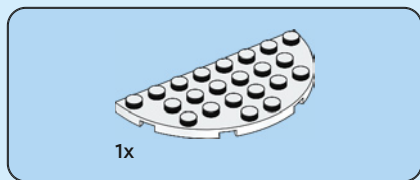

2

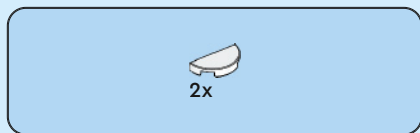
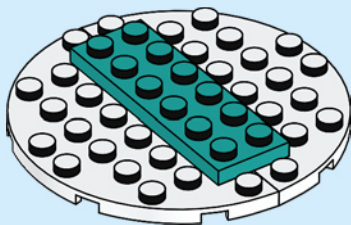

3

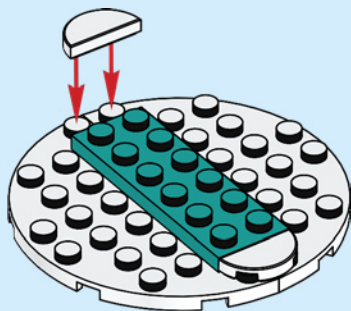



2x

4

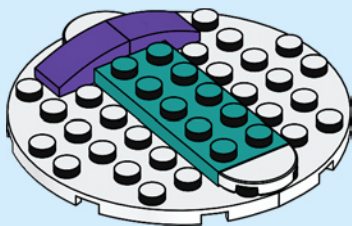

2x



2x

5

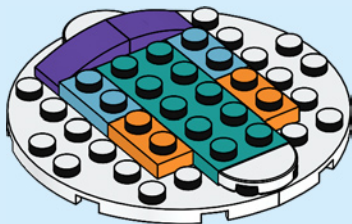



1x



1x

6

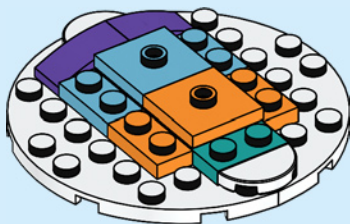

2x

7

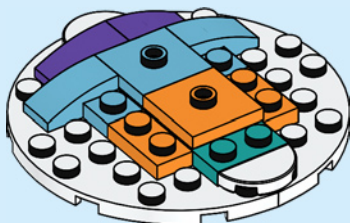



8

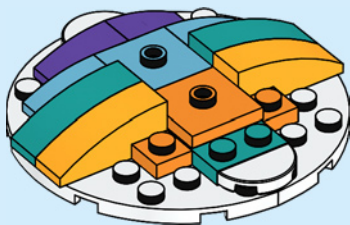

9

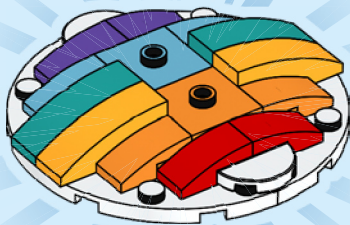

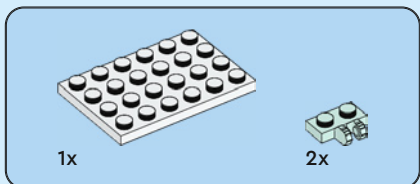
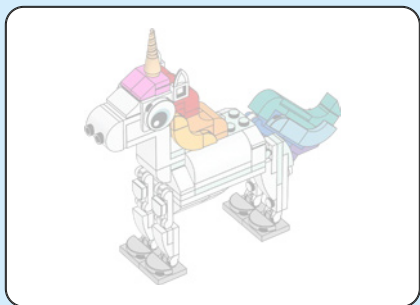

10

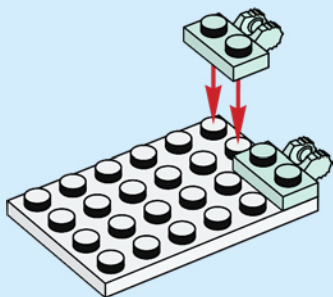

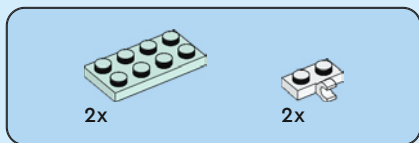

11

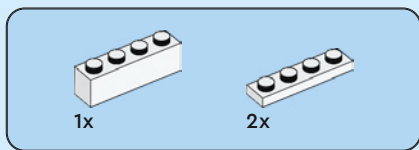
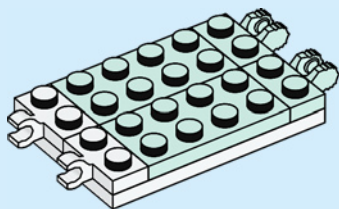

12

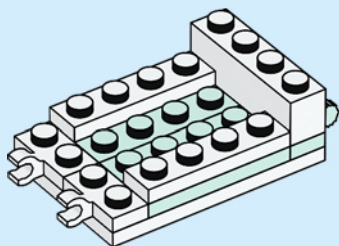



2x

13

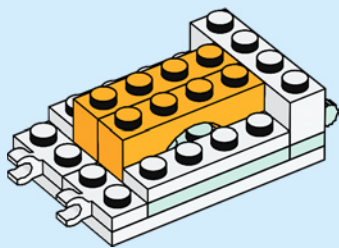



2x

14

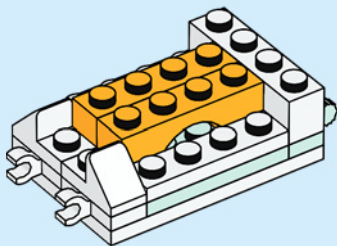

2x



1x

15

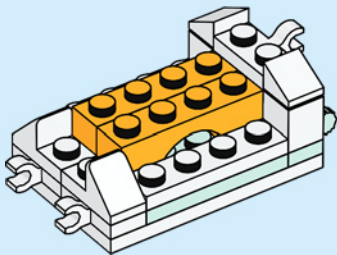



2x

16

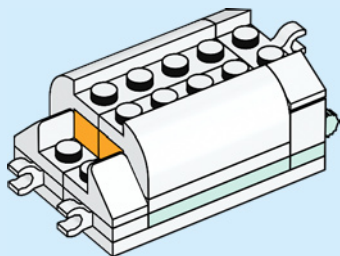



2x



1x

17

1

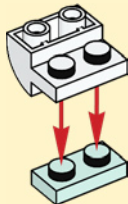

2

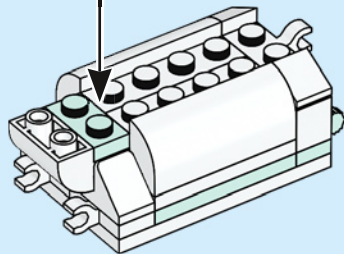
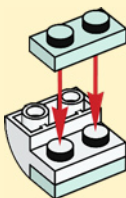



1x

18

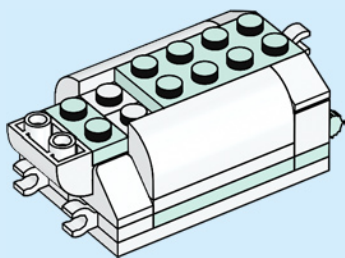

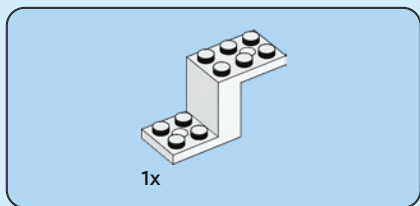

19

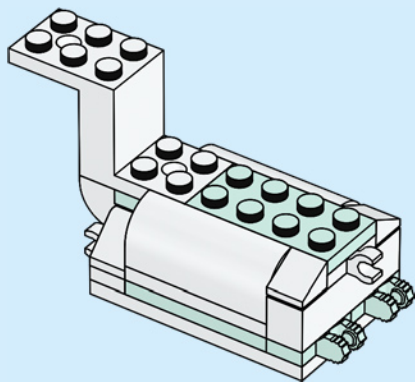

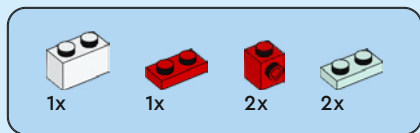

20

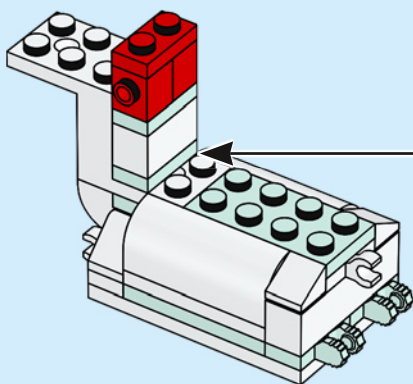
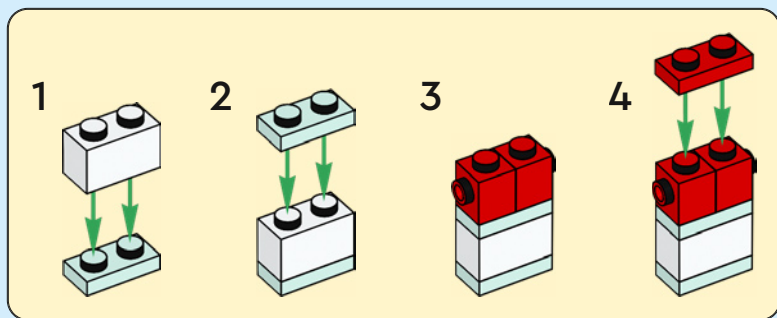



2x



2x

21

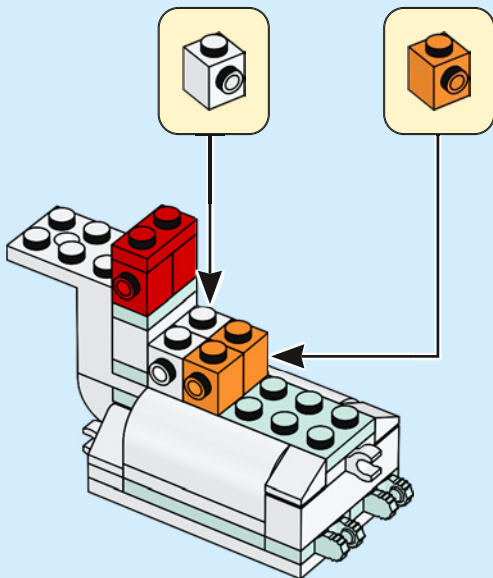



1x



2x

22

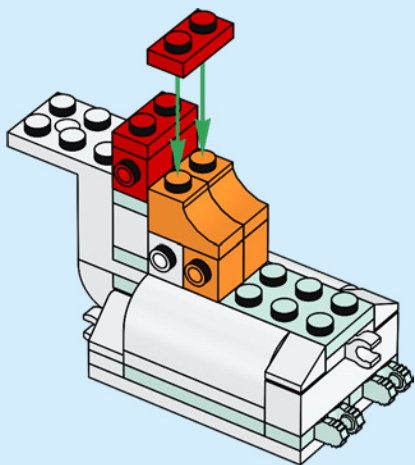



1x



1x

23

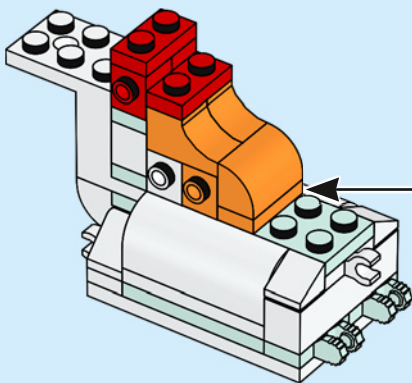
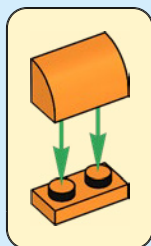



2x

24

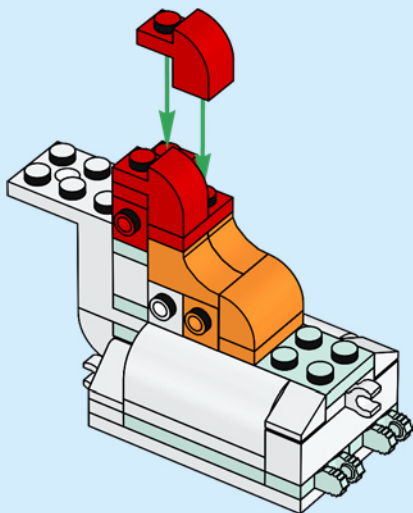

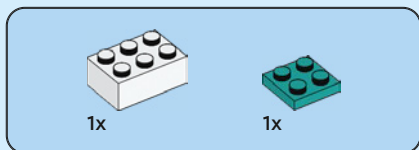

25

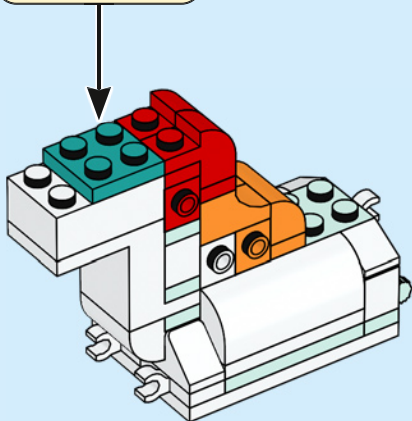
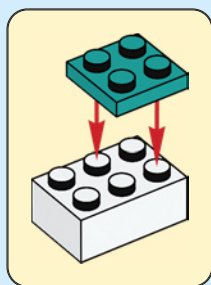



1x



1x



2x

26

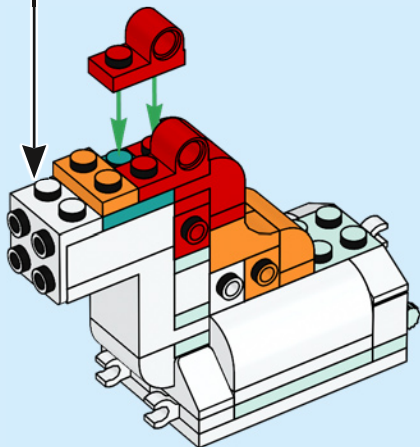
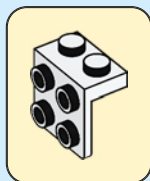



2x

27

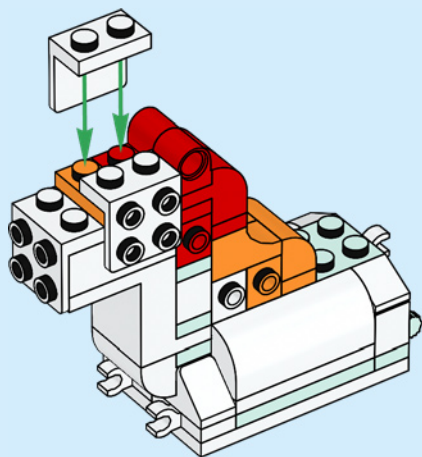



1x



1x

28

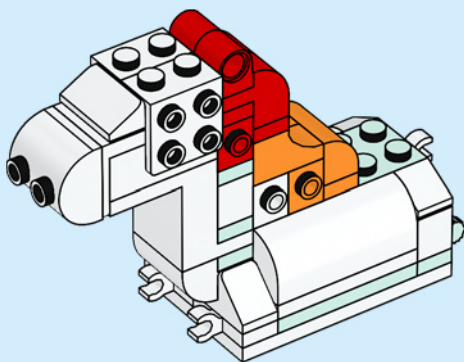



29

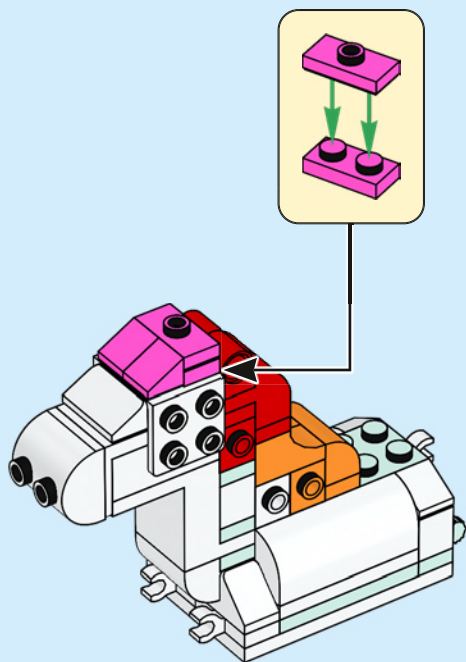



2x



1x

30

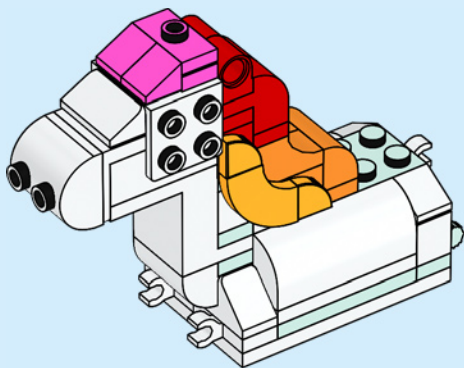



1x



1x

31

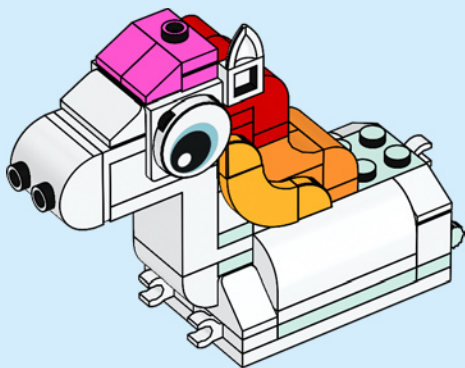



2x



1x

32

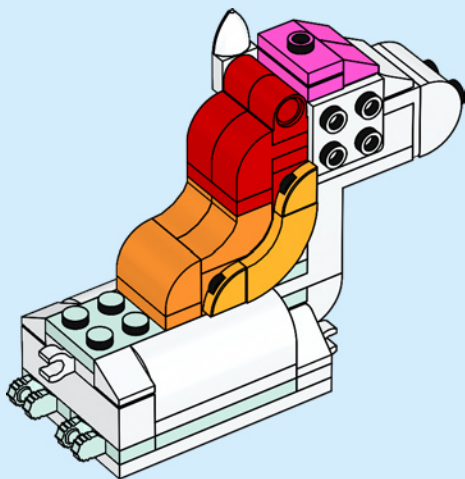



1x



1x

33

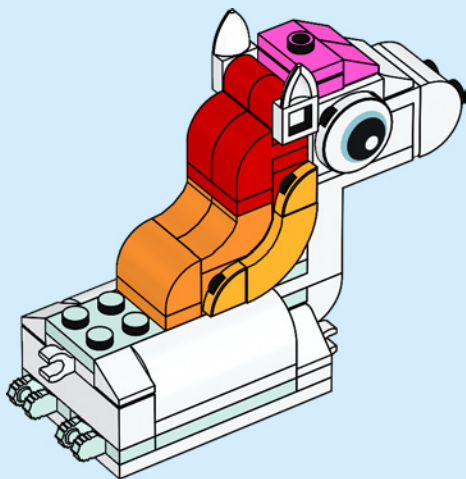

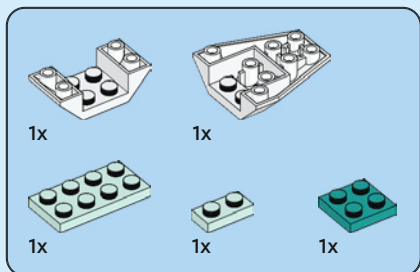

34

1

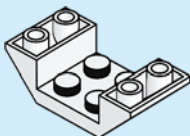

2

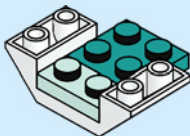

3

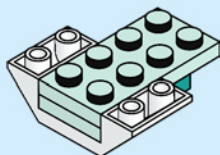

4

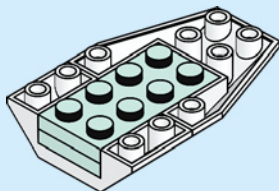

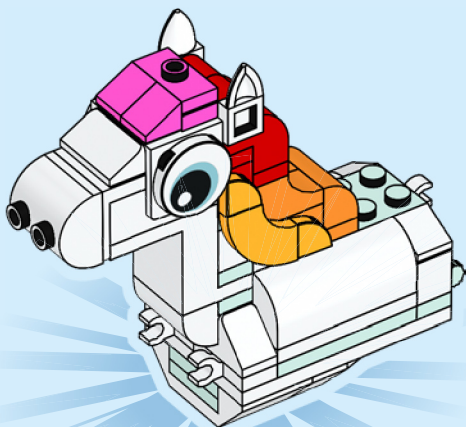



2x



1x



1x

35

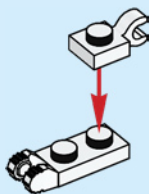

1x

36

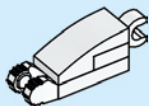

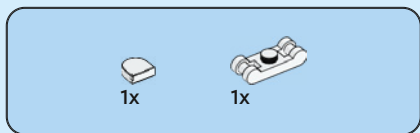

37

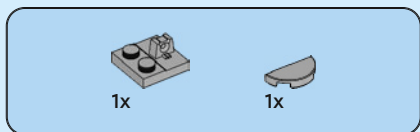
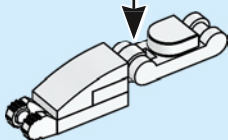
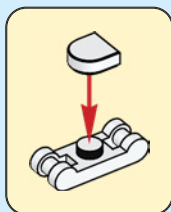

38

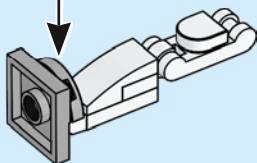
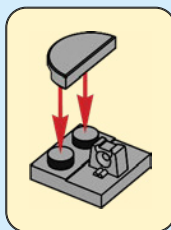

2x

39

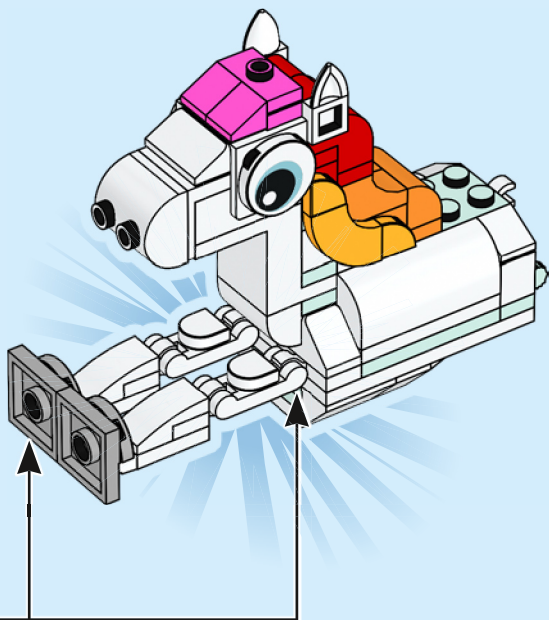



2x



1x



1x

40

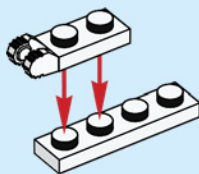

1x

41

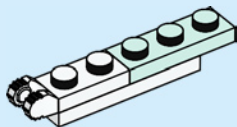



1x



1x

42

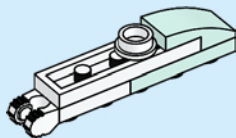

1x

43

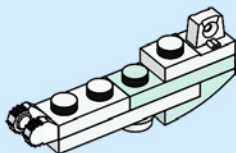

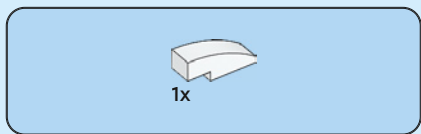

44

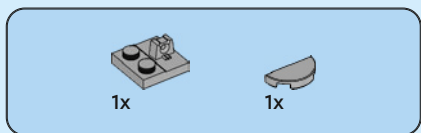
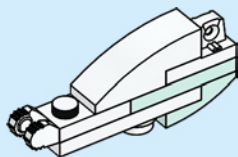

45

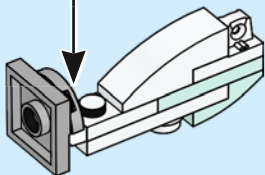
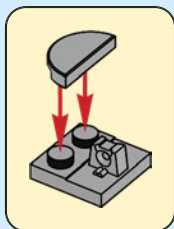

2x

46

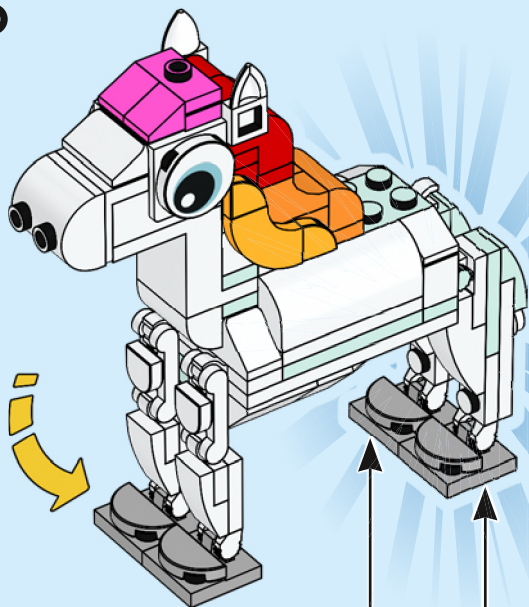

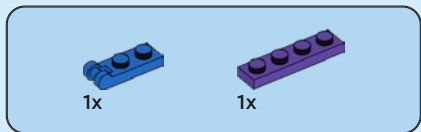
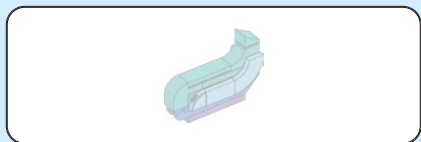

47

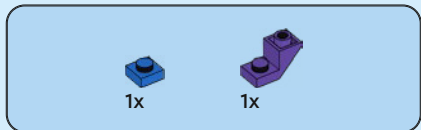
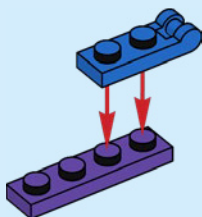

48

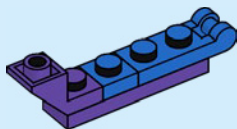



1x



2x

49

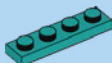
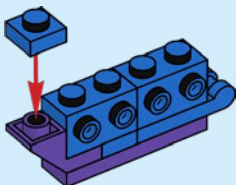

1x



1x

50

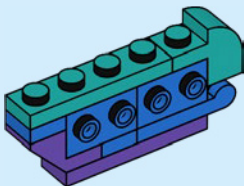



1x



1x



1x

51

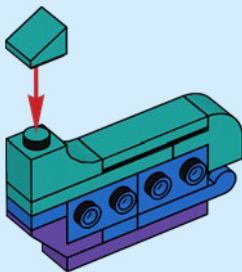

1x

52

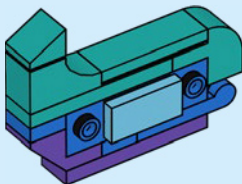



1x



1x

53

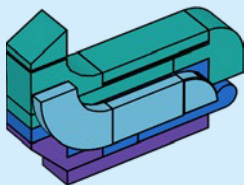



1x

54

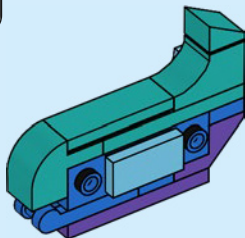

1x



1x

55

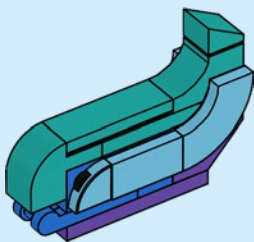

56

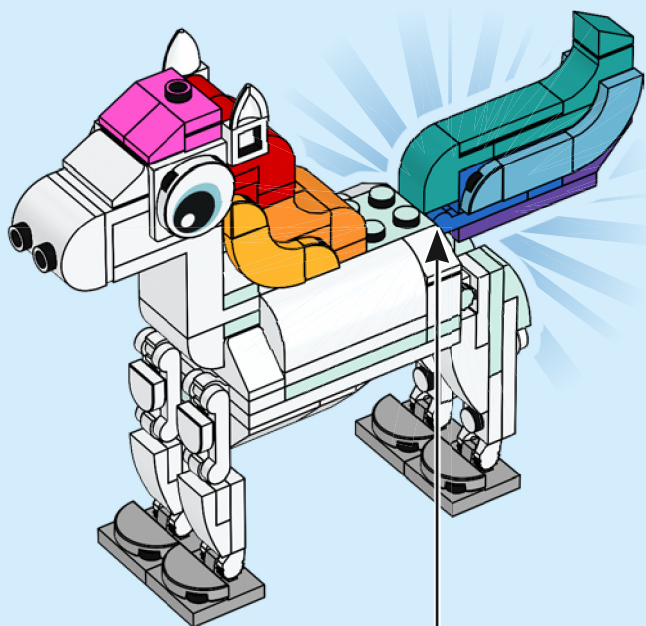



1x



1x

57

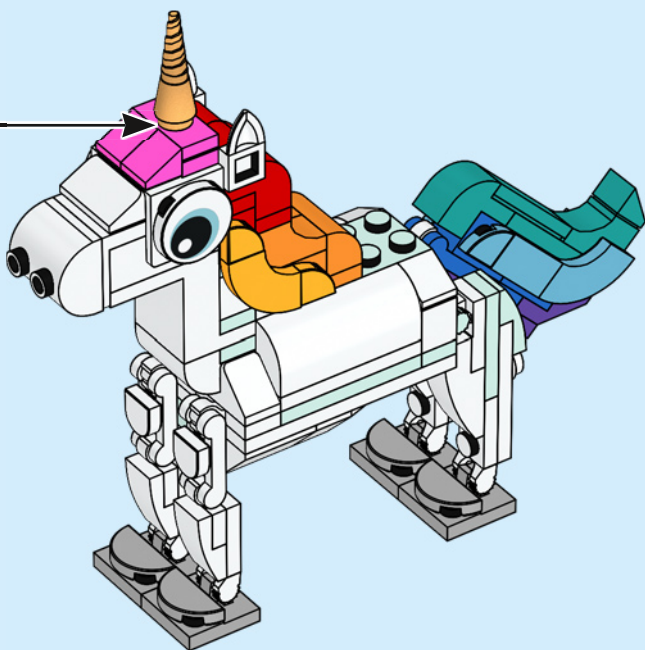
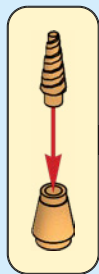

58

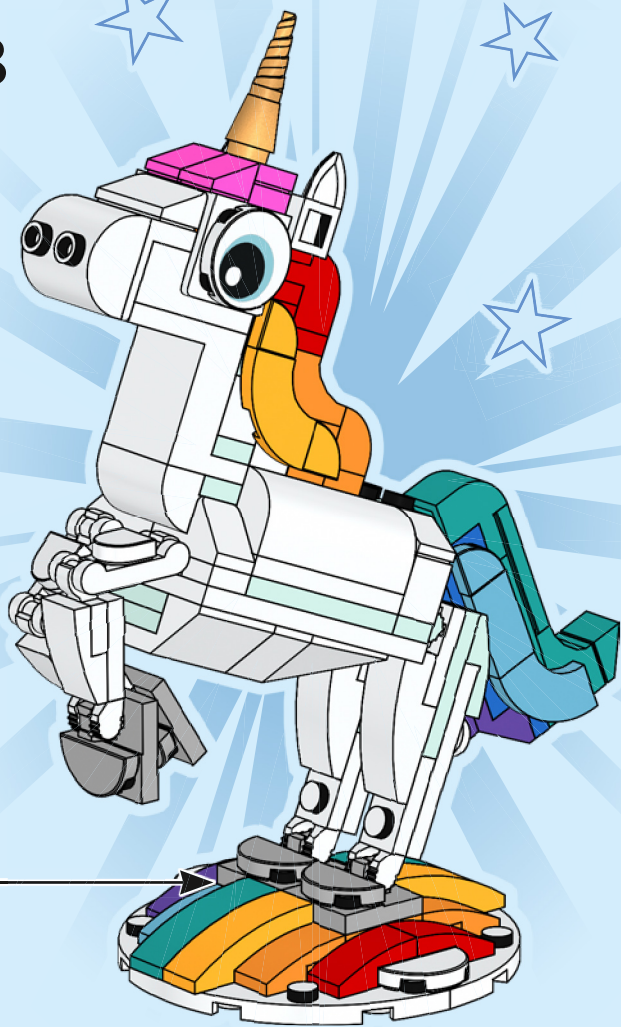

LEGO

CREATOR™

3 IN 1

31137



31138

31139

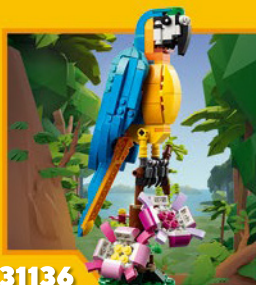

31136

31135



31134



31140





2x
614101



3x
6313115



4x
371001



2x
302321



2x
6250591



2x
6069002



1x
301001



2x
6184782



2x
4558952



1x
300401



2x
608101



2x
6099736



2x
4504369



2x
6034044



1x
4173943



4x
6408629



2x
6347293



3x
6117940



1x
6092950



4x
6265742



2x
4224792



2x
6431329



1x
6310374



2x
302423



2x
6400114



1x
4624989



1x
303201



2x
6431331



1x
4547489



1x
6400127



1x
6073890



2x
6252746



4x
6267044

2x
6138699



2x
6431334



2x
6265695



2x
4249112

2x
4558886



4x
4177932

50



1x
300201

2x
6029946

2x
6055069

2x
6431333

1x
6385785

1x
6126063

2x
6127601

1x
6057387

1x
6217794

1x
6278172

1x
6431332

1x
6399564

2x
6249390

2x
6057390

1x
6431330

1x
6167464

2x
6249426

1x
6213787

1x
6350418

1x
6259794

4x
6214457

2x
6334203

2x
6022064

2x
6071607

2x
6150307

2x
6097419

2x
6071246

2x
4649741

1x
6126090

2x
6258069

1x
6214208

1x
4529247

2x
6336530

2x
6431335

5x
6146701

2x
6325961

4x
6138662



 [LEGO.com/service](https://www.LEGO.com/service)

YOU COULD

WIN



Scan this QR code or go to **LEGO.COM/PRODUCTFEEDBACK** and give us your short feedback about this LEGO® set for a chance to win a cool LEGO prize.

Terms and Conditions apply*

DE: Du könntest GEWINNEN. Es gelten die Teilnahmebedingungen* **FR: Tu pourrais GAGNER.** Des conditions s'appliquent* **IT: Potresti VINCERE tu.** Termini e condizioni sono applicabili* **ES: Puedes GANAR.** Aplican términos y condiciones* **PT: Poderá GANHAR.** Aplicam-se termos e condições* **JA: プレゼント付き! 利用規約が適用されます*** **ZH: 轻松获奖. 条款和条件适用*** **KO: 상품의 주인이 되어보세요. 소정의 약관이 적용됩니다*** **RU: Вы можете ВЫИГРАТЬ.** Действуют положения и условия* **PL: Szansa na WYGRANĄ.** Obowiązują warunki korzystania* **CS: Máte šanci VYHRÁT.** Platí všeobecné smluvní podmínky* **SK: Máte šancu VYHRÁT.** Platia všeobecné zmluvné podmienky* **HU: TE IS NYERHETSZ.** Felhasználási feltételek érvényesek* **RO: Ai putea CÂȘTIGA.** Se aplică termeni și condiții* **BG: Можете да СПЕЧЕЛИТЕ.** Има определени правила и условия* **LV: Tu vari LAIMĒT.** Ir spēkā noteikumi un nosacījumi.* **ET: Sul on võimalus VÕITA.** Kehtivad tingimused* **LT: Jūs galite LAIMĖTI.** Taikomos sąlygos*

*[LEGO.com/productfeedback-terms](https://www.lego.com/productfeedback-terms)