



40450





## AMELIA EARHART TRIBUTE

From her childhood, Amelia Earhart was pushing the boundaries and expectations of being a girl in the early 20th century. Climbing trees, hunting rats and keeping a scrap book of her female role models, succeeding in fields like film direction, law, advertising, management and mechanical engineering – at that time all considered male oriented fields – were all things characterizing Amelia. But Amelia followed her heart, and knew she was cut out to do differently.

On December 28, 1920, pilot Frank Hawks gave her a ride



# 1932



that would forever change her life. *"By the time I had got two or three hundred feet off the ground, I knew I had to fly."*

Together with her husband (Amelia Earhart referred to her marriage as a partnership with dual control), Amelia Earhart was secretly planning for the 1932 solo flight cross the Atlantic – an achievement accomplished by no woman before. She took off from Harbor Grace, Newfoundland with the destination of Paris in mind. Strong north winds, icy conditions and mechanical problems plagued the flight and

forced her to land in a pasture near Londonderry, Ireland.

Recognized as an amazing achievement at the time, Amelia Earhart was awarded the Distinguished Flying Cross – the first ever given to a woman. At the ceremony, US Vice President Charles Curtis praised her bravery, saying she displayed *"heroic courage and skill as a navigator at the risk of her life."* Earhart felt the flight proved that men and women were equal in *"jobs requiring intelligence, coordination, speed, coolness, and willpower."*





## HOMMAGE À AMELIA EARHART

Dès son enfance, Amelia Earhart repousse les limites et les at- tentes qui accablent les femmes au début du 20<sup>e</sup> siècle. Amelia se distingue de maintes façons : elle grimpe dans les arbres, chasse les rats, tient un album de ses modèles féminins et œu- vre dans des domaines comme la réalisation de films, le droit, la publicité, la gestion et le génie mécanique – à cette époque tous considérés comme des do- maines réservés aux hommes. Mais Amelia écoute son cœur et sait qu'elle est destinée à faire les choses différemment.

Le 28 décembre 1920, le pilote Frank Hawks lui fait faire un tour d'avion qui changera sa vie à



# 1932



jamais. « *Au moment où j'étais à deux ou trois cents pieds du sol, je savais que je devais voler.* »

Avec son mari (Amelia Earhart qualifie son mariage de partenariat à double contrôle), Amelia Earhart planifie secrètement le vol transatlantique en solitaire de 1932, une réalisation qui n'avait jamais été accomplie par une femme auparavant. Elle décolle de Harbor Grace, Terre-Neuve-et-Labrador, pour se rendre à Paris. De forts vents du nord, des conditions givrantes et des problèmes mécaniques perturbent le vol et forcent Amelia à atterrir dans un pâturage près de Londonderry, en Irlande.

Ayant accompli une réalisation étonnante pour l'époque, Amelia Earhart reçoit la Croix du service distingué dans l'Aviation, la première à être décernée à une femme. Lors de la cérémonie, le vice-président américain Charles Curtis salue la bravoure d'Amelia Earhart, affirmant qu'elle avait fait preuve d'un « *courage et d'une habileté héroïques comme navigatrice, au péril de sa vie* ». Earhart estime que le vol prouve que les hommes et les femmes sont égaux dans « *les emplois nécessitant intelligence, coordination, rapidité, sang-froid et volonté* ».





## HOMENAJE A AMELIA EARHART

En su infancia, Amelia Earhart ya desafiaba los límites y expectativas de lo que significaba ser una niña a principios del siglo XX. Trepar a los árboles, cazar ratas, recopilar recortes con los logros de sus modelos femeninos a seguir o triunfar en campos como la dirección cinematográfica, el derecho, la publicidad, la administración y la ingeniería mecánica eran hasta entonces acciones reservadas para hombres y que, sin embargo, caracterizaban a Amelia. Pero Amelia seguía los dictados de su corazón y sabía que estaba hecha para ser diferente.

El 28 de diciembre de 1920, el piloto Frank Hawks la llevó a dar



# 1932



un paseo que cambiaría su vida para siempre. “Cuando alcanzamos los ochenta o cien metros de altura, supe que tenía que volar”.

Con la ayuda de su marido (Amelia Earhart describía su matrimonio como “*un vuelo con dos pilotos*”), Amelia Earhart planeó en secreto cruzar el Atlántico en solitario a bordo de un avión en 1932: una hazaña que ninguna mujer había logrado antes. Despegó de Harbor Grace (Terranova), pensando en llegar hasta París. Fuertes vientos del norte, gélidas condiciones y problemas mecánicos dificultaron el vuelo y la obligaron a aterrizar en un

pastizal próximo a Londonderry (Irlanda).

El logro fue considerado asombroso para la época y Amelia Earhart recibió la Cruz de Vuelo Distinguido, convirtiéndose en la primera mujer que la obtuvo. Durante la ceremonia, Charles Curtis, vicepresidente de los Estados Unidos, elogió su valentía y afirmó que había demostrado “*un heroico coraje y una enorme pericia como navegante, poniendo en riesgo su vida*”. Para Earhart, el vuelo había demostrado que hombres y mujeres eran iguales en “*posiciones que exigían inteligencia, coordinación, velocidad, calma y fuerza de voluntad*”.







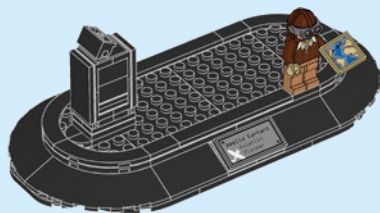
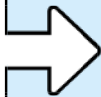
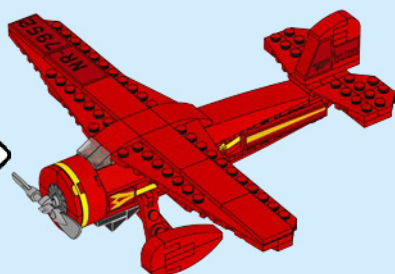
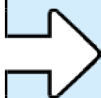

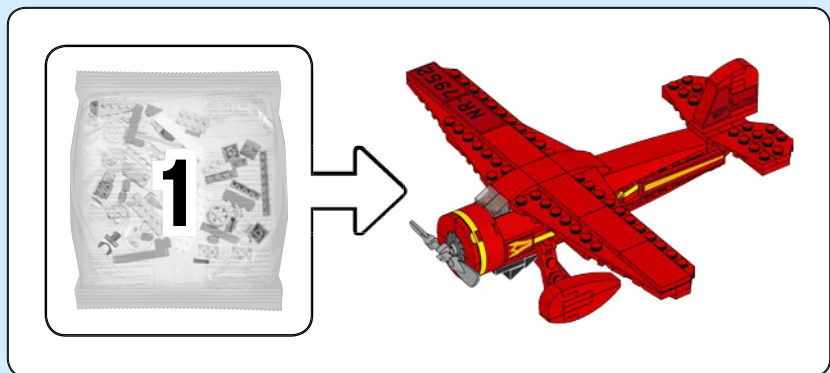

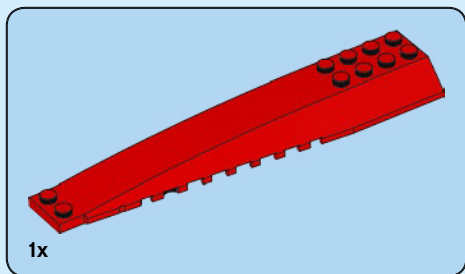

1

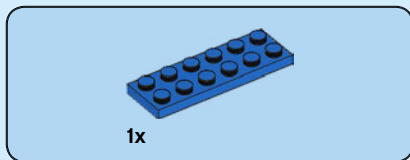
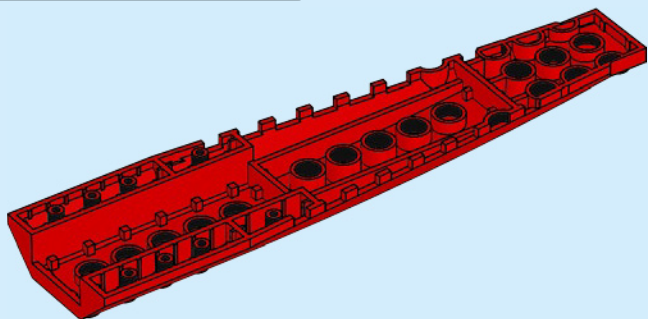

2

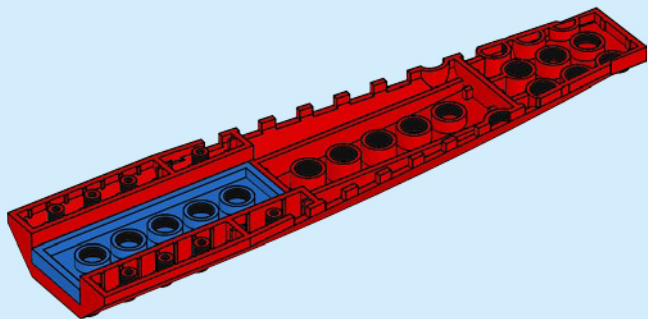

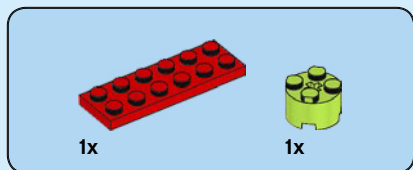

3

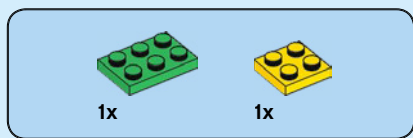
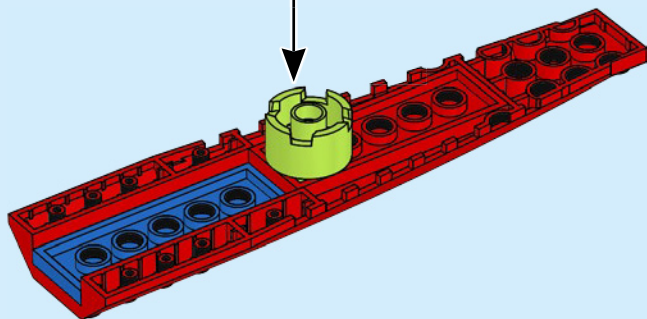
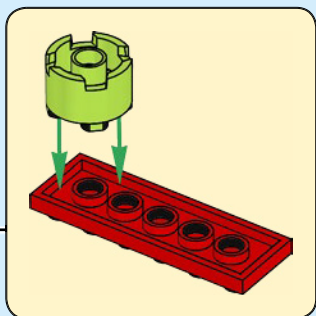

4

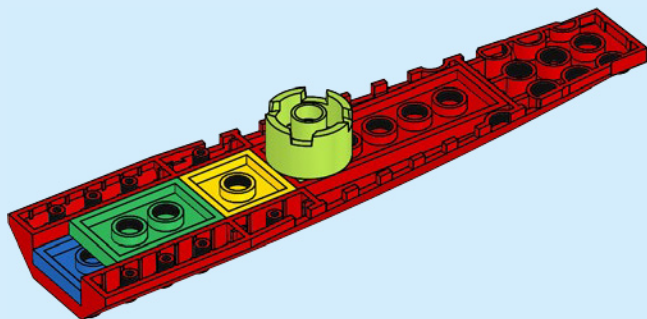

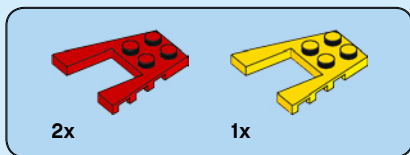

5

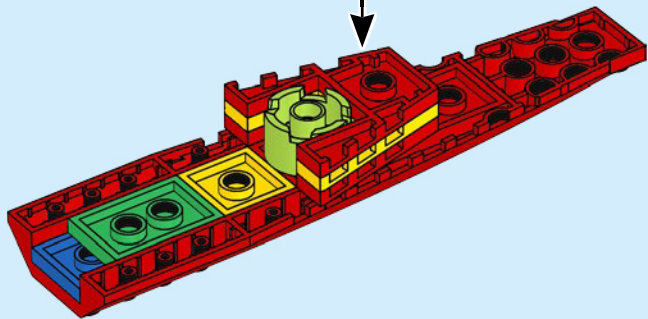
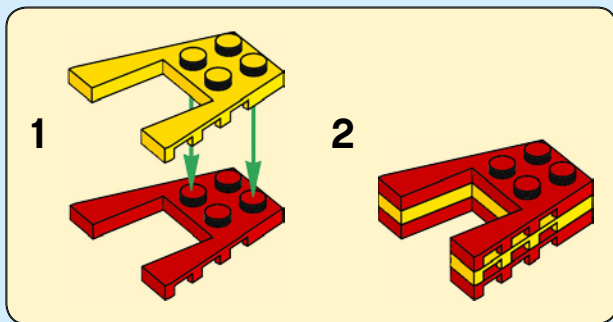

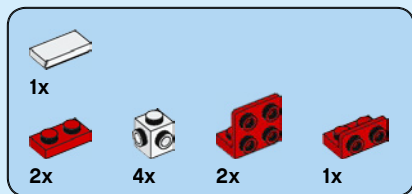

6

1



3

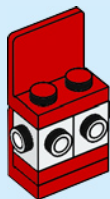

1



2



2



1



2



4

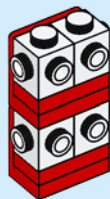



5

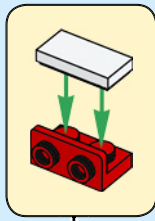

6

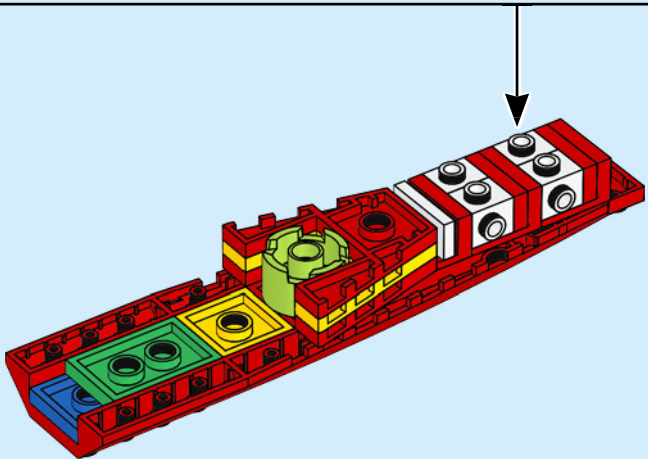
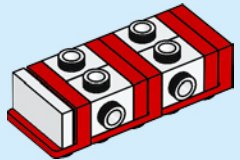

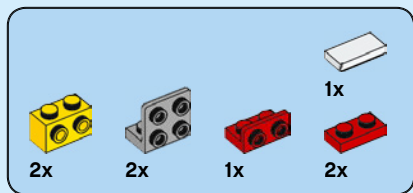

7

1



2

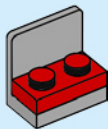

3



4

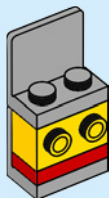

5



6







7

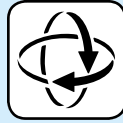
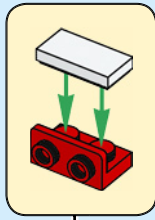

8

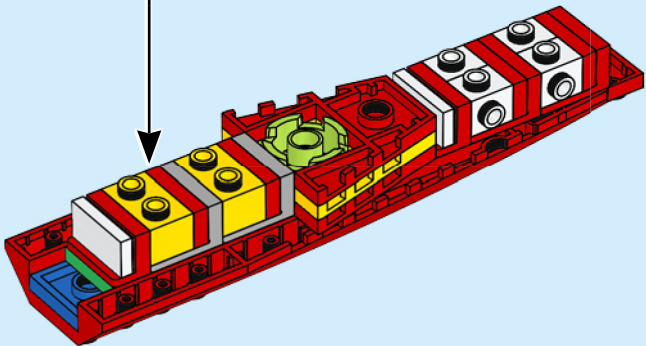
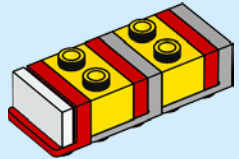

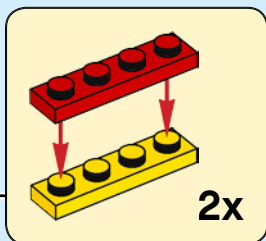

8

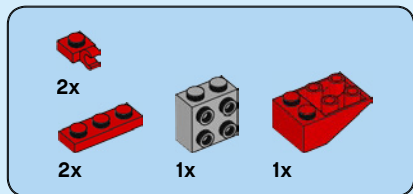
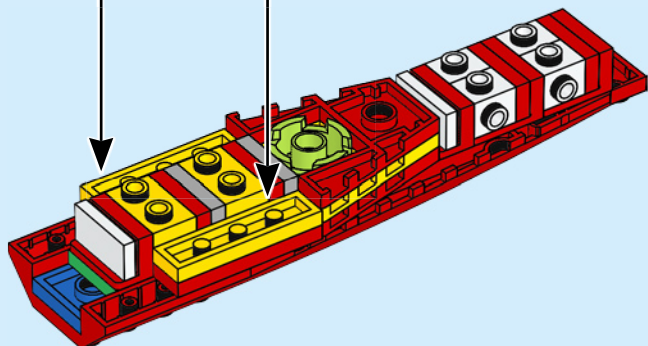

9

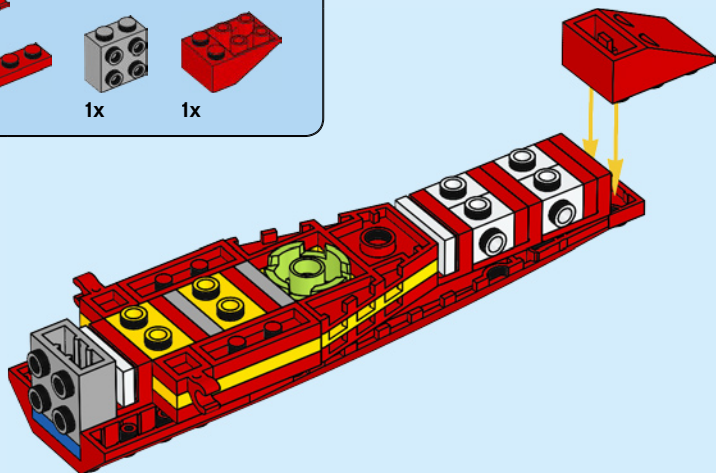



2x

# 10

1

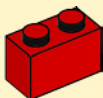

2

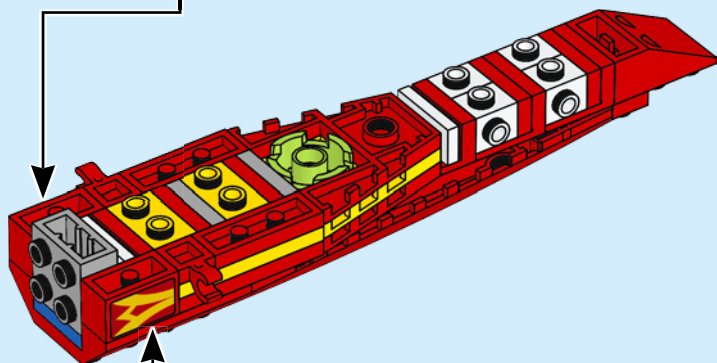

1

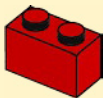

2



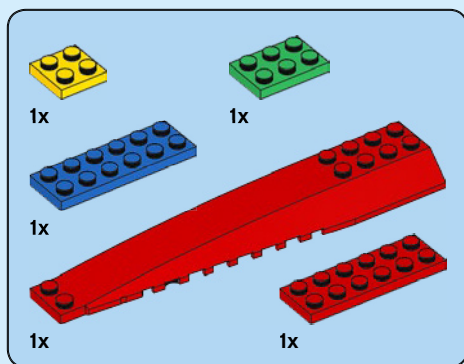

11

1

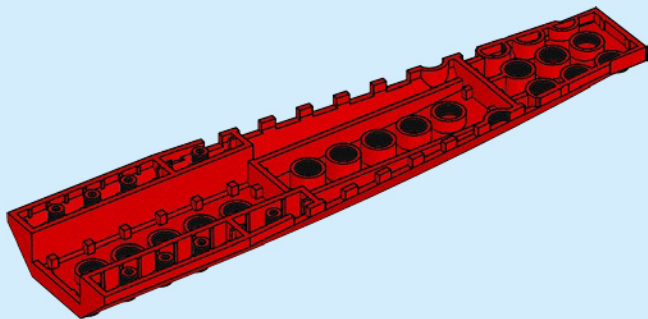

2

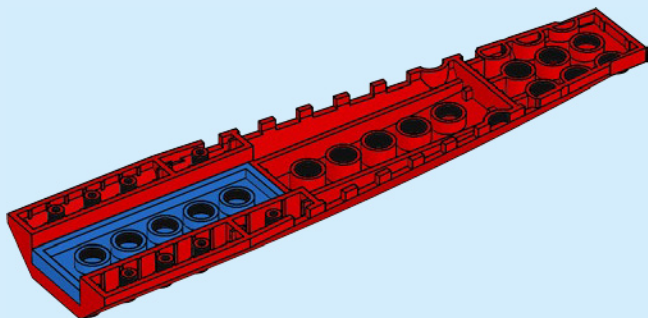

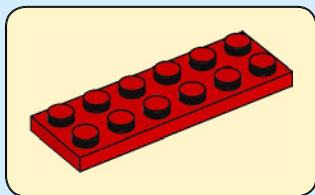

3

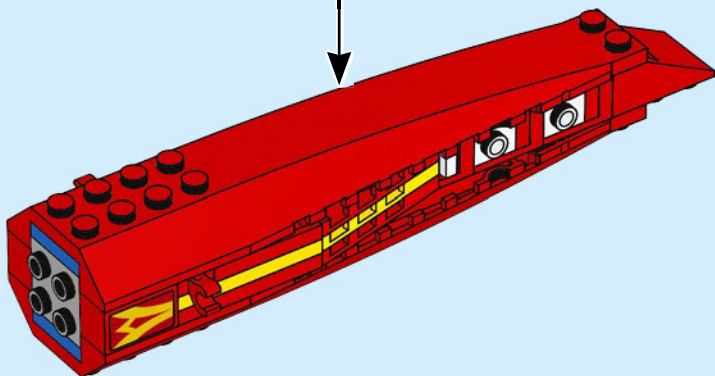
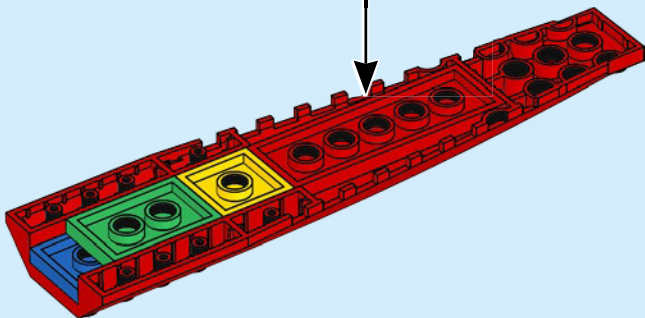

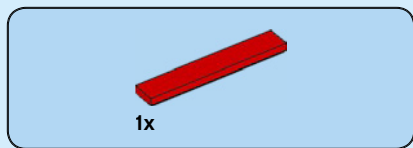

12

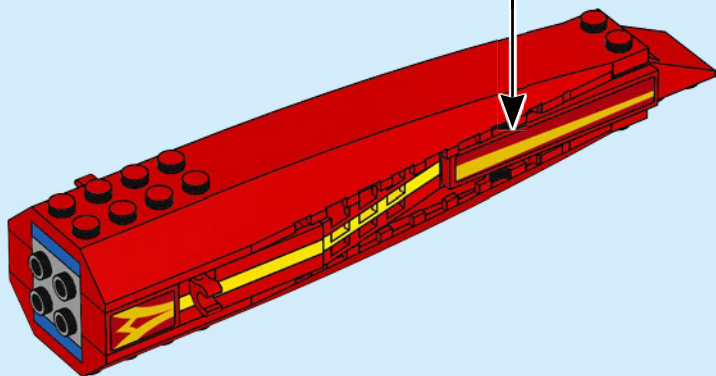
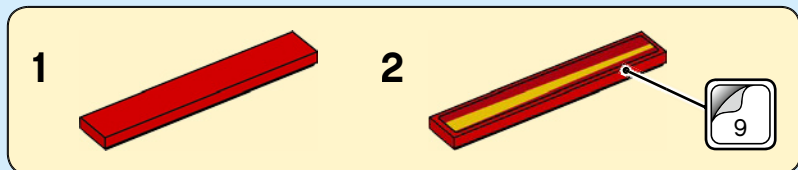

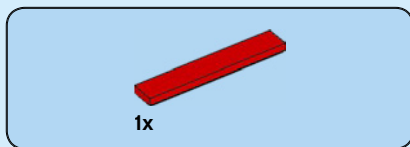

13

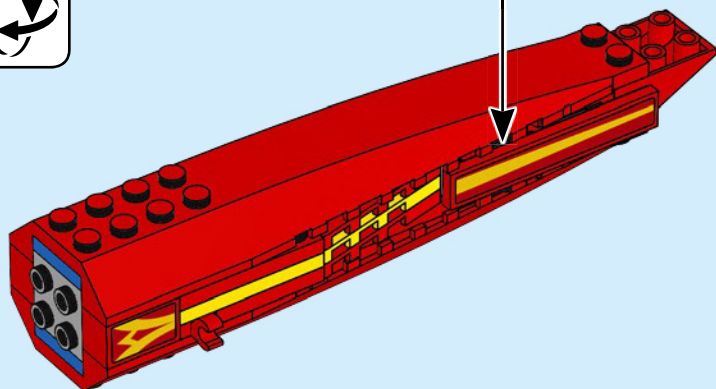
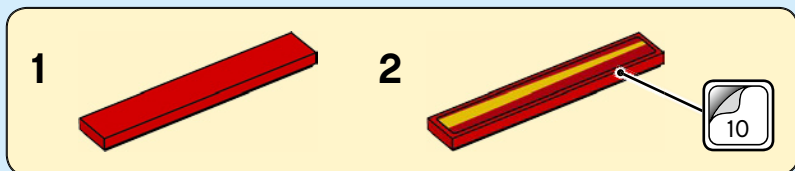

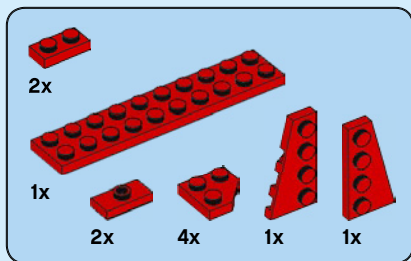

14

1

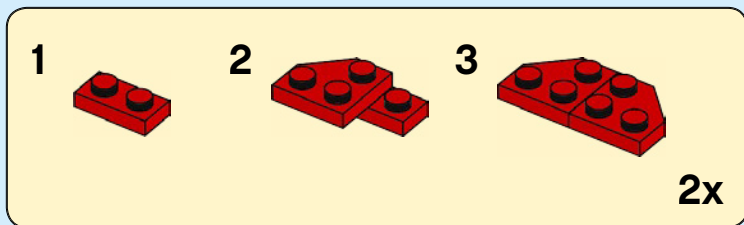
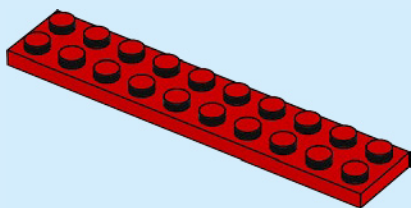

2

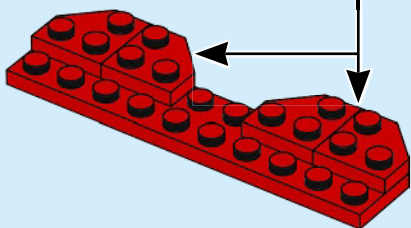



3

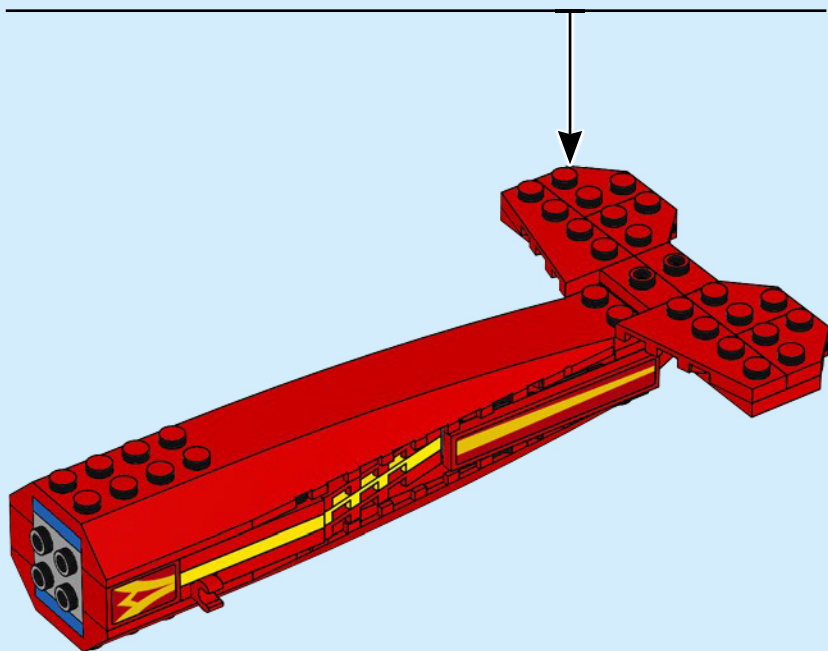
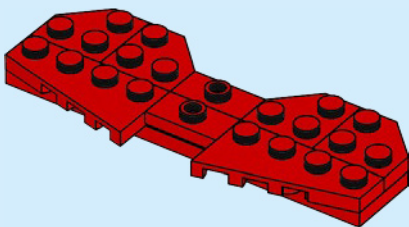



1x

15

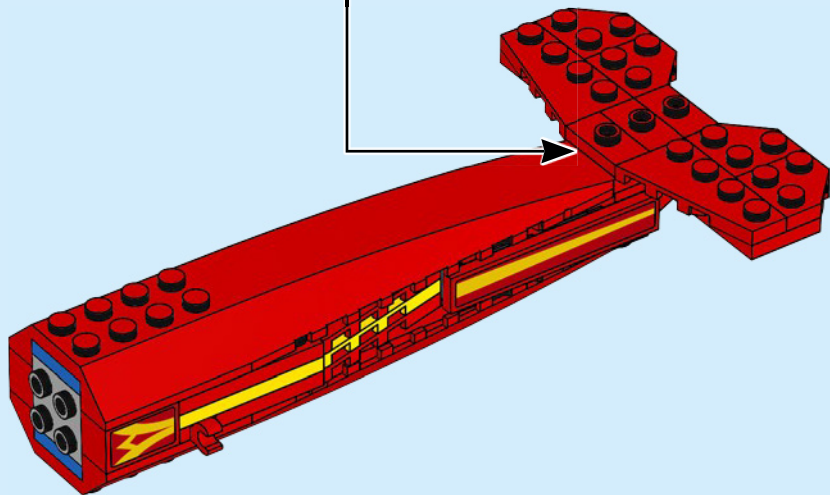

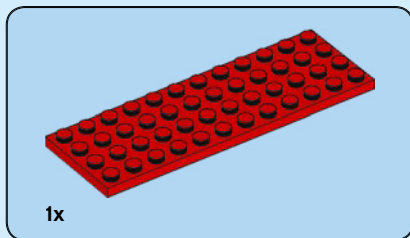
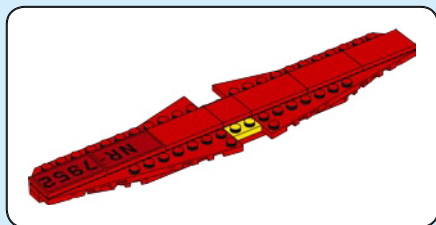

1x

**16**

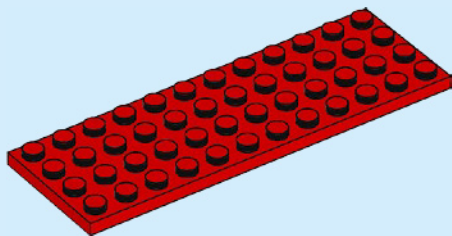

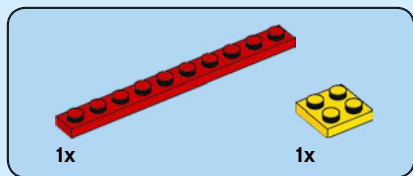

17

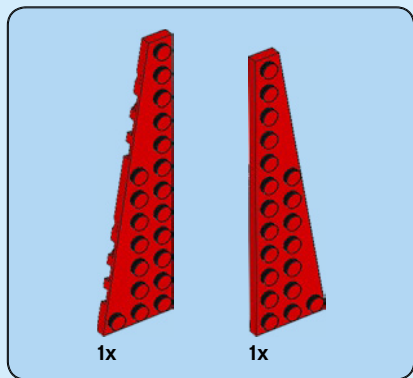
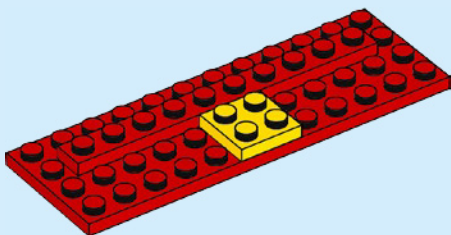

18

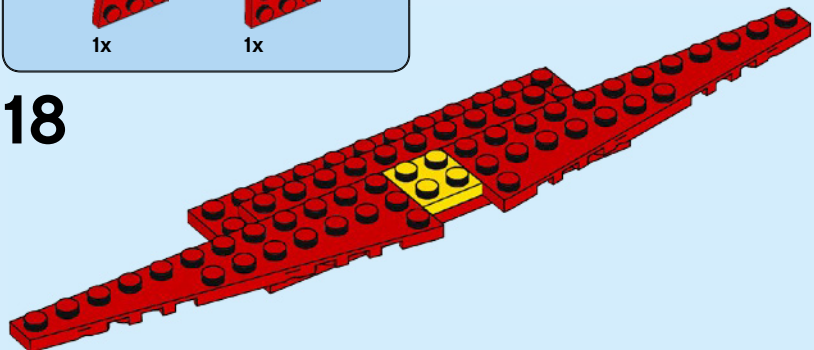

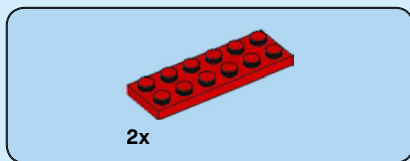

19

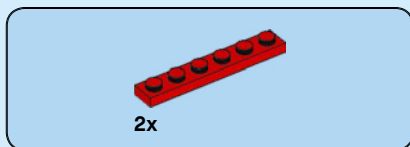
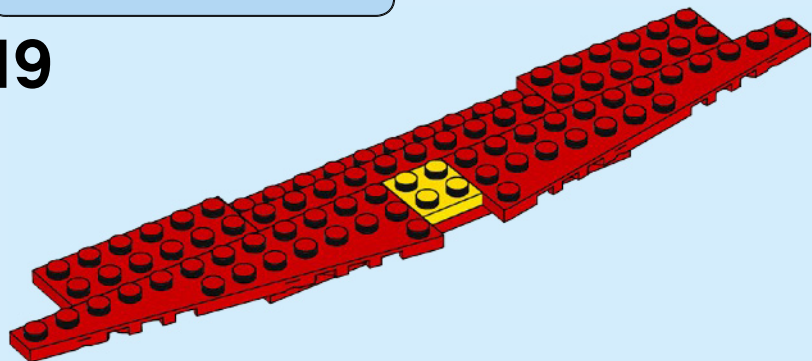

20

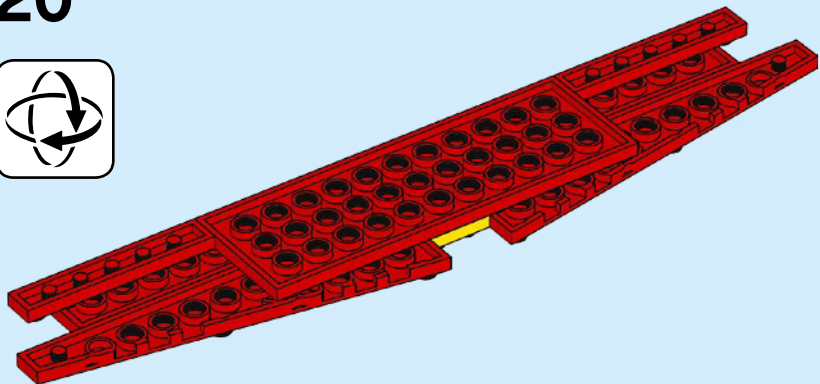
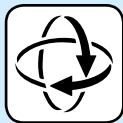



2x

21

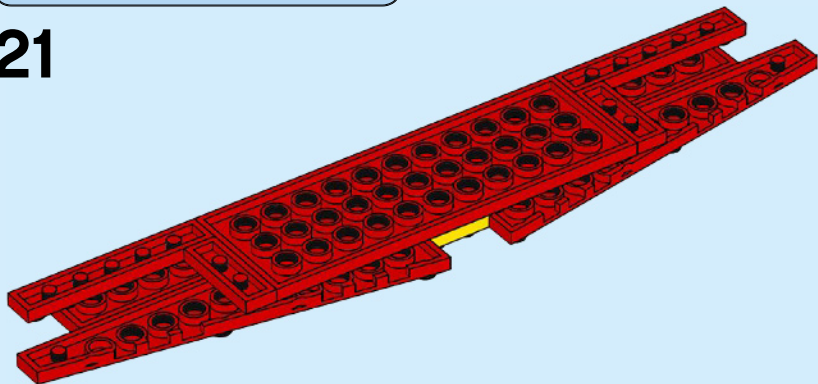

1x

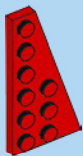

1x

22

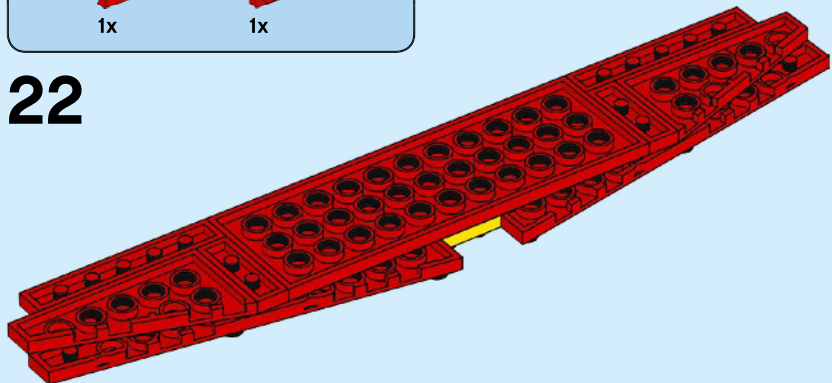

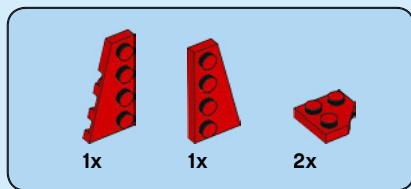

23

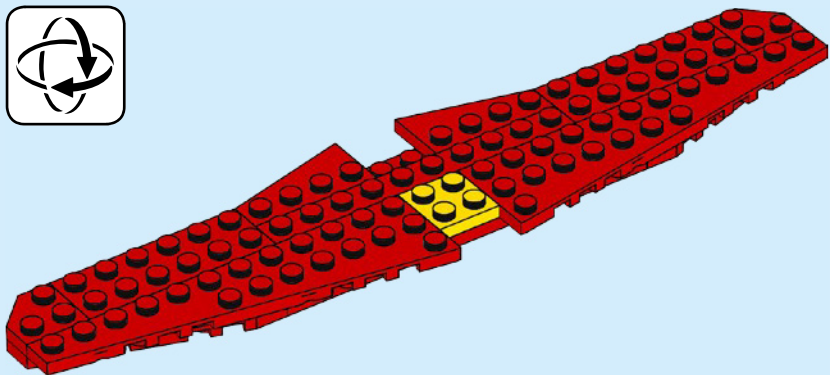

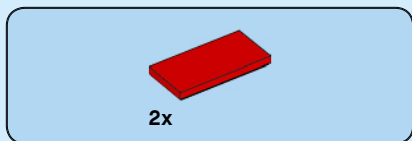

24

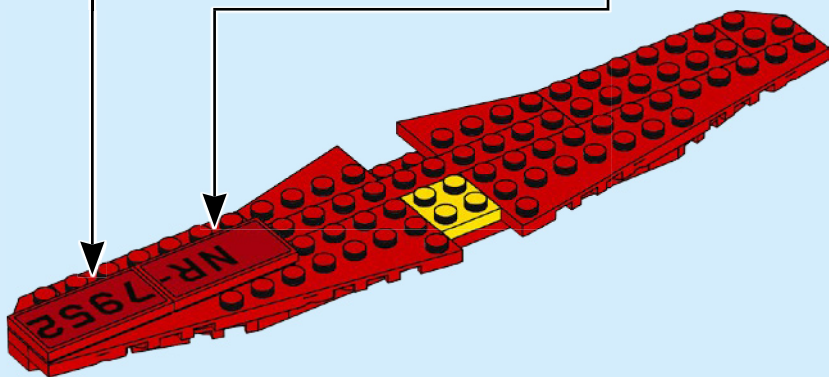
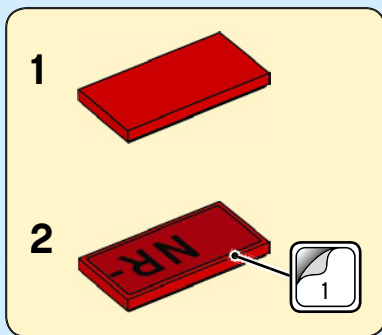
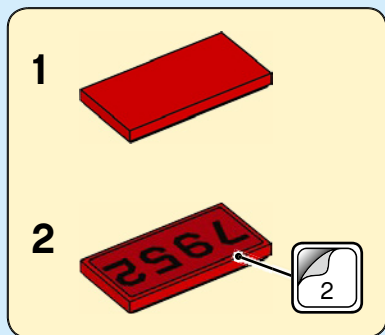



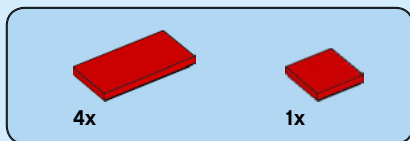

25

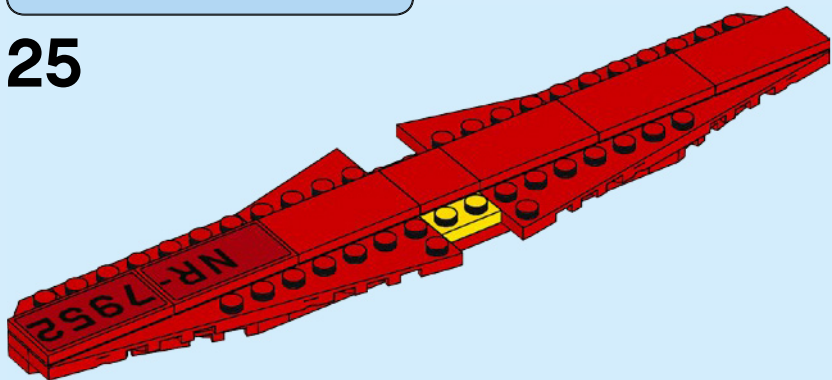

26

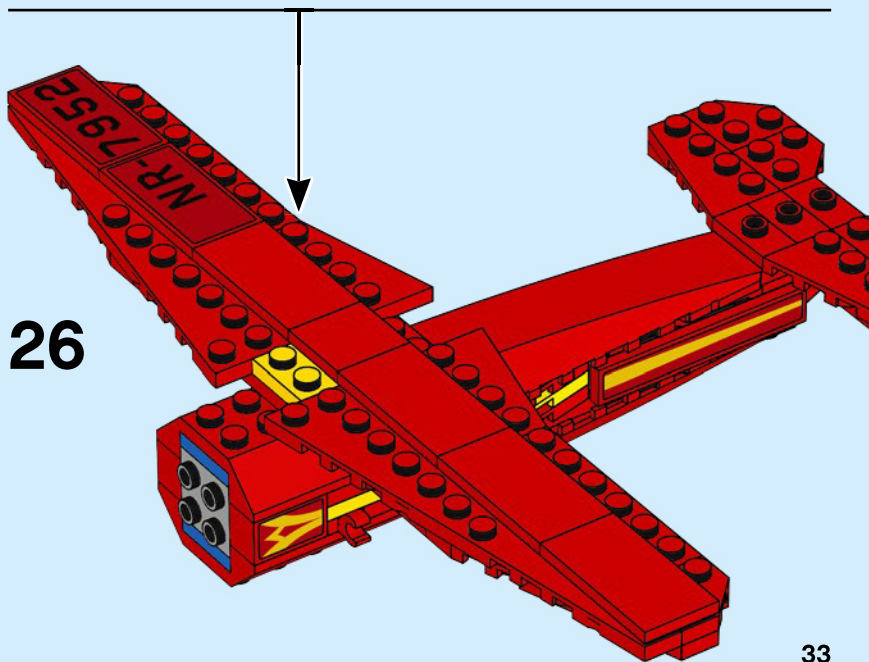



1x



1x



1x

# 27

1



2

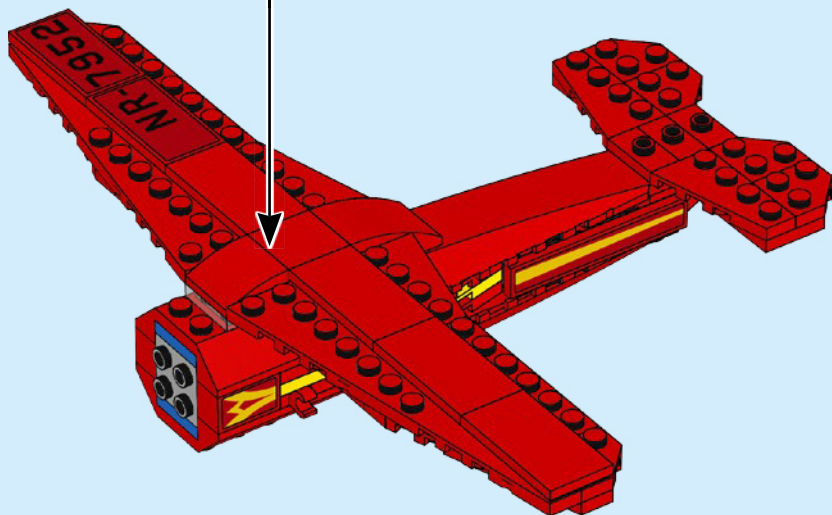
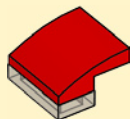



2x

28

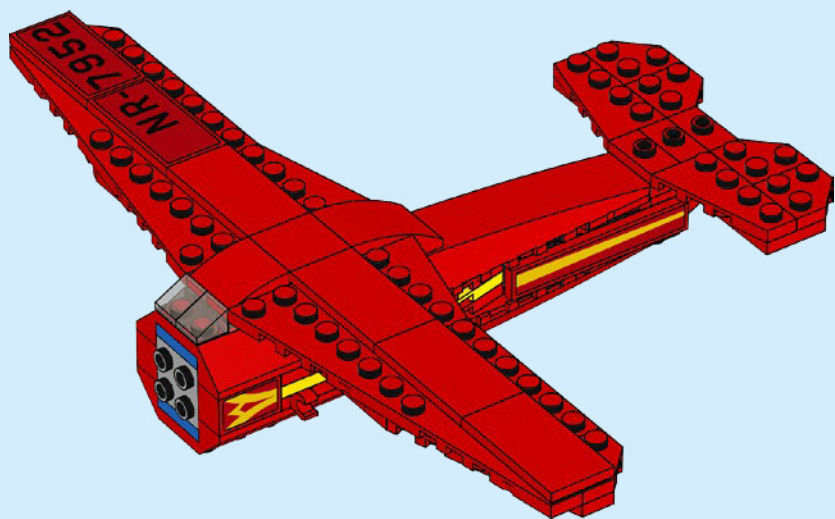



1x



1x

29

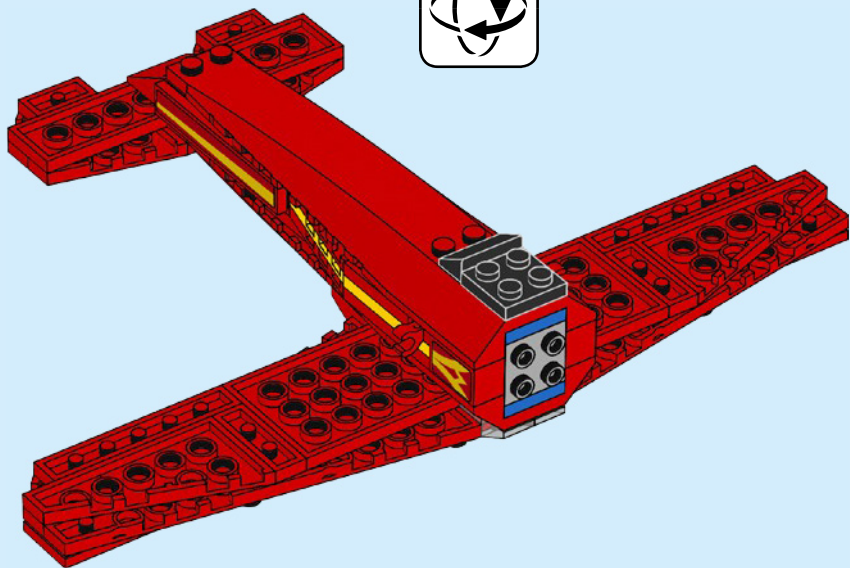



1x



2x

# 30

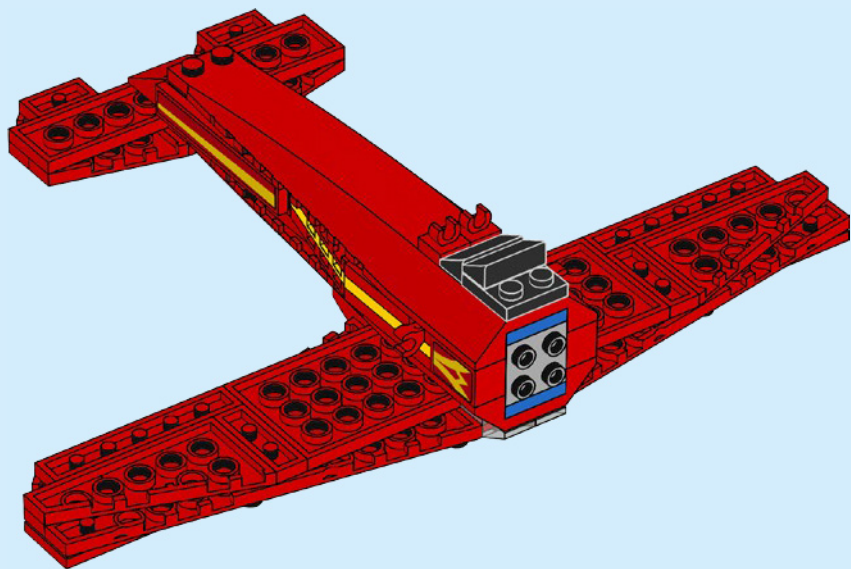

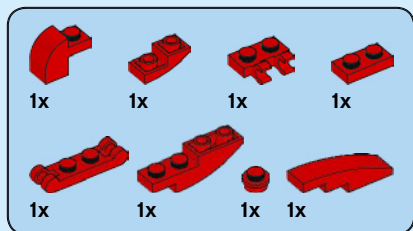

# 31

1

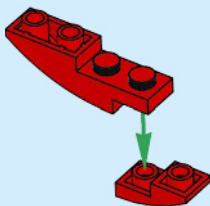

2

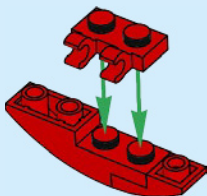

3

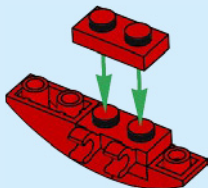

4

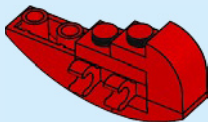

5

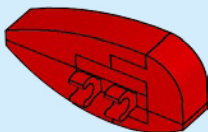

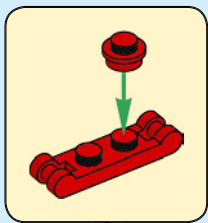

6

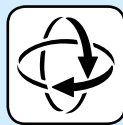
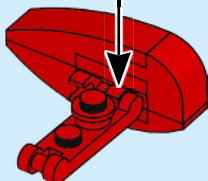

7

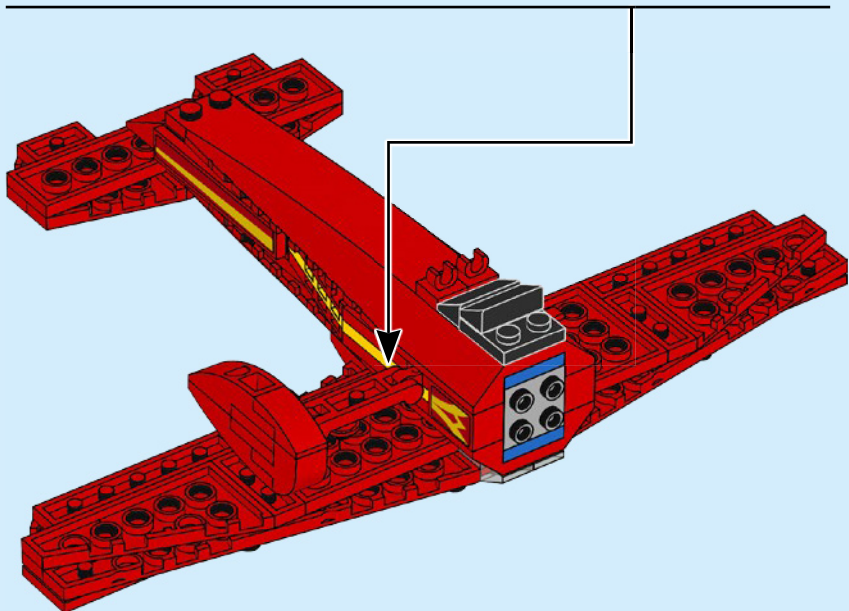
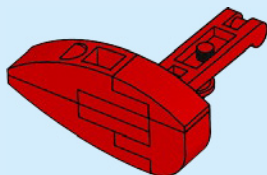

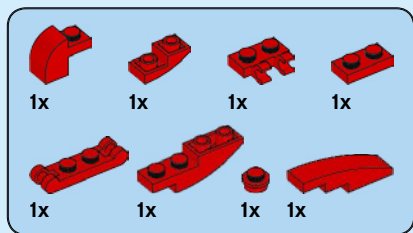

# 32

1

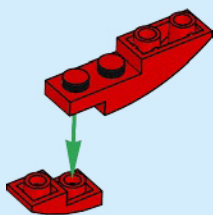

2

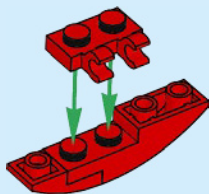

3

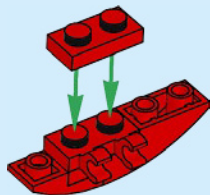

4

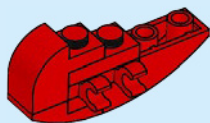

5

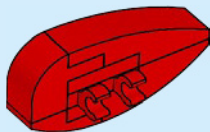



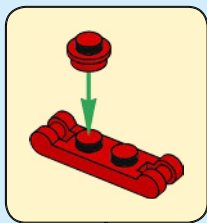

6

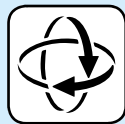
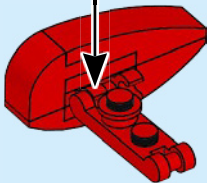

7

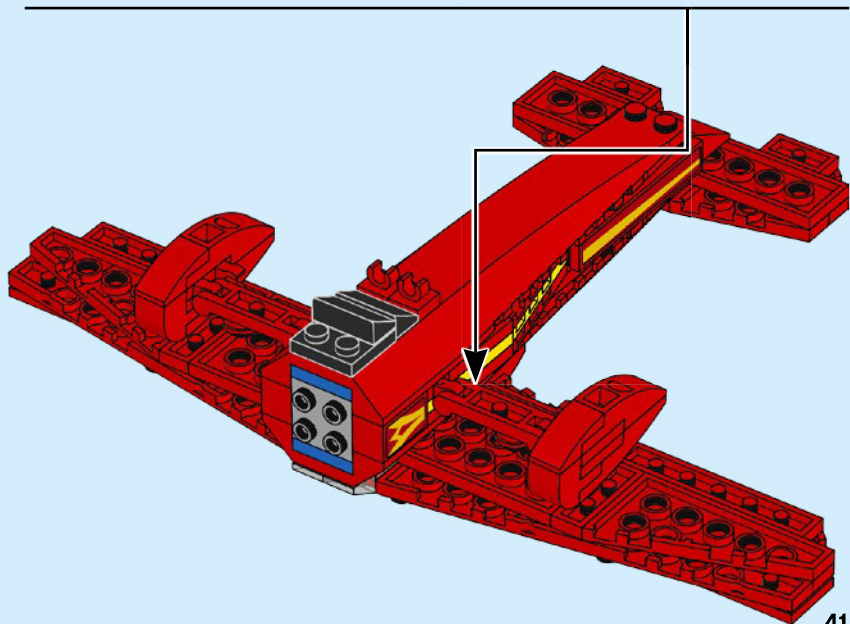
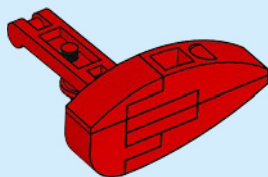



2x

33

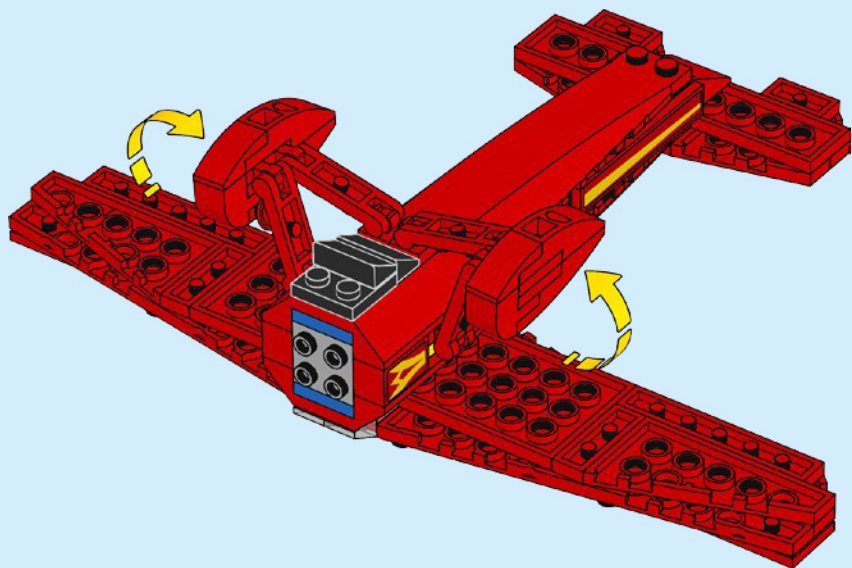

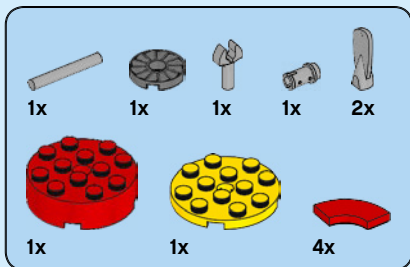

# 34

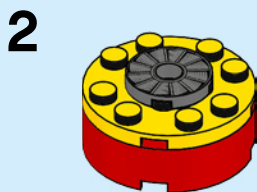
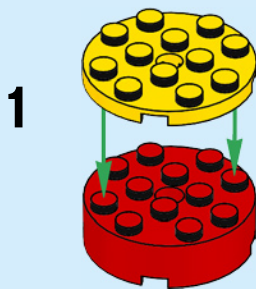

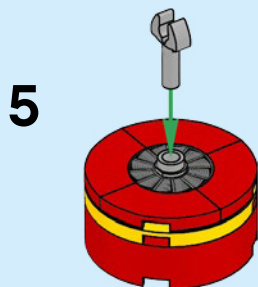
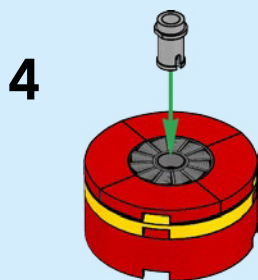
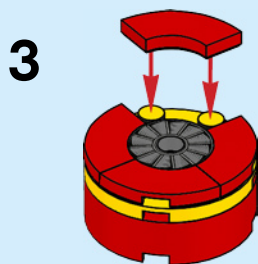

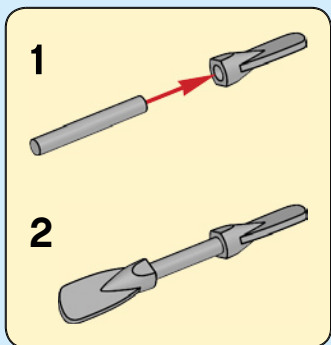

6

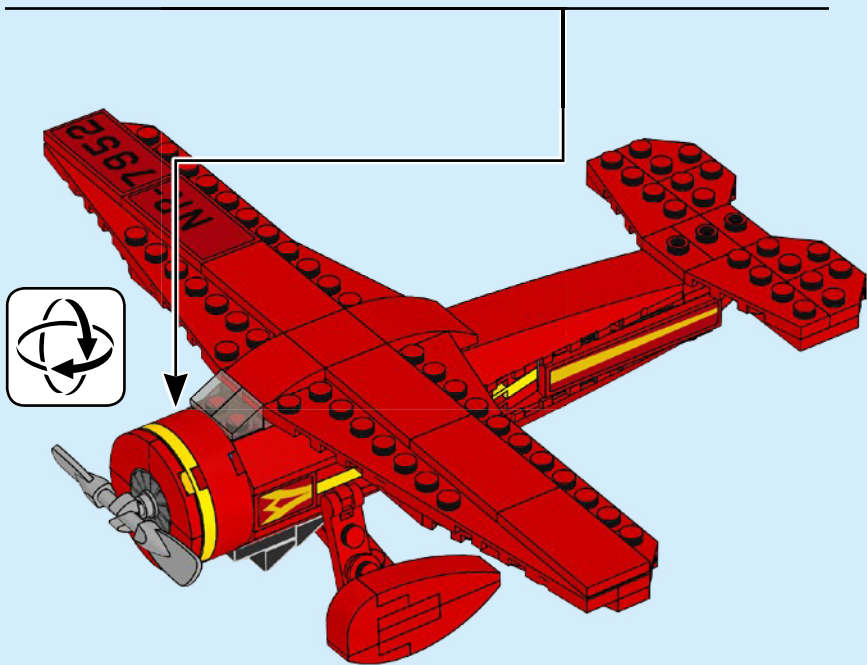
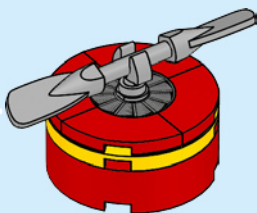

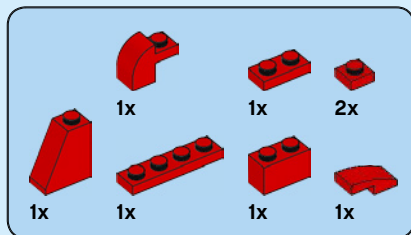

# 35

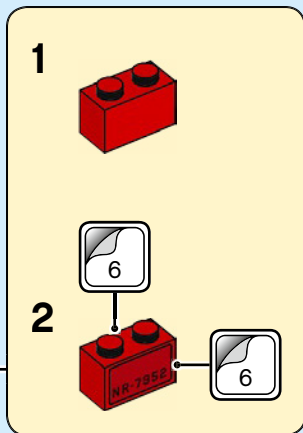
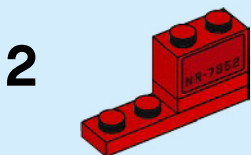
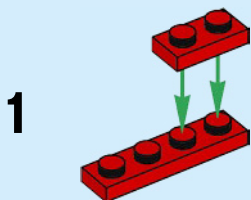

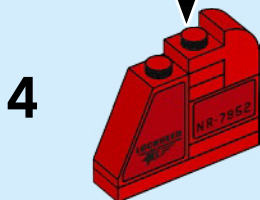
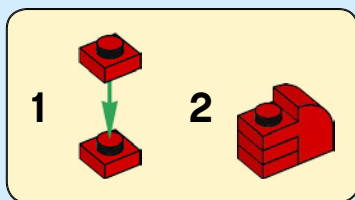
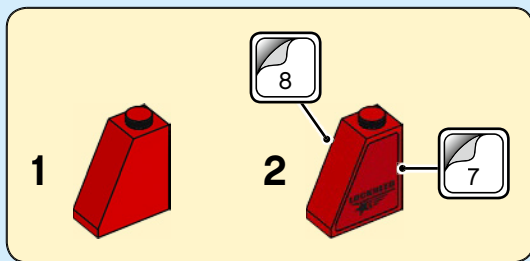

5

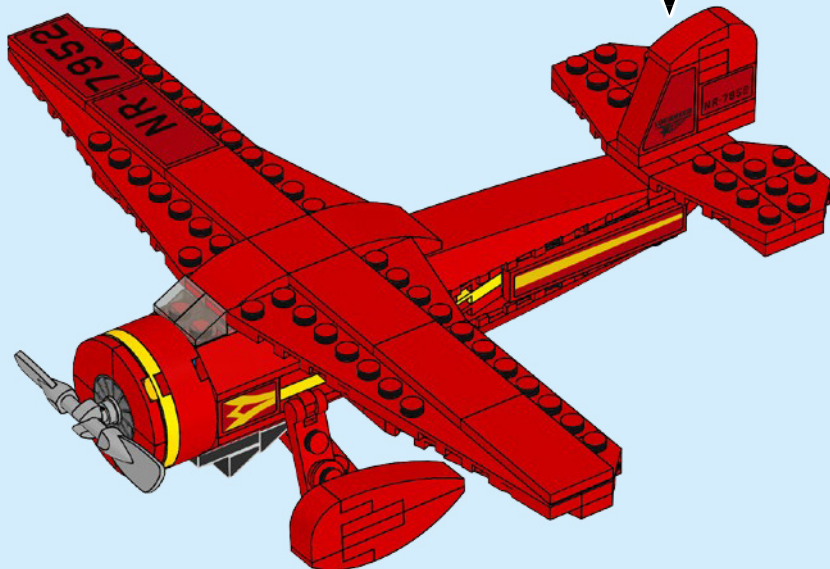
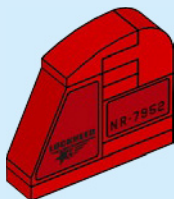



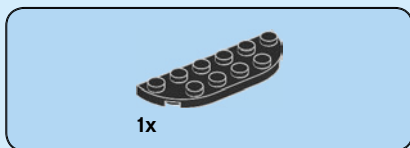
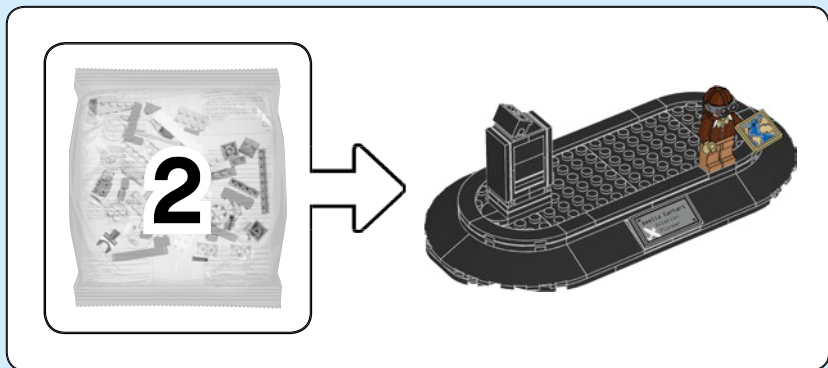

1

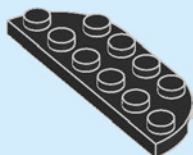

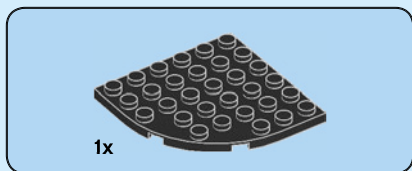

2

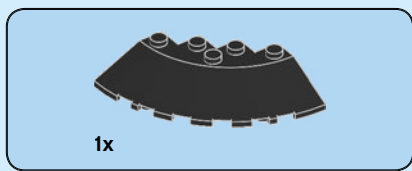
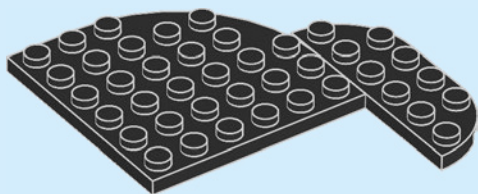

3

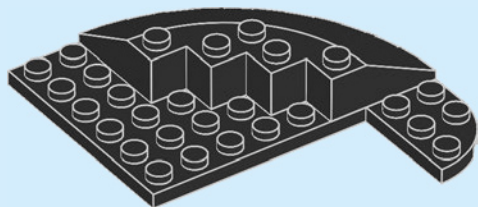

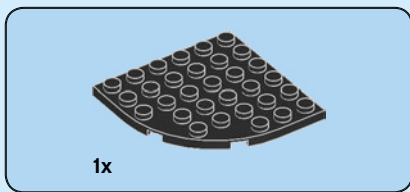

4

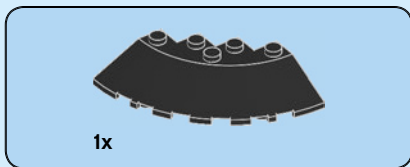
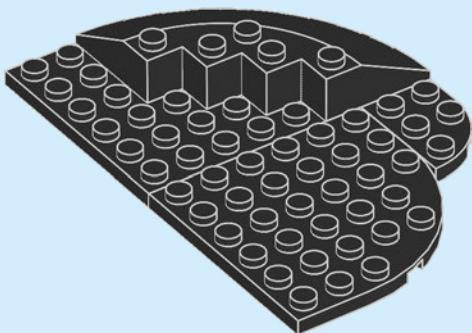

5

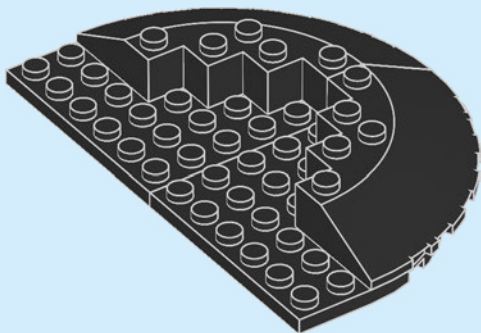

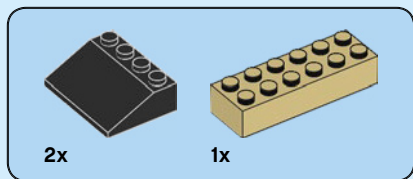

6

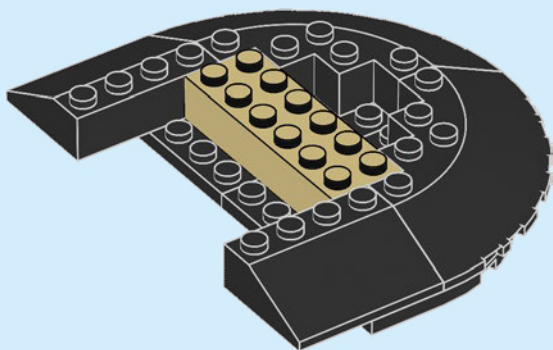

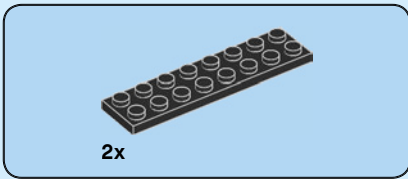

7

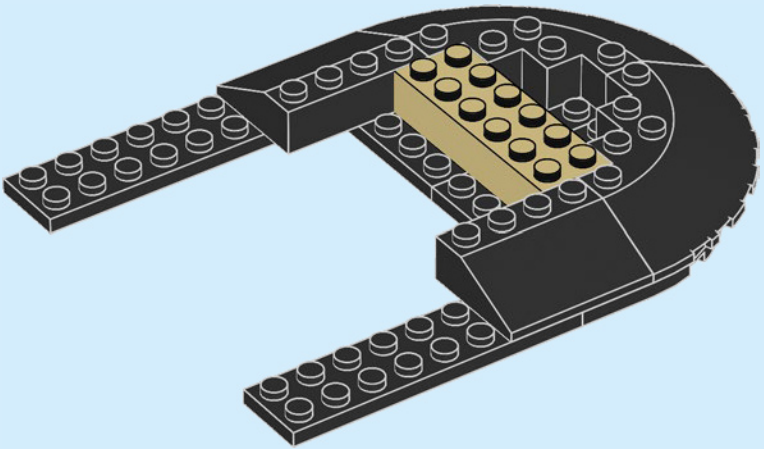



2x

8

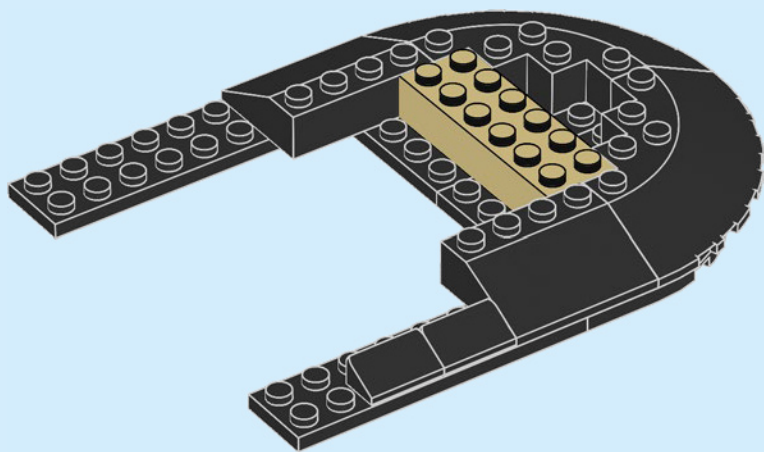



2x



2x

9

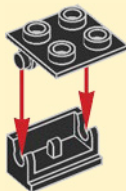

2x

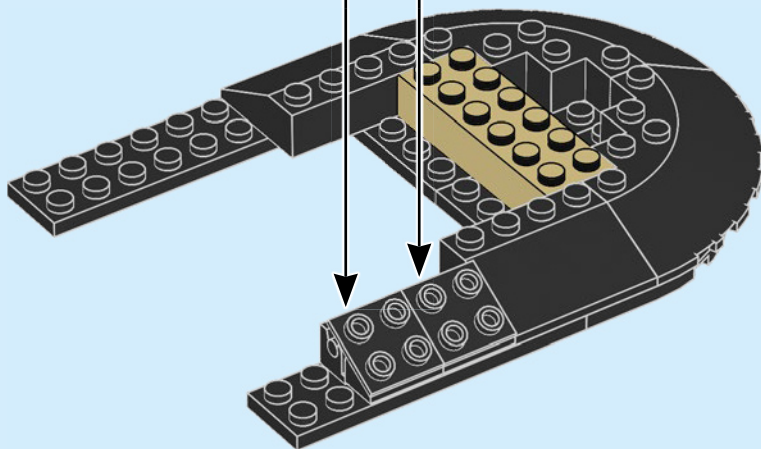

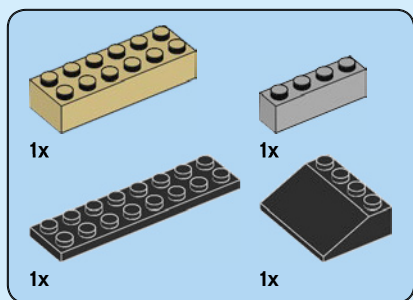

# 10

1

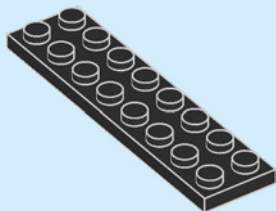

2

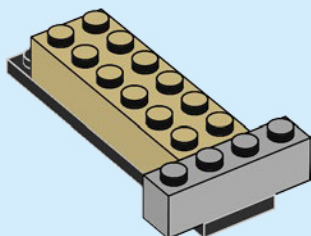



3

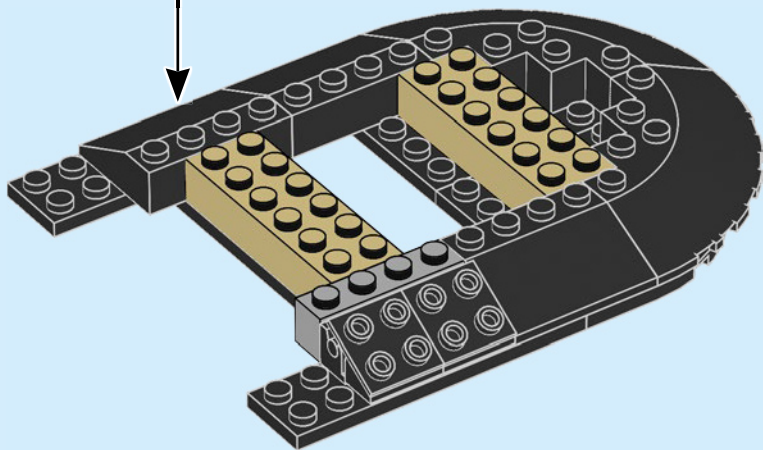
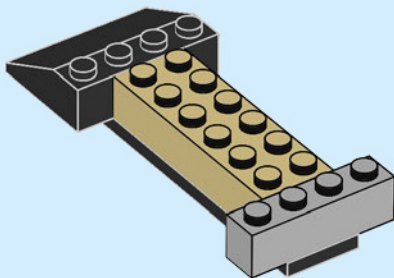

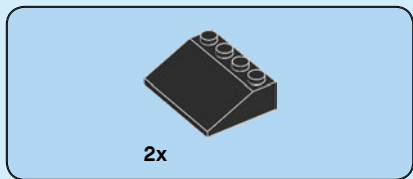

11

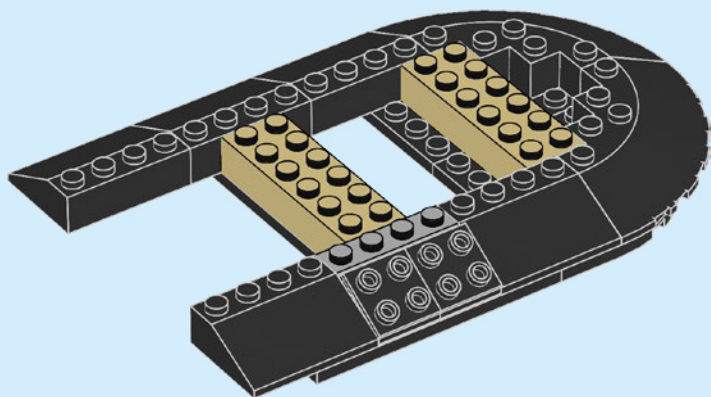

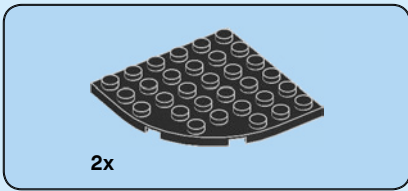

12

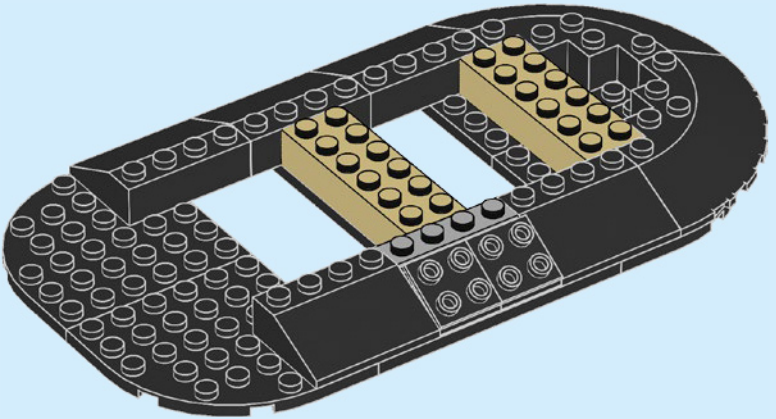

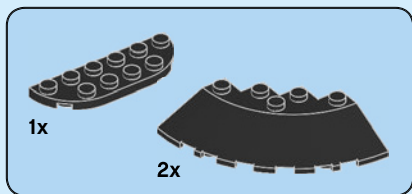

# 13

1

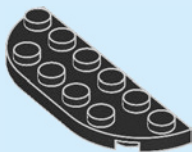

2

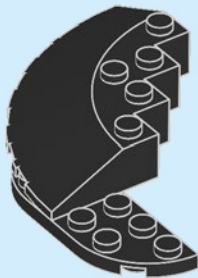

**3**

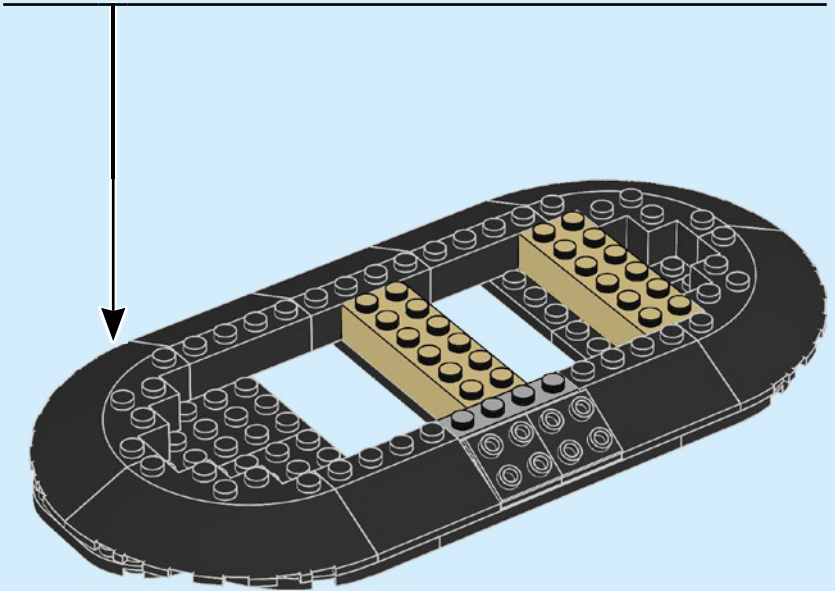
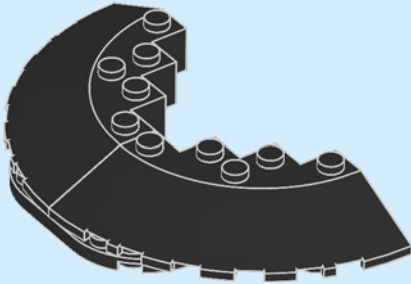

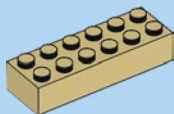

1x

14

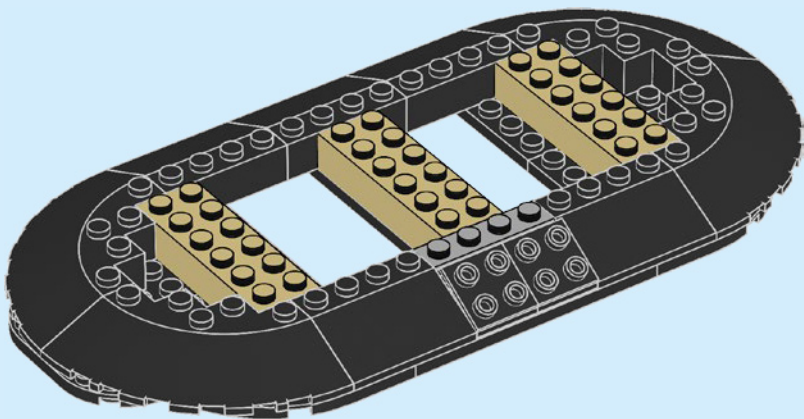

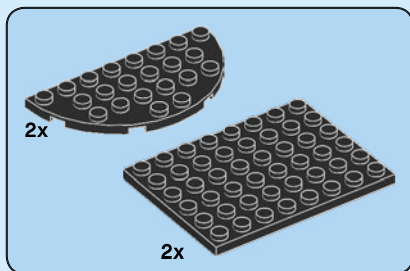

15

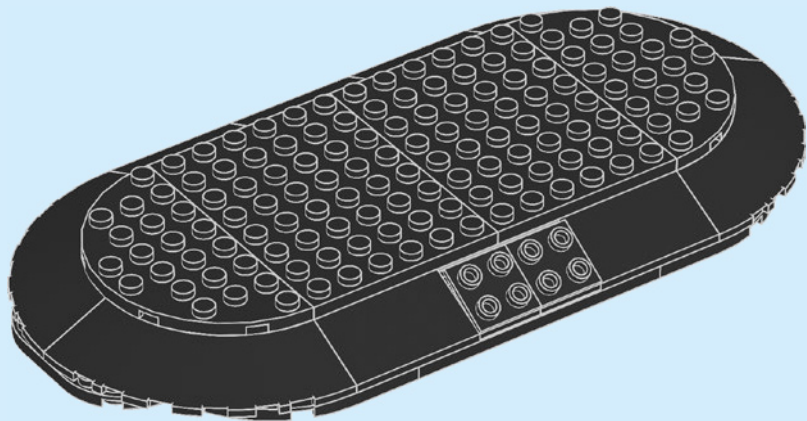

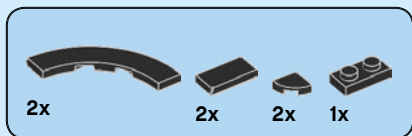

16

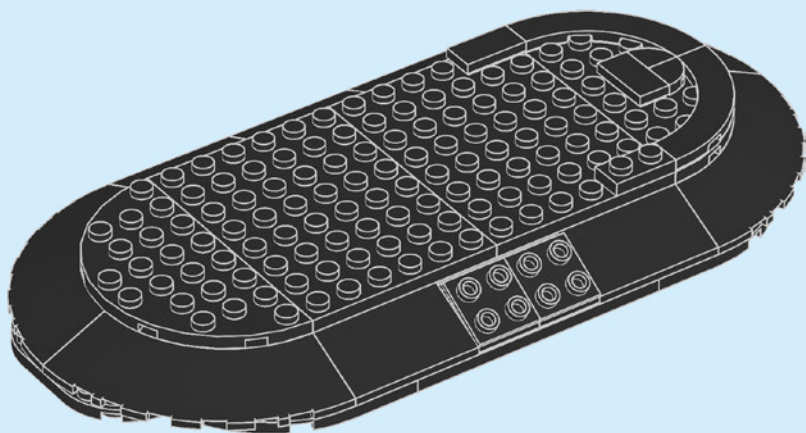



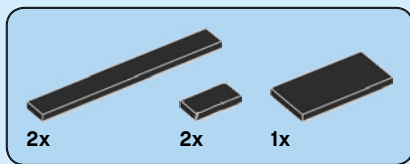

17

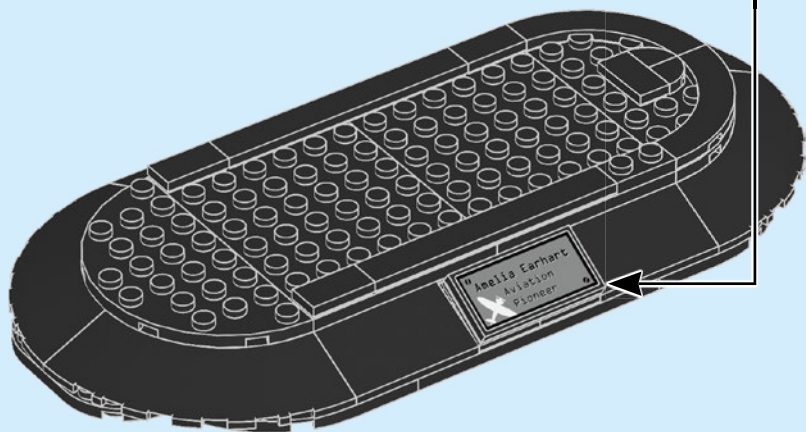
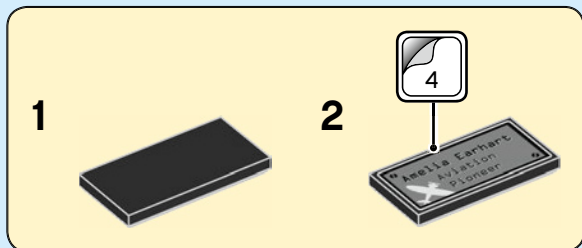

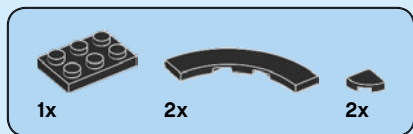

18

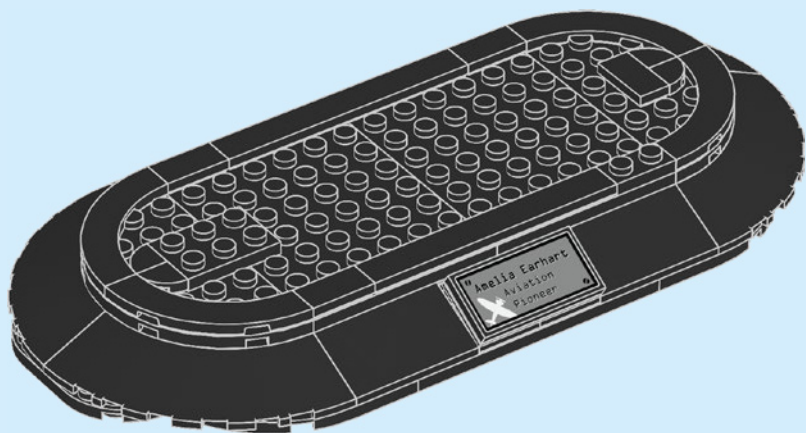

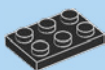

1x

# 19

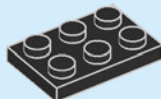

2x

# 20

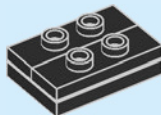



2x

21

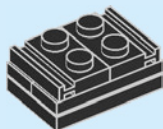

2x

22

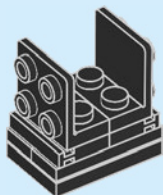

1x

23

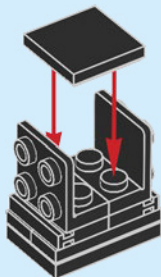

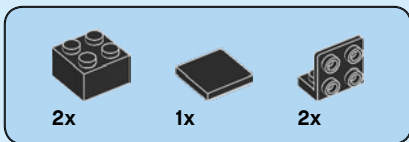

# 24

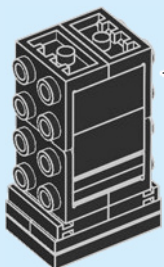
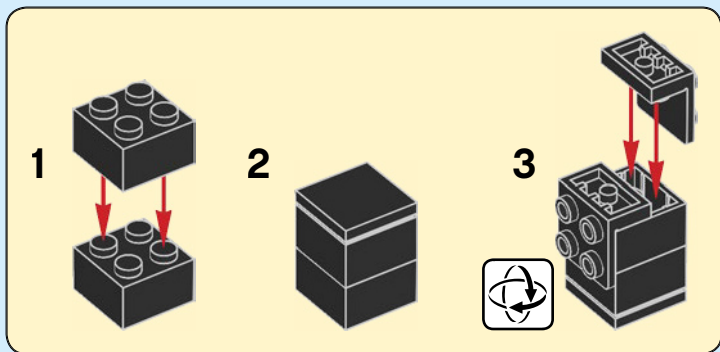

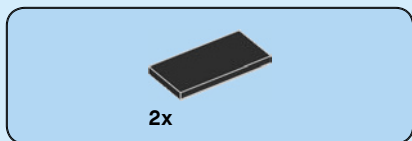

25

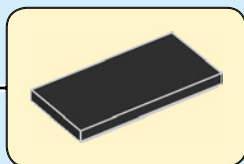
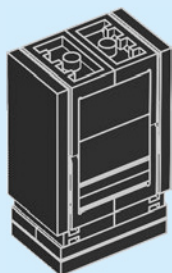

26

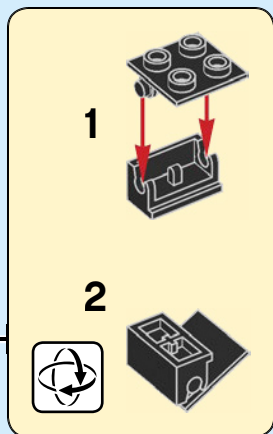

27

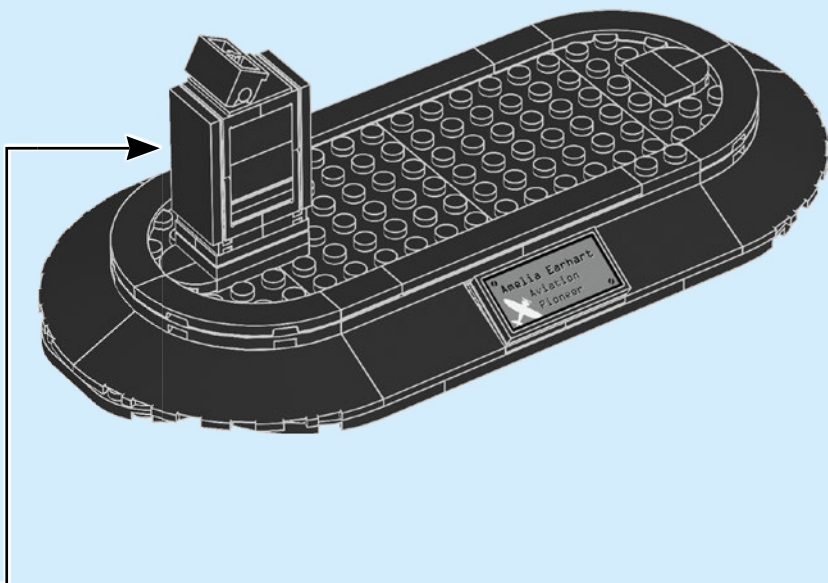

# 28

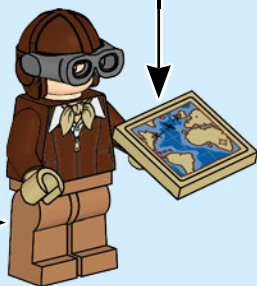
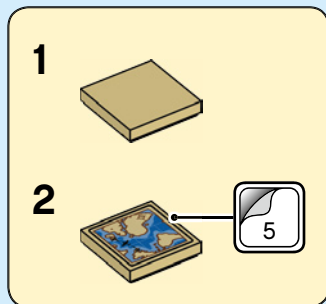
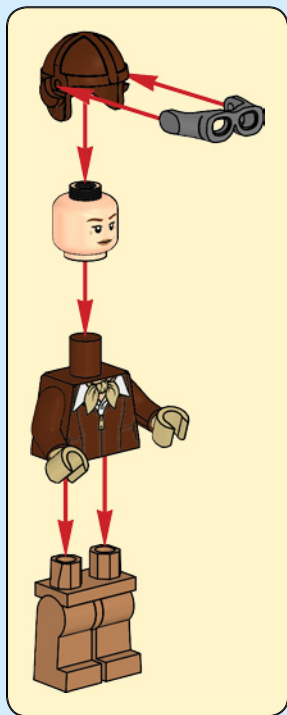



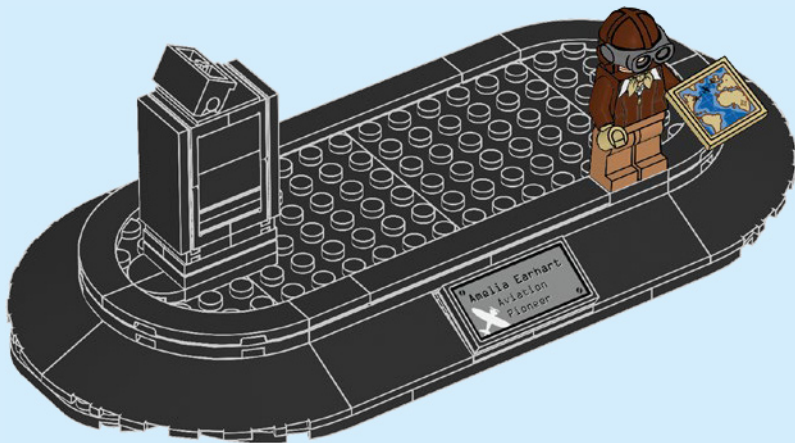

30

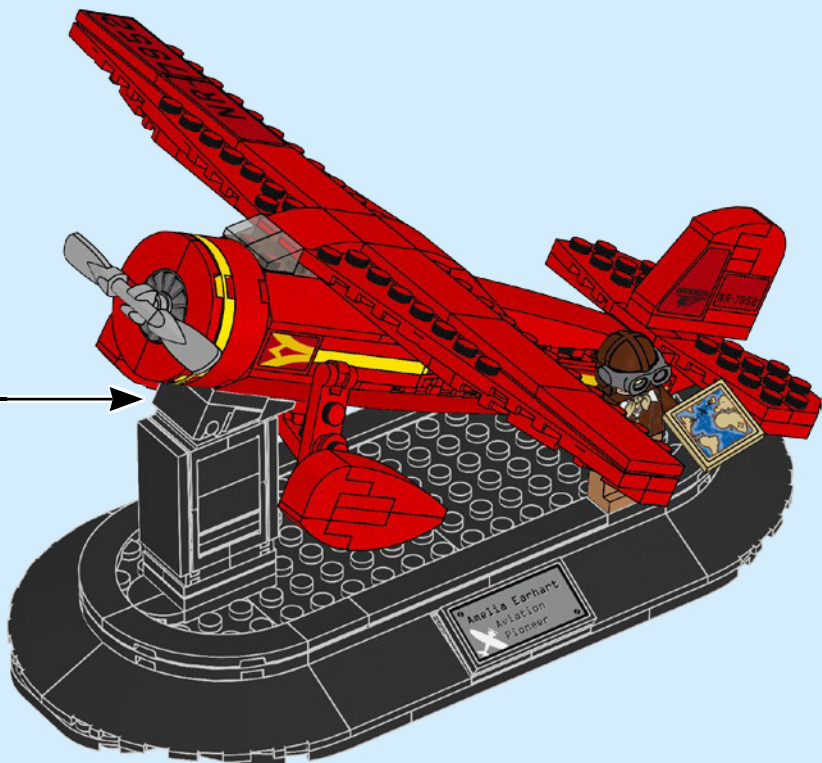



4x  
61224811



2x  
306901



1x  
4185177



2x  
6119197



3x  
302224



2x  
371024



1x  
4515349



1x  
6275404



1x  
4515371



4x  
6286215



3x  
6184782



1x  
6029946



2x  
6001806



2x  
6089698



2x  
4556153



1x  
306821



1x  
6105976



4x  
6310198



4x  
362321



1x  
6132210



1x  
4500462



3x  
371021



2x  
6057432



2x  
6045937



1x  
4610843



6x  
4560179



2x  
6275399



2x  
366621



2x  
4113858



4x  
379521

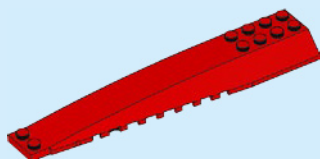

2x  
6287507

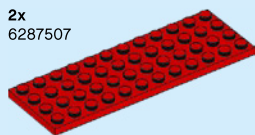

1x  
4514717



1x  
383221



1x  
447721



2x  
4161329



2x  
4160866



1x  
6170834



1x  
6170832



1x  
6054536



1x  
6054538



2x  
614121



2x  
6348058



2x  
302421



2x  
6335377



6x  
6173961



3x  
6092565



2x  
6186398



3x  
300421



9x  
302321

4x  
6172383

4x  
4548180

4x  
306926

3x  
393726

1x  
302326

4x  
6000650

2x  
4107761

1x  
302226

2x  
306826

3x  
4124096

2x  
300326

2x  
6199908

2x  
302126

3x  
4560182

5x  
329726

4x  
6171264

2x  
416226

2x  
6133200

3x  
303426

4x  
6337391

4x  
6137779

2x  
303626

2x  
6105963

3x  
4181134

2x  
379523

2x  
302128

1x  
6262262

2x  
6245263

1x  
6240219

1x  
4527943

1x  
4507049

1x  
6338706

2x  
4654580

1x  
6093527

2x  
6337380

1x  
6123809

1x  
6278156

1x  
4211483

1x  
4211394

1x  
6117346

1x  
6170695

1x  
6338710



Customer Service

Kundenservice

Service Consommateurs

Servicio Al Consumidor

LEGO.com/service or dial



00800 5346 5555 :

1-800-422-5346 :

LEGO and the LEGO logo are trademarks of the sort des marques de commerce de/son marcas registradas de LEGO Group. ©2021 The LEGO Group. 6355624