



BRICK 'HEADZ

40495



Harry Potter

WIZARDING
WORLD

HERMIONE GRANGER™

140



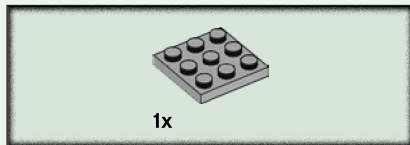
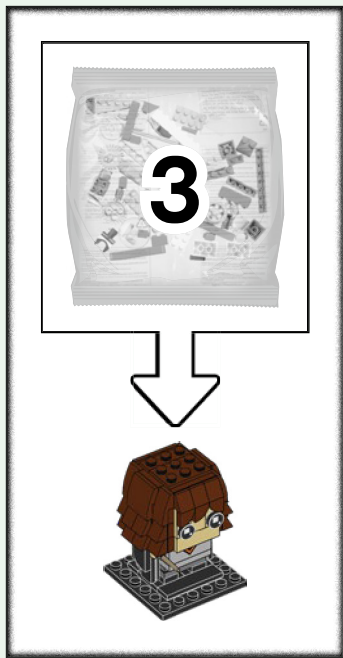

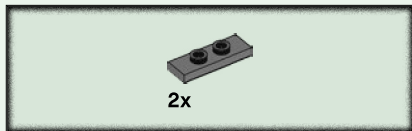

2

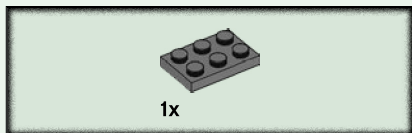
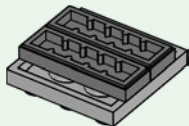

3

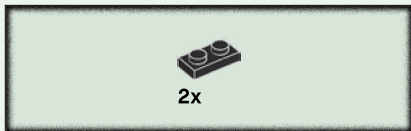
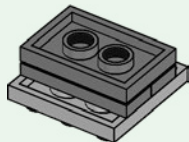

4

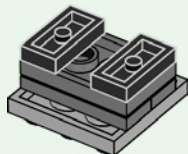

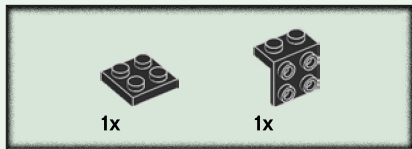

5

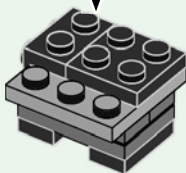
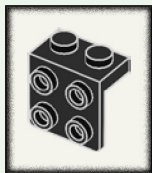

4

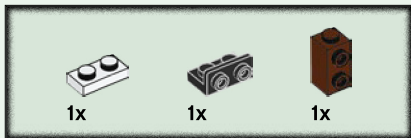

6

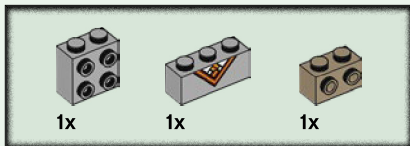
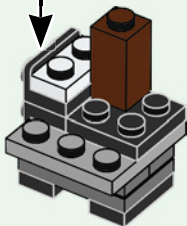
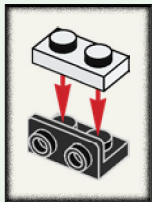

7

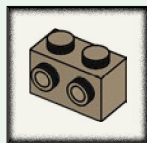

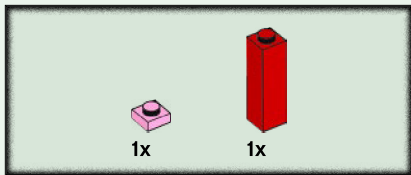

8

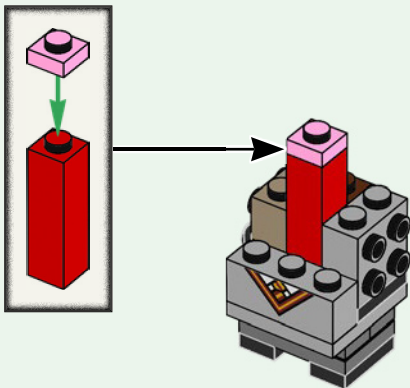

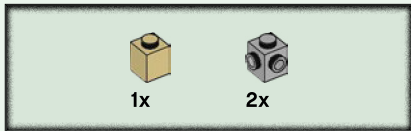

9

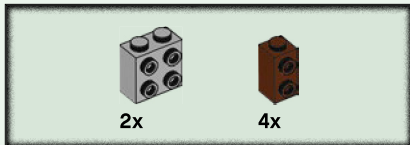
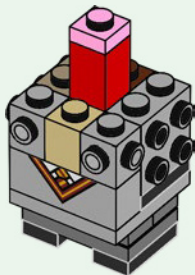

10

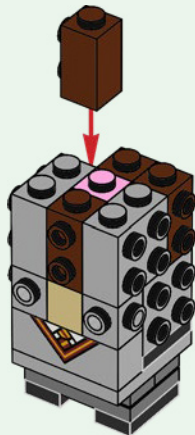

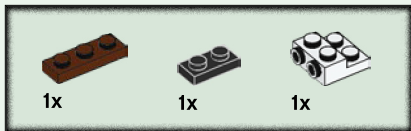

11

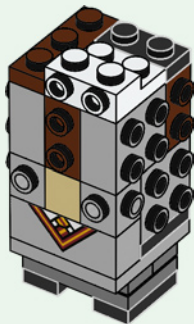

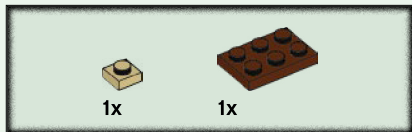

12

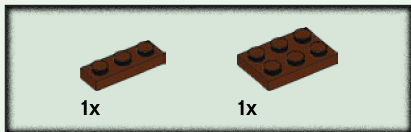
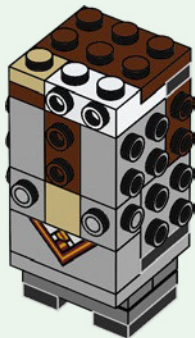

13



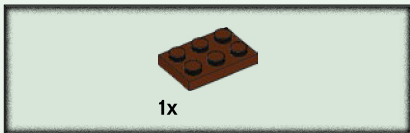

14



10



15

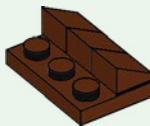

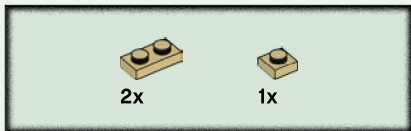

16

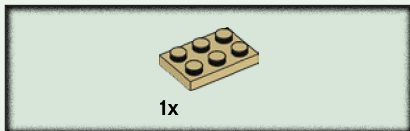
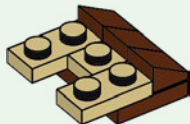

17

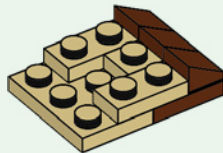

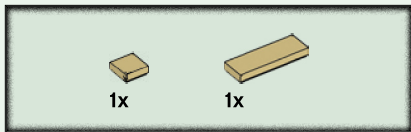

18

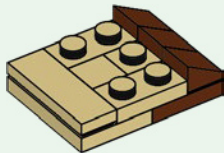

19



20

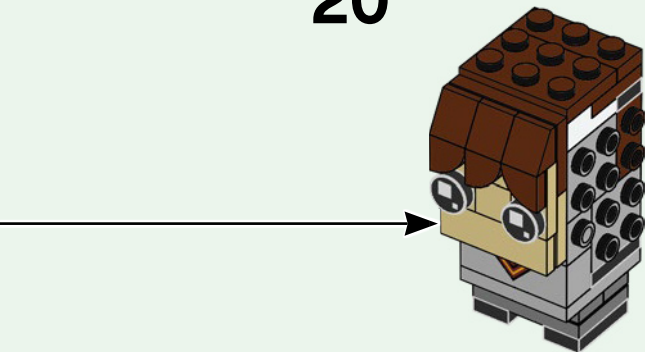

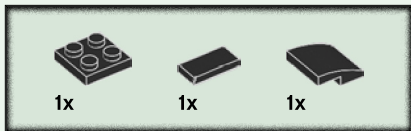

21

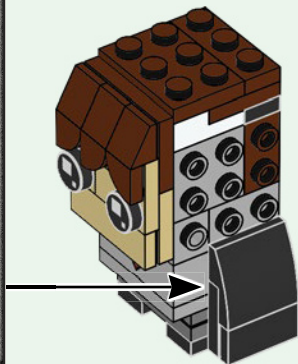
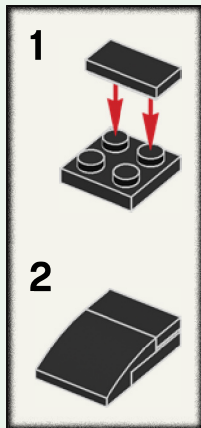

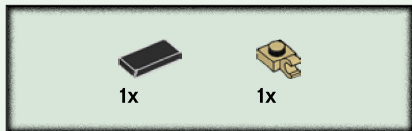

22

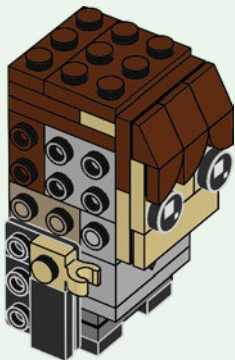

23

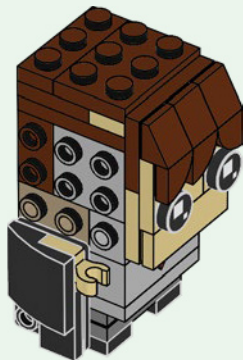

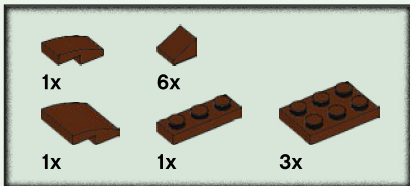

24

1



2

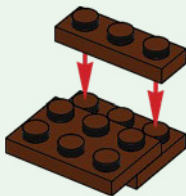

3

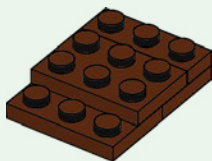

4

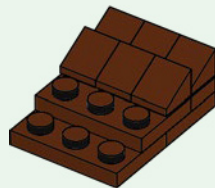

5

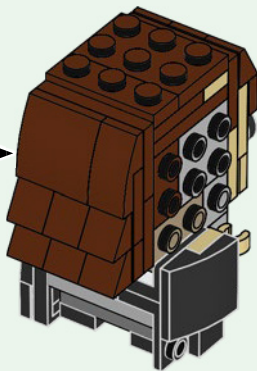
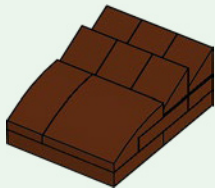

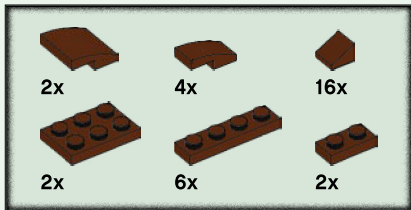

25

1

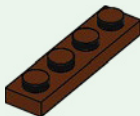

2



3

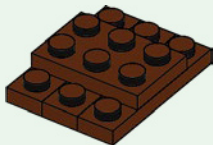

4



5



6



7

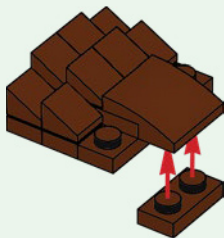

8

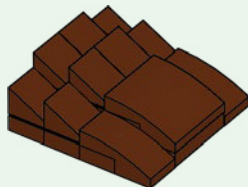

2x

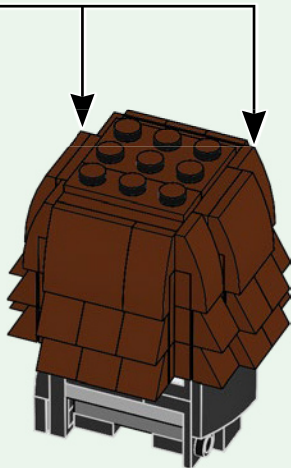

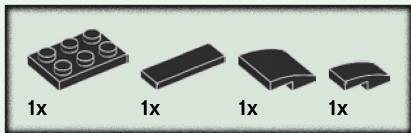

26

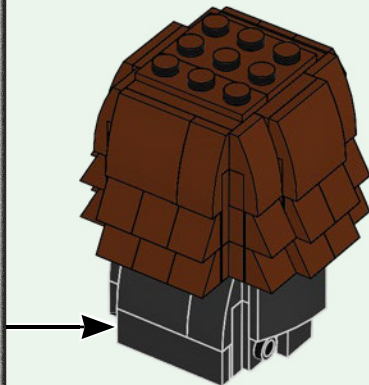
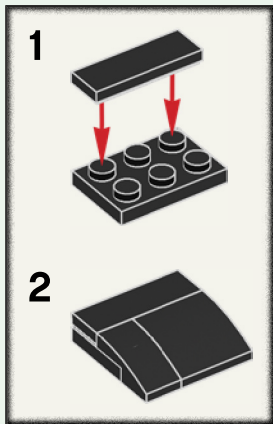

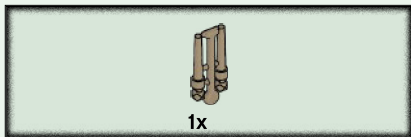

27

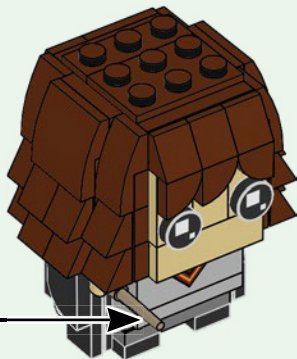

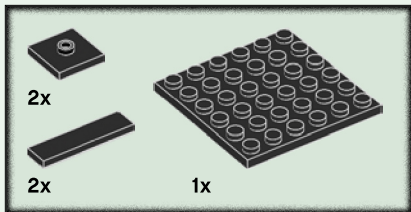

28

1

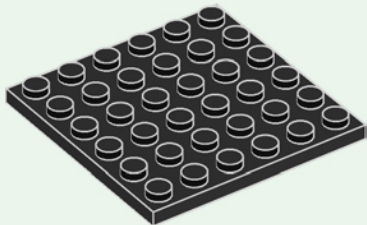

2

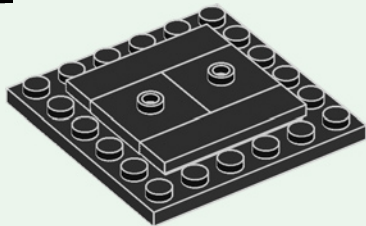

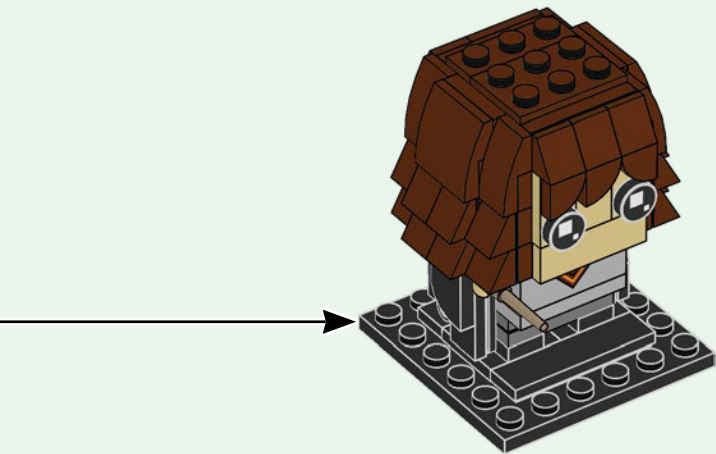



Rebuild
the
world™



LEGO and the LEGO logo are trademarks of the/son des marques de commerce du/son marcas registradas de LEGO Group. ©2021 The LEGO Group. 6373337



WIZARDING WORLD characters, names and related indicia are © & ™ Warner Bros. Entertainment Inc. WB SHIELD: © & ™ WBEI. Publishing Rights © JKR. (s21)