

LEGO SYSTEM™

4970

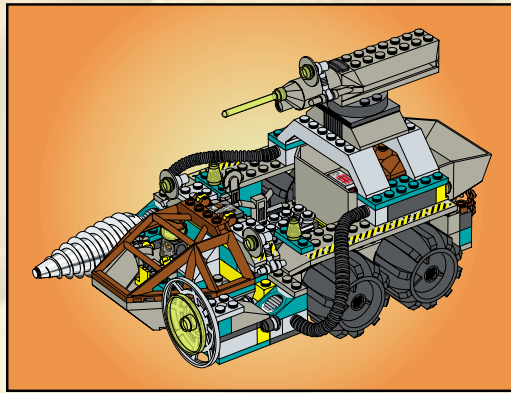

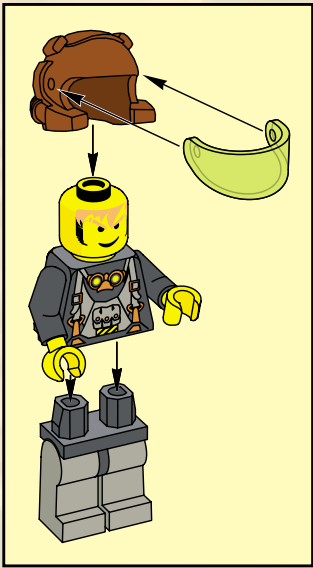

1

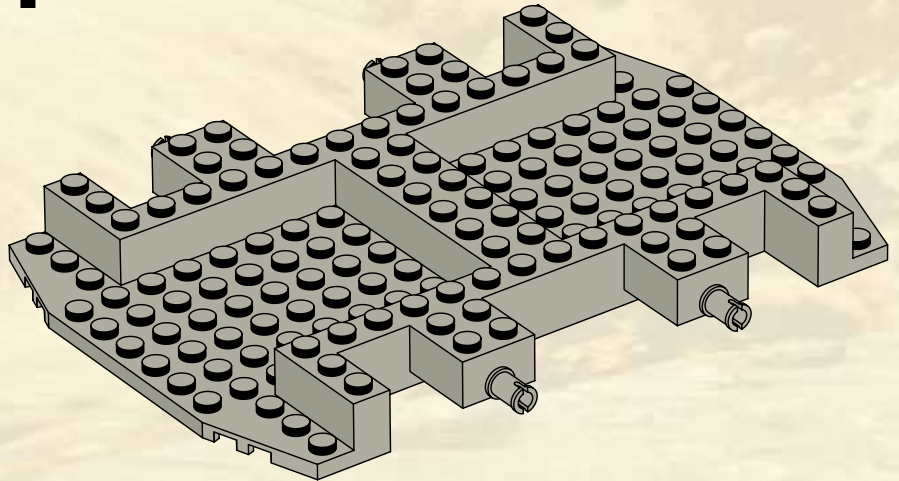

2

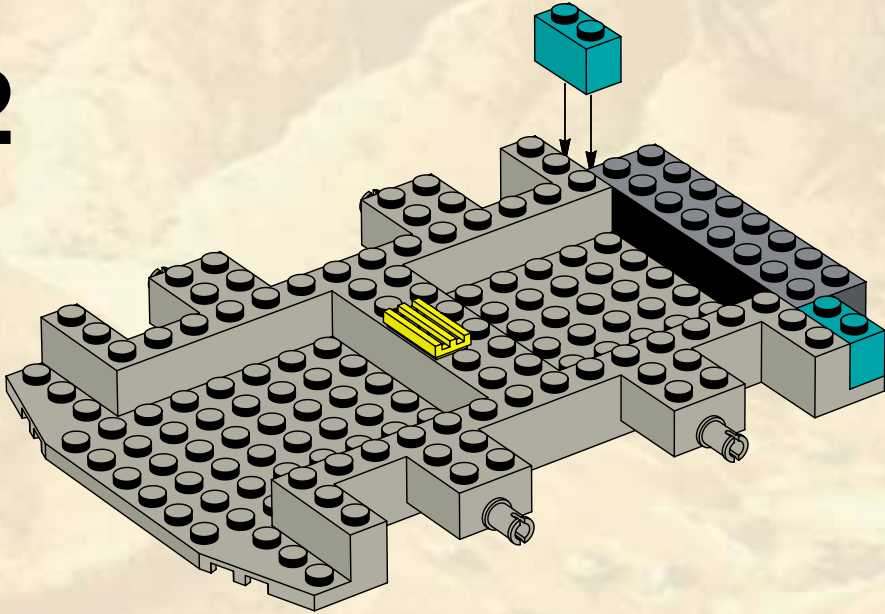

3

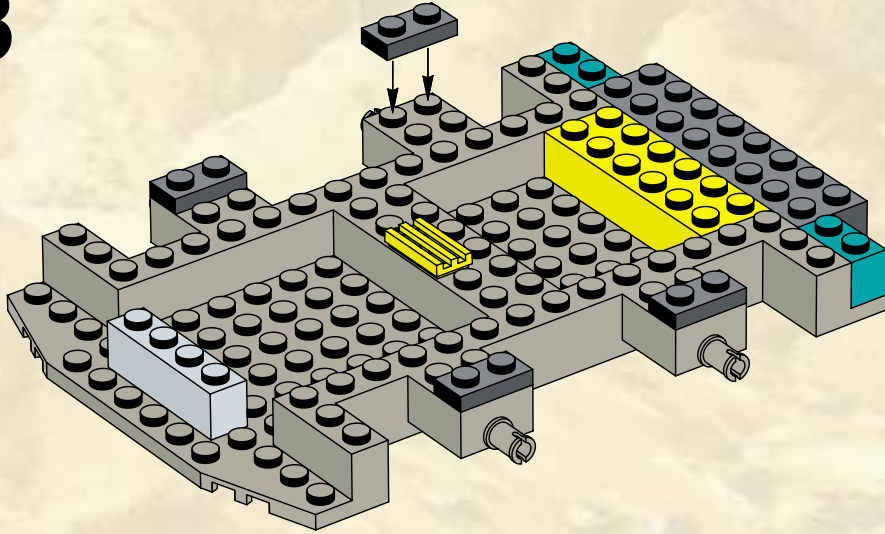

1

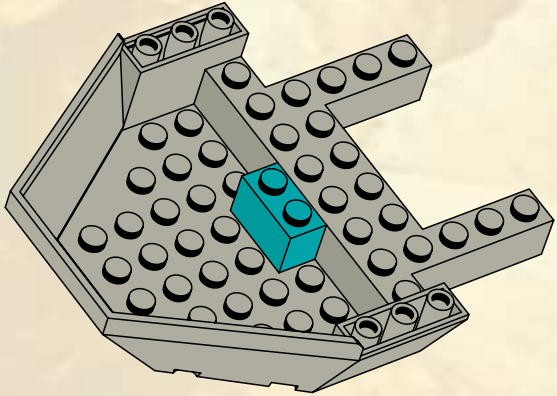

2

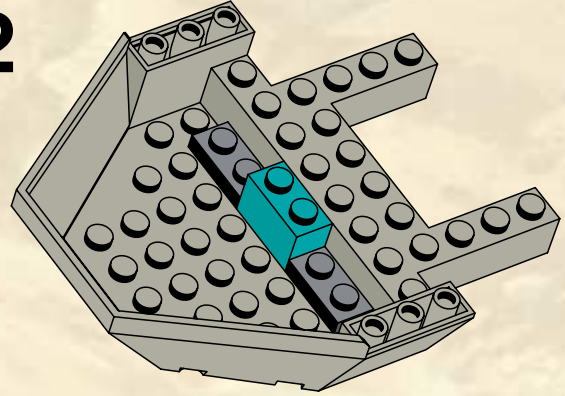

3

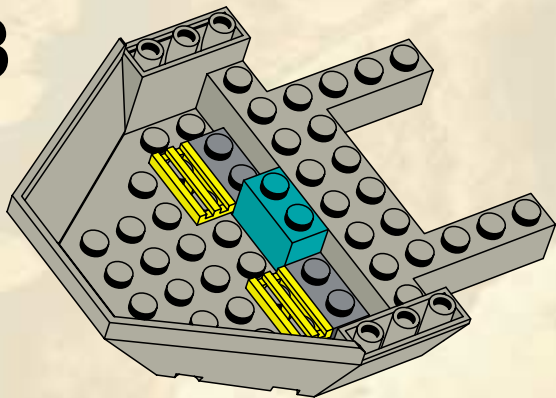

4

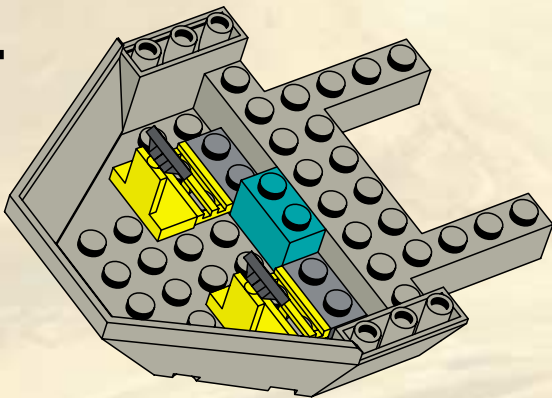

5

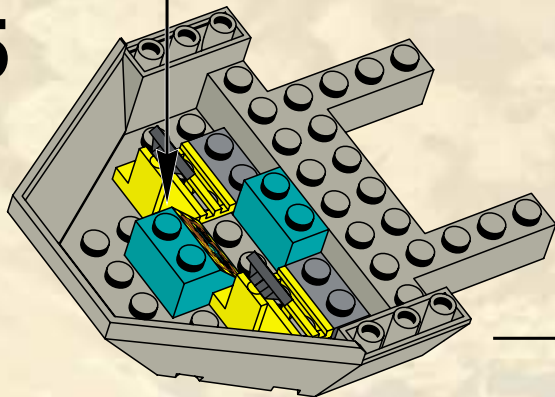
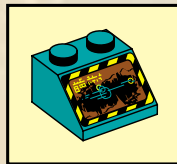

4

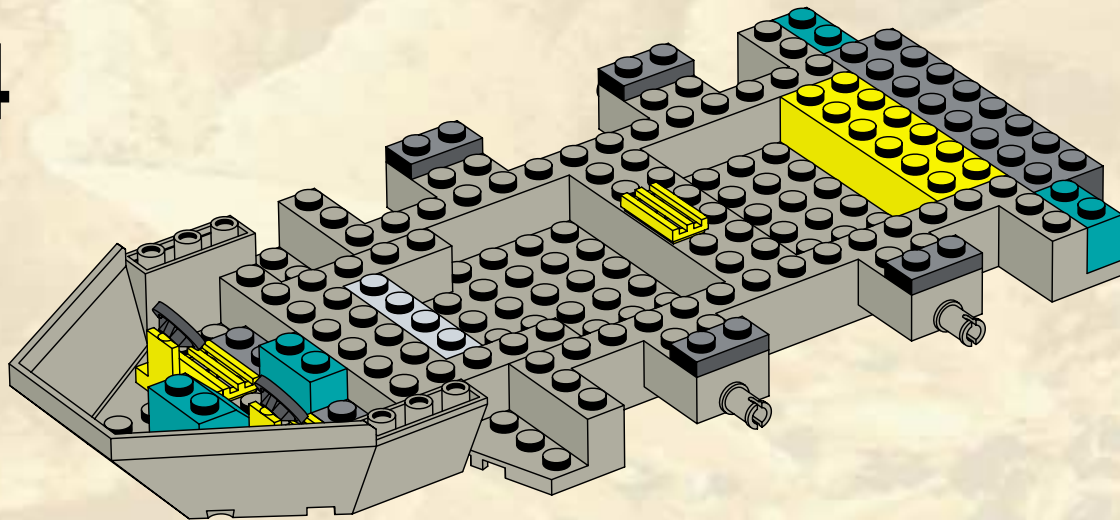

5

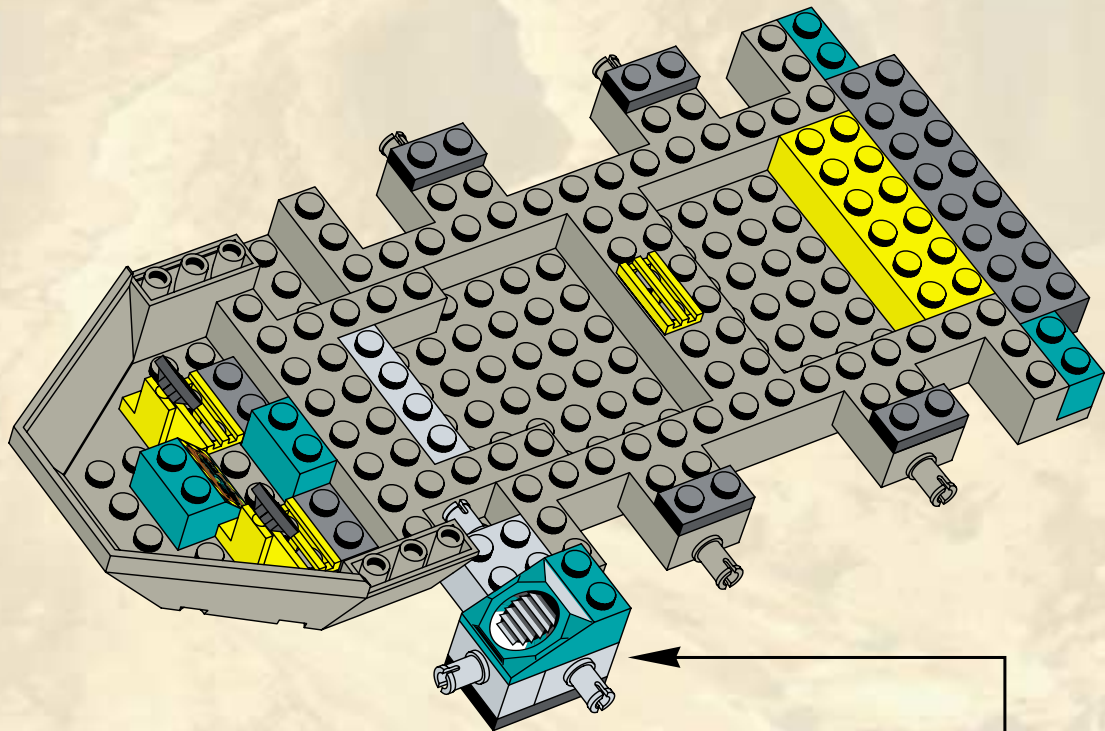

1



2

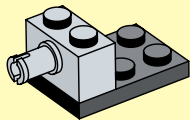

3

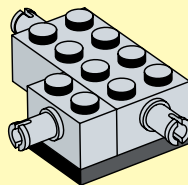

4

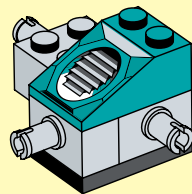

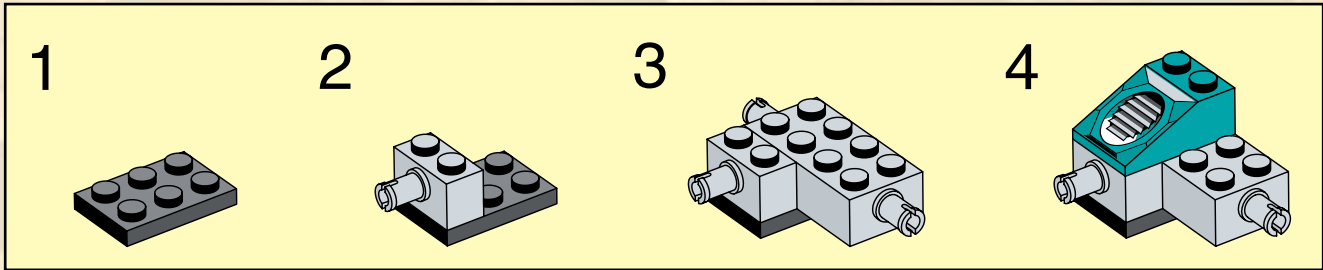

6

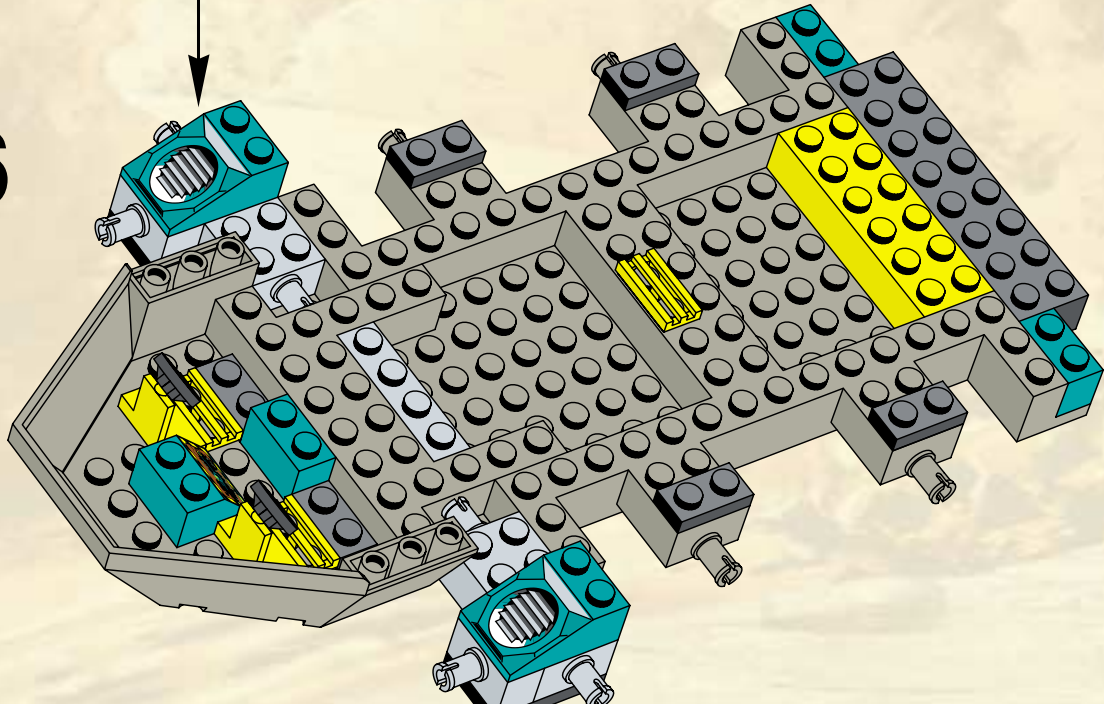

7

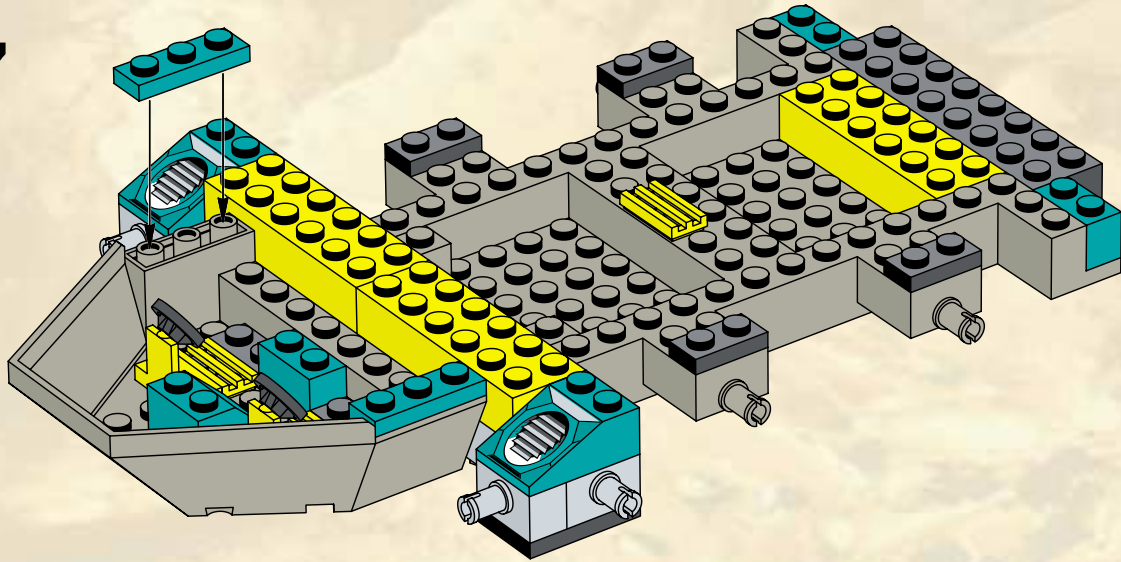

8

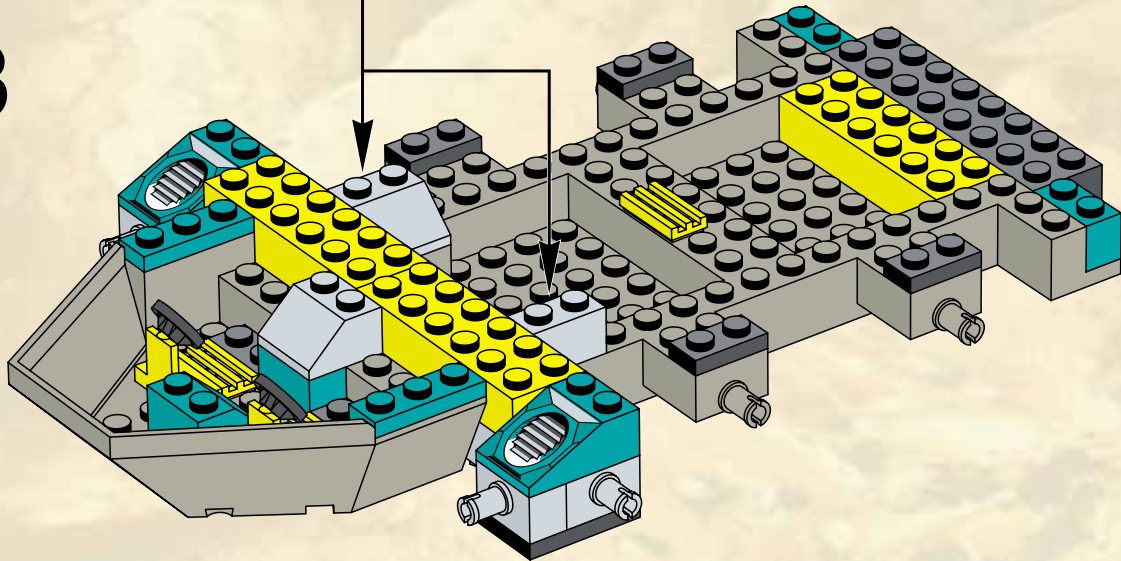
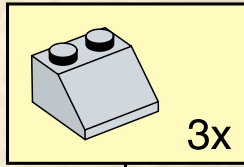

1

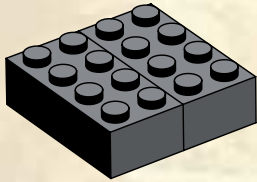

2

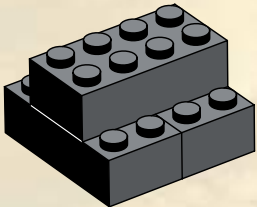

3

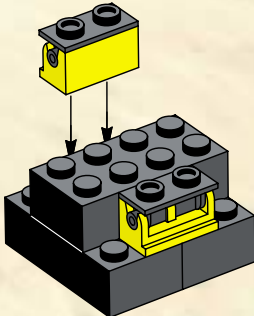
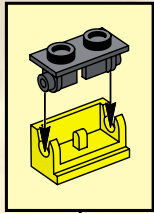

4

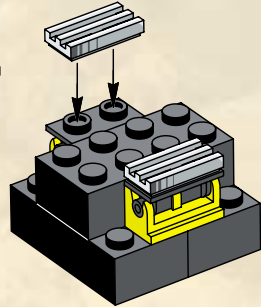

5

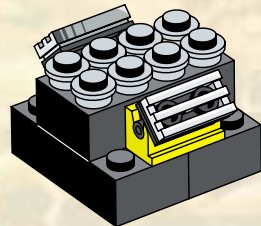

9

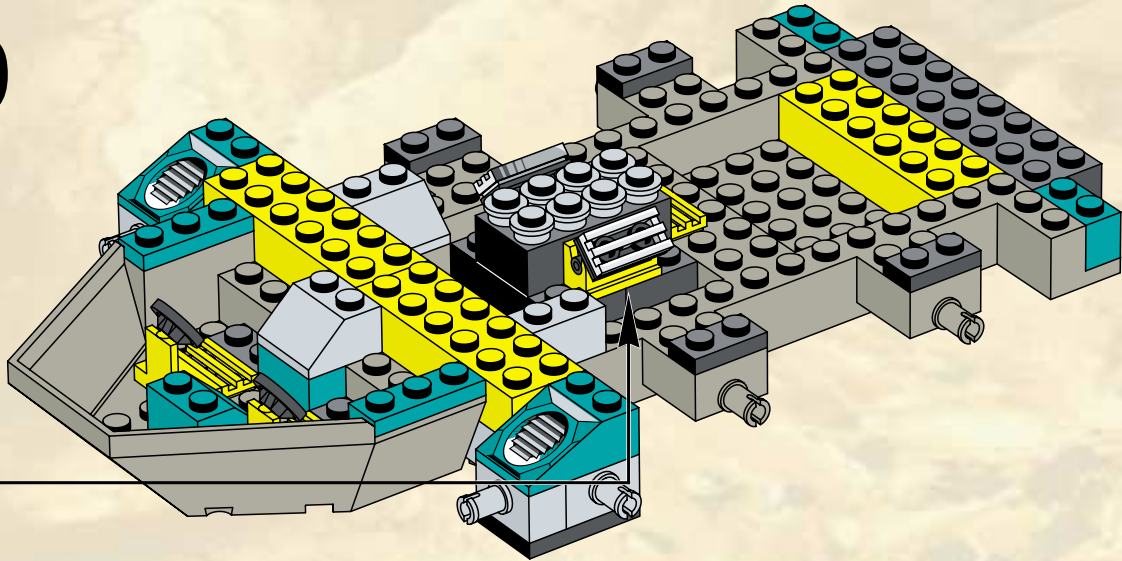

10

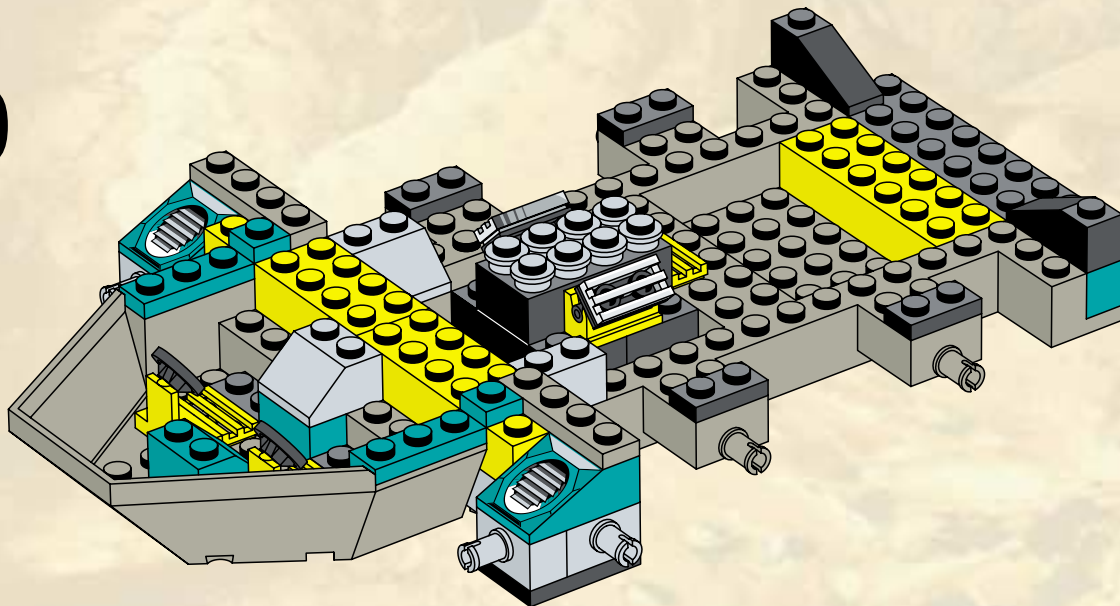

11

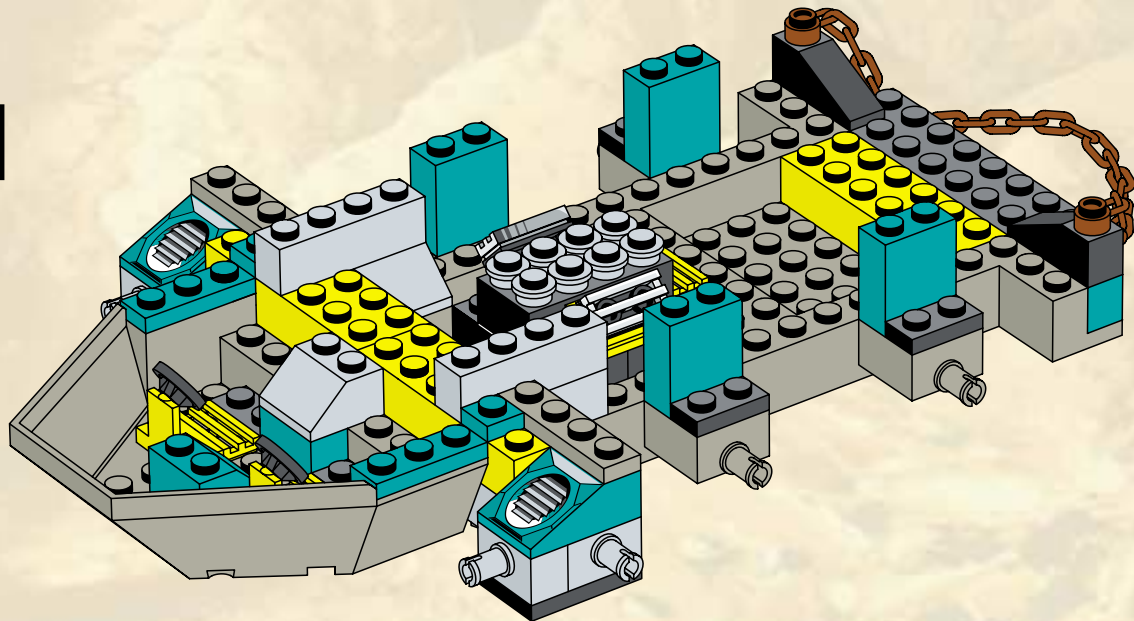

12

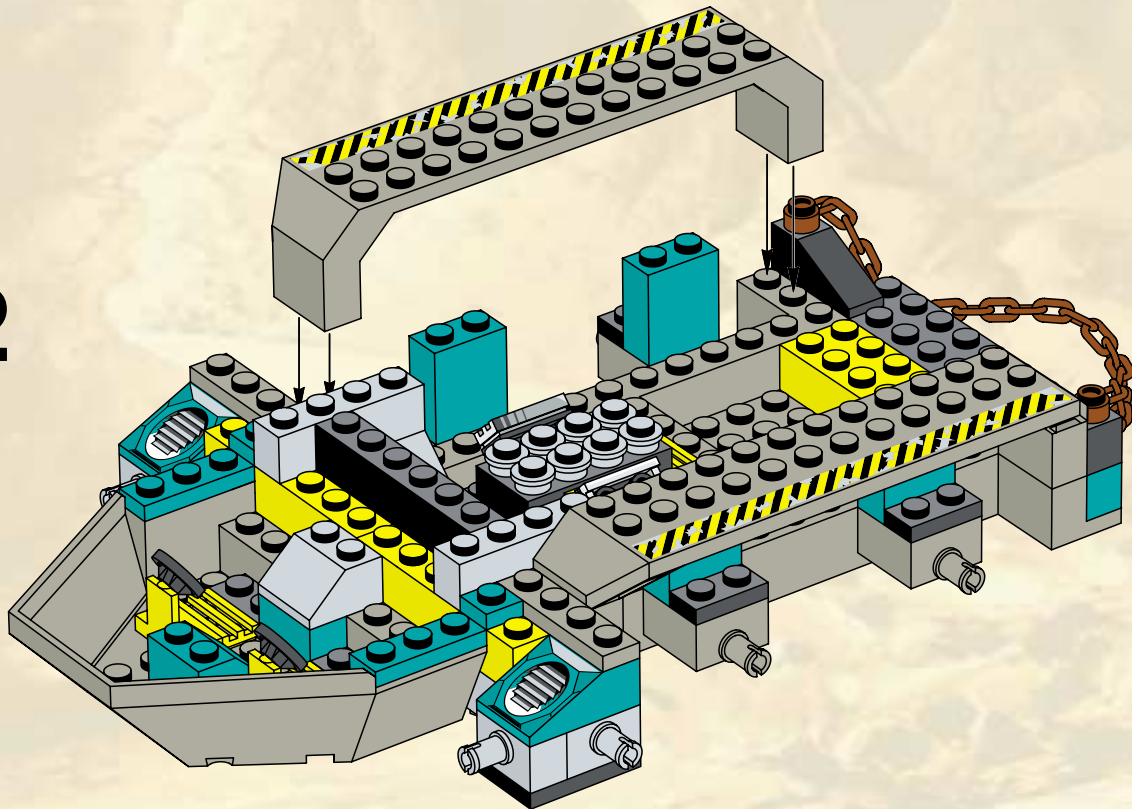

13

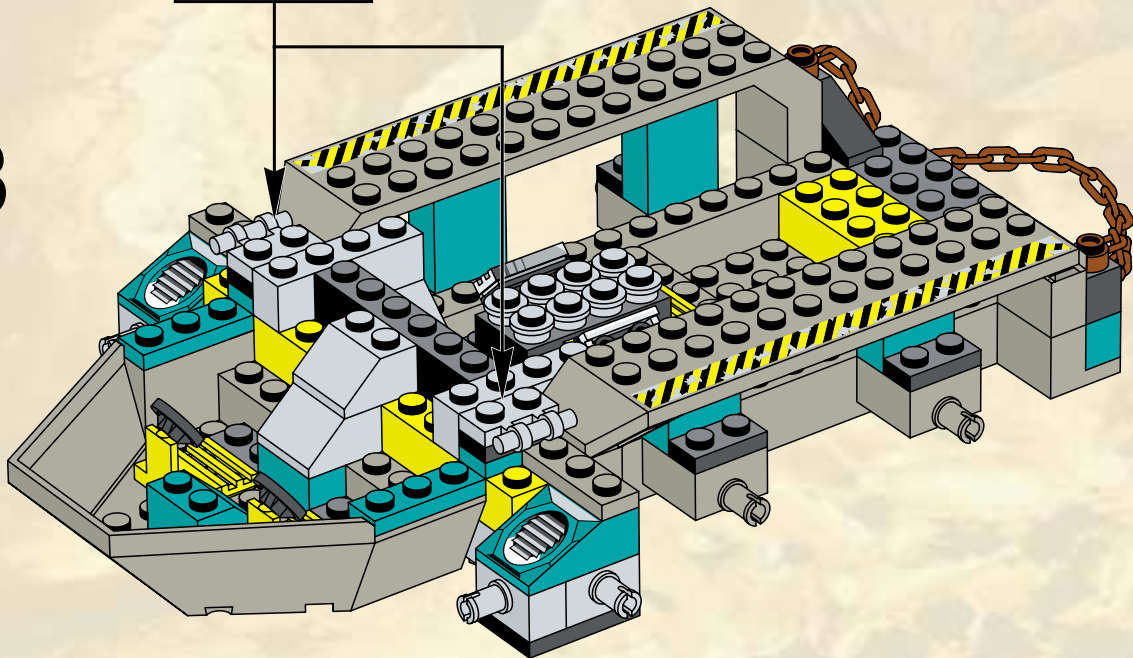
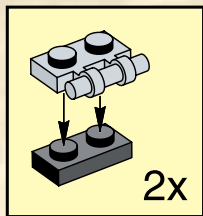

14

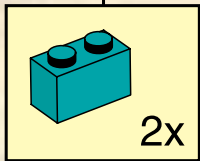
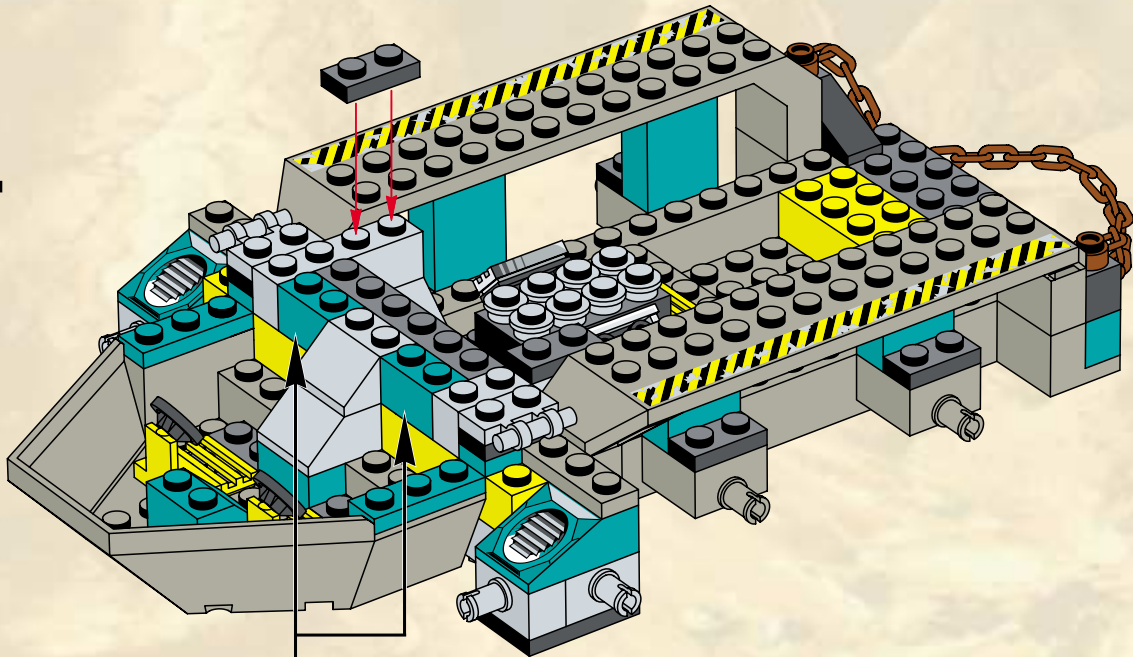

15

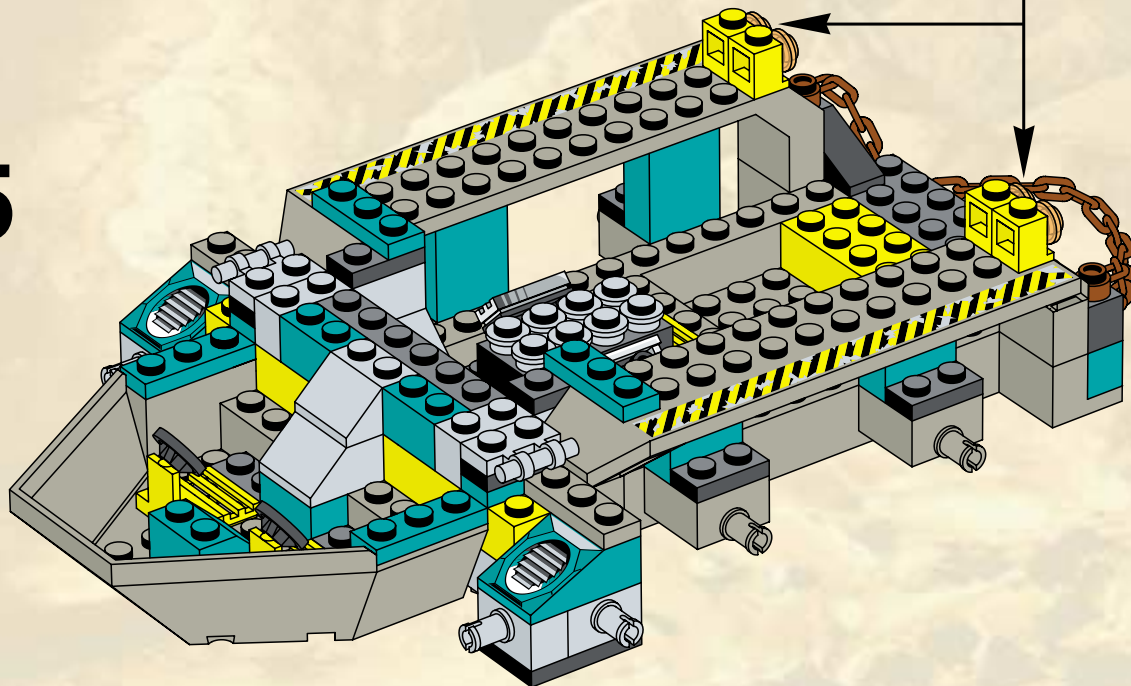

16

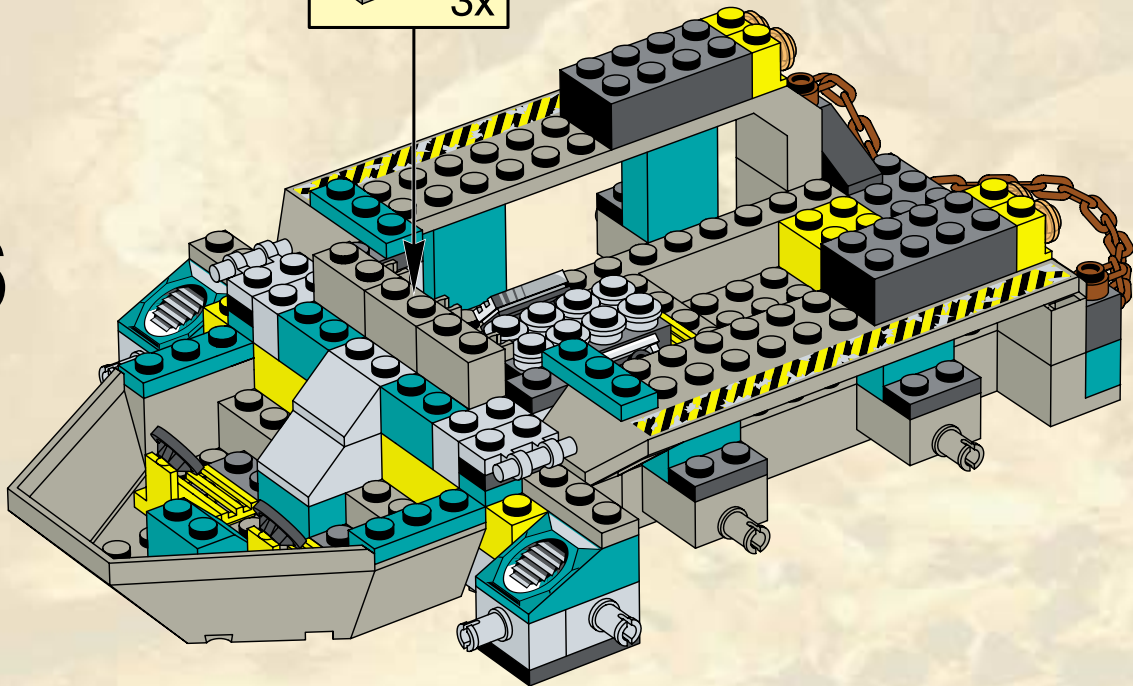
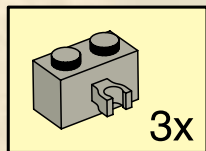

17

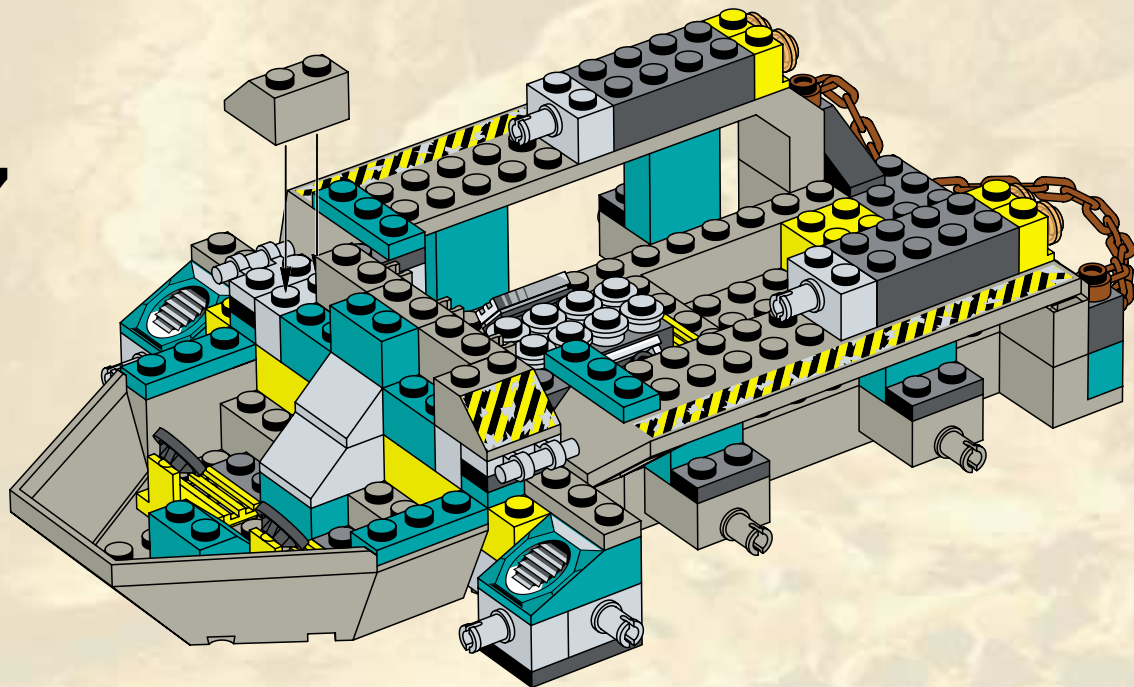

18

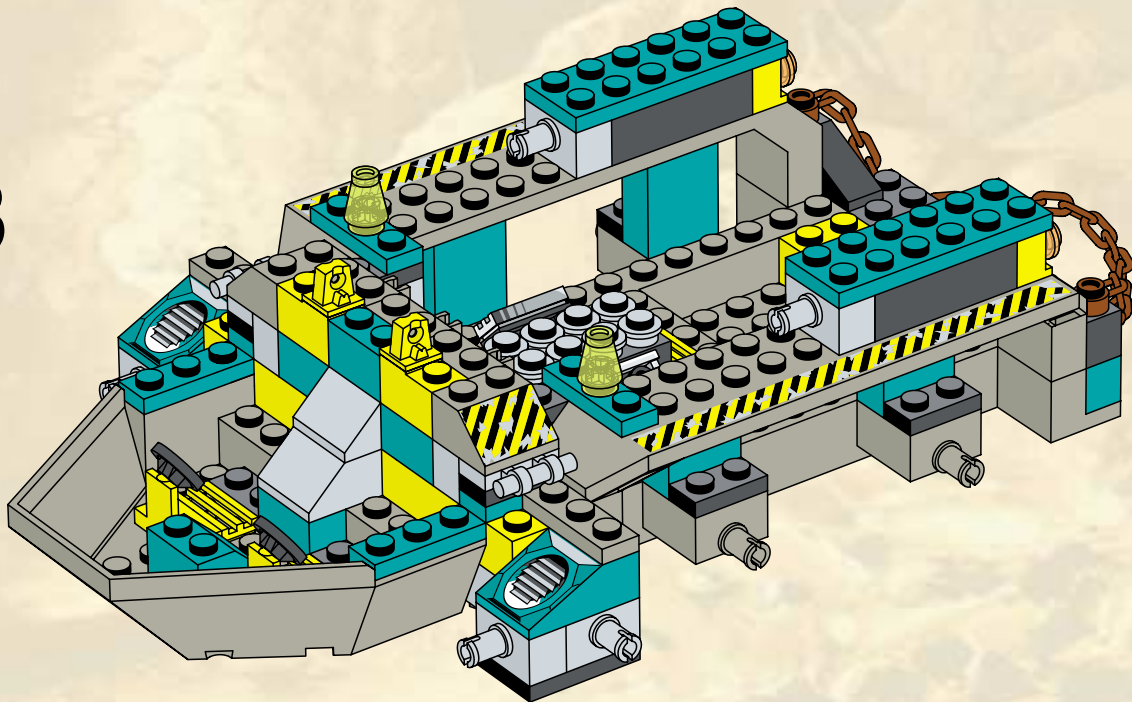

19

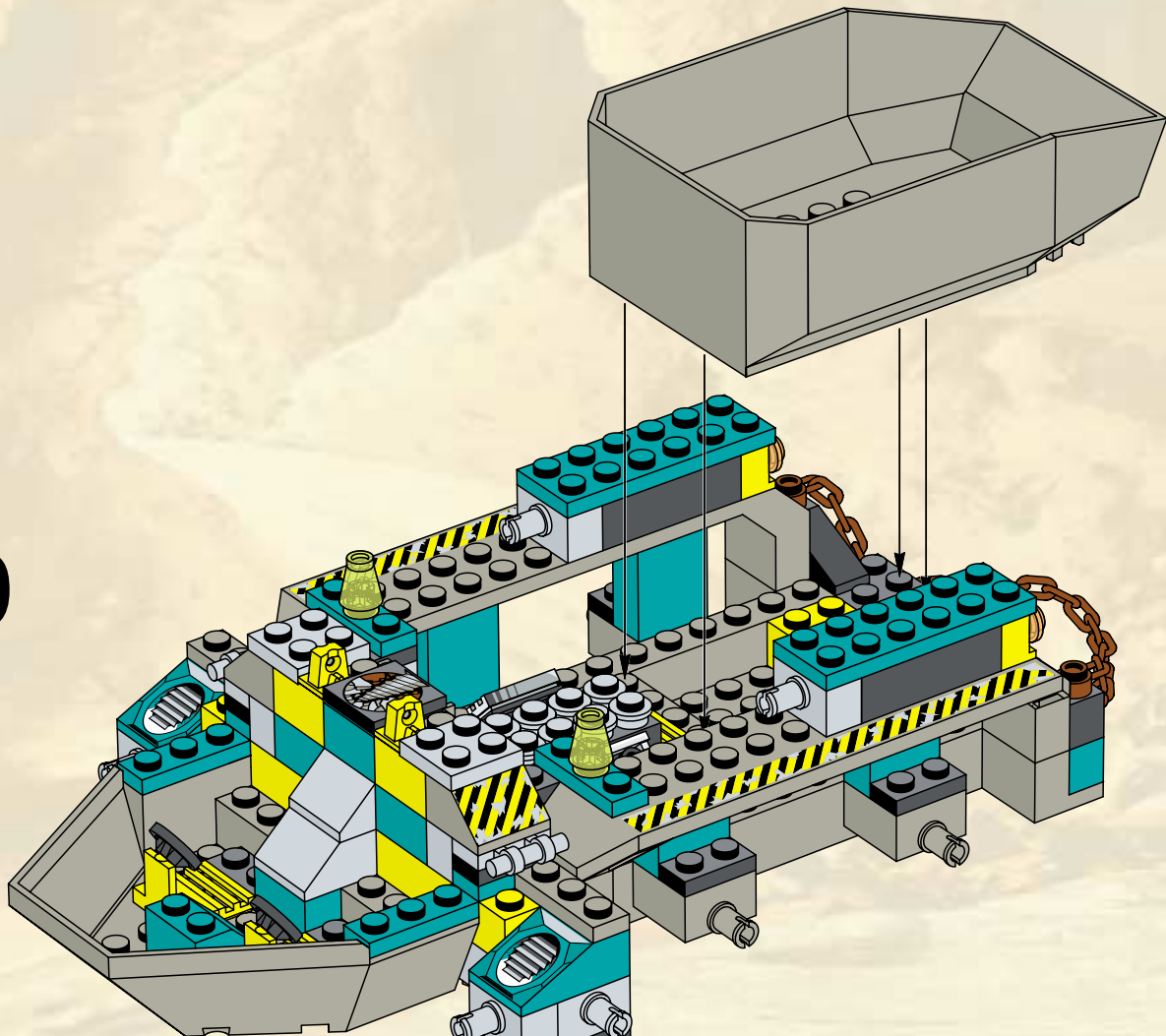

20

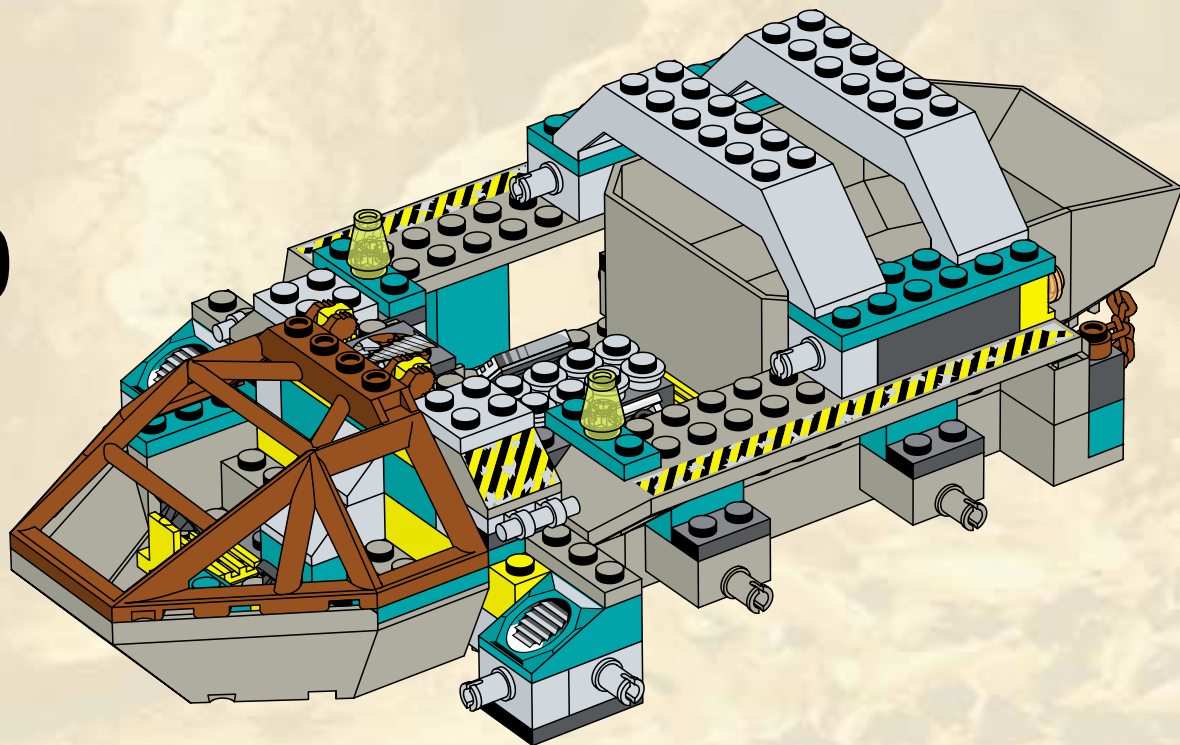

21

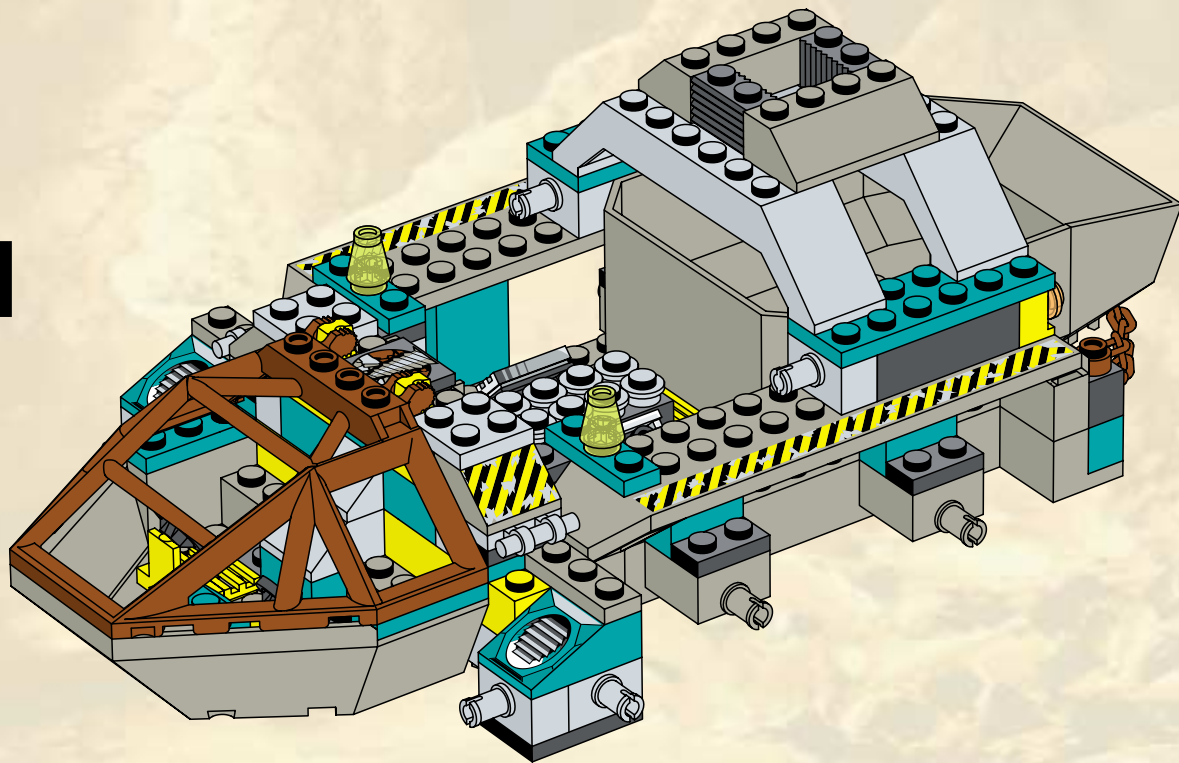

22

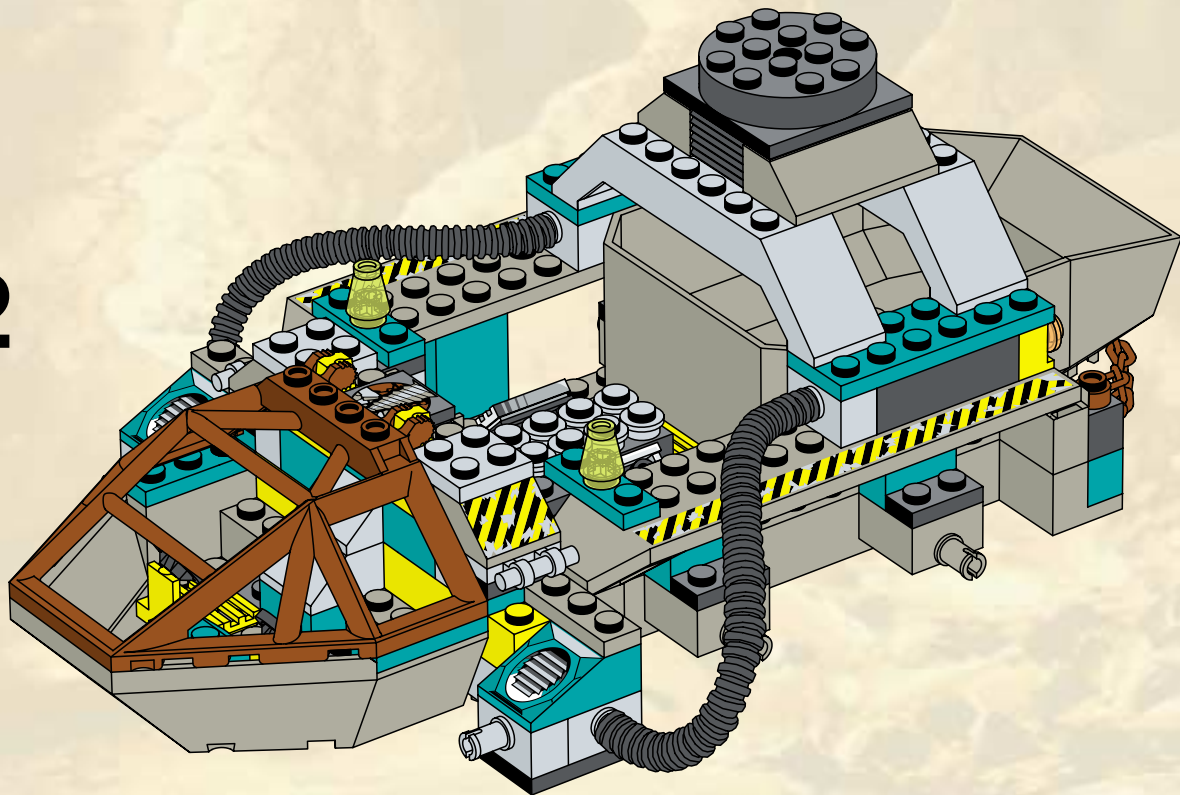

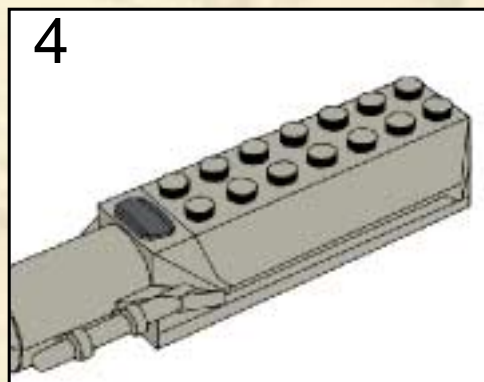
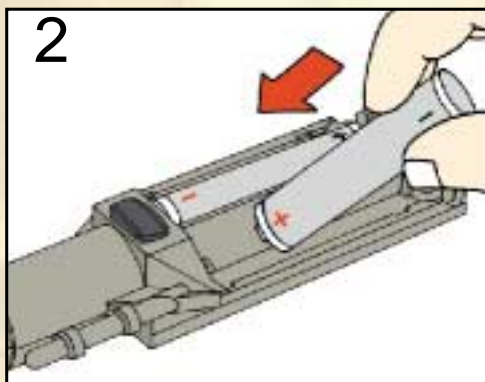
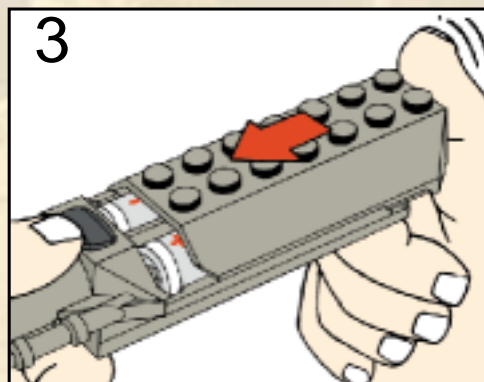
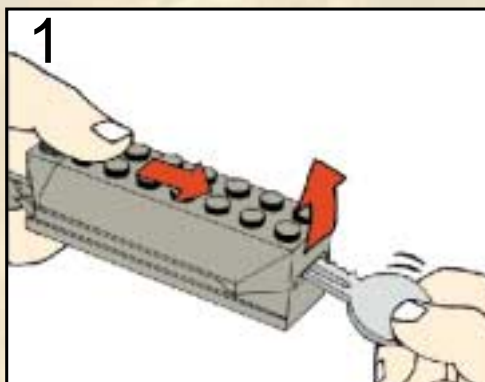

1

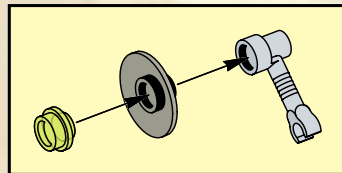
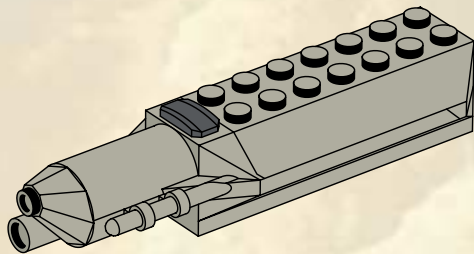

2

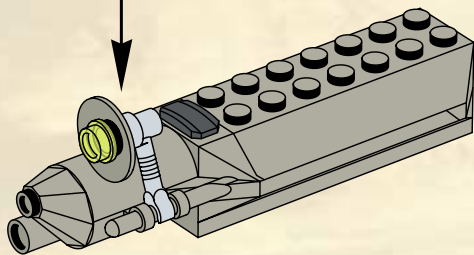

3

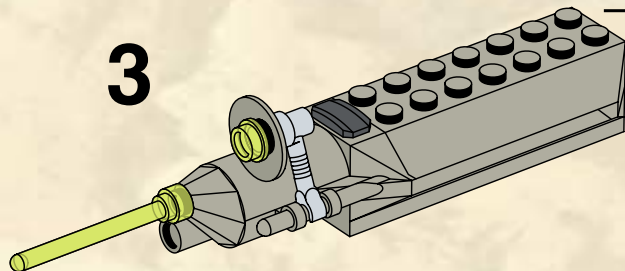

23

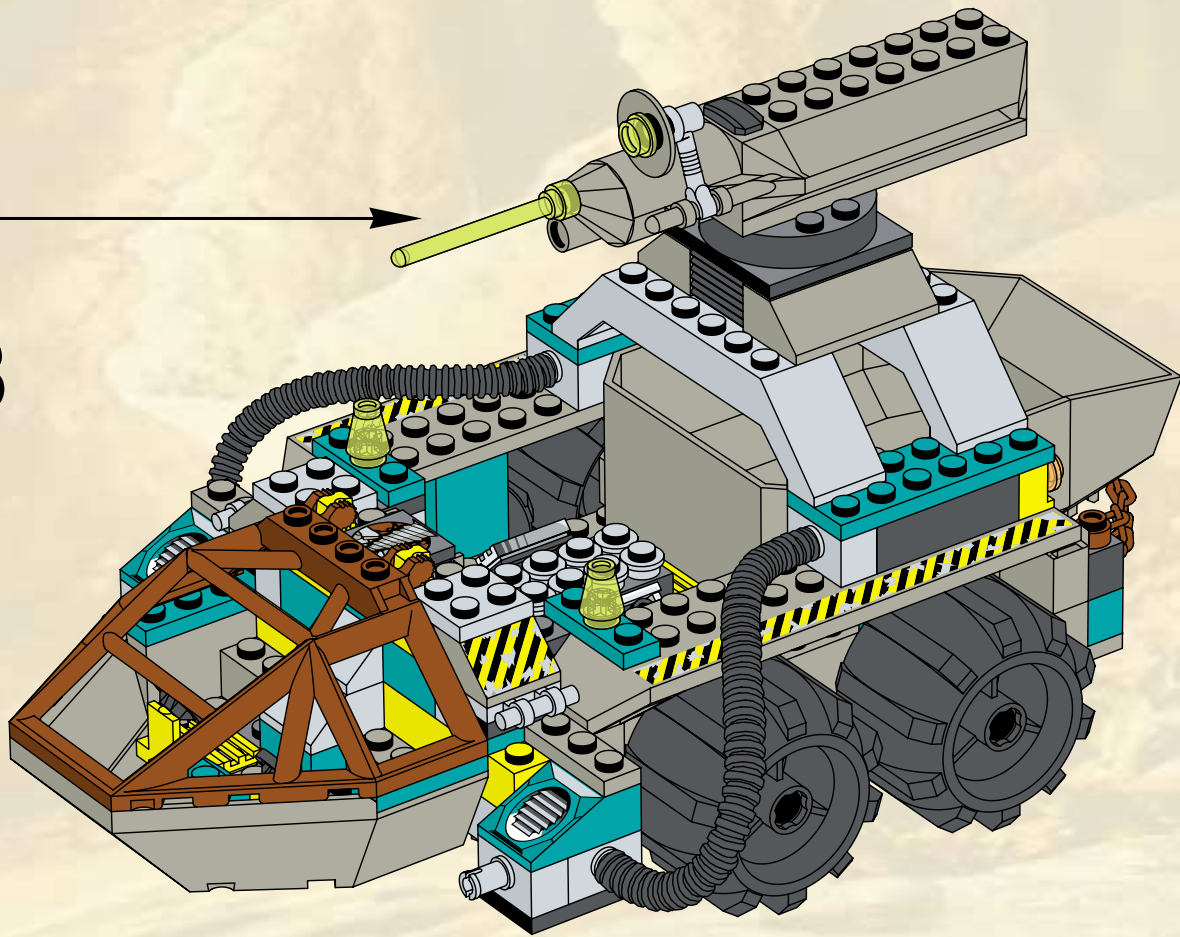

1

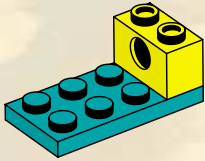

2

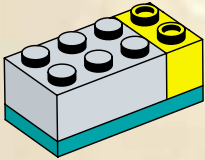

3

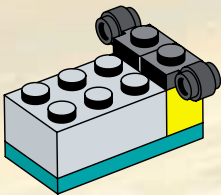

4

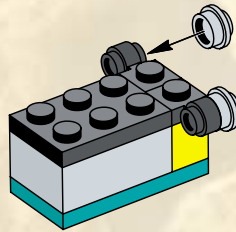

5

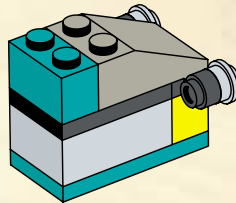

6

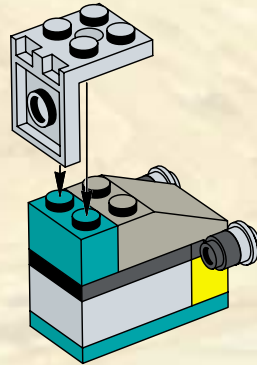

7

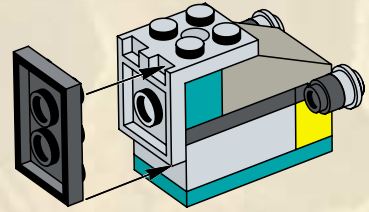

8

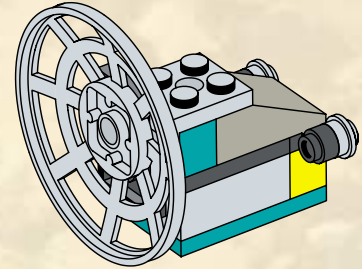

9

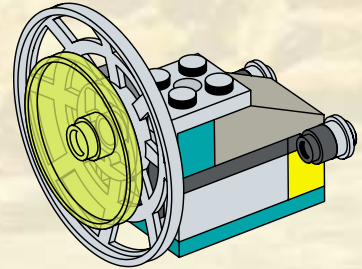

24

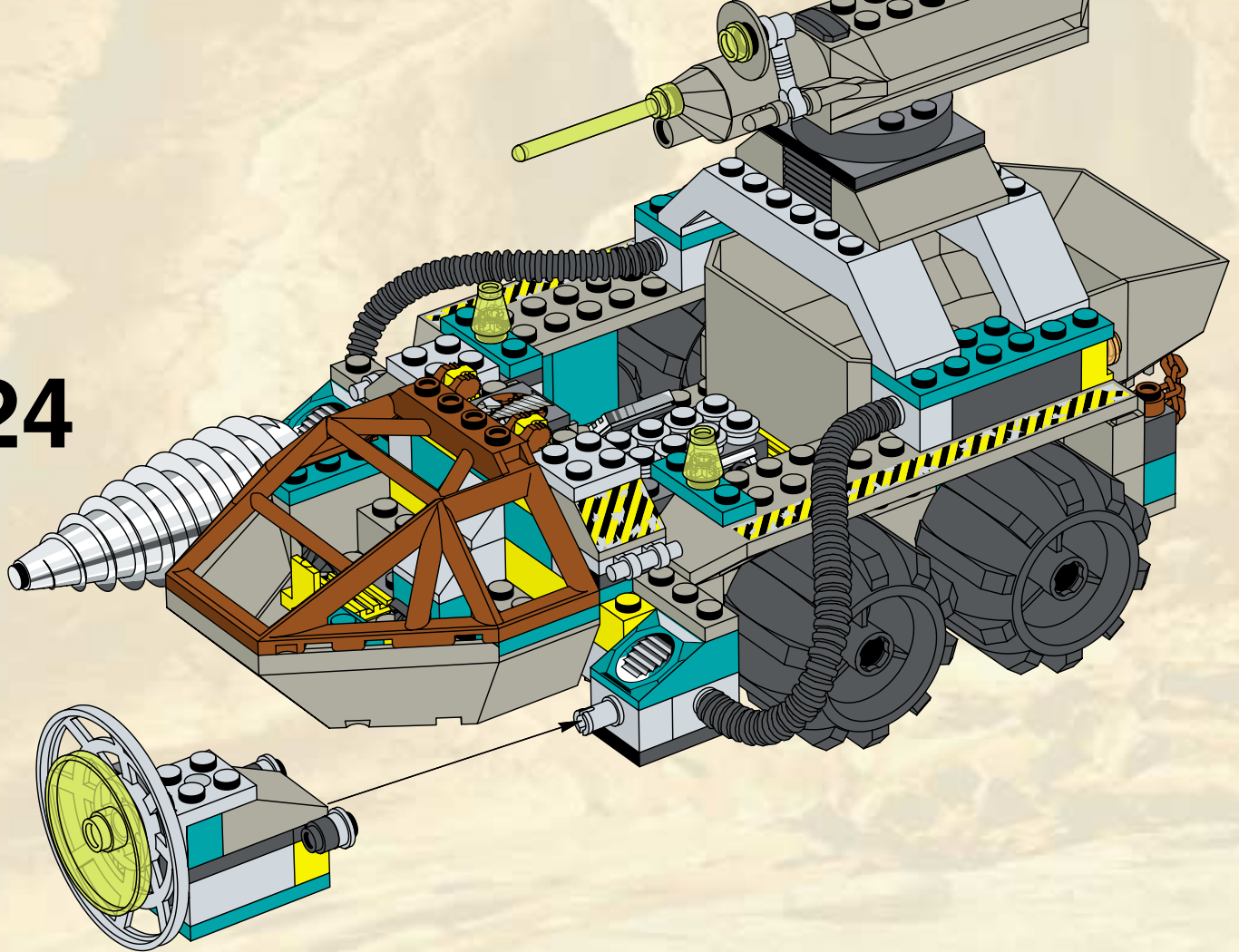

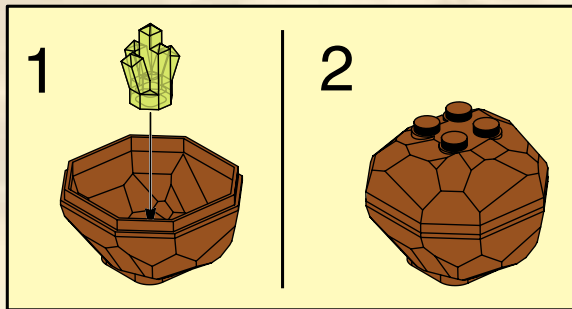
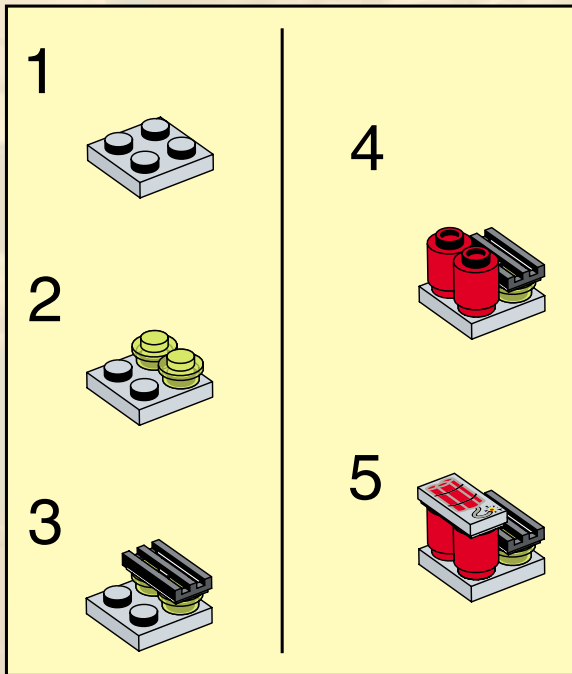

25

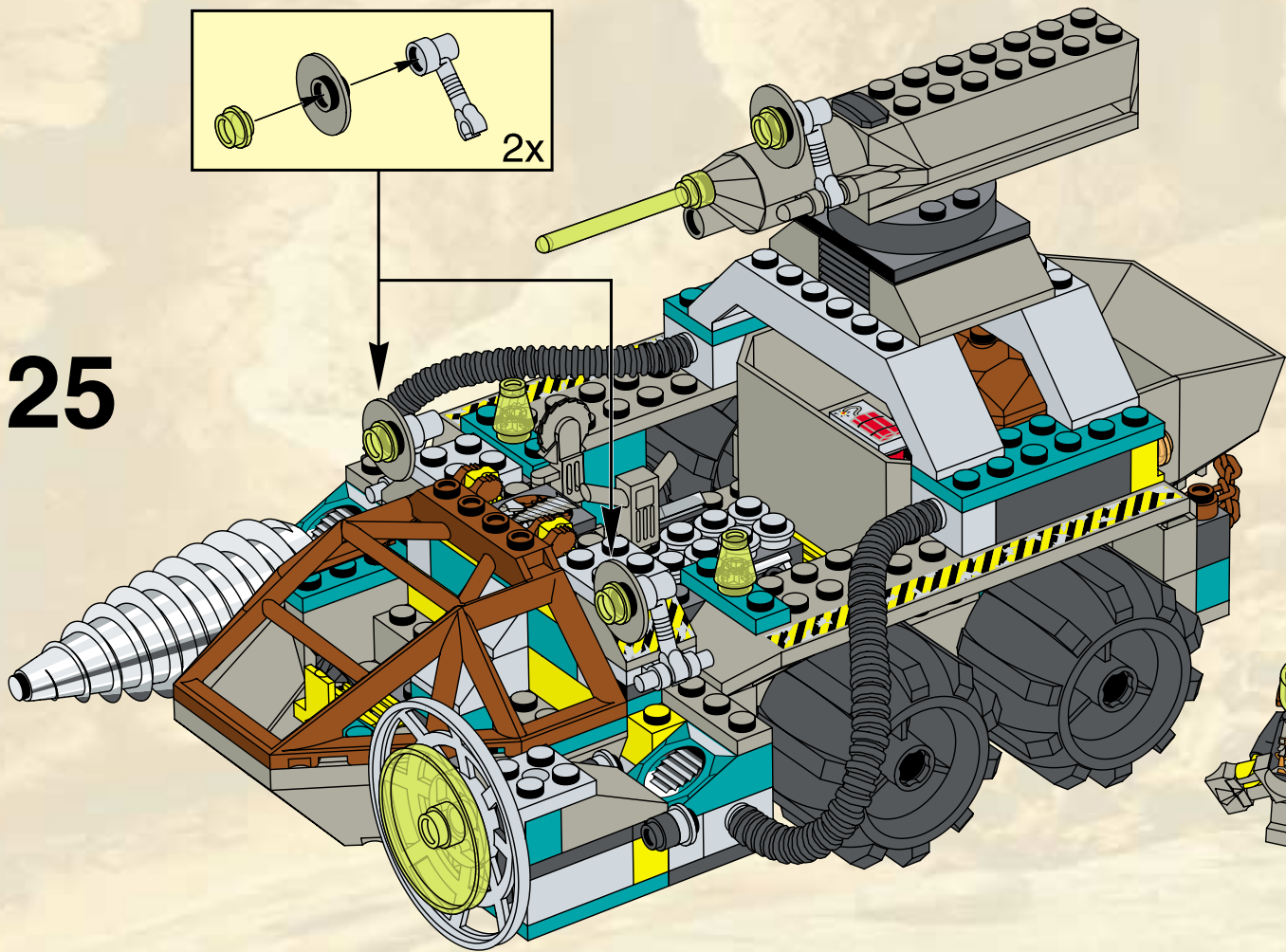
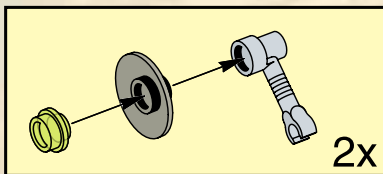

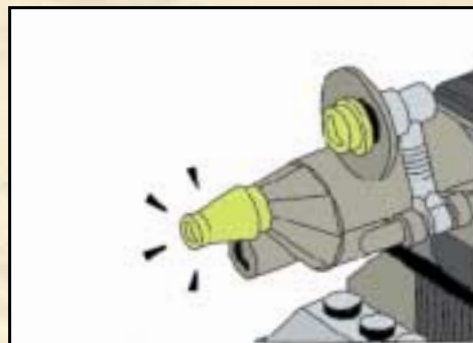
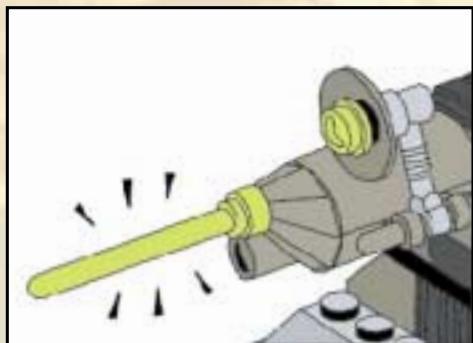



UK Instructions for use of battery box

Never mix different types of batteries or old and new batteries in one battery box. Always remove the batteries from the battery box for long-term storage or if they have reached the end of their life. Liquid leaking from dead batteries will damage the battery box. Rechargeable batteries can be used but power may be reduced. Do not recharge the batteries in the battery box.

D Bedienunghinweise für Batteriekästen

Benutze niemals verschiedene Batterietypen oder alte und neue Batterien gemeinsam in einem Batteriekasten. Nimm aufgebrauchte Batterien gleich aus dem Batteriekasten. Lagere den Batteriekasten für längere Zeit stets ohne Batterien. Austretende Flüssigkeit aus alten Batterien kann den Batteriekasten beschädigen. Du kannst wiederaufladbare Batterien benutzen. Aber lade sie nicht im Batteriekasten auf. Entsorge verbrauchte und alte Batterien immer über Sammelstellen. Sie gehören nicht in den Hausmüll!

F Instructions pour l'utilisation du boîtier-piles

Ne mélangez jamais différents types de piles, ou des anciennes piles avec des neuves. Pensez à enlever les piles du boîtier lorsque vous ne vous en servez pas, et ne les gardez pas trop longtemps, car le liquide provenant de piles usagées peut endommager le boîtier. Vous pouvez utiliser des piles rechargeables, mais ne les rechargez pas dans le boîtier-piles.

I Istruzioni per l'uso del portapile

Non utilizzare pile vecchie e nuove nello stesso portapile. Togliere sempre le pile se scariche o se non devono essere utilizzate per lungo tempo. Il liquido che fuoriesce dalle pile scariche danneggia il portapile. E' possibile utilizzare pile ricaricabili. Non ricaricare le pile nel portapile.

NL Zo gebruikt u de batterijhouder

Gebruikt u nooit verschillende type batterijen of nieuwe en oude batterijen bij elkaar in een batterijhouder. Als u de batterijhouder langere tijd niet gebruikt, verwijdert u dan de batterijen. Dit geldt ook voor batterijen die leeg zijn. Batterijen die leeg zijn of die lang in de batterijhouder zitten kunnen gaan lekken. Dit veroorzaakt onherstelbare schade en valt niet onder garantie. U kunt oplaadbare batterijen gebruiken. Laad nooit batterijen op in de batterijhouder.

E Instrucciones para el uso del porta-pilas

Dentro de una misma caja porta-pilas no mezclar nunca distintos tipos de pilas ni tampoco las nuevas con las ya usadas. Sacar siempre las pilas de la caja porta-pilas cuando no vayan a utilizarse por un tiempo y cambiarlas igualmente cuando estén muy usadas, ya que el líquido que desprenden puede dañar las conexiones de la caja porta-pilas. Pueden utilizarse pilas recargables, si bien no deben recargarse dentro de la caja porta-pilas.

DK Batteriinformation

Brug aldrig forskellige typer batterier sammen, eller nye og gamle batterier i samme batteriboks. Tag altid batterierne ud af batteriboksen, hvis du ikke skal bruge den i længere tid, eller hvis batterierne er brugt op. Væsk fra batterierne kan ødelegge batteriboksen. Man kan anvende genopladelige batterier. Genoplad aldrig batterierne i batteriboksen.

FIN Paristokotelon käyttöohje

Erityyppisiä tai uusia ja vanhoja paristoja ei pitäisi koskaan käyttää samanaikaisesti. Poistakaa paristot aina paristokotelosta mikäli ne ovat loppuunkäytetyt tai mikäli ette käytä paristokoteloita pitkään aikaan. Nestevuodot loppuunkäytetyistä paristoista vahingoittavat paristokotelo. Voitte käyttää myös akkuja. Älkää kuitenkaan ladatko akkuja paristokotelossa.

S Instruktioner till batteriboxen

Blanda inte olika typer av batterier och inte heller nya och gamla batterier i samma batteribox. Ta ut batterierna ur boxen om du inte skall använda den på länge, eller om batterierna är slut. Läckande vätska från gamla batterier skadar batteriboxen. Laddningsbara batterier kan användas. Ladda inte upp batterierna i batteriboxen.

P Instruções para utilização da Caixa de Pilhas

Não misturar nunca pilhas de tipos diferentes ou pilhas novas e velhas na mesma caixa de pilhas. Retirar sempre as pilhas da caixa no caso de armazenagem prolongada ou se elas já estiverem gastas. O líquido vertido pelas pilhas gastas danificará a caixa de pilhas. Podem ser utilizadas pilhas recarregáveis. Não recarregue as pilhas na caixa.

H Utasítások az elemtartó használatához

Soha ne használj egyszerre különböző fajta elemeket vagy használt és új elemeket egy elemtartóban. Ha sokáig nem használod az elemeket vagy ha már lemerültek, vedd ki őket az elemtartóból. Az elhasználdott elemekből kiáramló folyadék tönkretelheti az elemtartót. Feltölthető elemeket természetesen használhatsz, de élettartamuk rövidebb lehet. Soha ne töltsd fel az elemeket a elemtartóban.

GR Οδηγίες χρήσεως του κουτιού μπαταρίας

Ποτέ μην αναμειγνύετε διαφορετικούς τύπους μπαταριών ή νέες με παλιές μπαταρίες στο ίδιο κουτί. Όταν τις αποθηκεύετε για πολύ χρόνο ή όταν οι μπαταρίες έχουν χαλάσει, απομακρύνετε τις πάντοτε από το κουτί μπαταρίας. Υγρό που στάζει από άδειες μπαταρίες θα χαλάσει το κουτί μπαταρίας. Επαναφορτιζόμενες μπαταρίες μπορούν να χρησιμοποιηθούν. Μην επαναφορτίζετε τις μπαταρίες μέσα στο κουτί.

TR Pil kutusu kullanma talimatı

Hiçbir zaman değişik tipteki pilleri ve eski ile yeni pilleri birarada kullanmayınız. Motoru uzun süre kullanmayacağınıza pilleri kutuda bırakmayınız. Boşalan pilleri kutudan çıkartınız. Boşalan pillerin akması pil kutusuna zarar verebilir. Şarj edilebilen pilleri de kullanabilirsiniz, ancak bu durumda güç azalabilir. Pilleri kutunun içinde şarj etmeyiniz.

Cara menggunakan kotak baterai

MAL Jangan campurkan baterai lama dan baru dalam satu kotak baterai. Jika tidak menggunakan motor atau baterai habis, keluarkan baterai dari kotak. Kebocoran baterai yang habis akan merusakkan kotak. Baterai yang boleh dicas boleh digunakan tetapi kuasa tenaganya berkurangan. Jangan sekali-kali mencajkan baterai di dalam kotak.

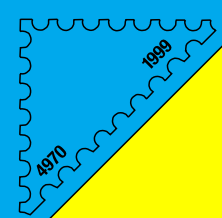

日本語 電池ケース使用上のご注意

異なる種類の電池や、古い電池と新しい電池を混ぜて使用することは避けください。電池の寿命が切れた場合、または長期間使用しない場合には、ケースから電池を抜いてください。切れた電池から液が漏れて、電池ケースを損なうこととなります。充電式電池も使用できますが、パワーは弱くなる場合があります。なお、電池ケースの中で充電しないようご注意ください。

中文 電池盒使用說明

切勿在同一個電池盒內同時使用不同類型的電池或混合新舊電池。需要長期藏貯電池或者電池已經用盡的話，請把電池從電池盒內取出。從廢電池漏出來的液體會損壞電池盒。您可以使用充電式電池，但它們的電力比較弱。進行充電時，請勿把電池留在電池盒內。

عربي
تعليمات استعمال صندوق البطارية
يجب عدم خلط أنواع مختلفة من البطاريات، أو خلط البطاريات القديمة مع الجديدة في صندوق بطارية واحد. كما يجب دائماً مراعاة إزالة البطاريات من صندوق البطارية، عند حفظها وعدم استعمالها لمدة طويلة أو عند إنتهاء فعالية طاقتها. كما وأنه يجب الأخذ في الإعتبار أن تسرب السائل من البطاريات القديمة التي إنتهت فعالية طاقتها يؤدي إلى تلف صندوق البطارية. يمكن استعمال البطاريات التي يعاد شحنها، إلا أن ذلك قد يؤدي إلى تقليل وإخفاض الطاقة. يجب عدم إعادة شحن البطاريات في صندوق البطارية.

한국어 진전지 박스 사용법

진전지 박스에는 알카라인 진전지와 일반 진전지를 함께 사용하지 마시고, 오래 된 진전지와 새 진전지도 함께 사용하지 마십시오. 진전지의 수명이 다른 경우나 장기간 사용하지 않을 때에는 항상 진전지 박스로부터 진전지를 제거시켜 주십시오. 수명이 다른 진전지에서 액체가 나오면 진전지 박스를 상하게 합니다. 축전지는 사용이 가능하나 전력은 약해질 수 있습니다. 진전지를 진전지 박스 안에서 충전하지 마십시오.

TH วิธีการใช้กล่องแบตเตอรี่

อย่าใช้แบตเตอรี่ต่างชนิดปนกัน หรือใช้แบตเตอรี่เก่ารวมกับแบตเตอรี่ใหม่ในกล่องแบตเตอรี่ ควรถอดแบตเตอรี่ออกทุกครั้ง เมื่อไม่ได้ใช้งานเป็นระยะเวลาสั้น หรือเมื่อแบตเตอรี่หมดอายุ น้ำยาที่รั่วออกจากแบตเตอรี่ที่หมดอายุแล้วจะทำให้กล่องแบตเตอรี่เสียหายได้ สามารถใช้แบตเตอรี่ประเภทชาร์จไฟได้ แต่กำลังไฟ อาจลดลง ห้ามชาร์จแบตเตอรี่ในกล่องใส่แบตเตอรี่

1

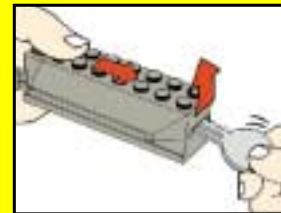

2



3

