



# CITY

60050



[LEGO.com/city](https://www.lego.com/city)



2

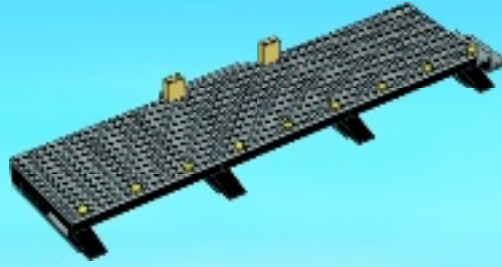

3



4

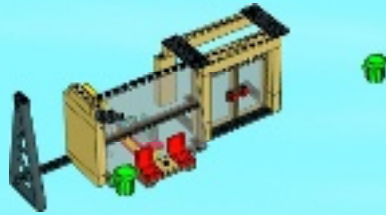

5

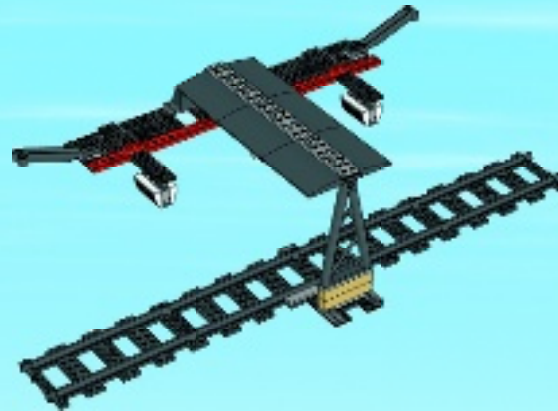

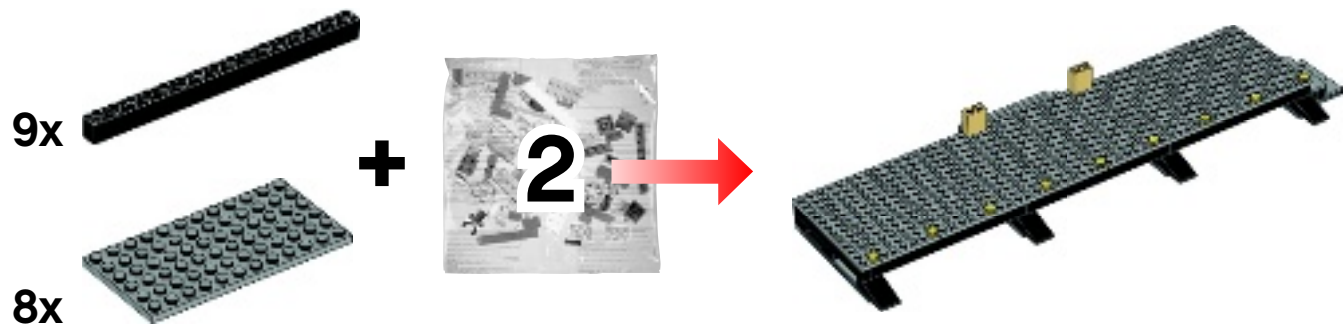

1

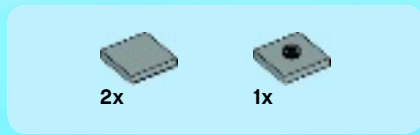

2

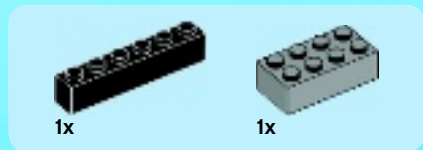

3

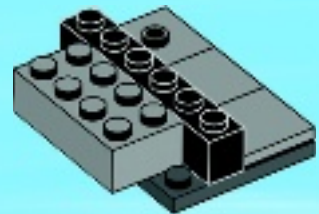



2x

4

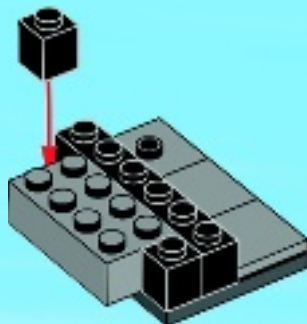

2x



1x

5

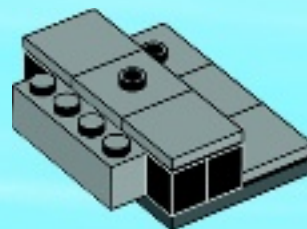

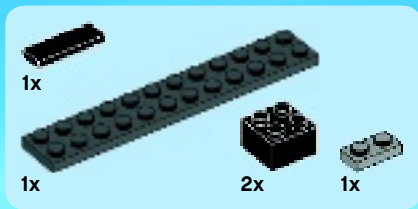

6

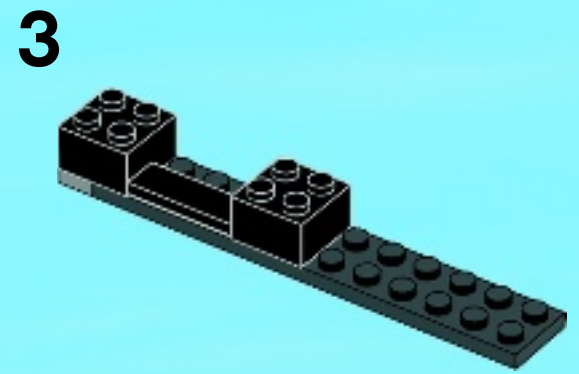
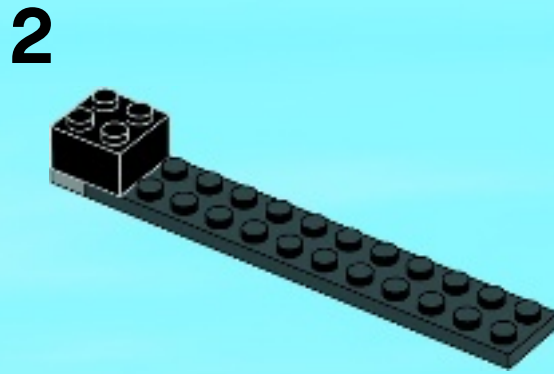
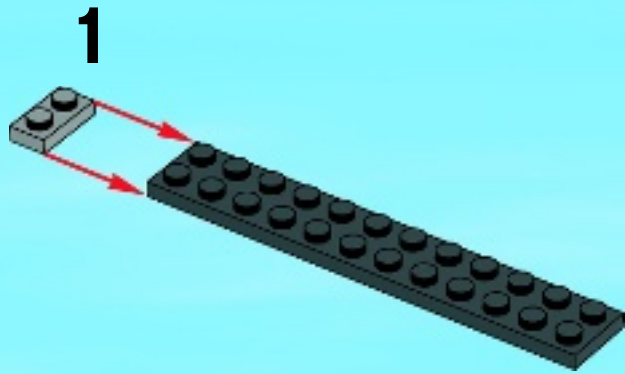



1x

# 7

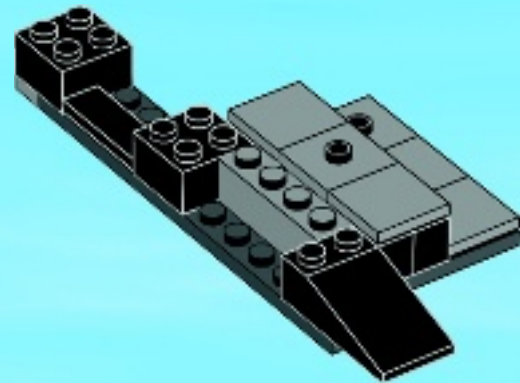
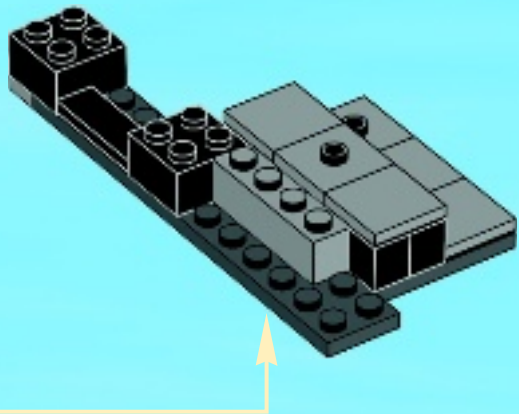



8

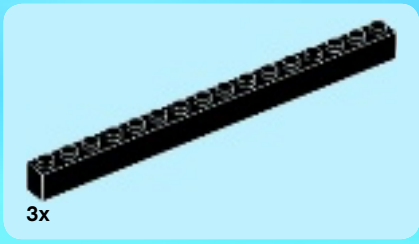
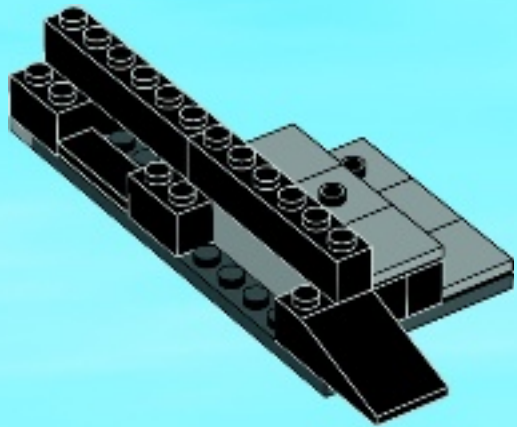

9

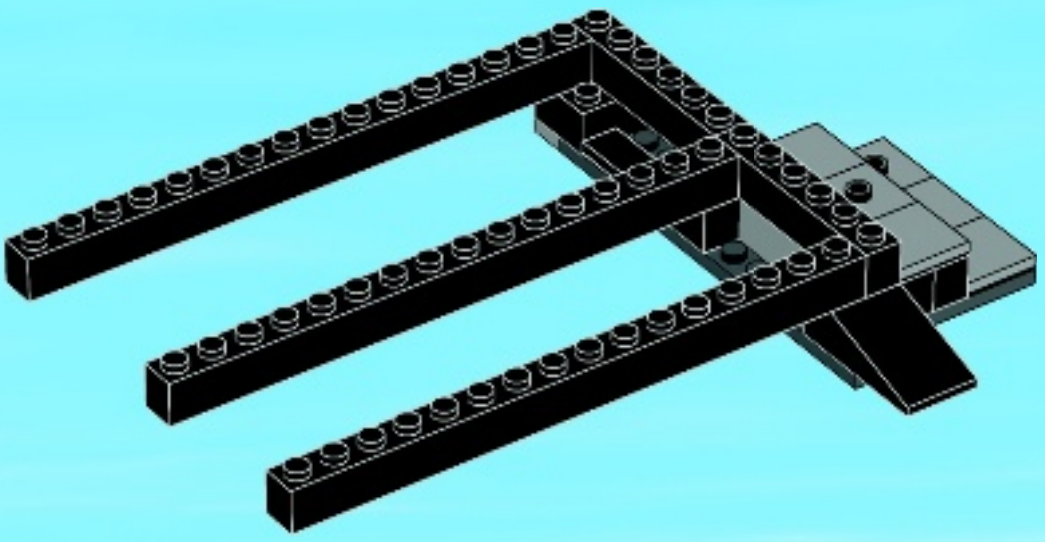

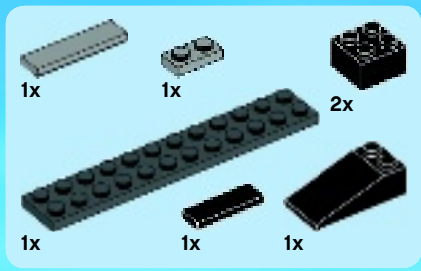

# 10

1

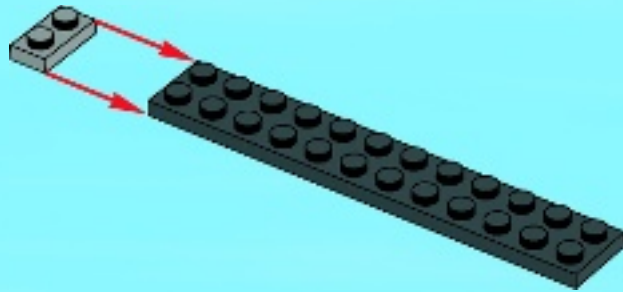

2

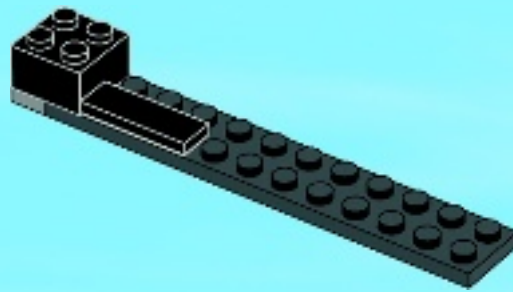

3

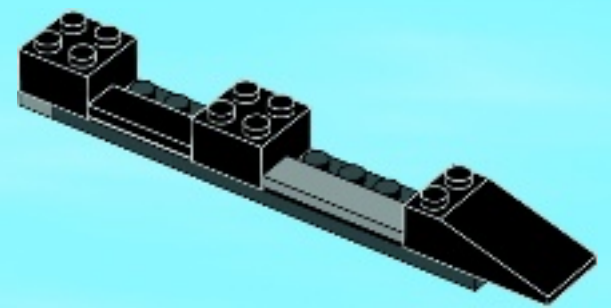



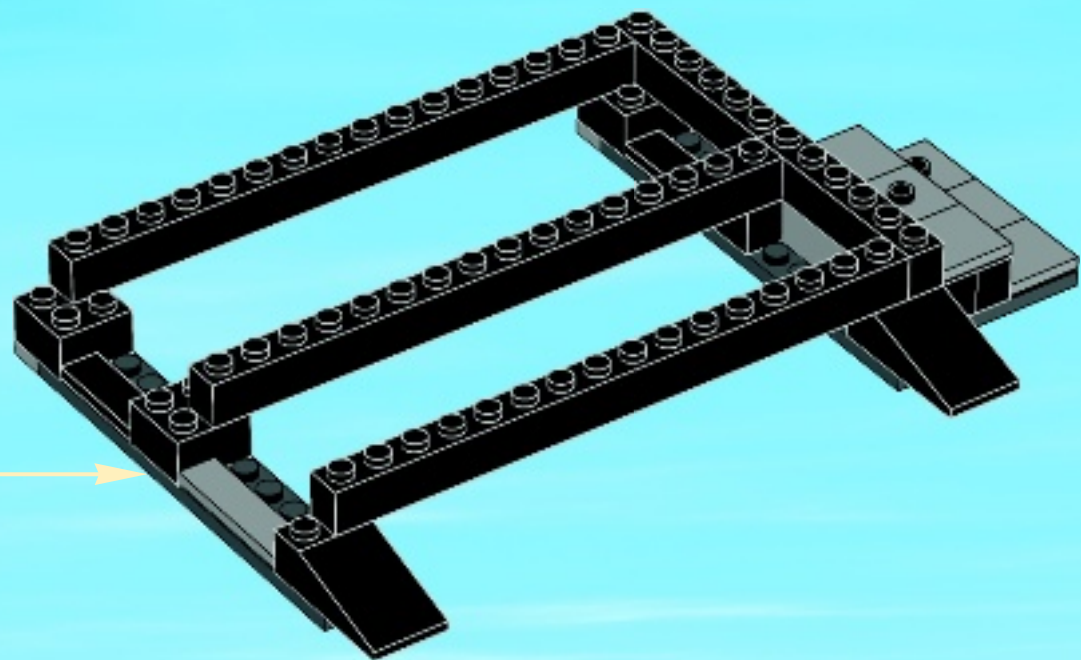



11

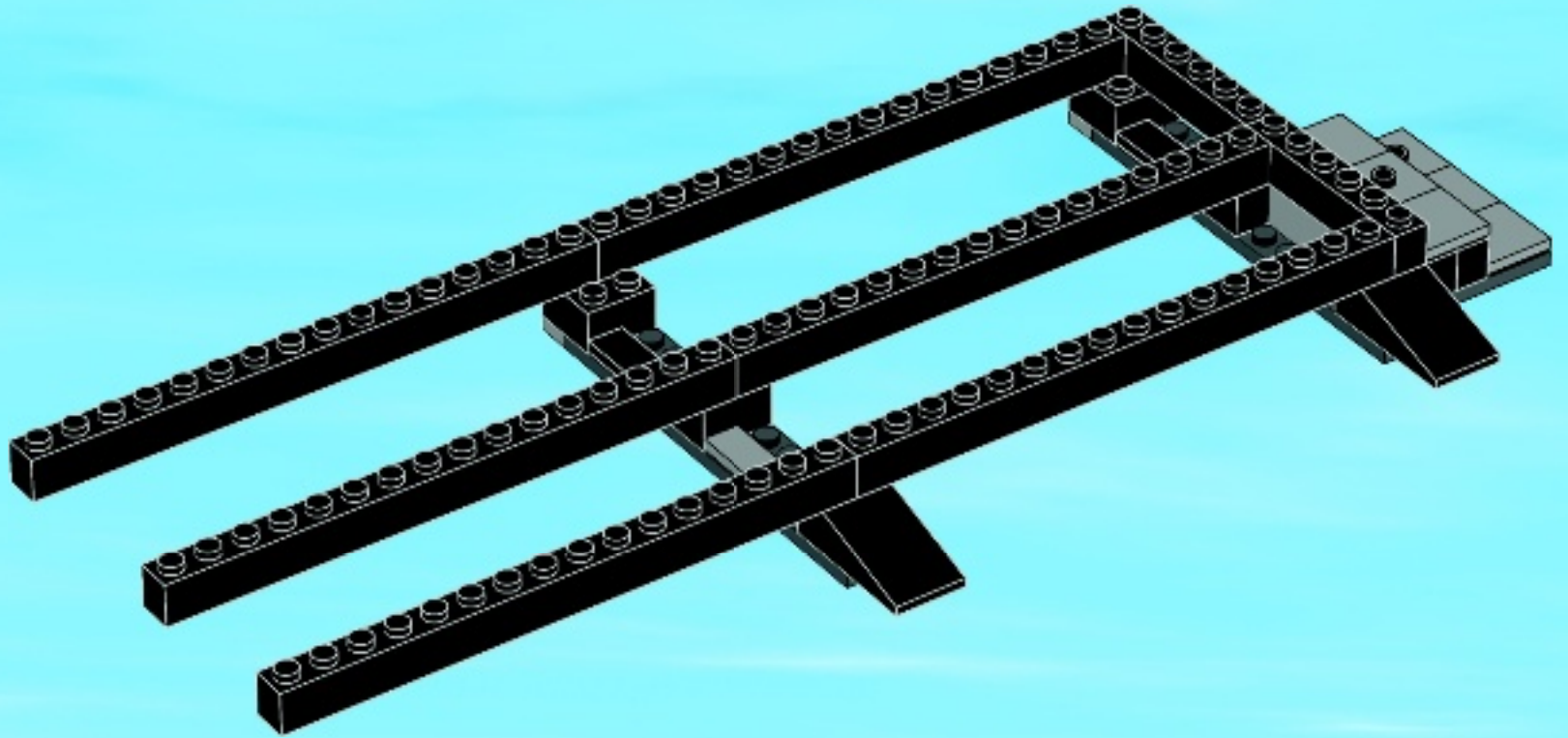

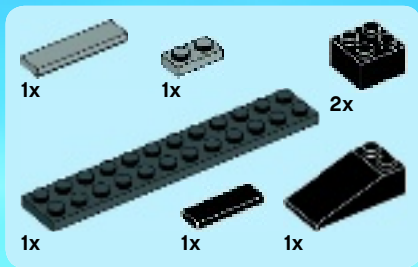

# 12

1

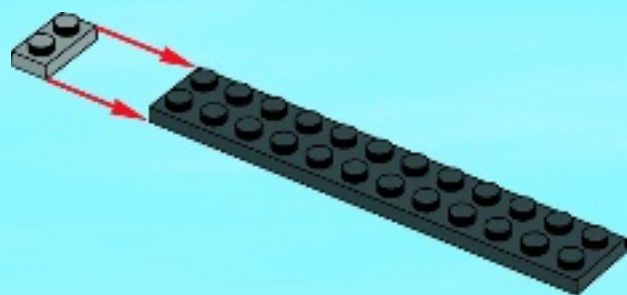

2

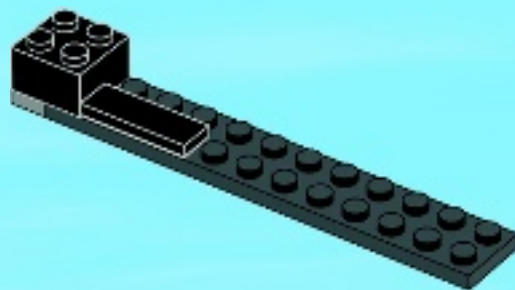

3

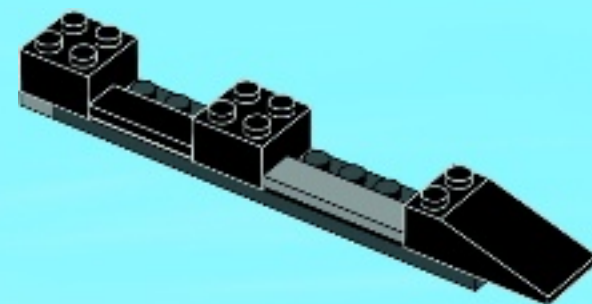

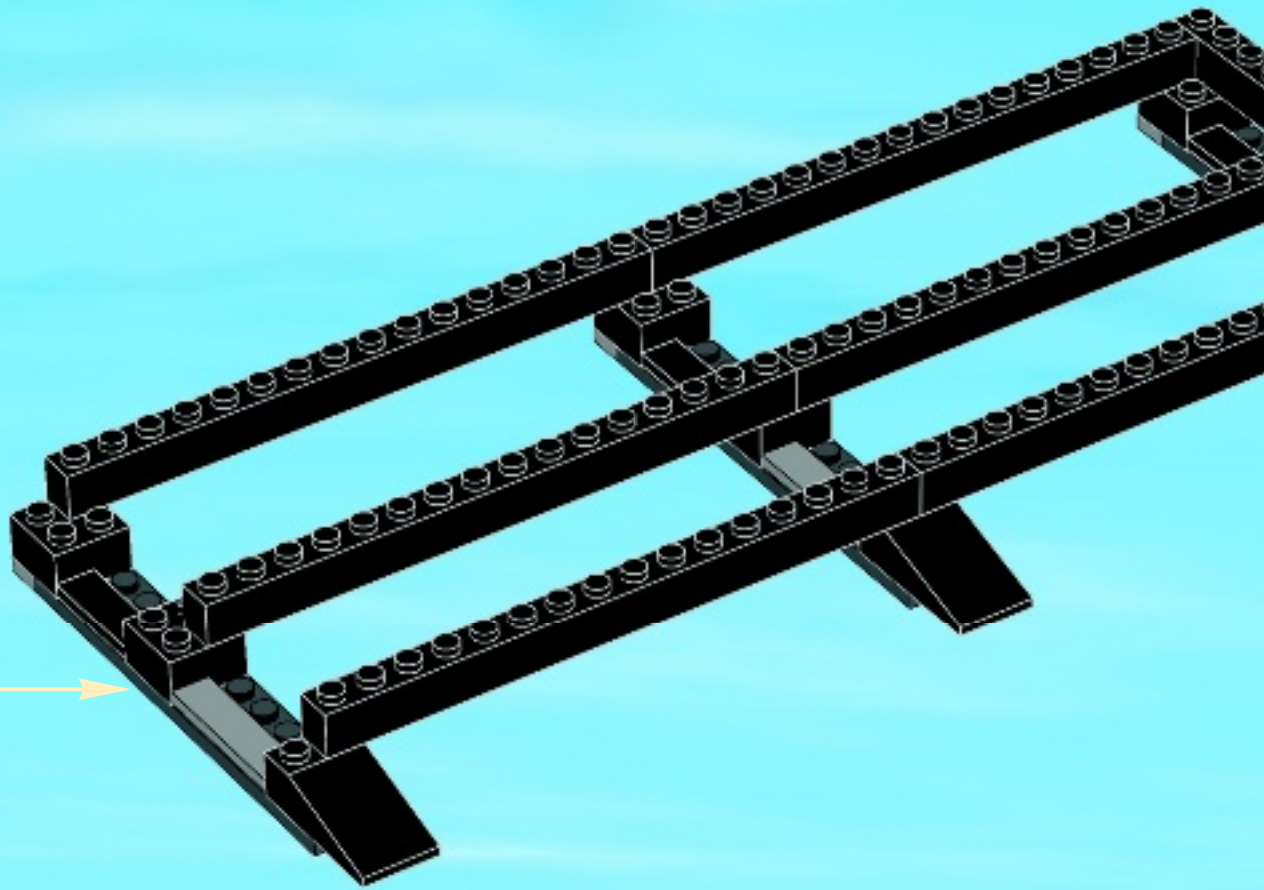

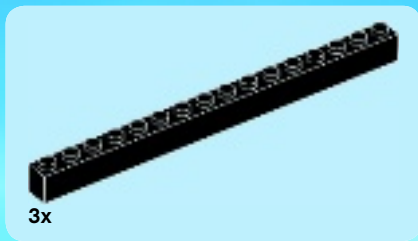

13

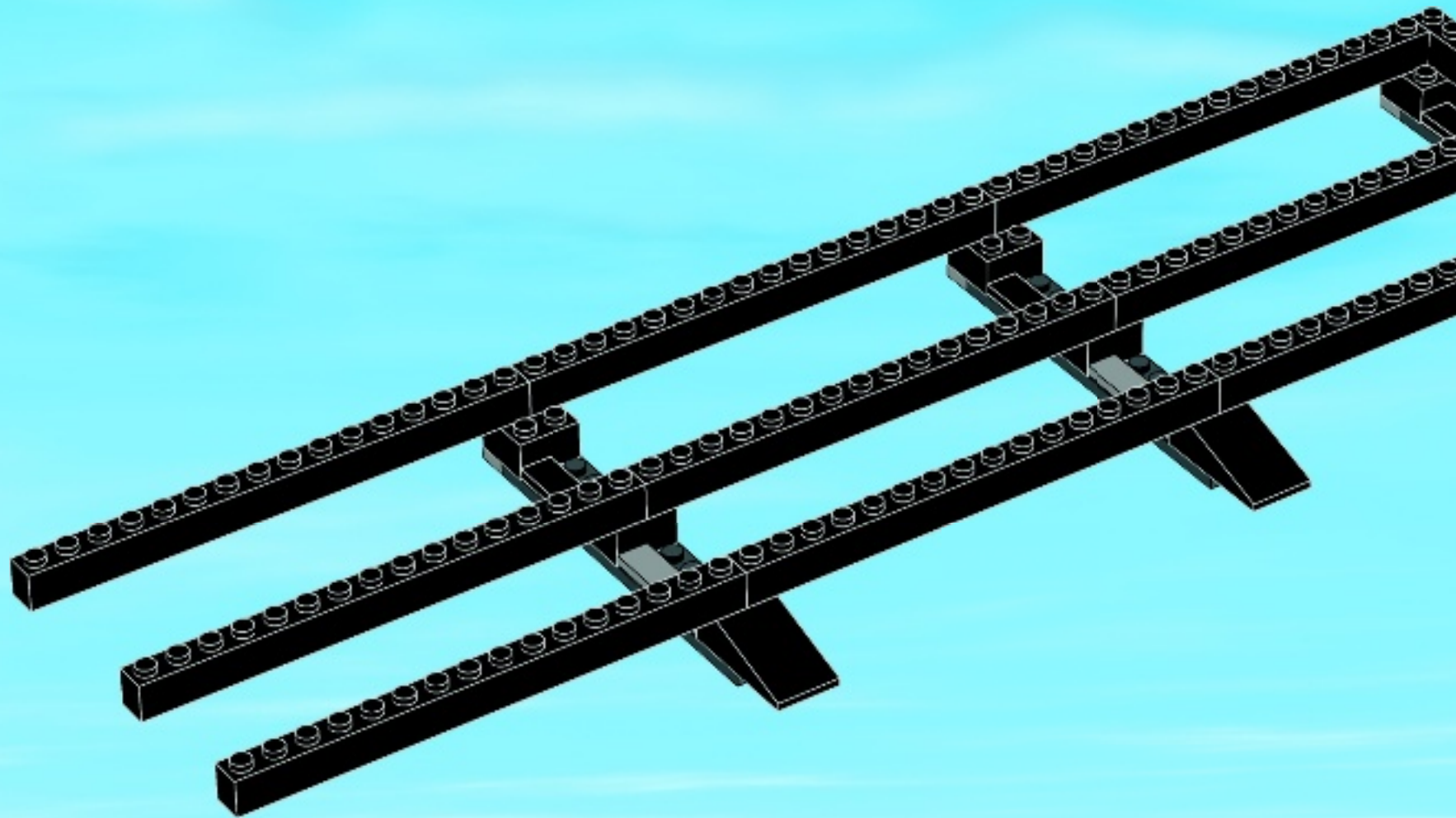

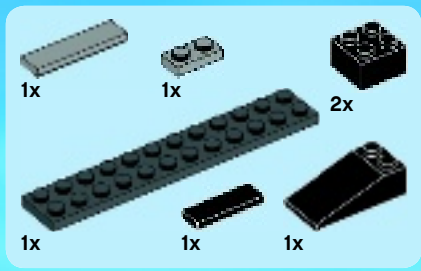

# 14

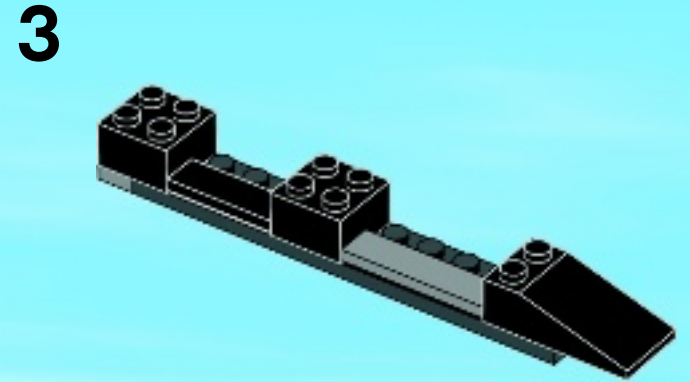
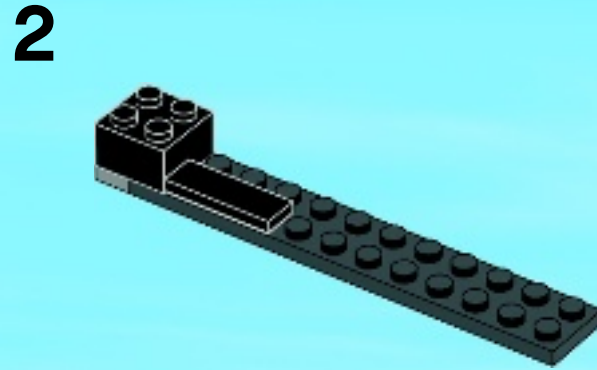
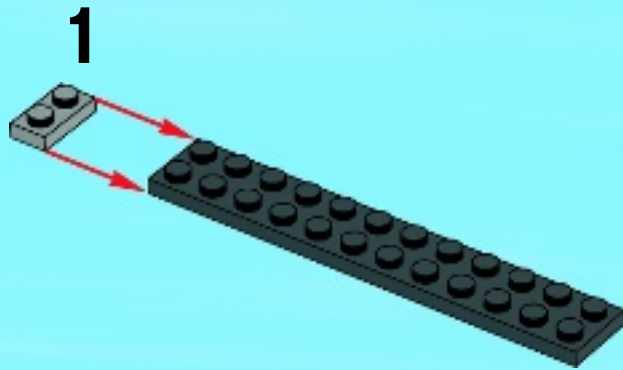

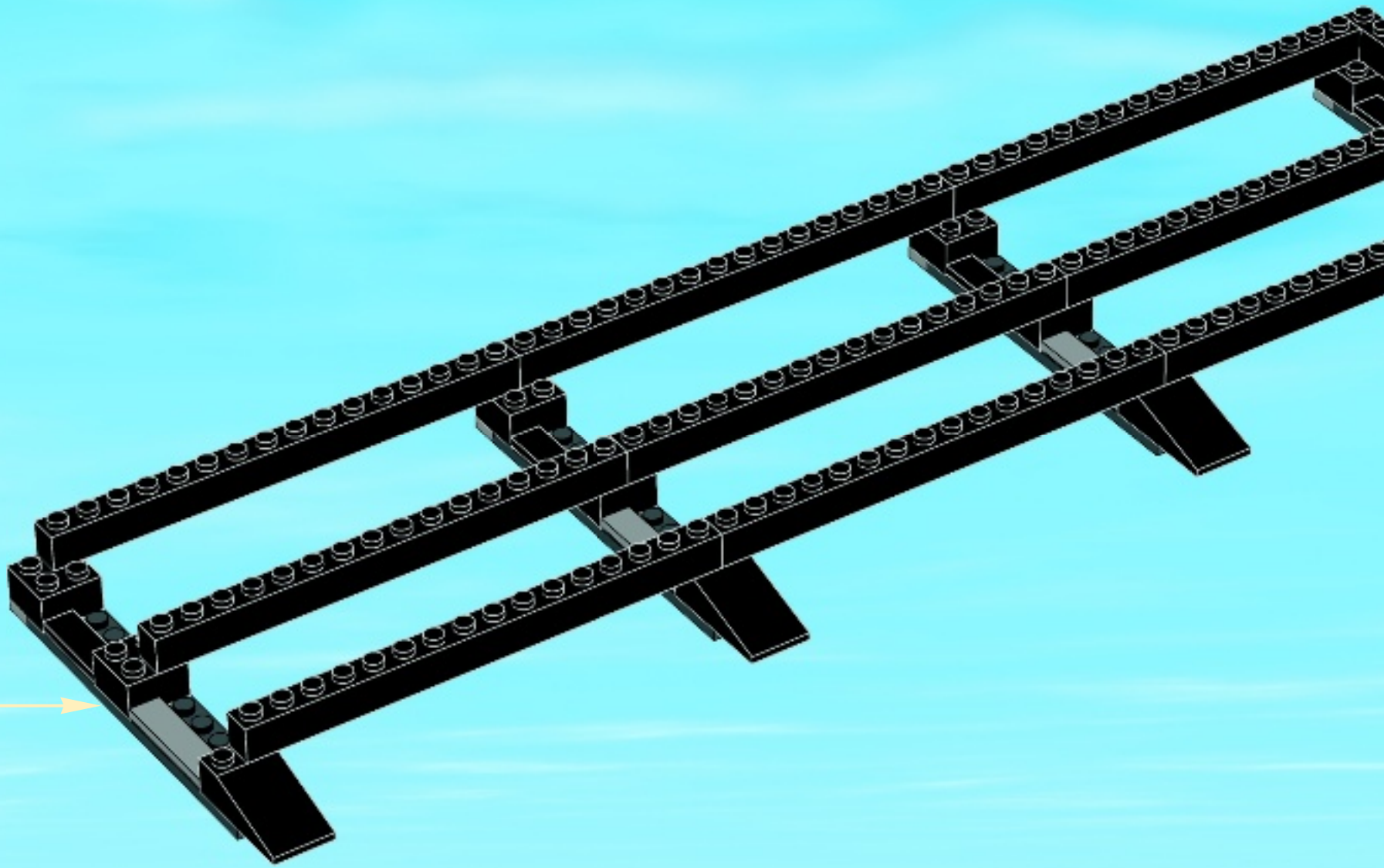



15

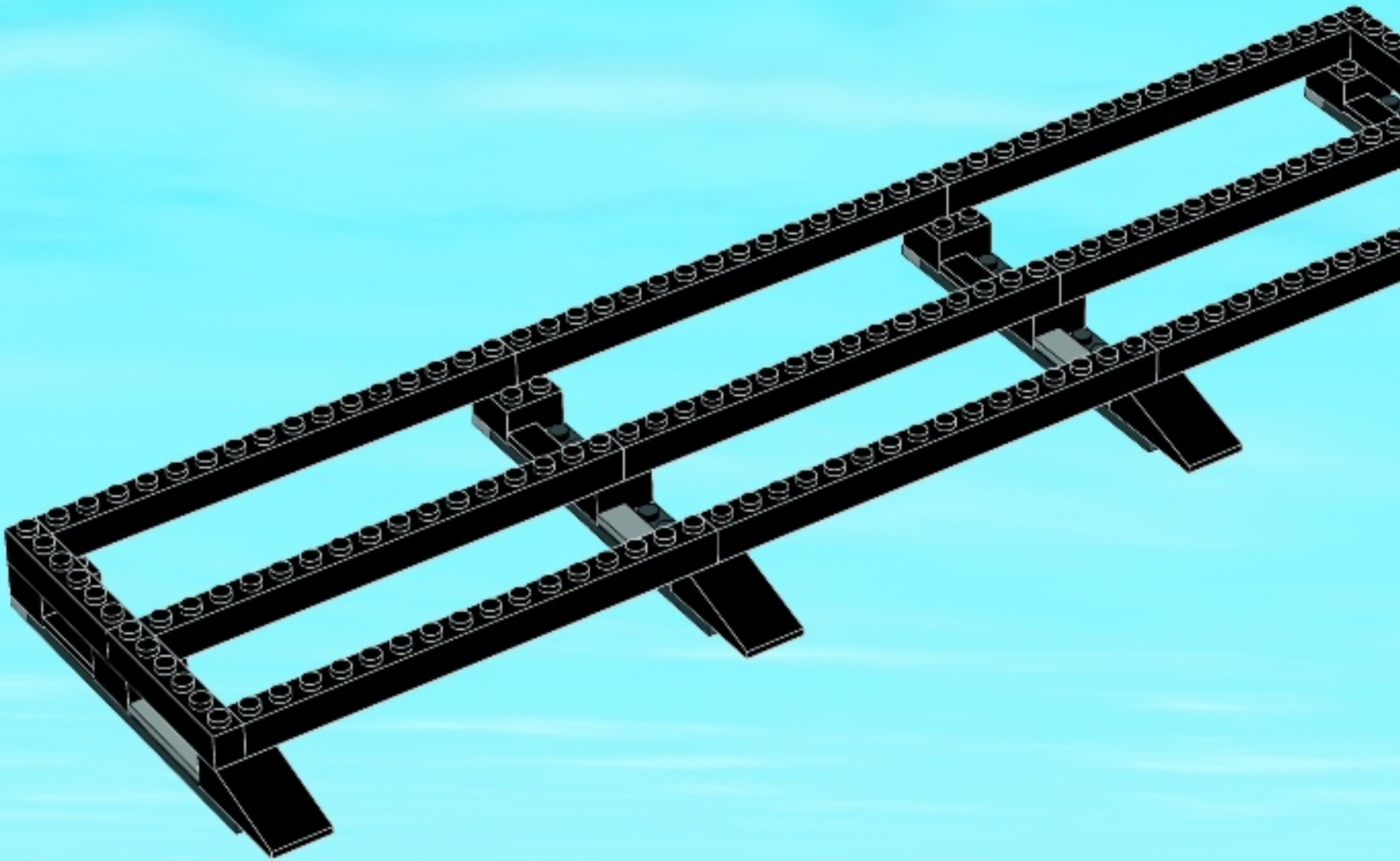



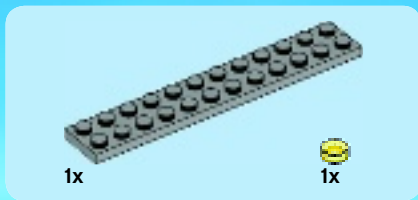

16

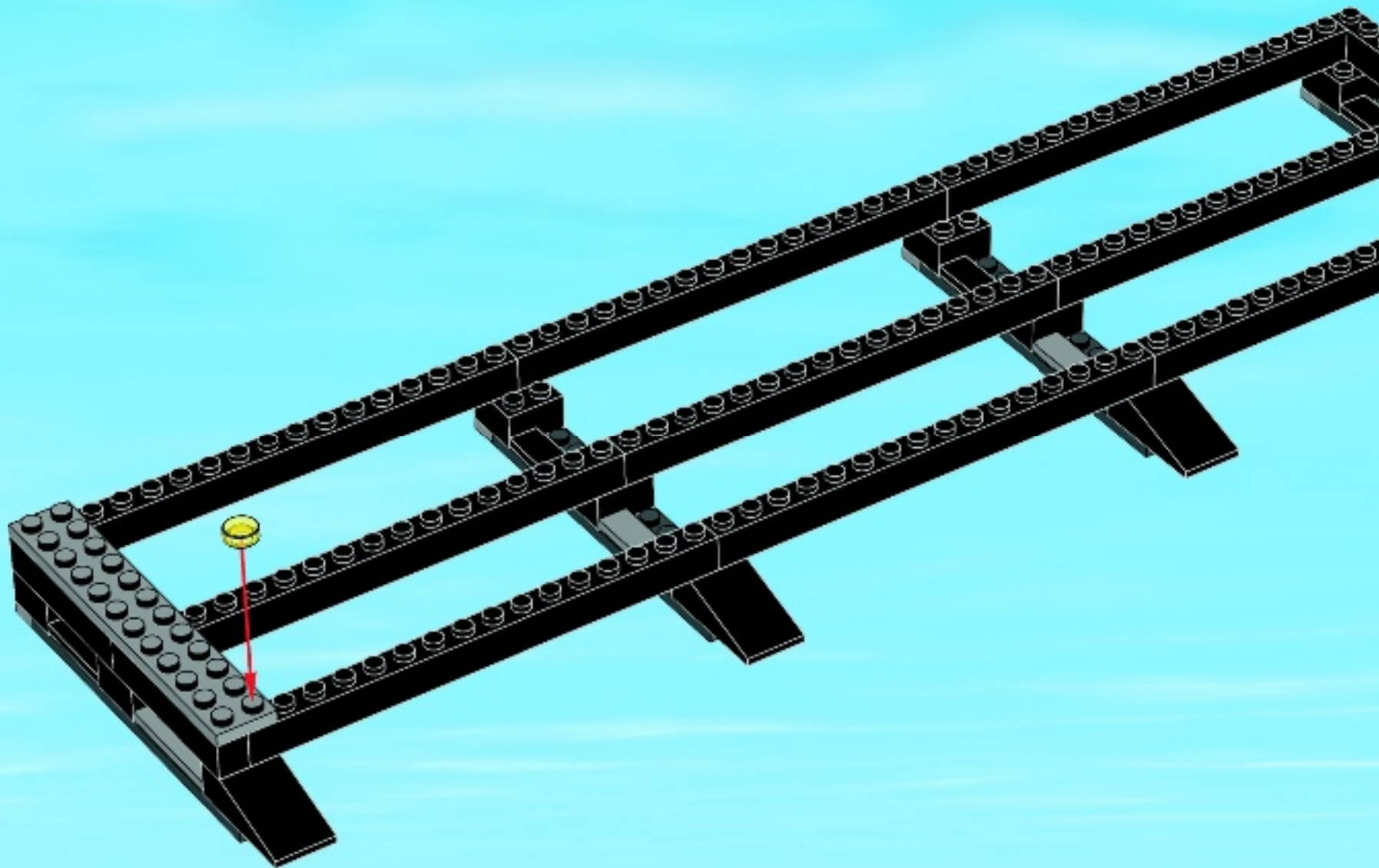

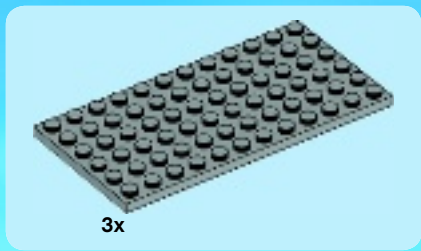

17

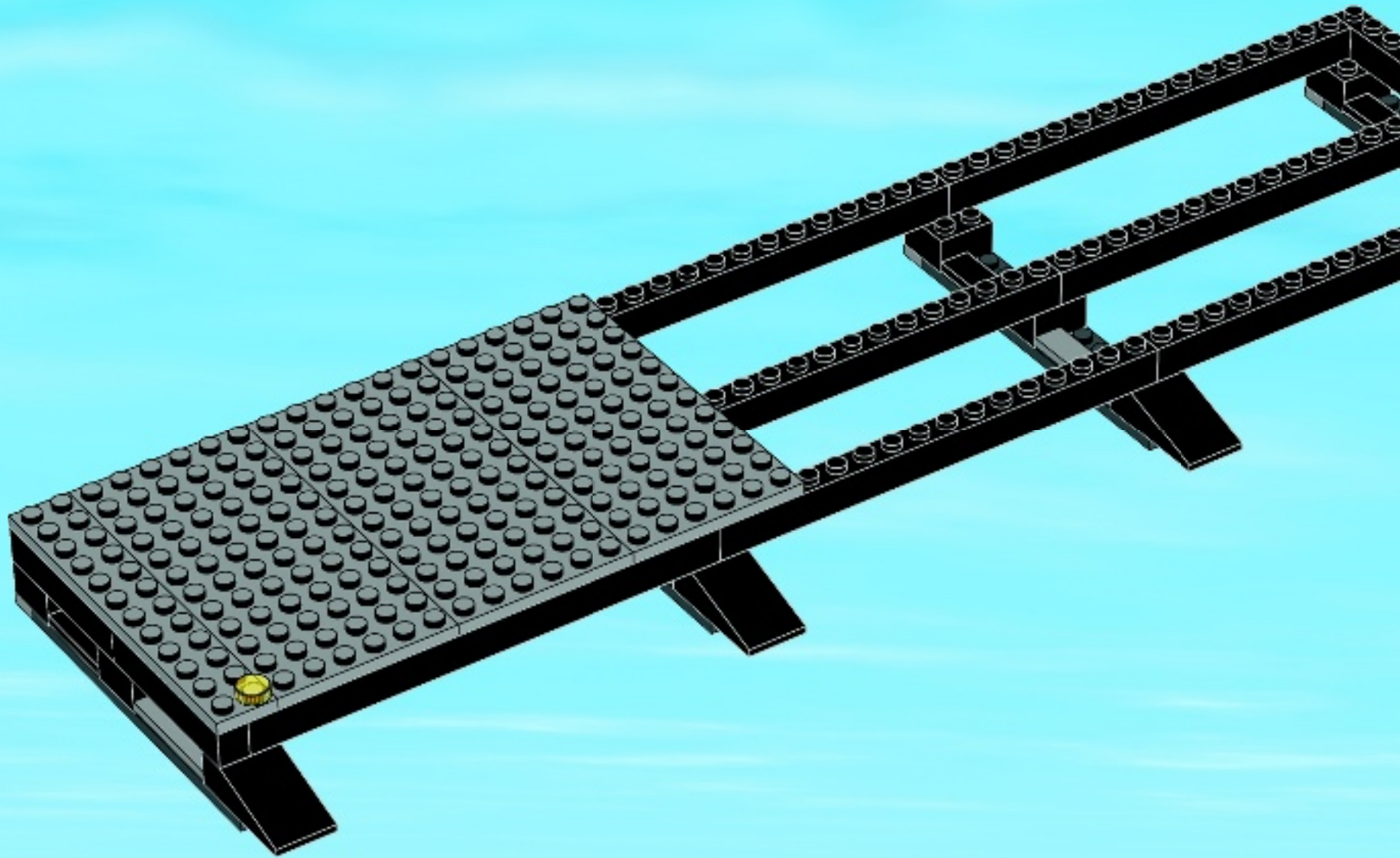



1x



3x

# 18

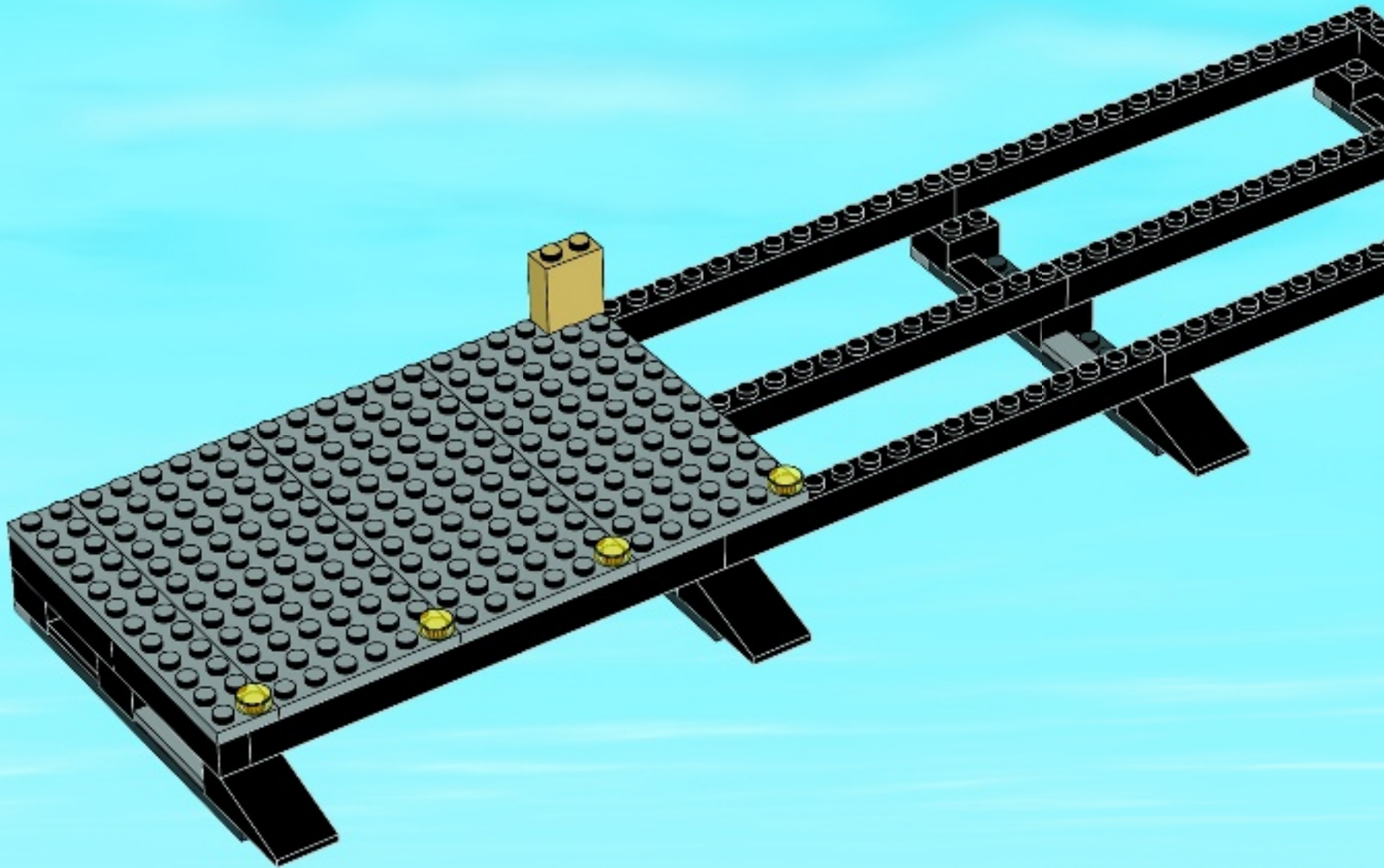

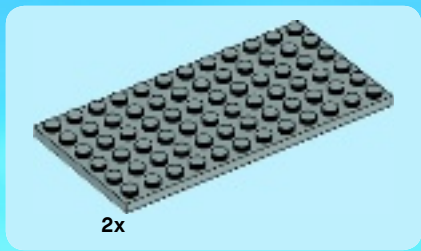

19

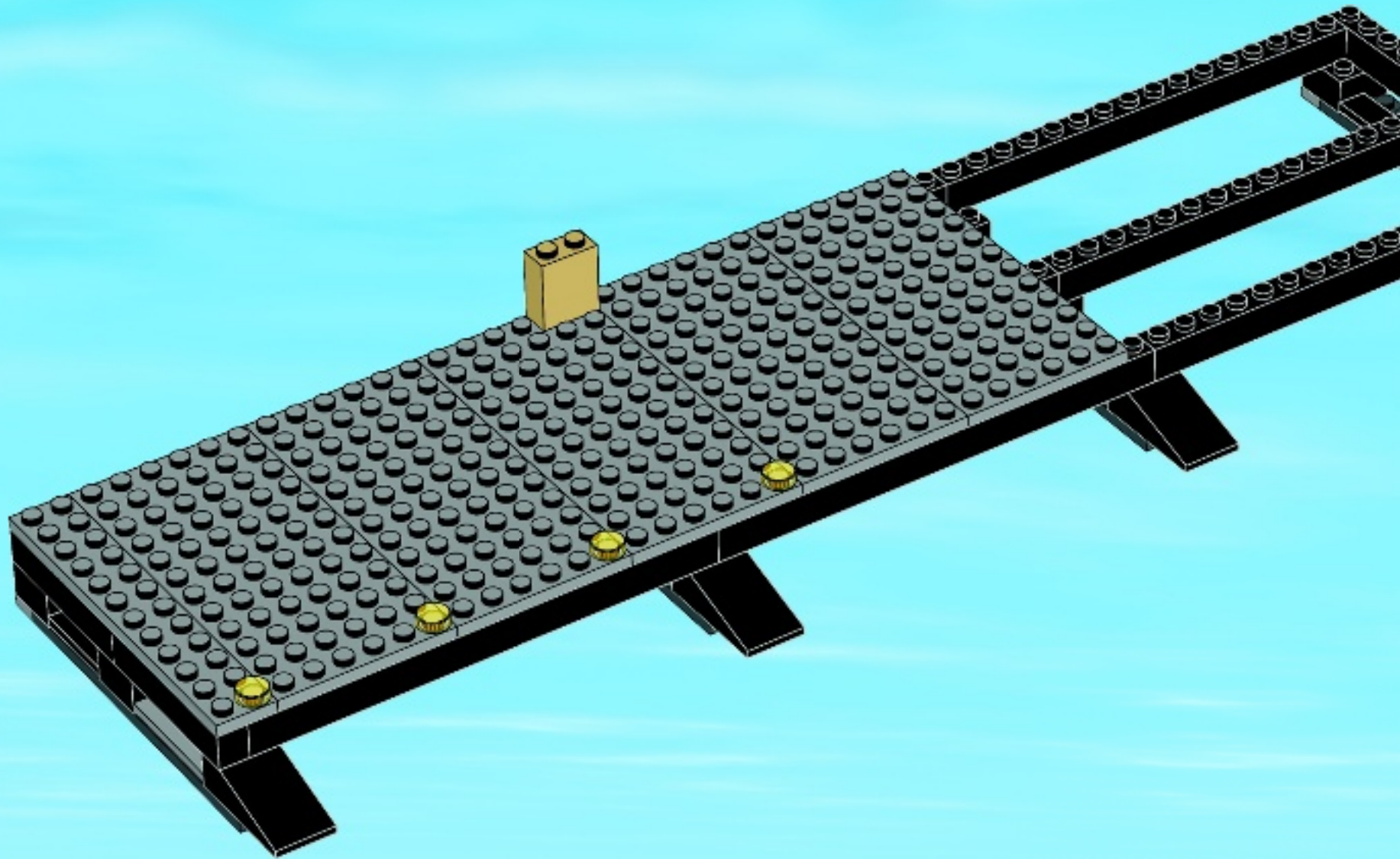



1x



2x

# 20

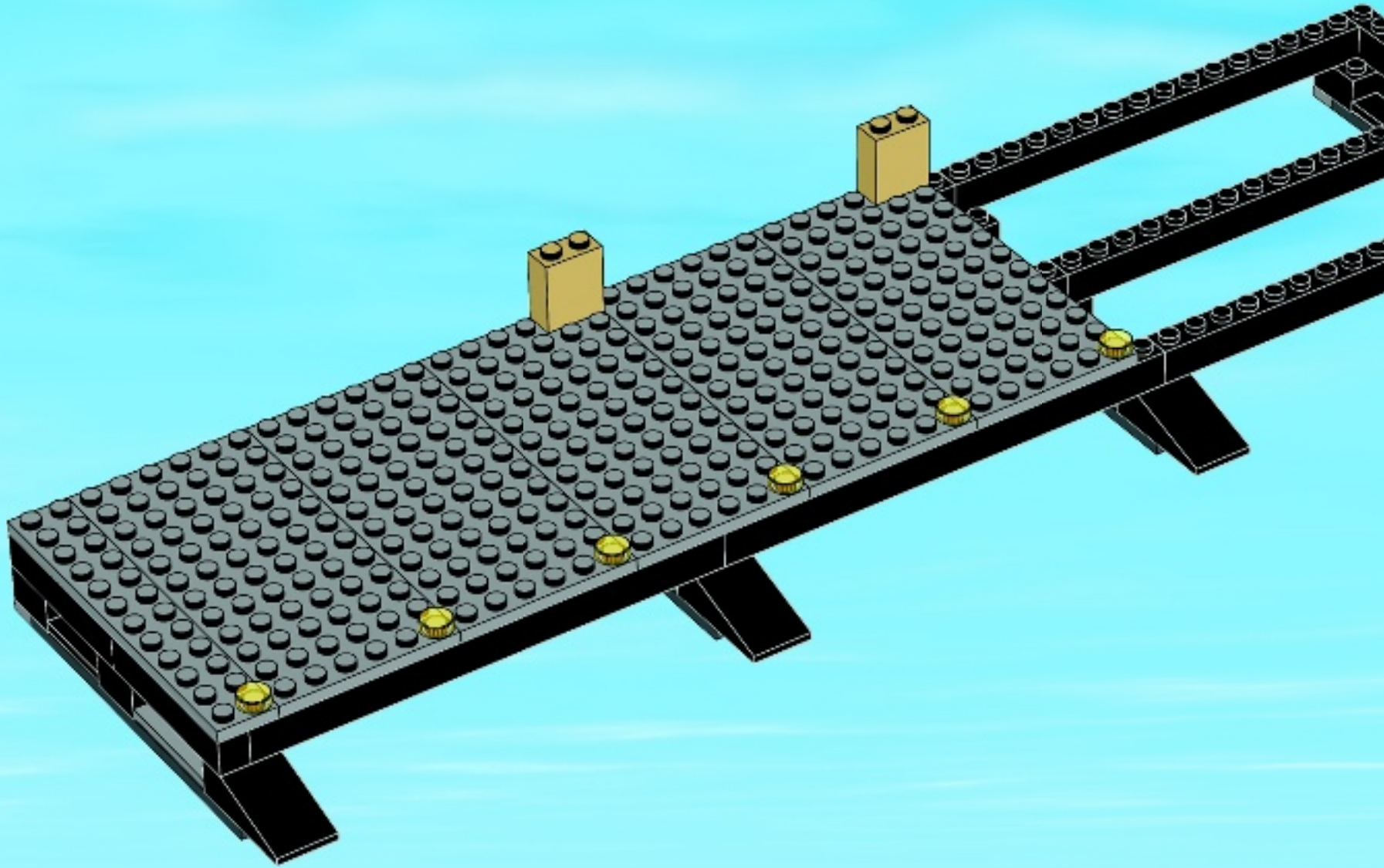

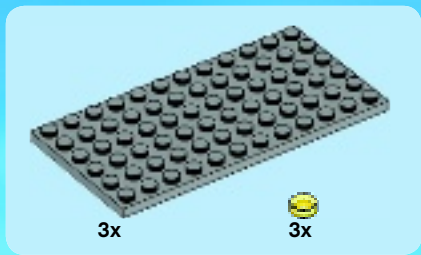

21

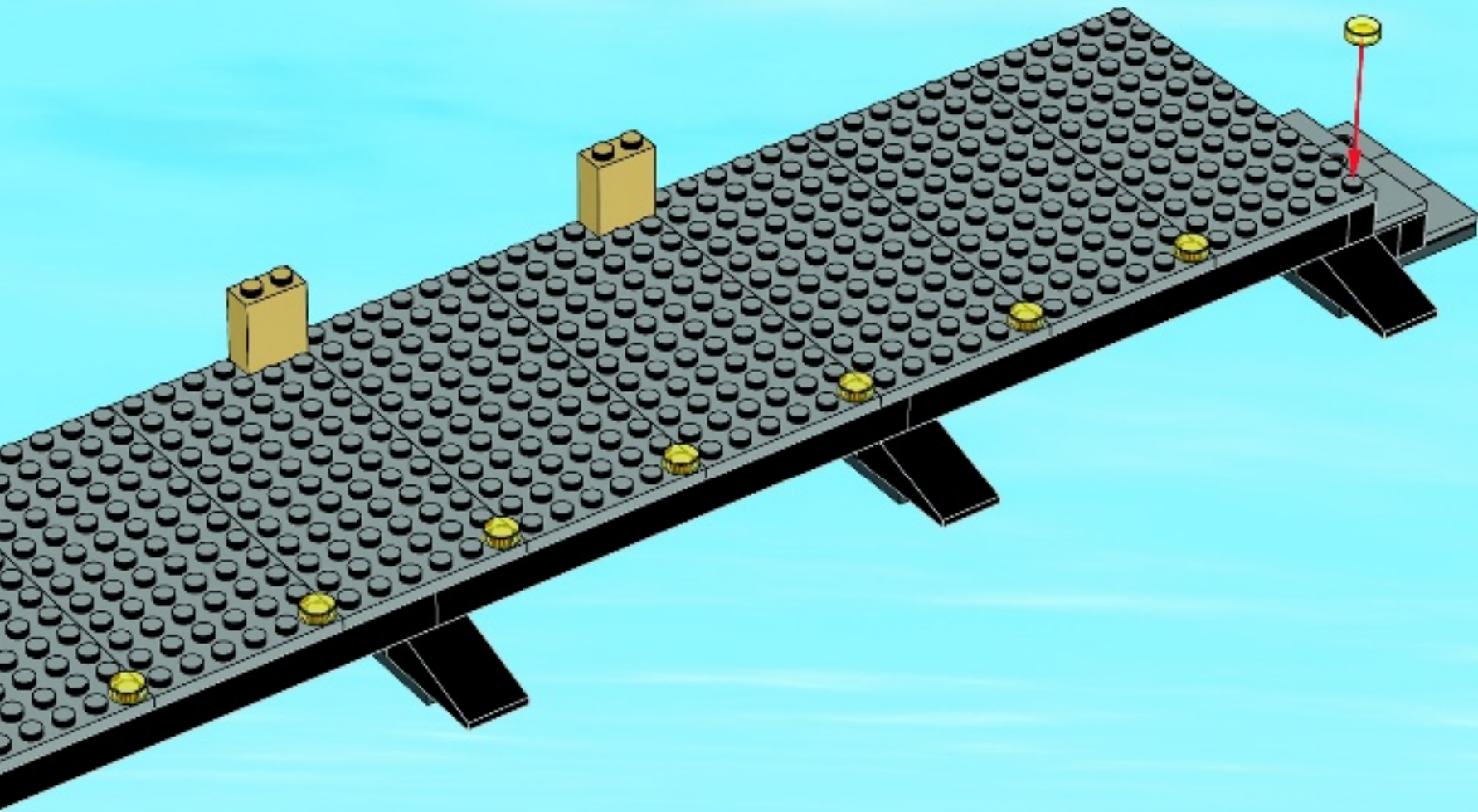

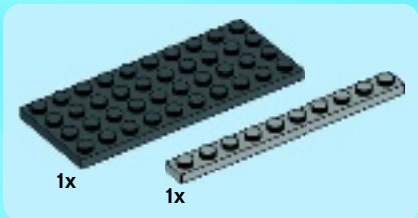
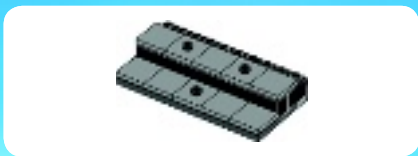

1

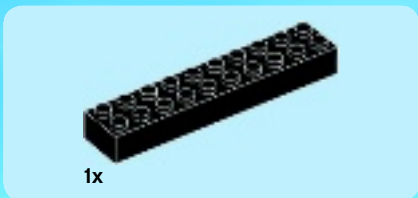
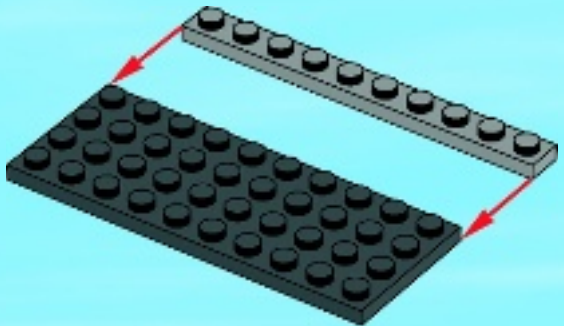

2

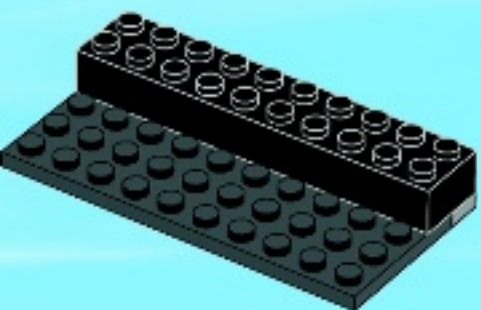

3

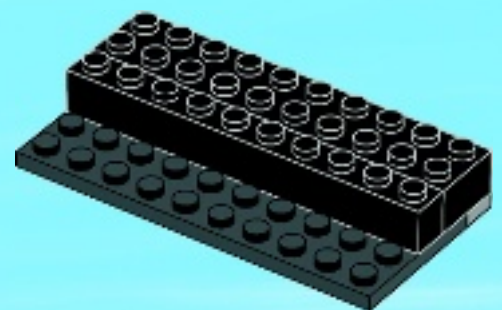



4x



1x

4

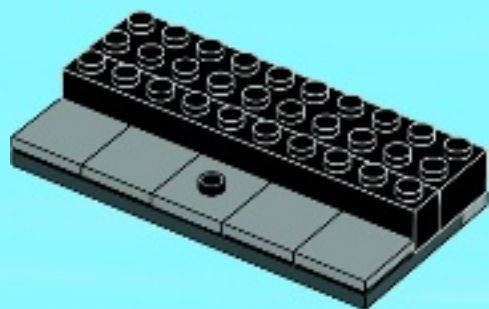

3x



2x

5

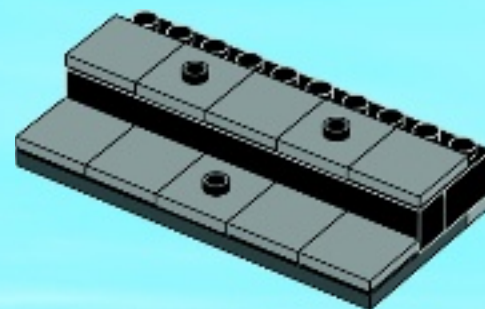



22

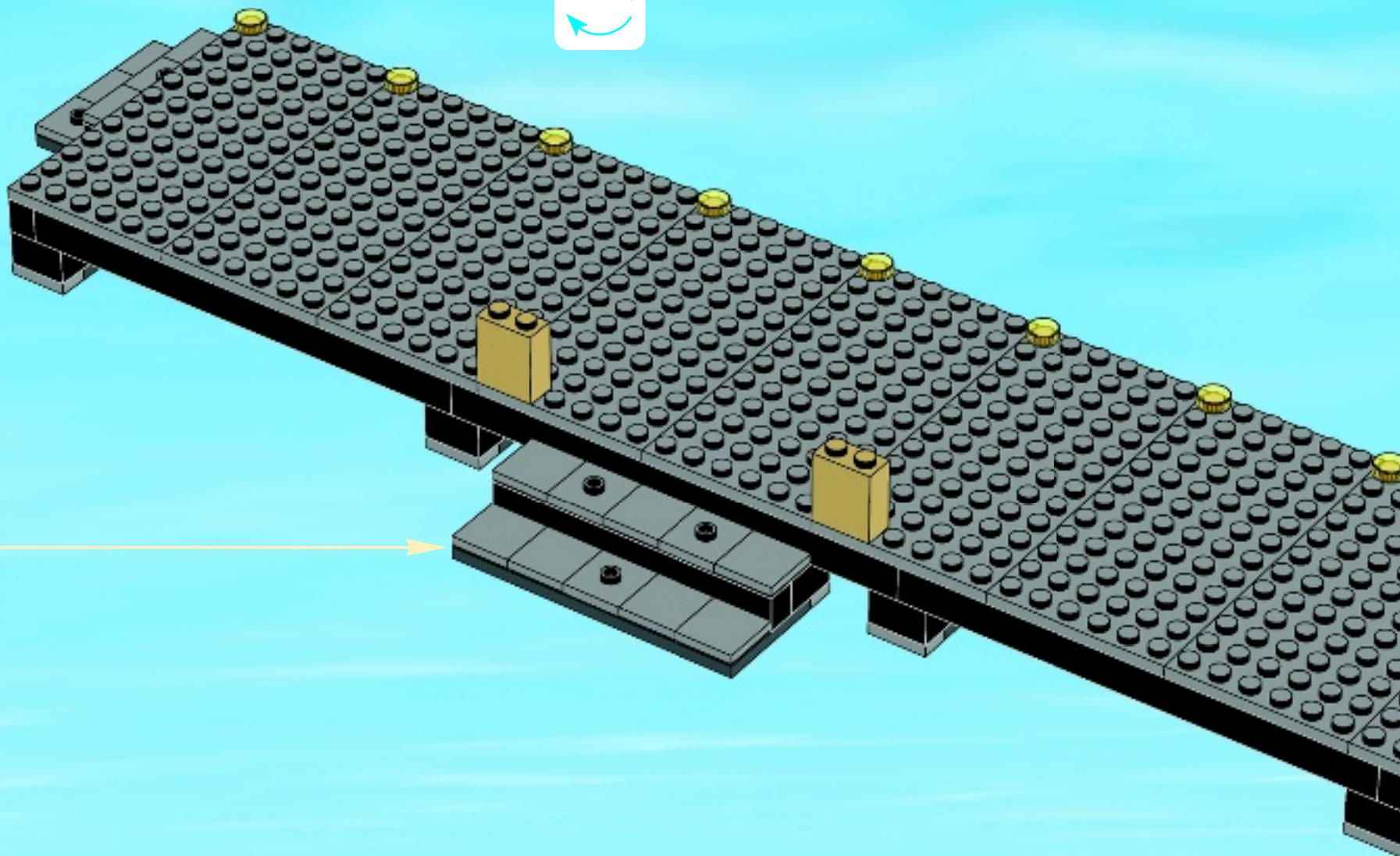

3

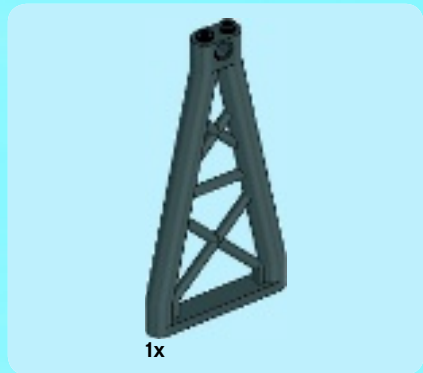
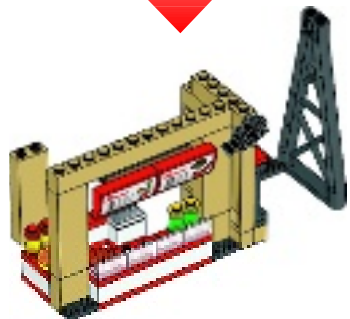

1x

23

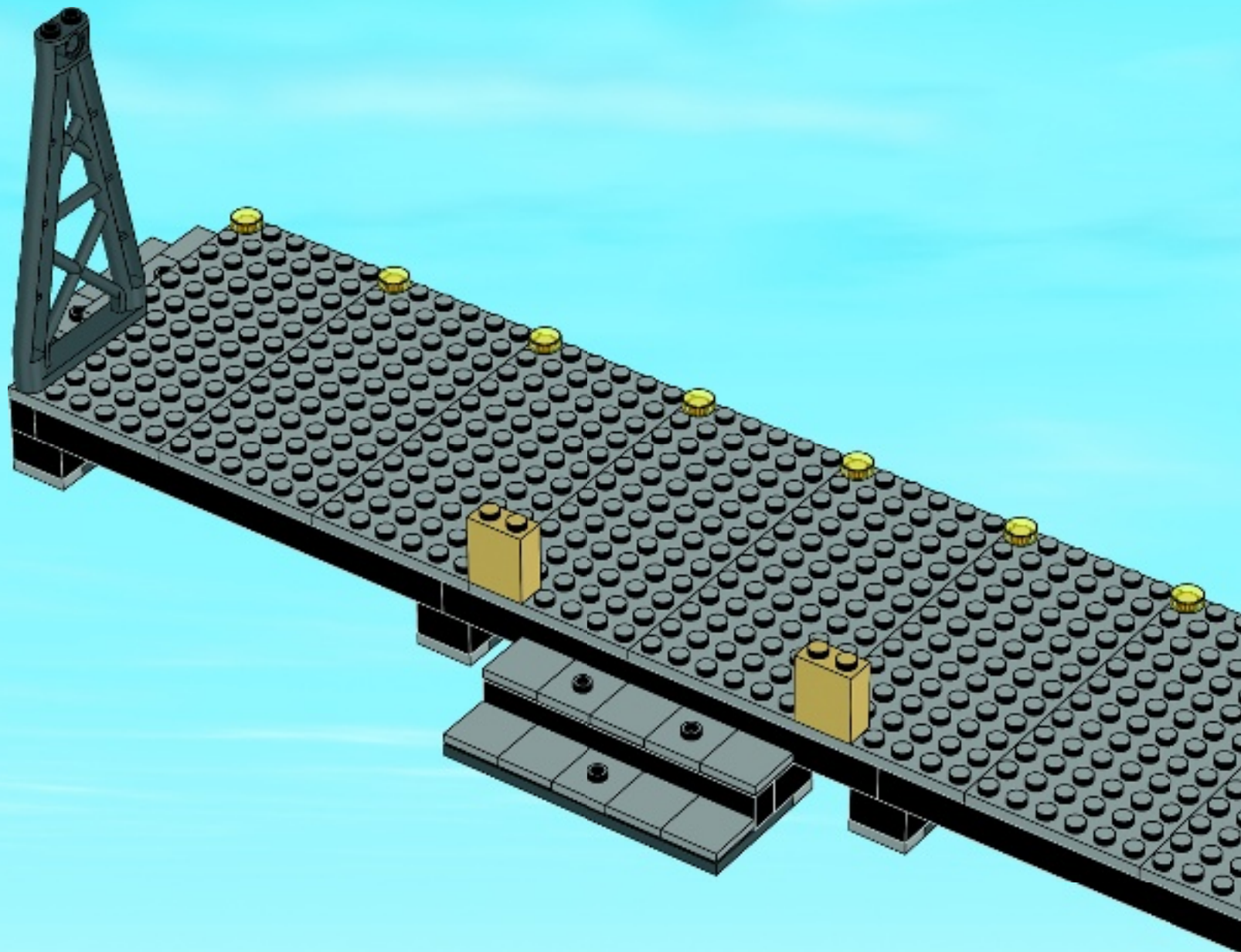



2x

24

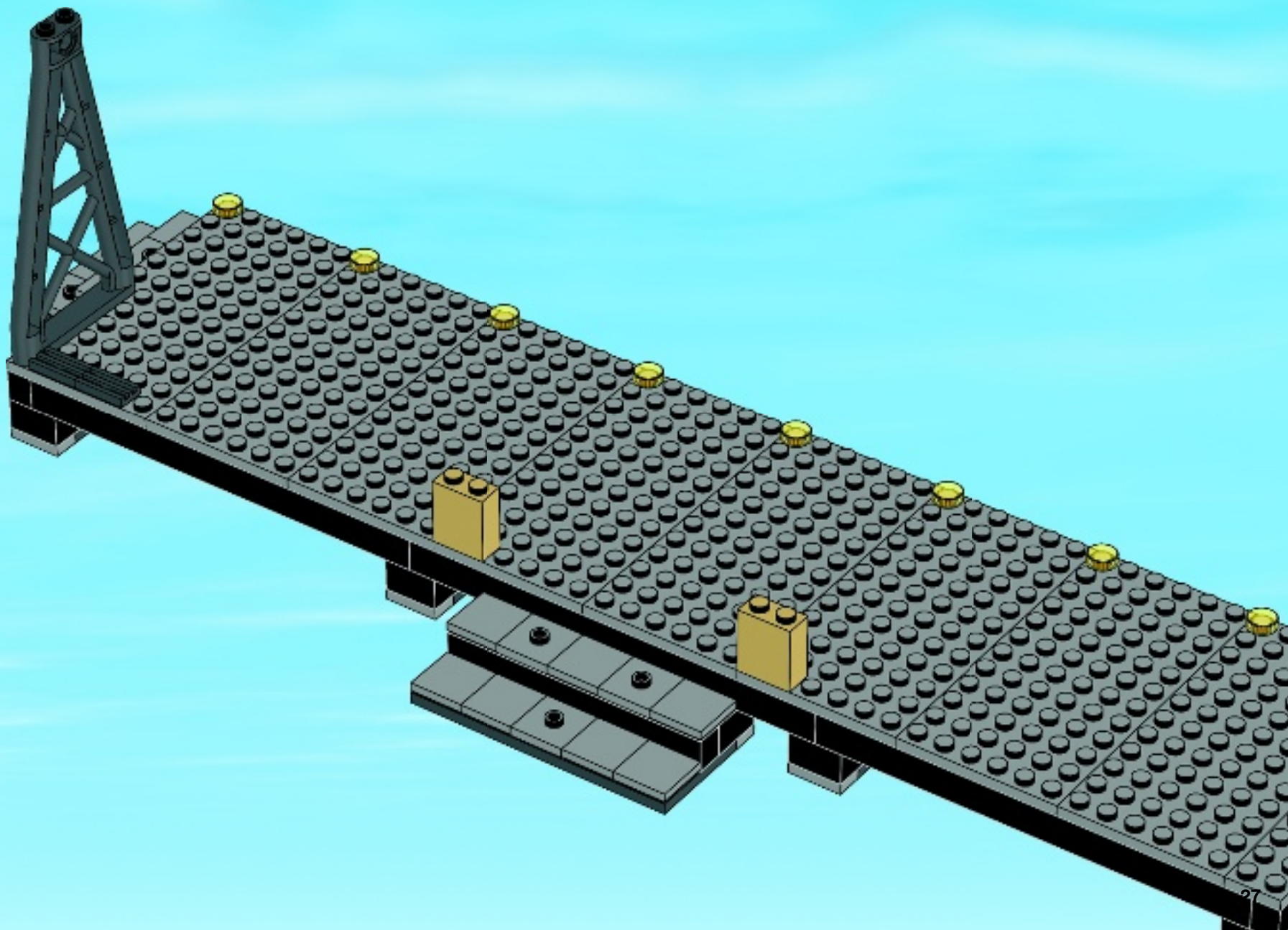

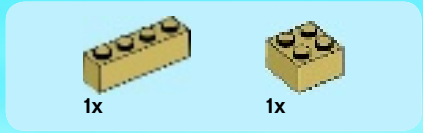

1

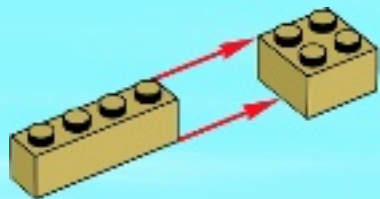

2

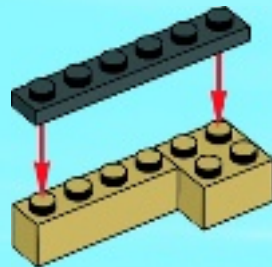

3

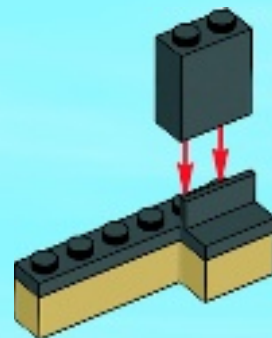

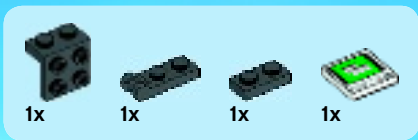

4

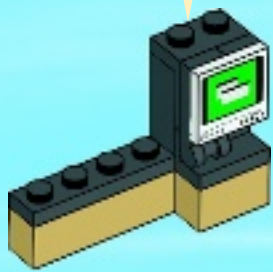
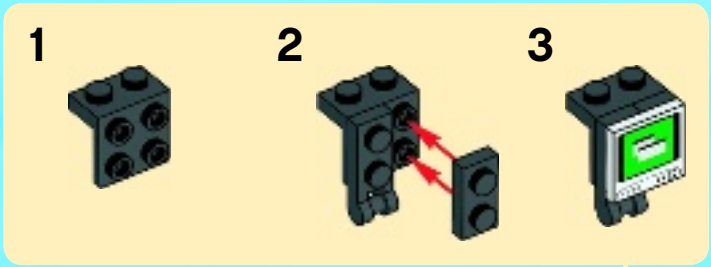

5

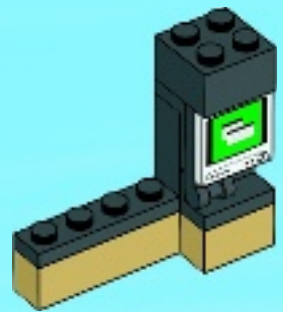

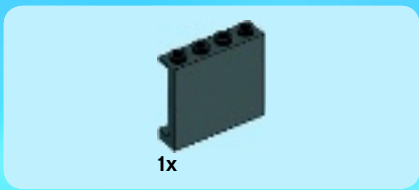

6

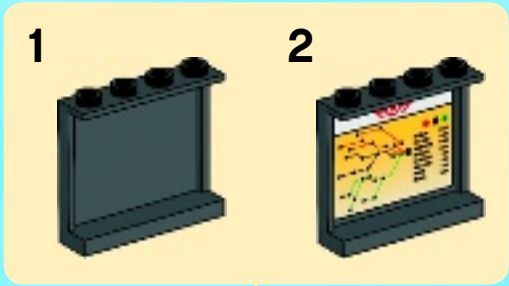

7

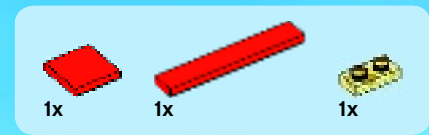

8

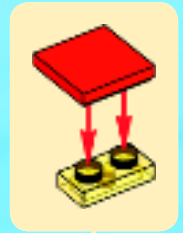

25

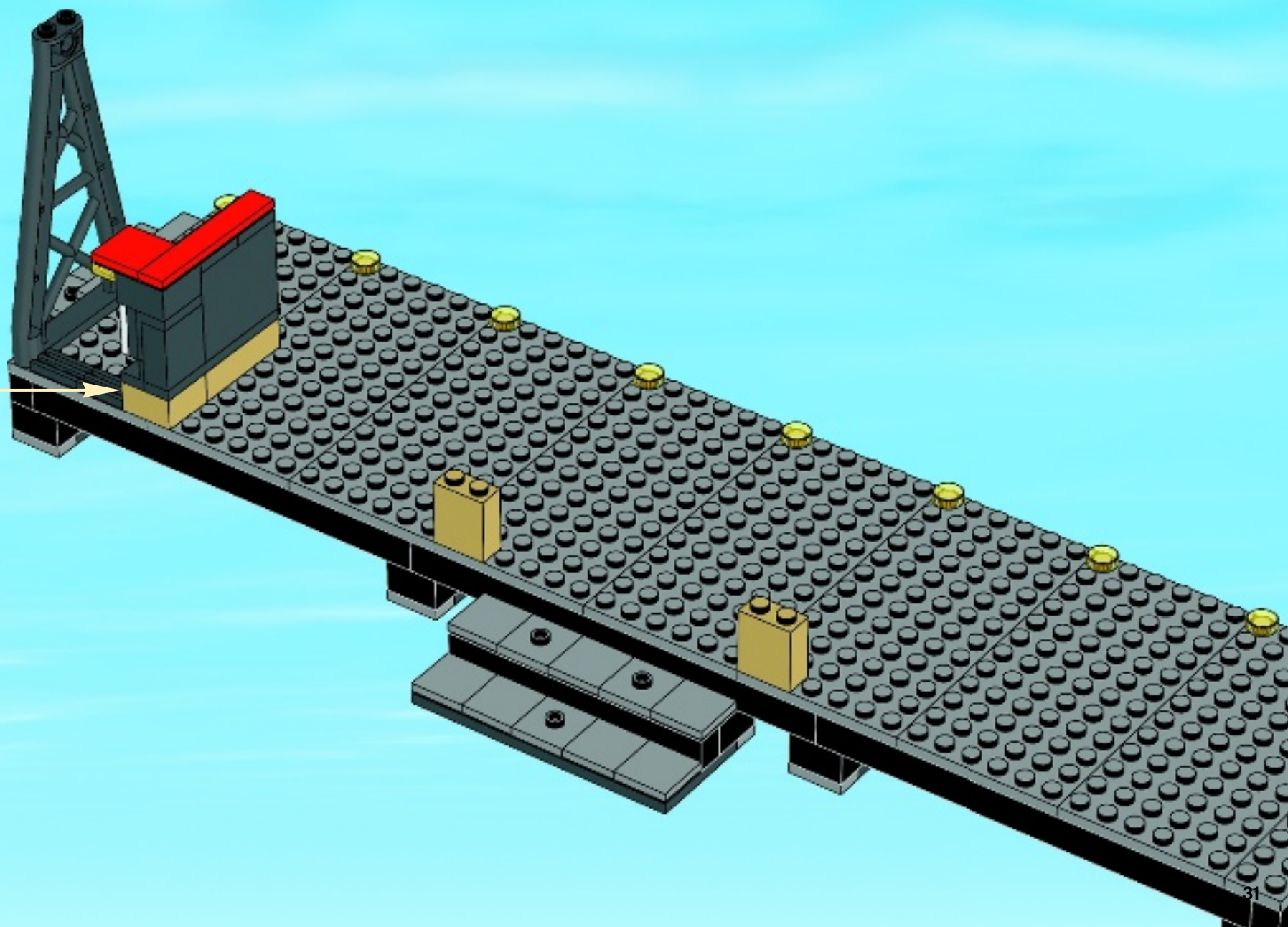

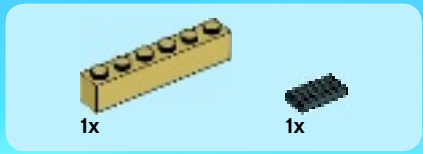

# 26

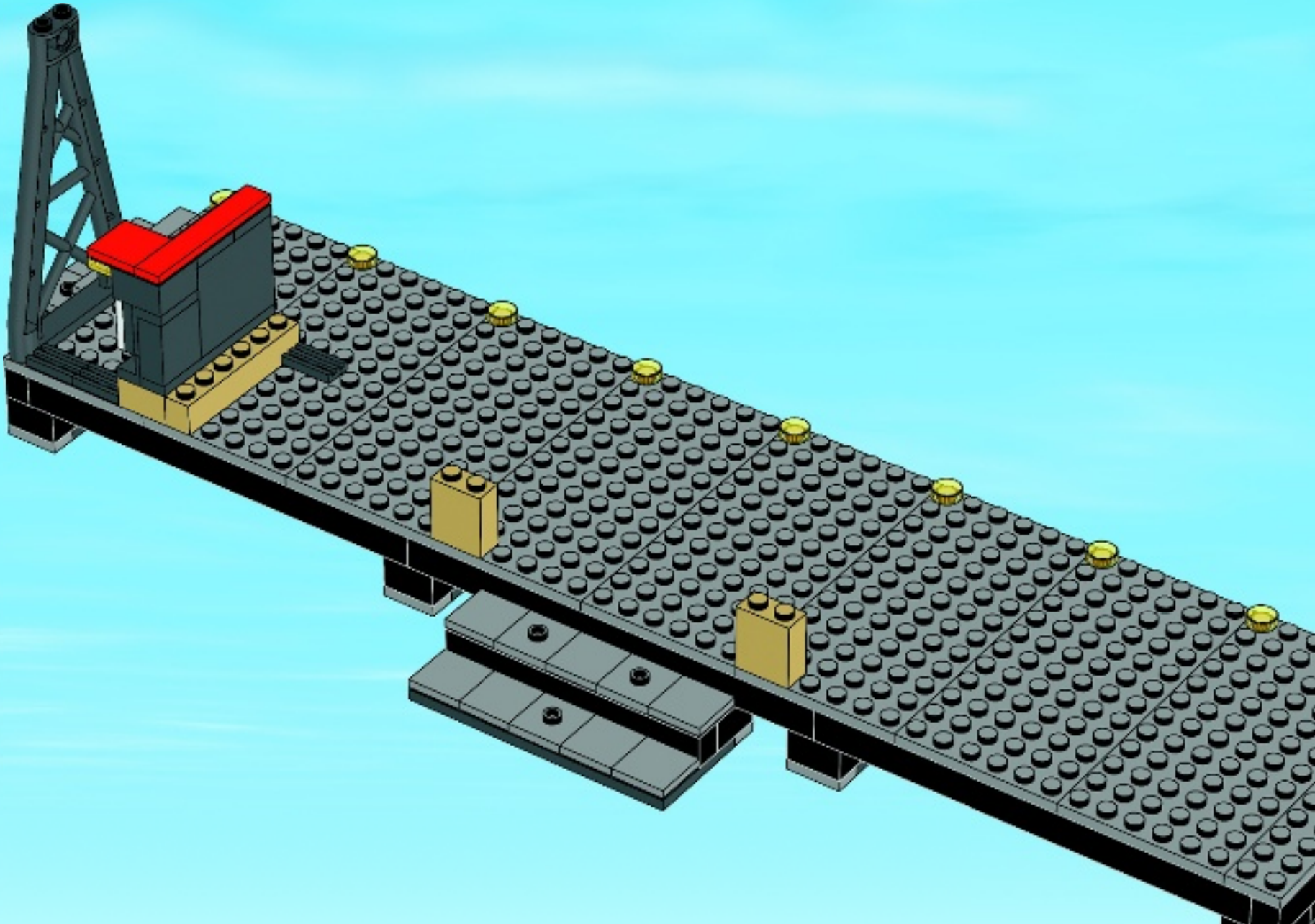



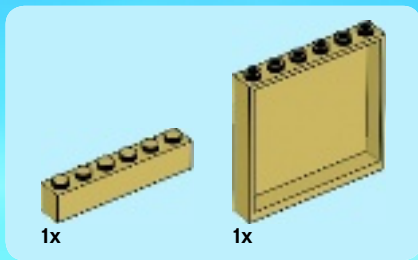

27

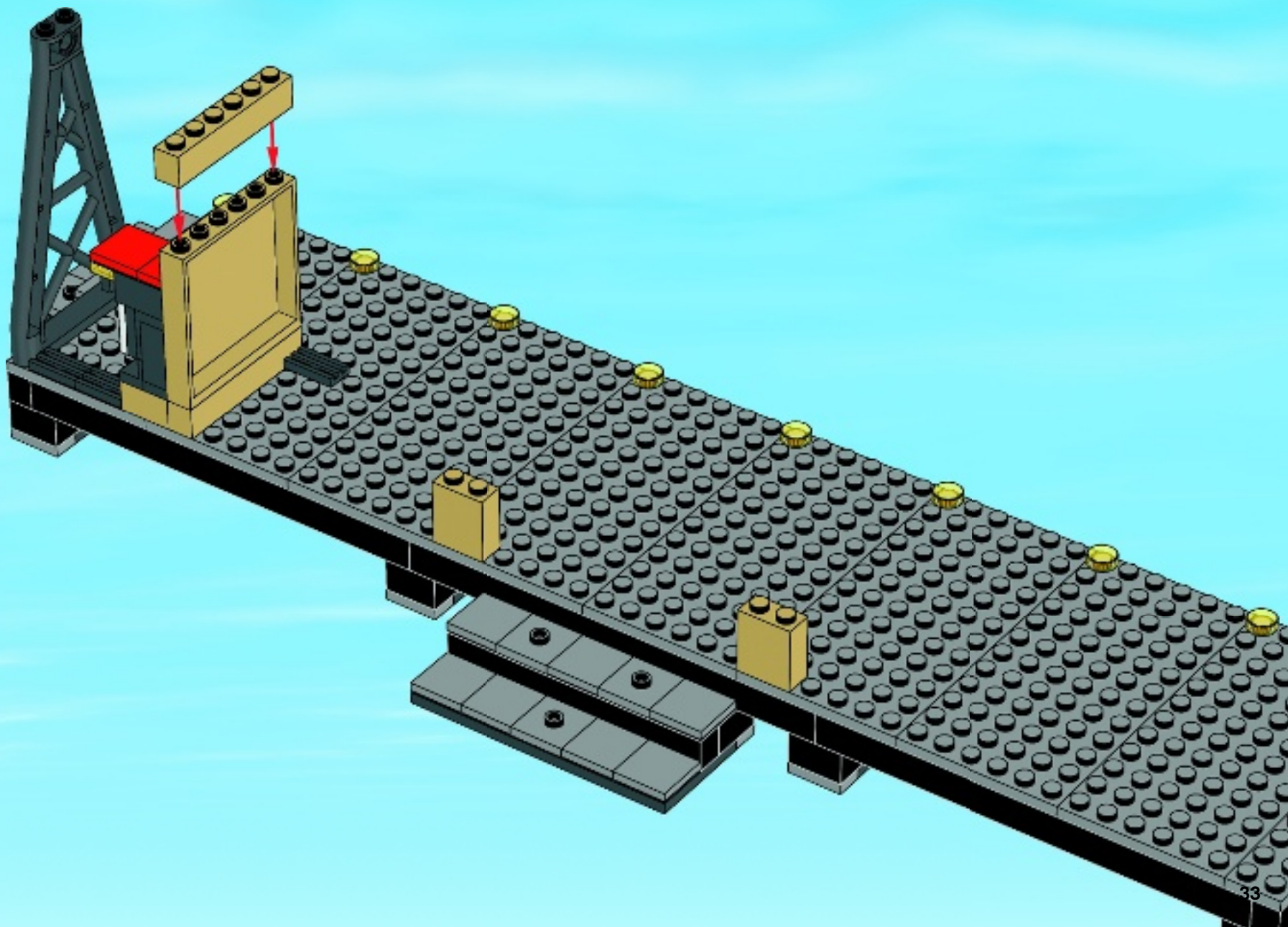

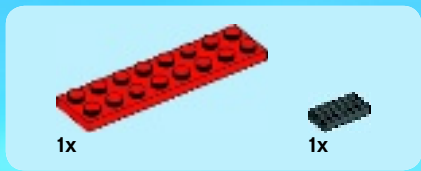

28

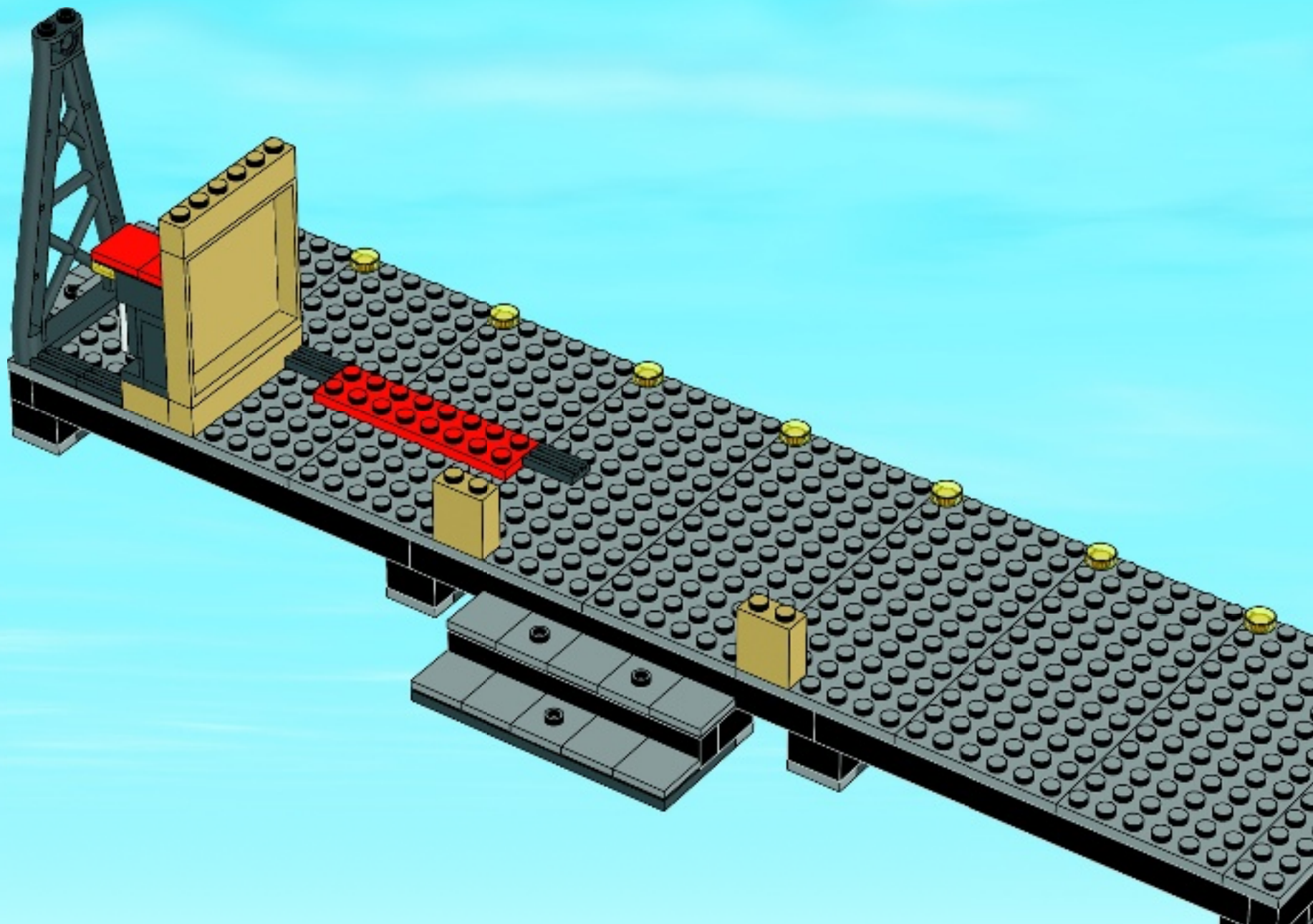



2x

29

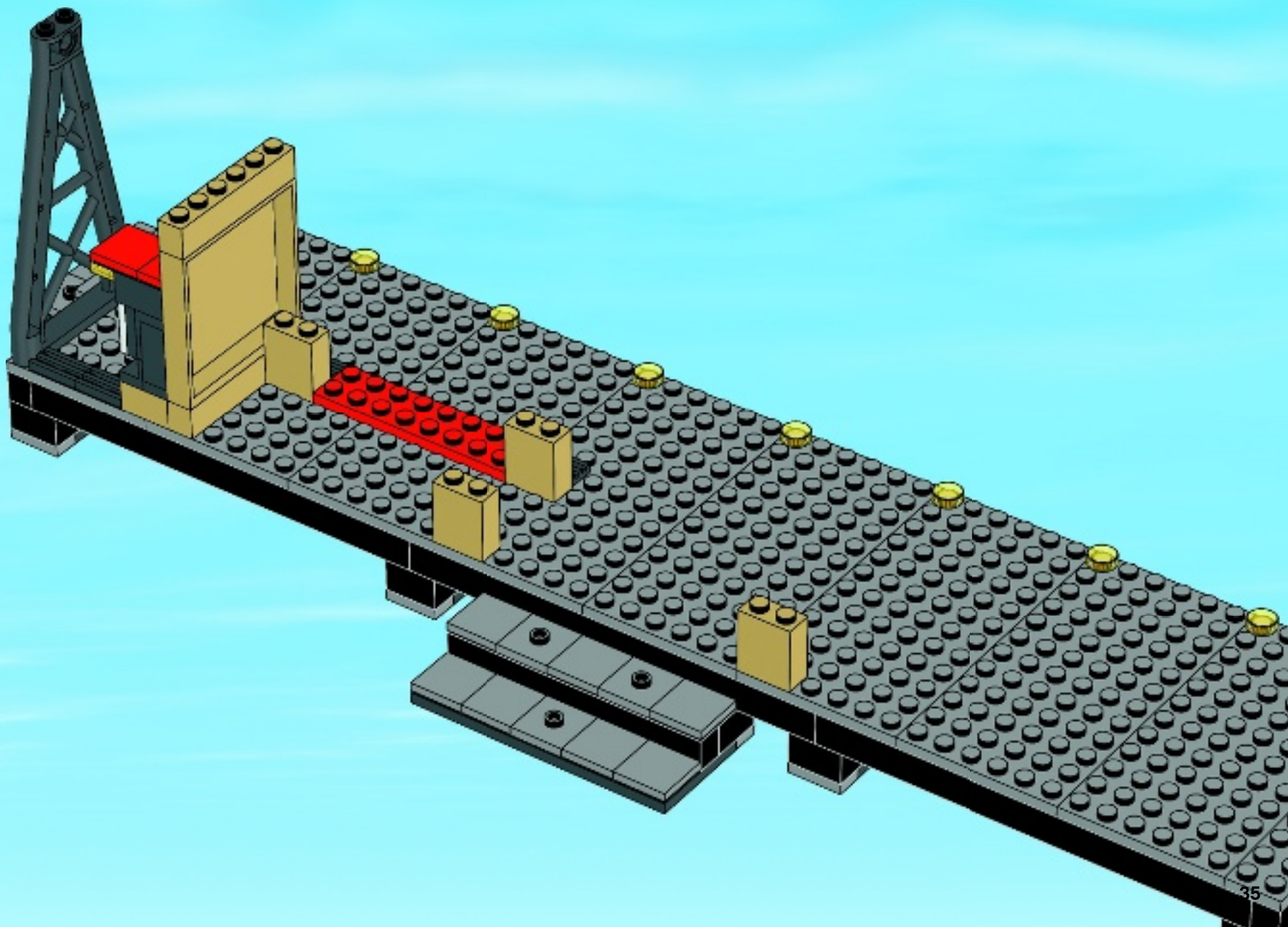



1x



1x



1x

# 30

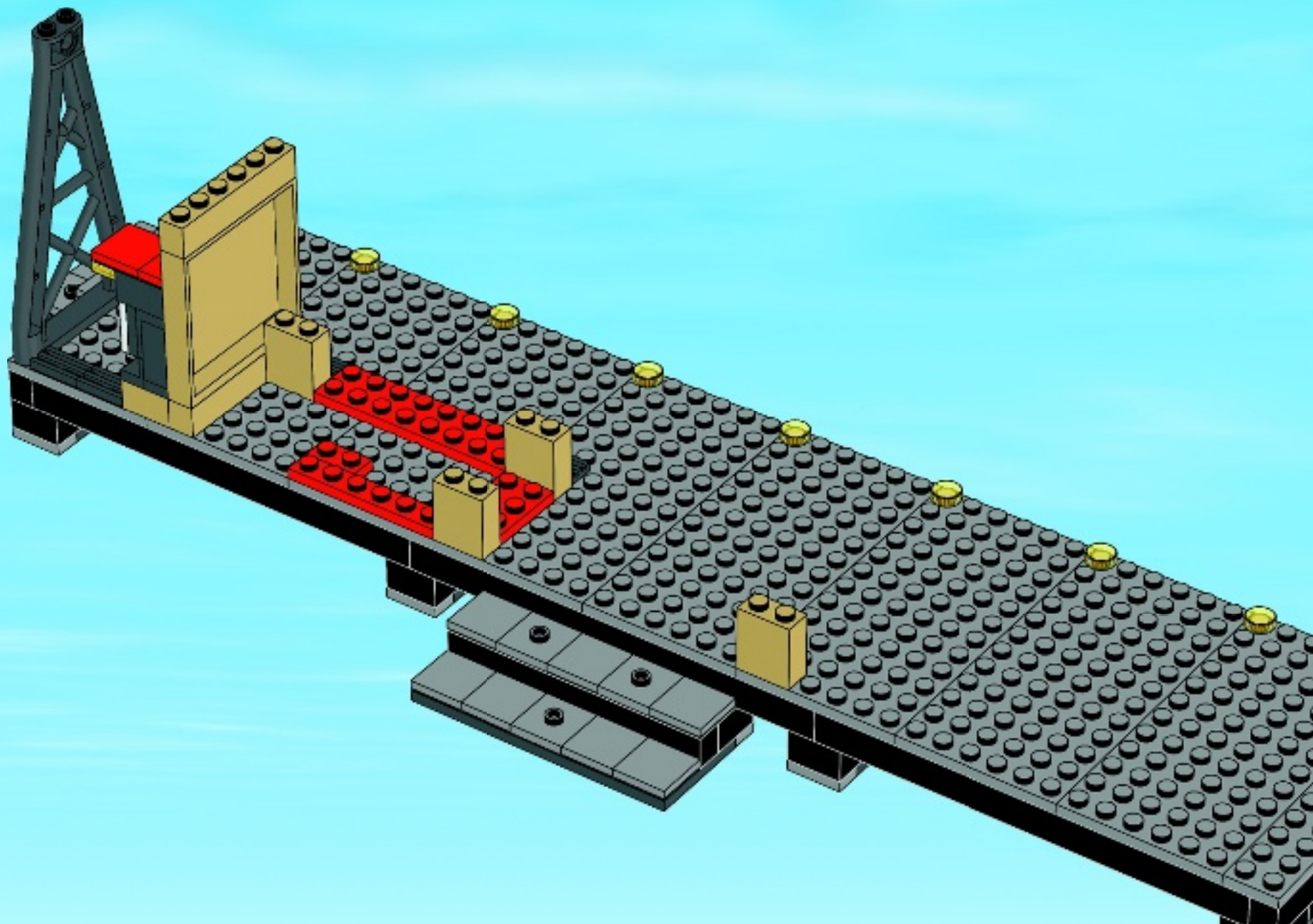

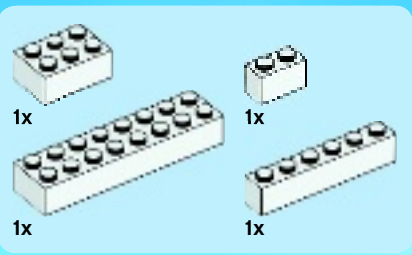

31

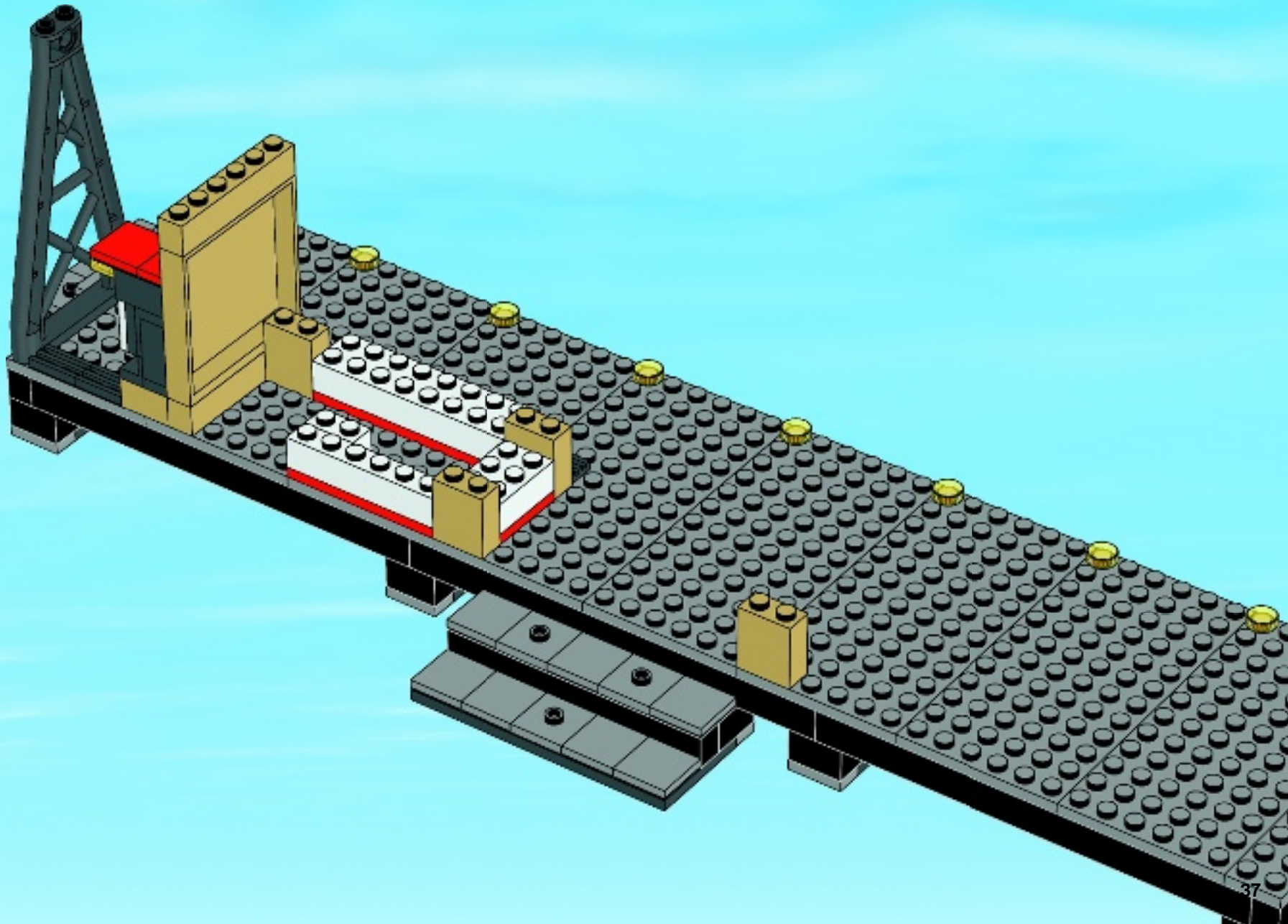







2x

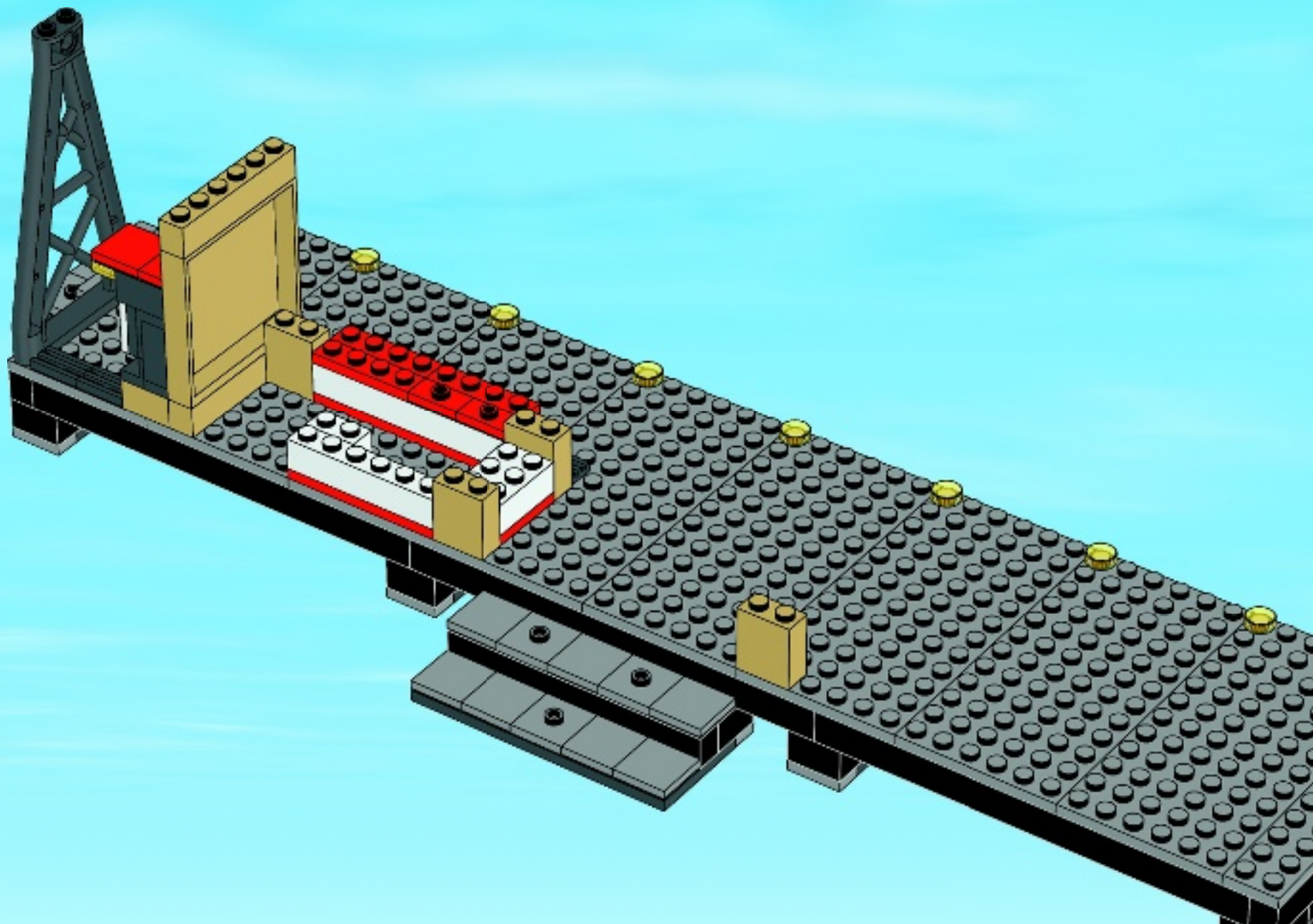

3x

# 32



- 1x 
- 1x 
- 1x 

# 33

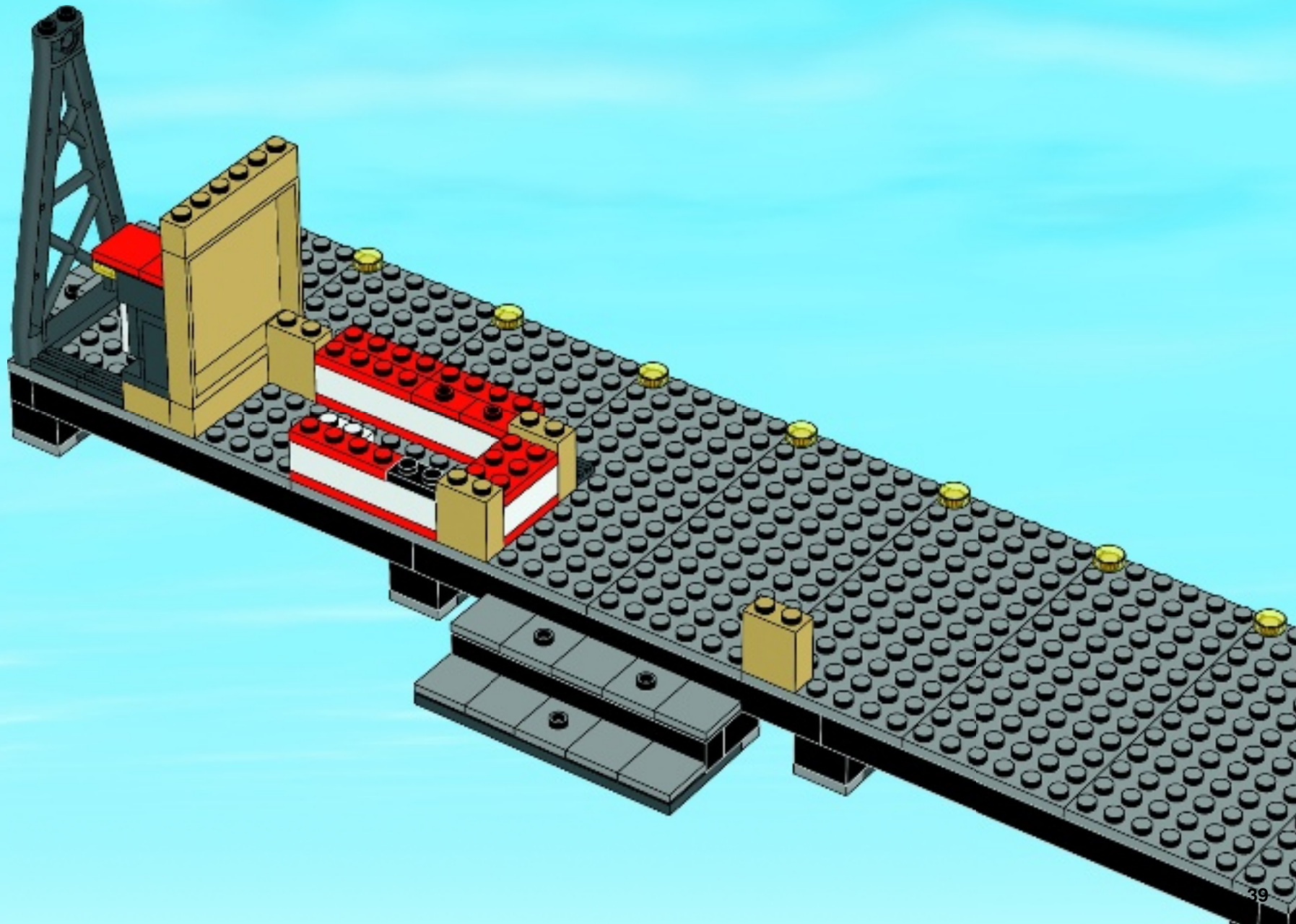



4x

# 34

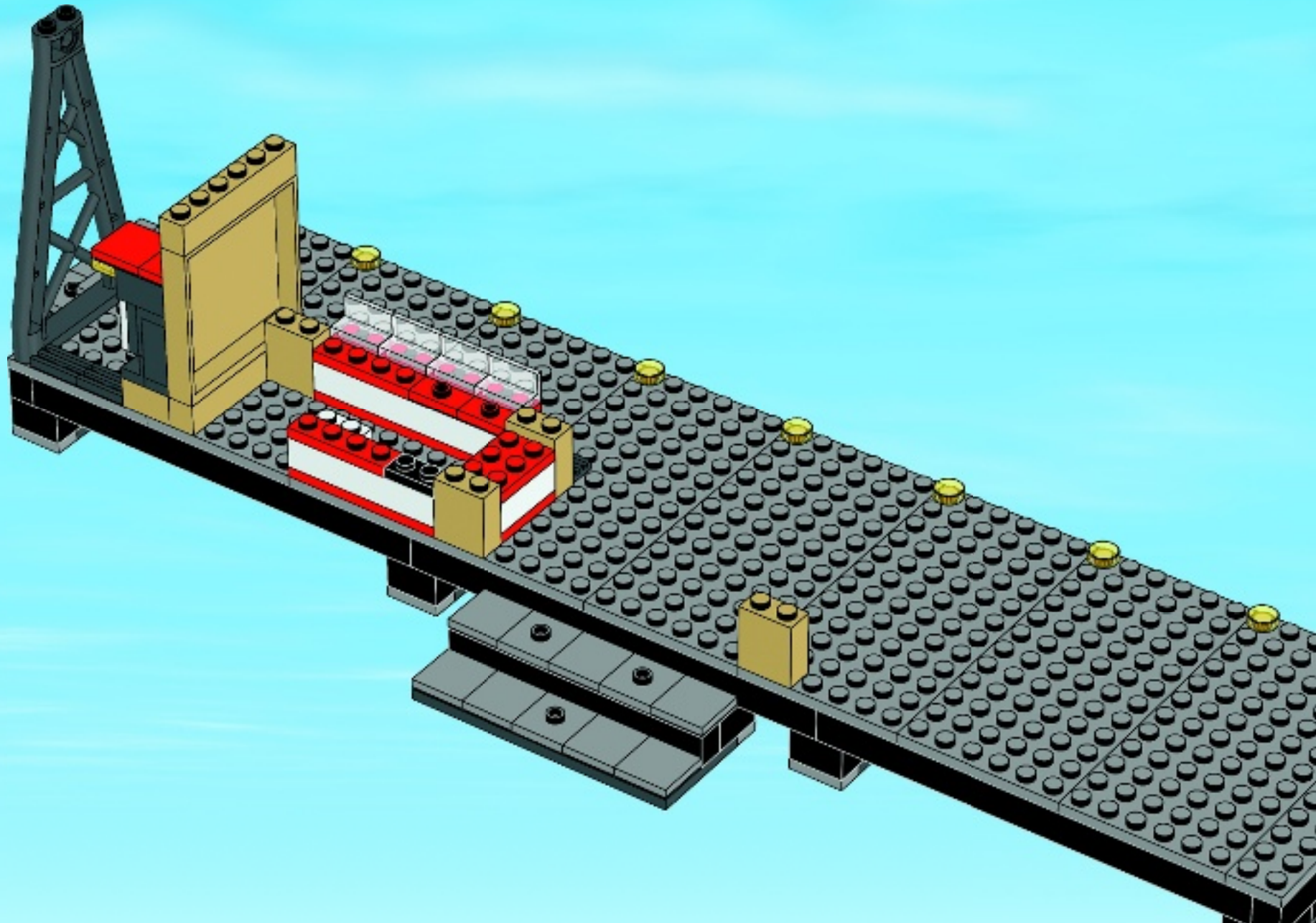



- 1x 
- 1x 
- 1x 
- 1x 

# 35

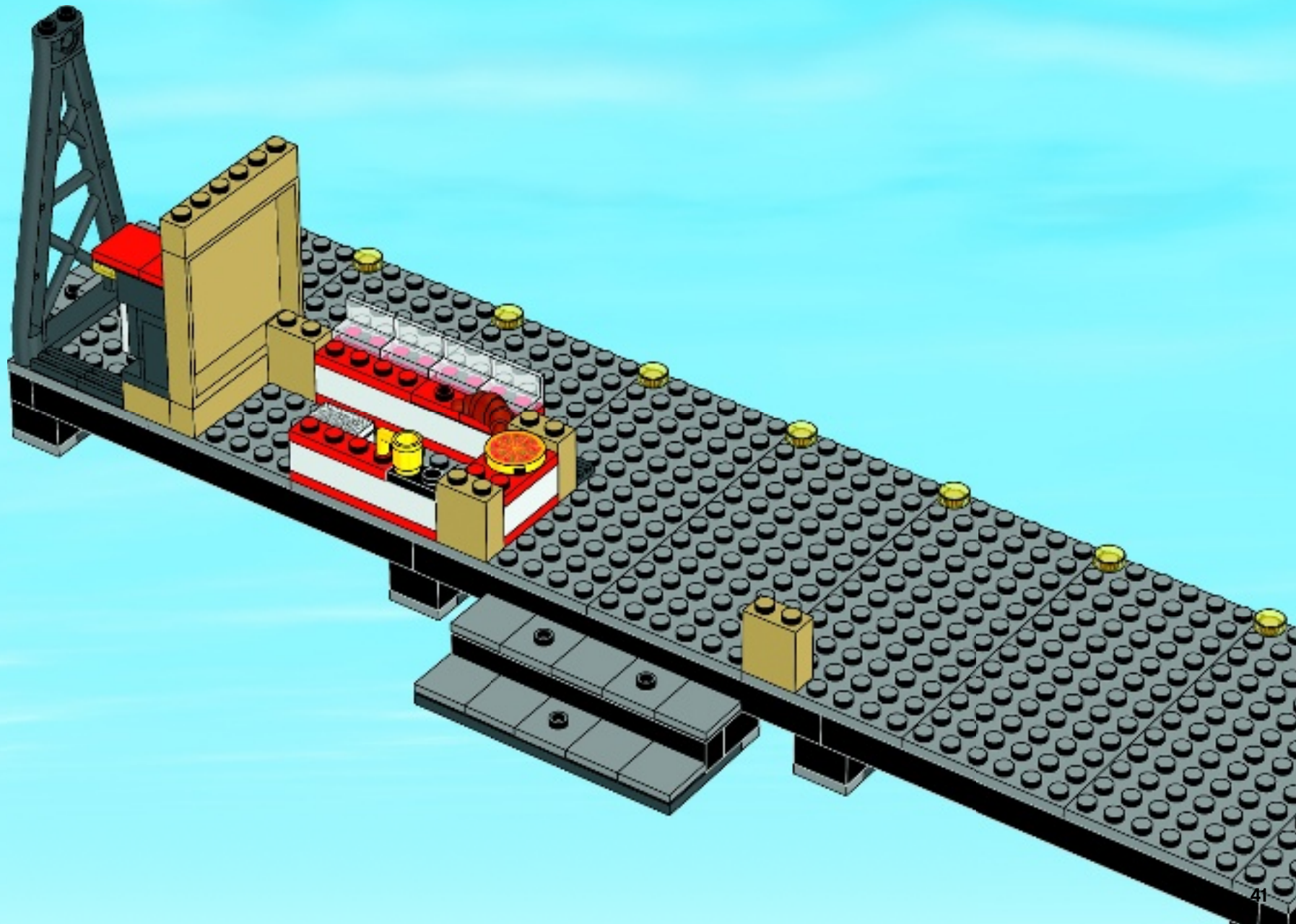



1x



1x



2x

# 36

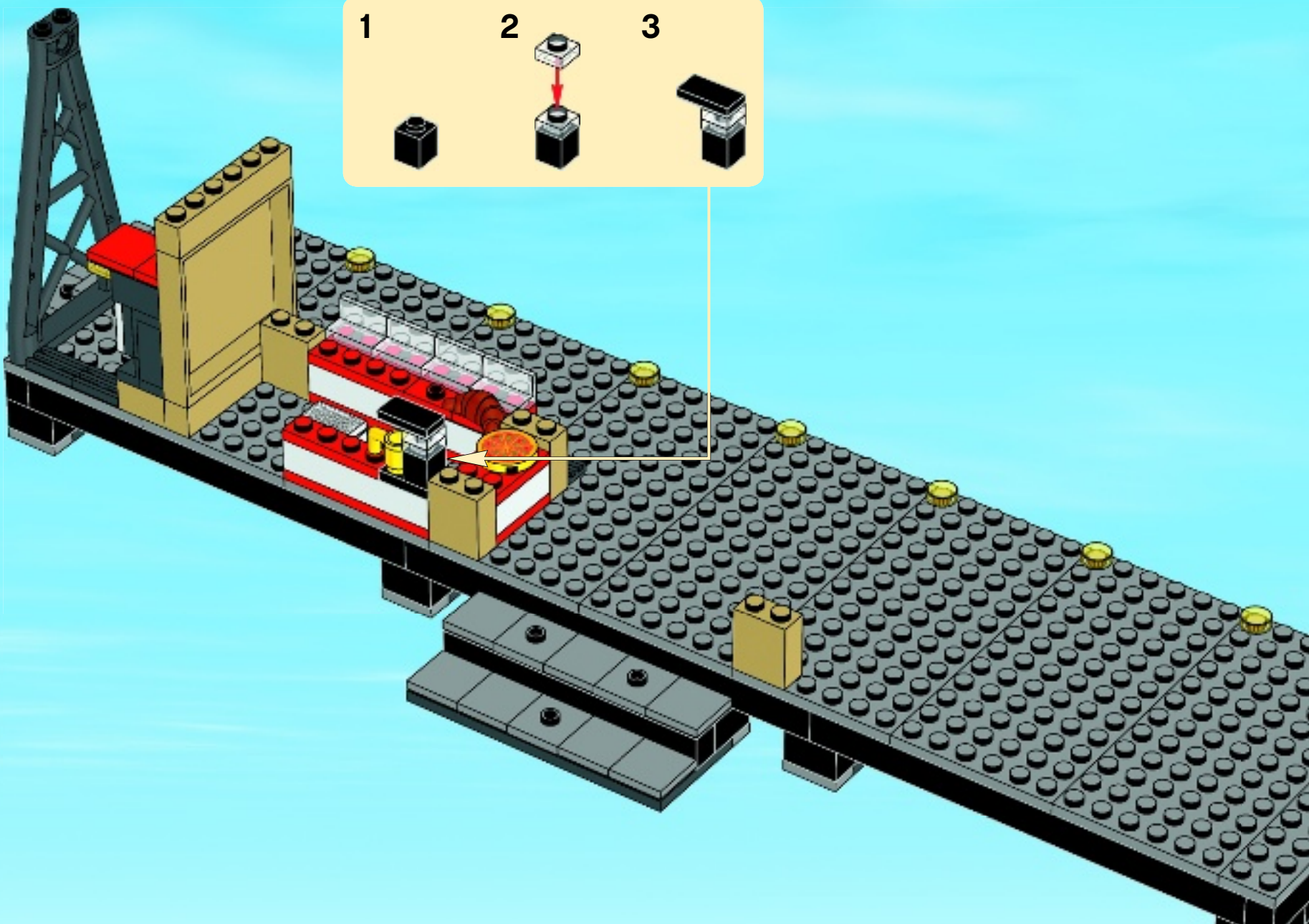



2x



2x



2x



2x

# 37



2x



2x

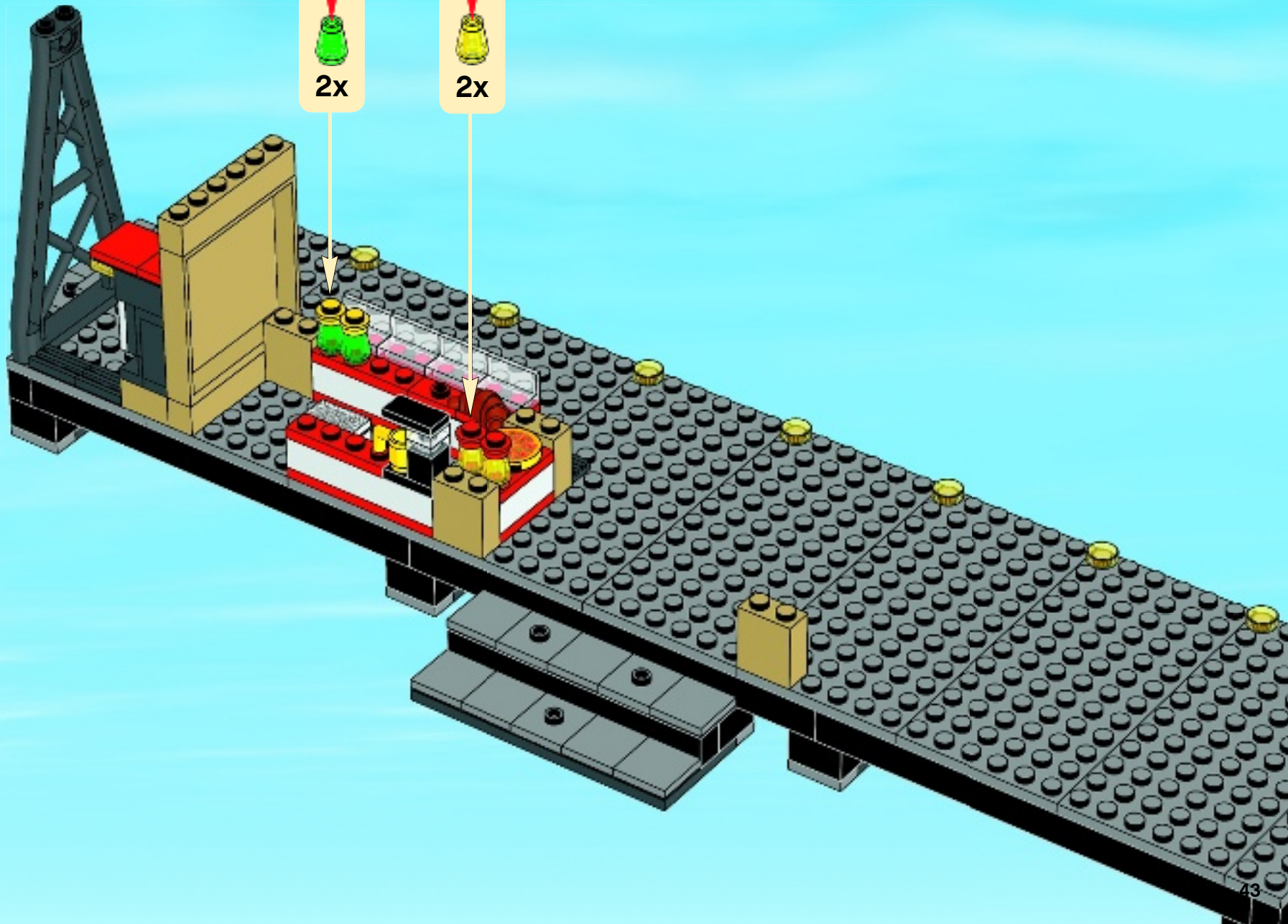



1x



1x

# 38





3x

39

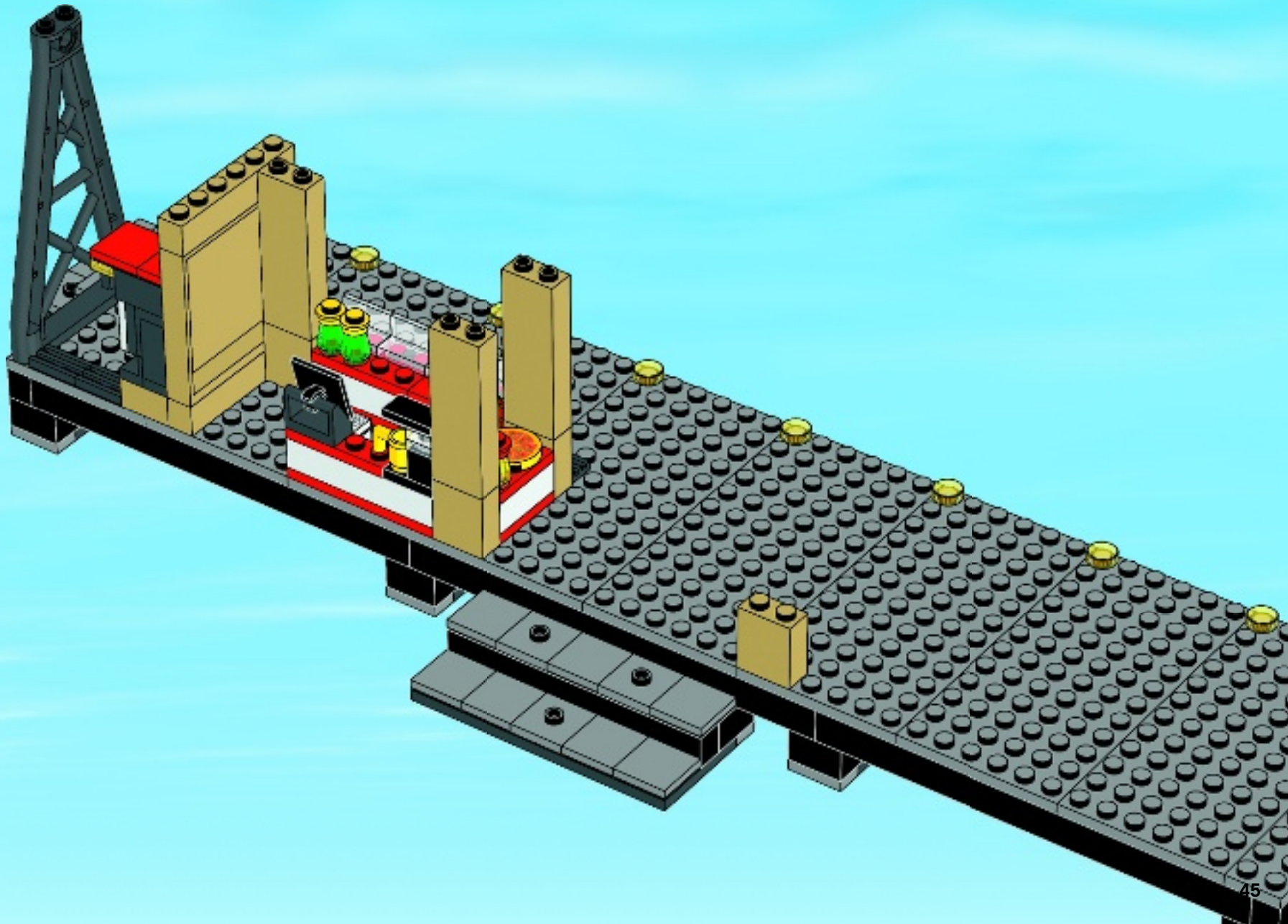

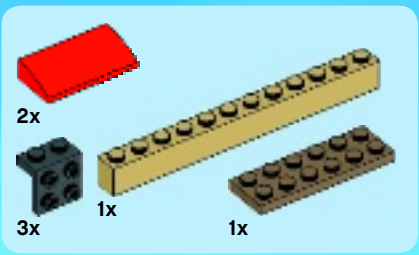

40

1

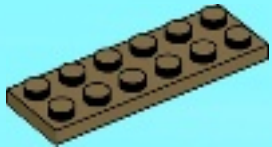

2

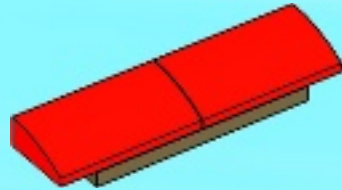

3

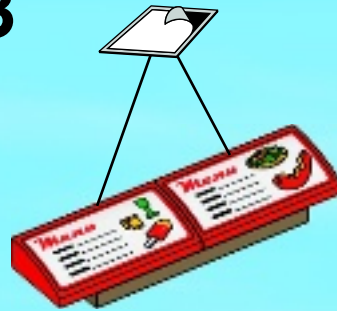

4

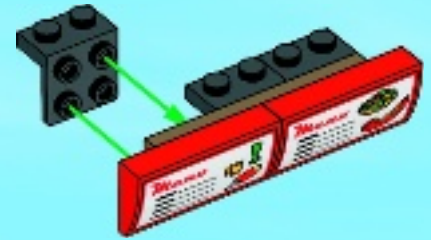

5

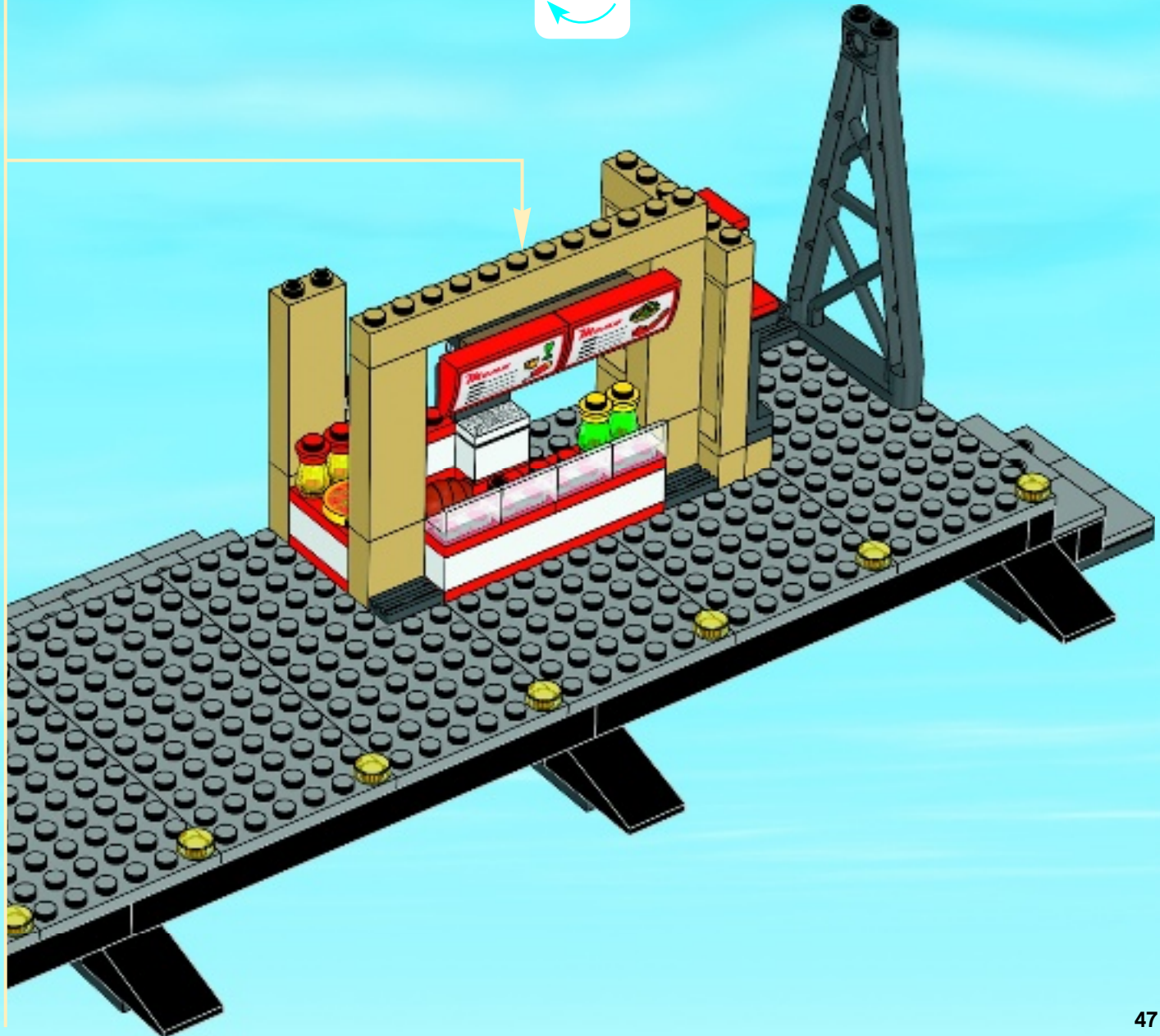



41

