



**SUPER  
MARIO**™

71431





LEGO.com/sustainable-packaging



FR  
**DONNEZ**  
OU  
**RECYCLEZ**



OU



OU



ASSOCIATION

MAGASIN

DÉCHÈTERIE

Adresses sur [quefairedemesdechets.fr](http://quefairedemesdechets.fr)

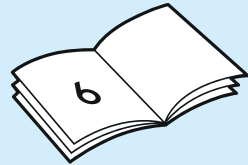
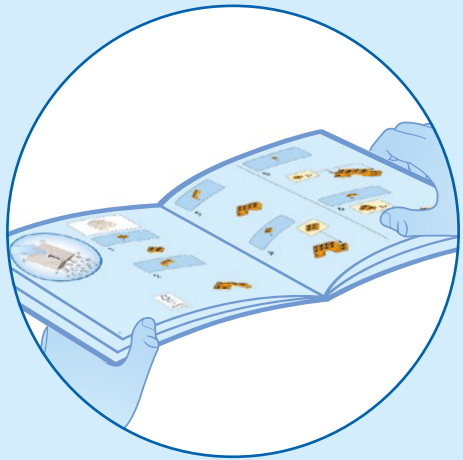
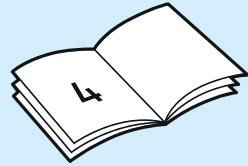
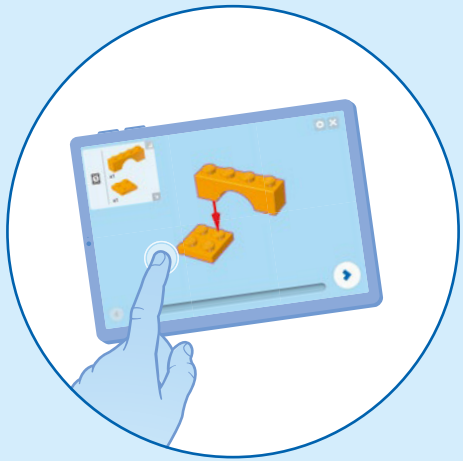



LEGO® Super Mario™ app

## 1. Scan QR code to build from digital building instruction



1. Scan QR code to build from digital building instruction
2. Open digital building instruction
3. Start building

1. Escanea el código QR para construir con instrucciones de construcción digitales
2. Abre las instrucciones de construcción digitales
3. Empieza a construir

1. Für digitale Bauanleitung den QR-Code scannen
2. Digitale Bauanleitung öffnen
3. Der Bauspaß kann beginnen

1. Lê o código QR para construir utilizando as Instruções de Construção digitais
2. Abrir as instruções de construção digitais
3. Começar a construir

1. Scanne le code QR pour construire avec les instructions de montage numériques
2. Ouvre les instructions de montage numériques
3. Commence à construire

1. 扫描二维码, 在数字拼搭说明的协助下拼搭
2. 打开数字拼搭说明
3. 开始拼搭

1. Scansiona il codice QR per scaricare le istruzioni digitali per costruire
2. Apri le istruzioni digitali per costruire
3. Inizia a costruire

1. Zeskanuj kod QR, aby budować dzięki cyfrowym instrukcjom budowania
2. Otwórz cyfrową instrukcję budowania
3. Rozpocznij budowanie



## 2. Open digital building instruction

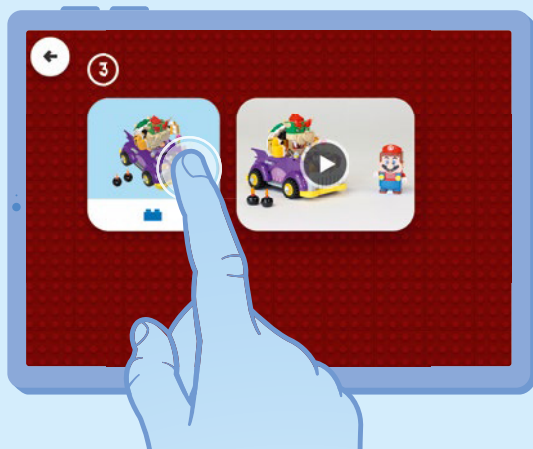

1. Naskenujte QR kód a stavte podle digitálního návodu
2. Otevřete digitální návod na stavění
3. Pusťte se do stavění

1. Сканирайте QR кода, за да започнете строите с цифрови инструкции за построяване
2. Отворете цифровите инструкции за построяване
3. Започнете да строите

1. Naskenujte QR kód a stavajte podľa digitálneho návodu
2. Otvorte digitálny návod na stavanie
3. Pusťte sa do stavania

1. Skenē QR kodu, lai būvētu, izmantojot digitālas būvēšanas instrukcijas
2. Atver digitālo būvēšanas instrukciju
3. Sākt būvēt

## 3. Start building

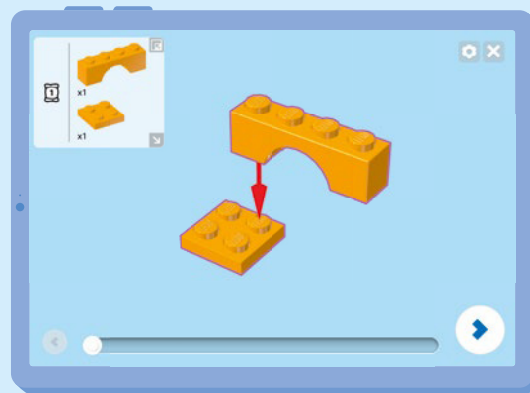

1. Olvasd be a QR-kódot a digitális építési útmutató használatához!
2. Digitális építési útmutató megnyitása
3. Kezdődjön az építés!

1. Skanni QR-kood, et ehitada digitaalsete ehitusjuhisteiga
2. Ava digitaalsed ehitusjuhised
3. Alusta ehitamist

1. Scanează codul QR pentru a construi pe baza instrucțiunilor digitale
2. Deschide instrucțiunile de construcție digitale
3. Începe să construiești

1. Nuskaitykite QR kodą ir konstruokite naudodamiesi instrukcijomis
2. Atidarykite skaitmenines instrukcijas
3. Konstruokite



1

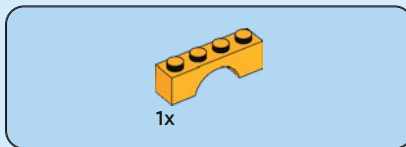

2

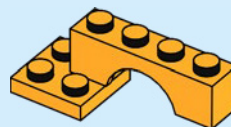

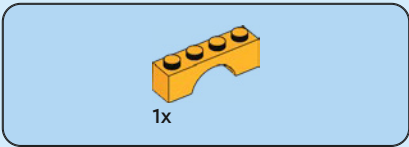

3

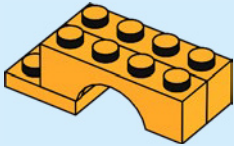

4

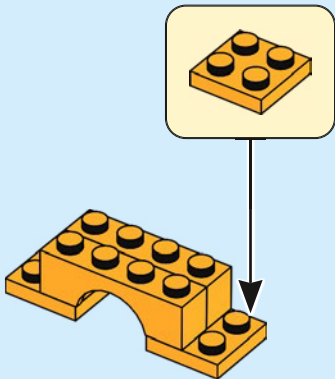

5

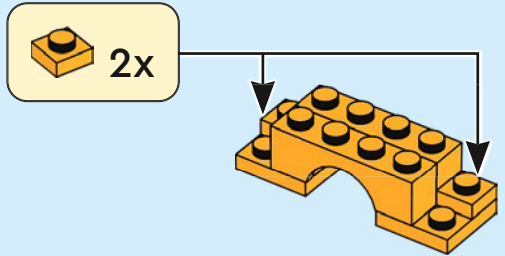

6

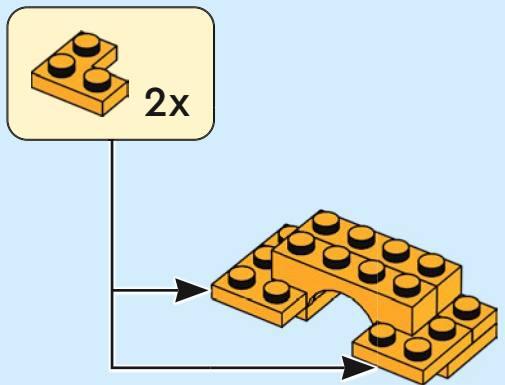



2x

7

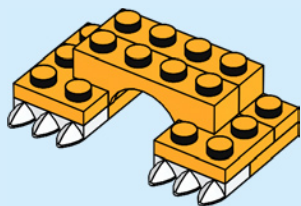

4x

8

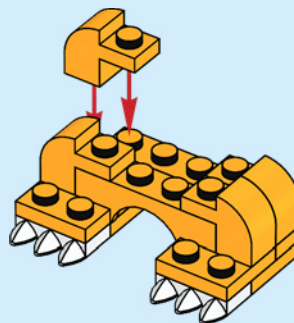

2x

9

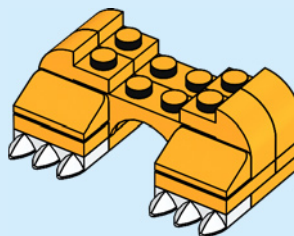

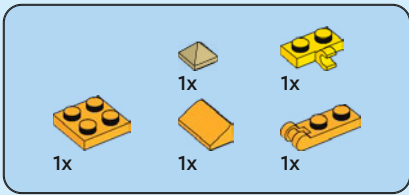

10

1

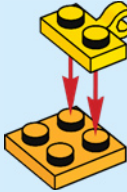

2

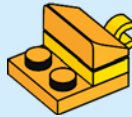

3

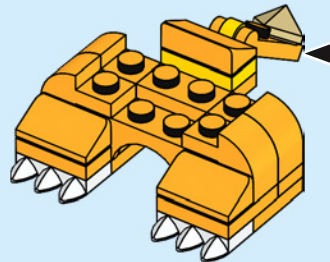
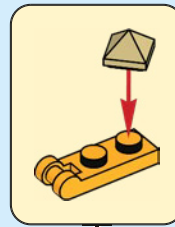
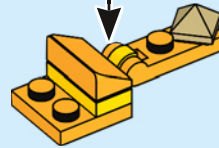





2x

11

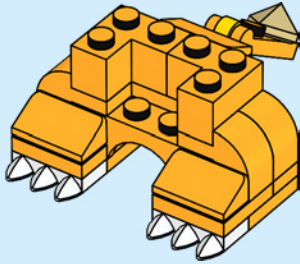

1x

12

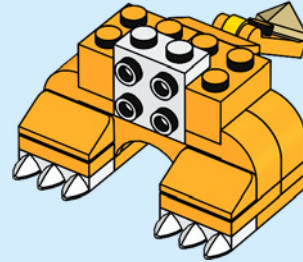

2x



2x

13



2x

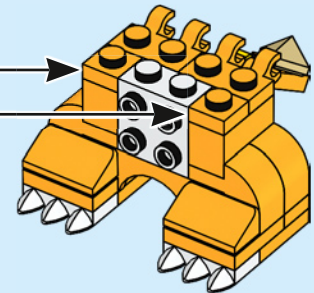

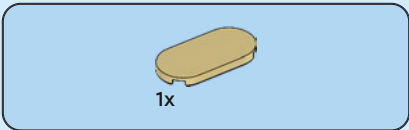

14

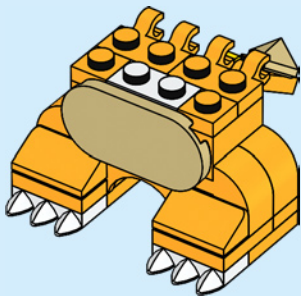

15

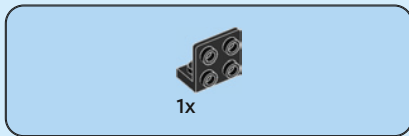
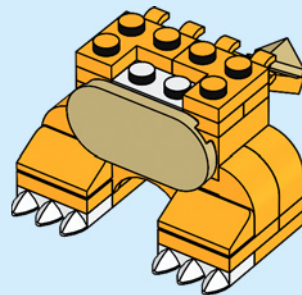

16

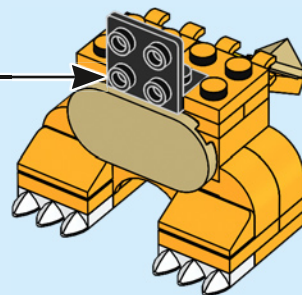



2x

17

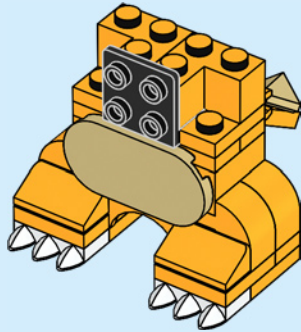

2x

18

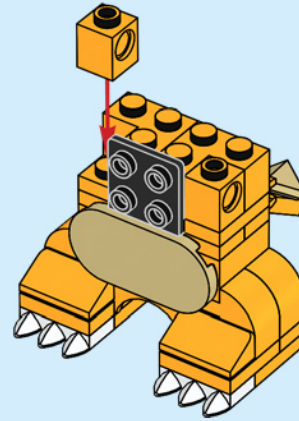

1x

19

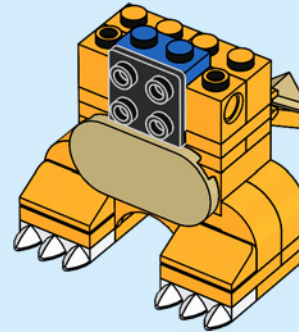



2x



2x

# 20

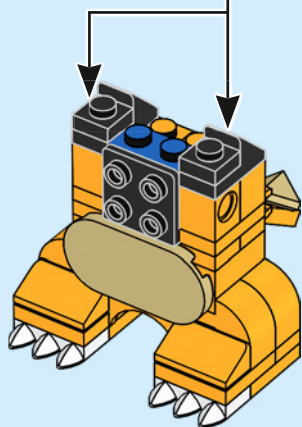
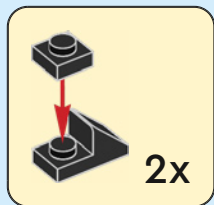

2x

# 21

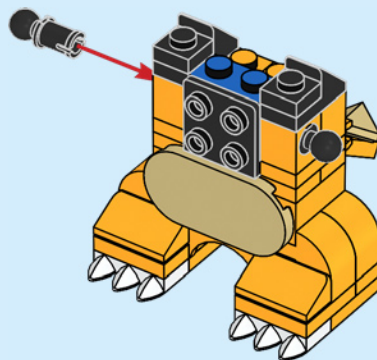



1x

22

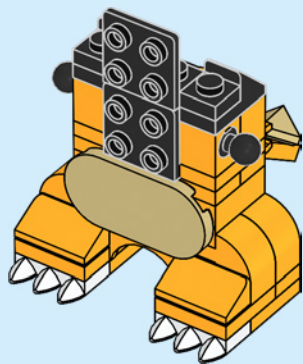

1x

23

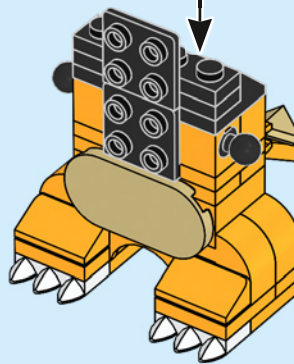
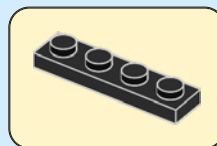



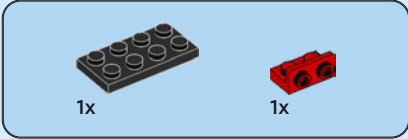

24

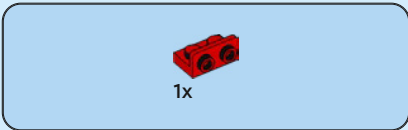
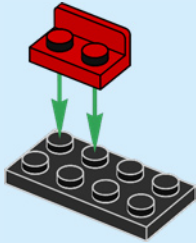

25

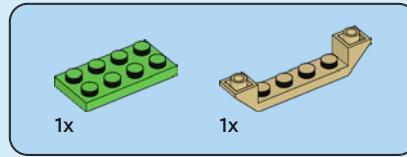
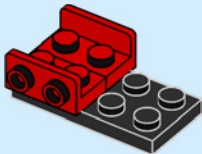

26

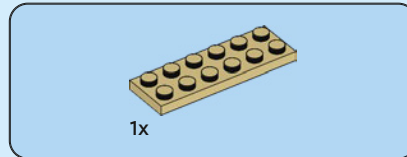
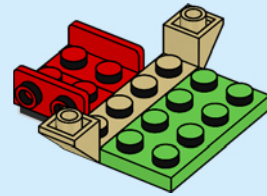

27

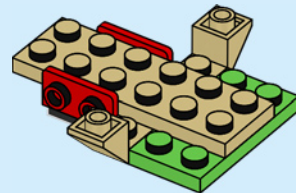



2x

28

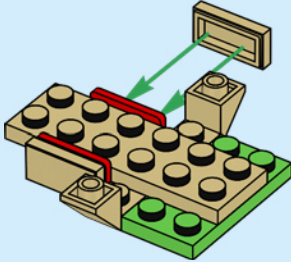

1x



1x

30

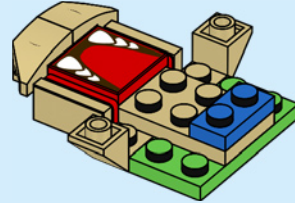

1x



1x



1x

29

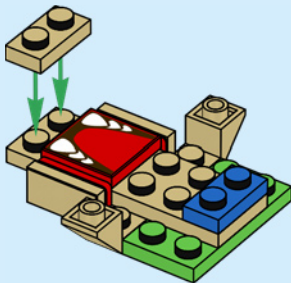

2x

31

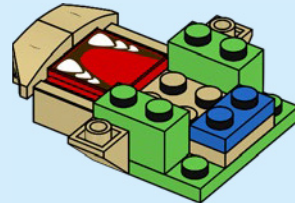



2x

32

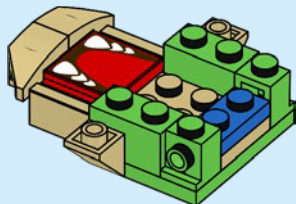

1x

33

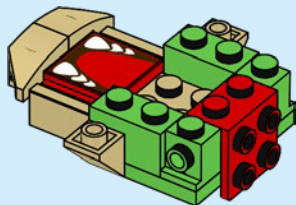

2x

34

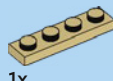
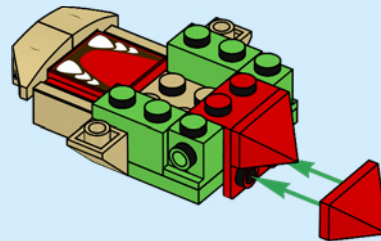

1x

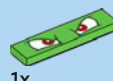

1x



2x

35

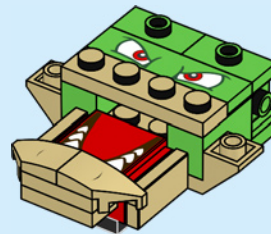



2x

36

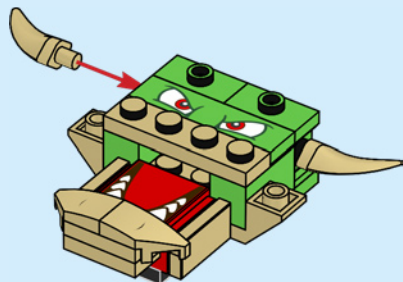

2x

37

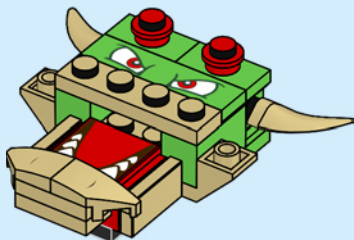

1x



1x

38

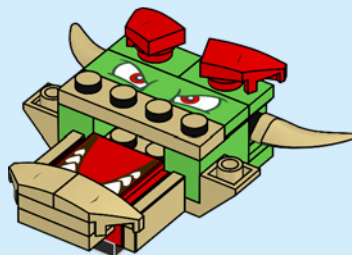

2x

39

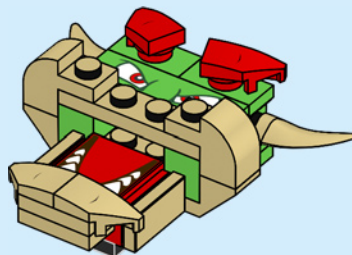



2x



1x

# 40

1

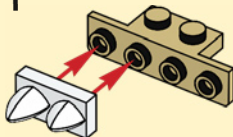

2

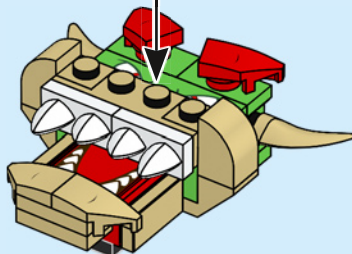
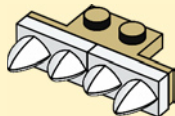

2x

# 41

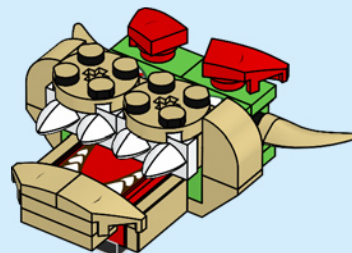

1x

# 42

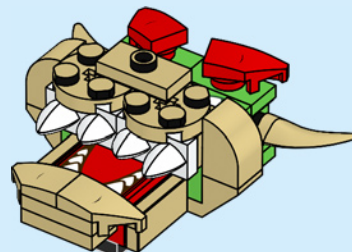





2x



2x

43

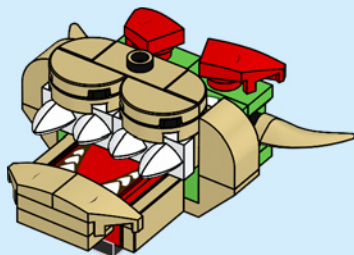

1x

44

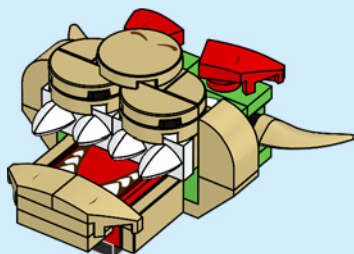

45

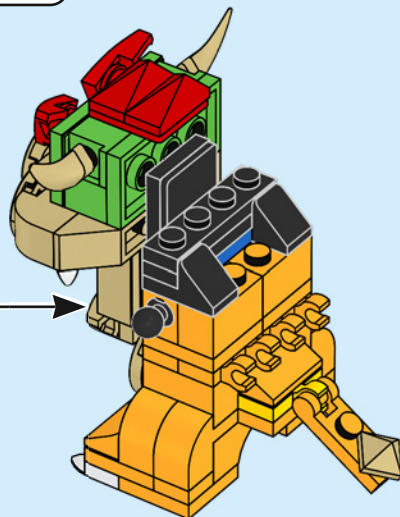

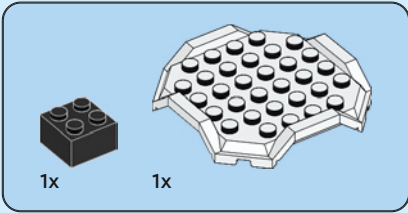

46

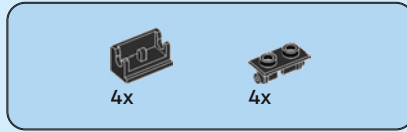
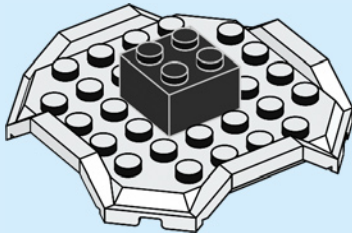

47

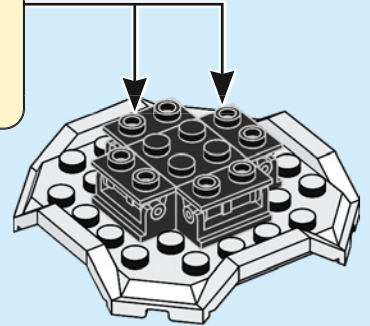
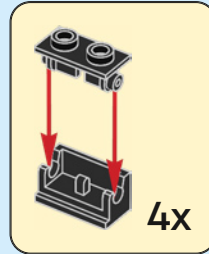

48

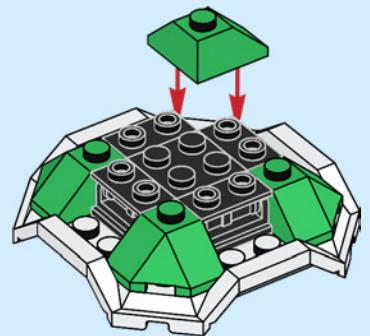

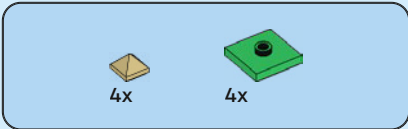

49

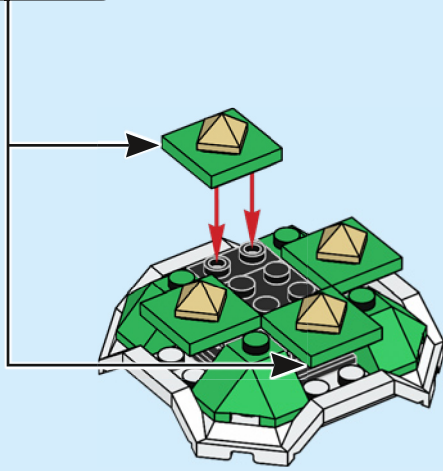
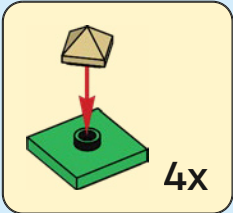

50

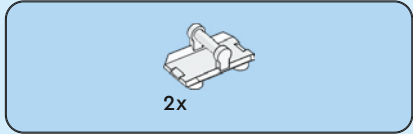
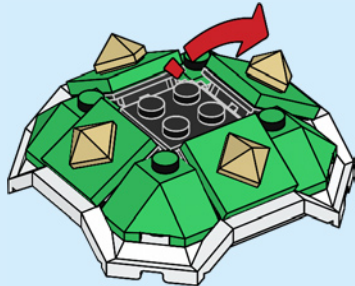

51

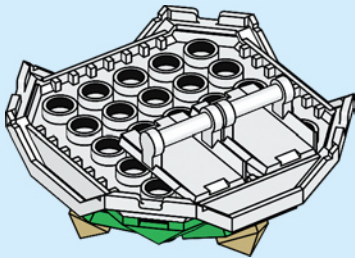

52

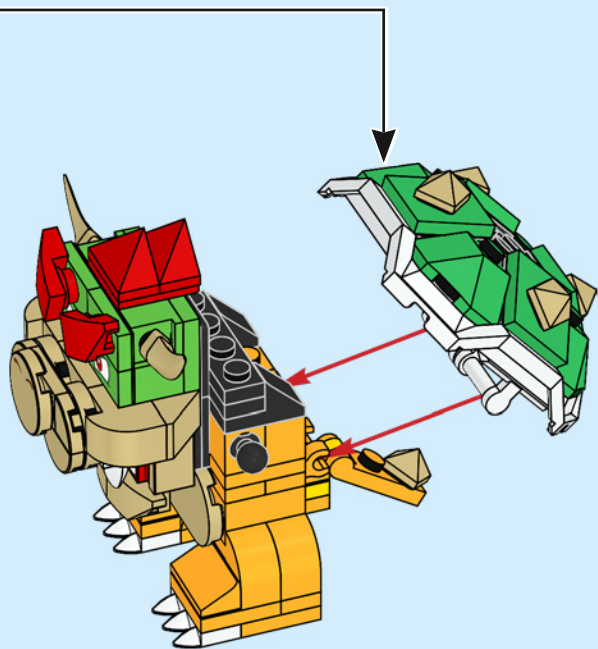

53

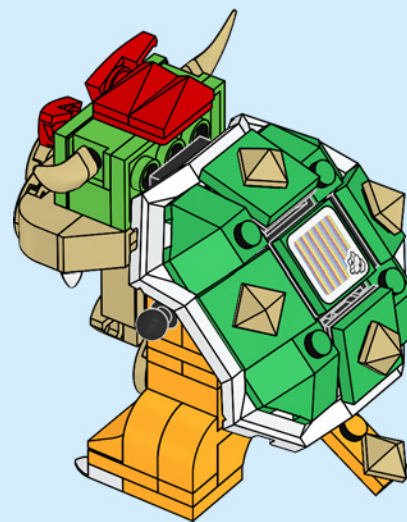
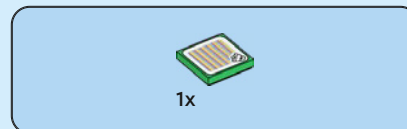



1x



1x

54

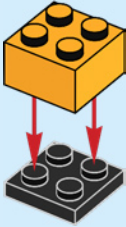

1x

55



1x

56

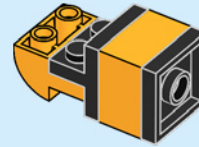

1x

57

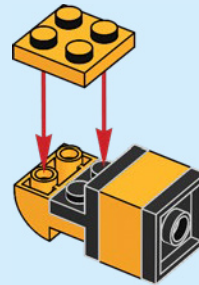



58

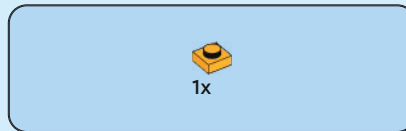
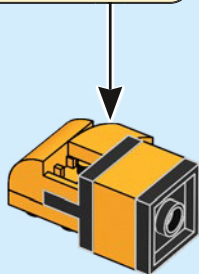
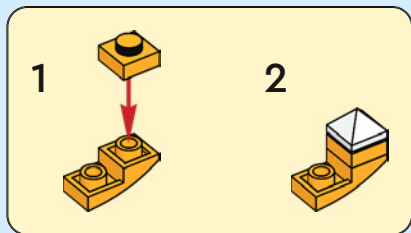

59

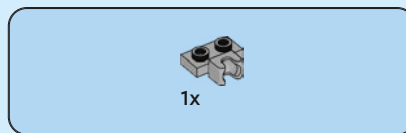
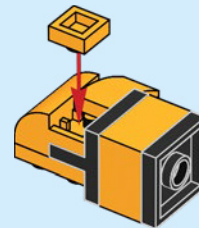

60

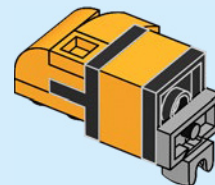



61

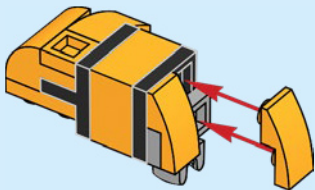

62

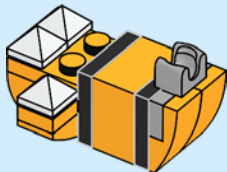

63

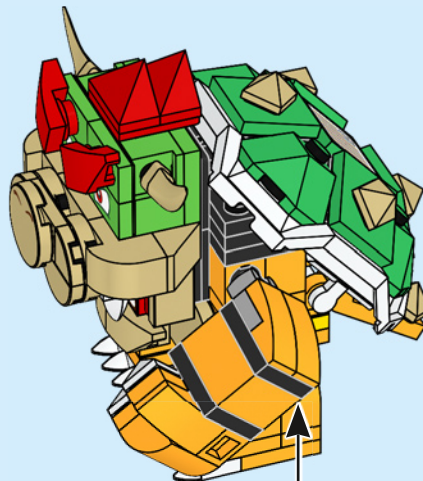

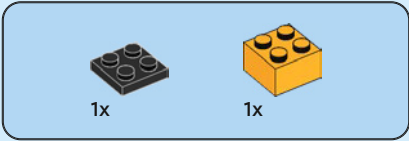

64

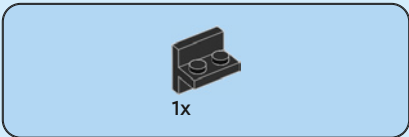
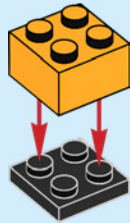

65

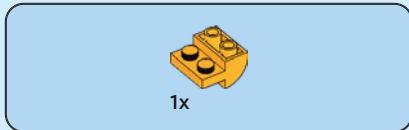
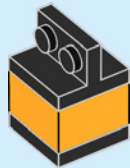

66

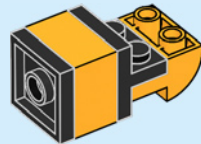
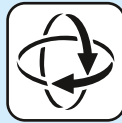

67

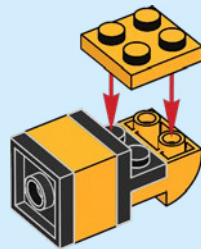





68

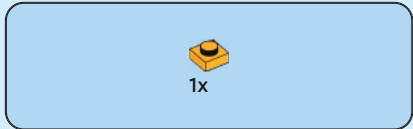
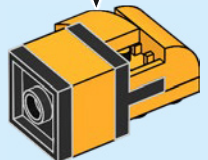
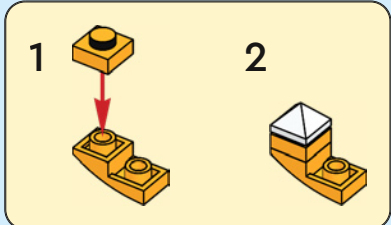

69

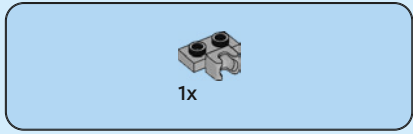
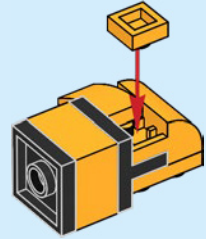

70

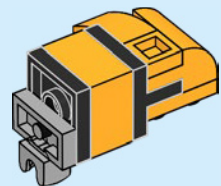



2x

71

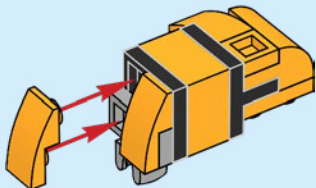

2x

72

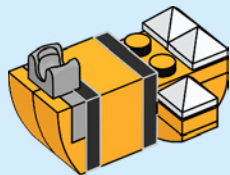

73

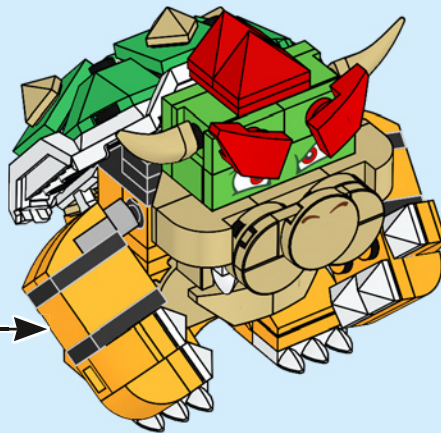

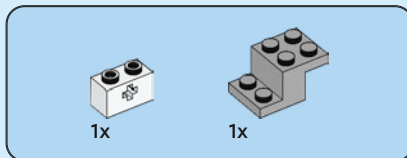
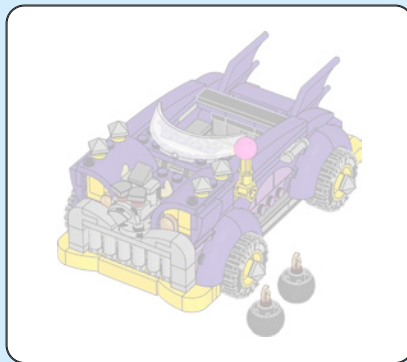

1

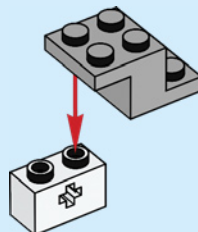

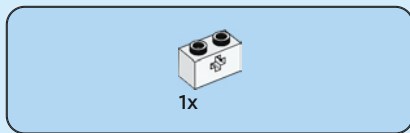

2

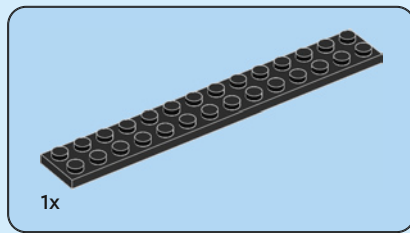
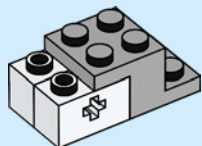

4

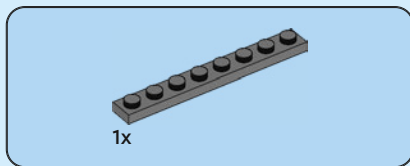
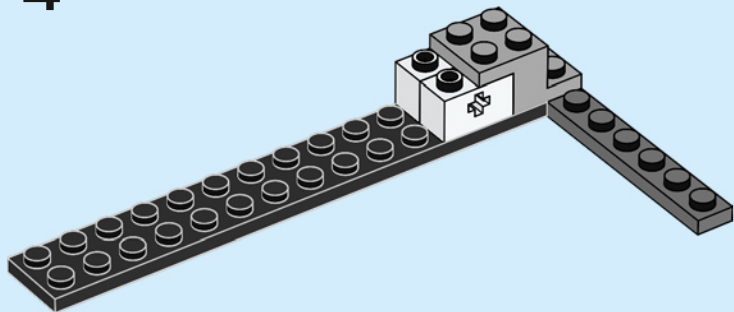

3

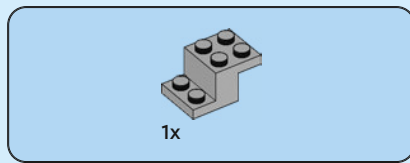
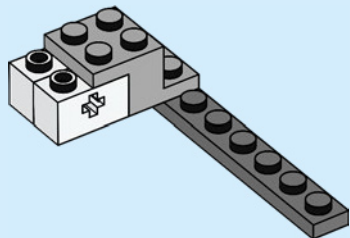

5

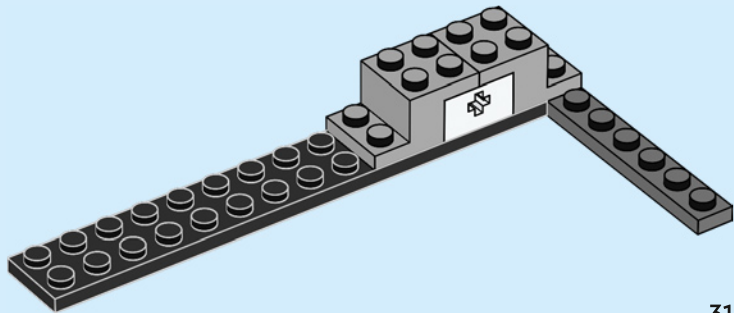

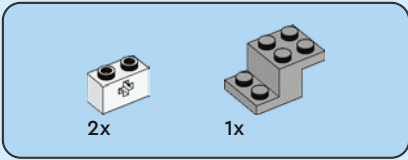

6

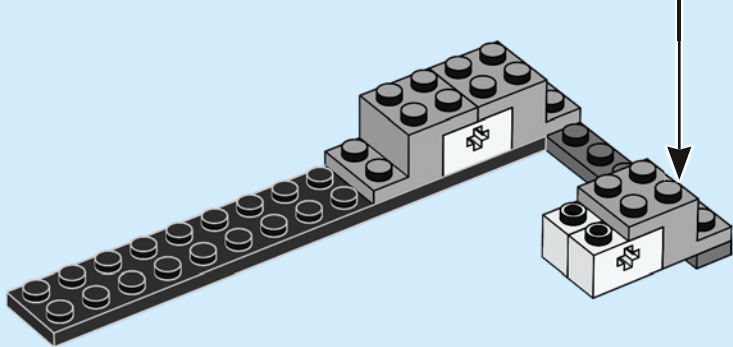
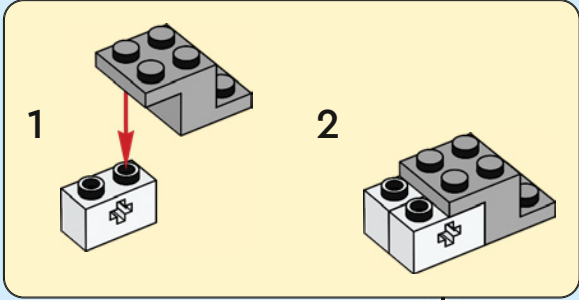

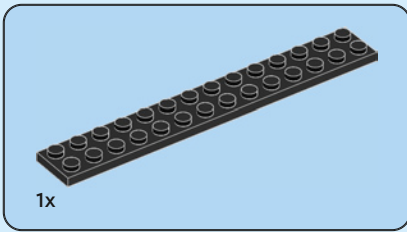

7

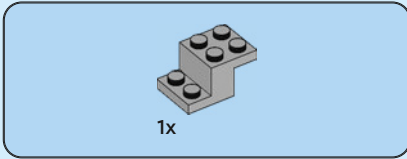
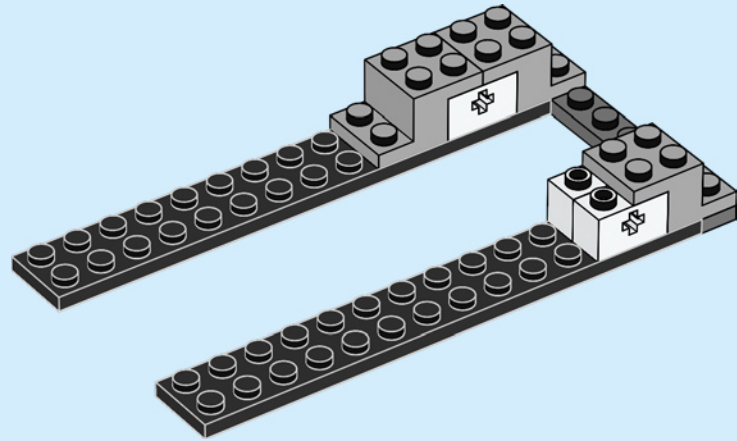

8

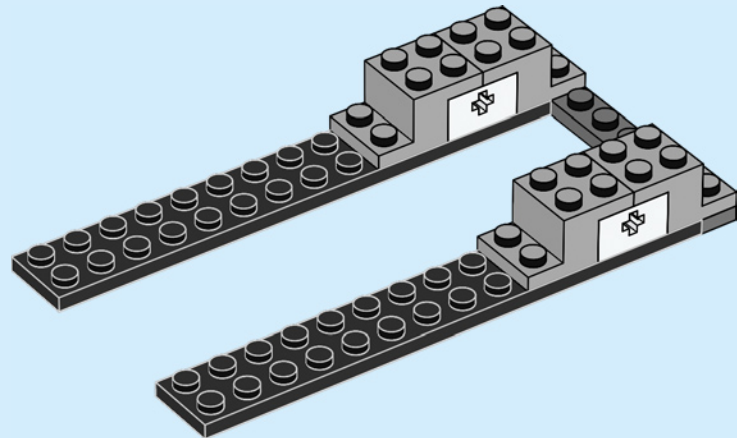

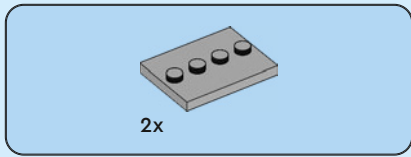

9

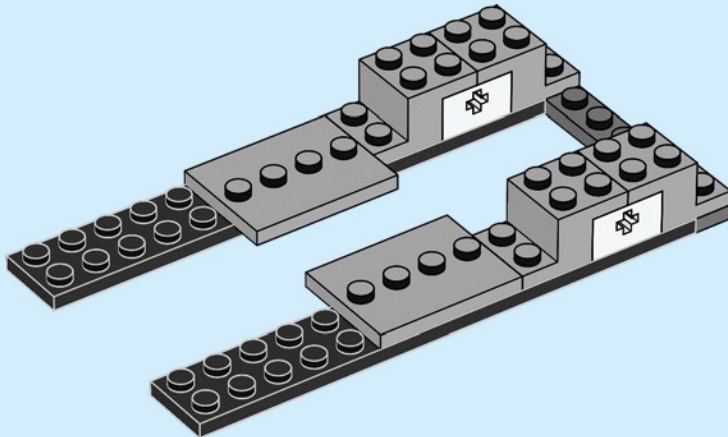

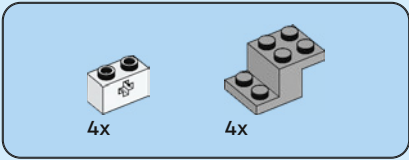

# 10

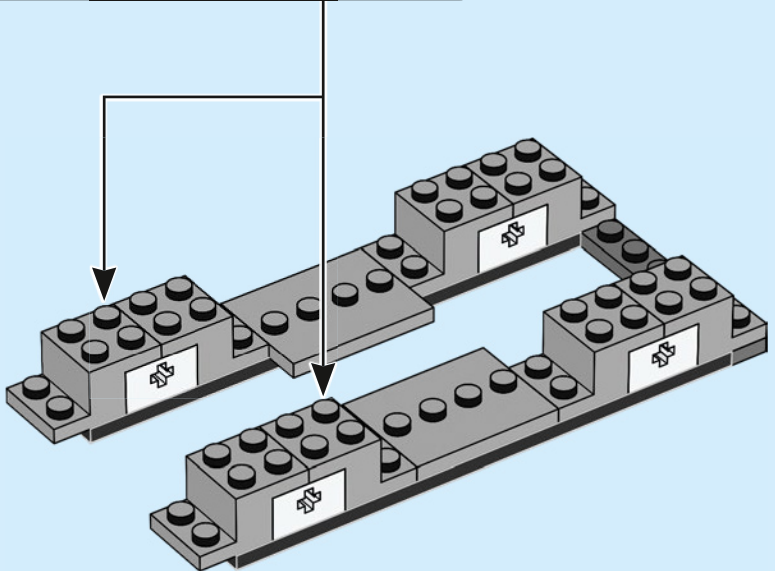
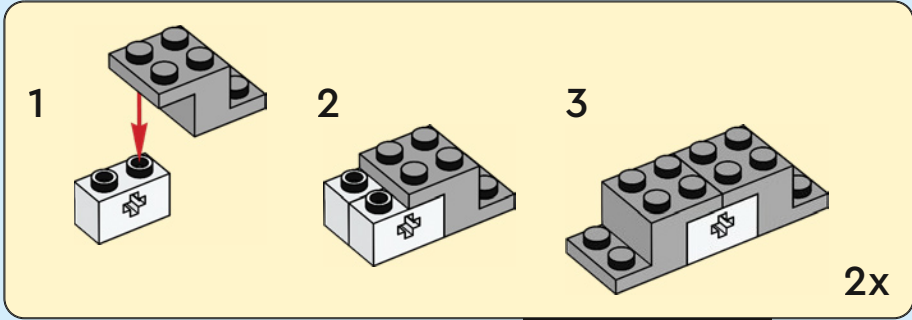



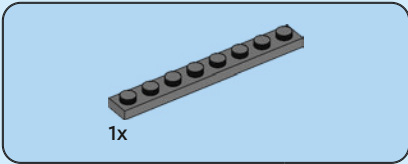

11

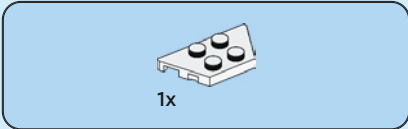
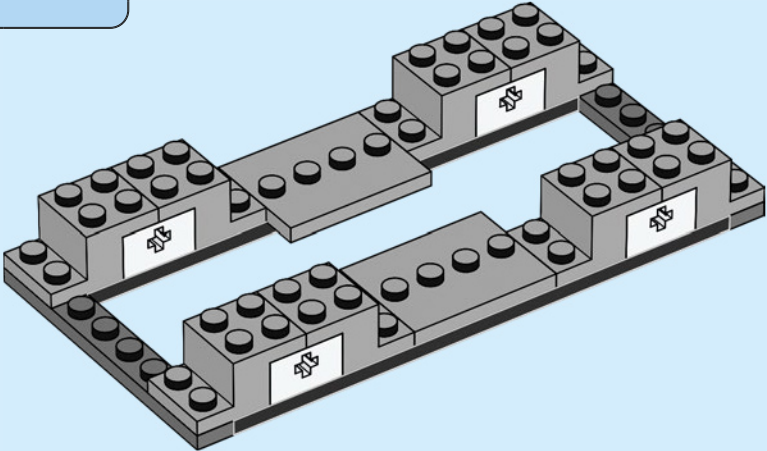

12

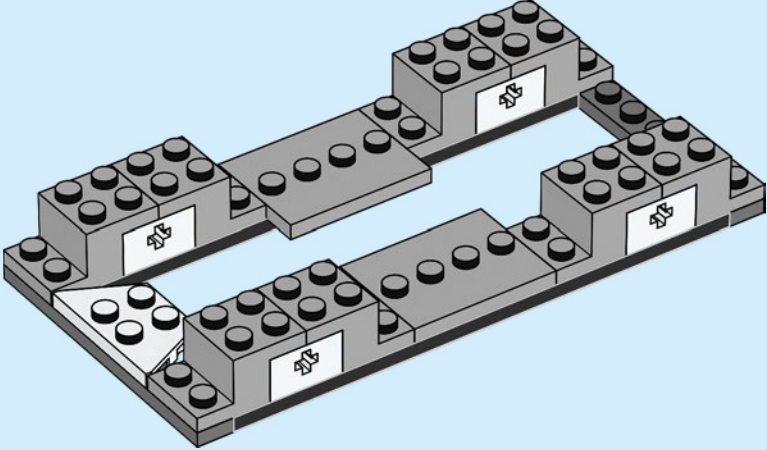

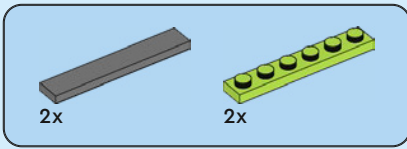

13

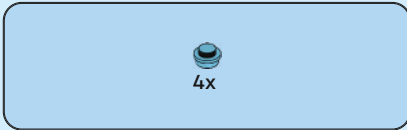
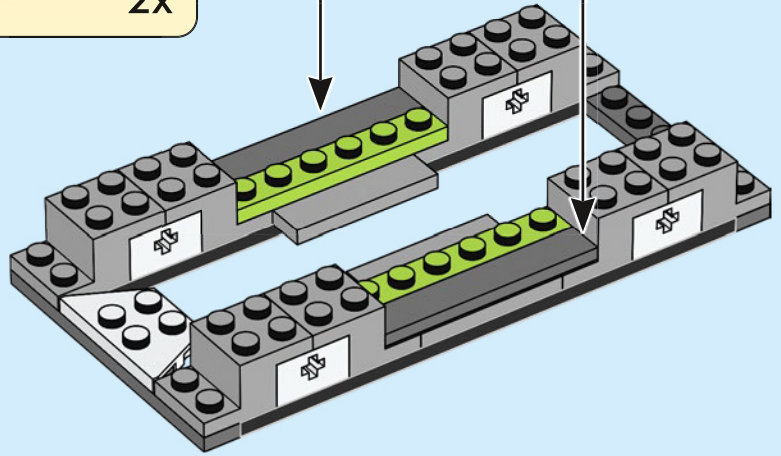
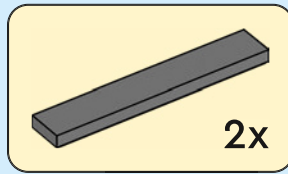

14

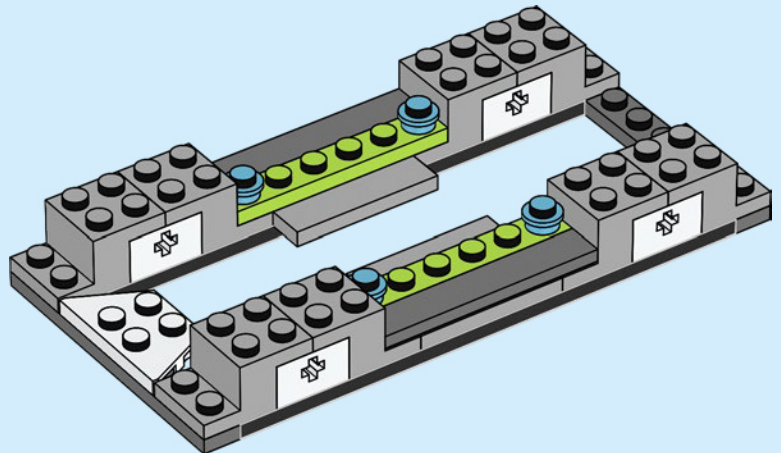

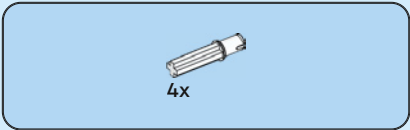

15

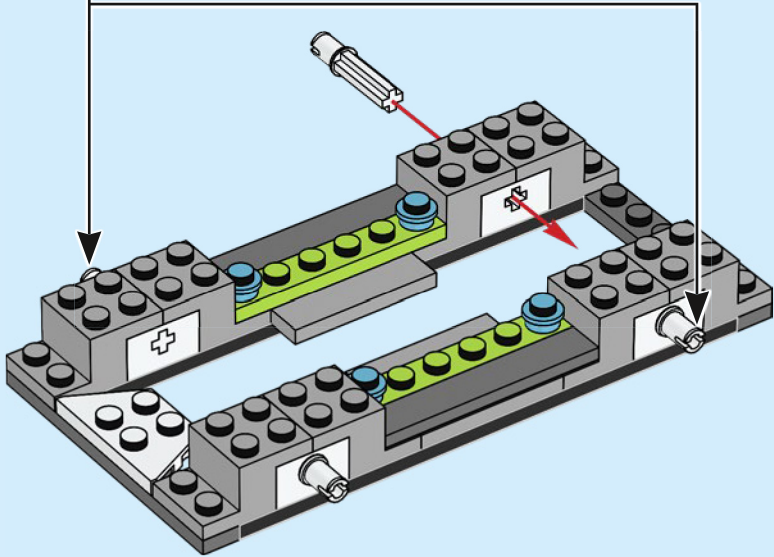
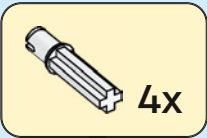



1x

16

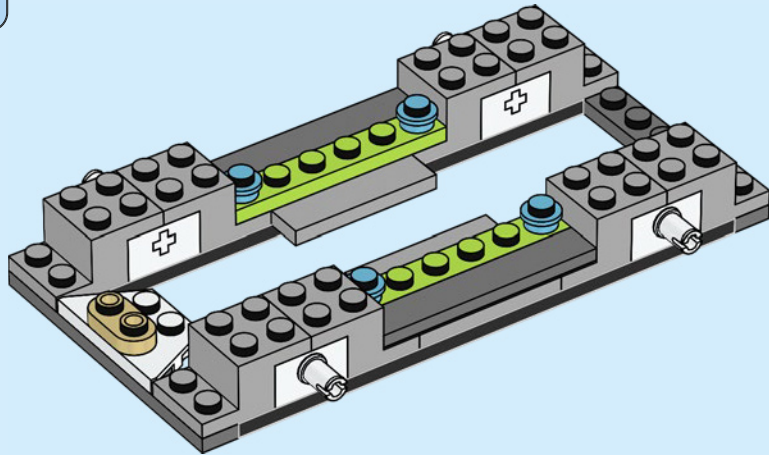

2x

17

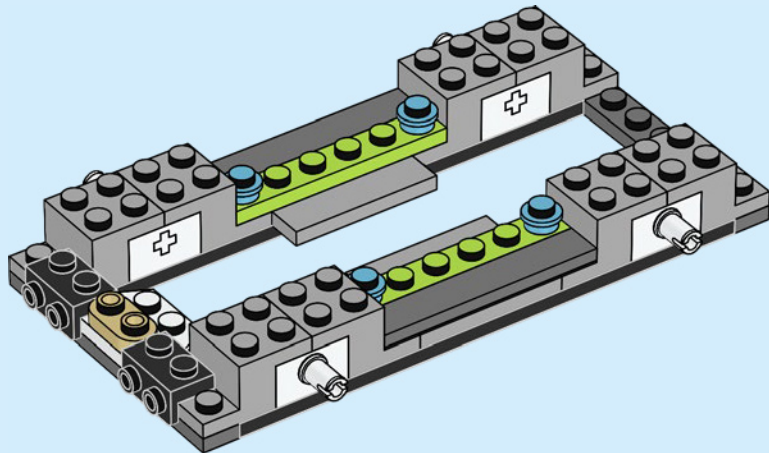



2x

18

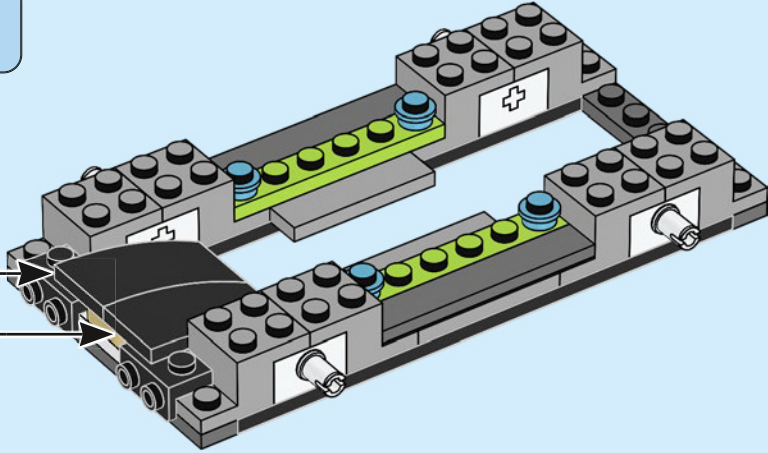

2x

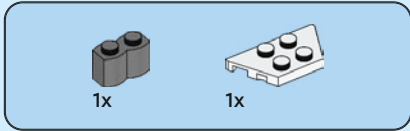

1x

1x

19

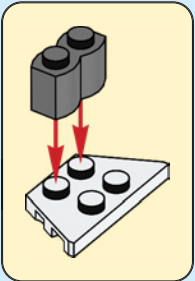
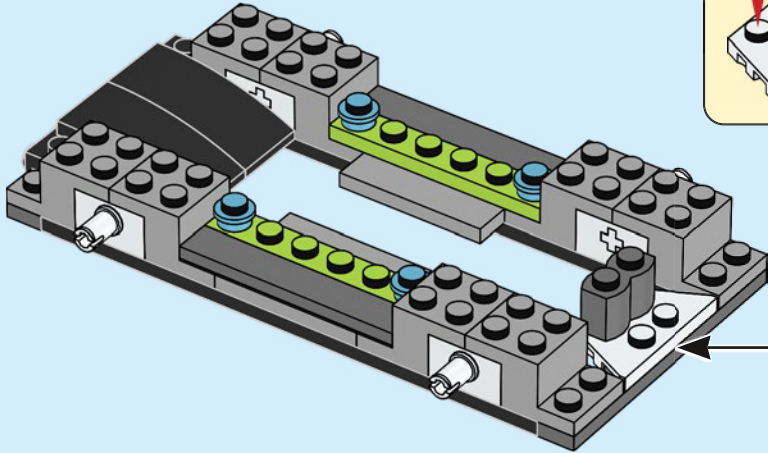



20

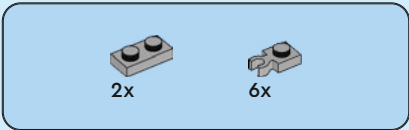
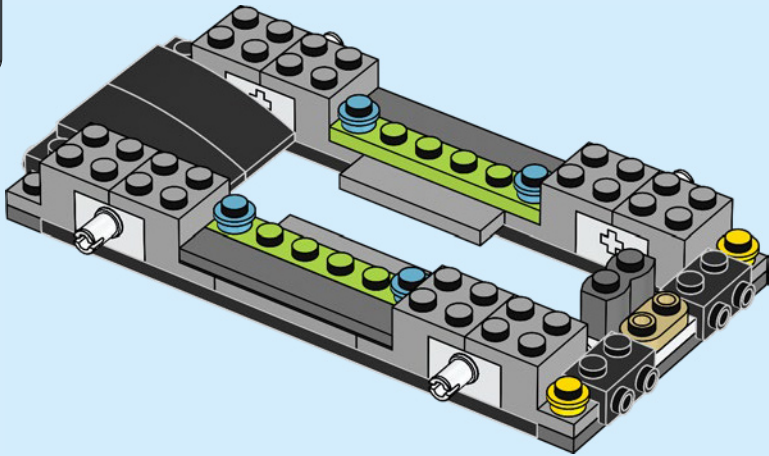

21

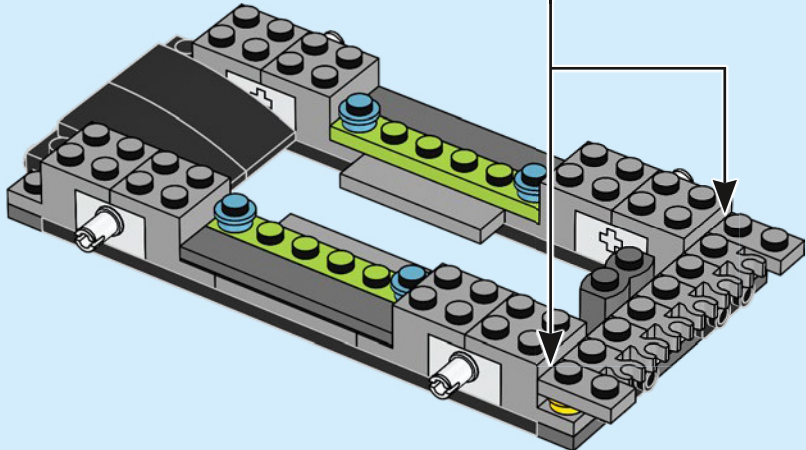
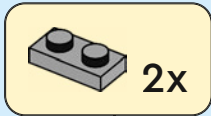



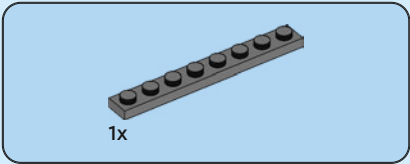

22

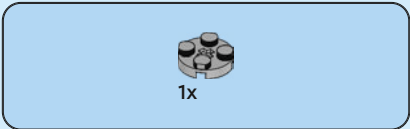
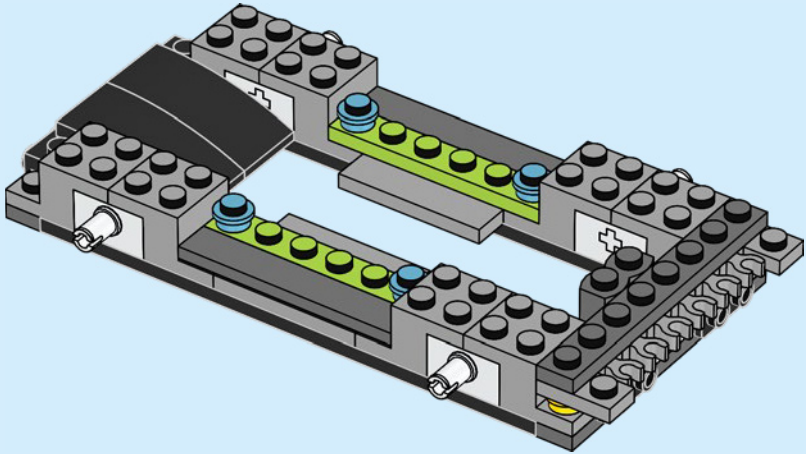

23

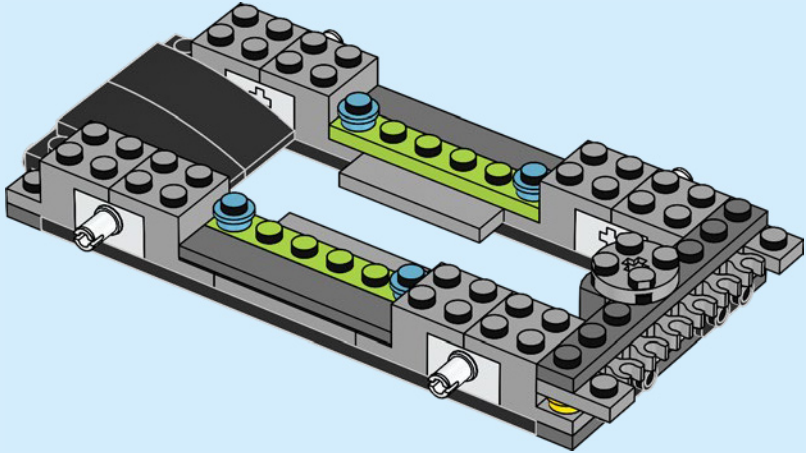

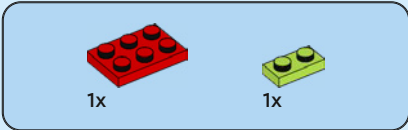
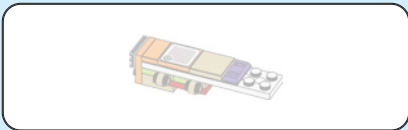

24



25

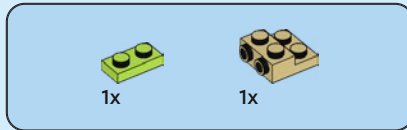
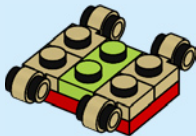

26

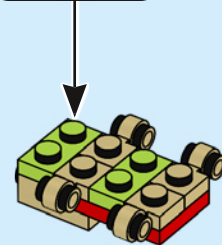
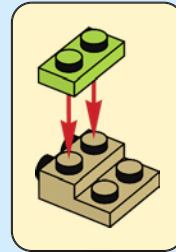



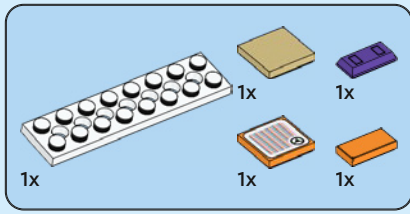

27

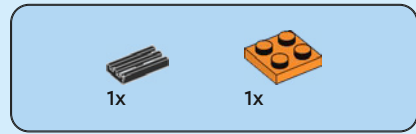
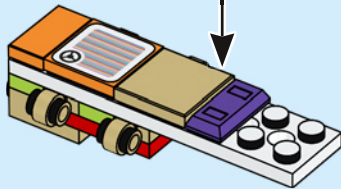
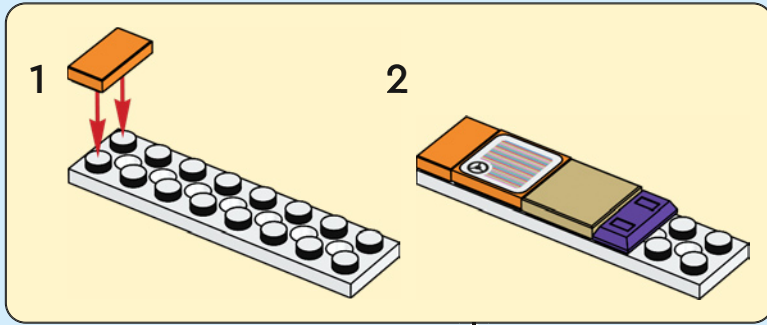

28

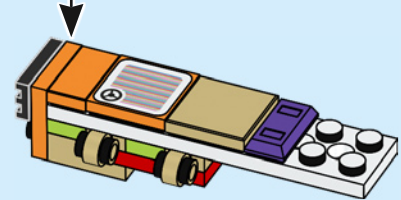
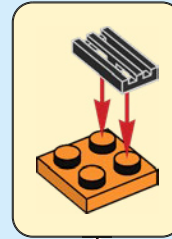

29

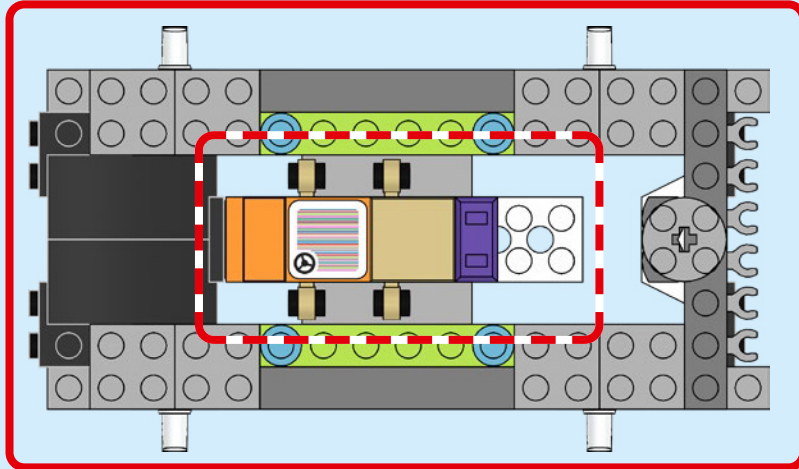
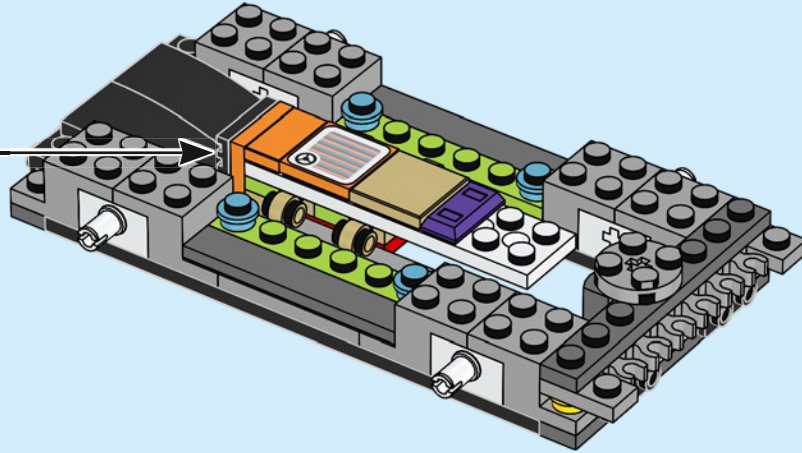



4x

30

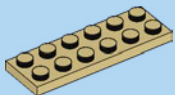
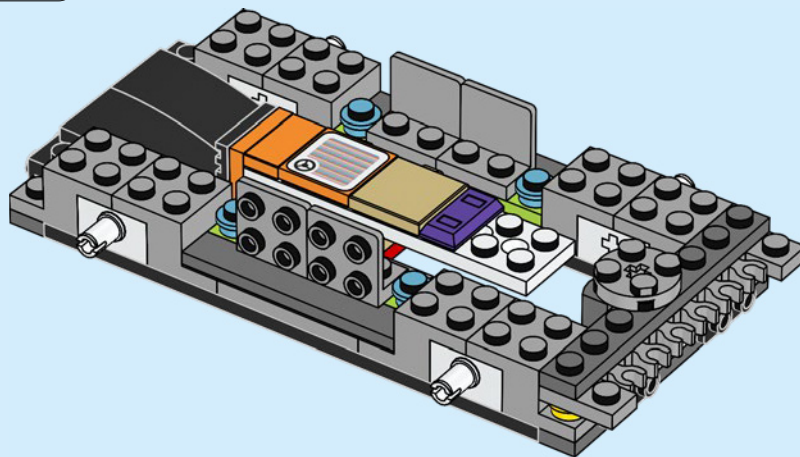

2x

31

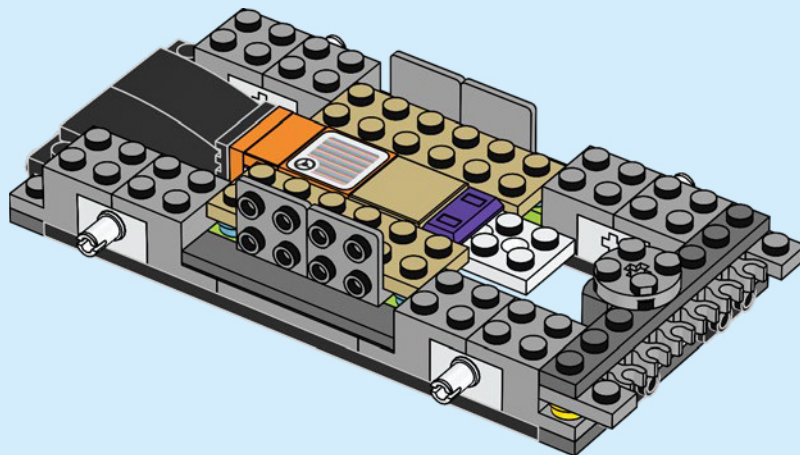

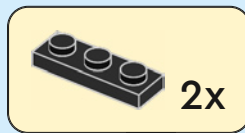
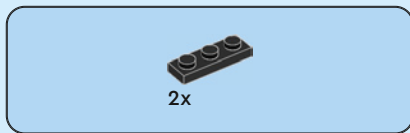

32

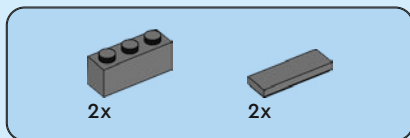
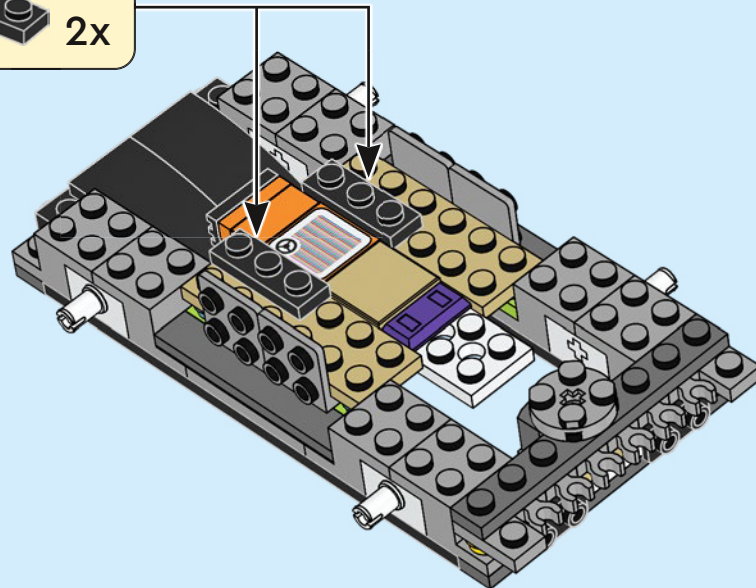

33

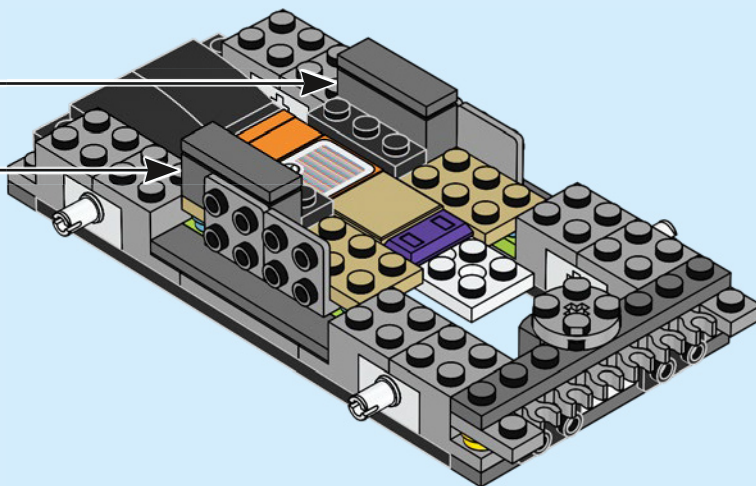
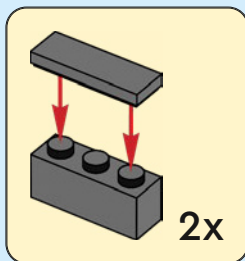



2x



2x

34

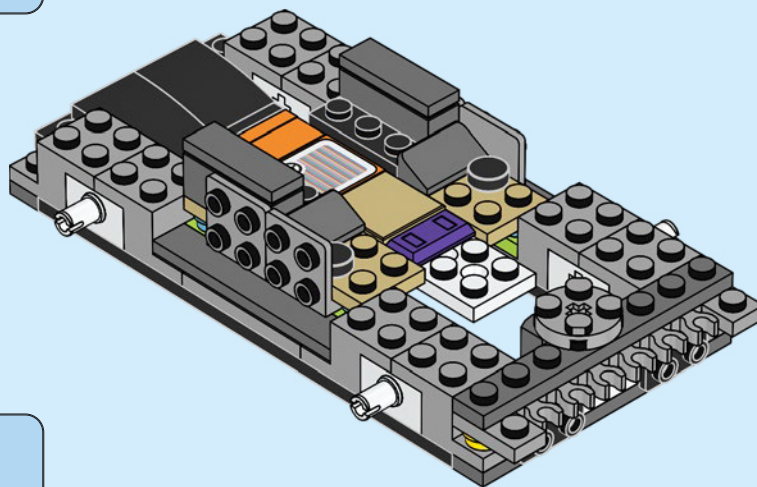

2x

35

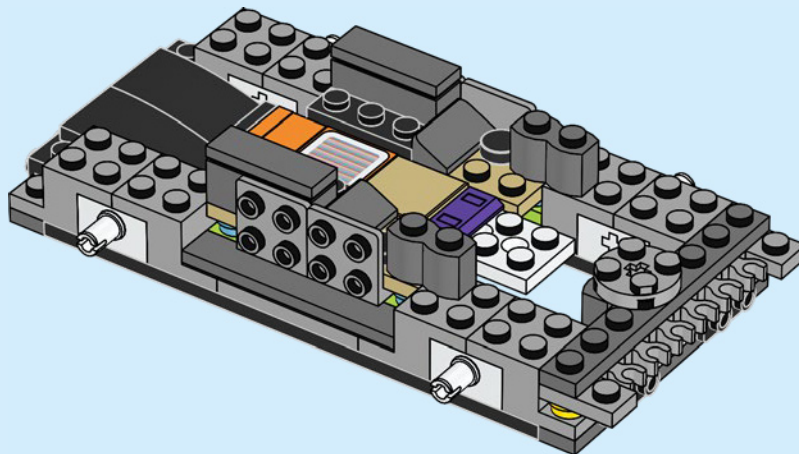





2x

36

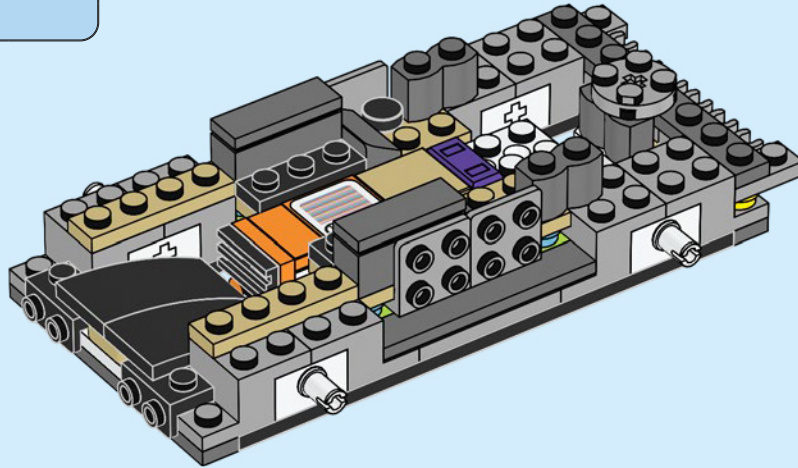

2x

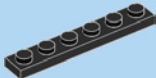

1x

37

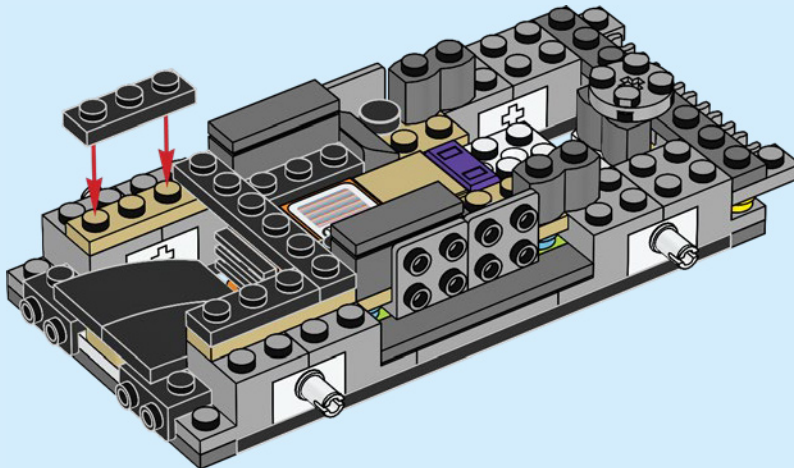

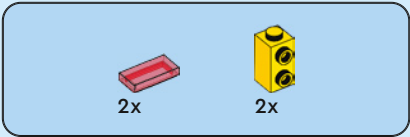

38

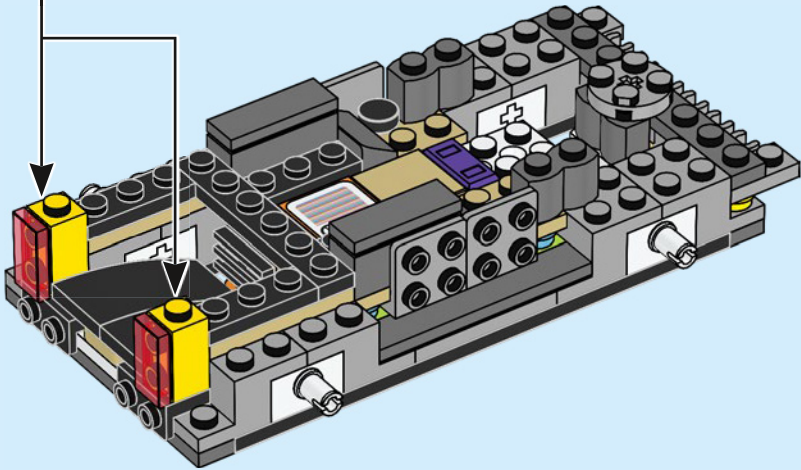
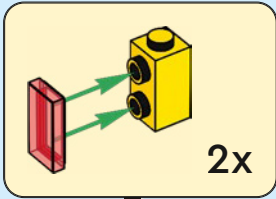



2x



2x

# 39

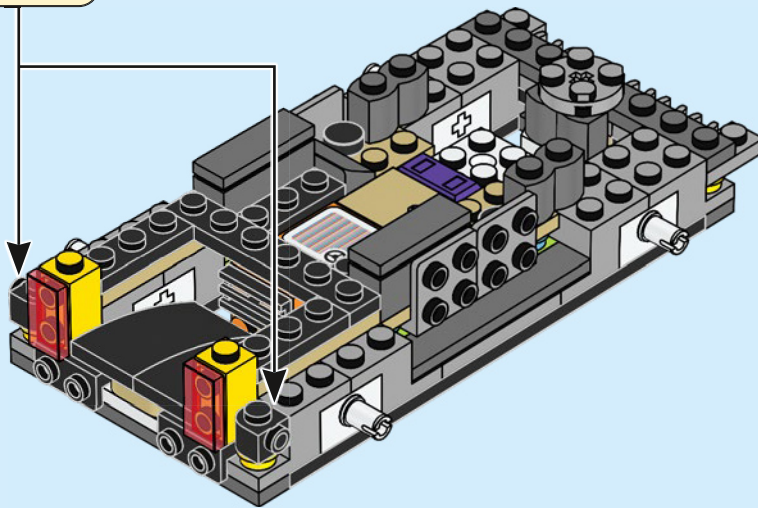
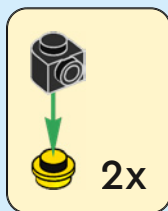



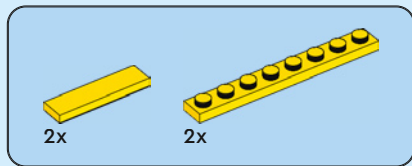

40

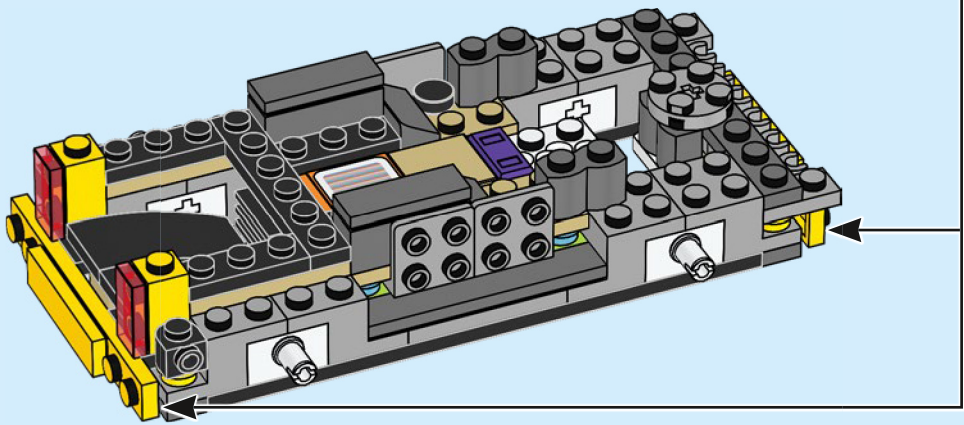
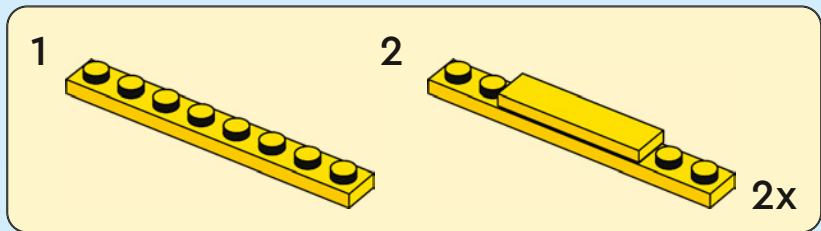

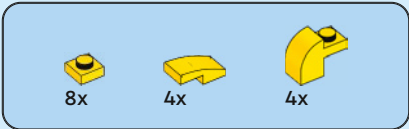

41

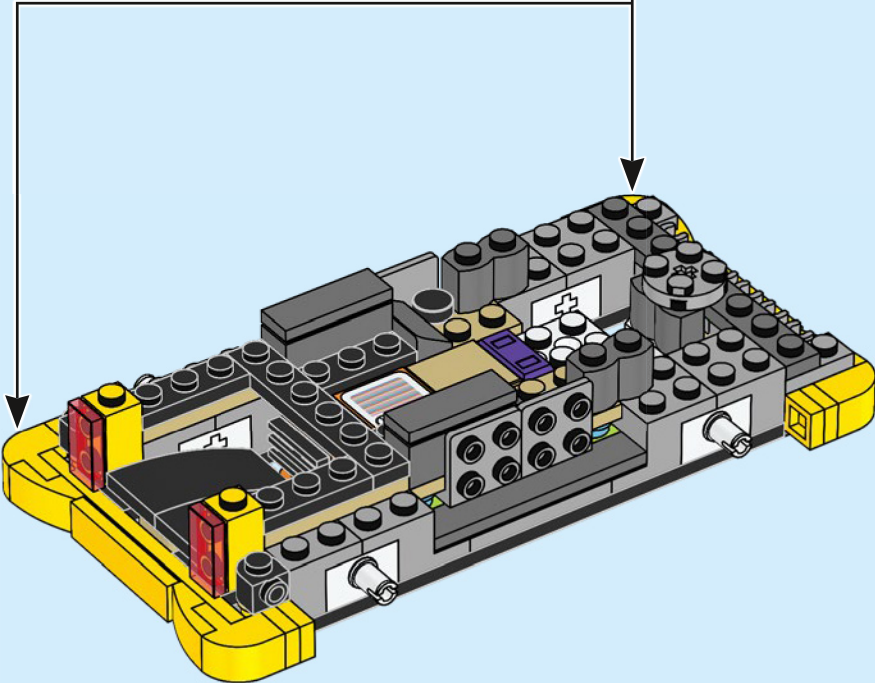
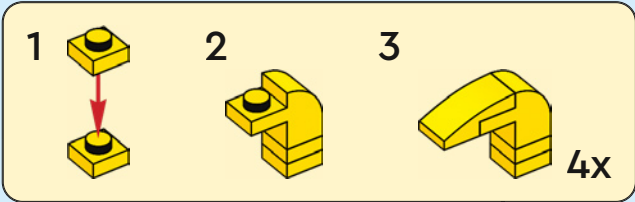

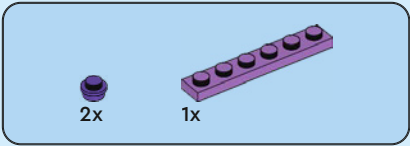

42

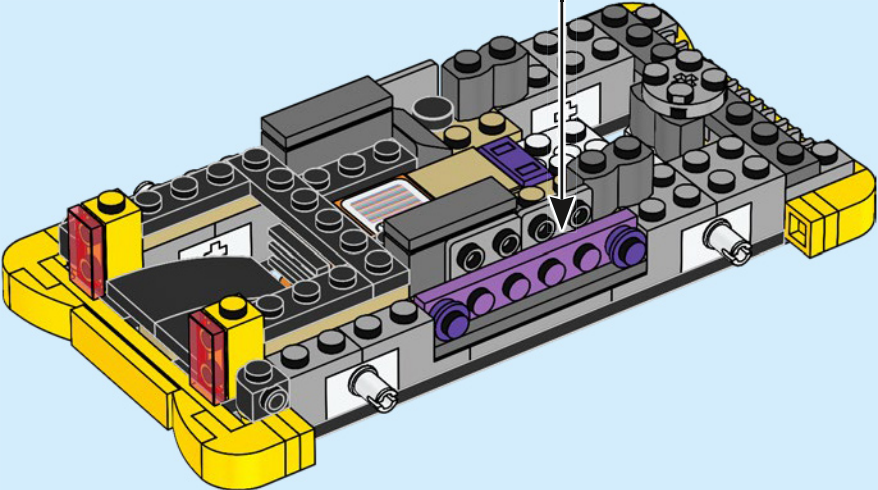
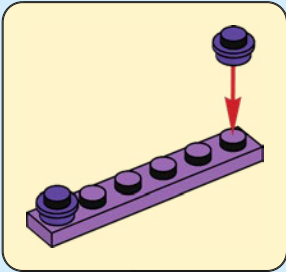



1x

43

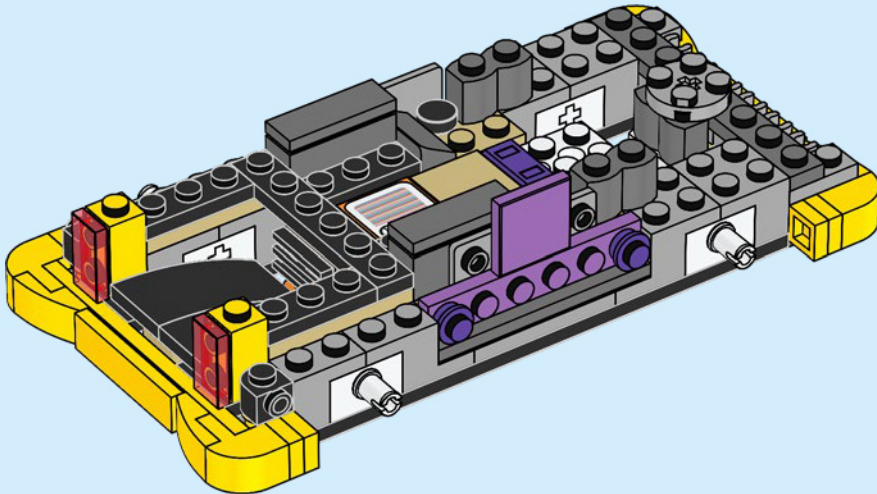



2x

44

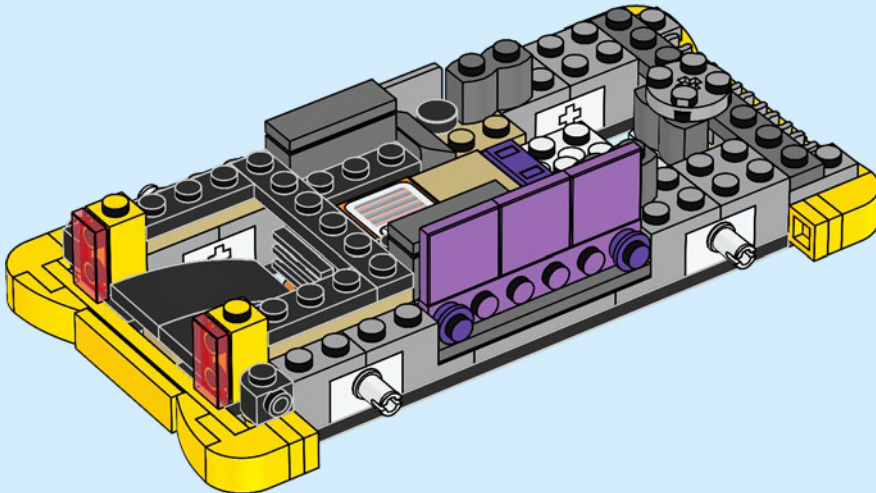

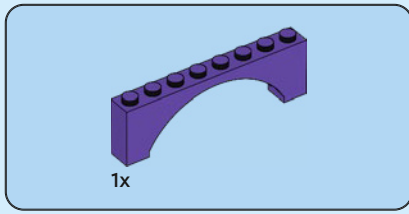

45

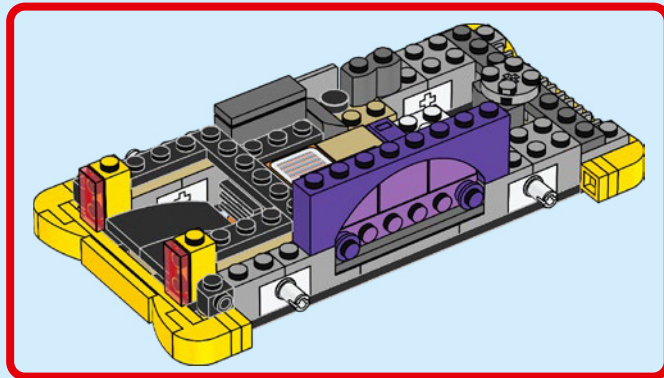
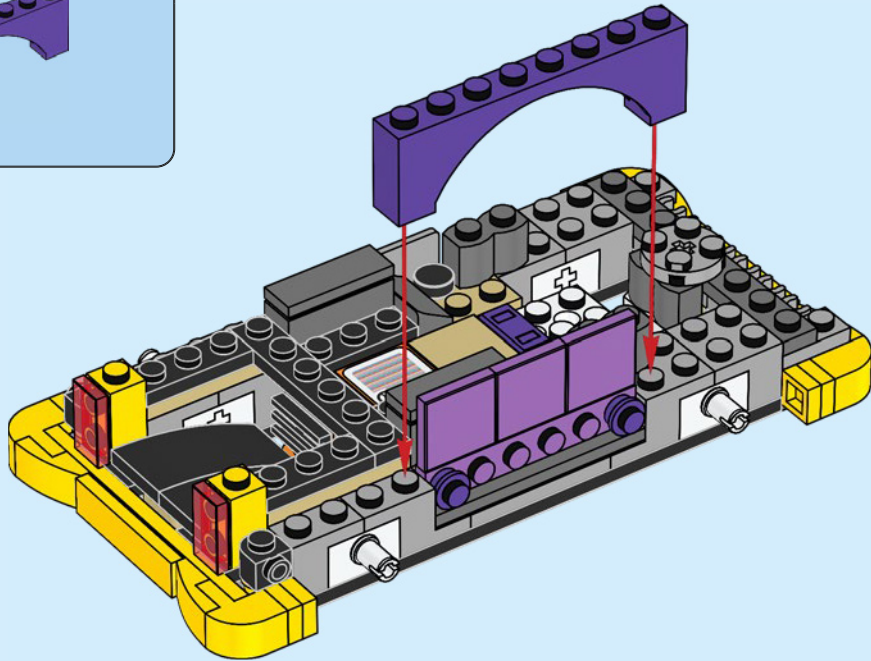

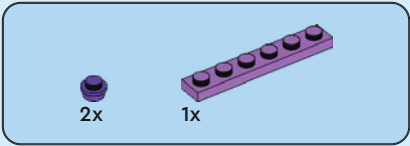

46

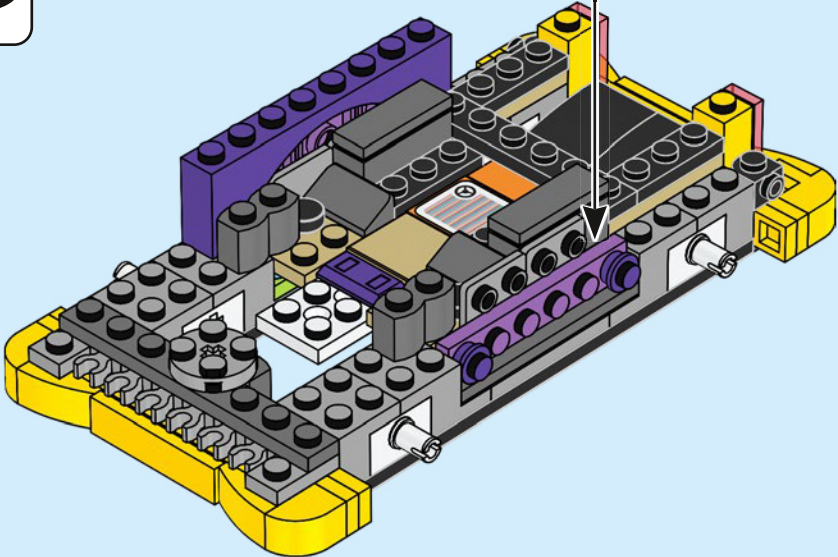
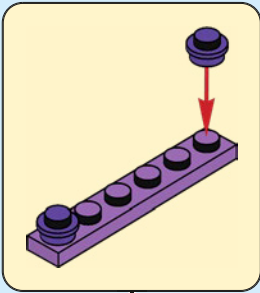



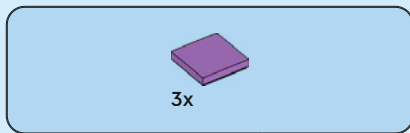

47

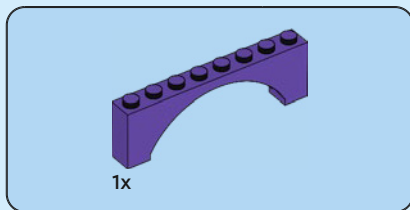
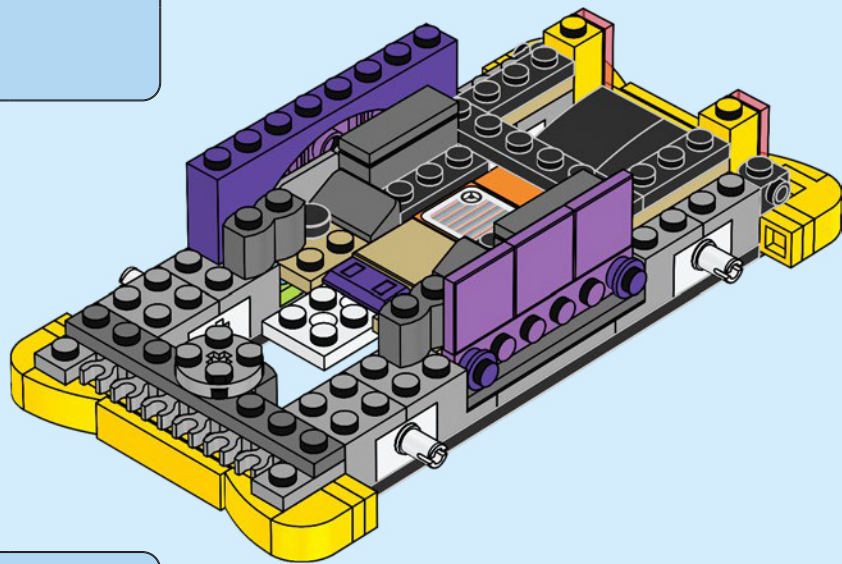

48

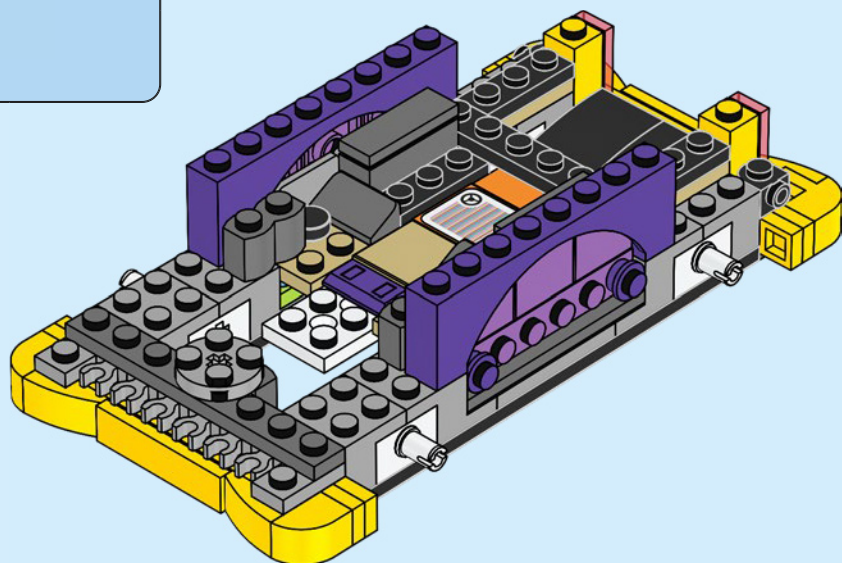



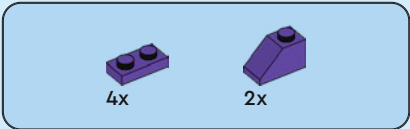

49

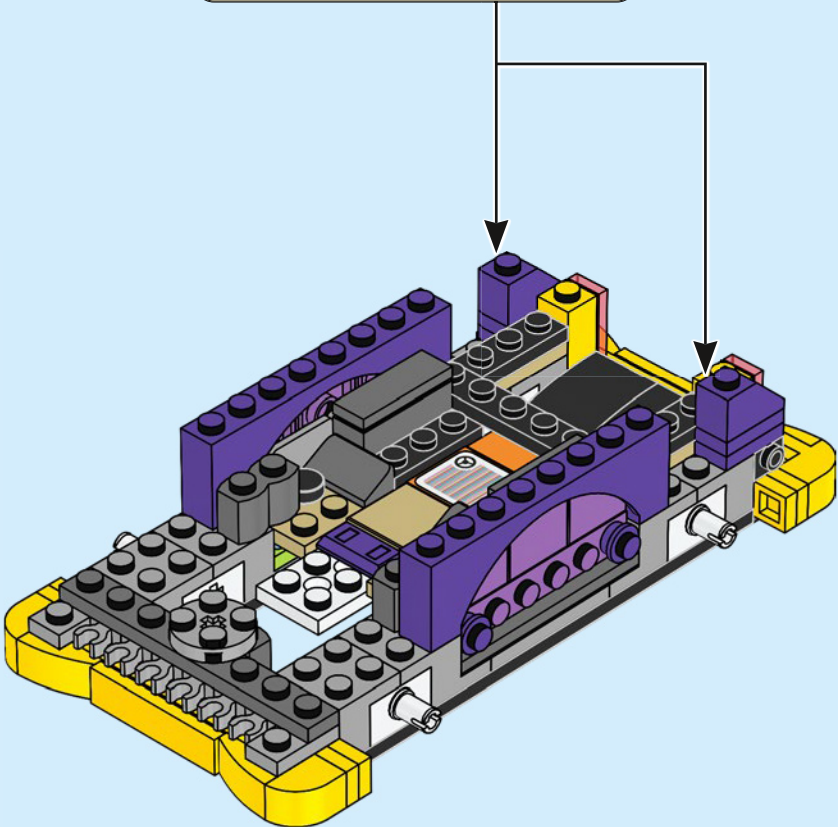
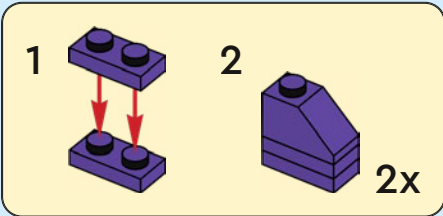



2x



4x

50

1



2

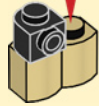

2x

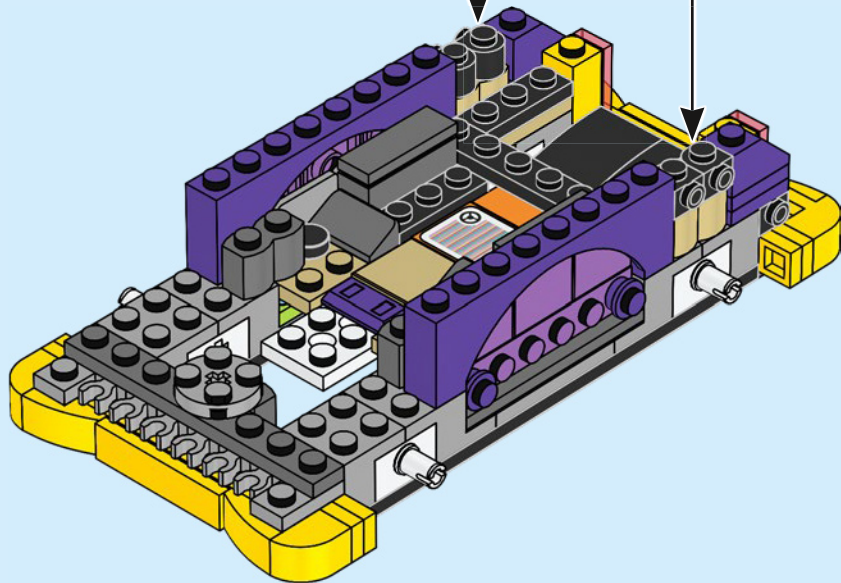



51

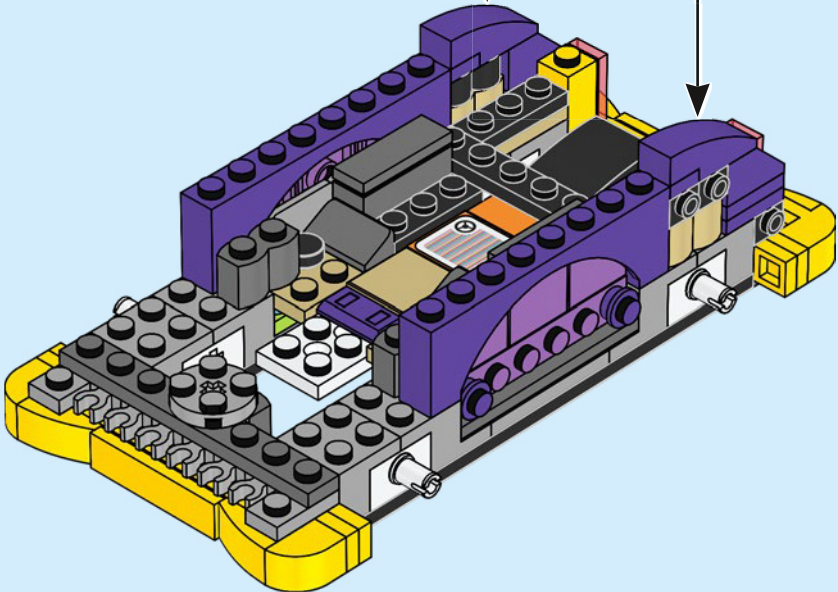
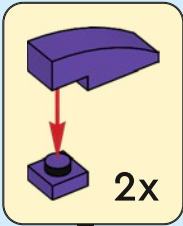

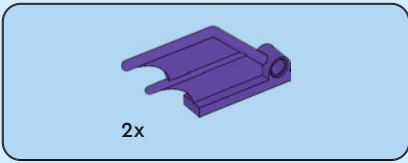

52

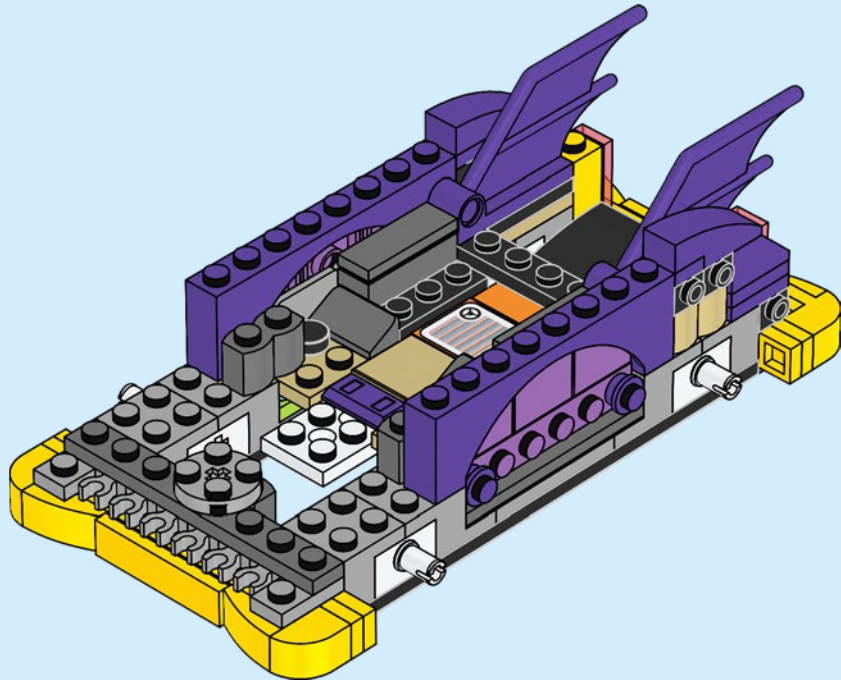



2x

53

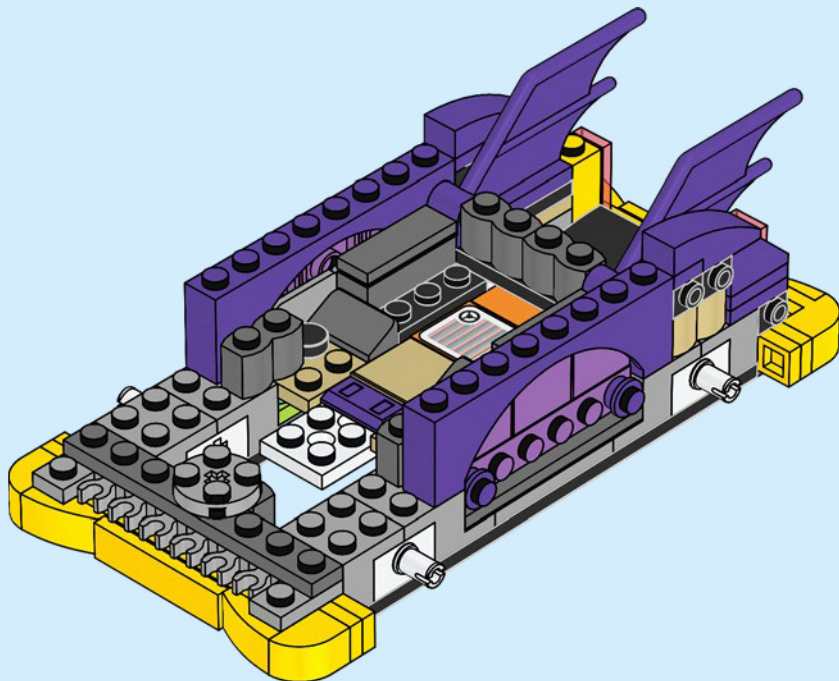



1x



2x

# 54

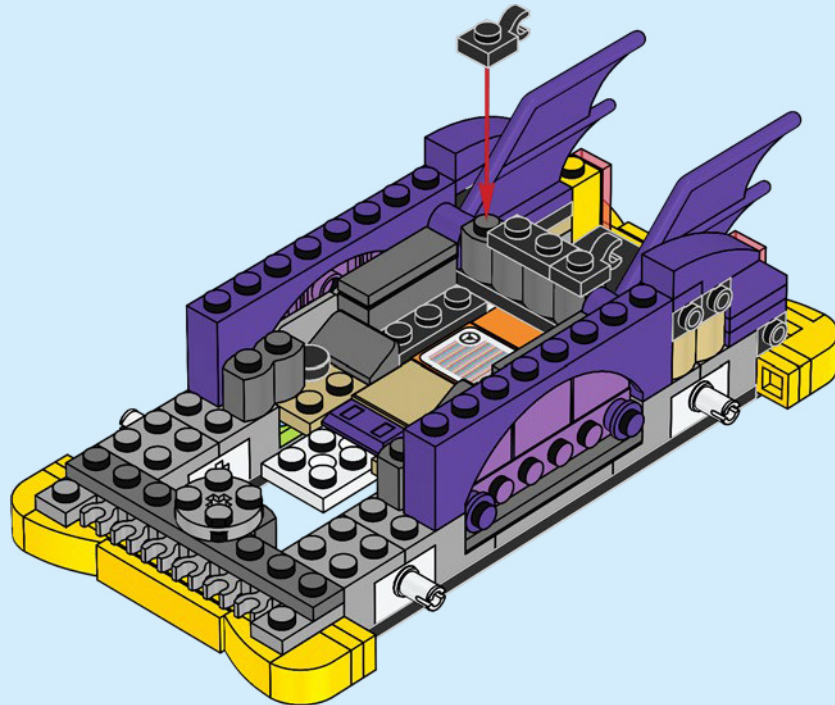

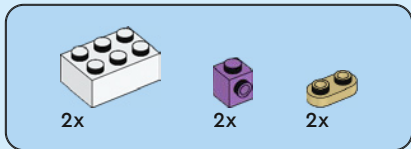

55

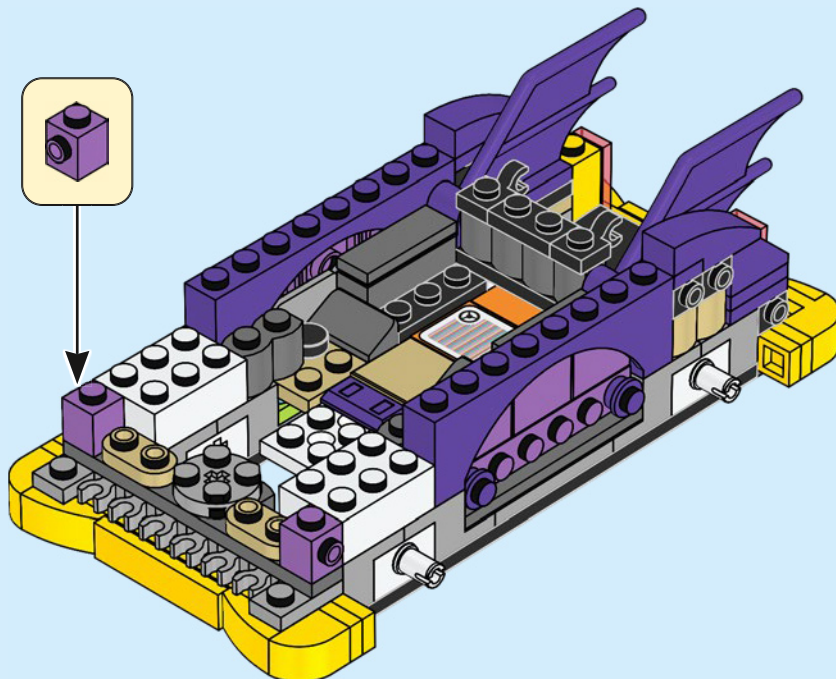





2x



2x

# 56

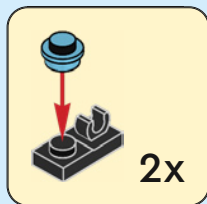

2x

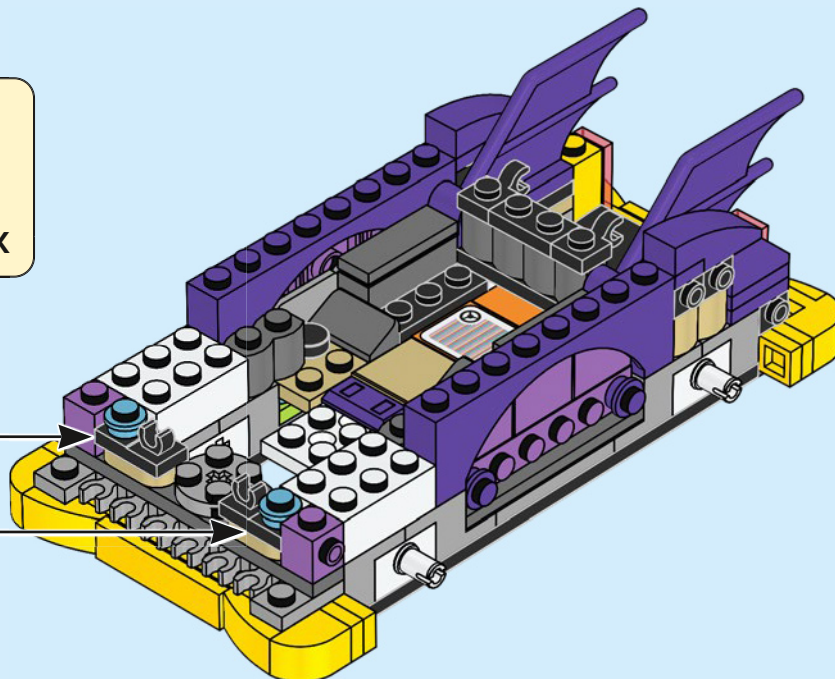





2x



2x

57

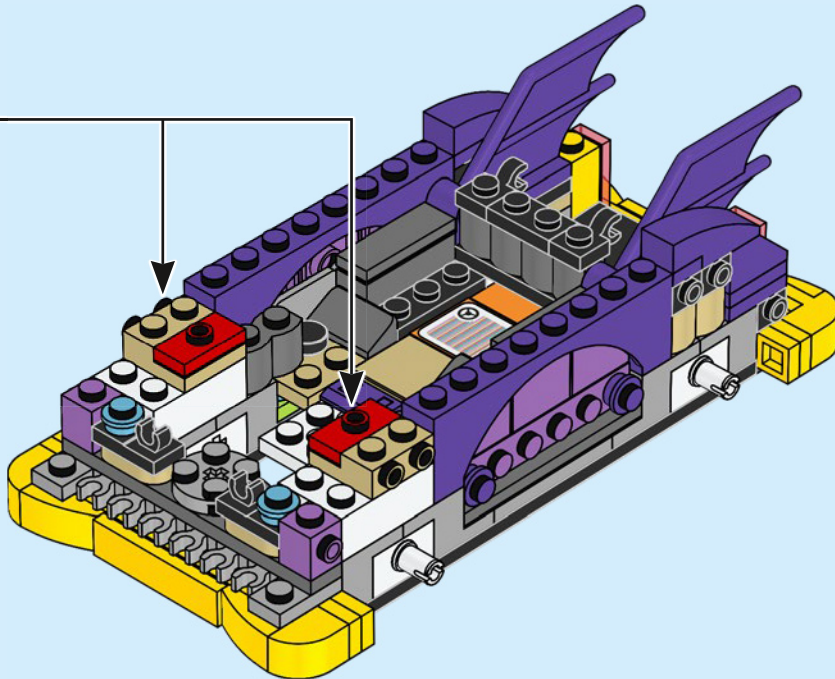
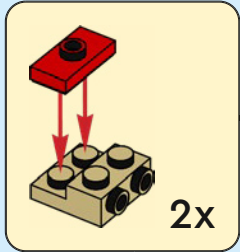



2x



2x

58

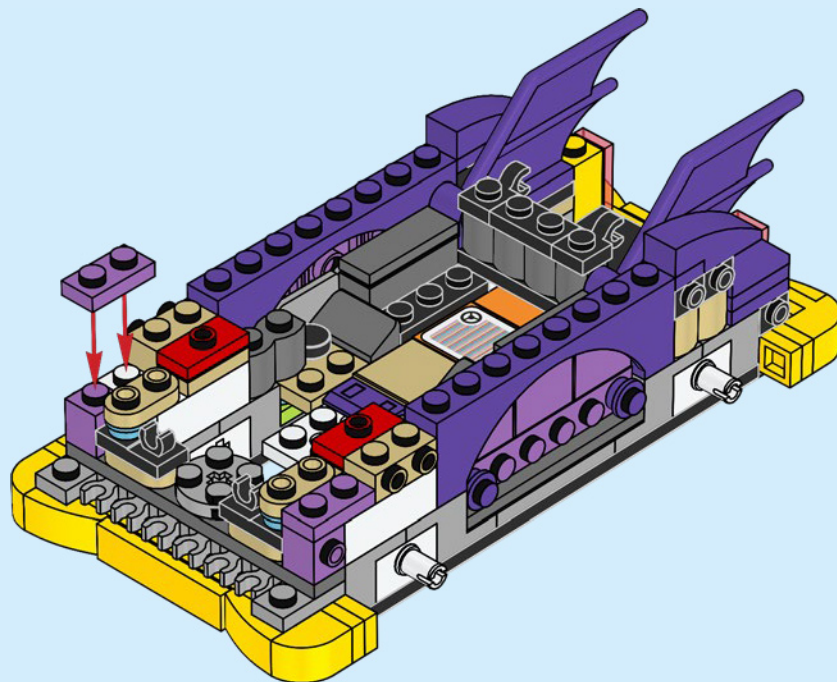



2x

59

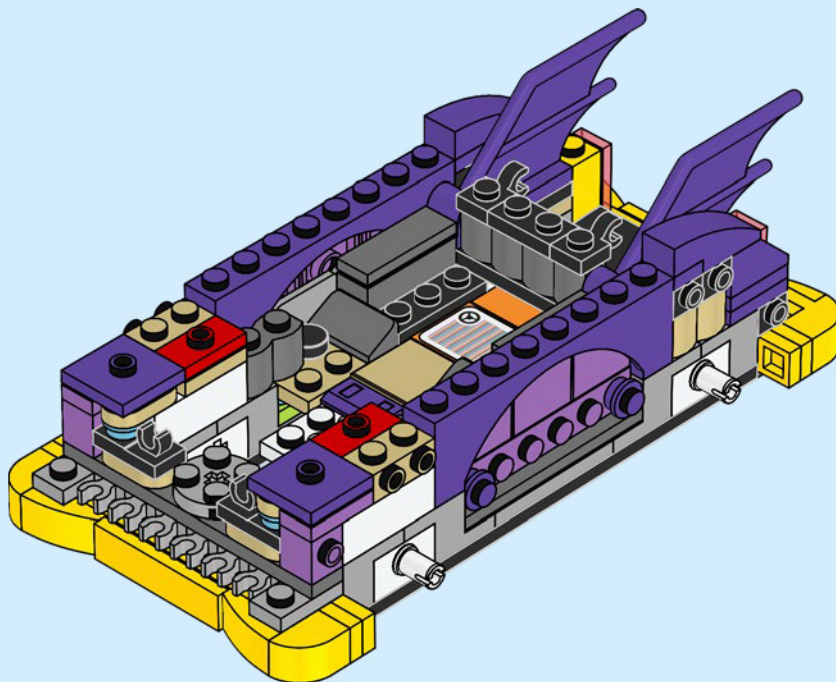



2x

60

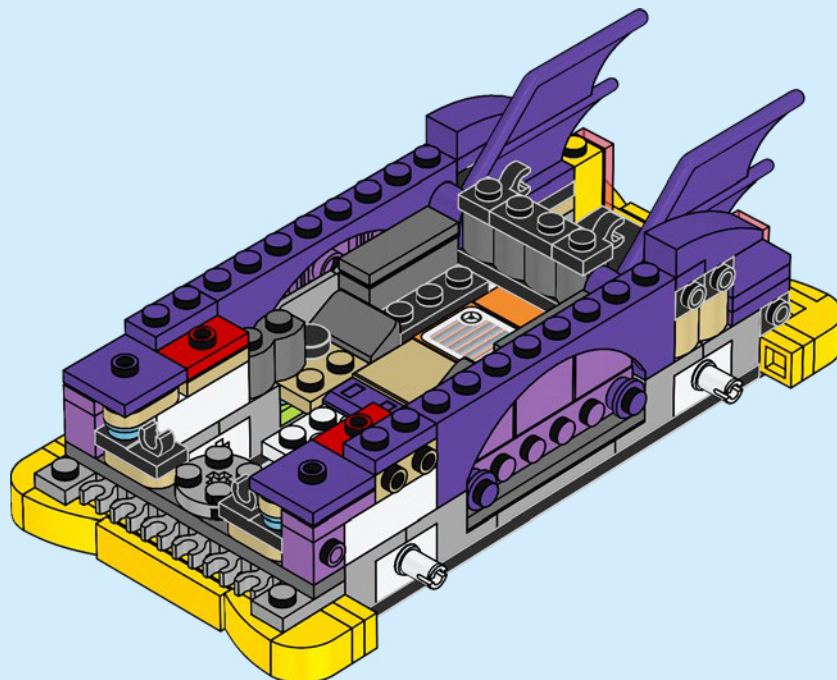



1x



2x

61

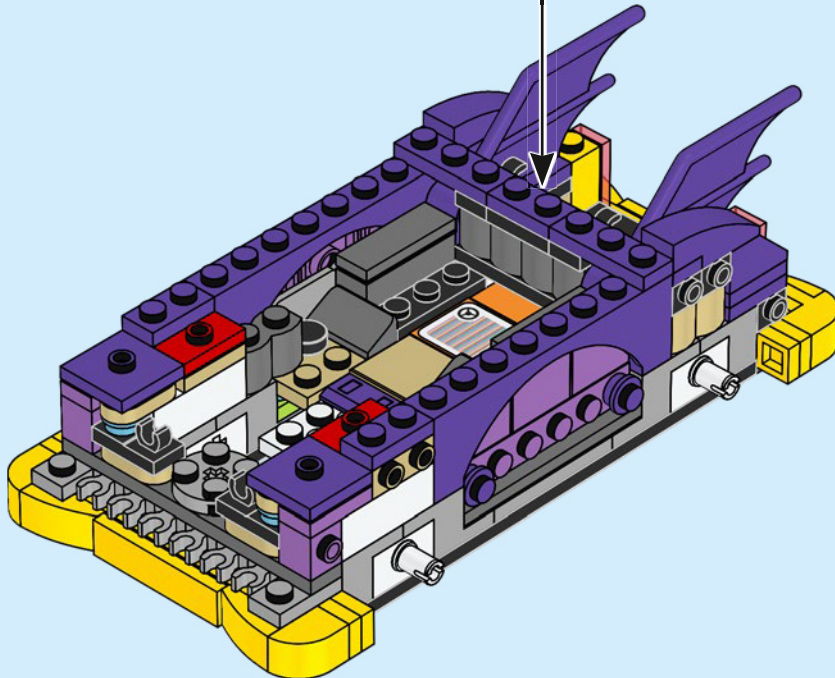
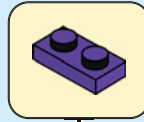



2x



2x

62

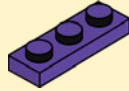

2x

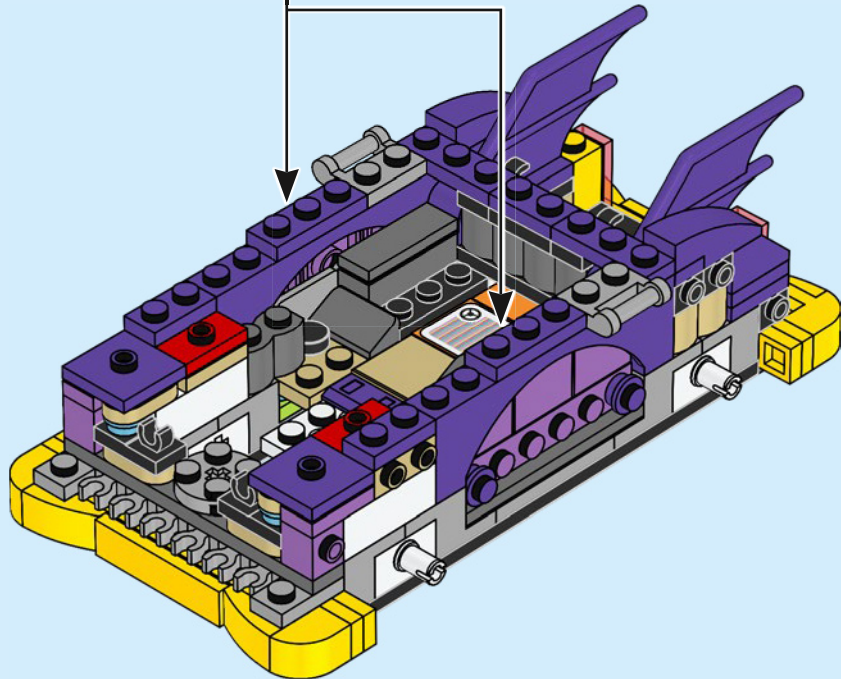



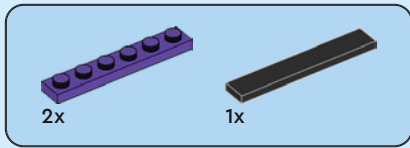

63

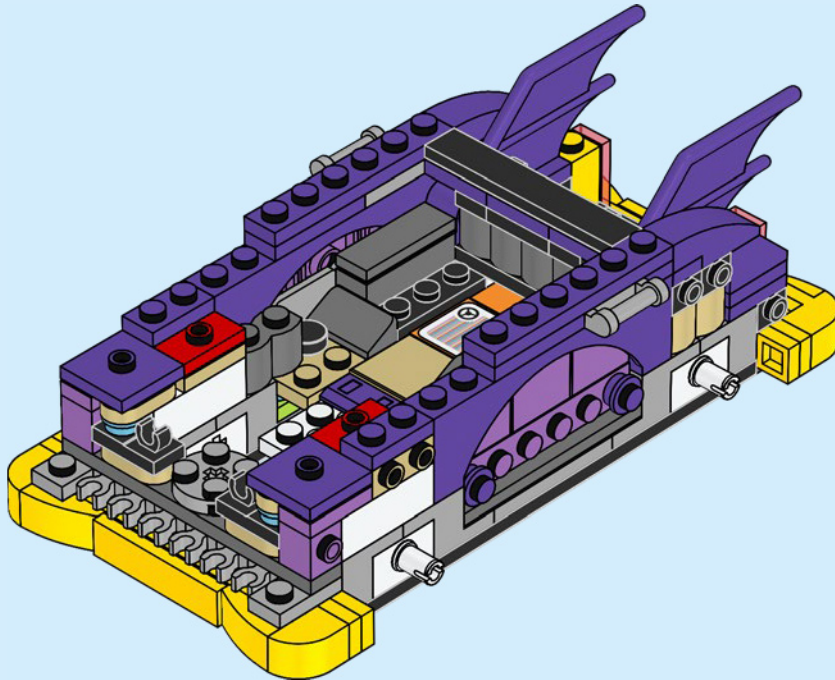



2x

64

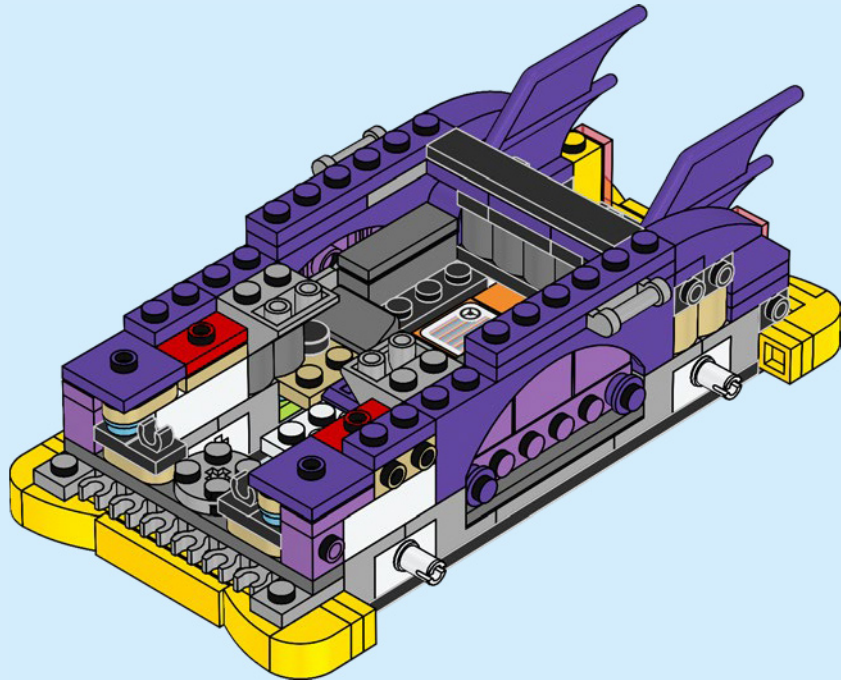





2x

65

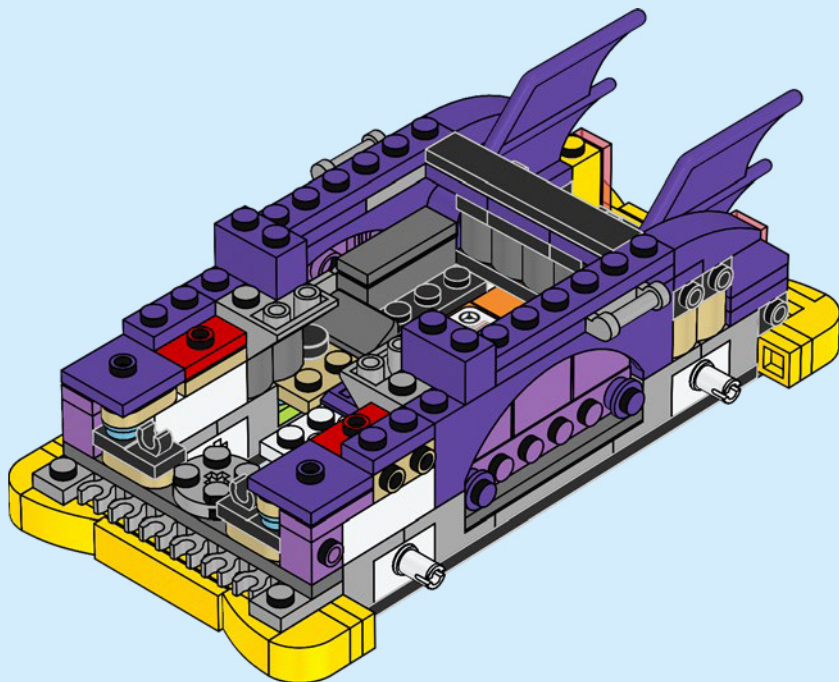

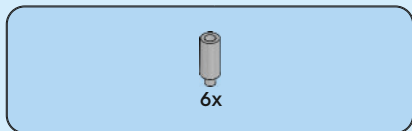

66

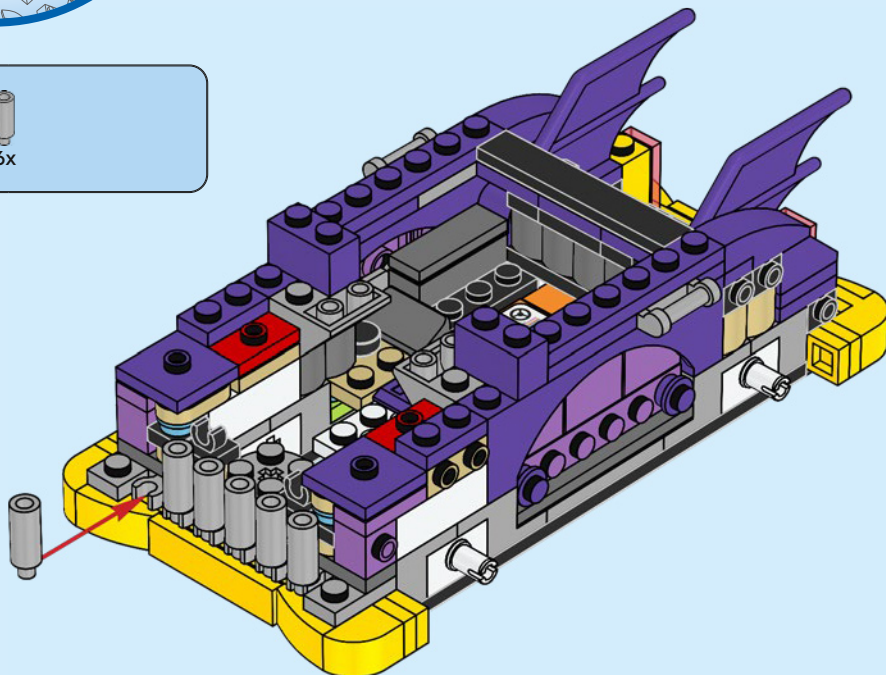



2x

67

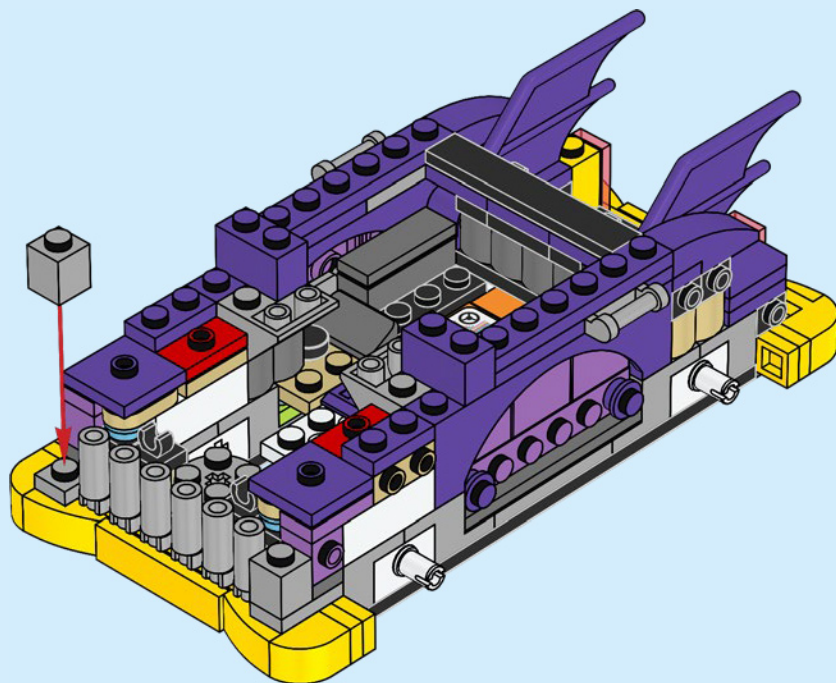

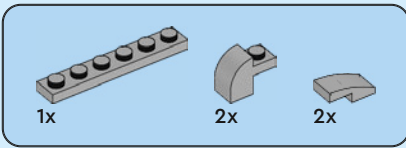

68

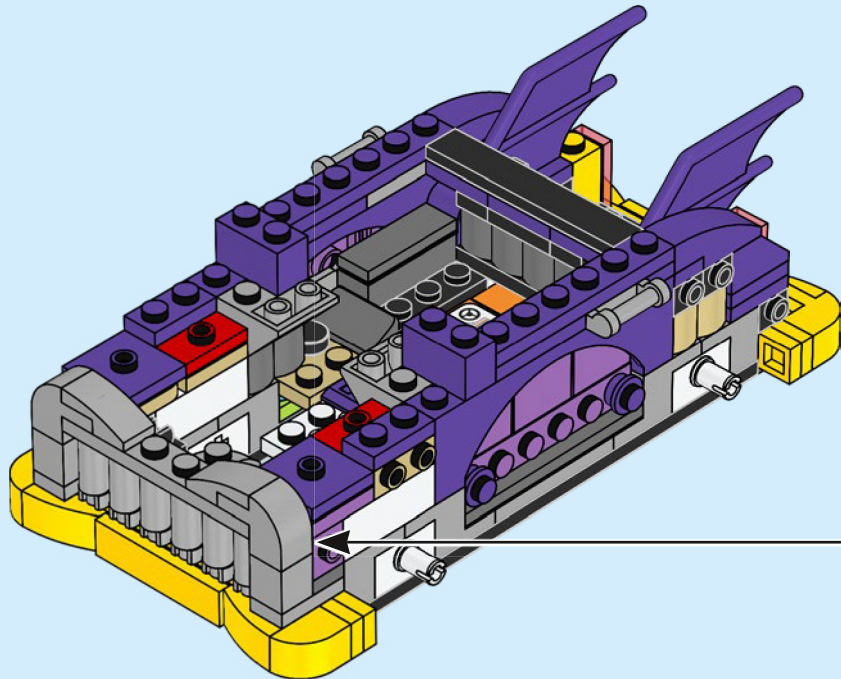
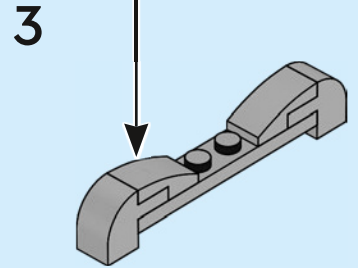
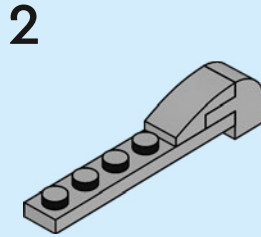
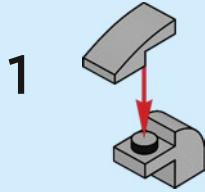



1x

69

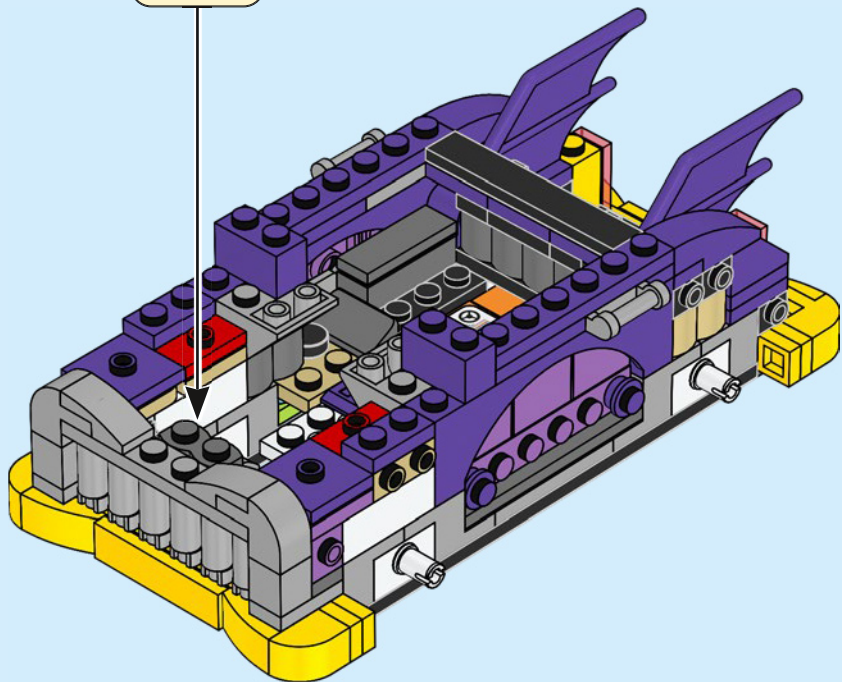
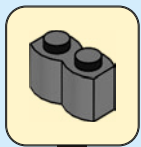



2x

70



2x

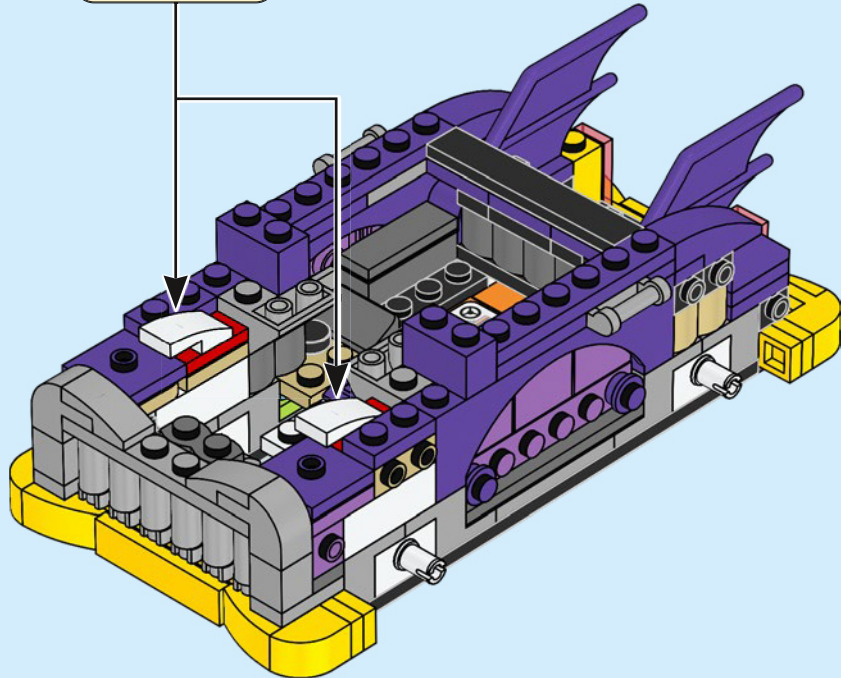



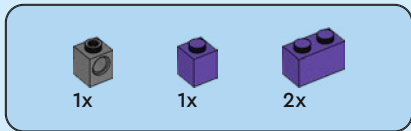

71

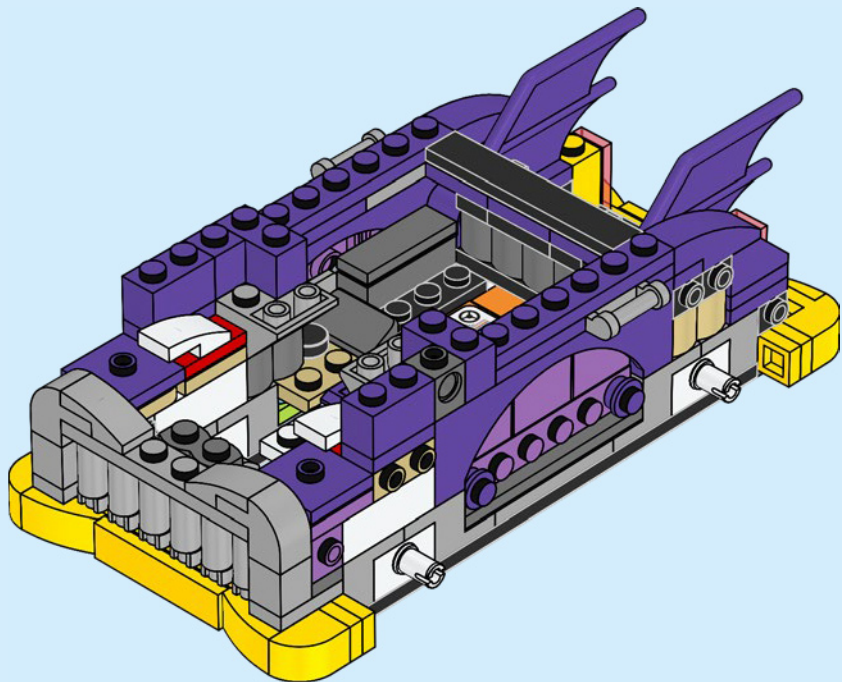

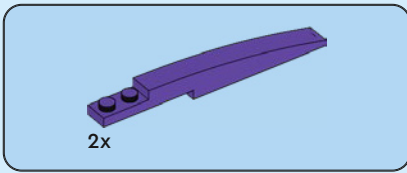

72

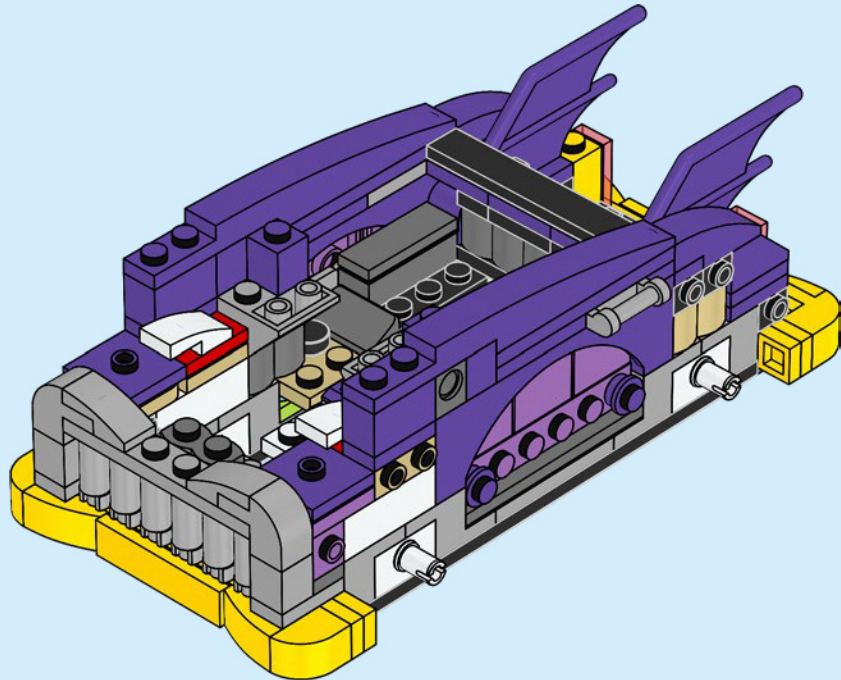





2x



2x

# 73

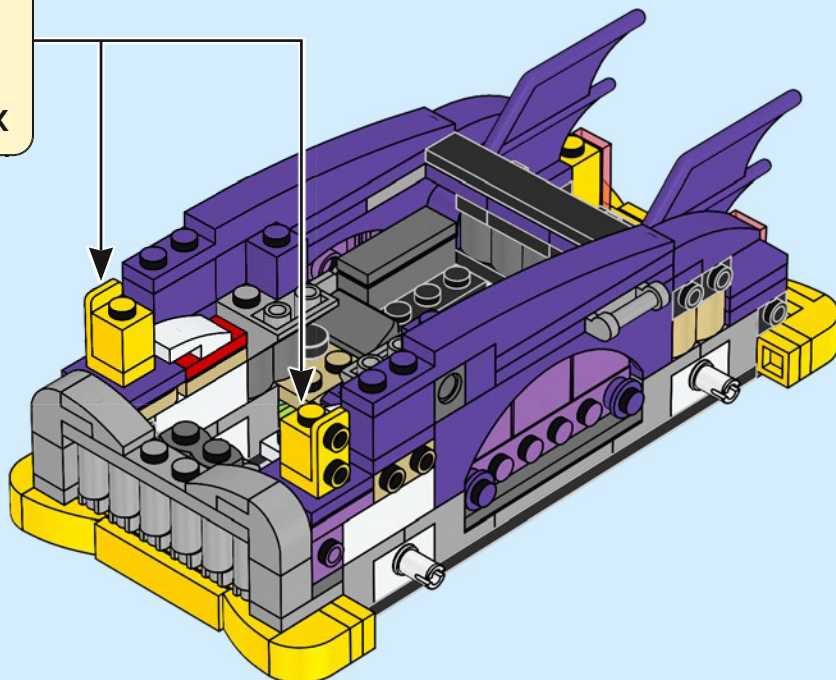
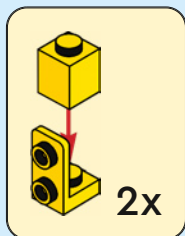



74

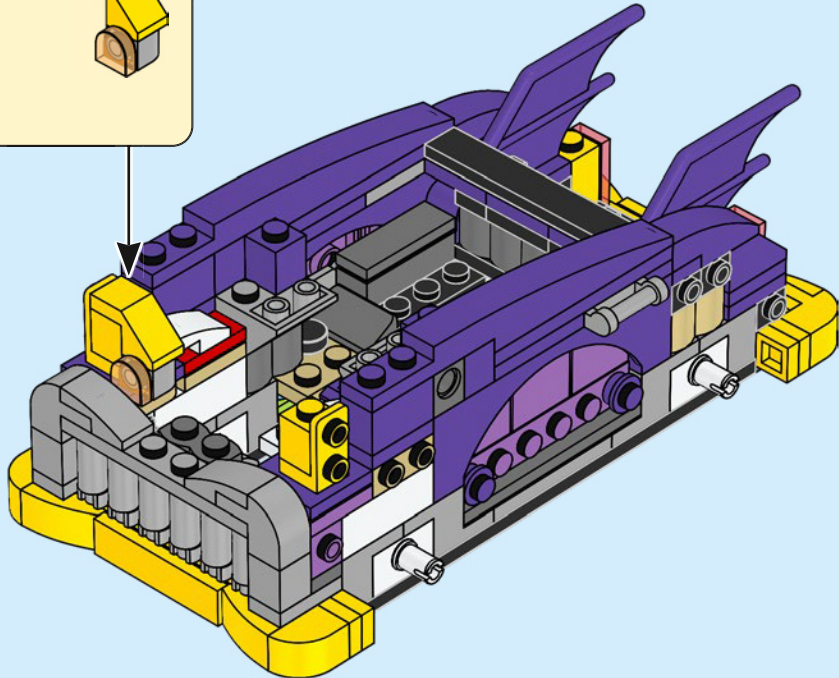
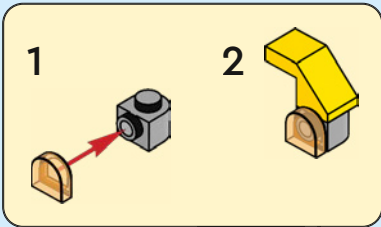

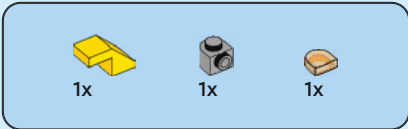

75

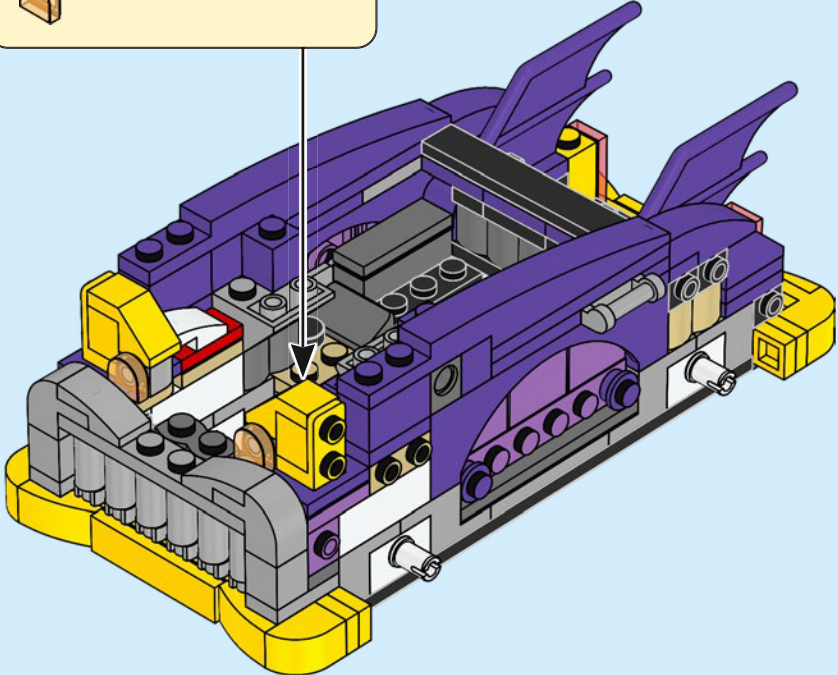
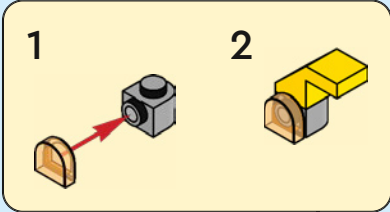

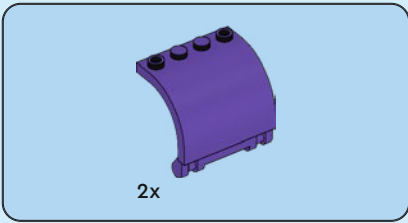

76

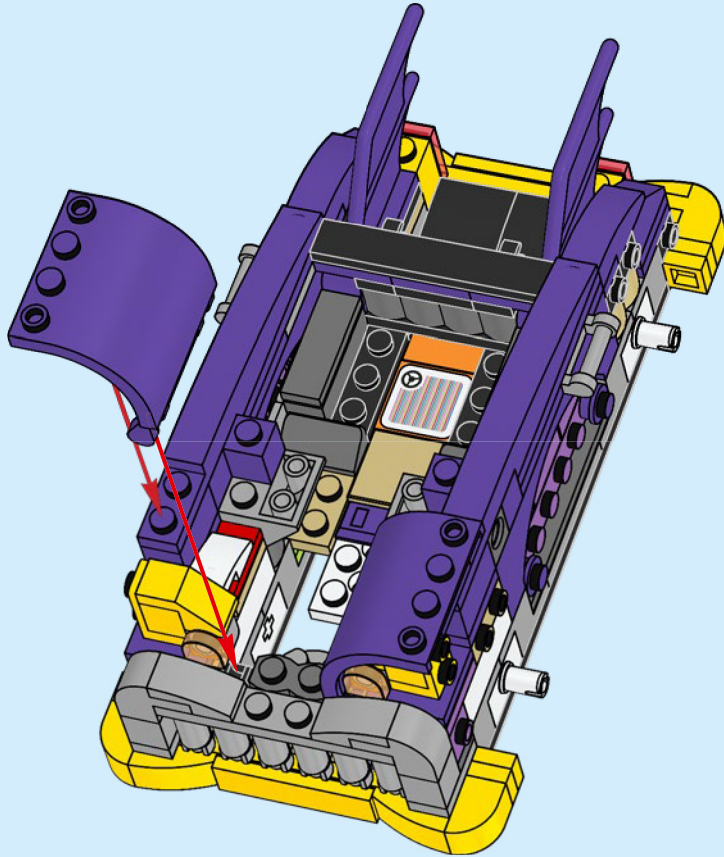

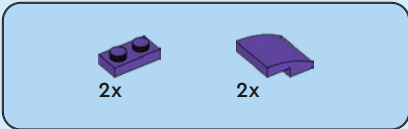

77

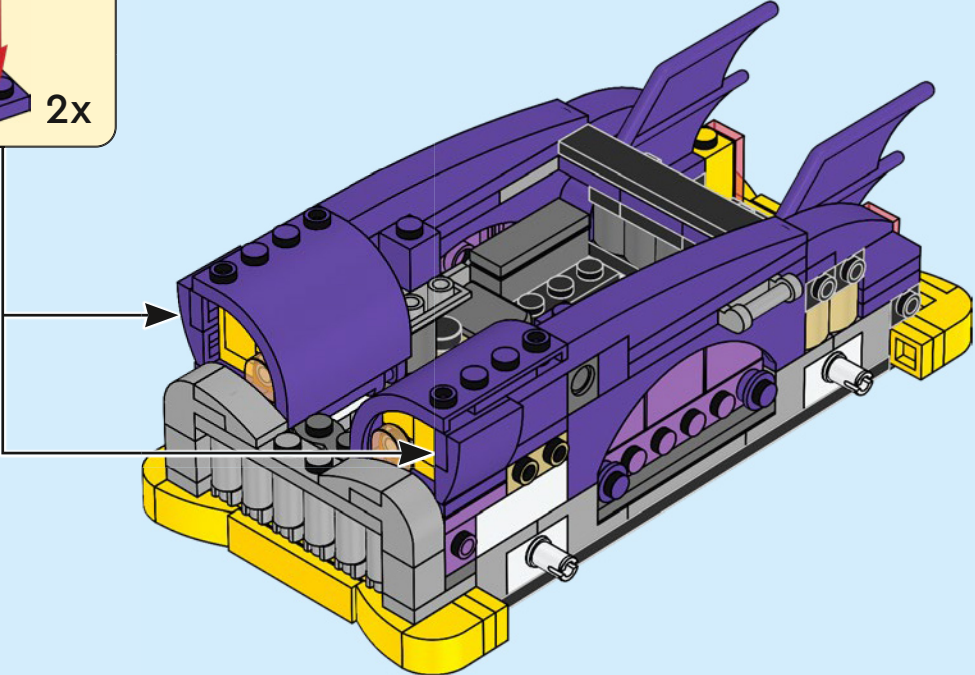
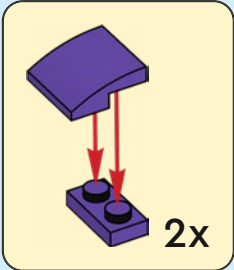



1x

78

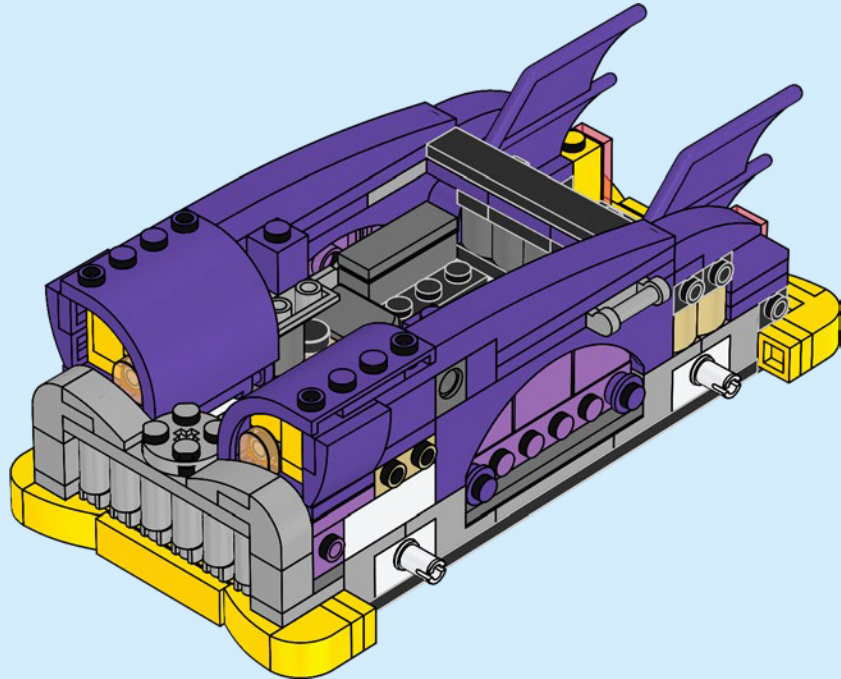

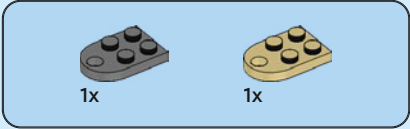
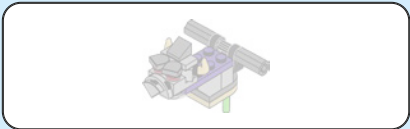

79

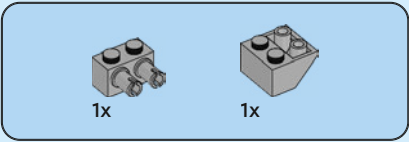
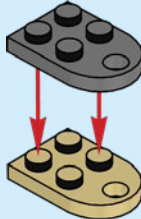

80

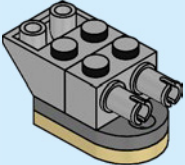

81

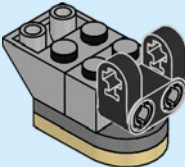



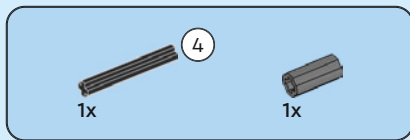

82

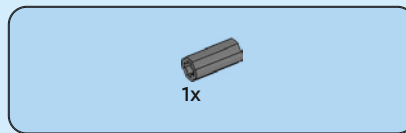
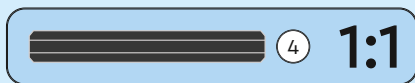
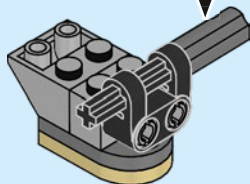
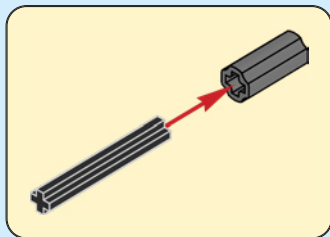

83

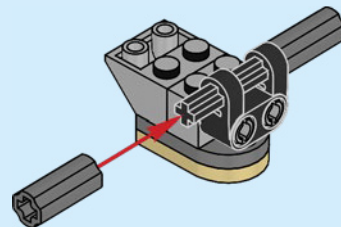

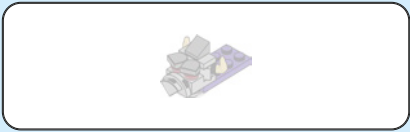

84



85

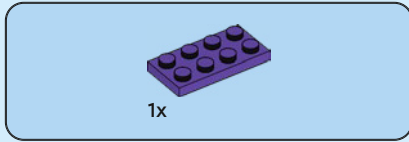

86

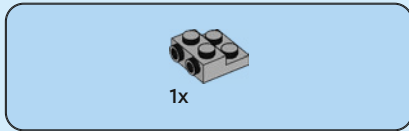
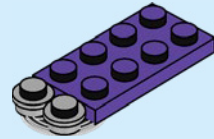

87

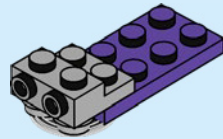

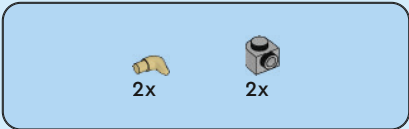

88

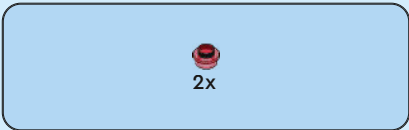
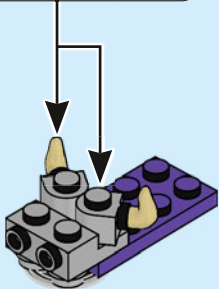
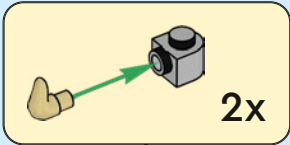

89

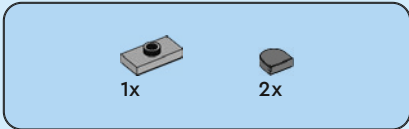
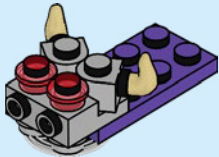

90

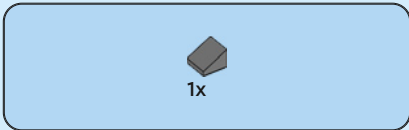
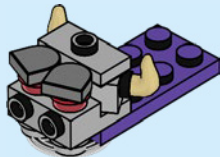

91

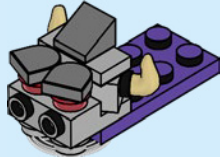

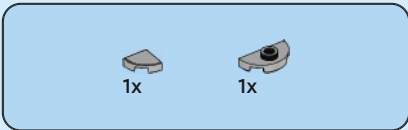

92

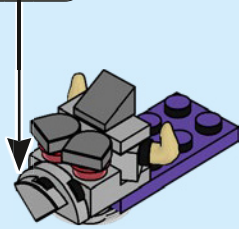
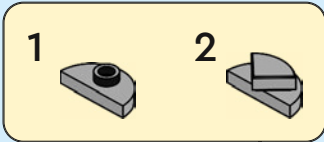

93

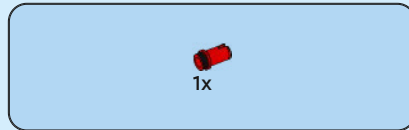
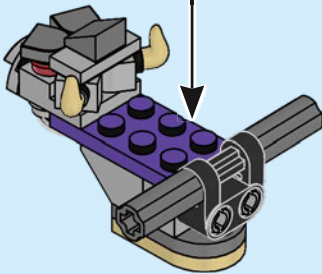

94

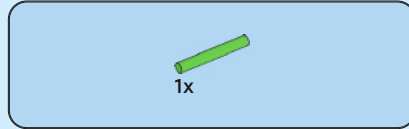
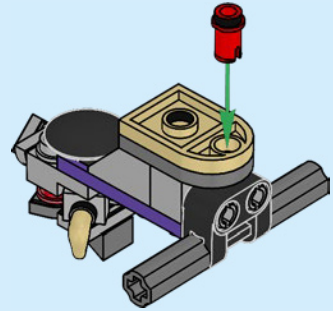

95

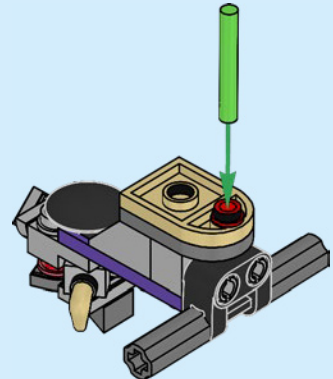

96

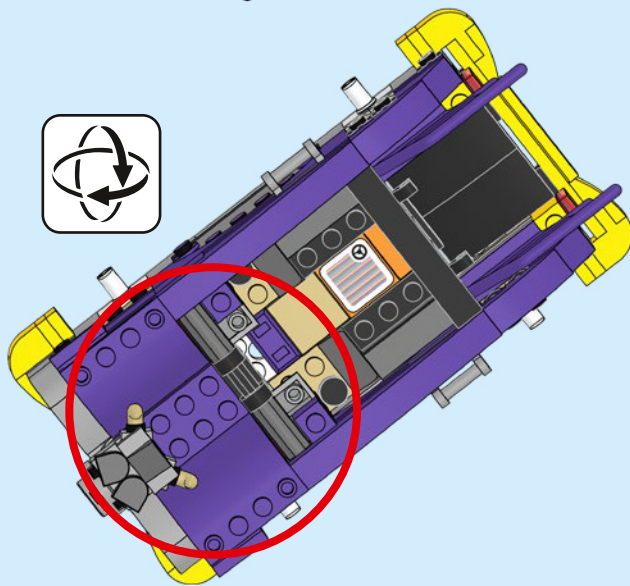
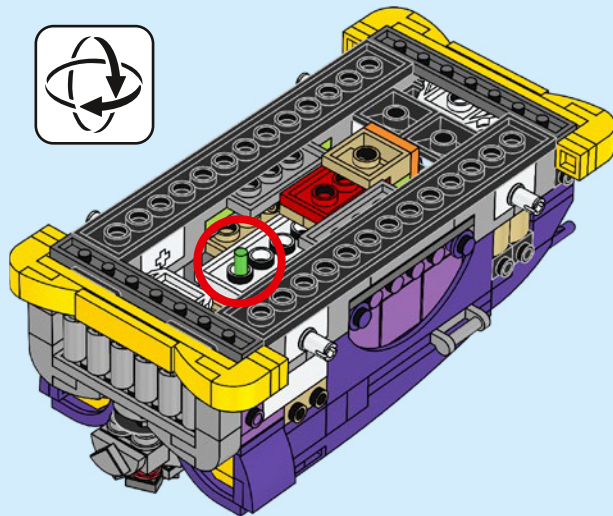
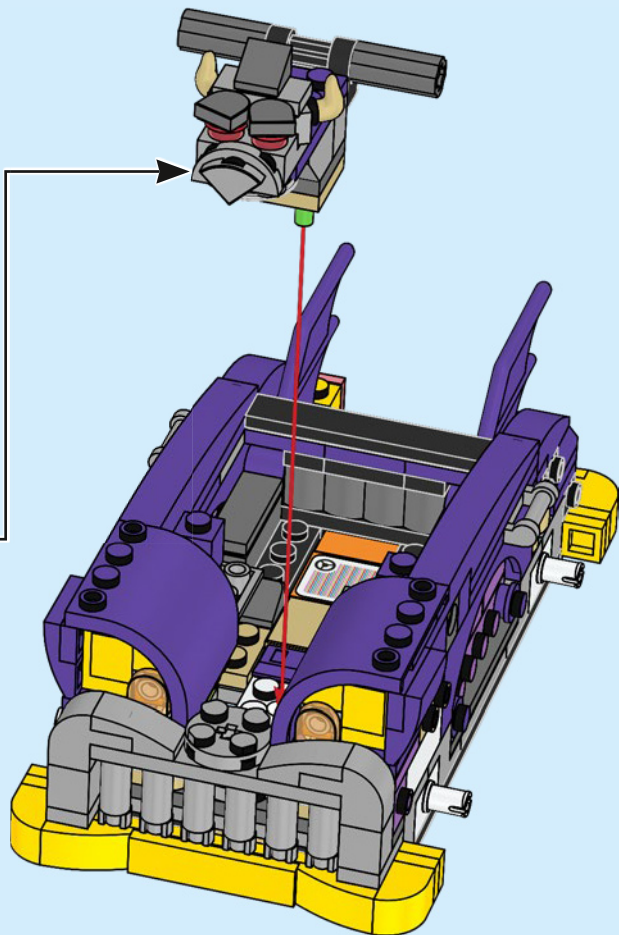

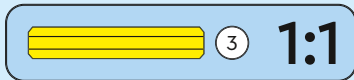
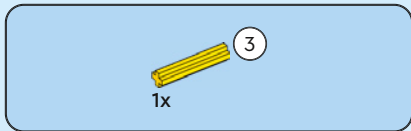

97

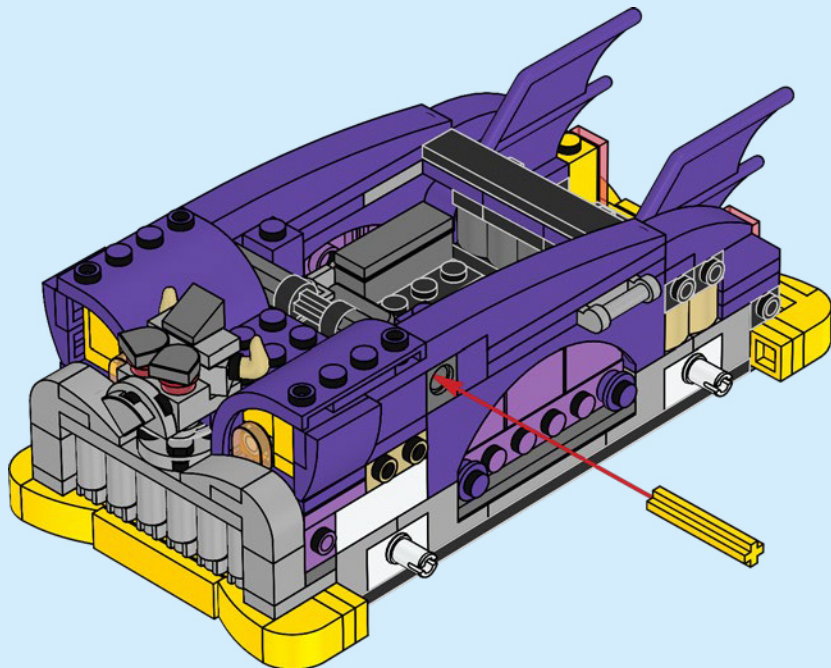

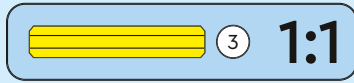
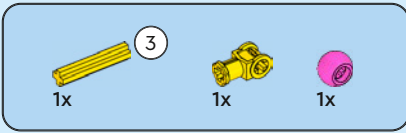

98

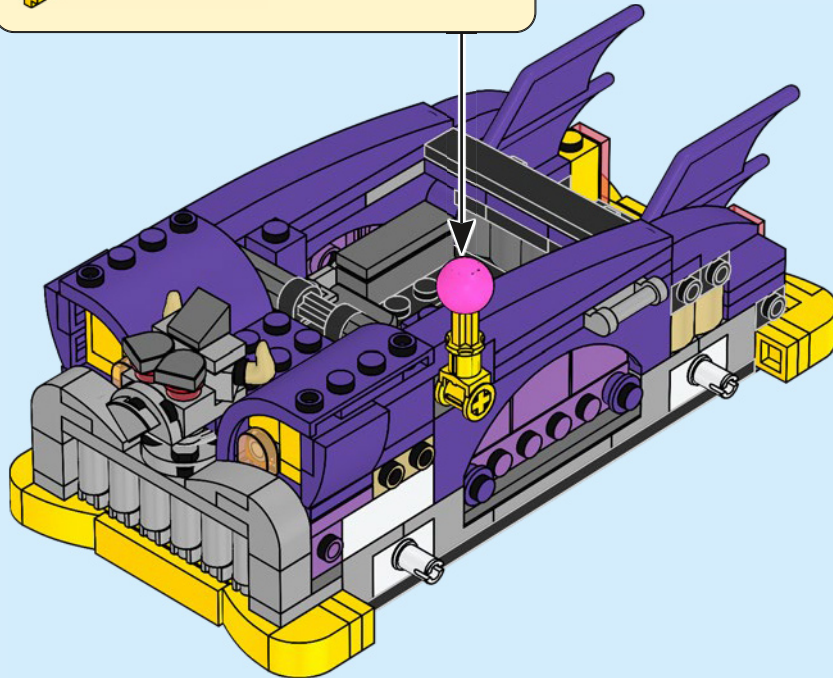
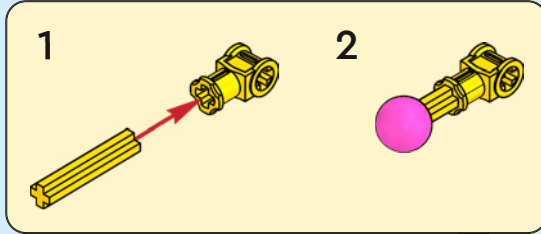



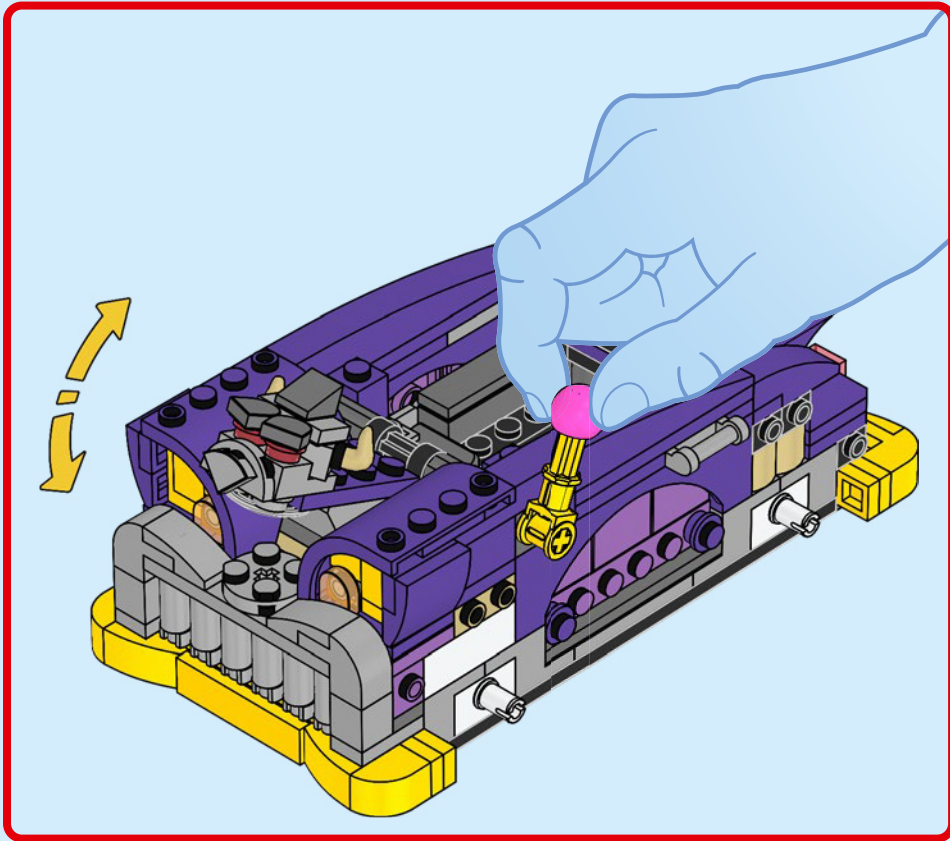



4x



4x

99

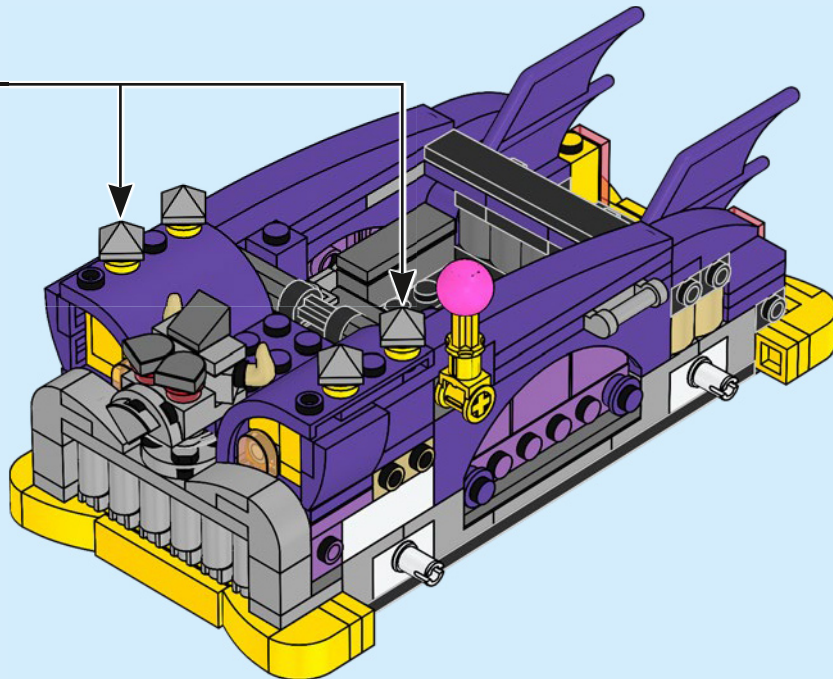
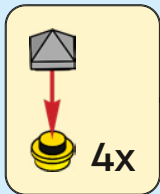

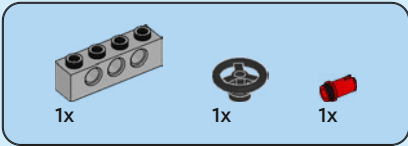

100

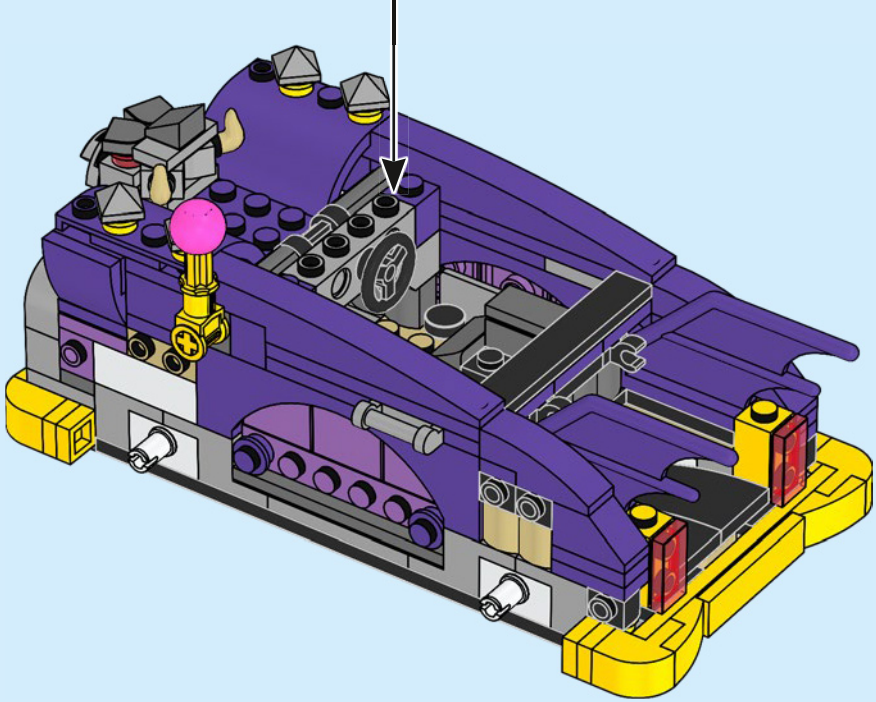
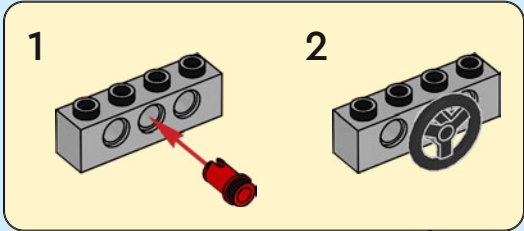

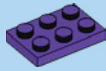

2x

# 101

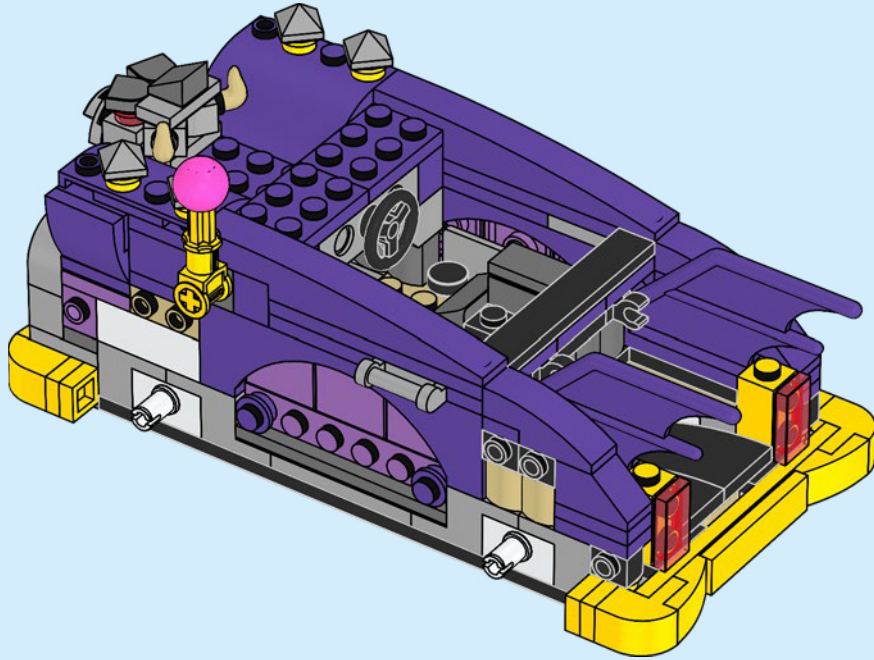

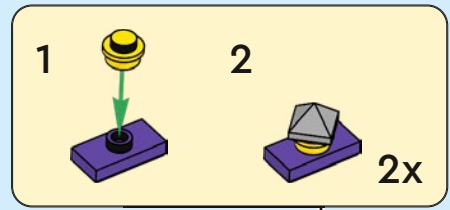
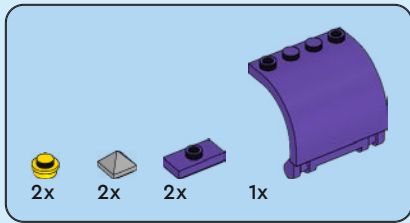

102

1

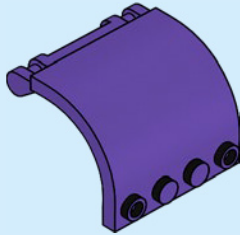

2

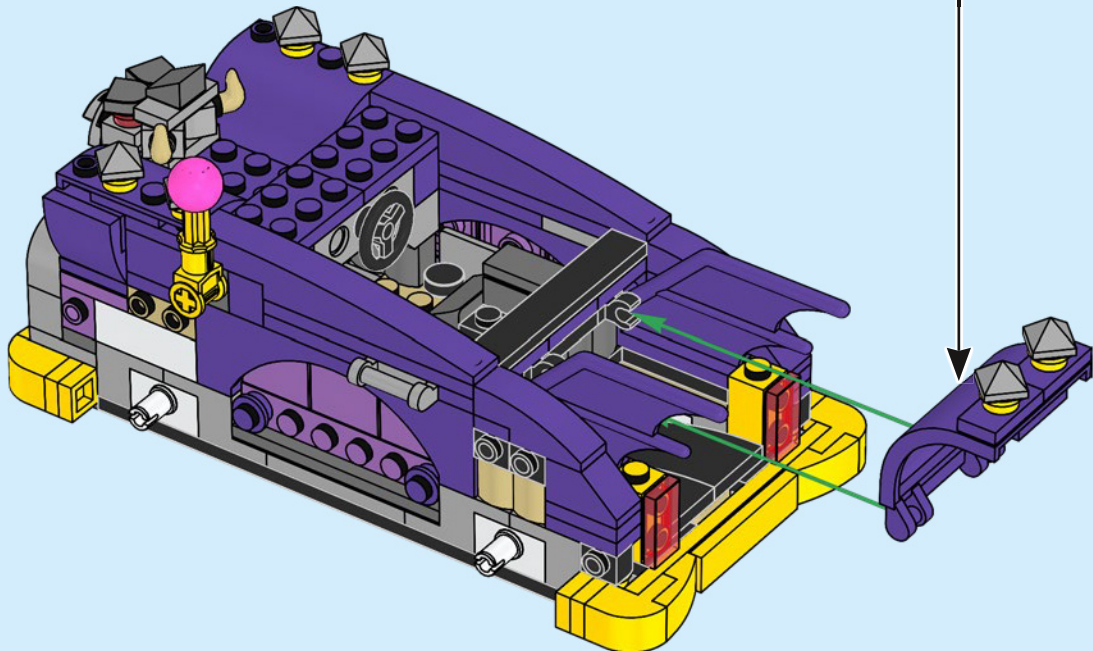
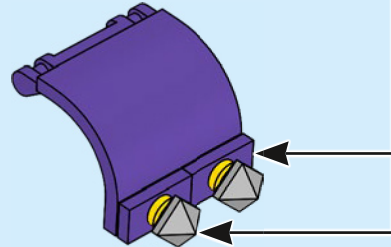



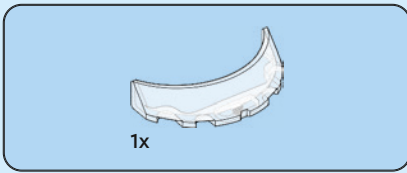

103

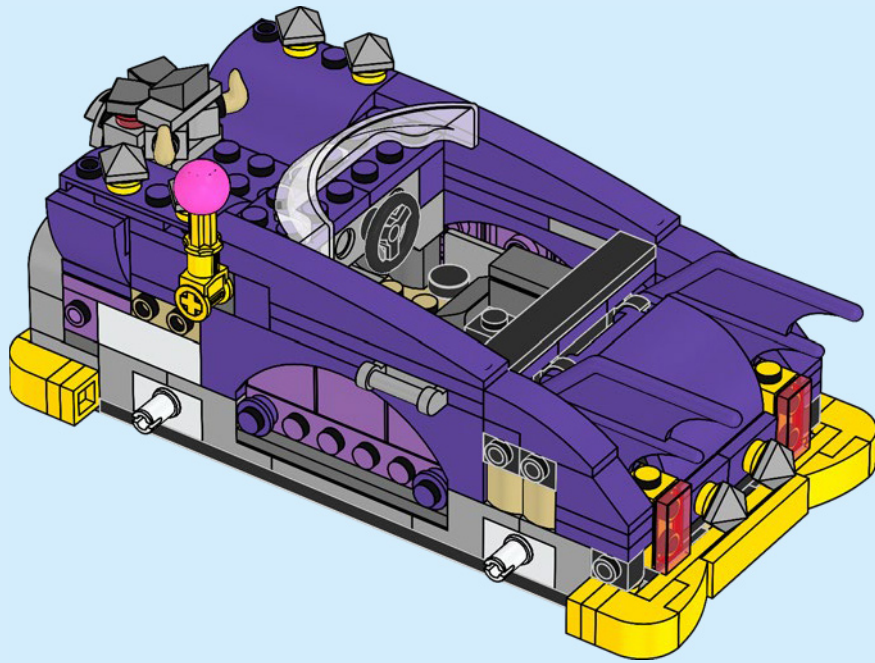



104

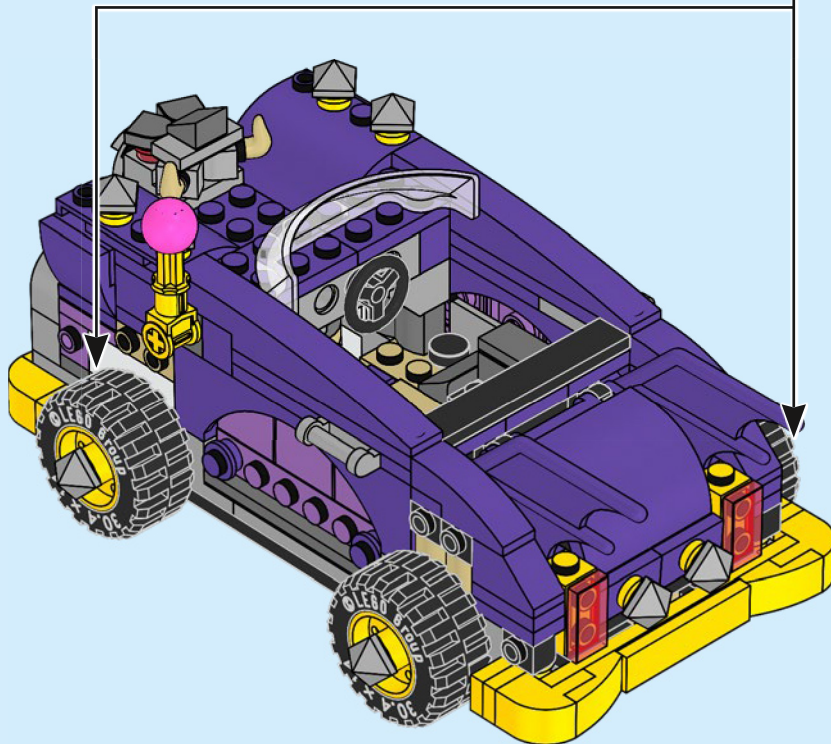
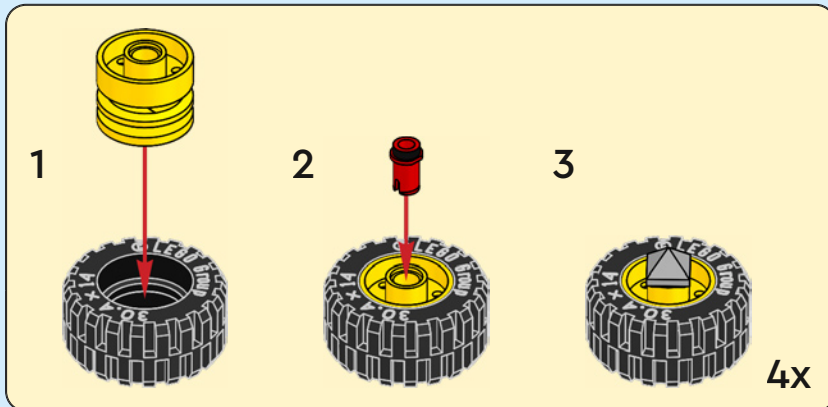



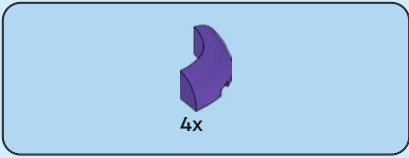

105

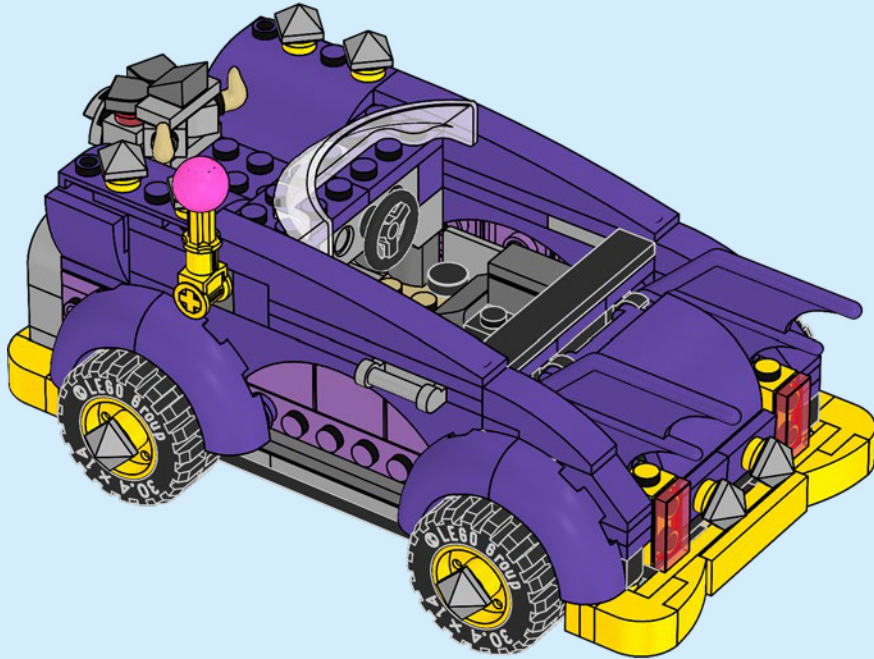

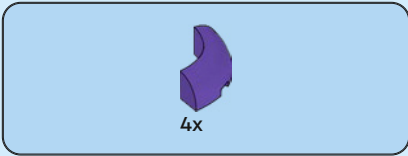

106

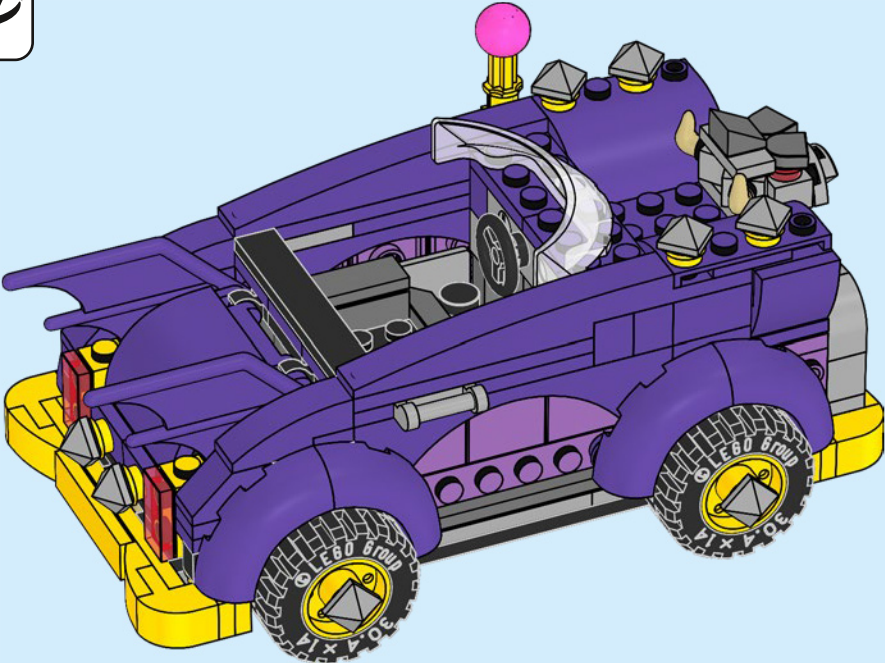

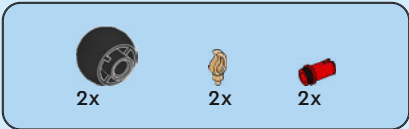

# 107

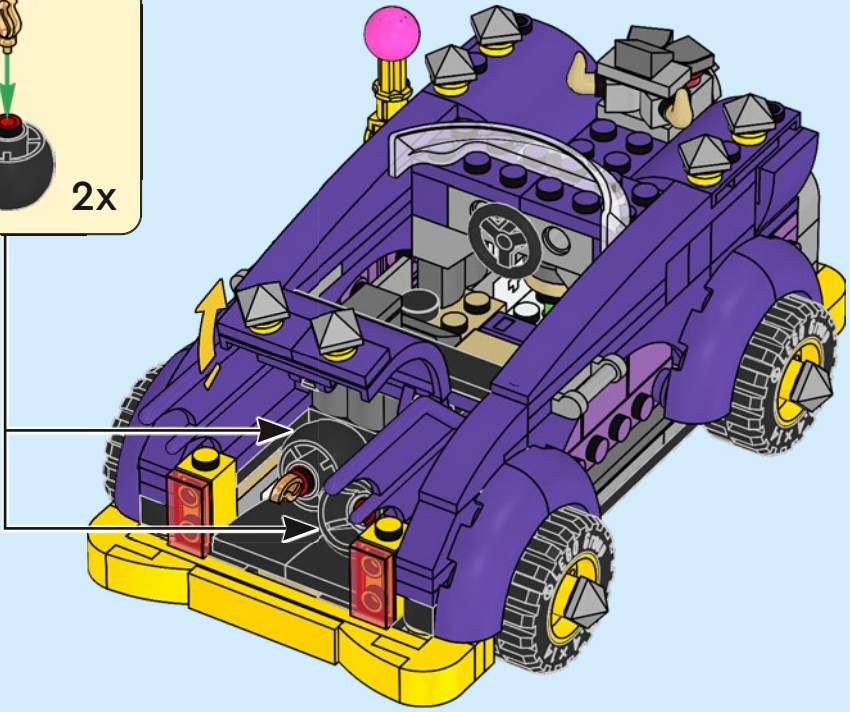
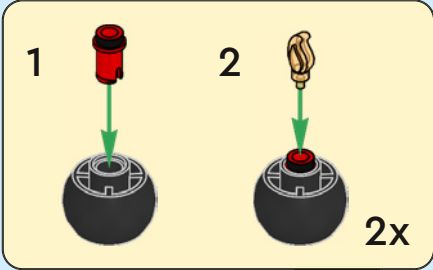

1

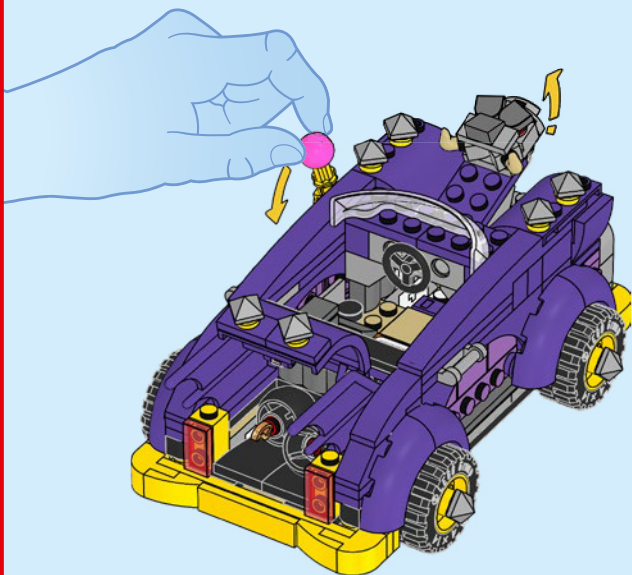

2

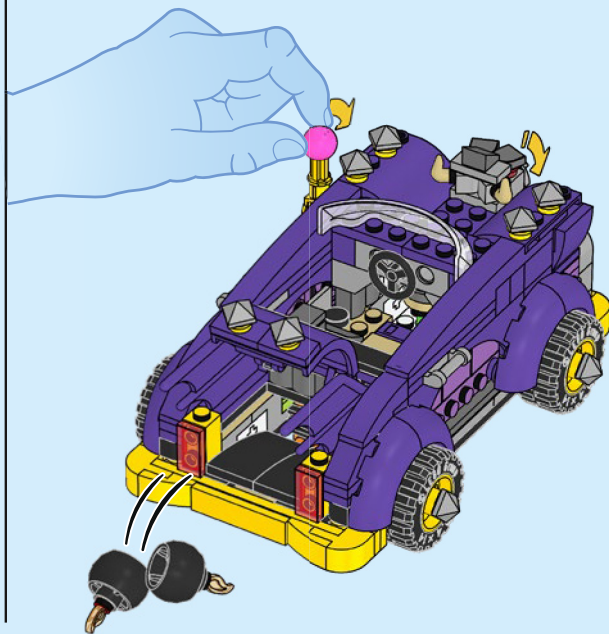

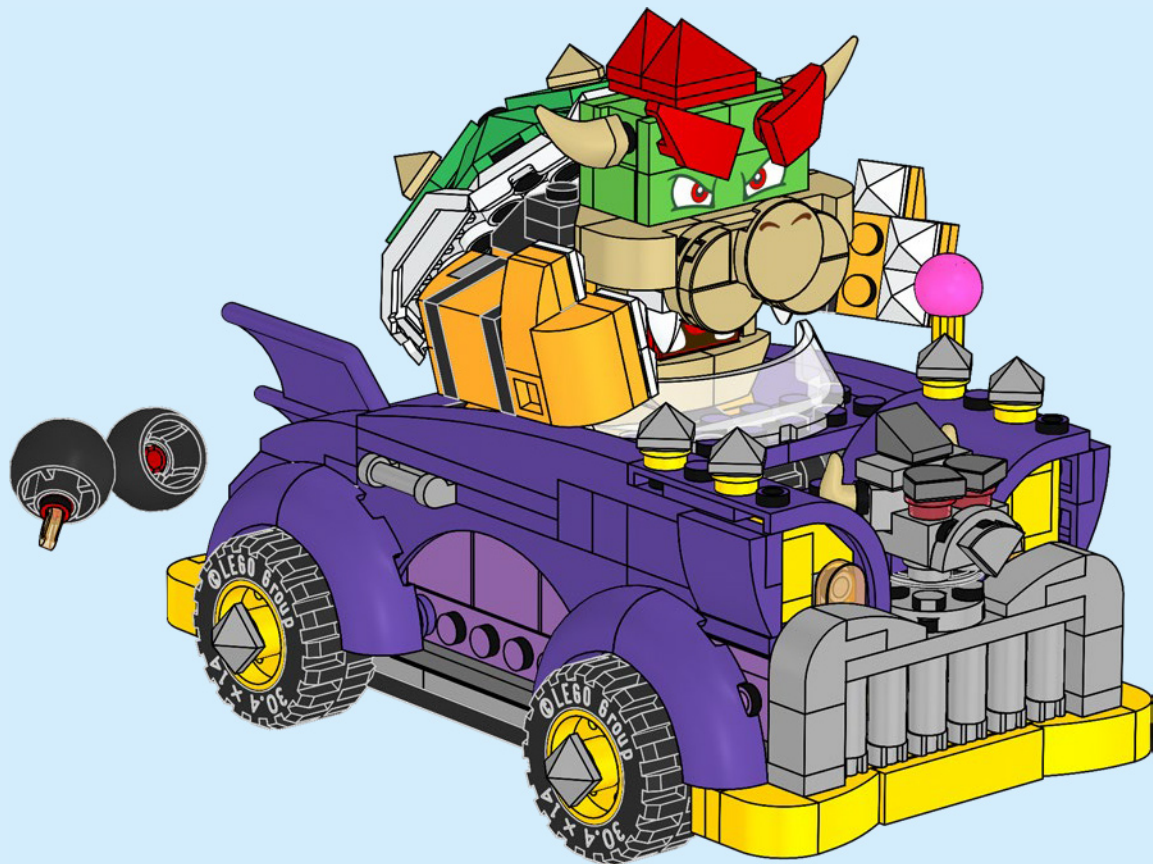



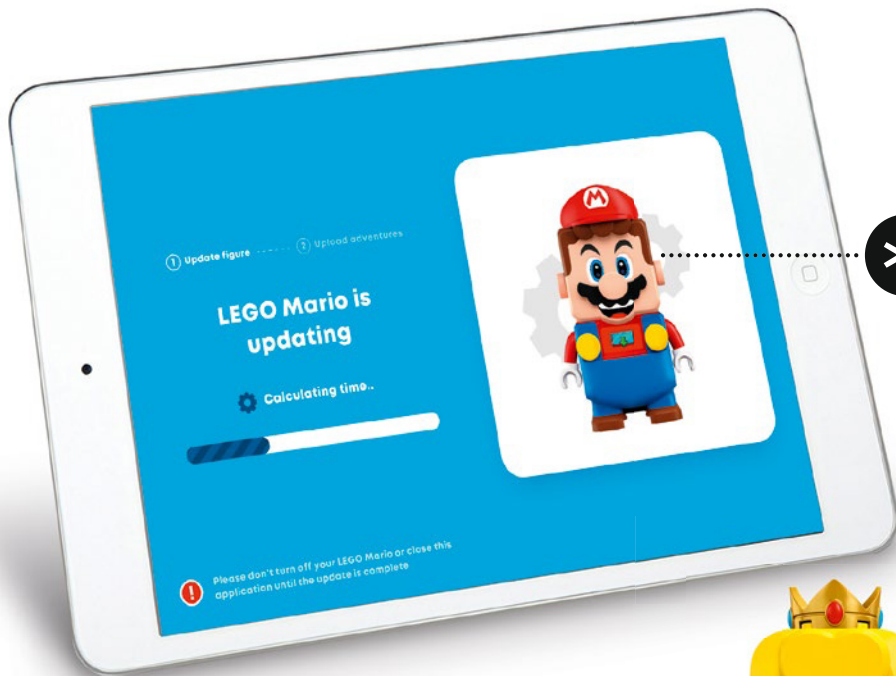

**UPDATE YOUR  
INTERACTIVE FIGURE  
IN THE LEGO®  
SUPER MARIO™ APP TO  
BE READY TO PLAY**

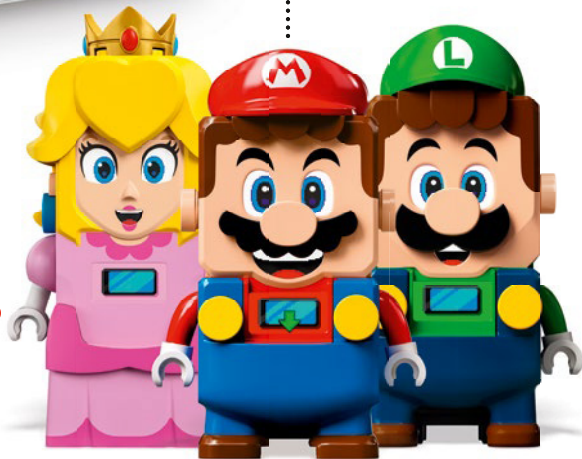

Update your interactive figure in the LEGO® Super Mario™ app to be ready to play

Aktualisiere deine interaktive Figur in der LEGO® Super Mario™ App und das Spiel kann beginnen

Mets à jour ta figurine interactive dans l'appli LEGO® Super Mario™ avant de jouer

Aggiorna il tuo personaggio interattivo nell'app LEGO® Super Mario™ perché sia pronto per giocare

Actualiza tu figura interactiva en la app LEGO® Super Mario™ y prepárate para jugar

Atualiza a tua figura interativa na aplicação LEGO® Super Mario™ para começar a jogar

在乐高®超级马力欧应用程序中更新你的交互式人偶，为玩乐做好准备

Zaktualizuj swoją interaktywną figurkę w aplikacji LEGO® Super Mario™, aby przygotować ją do zabawy

Aktualizujte interaktivní figurku v aplikaci LEGO® Super Mario™, abyste se mohli pustit do hraní

Aktualizujte interaktivnú figúrku v aplikácii LEGO® Super Mario™, aby ste mohli pustiť do hrania

Frissítsd interaktív figurád a LEGO® Super Mario™ alkalmazásban és készülj fel a játékra!

Actualizează-ți figurina interactivă în aplicația LEGO® Super Mario™ pentru a fi gata de joacă

Актуализирайте интерактивната фигура в приложението LEGO® Super Mario™, за да сте готови за игра

Atjaunini savu interaktīvo figūru LEGO® Super Mario™ lietotnē, lai būtu gatavs rotaļāties

Värskenda oma interaktiivset figuuri rakenduses LEGO® Super Mario™, et olla mängimiseks valmis

Atnaujinkite interaktyvią figūrėlę programėlėje „LEGO® Super Mario™“ ir pasiruoškite žaisti



## LEGO® Super Mario™ app

LEGO® Super Mario™ App  
Appli LEGO® Super Mario™  
App LEGO® Super Mario™  
App LEGO® Super Mario™  
Aplicação LEGO® Super Mario™  
乐高®超级马力欧™应用程序  
Aplikacija LEGO® Super Mario™  
Aplikace LEGO® Super Mario™  
Aplikácia LEGO® Super Mario™  
LEGO® Super Mario™ alkalmazás  
Aplicația LEGO® Super Mario™  
Приложение LEGO® Super Mario™  
LEGO® Super Mario™ lietotne  
LEGO® Super Mario™ rakendus  
Programélé „LEGO® Super Mario™“



[LEGO.com/super-mario-trouble-shooting-guide](https://www.lego.com/super-mario-trouble-shooting-guide)





71431

+



71360

OR



71387

OR



71403

OR / ODER / OU / OPPURE / O / 或 / LUB / NEBO / ALEBO / VAGY / SAU / ИЛИ / ВАИ / VÕI / ARBA

**DISCOVER MORE  
ABOUT YOUR  
SET IN THE APP**



Discover more about your set in the app  
Entdecke in der App noch mehr über dein Set  
Découvre plus de détails sur ton set dans l'appli  
Scopri di più sul tuo set nell'app  
Descubre más acerca de tu set en la app  
Conhece melhor o teu set na aplicação  
可通过应用程序了解更多关于此套装的信息  
Dowiedz się więcej sprawdzając w aplikacji  
Zjistěte více o své stavebnici v aplikaci  
Zisti viac o svojej stavebnici v aplikácii  
Tudj meg többet a készletről az alkalmazásban!  
Descoperă mai multe despre setul tău în aplicație  
Откройте повече за комплекта в приложението  
Atklāj vairāk par komplektu lietotnē  
Avasta oma komplekti kohta lisateavet rakendusest  
Sužinokite daugiau apie rinkinį programėlėje







71430



71431



71360

Starter Course 71360 and/or 71387 and/or 71403 needed

Starterset 71360 und/oder 71387 und/oder 71403 wird benötigt

Pack(s) de démarrage 71360 et/ou 71387 et/ou 71403 nécessaire(s)

Starter Pack 71360 e/o 71387 e/o 71403 necessari

Se necesita el Pack Inicial 71360 y/o 71387 y/o 71403

Necessita do Pack Inicial 71360 e/ou 71387 e/ou 71403

スターセット (71360/71387/71403 のいずれか) が必要です

需要入门套组 71360 和/或 71387 和/或 71403

스타터팩 71360, 71387 또는 71403 이 필요합니다

Для игры необходимы Стартовые наборы (арт. 71360 и/или 71387, и/или 71403)

Potrzebne są zestawy startowe 71360, 71387 i/lub 71403

Je zapotřebí startovací set 71360 nebo 71387 nebo 71403

Je potrebný štartovací set 71360 a/alebo 71387 a/alebo 71403

A 71360-as és/vagy a 71387-es és/vagy a 71403-as Kezdőpálya szükséges

Este nevoie de Setul de bază 71360 și/sau 71387 și/sau 71403

Нужни са начална писта 71360 и/или 71387 и/или 71403

Nepieciešams sākuma maršruta komplekts 71360 un/vai 71387, un/vai 71403

Vaja on alustusrada 71360 ja/või 71387 ja/või 71403

Reikalingas pradinis rinkinys 71360 ir (arba) 71387 ir (arba) 71403



Rebuild  
the  
world™





Rebuild  
the  
world™



|               |               |               |               |               |               |               |
|---------------|---------------|---------------|---------------|---------------|---------------|---------------|
|               |               |               |               |               |               |               |
| 6x<br>6314487 | 2x<br>6314377 | 1x<br>4185177 | 2x<br>6089698 | 4x<br>6361082 | 4x<br>393726  | 4x<br>4619323 |
|               |               |               |               |               |               |               |
| 1x<br>6218823 | 2x<br>6368620 | 3x<br>6469454 | 1x<br>6117974 | 4x<br>6109681 | 4x<br>393826  | 2x<br>4647286 |
|               |               |               |               |               |               |               |
| 2x<br>6046384 | 2x<br>6145570 | 1x<br>6170776 | 1x<br>6309105 | 2x<br>243124  | 2x<br>6347310 | 1x<br>302326  |
|               |               |               |               |               |               |               |
| 8x<br>6178921 | 1x<br>6299936 | 1x<br>6318084 | 1x<br>302121  | 2x<br>346024  | 1x<br>302326  | 1x<br>302026  |
|               |               |               |               |               |               |               |
| 2x<br>6034044 | 5x<br>6249125 | 1x<br>6294716 | 2x<br>302323  | 2x<br>6284070 | 1x<br>241226  |               |
|               |               |               |               |               |               |               |
| 2x<br>6046381 | 2x<br>6408047 | 2x<br>6294716 | 10x<br>614124 | 6x<br>6424674 | 2x<br>6000650 |               |
|               |               |               |               |               |               |               |
| 4x<br>6289797 | 6x<br>6212758 | 3x<br>4113233 | 2x<br>300524  | 2x<br>302426  | 4x<br>6016172 |               |
|               |               |               |               |               |               |               |
| 2x<br>6188400 | 1x<br>6299935 | 1x<br>6312481 | 2x<br>6441826 | 2x<br>6344752 | 2x<br>6250020 |               |
|               |               |               |               |               |               |               |
| 2x<br>6188400 | 2x<br>4140562 | 3x<br>4113993 | 8x<br>302424  | 2x<br>6308000 | 2x<br>302226  |               |
|               |               |               |               |               |               |               |
| 2x<br>4249506 | 1x<br>6310515 | 2x<br>614121  | 2x<br>6330893 | 1x<br>4278359 | 1x<br>300326  |               |
|               |               |               |               |               |               |               |
| 2x<br>300201  | 4x<br>6281995 | 8x<br>6378120 | 1x<br>6375678 | 1x<br>6057397 | 4x<br>362326  |               |
|               |               |               |               |               |               |               |
|               |               |               |               |               |               |               |
| 1x<br>4527945 | 2x<br>4114026 | 1x<br>6177505 | 1x<br>6313121 | 1x<br>6349281 | 1x<br>370526  |               |
|               |               |               |               |               |               |               |
|               |               |               |               |               |               |               |
| 1x<br>6318110 | 1x<br>4113917 | 2x<br>6075074 | 2x<br>6228597 | 2x<br>6273330 | 1x<br>371026  |               |
|               |               |               |               |               |               |               |
|               |               |               |               |               |               |               |
| 1x<br>6092587 | 2x<br>6411329 | 2x<br>6092565 | 4x<br>6029947 | 2x<br>6069000 | 2x<br>6001494 |               |
|               |               |               |               |               |               |               |
|               |               |               |               |               |               |               |



1x  
6161772

1x  
6309102

1x  
6141590

1x  
6246850

2x  
6208450

2x  
6251290

1x  
4188771

1x  
4159007

1x  
6474140

2x  
4164037

2x  
4529160

2x  
6357747

2x  
6249116

8x  
6073040

2x  
6318085

3x  
6024286

4x  
6374487

6x  
6145215

2x  
6337271

4x  
6099714

4x  
6034175

5x  
6003033

2x  
6295078

2x  
6469079

1x  
6248671

2x  
6071607

6x  
6436421

2x  
4211525

4x  
6448793

2x  
4211389

1x  
6176433

10x  
6258381

1x  
6420741

6x  
6296894

2x  
4211475

2x  
6043656

2x  
4211398

2x  
6285778

2x  
6028813

1x  
6066097

4x  
4654580

1x  
6276874

2x  
4244627

3x  
6435857

1x  
6469440

8x  
6347992

1x  
4211441

2x  
6079461

1x  
4211438

1x  
6228091

2x  
6362252

1x  
4210639

1x  
4504378

2x  
4567887

6x  
4211095

2x  
4516546

2x  
4568734

2x  
4211104

1x  
4225733

2x  
4210651

3x  
4210998

4x  
4566522

1x  
6084028

2x  
6231376

8x  
6367941

9x  
4655695

4x  
6104154

2x  
6109814

2x  
6092604

1x  
6394865

2x  
6446090

2x  
6182217

4x  
6035470

3x  
6433303

2x  
4655691

2x  
6468785

2x  
6358028

2x  
6468787

2x  
6103449

2x  
4225142

1x  
6030277

6x  
6102986

2x  
6125776

2x  
4619512

6x  
6173813

2x  
4649745



 [LEGO.com/service](https://www.LEGO.com/service)

YOU COULD **WIN**

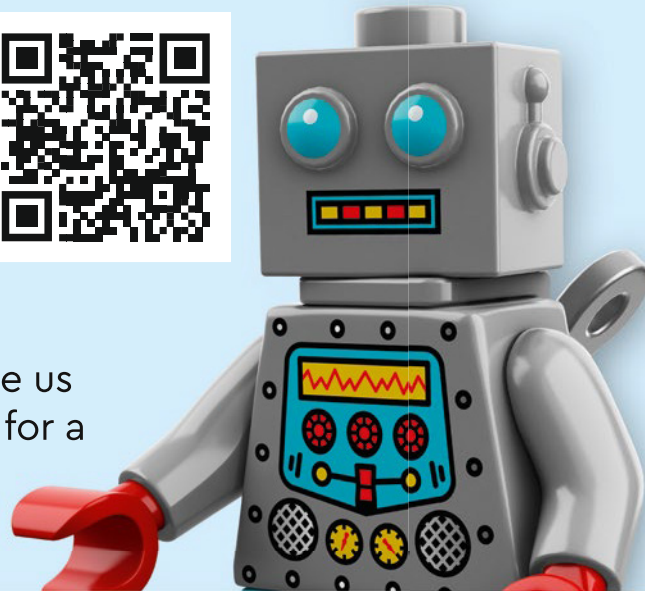

Scan this QR code or go to **LEGO.COM/PRODUCTFEEDBACK** and give us your short feedback about this LEGO® set for a chance to win a cool LEGO prize.

Terms and Conditions apply\*

**EN: YOU COULD WIN.** Terms and Conditions apply\* **DE: Du könntest GEWINNEN.** Es gelten die Teilnahmebedingungen\* **FR: Tu pourrais GAGNER.** Des conditions s'appliquent\* **IT: Potresti VINCERE tu.** Termini e condizioni sono applicabili\* **ES: Puedes GANAR.** Aplican términos y condiciones\* **PT: Poderá GANHAR.** Aplicam-se termos e condições\* **ZH: 轻松获奖. 条款和条件适用\*** **PL: Szansa na WYGRANĄ.** Obowiązują warunki korzystania\* **CS: Máte šanci VYHRÁT.** Platí všeobecné smluvní podmínky\* **SK: Máte šancu VYHRAŤ.** Platia všeobecné zmluvné podmienky\* **HU: TE IS NYERHETSZ.** Felhasználási feltételek érvényesek\* **RO: Ai putea CÂȘTIGA.** Se aplică termeni și condiții\* **BG: Можете да СПЕЧЕЛИТЕ.** Има определени правила и условия\* **LV: Tu vari LAIMĒT.** Ir spēkā noteikumi un nosacījumi.\* **ET: Sul on võimalus VÕITA.** Kehtivad tingimused\* **LT: Jūs galite LAIMĖTI.** Taikomos sąlygos\*

\*[LEGO.com/productfeedback-terms](https://www.lego.com/productfeedback-terms)

LEGO, the LEGO logo and the Brick and Knob configurations are trademarks and/or copyrights of the LEGO Group. ©2024 The LEGO Group.

TM & © 2024 Nintendo.

6497689