



**SUPER  
MARIO**™

71431





### **Get excited about our new packaging!**

We're switching from plastic to paper-based packaging. That's why you might find a mix of paper and plastic in our boxes!

### **Nos nouveaux emballages vous emballeront !**

Nous passons des emballages en plastique aux emballages à base de papier. C'est pourquoi vous pourriez trouver un mélange de papier et de plastique dans nos boîtes !

### **¡Te presentamos nuestros nuevos empaques!**

Estamos sustituyendo las bolsas de plástico por bolsas con base de papel. ¡Por eso, puedes encontrar una mezcla de papel y de plástico en nuestras cajas!

**[LEGO.com/sustainable-packaging](https://www.lego.com/sustainable-packaging)**

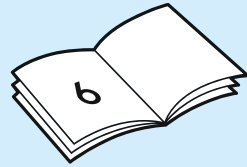
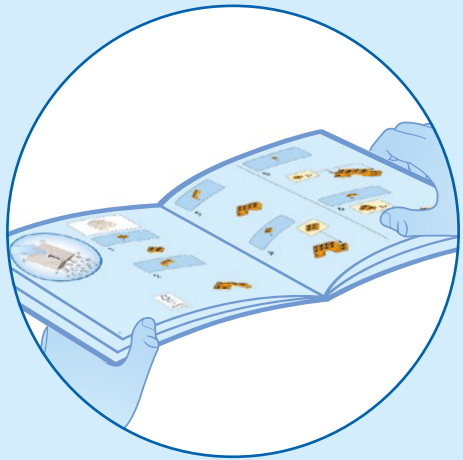
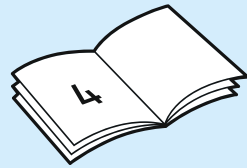
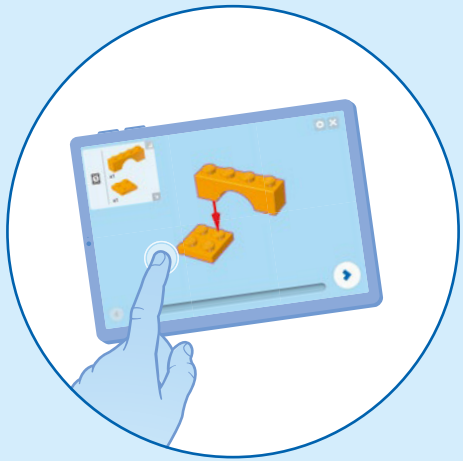



LEGO® Super Mario™ app

**1. Scan QR code to build from digital building instruction**

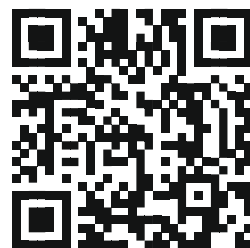

**1. Scanner le code QR pour construire avec les instructions de montage numériques**

**1. Escanea el código QR para construir con instrucciones de construcción digitales**

## 2. Open digital building instruction

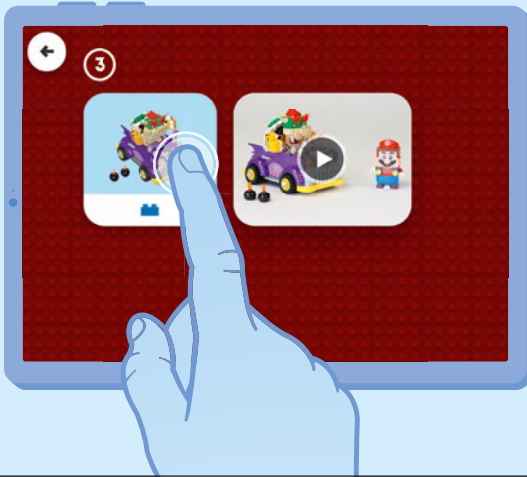

## 2. Ouvrir les Instructions de montage numériques

## 2. Abre las instrucciones de construcción digitales

## 3. Start building

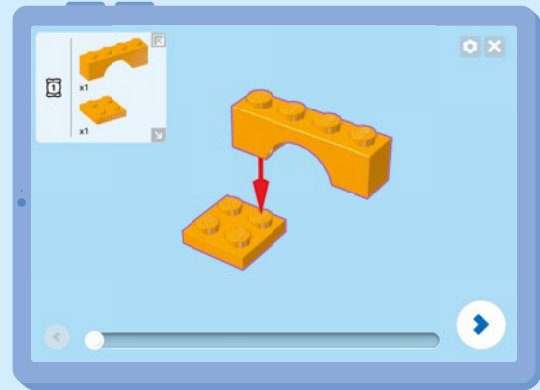

## 3. Commencer à construire

## 3. Empieza a construir

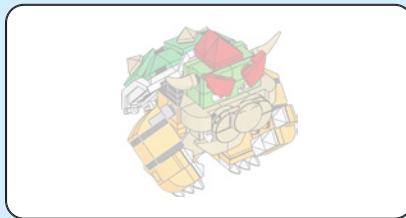

1

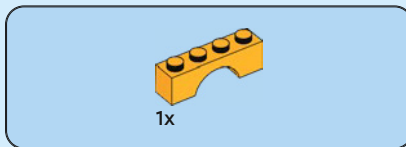

2

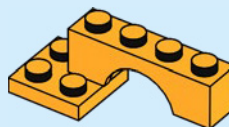

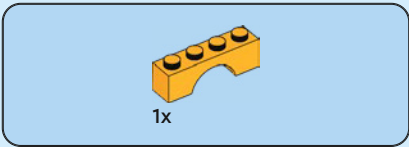

3

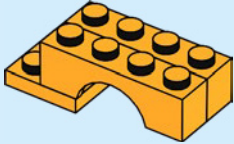

4

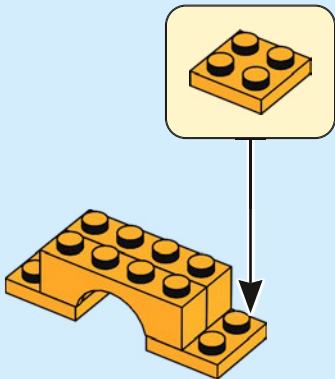

5

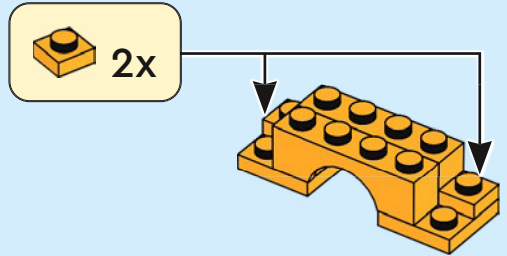

6

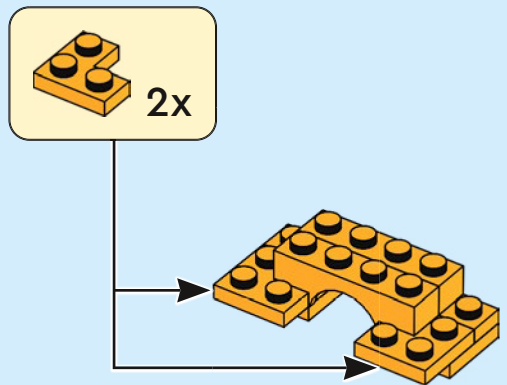



2x

7

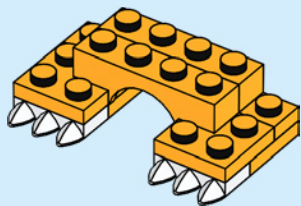

4x

8

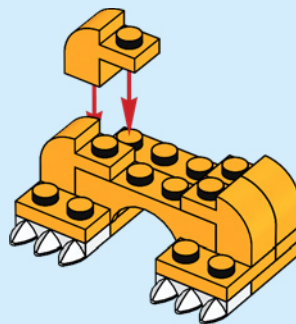

2x

9

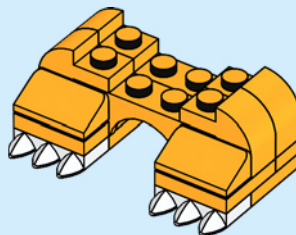



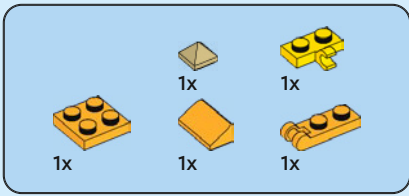

10

1

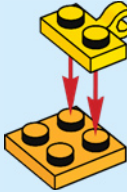

2



3

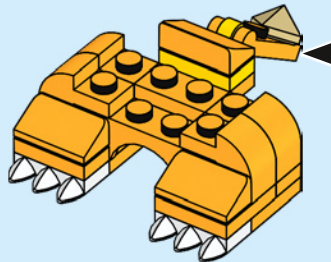
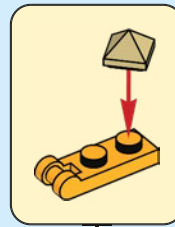
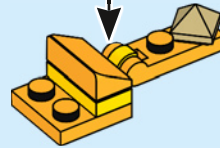



2x

11

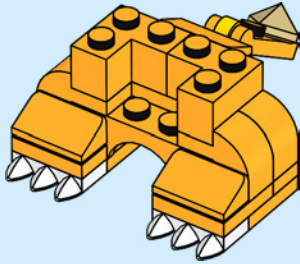

1x

12

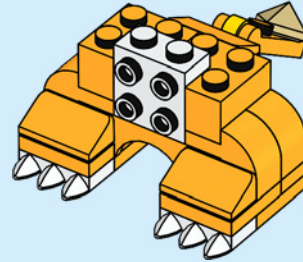

2x



2x

13



2x

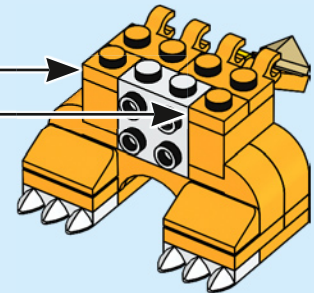

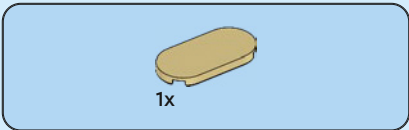

14

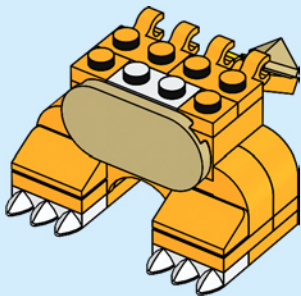

15

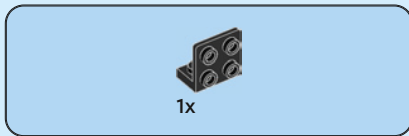
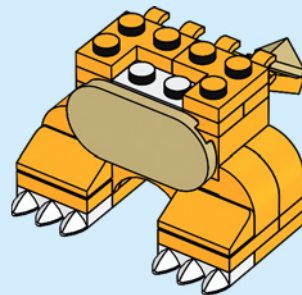

16

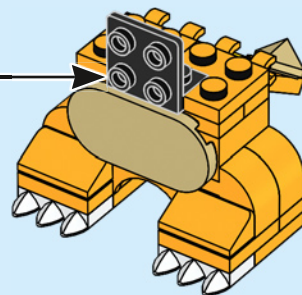



2x

17

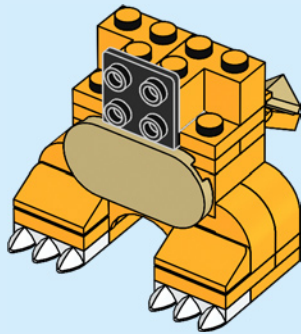

2x

18

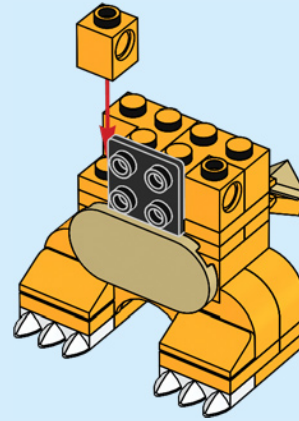

1x

19

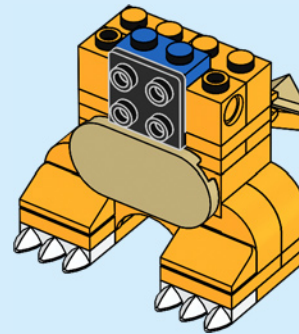



20

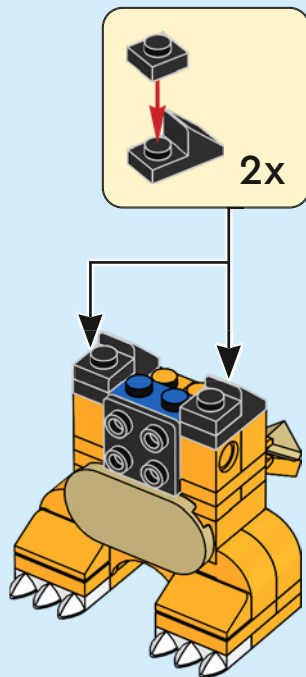

21

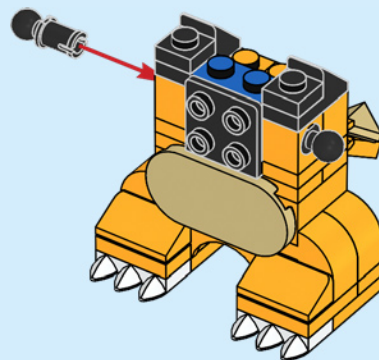



1x

22

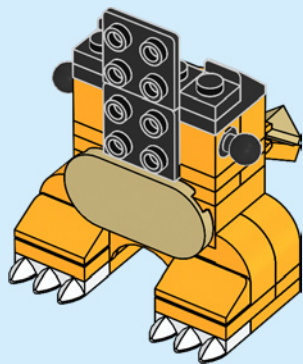

1x

23

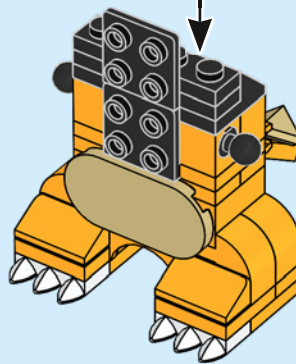
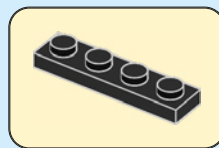

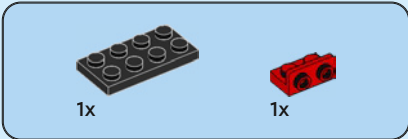

24

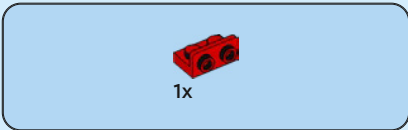
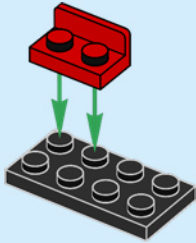

25

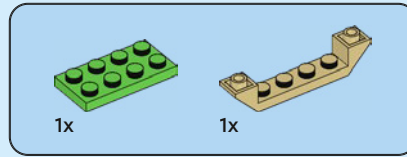
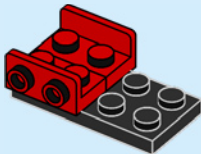

26

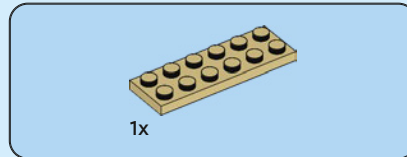
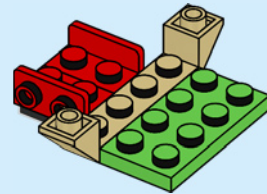

27

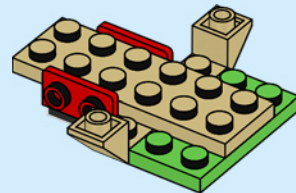



28

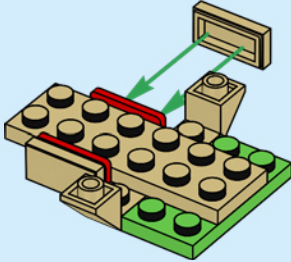

29

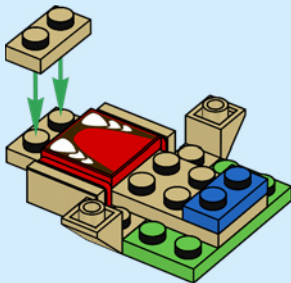

30

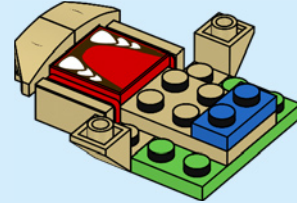

31

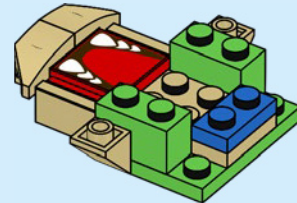





2x

32

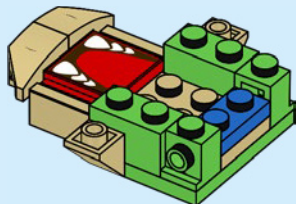

1x

33

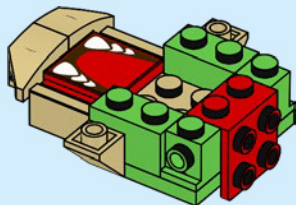

2x

34

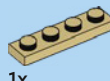
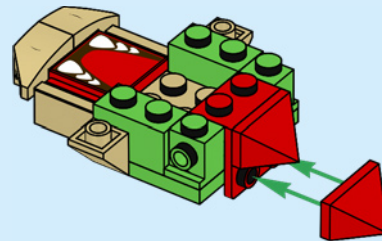

1x

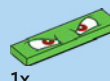

1x



2x

35

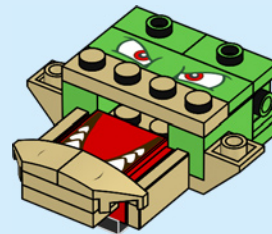



2x

36

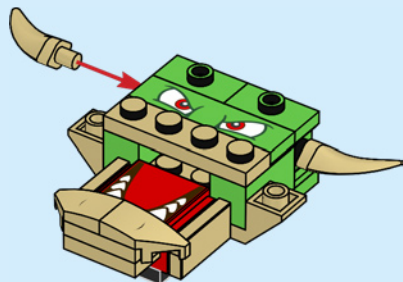

2x

37

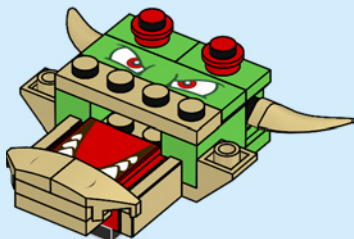

1x



1x

38

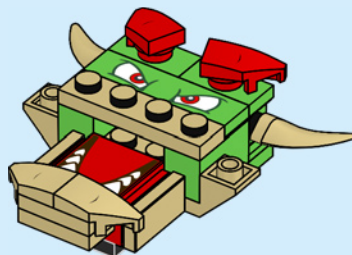

2x

39

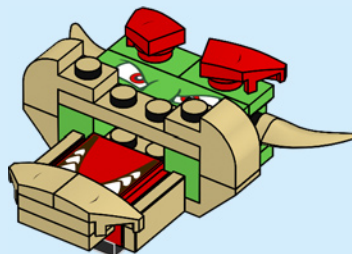



2x



1x

# 40

1

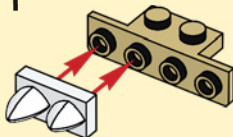

2

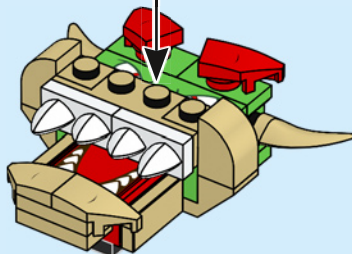
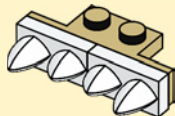

2x

# 41

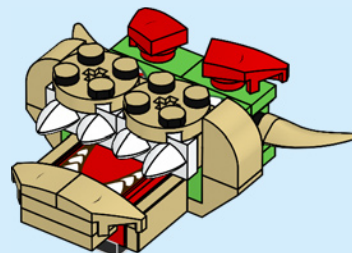

1x

# 42

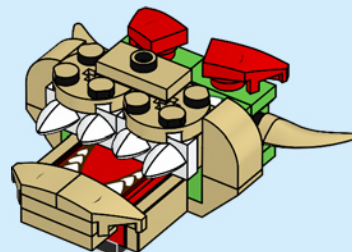



2x



2x

43

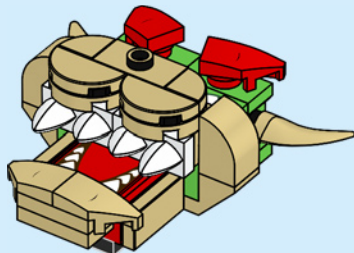

1x

44

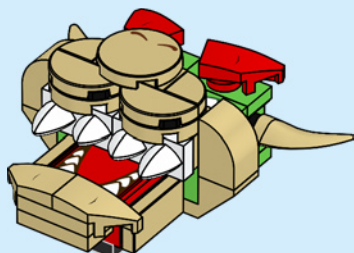

45

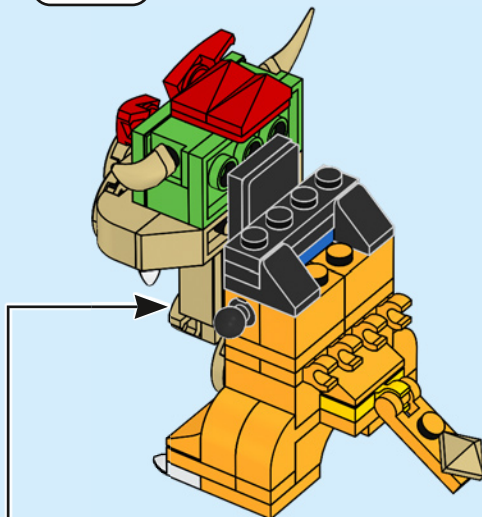

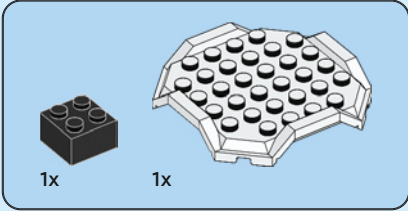

46

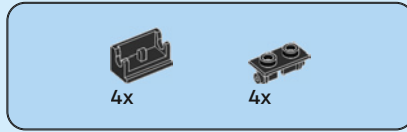
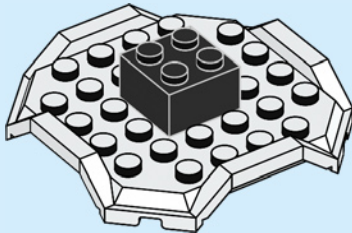

47

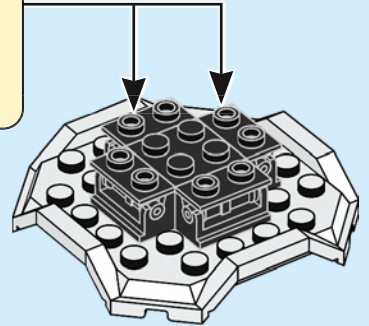
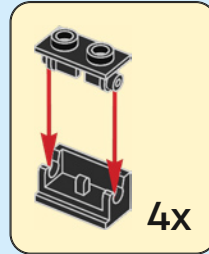

48

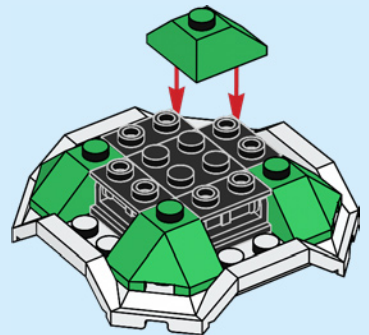

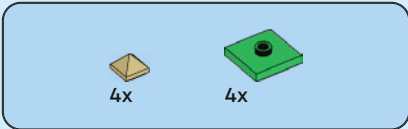

49

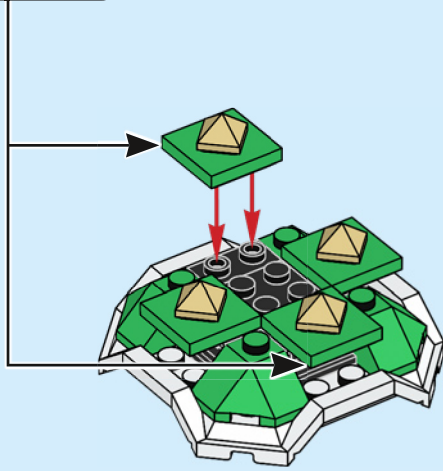
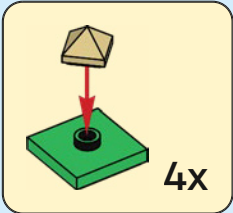

50

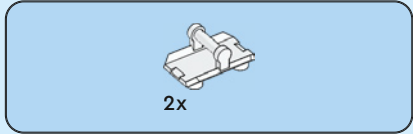
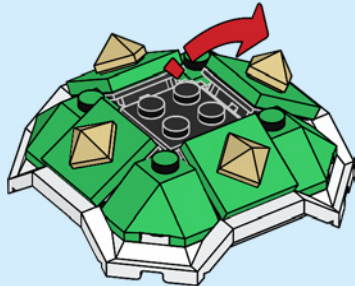

51

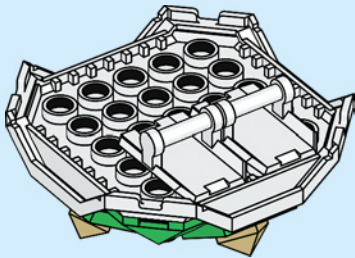

52

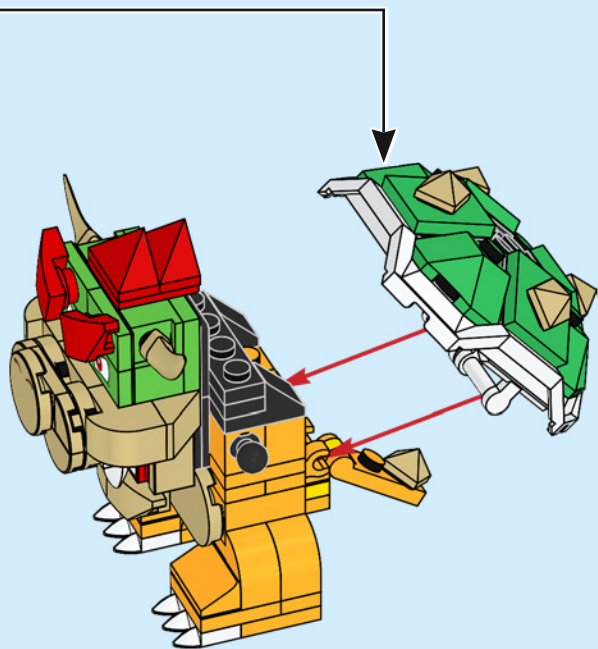

53

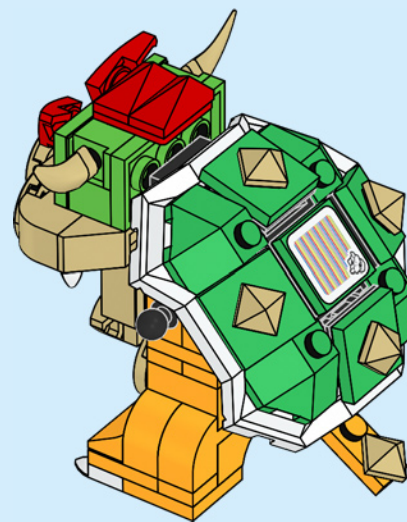
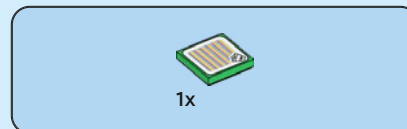



1x



1x

54

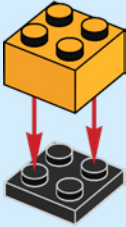

1x

55



1x

56

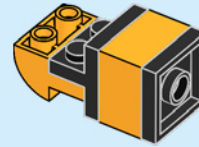

1x

57

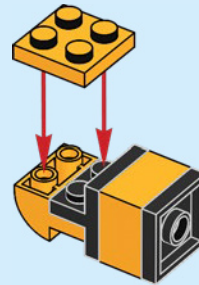





58

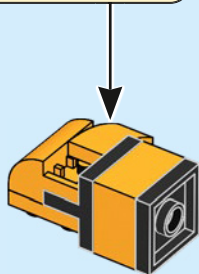
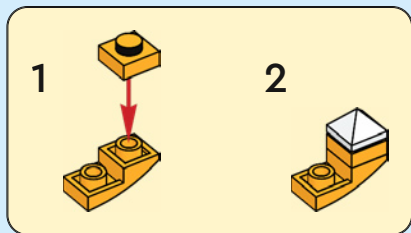

59

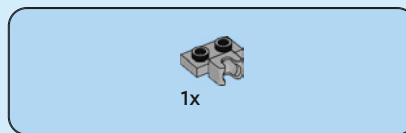
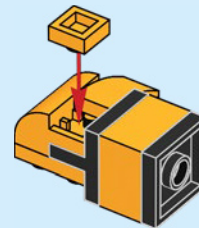

60

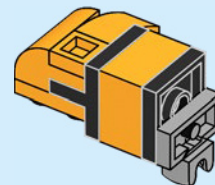



61

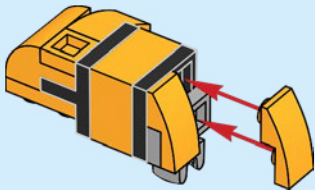

62



63

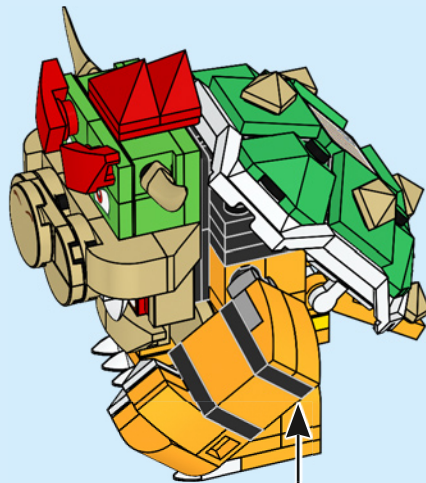

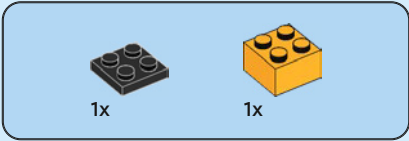

64

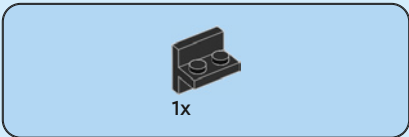
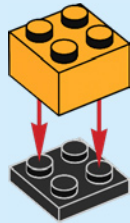

65

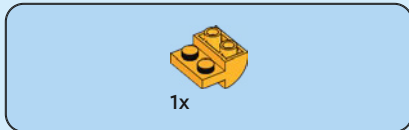
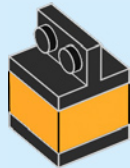

66

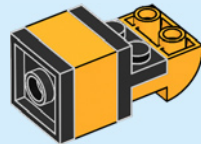

67

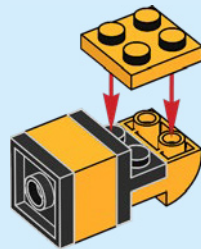

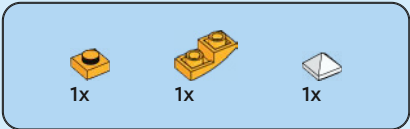

68

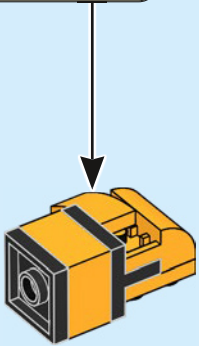
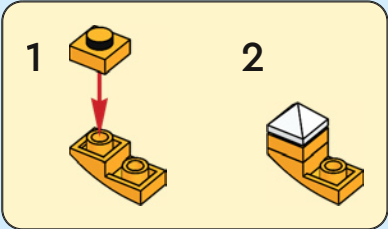

69

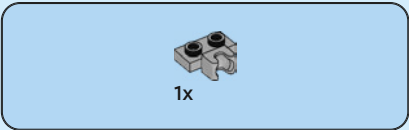
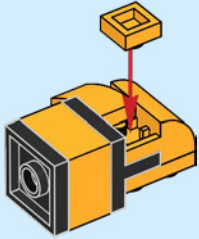

70

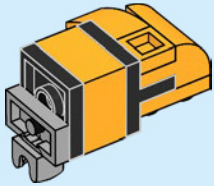



2x

71

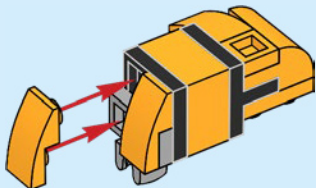

2x

72

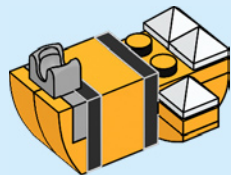

73

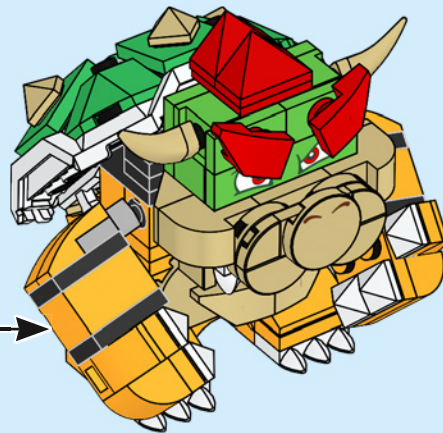

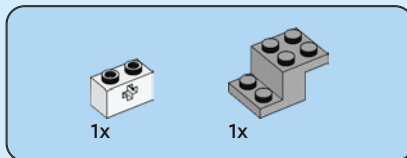
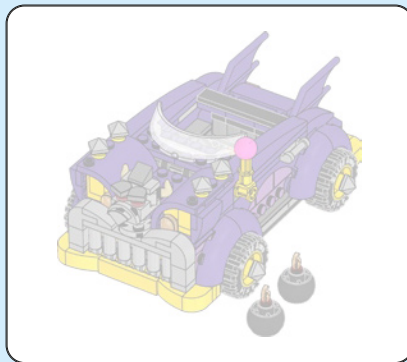

1

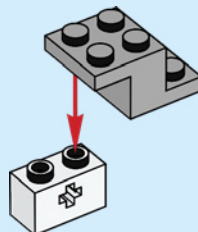

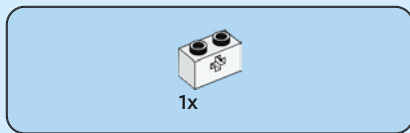

2

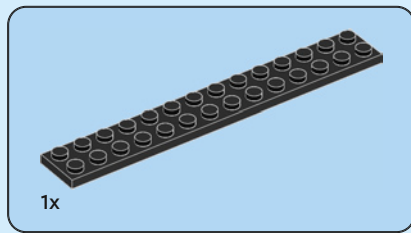
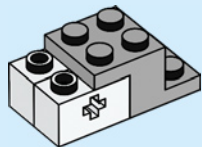

4

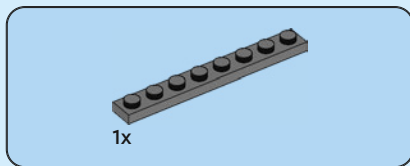
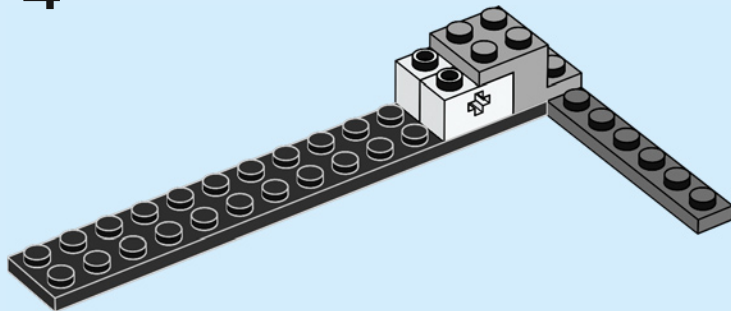

3

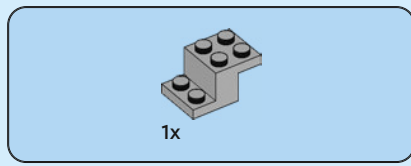
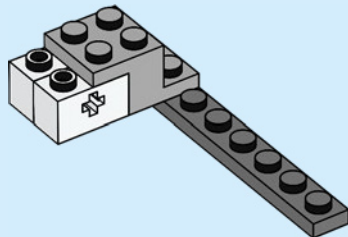

5

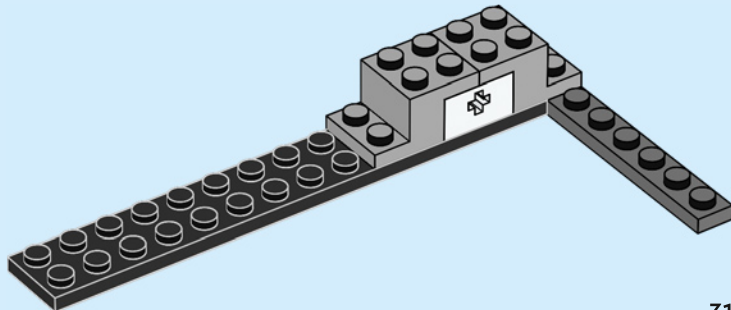

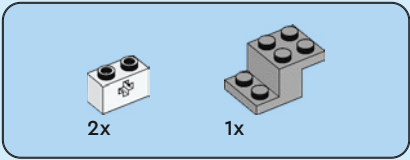

6

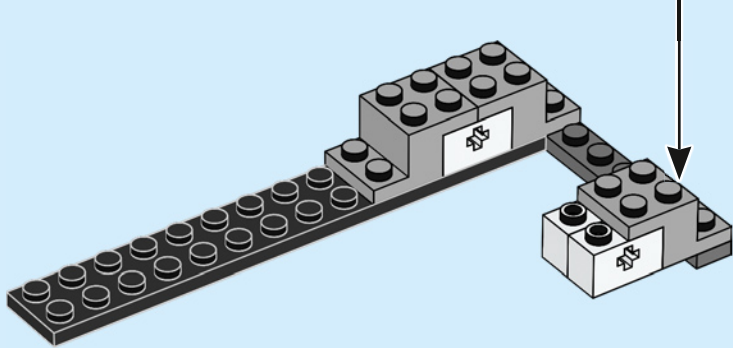
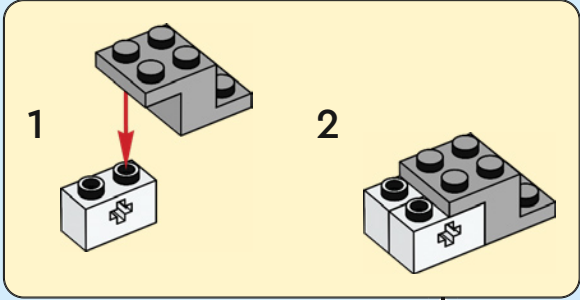



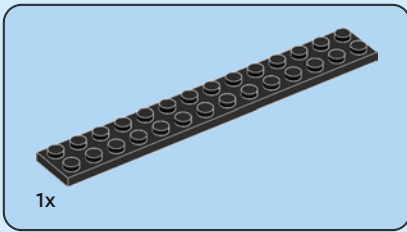

7

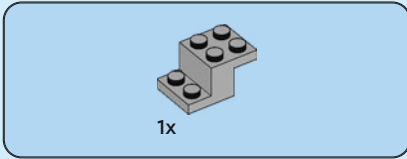
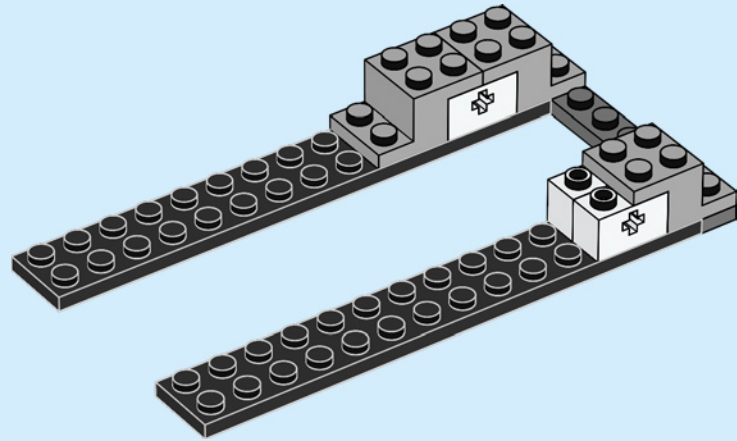

8

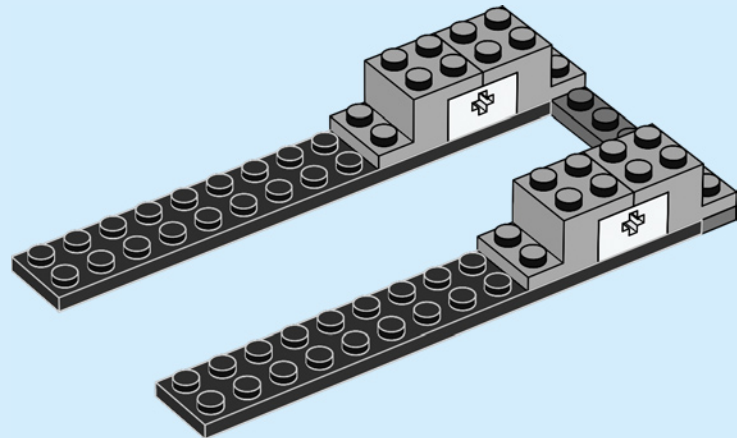

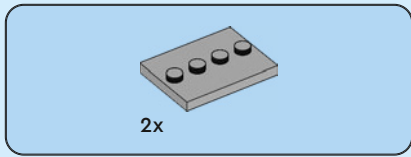

9

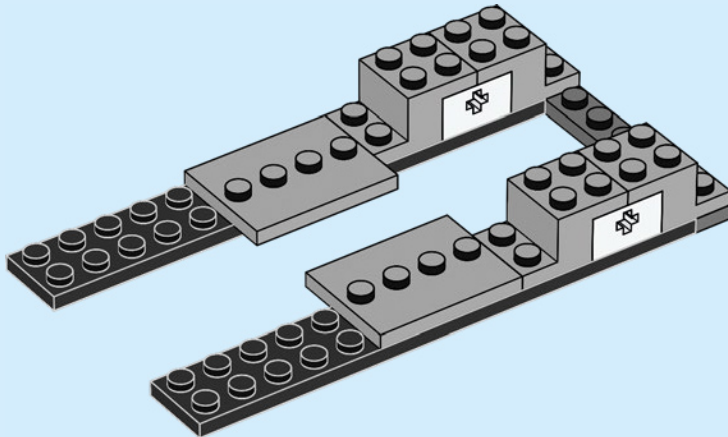

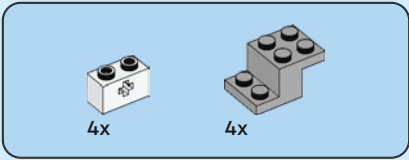

# 10

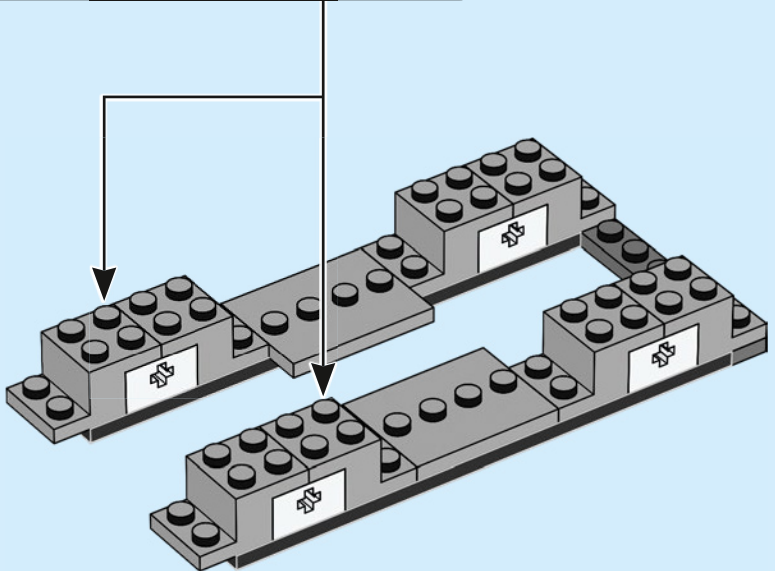
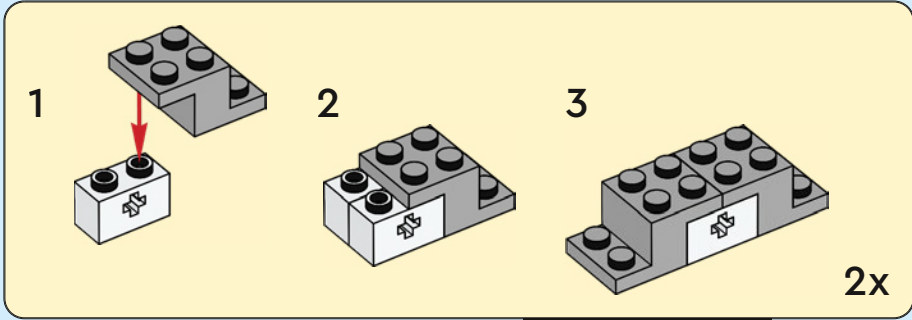

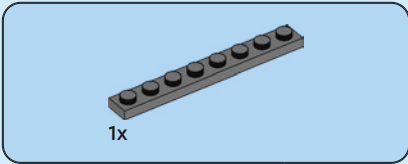

11

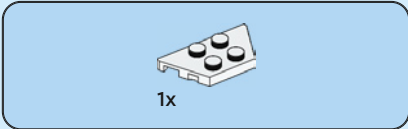
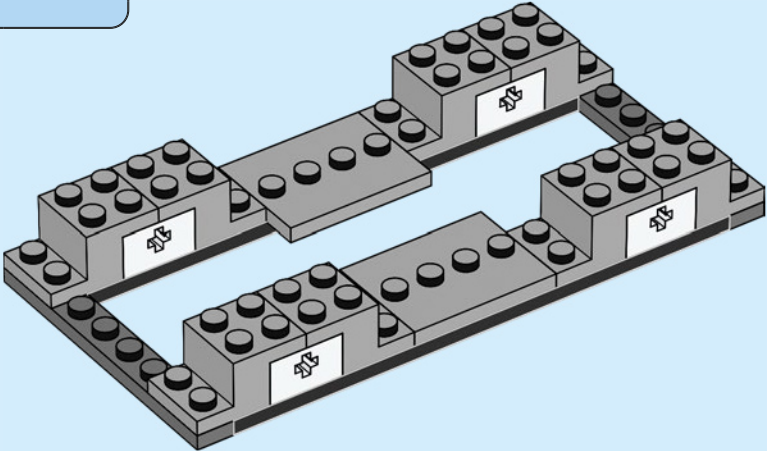

12

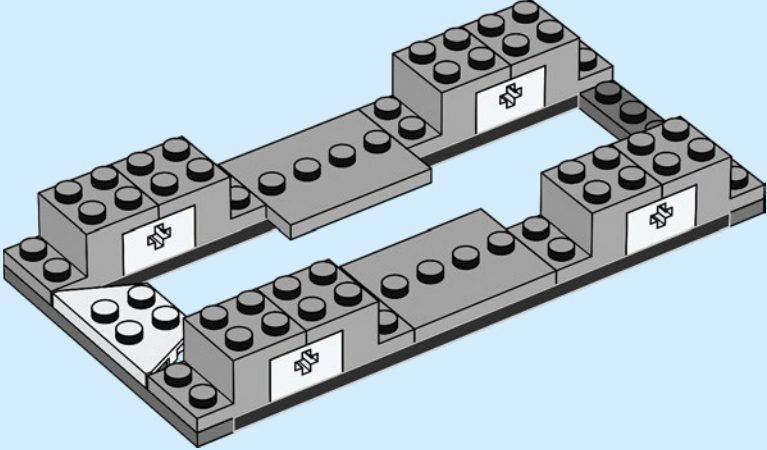

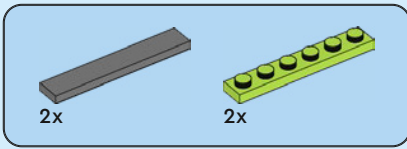

13

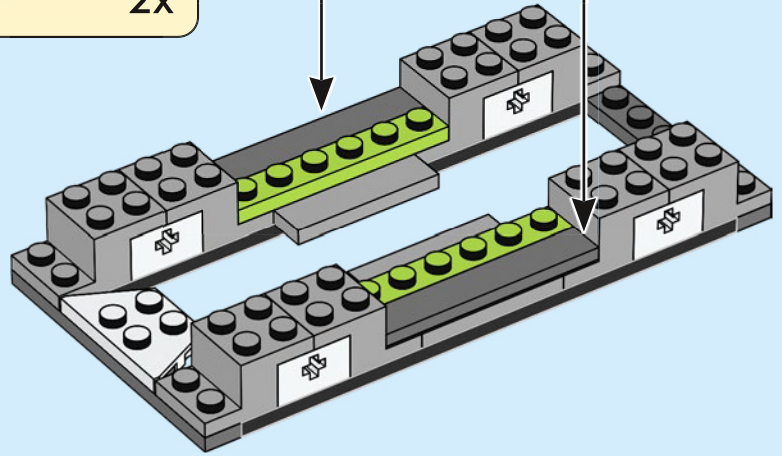
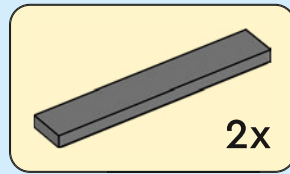

14

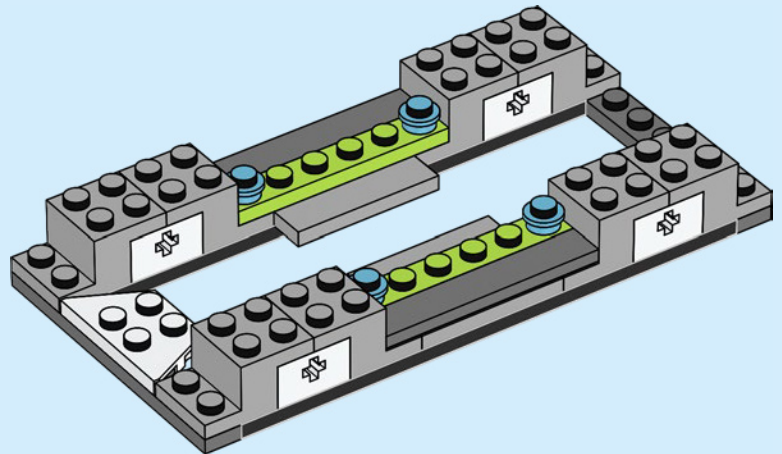

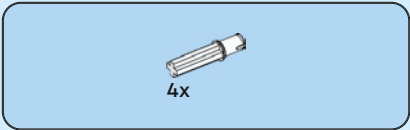

15

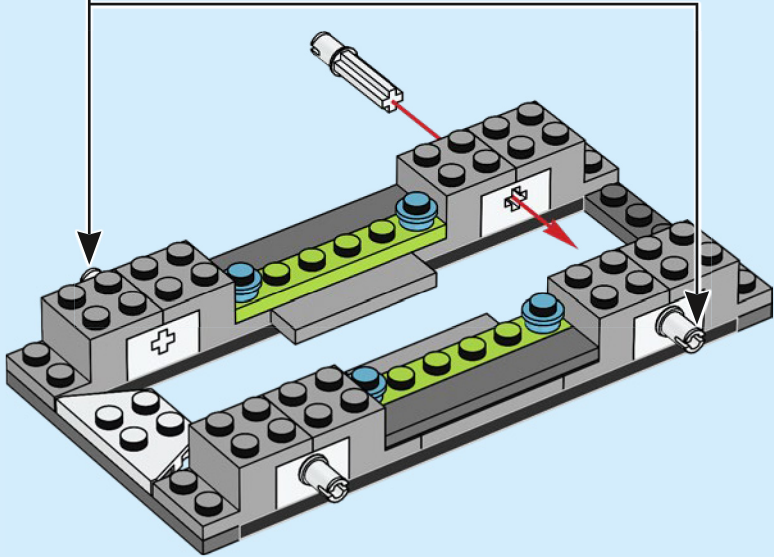
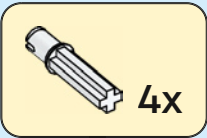



1x

16

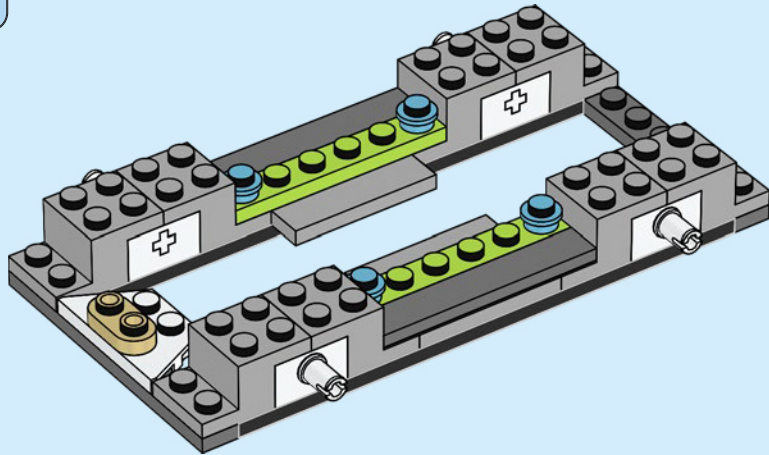

2x

17

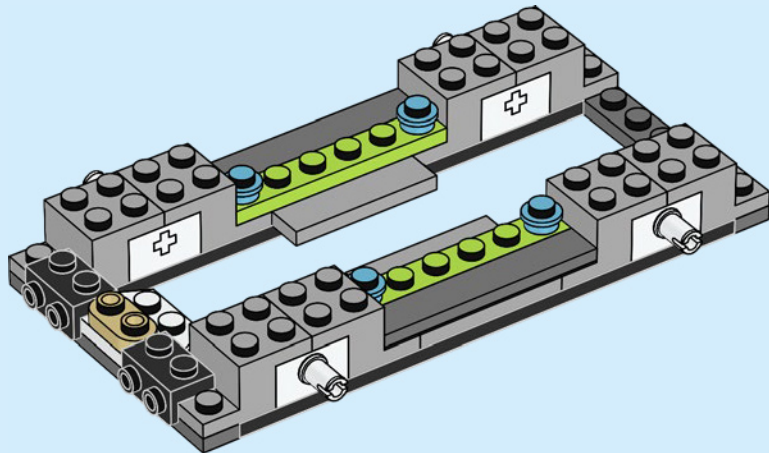



2x

18

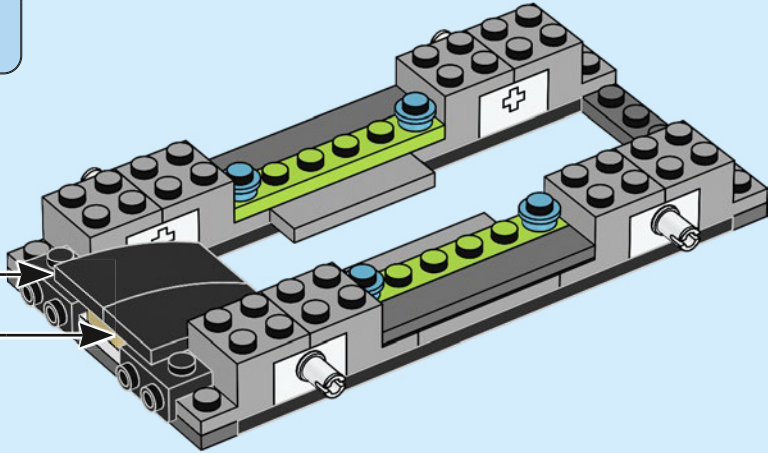

2x

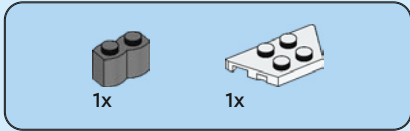

1x

1x

19

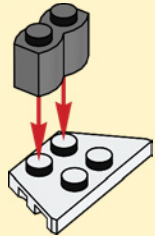
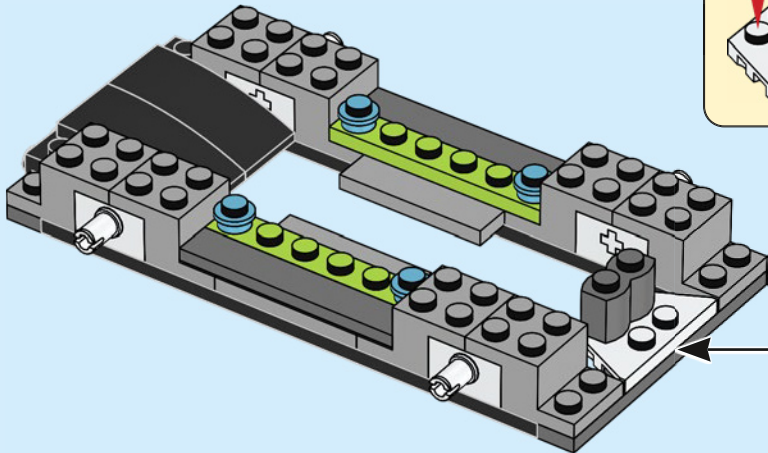





20

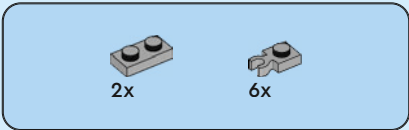
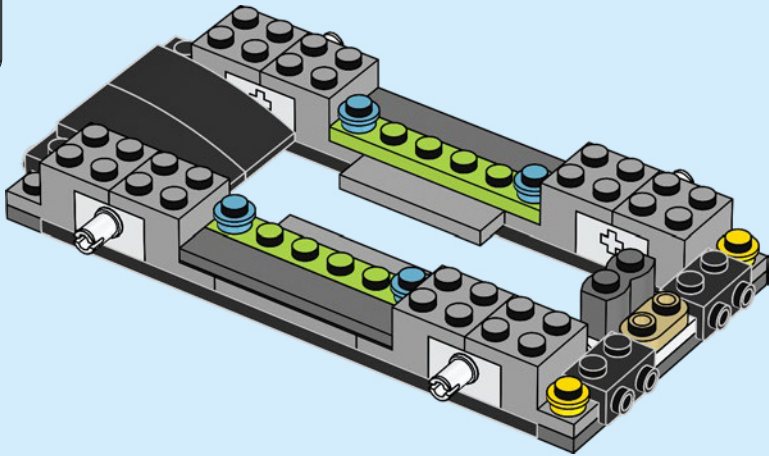

21

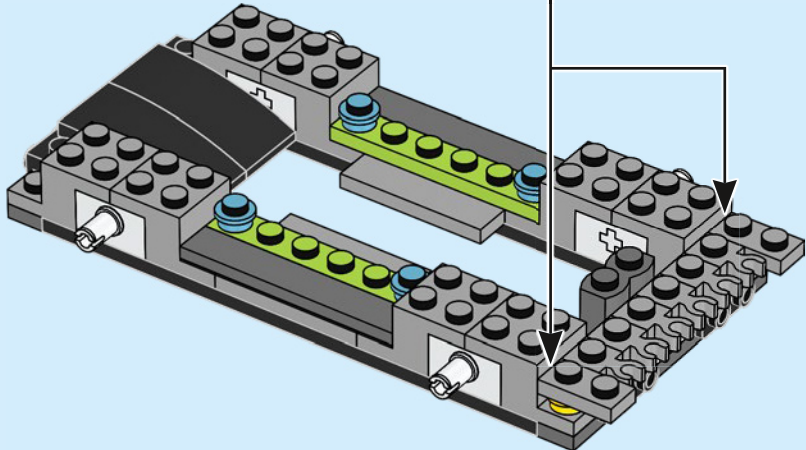
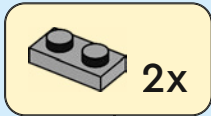

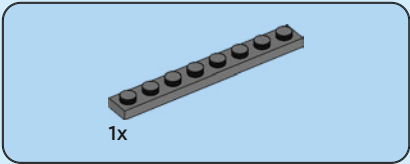

22

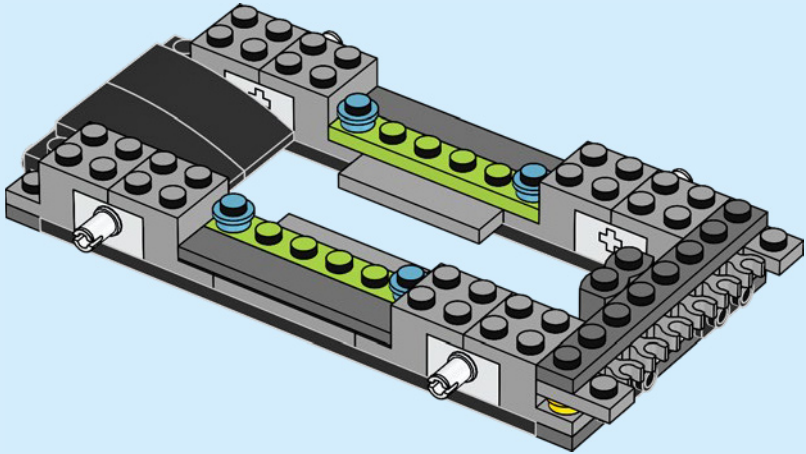

23

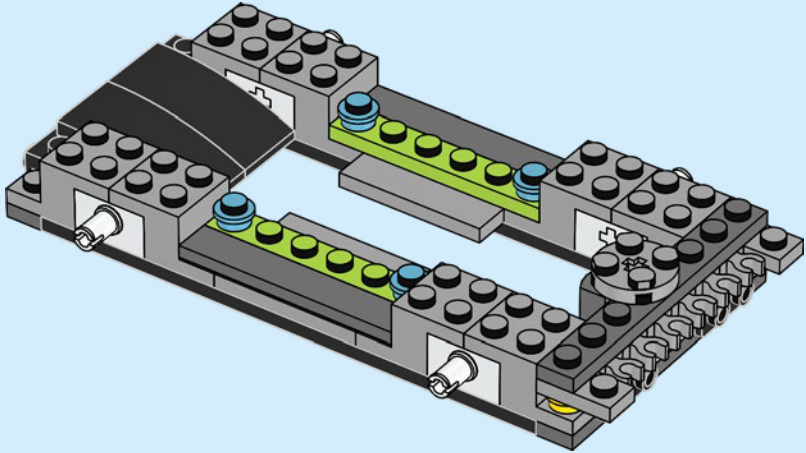

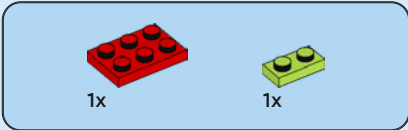
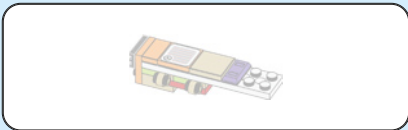

24



25

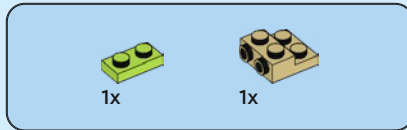
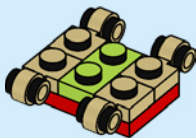

26

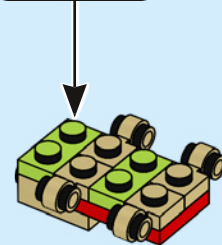
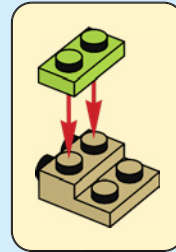

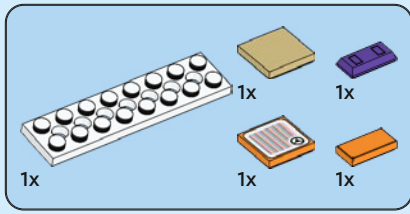

27

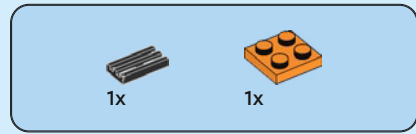
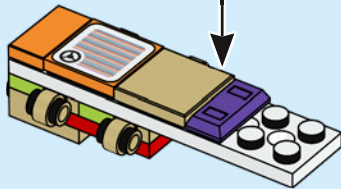
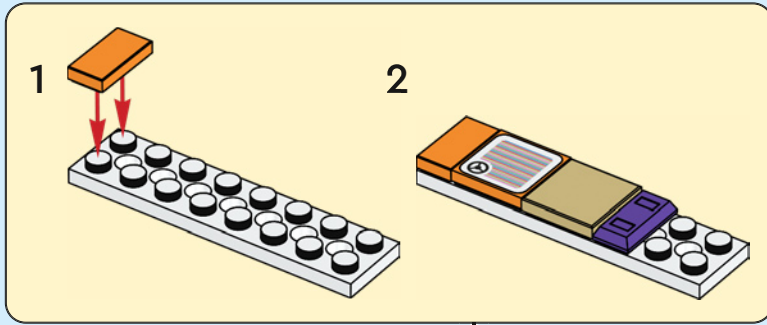

28

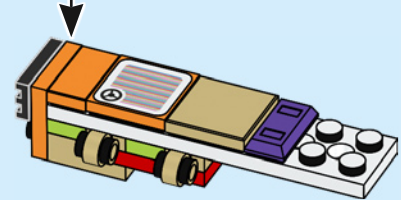
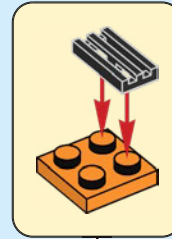

29

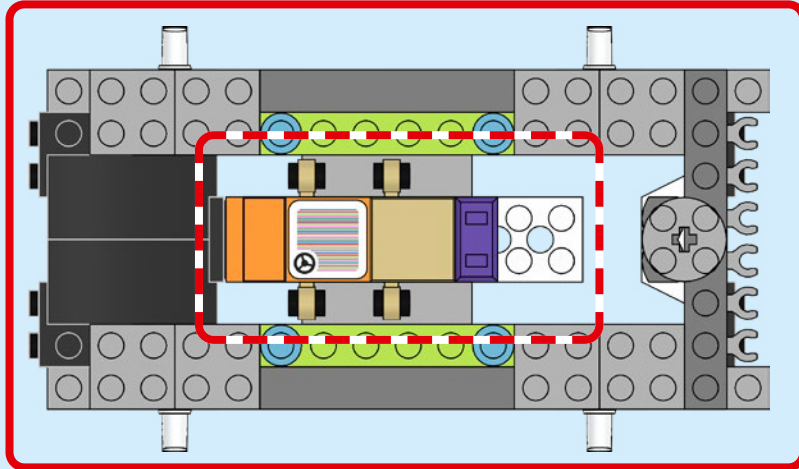
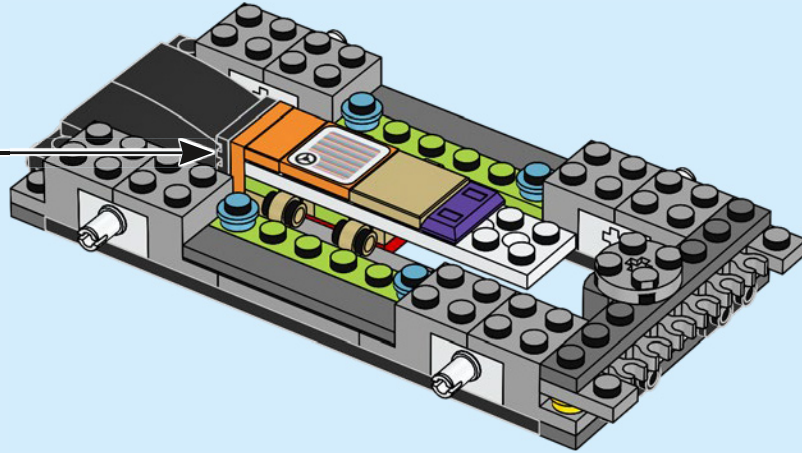



4x

30

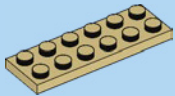
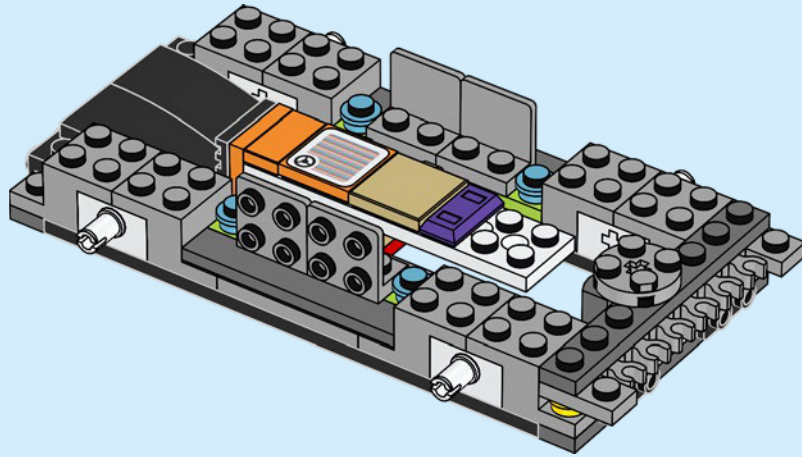

2x

31

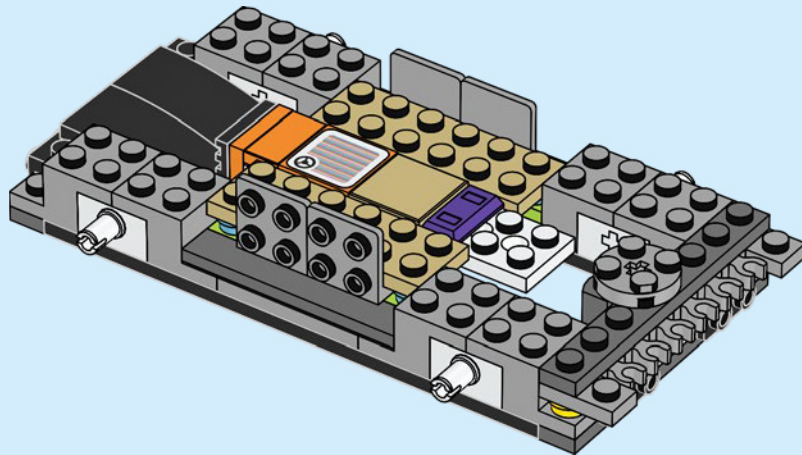

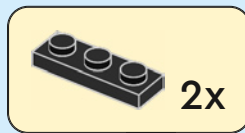
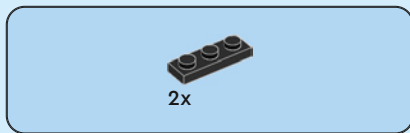

32

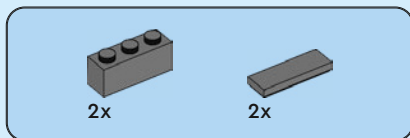
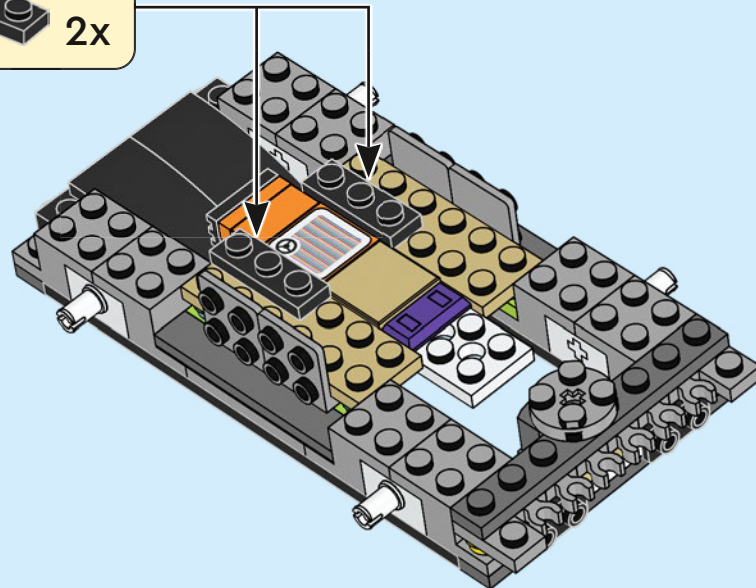

33

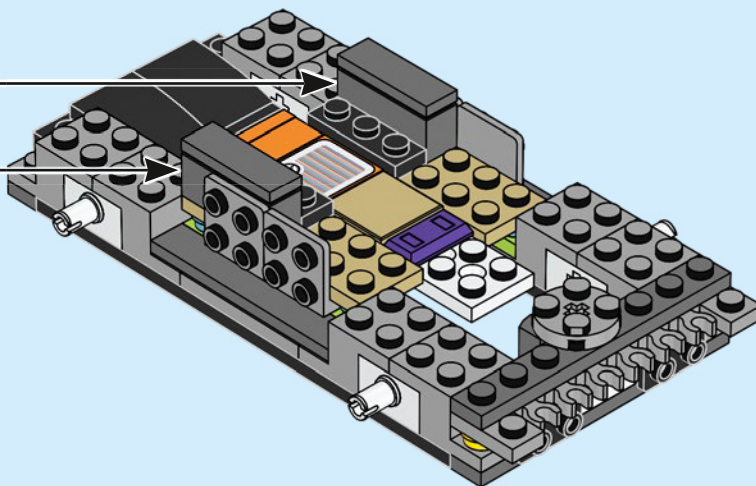
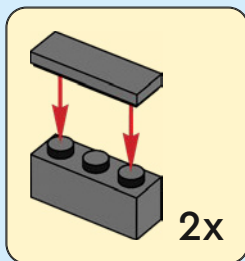



2x



2x

# 34

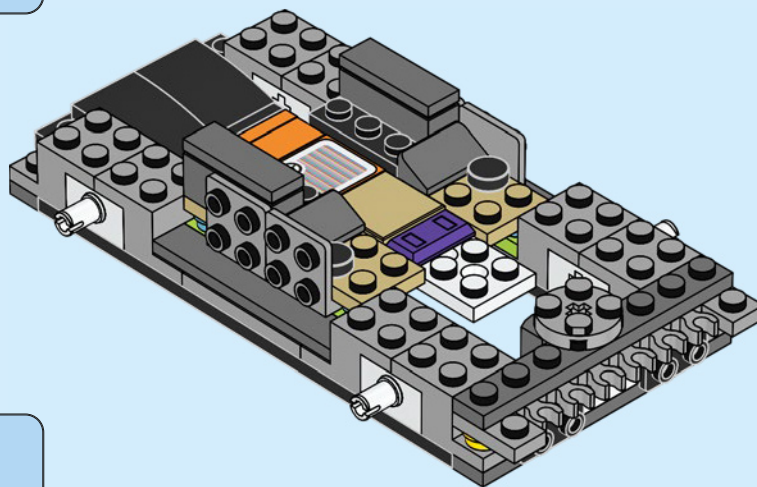

2x

# 35

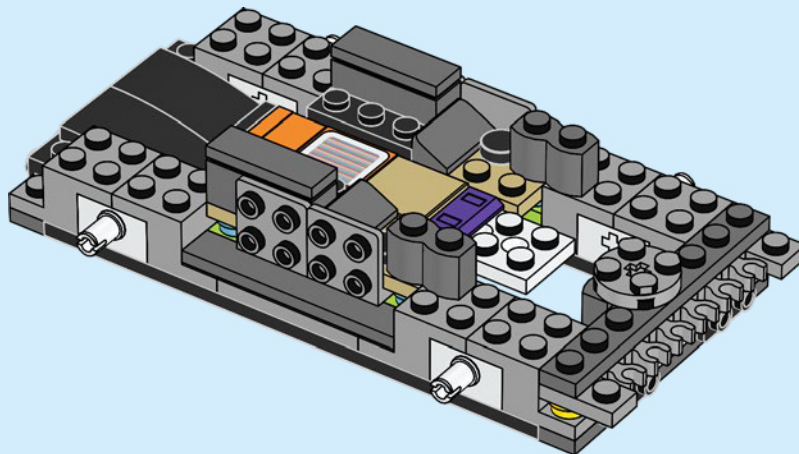





2x

36

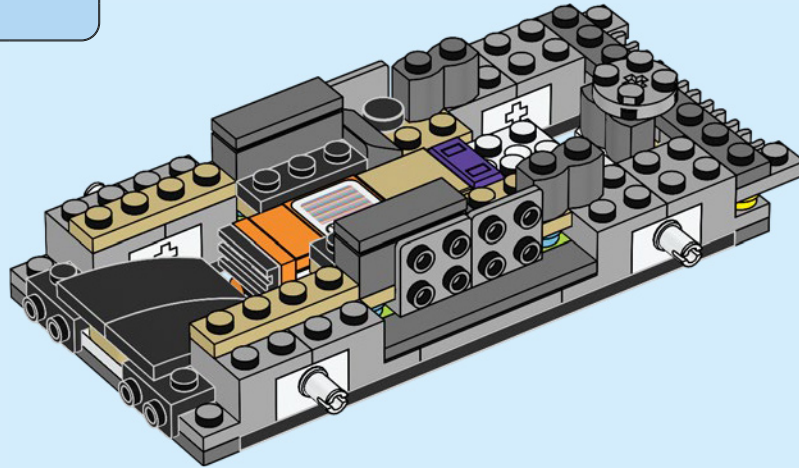

2x

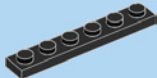

1x

37

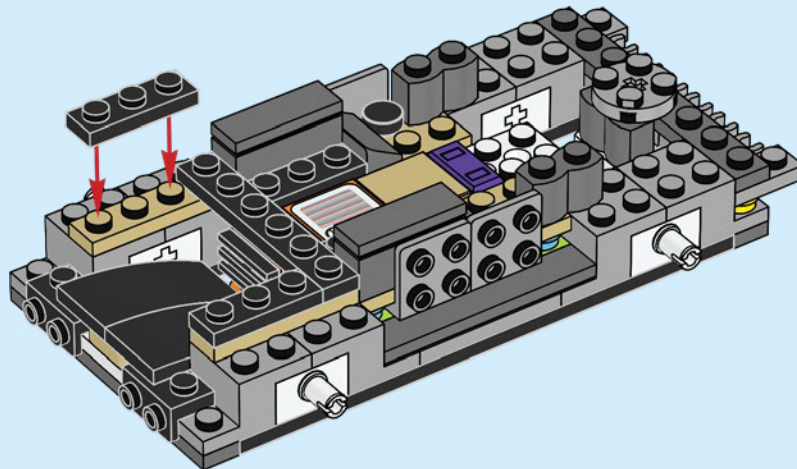

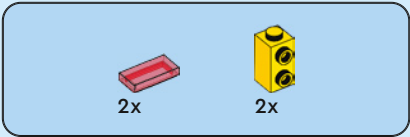

38

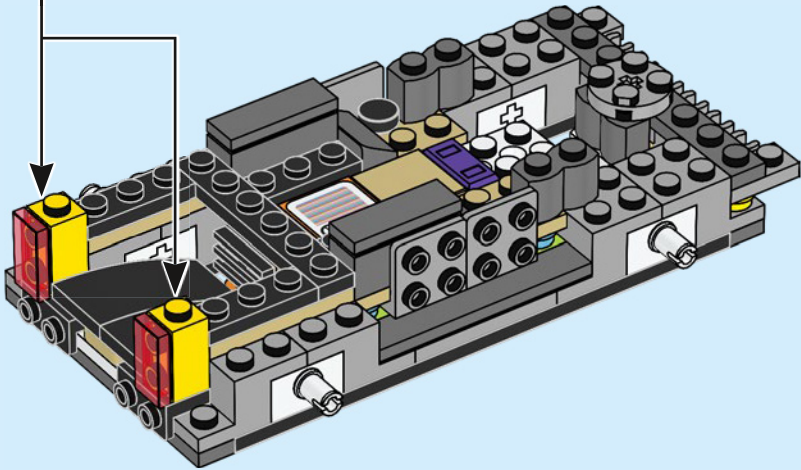
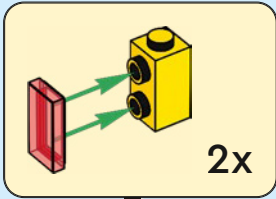



2x



2x

# 39

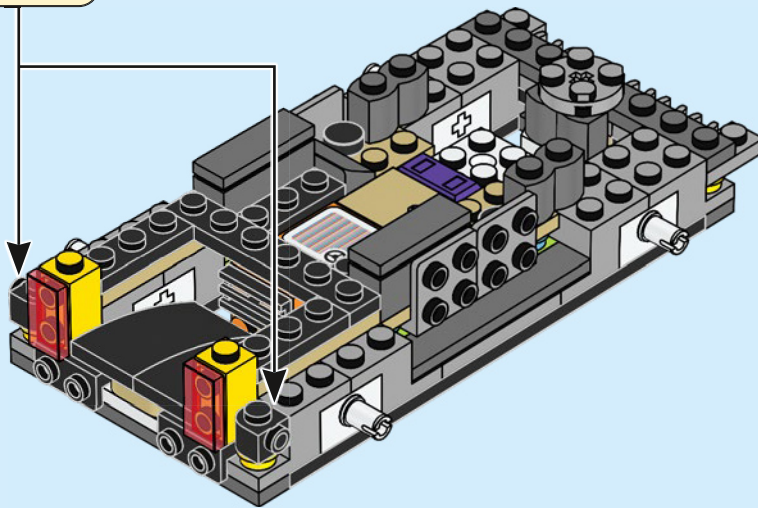
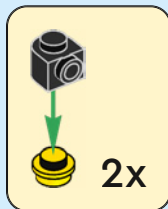

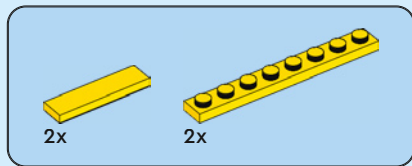

40

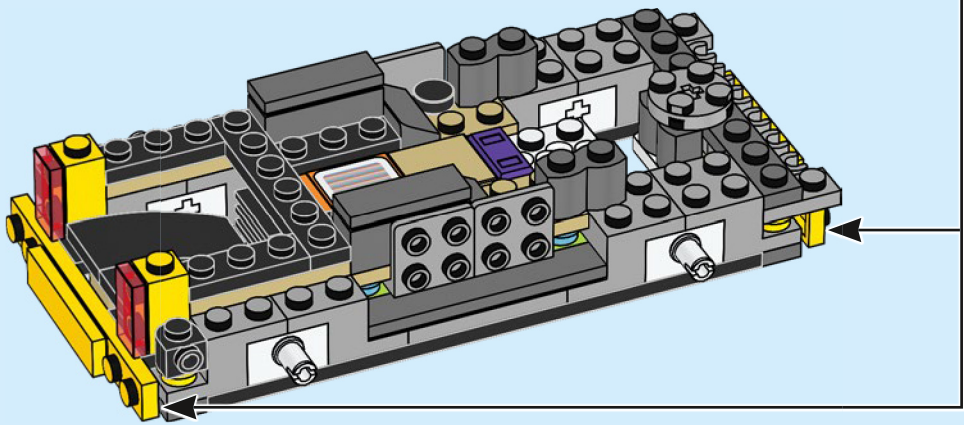
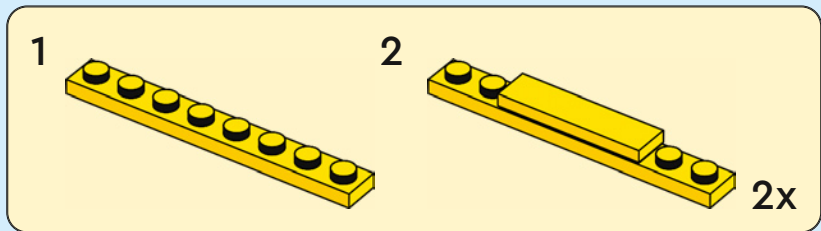

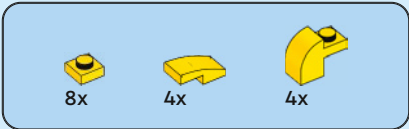

41

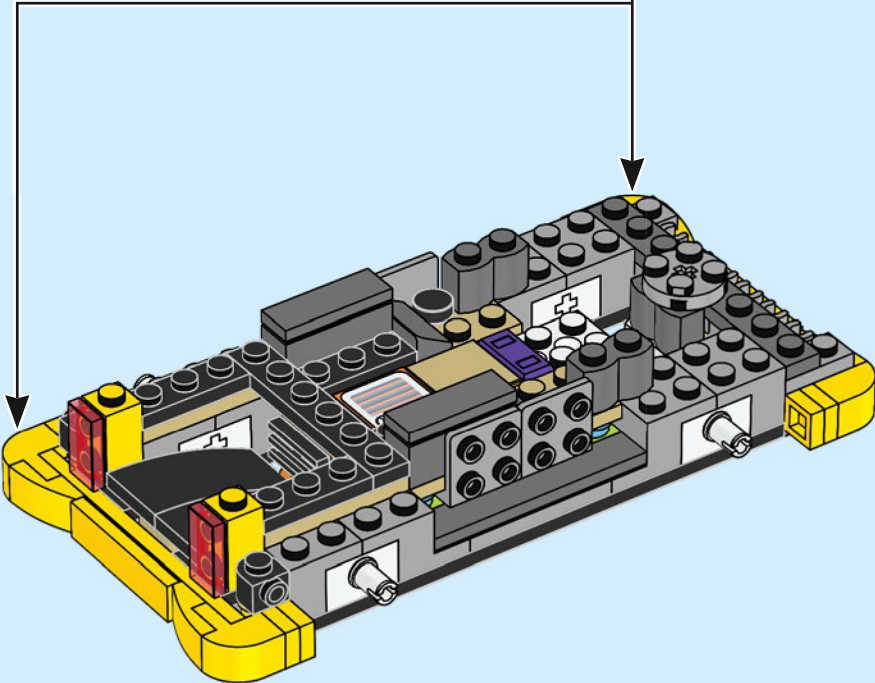
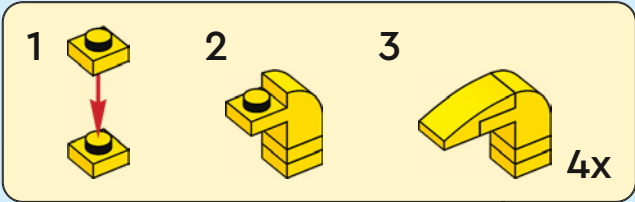

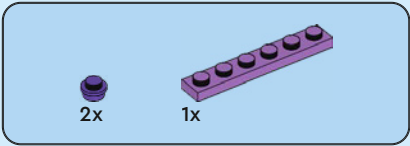

42

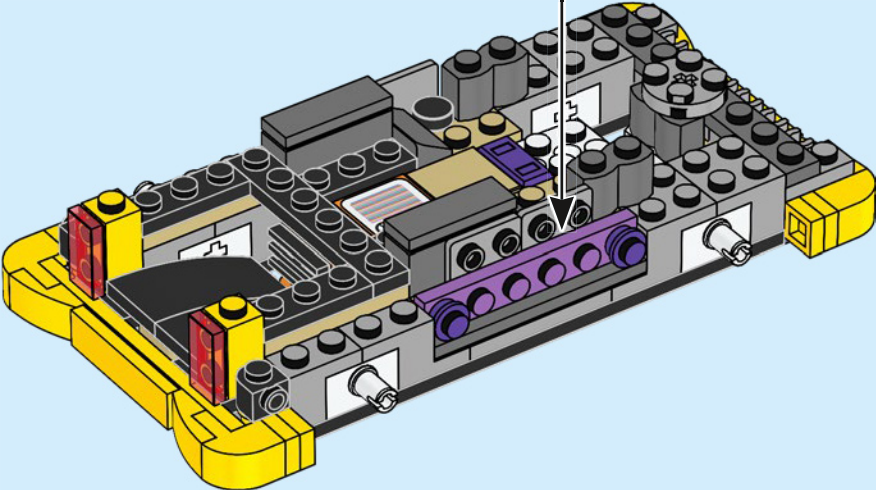
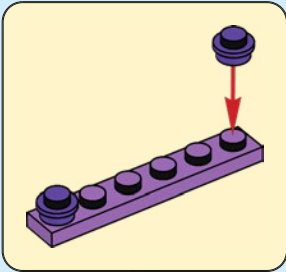



1x

43

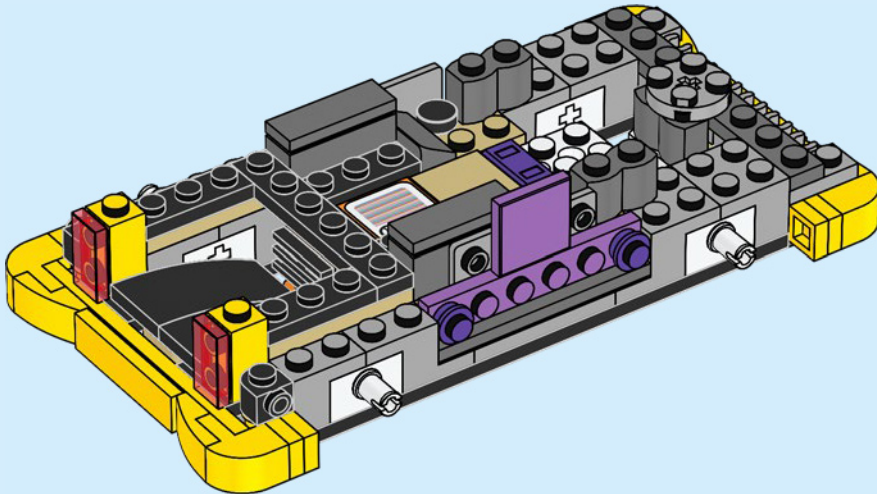



2x

44

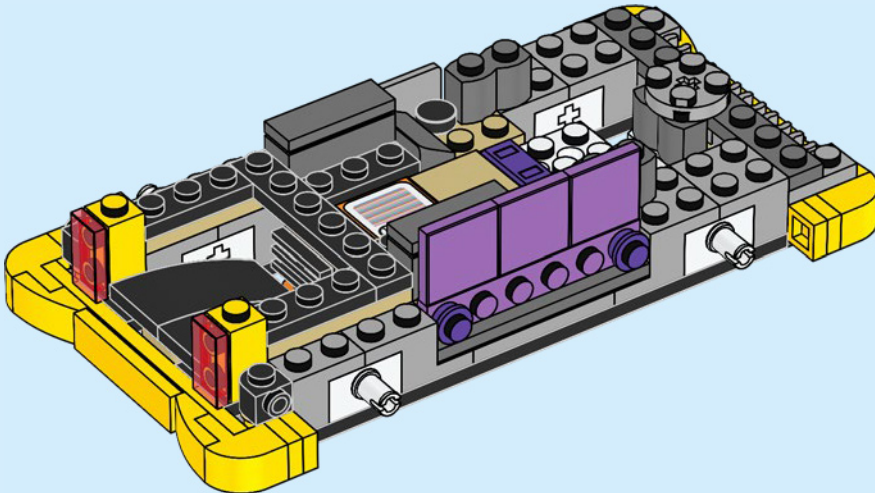



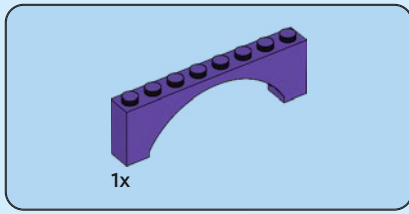

45

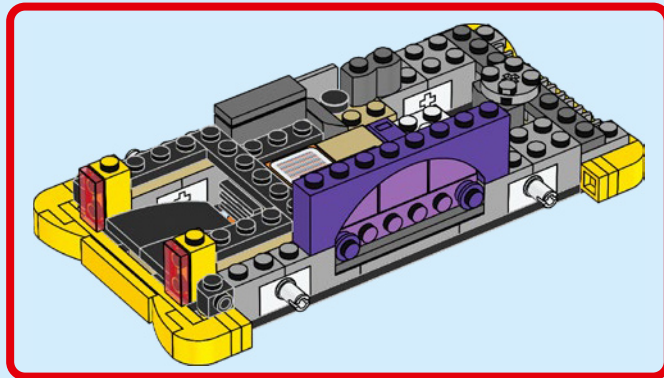
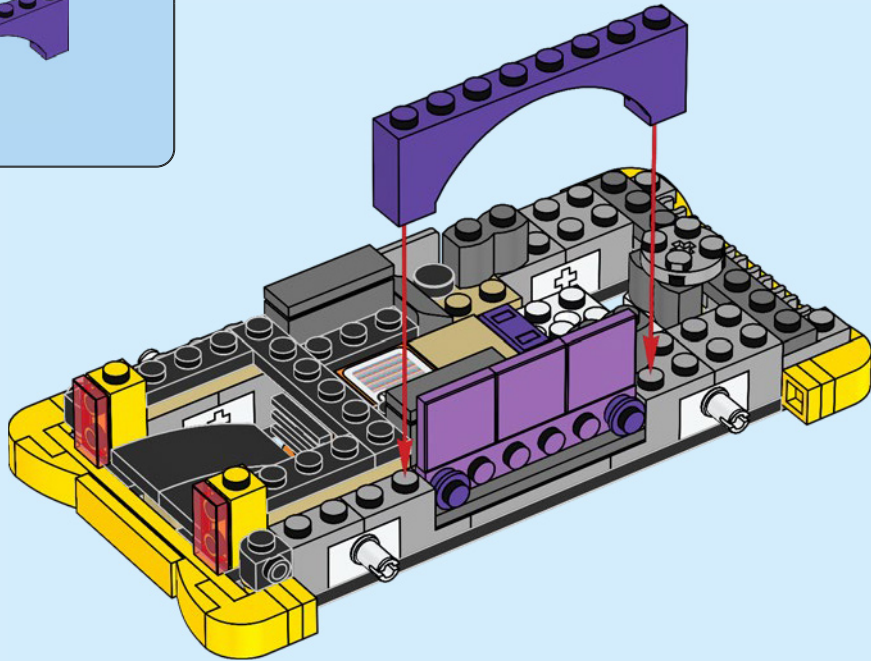

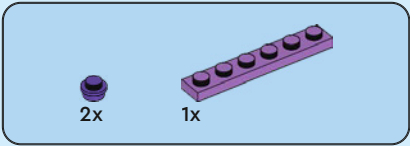

46

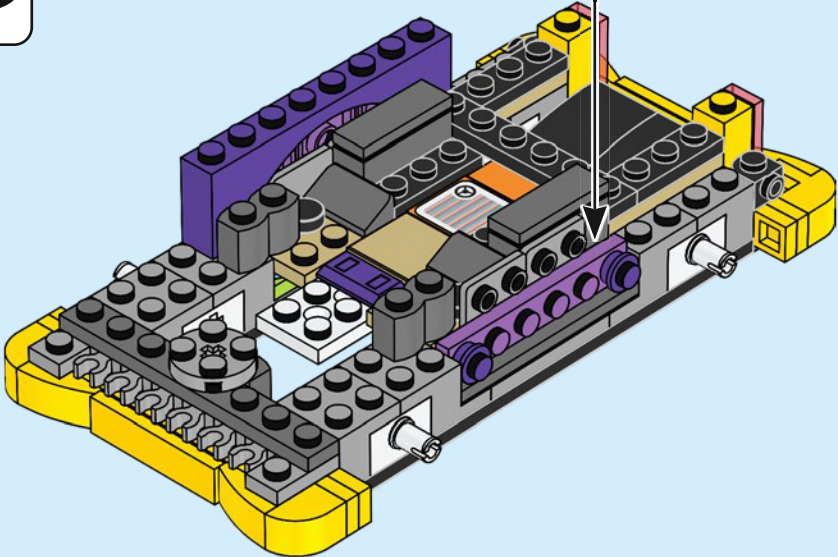
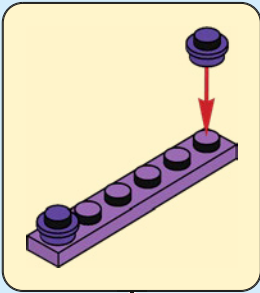

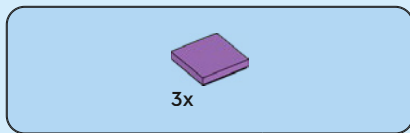

47

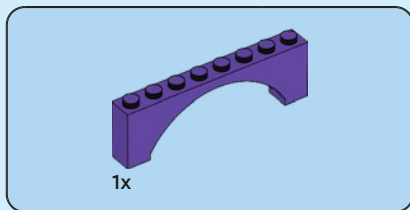
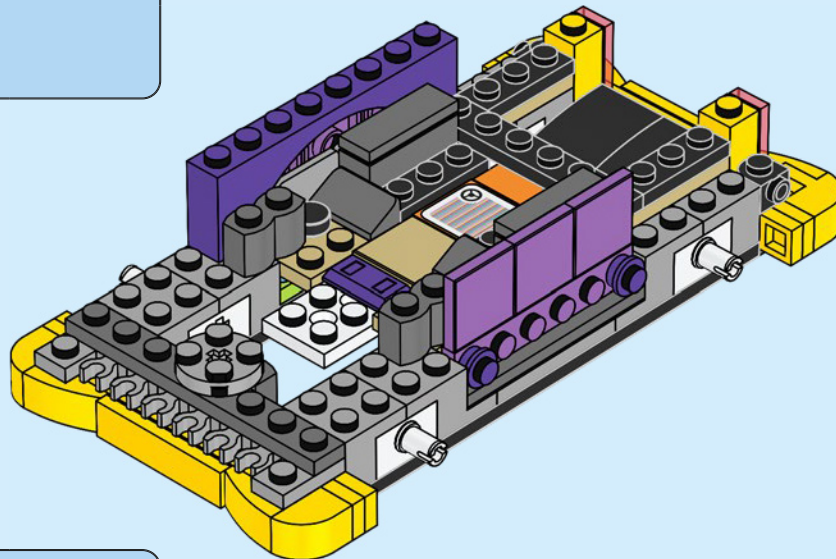

48

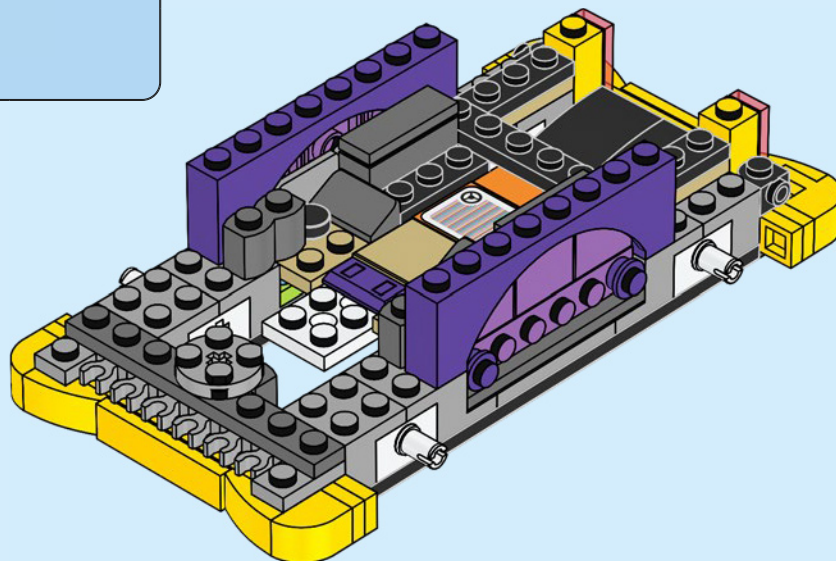

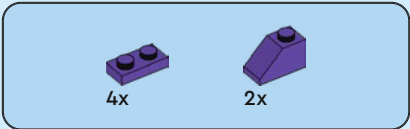

49

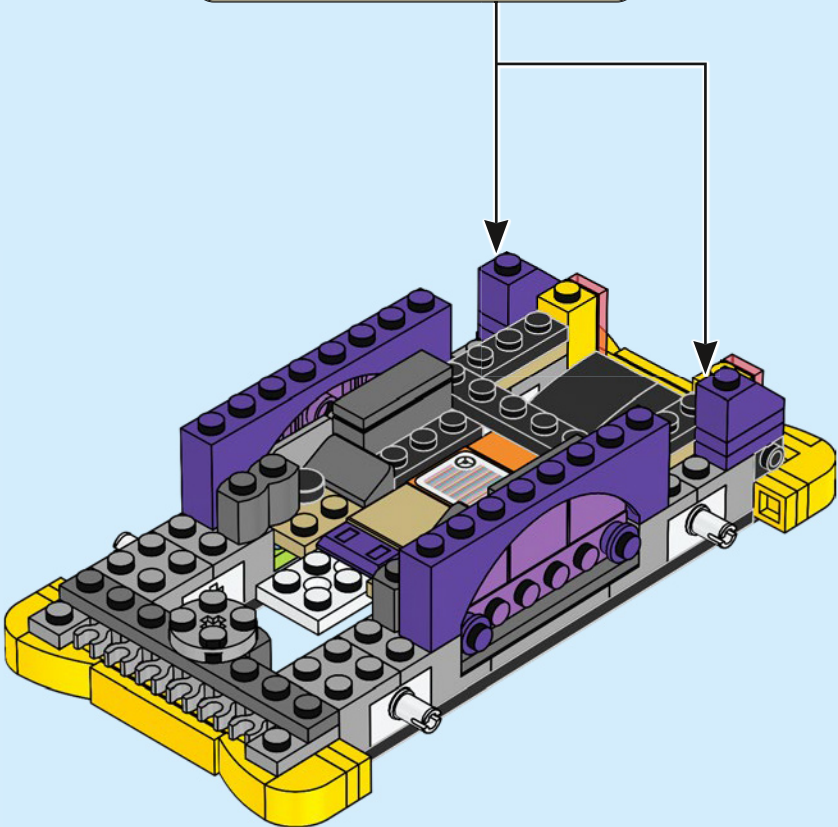
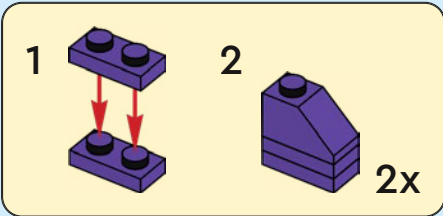



2x



4x

50

1



2

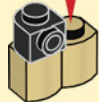

2x

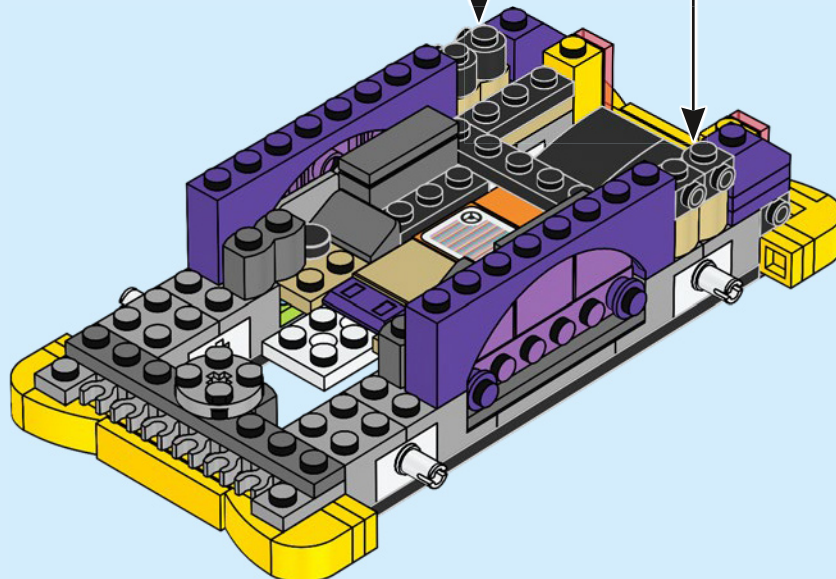



51

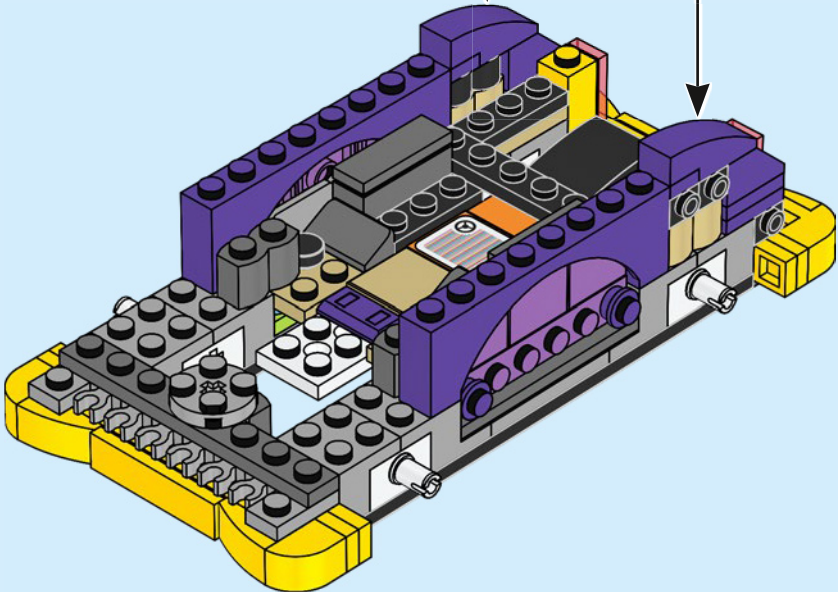
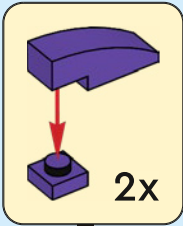

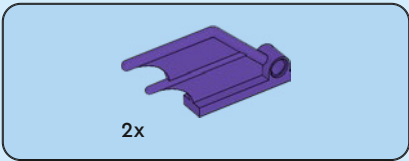

52

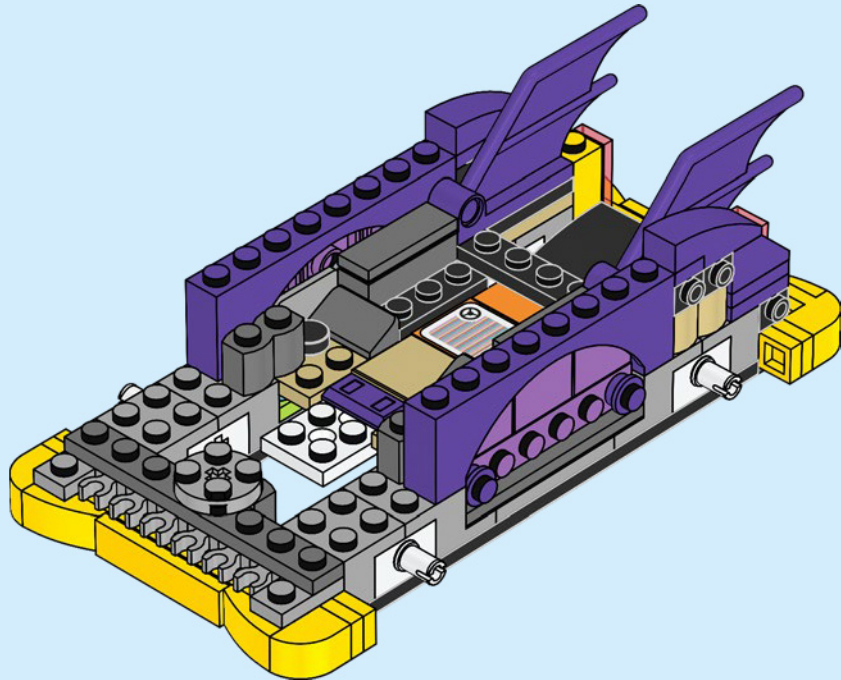



2x

53

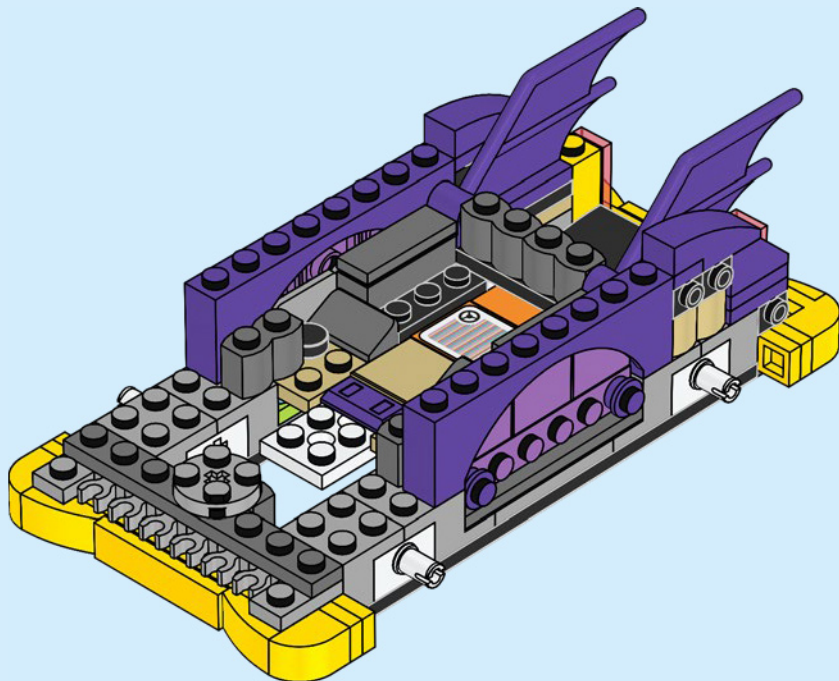





1x



2x

# 54

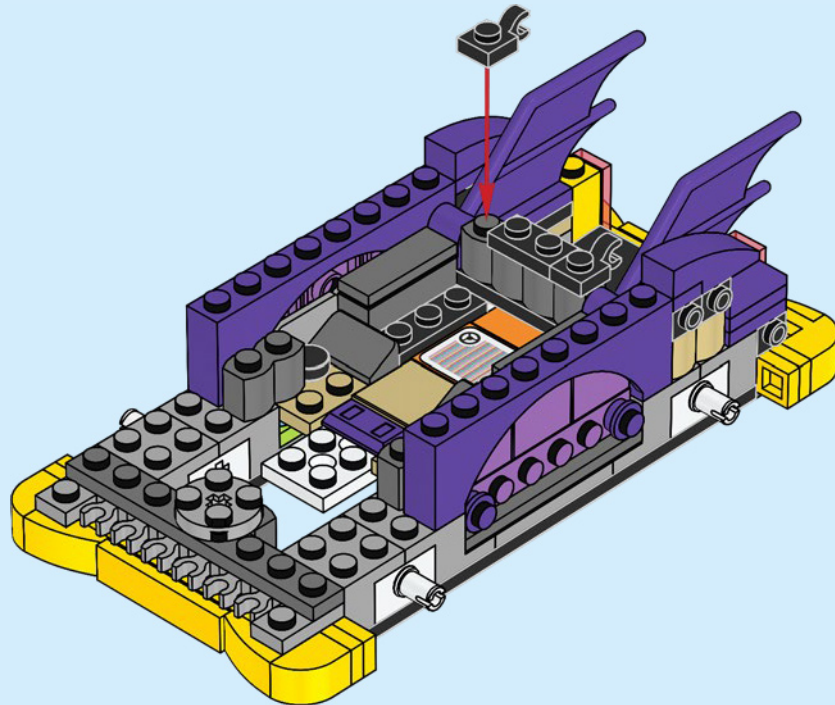

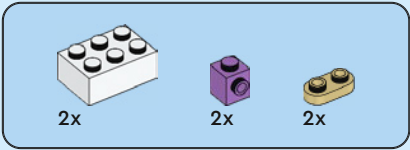

55

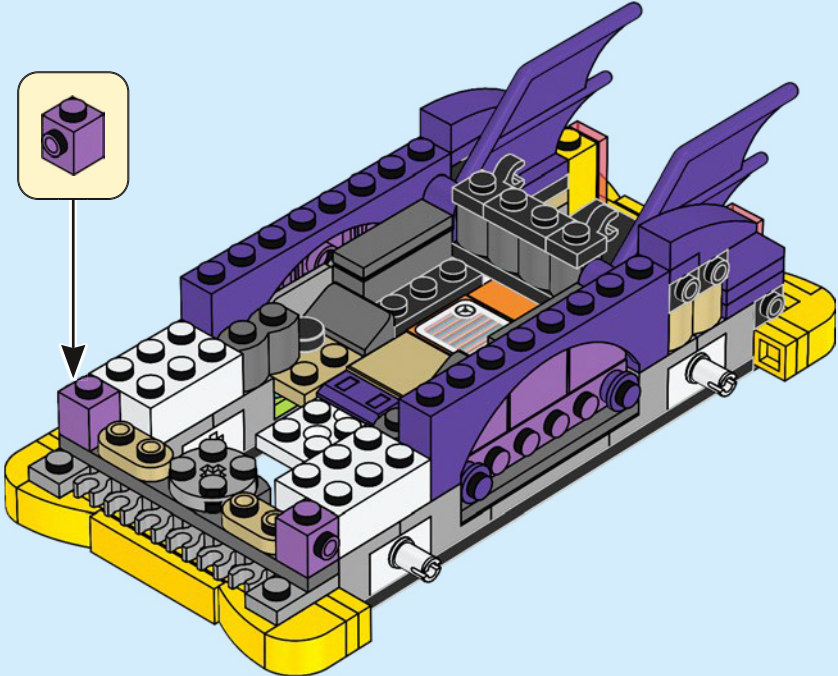



2x



2x

# 56

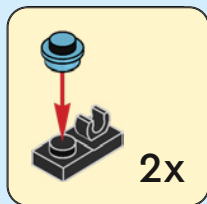

2x

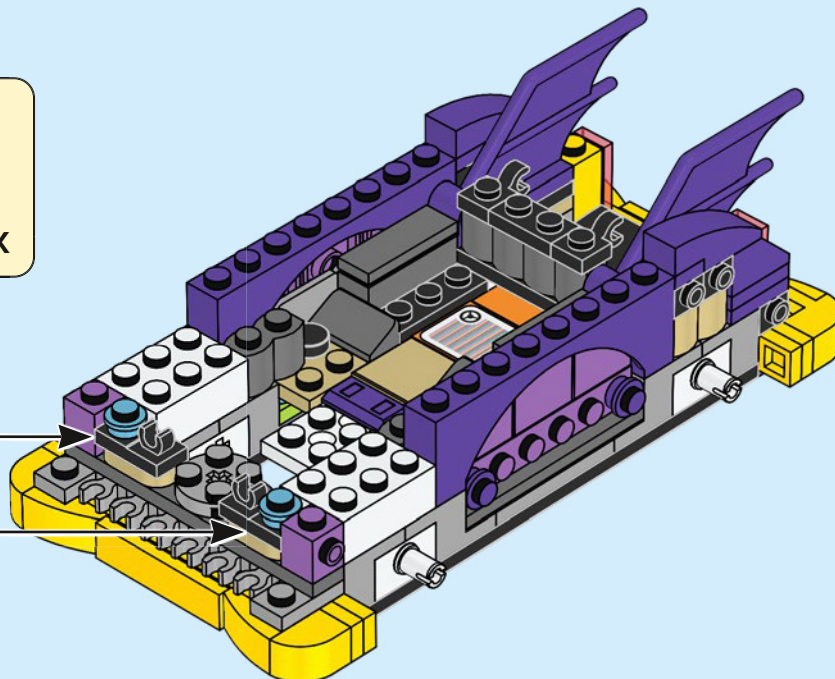



2x



2x

57

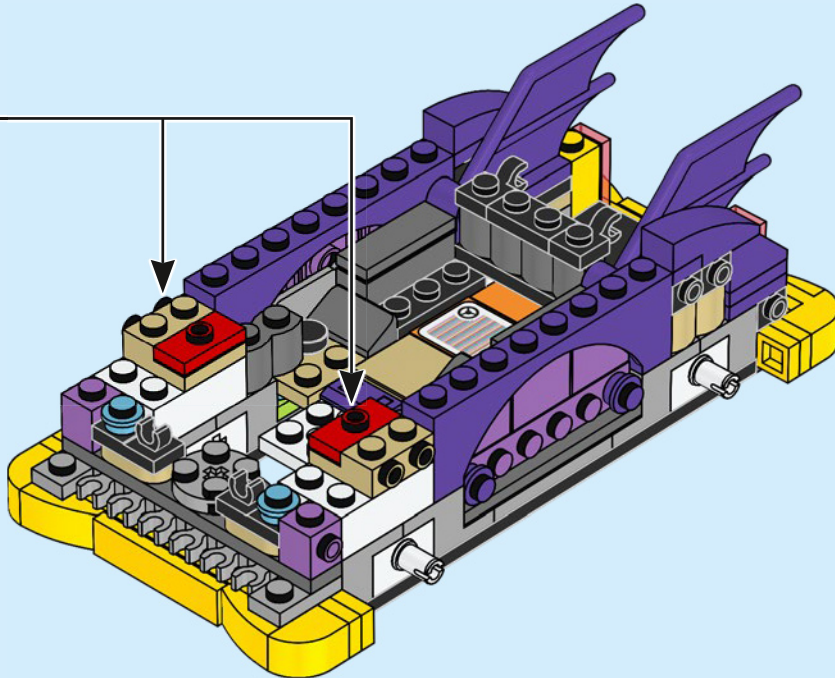
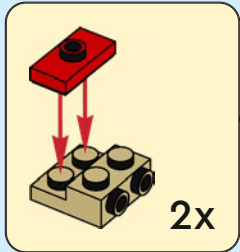



2x



2x

58

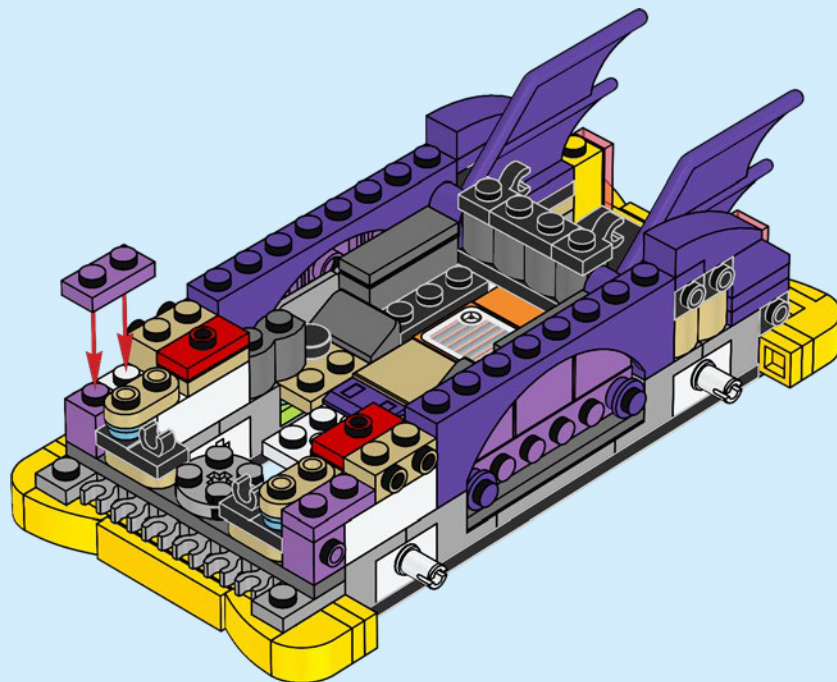



2x

59

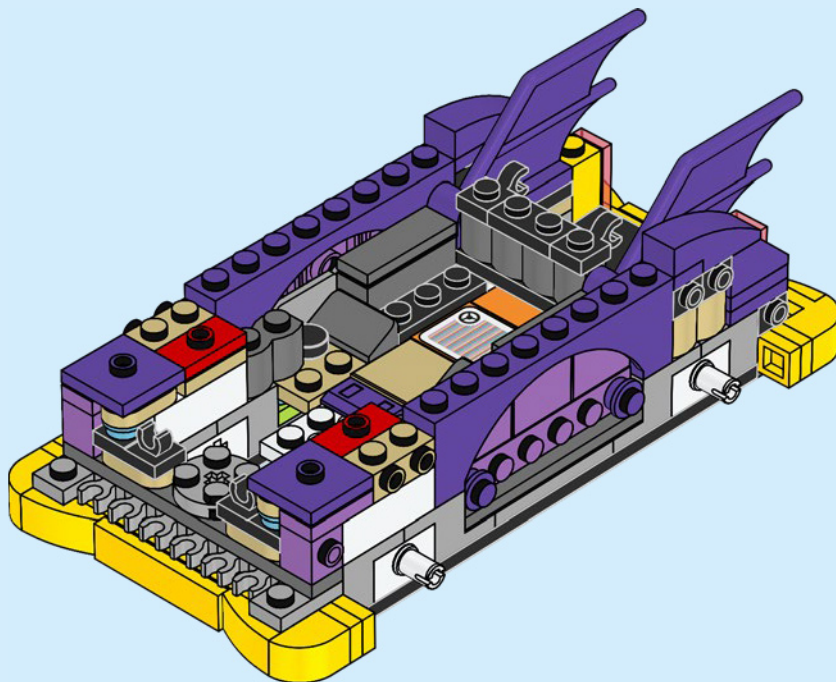



2x

60

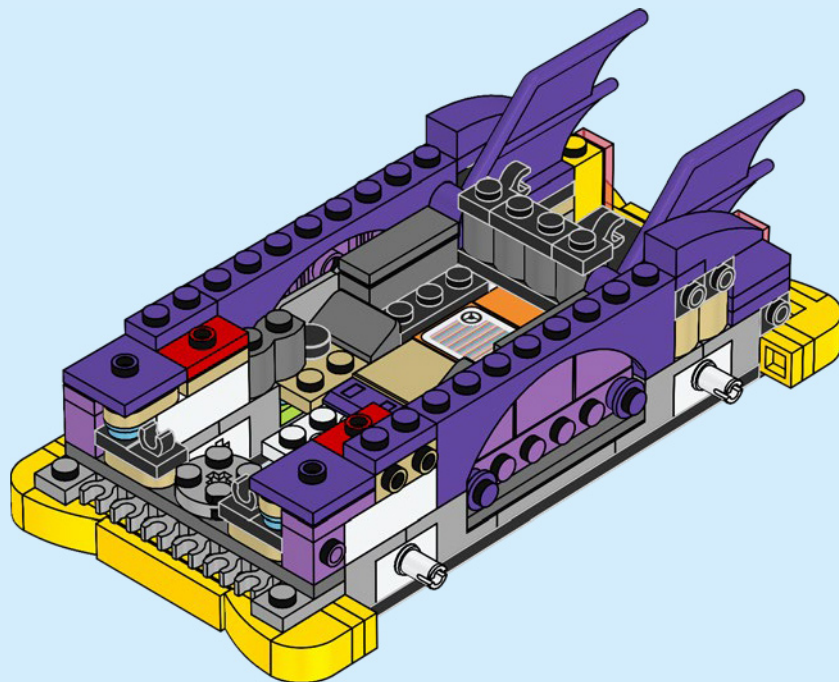



1x



2x

61

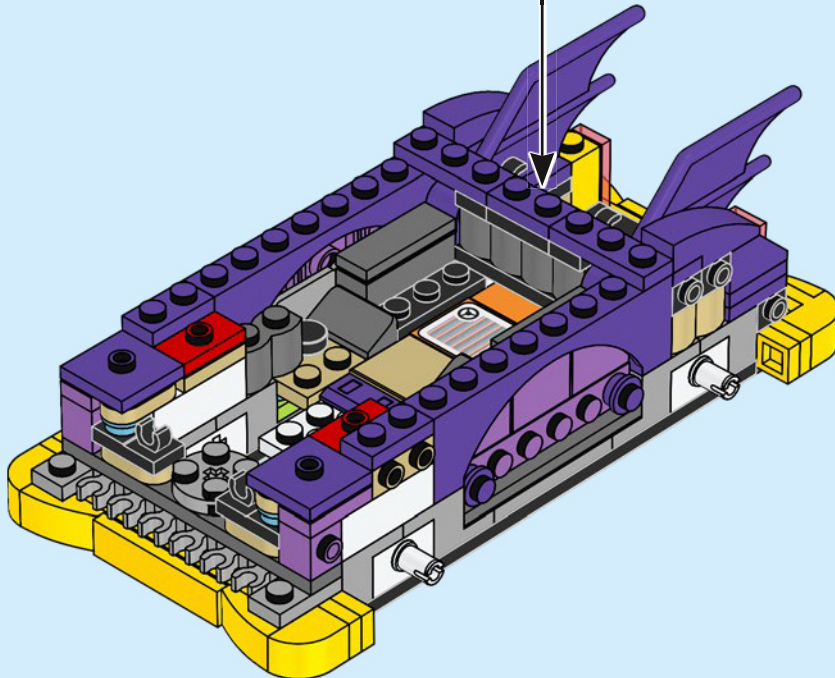
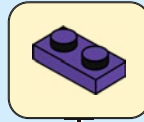





2x



2x

62

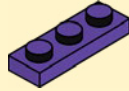

2x

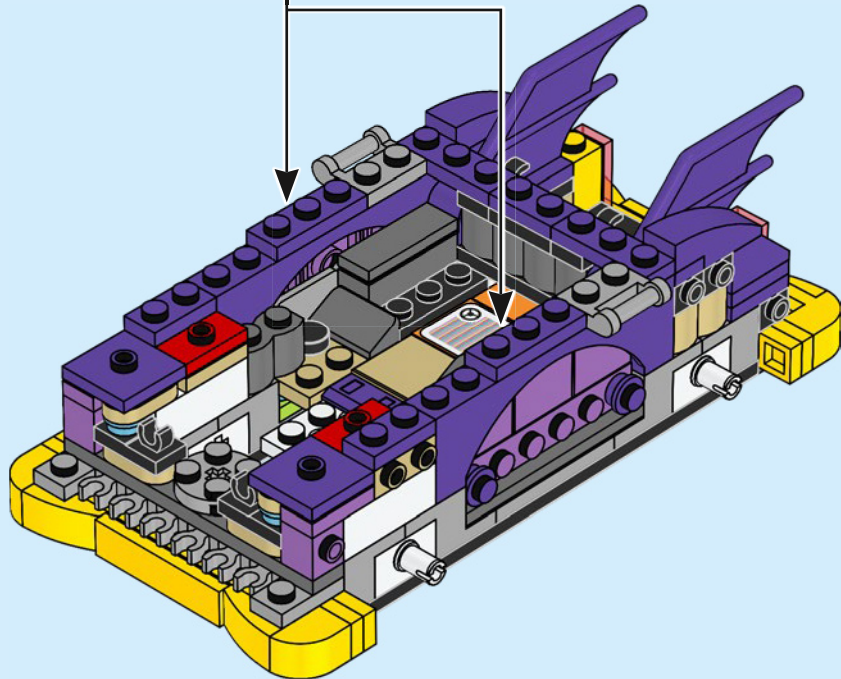

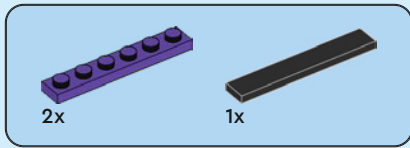

63

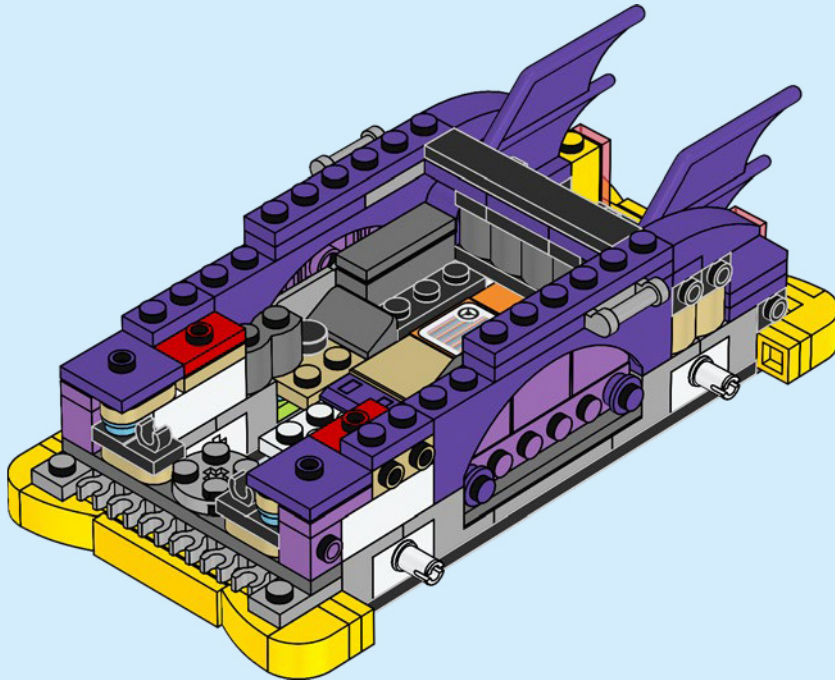



2x

64

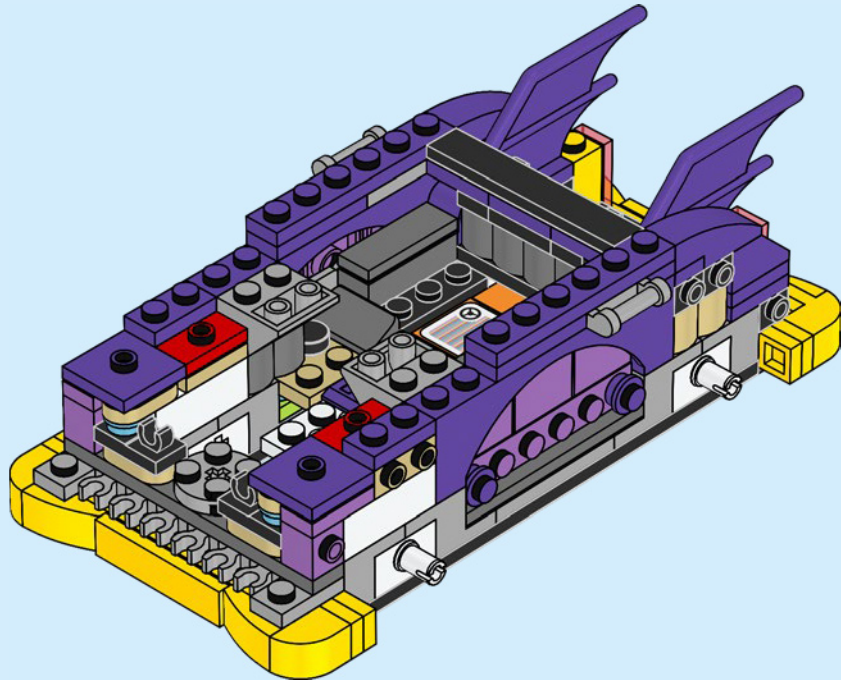



2x

65

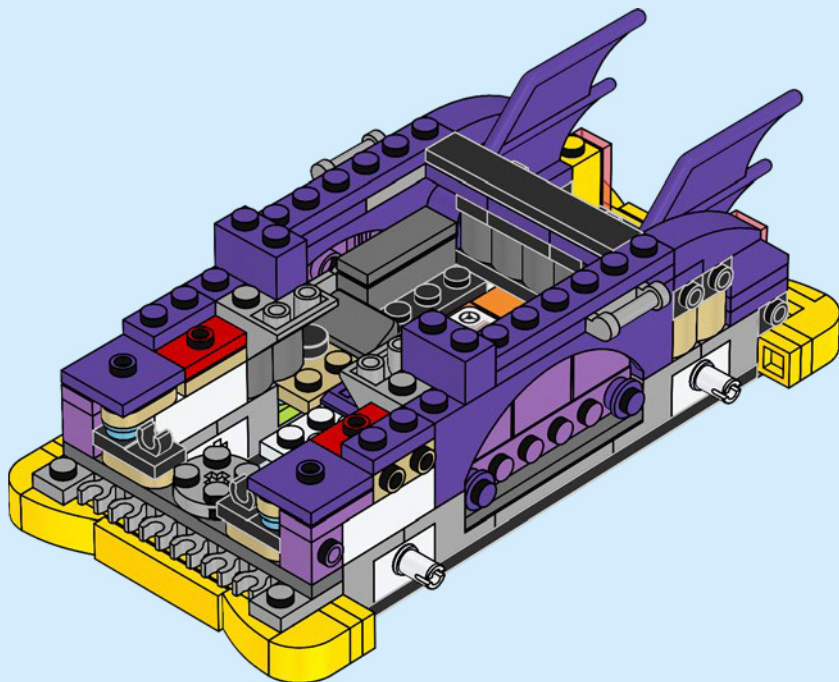

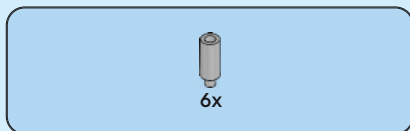

66

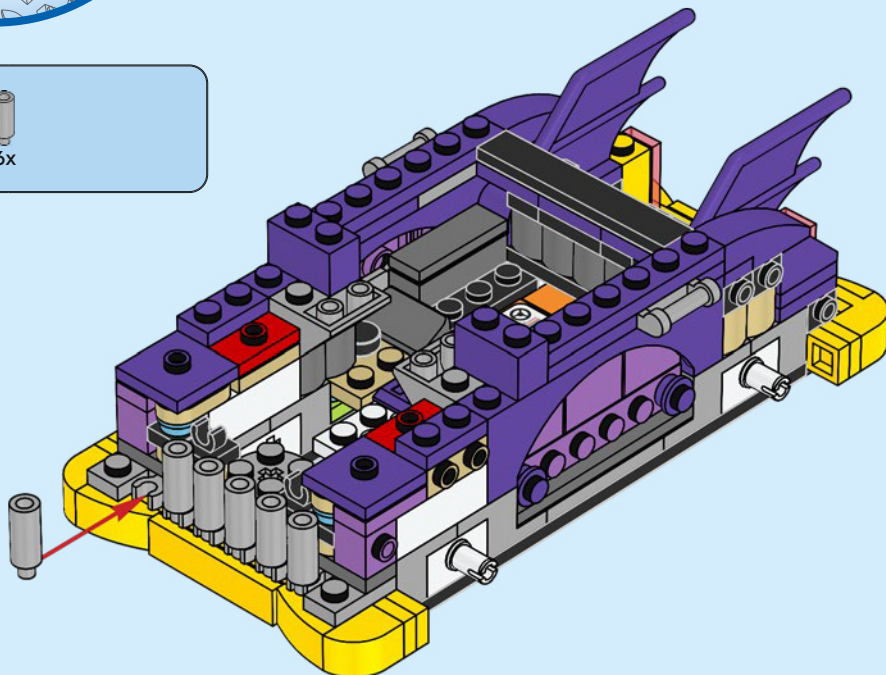



2x

67

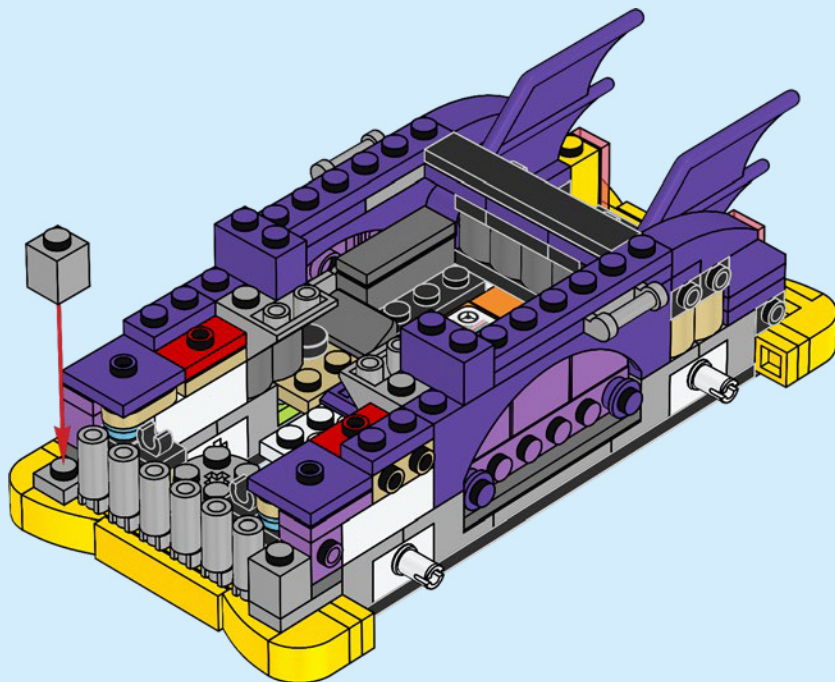

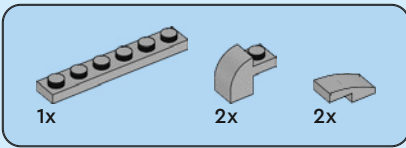

68

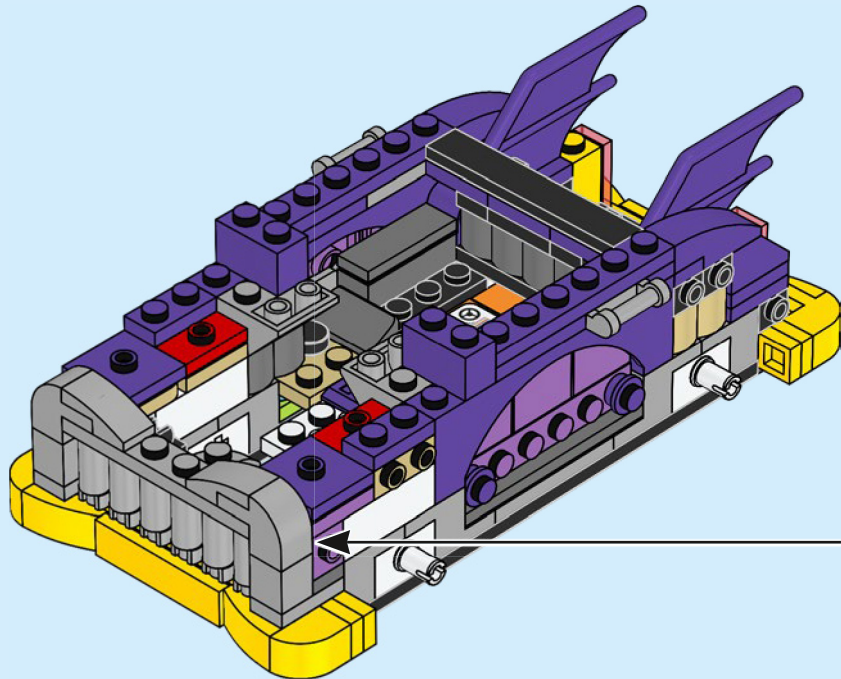
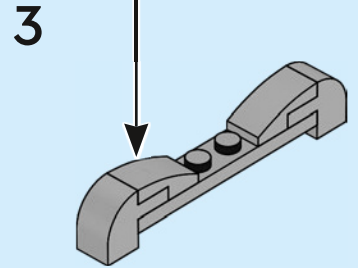
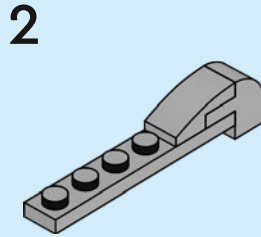
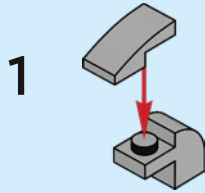



1x

69

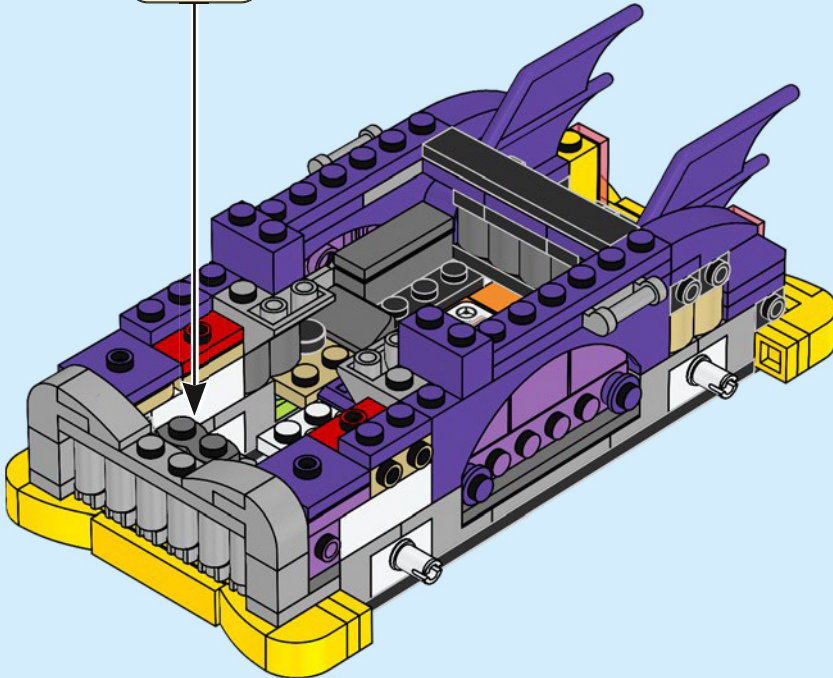
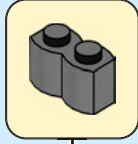





2x

70



2x

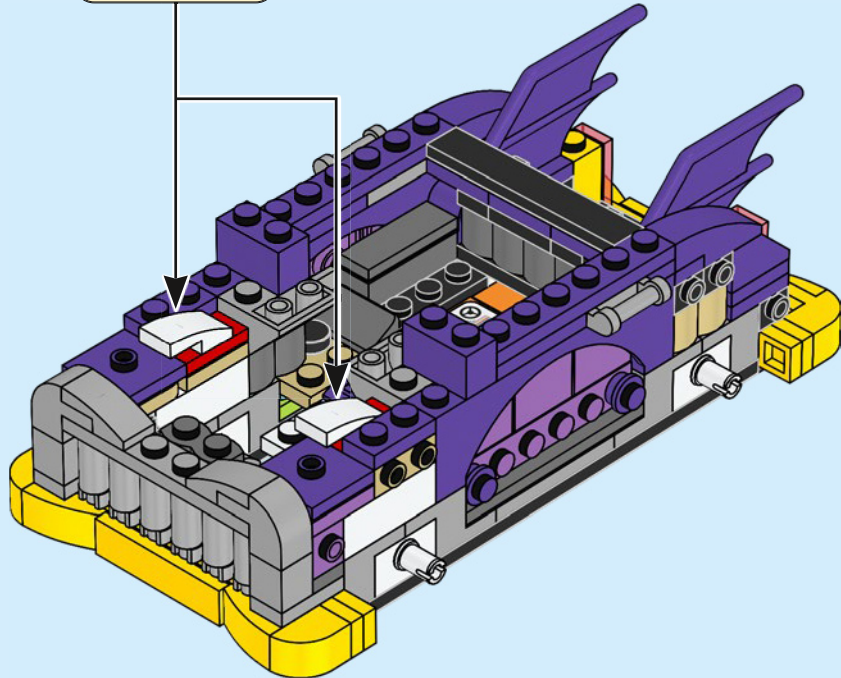



71

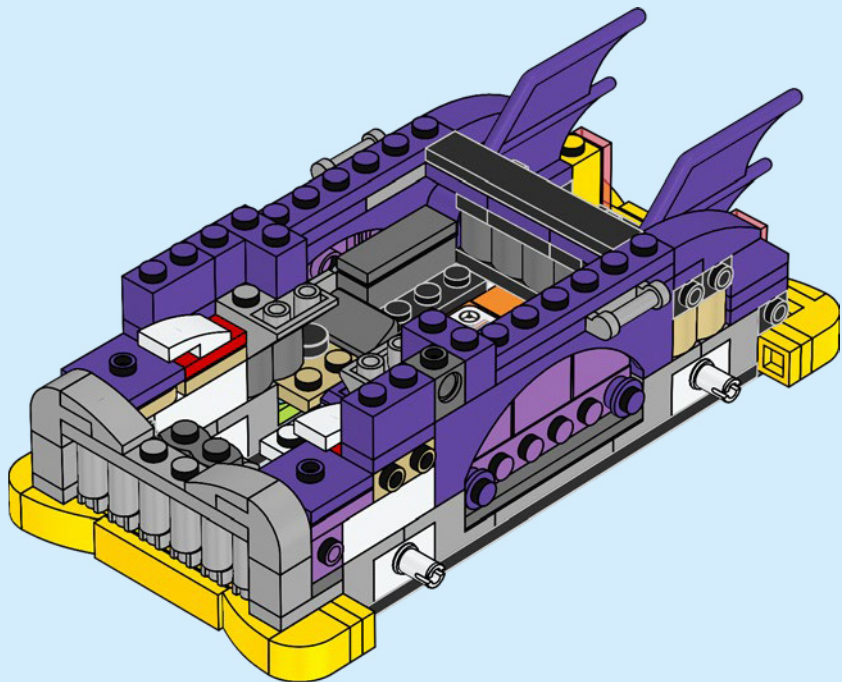

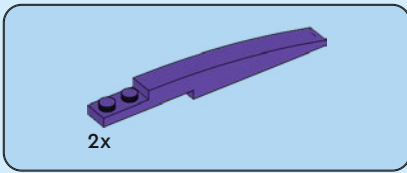

72

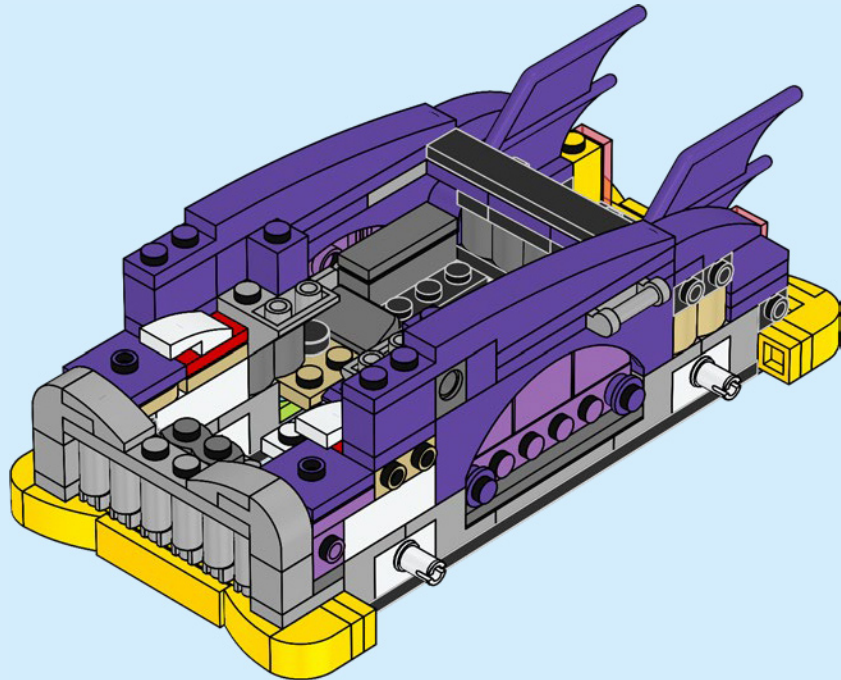



2x



2x

# 73

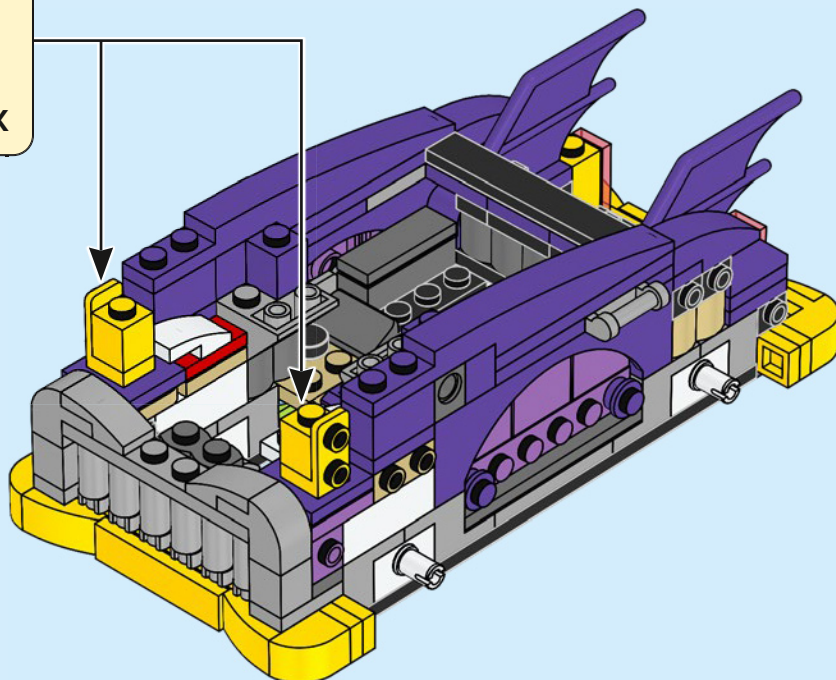
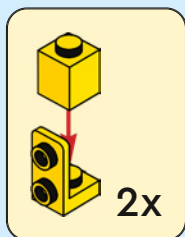



74

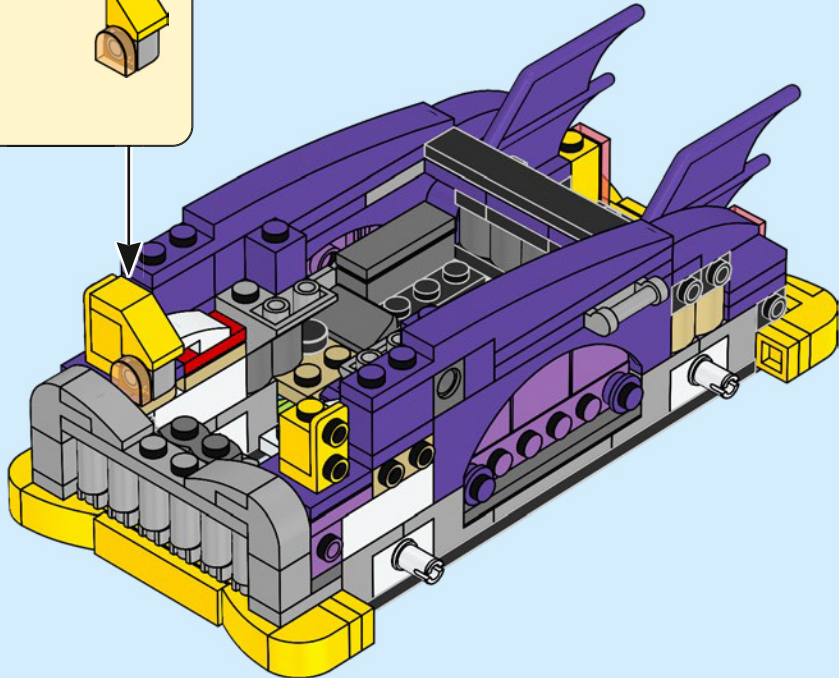
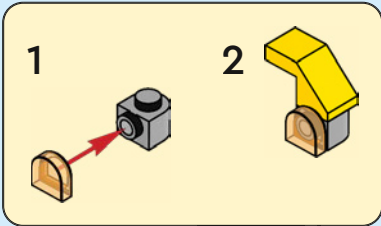

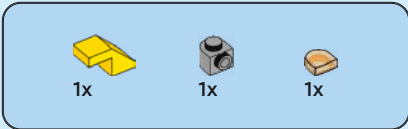

75

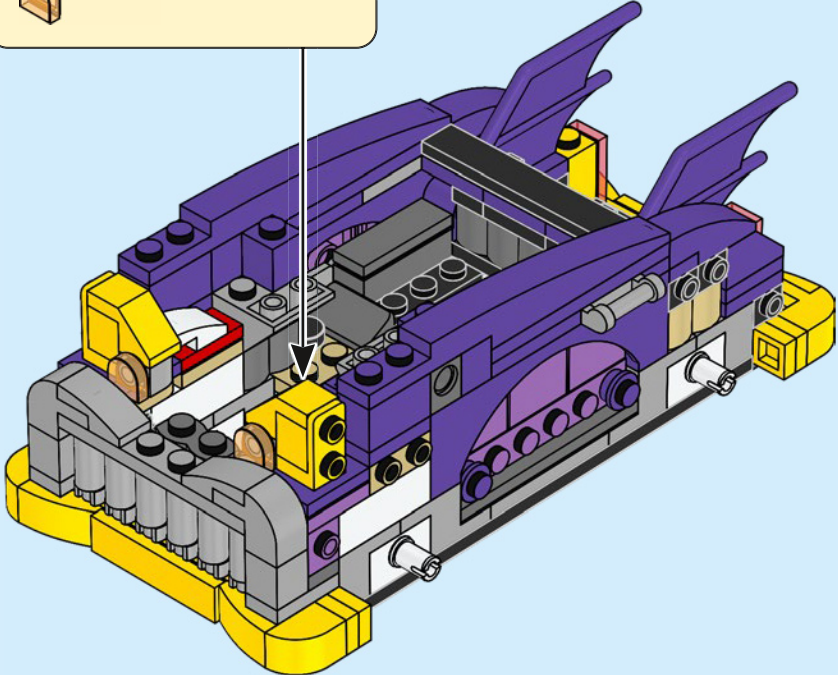
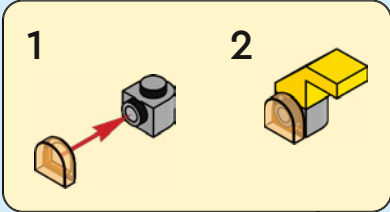

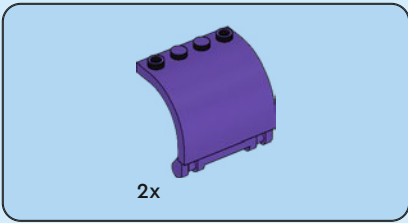

76

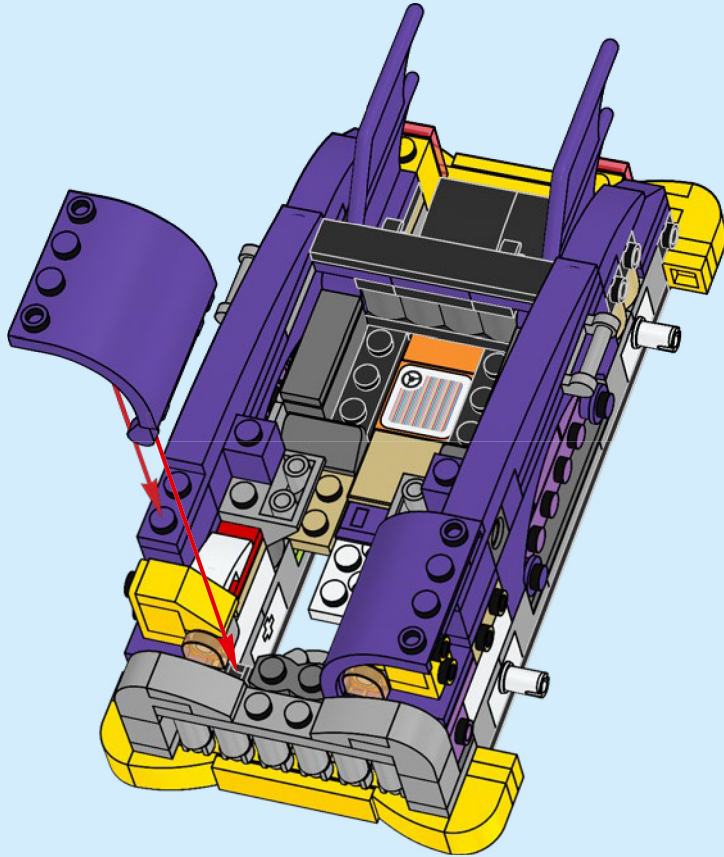

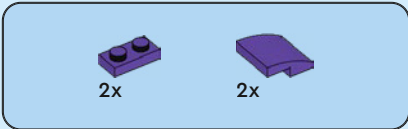

77

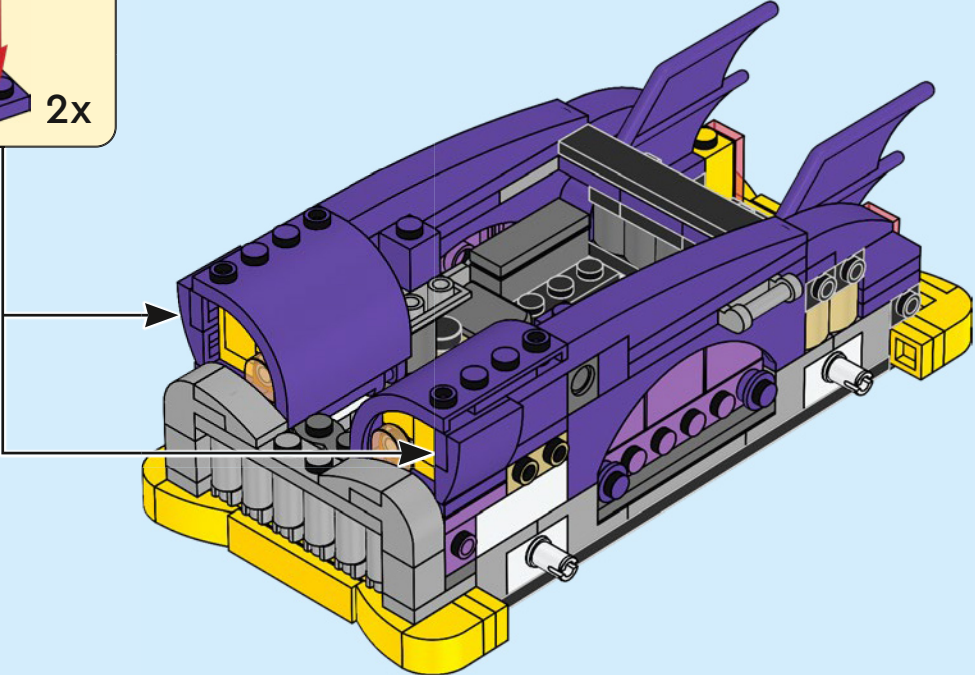
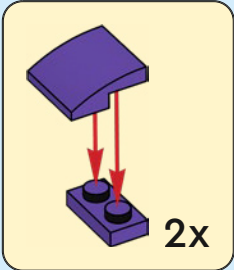





1x

78

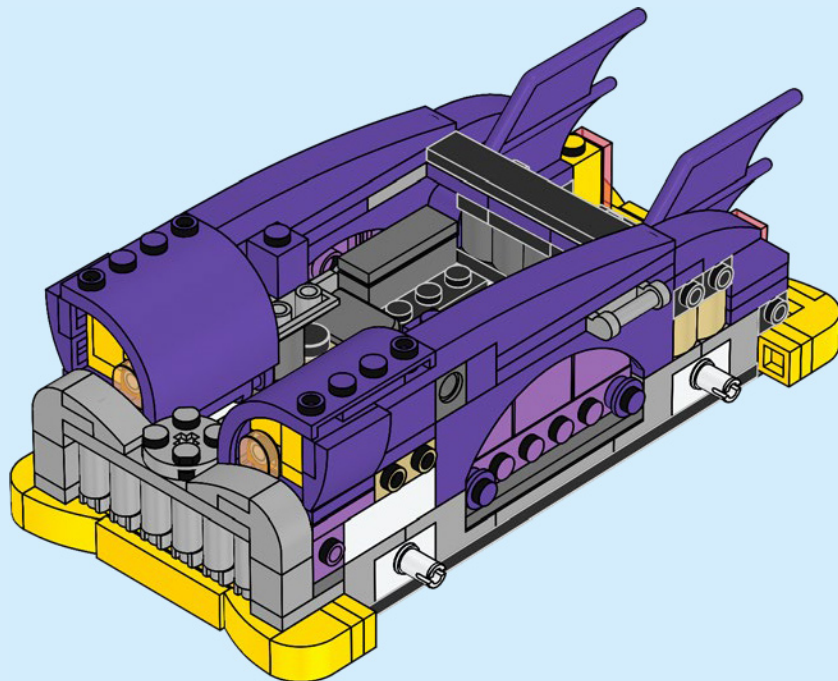

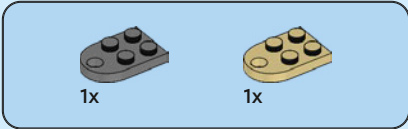
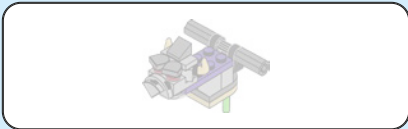

79

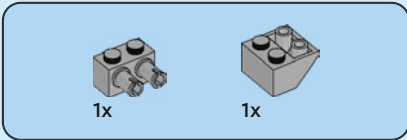
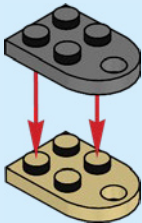

80

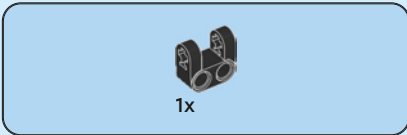
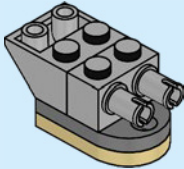

81

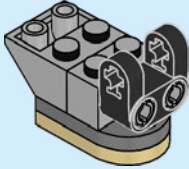

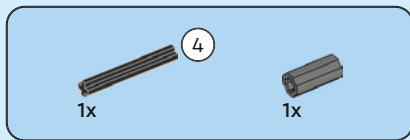

82

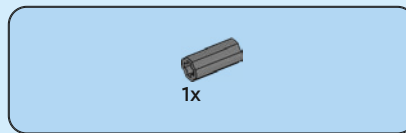
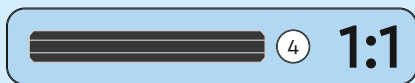
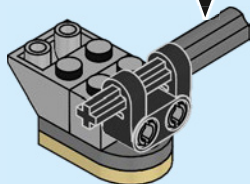
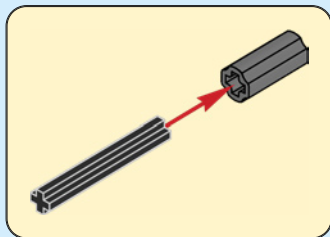

83

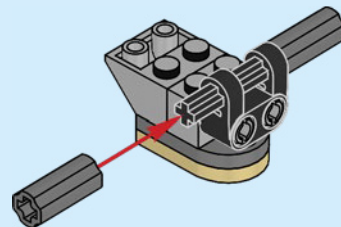



84



85

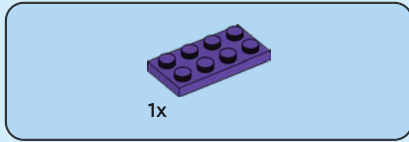
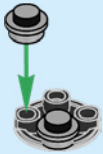

86

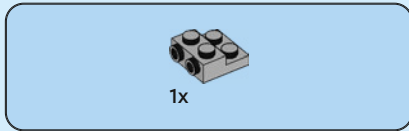
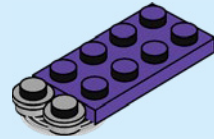

87

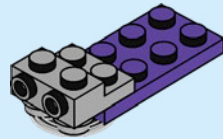

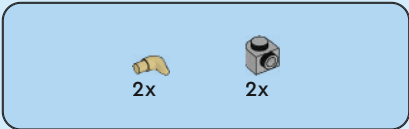

88

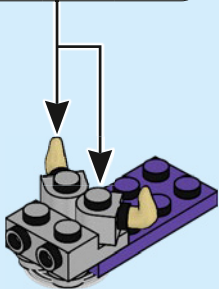
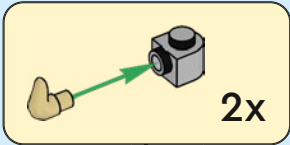

89

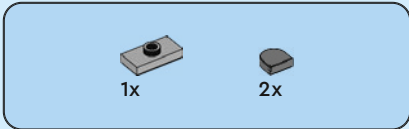
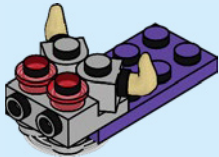

90

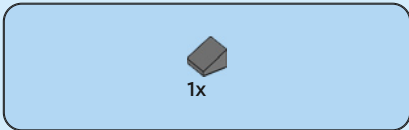
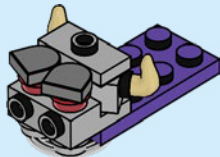

91

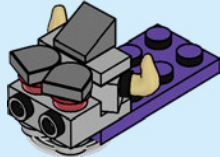

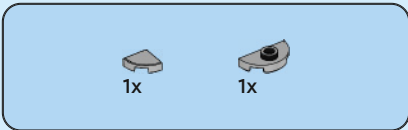

92

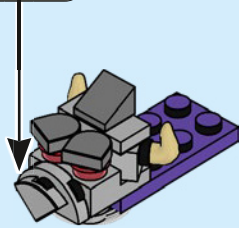
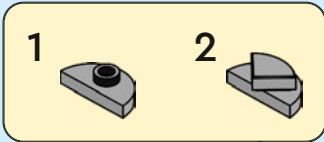

93

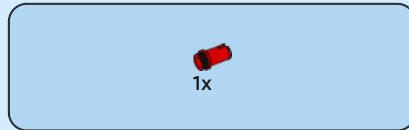
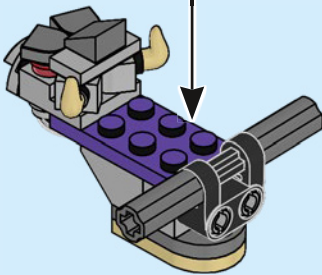

94

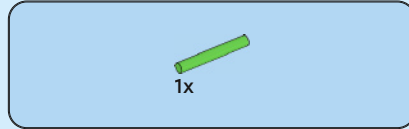
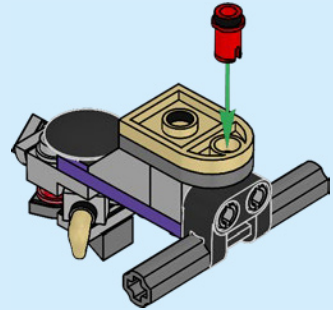

95

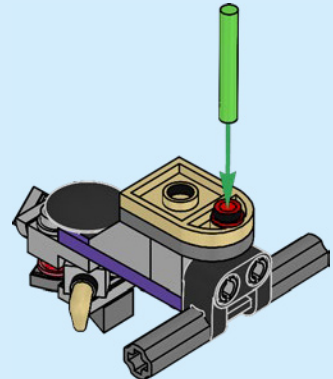

96

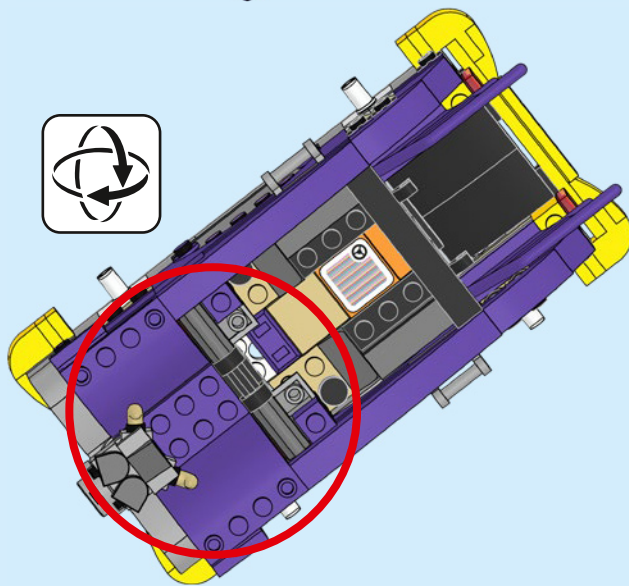
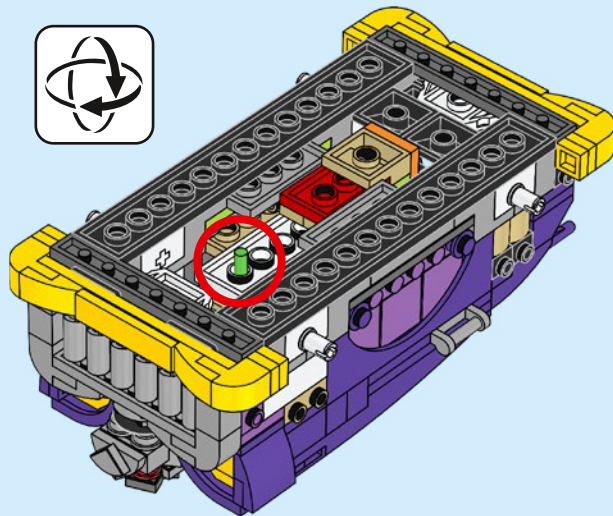
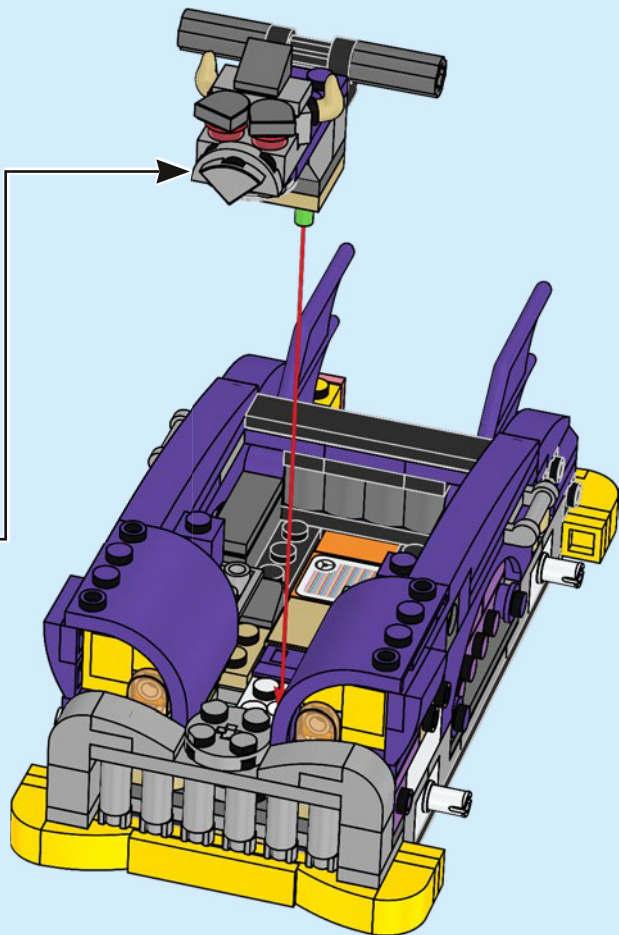

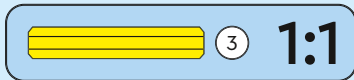
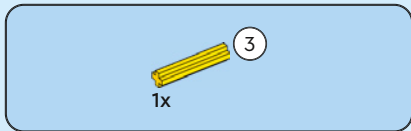

97

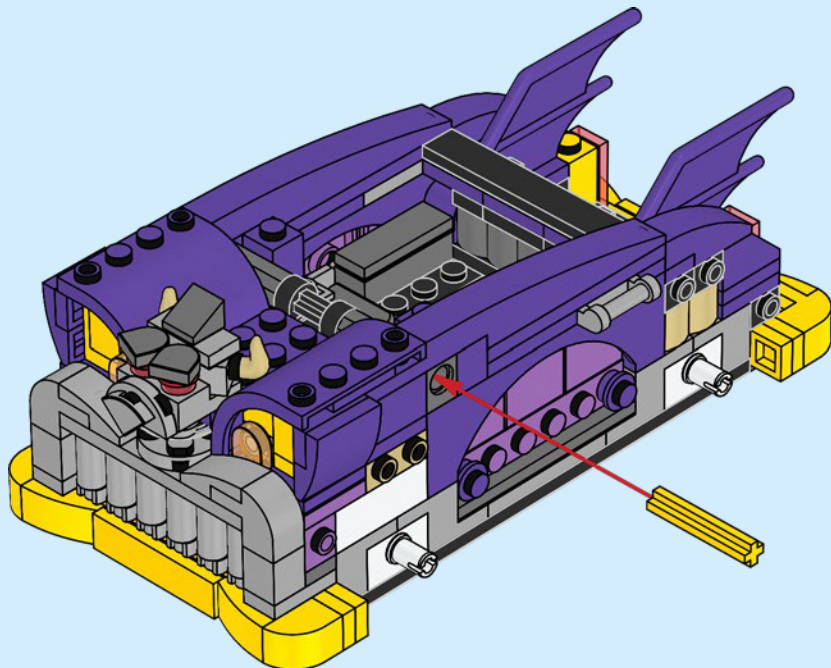



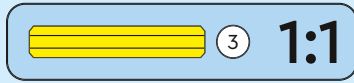
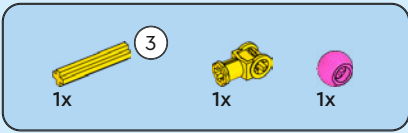

98

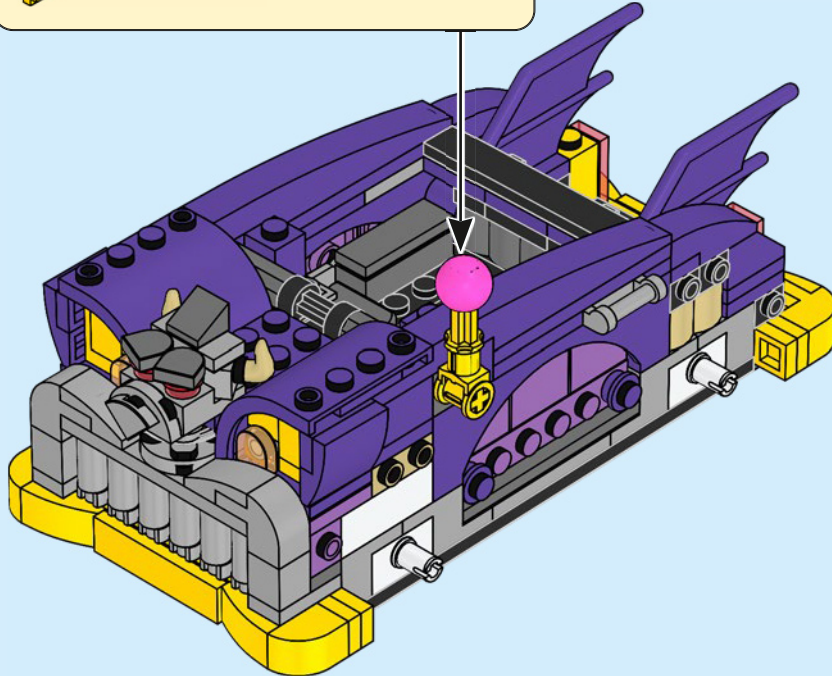
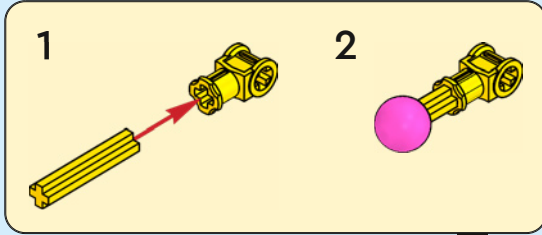

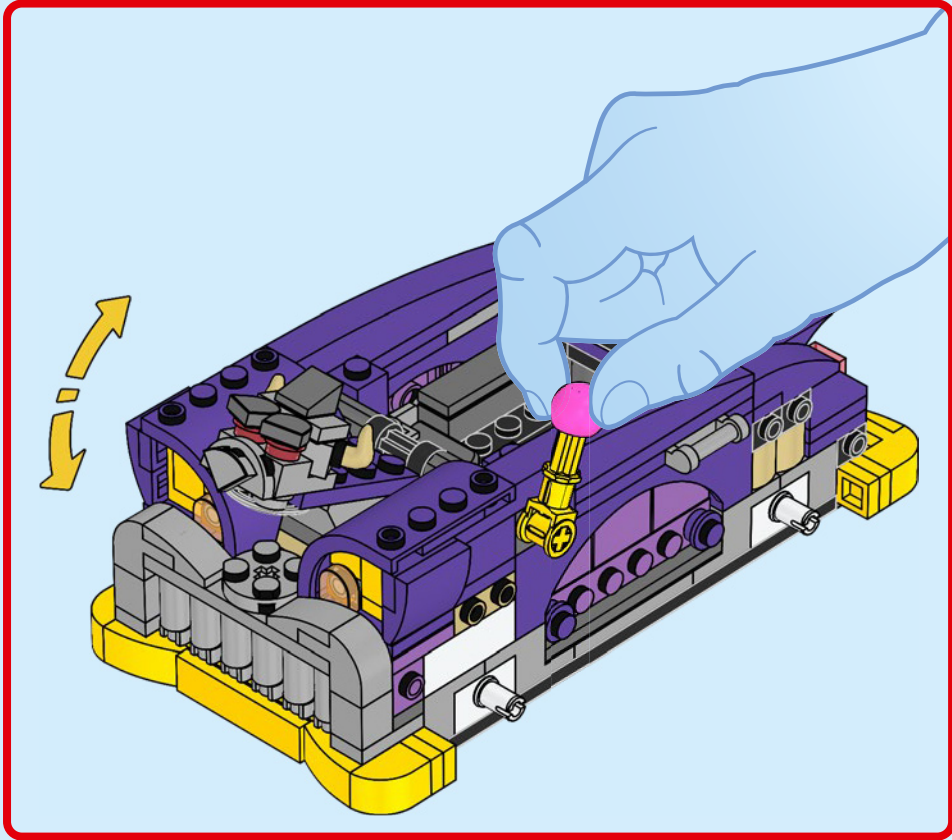



4x



4x

99

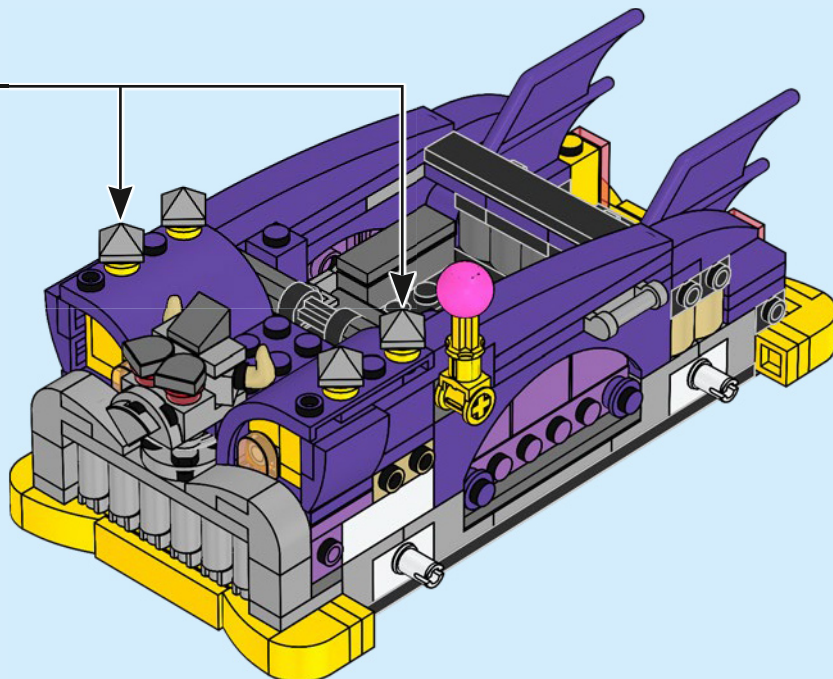
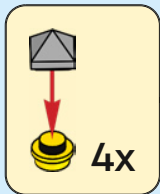

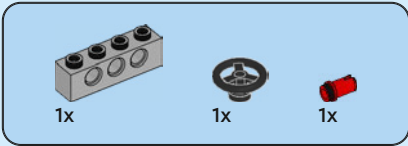

100

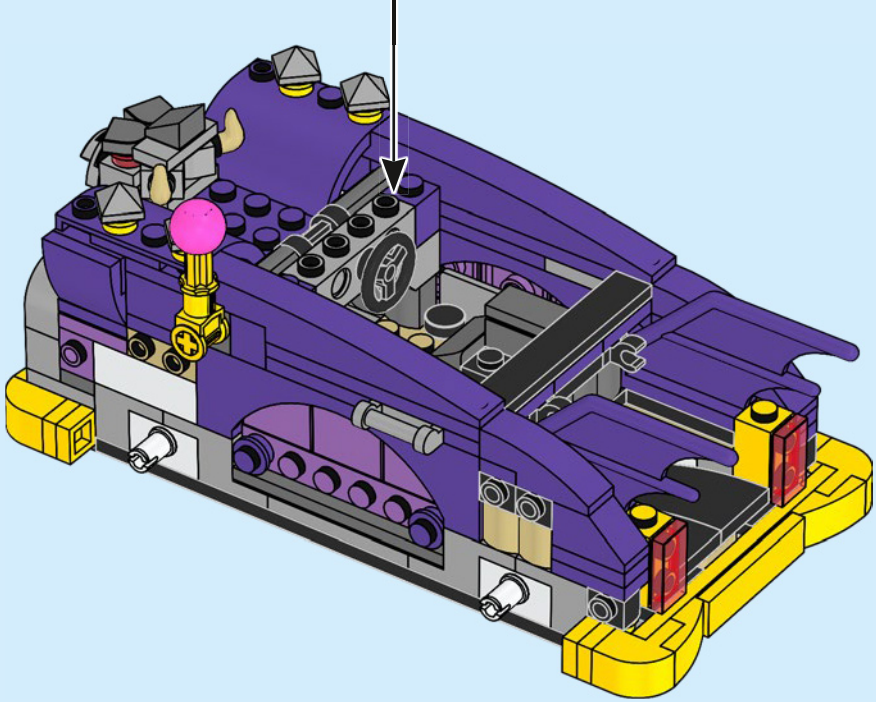
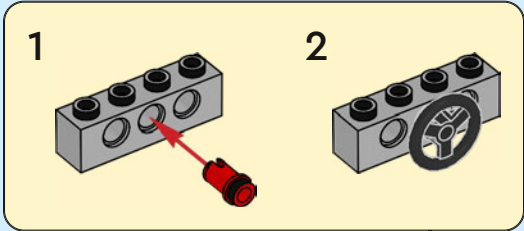

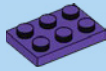

2x

# 101

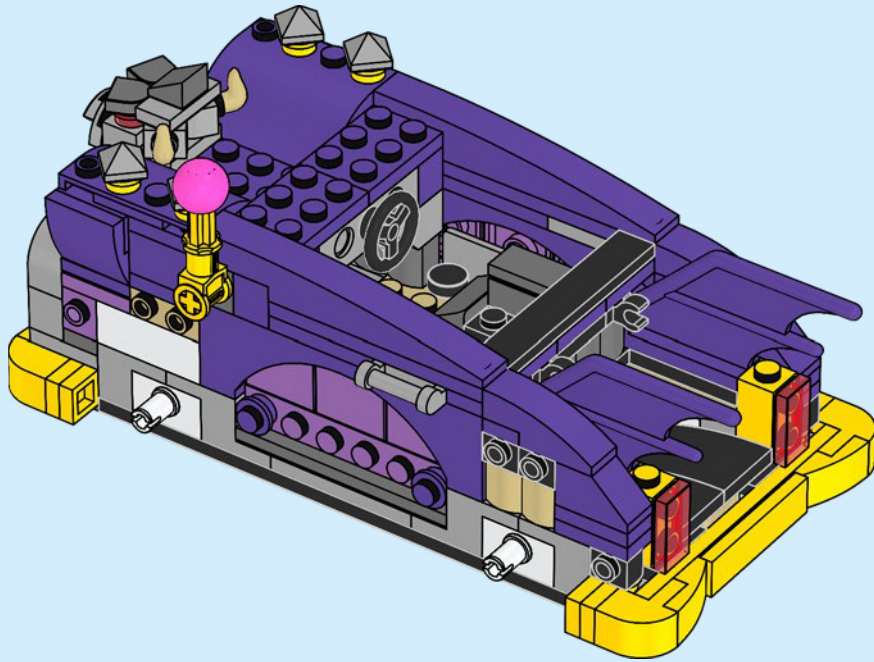

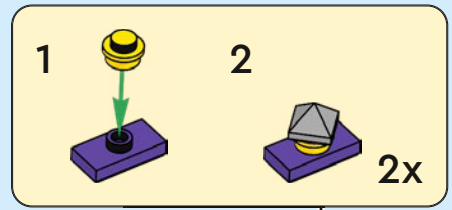
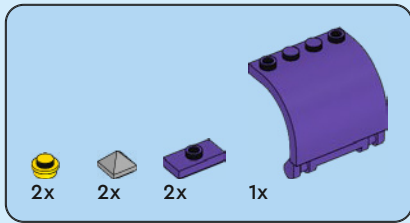

102

1

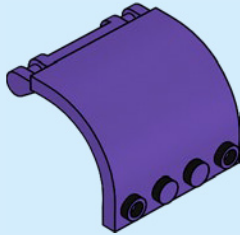

2

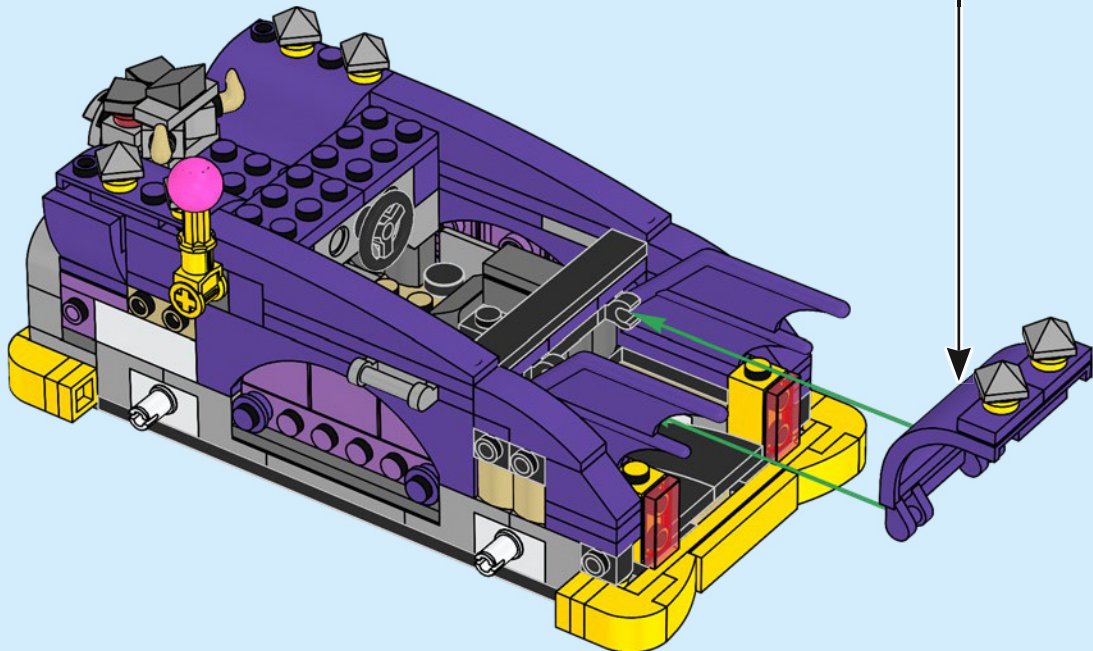
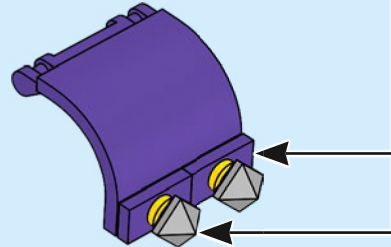

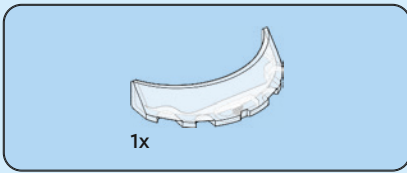

103

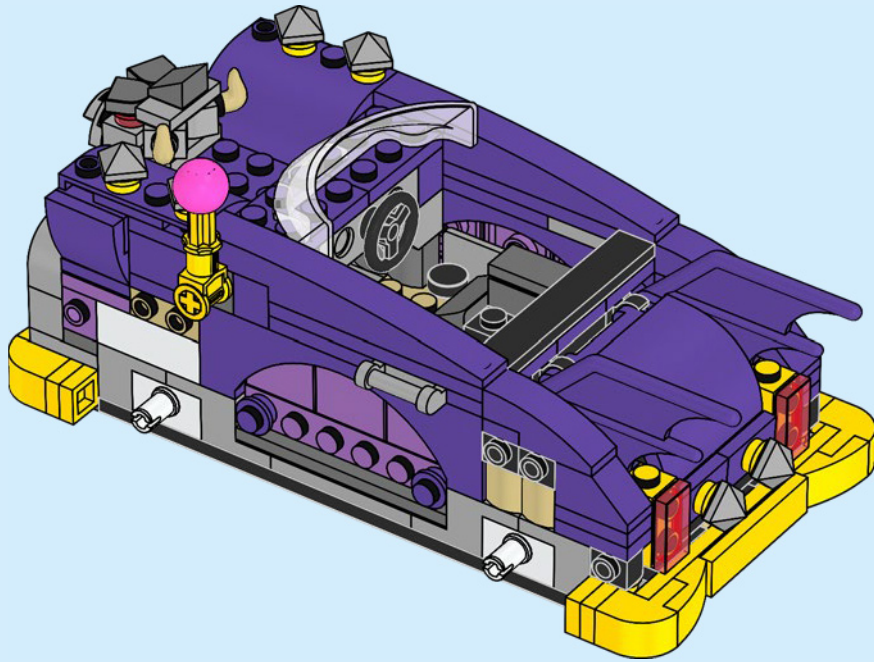



104

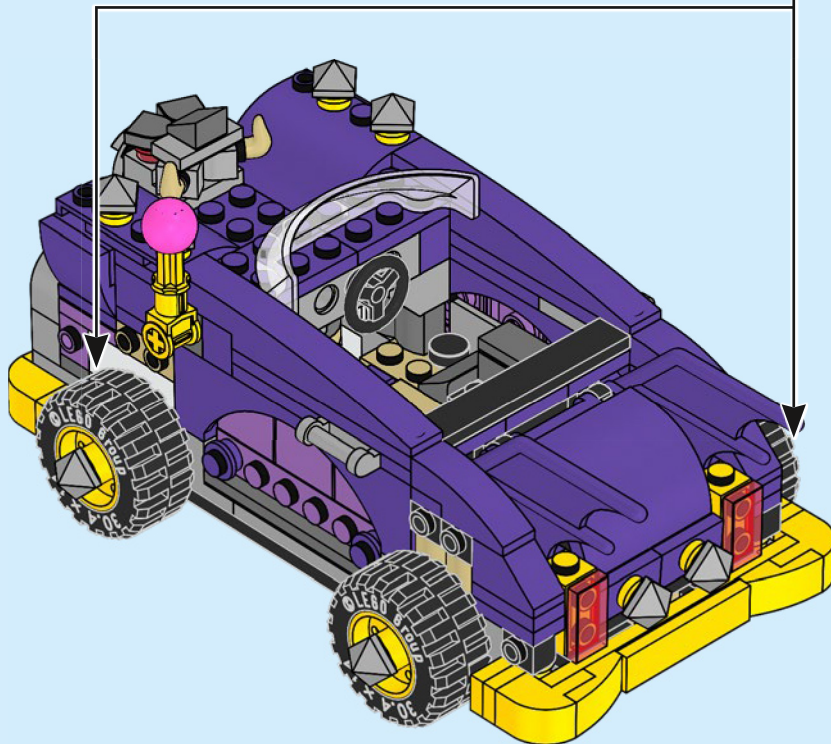
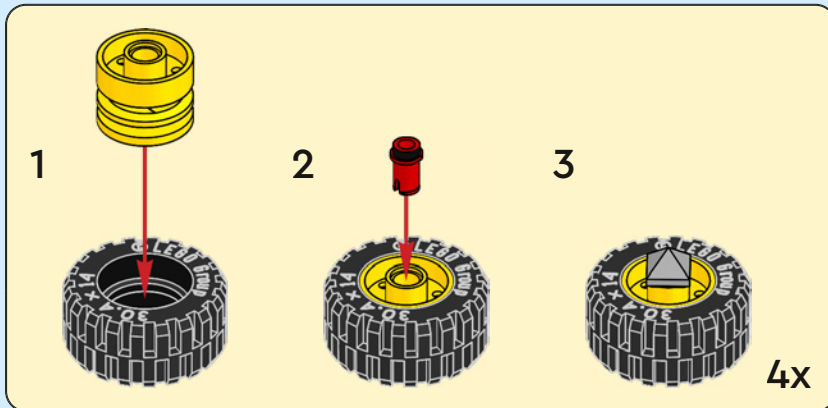



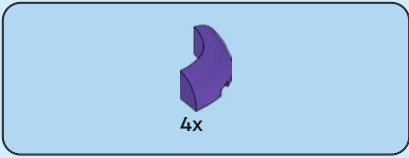

105

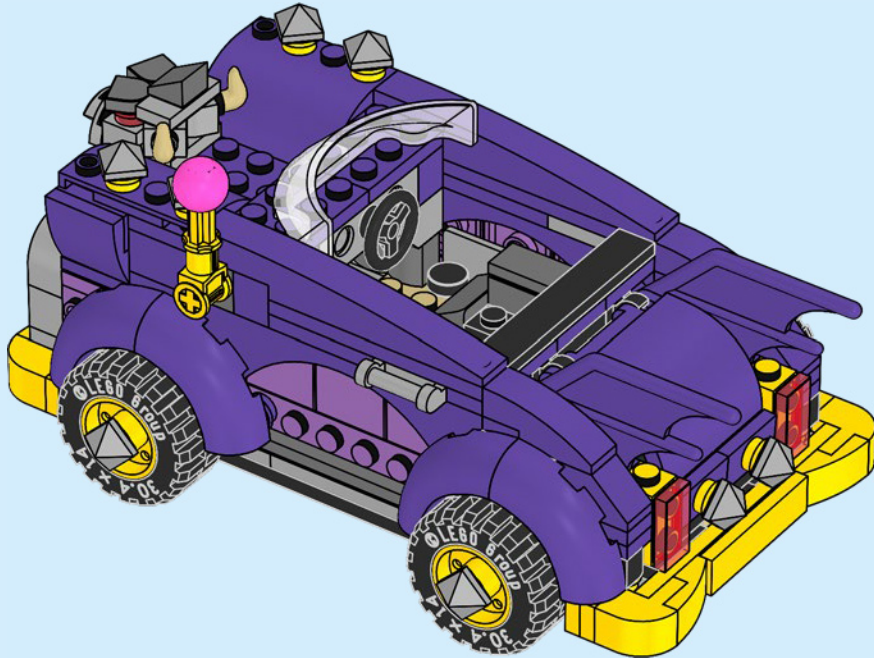

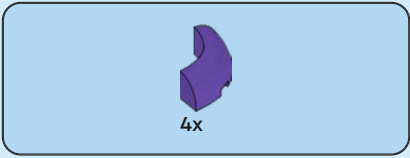

106

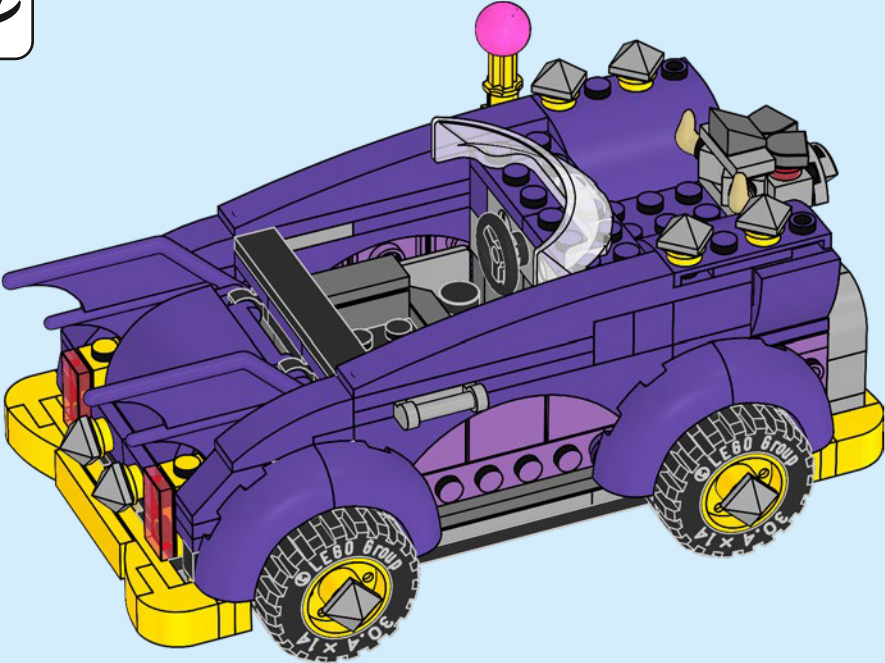

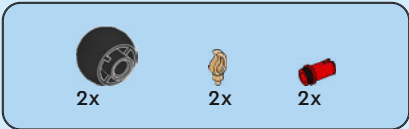

# 107

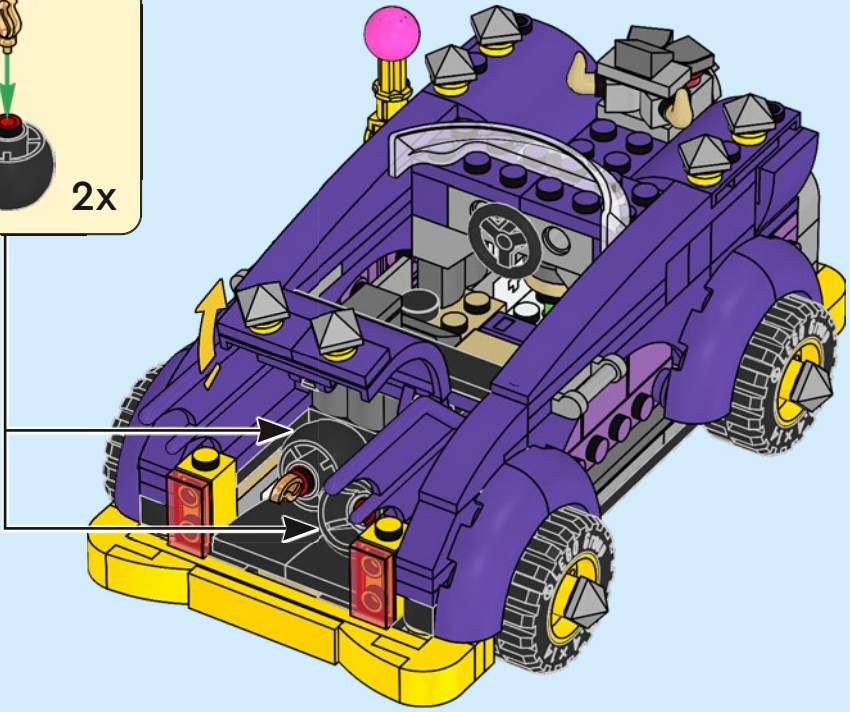
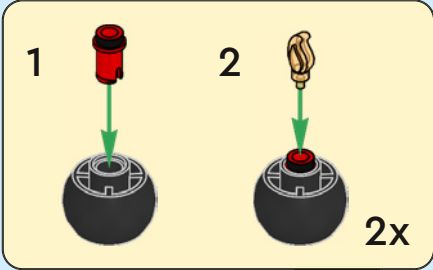

1

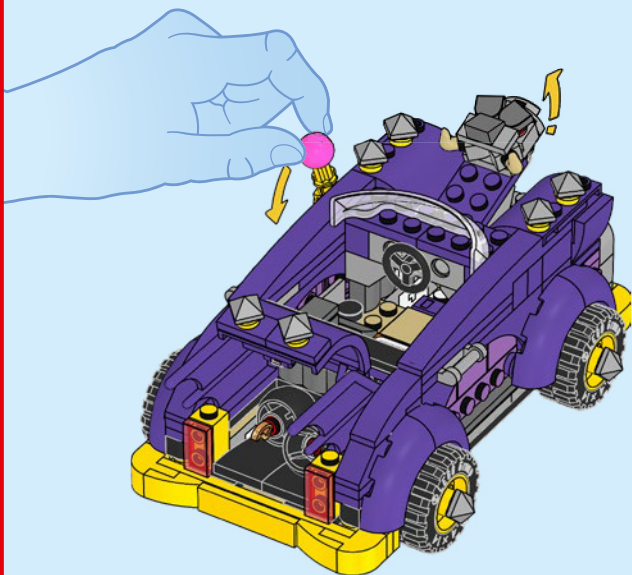

2

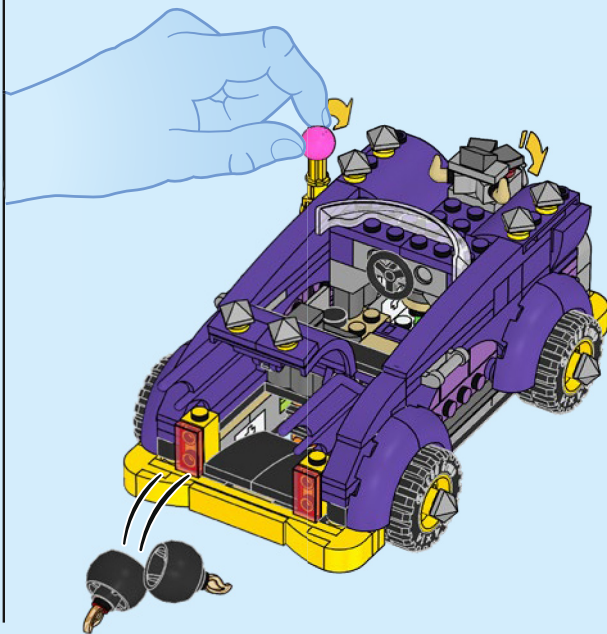

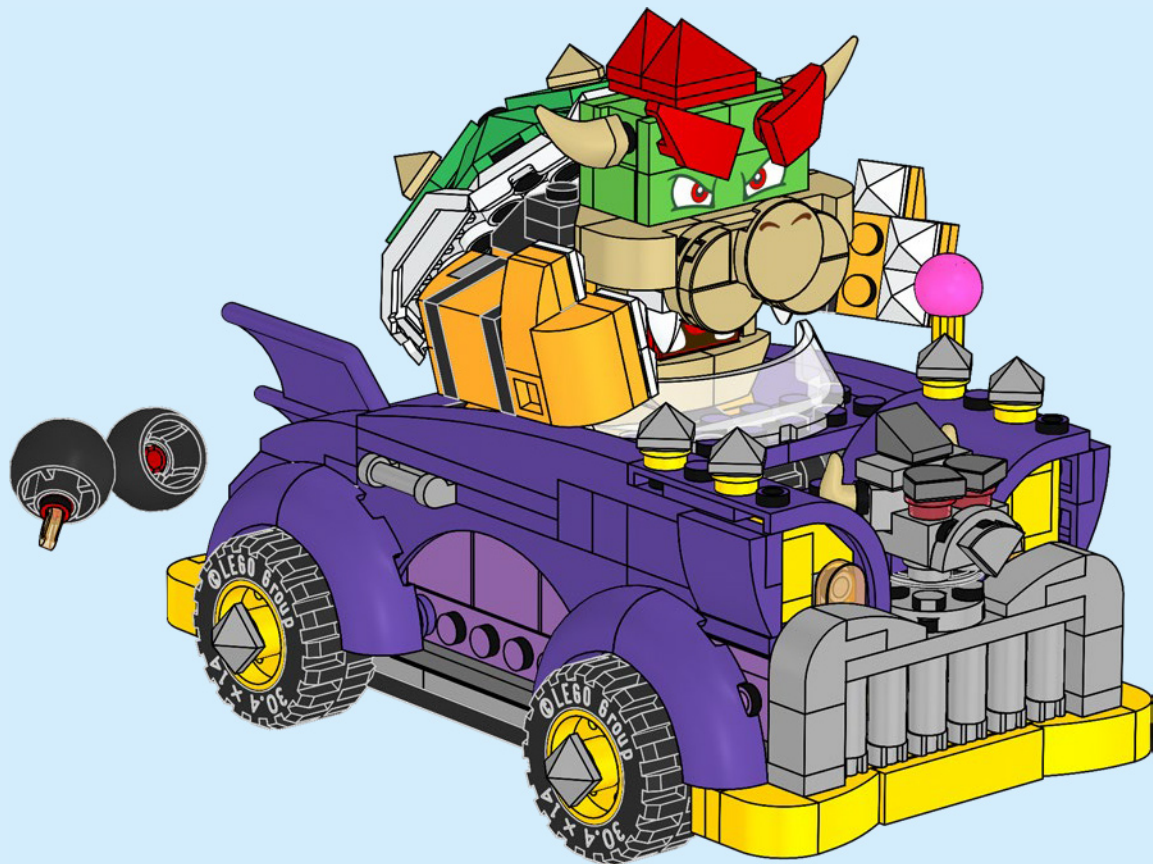

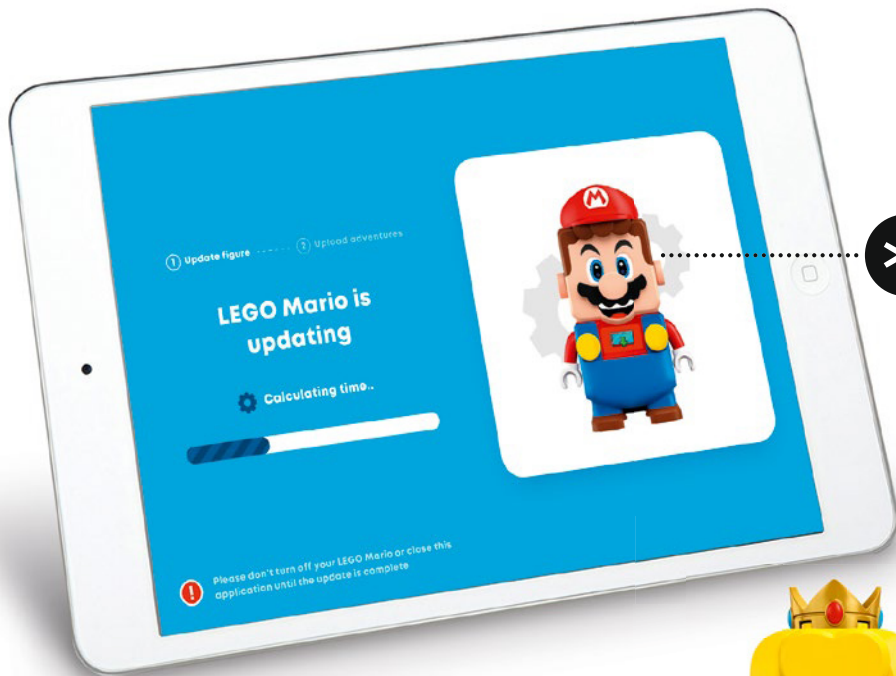

**UPDATE YOUR  
INTERACTIVE FIGURE  
IN THE LEGO®  
SUPER MARIO™ APP TO  
BE READY TO PLAY**



**METTRE À JOUR LA  
FIGURINE INTERACTIVE  
DANS L'APPLICATION  
LEGO® SUPER MARIO™  
POUR POUVOIR JOUER**



**LEGO® Super Mario™ app  
Application LEGO® Super Mario™  
App LEGO® Super Mario™**



**ACTUALIZA TU FIGURA  
INTERACTIVA EN LA APP  
LEGO® SUPER MARIO™  
Y PREPÁRATE PARA  
JUGAR**

**[LEGO.com/super-mario-trouble-shooting-guide](https://www.lego.com/super-mario-trouble-shooting-guide)**



71431



71360

OR/OU  
/O



71387

OR/OU  
/O



71403



**DISCOVER MORE  
ABOUT YOUR  
SET IN THE APP**



**TROUVEZ PLUS  
D'INFORMATIONS  
SUR L'ENSEMBLE  
DANS L'APPLICATION**

**DESCUBRE MÁS  
ACERCA DE TU SET EN  
LA APP**





Starter Course 71360 and/or 71387  
and/or 71403 needed

Pack(s) de démarrage 71360 et/ou  
71387 et/ou 71403 nécessaire(s)

Se necesita el Recorrido Inicial 71360  
y/o 71387 y/o 71403



Rebuild  
the  
world™





Rebuild  
the  
world™



6x 6314487	2x 6314377	1x 4185177	2x 6089698	4x 6361082	4x 393726	4x 4619323
1x 6218823	2x 6368620	3x 6469454	1x 6117974	4x 6109681	4x 393826	2x 4647286
2x 6046384	2x 6145570	1x 6170776	1x 6309105	2x 243124	2x 6347310	1x 302326
8x 6178921	1x 6299936	1x 6318084	1x 302121	2x 346024	1x 302326	1x 302026
2x 6034044	5x 6249125	1x 6294716	2x 302323	2x 6284070	1x 241226	
2x 6046381	2x 6408047	1x 6294716	10x 614124	6x 6424674	2x 6000650	
4x 6289797	6x 6212758	3x 4113233	2x 300524	2x 302426	4x 6016172	
2x 6188400	1x 6299935	1x 6312481	2x 6441826	2x 6344752	2x 6250020	
2x 6188400	2x 4140562	3x 4113993	8x 302424	2x 6308000	2x 302226	
2x 4249506	1x 6310515	2x 614121	2x 6330893	1x 4278359	1x 300326	
		8x 6378120	1x 6375678		4x 362326	
2x 300201	4x 6281995	2x 6378120	1x 6375678		4x 362326	
		1x 6177505	1x 6313121		1x 370526	
		1x 6177505	2x 6228597		1x 371026	
		2x 6075074	4x 6029947			
		2x 6092565	2x 6130007			

1x 6161772	2x 6318085	4x 6448793	3x 6435857	2x 4568734	2x 6446090	2x 6103449
1x 6309102	3x 6024286	2x 4211389	1x 6469440	2x 4211104	2x 6182217	2x 4225142
1x 6141590	4x 6374487	1x 6176433	1x 64225733	1x 4225733	4x 6035470	1x 6030277
1x 6246850	6x 6145215	10x 6258381	8x 6347992	2x 4210651	3x 6433303	6x 6102986
2x 6208450	2x 6337271	1x 6420741	1x 4211441	3x 4210998	2x 4655691	2x 6125776
2x 6251290	4x 6099714	6x 6296894	2x 6079461	4x 4566522	2x 6468785	2x 4619512
1x 4188771	4x 6034175	2x 4211475	1x 4211438	1x 6084028	2x 6468785	6x 6173813
1x 4159007	5x 6003033	2x 6043656	1x 4211438	2x 6231376	2x 6358028	2x 4649745
1x 6474140	2x 6295078	2x 4211398	1x 6228091	8x 6367941	2x 6468787	
2x 4164037	2x 6285778	2x 6028813	2x 6362252	9x 4655695		
2x 4529160	2x 6028813	2x 6028813	1x 4210639	4x 6104154		
2x 6357747	2x 6469079	1x 6066097	1x 4504378	2x 6109814		
2x 6249116	1x 6248671	4x 4654580	2x 4567887	2x 6092604		
8x 6073040	2x 6071607	1x 6276874	6x 4211095	1x 6394865		
	6x 6436421	2x 4244627	2x 4516546			
	2x 4211525					

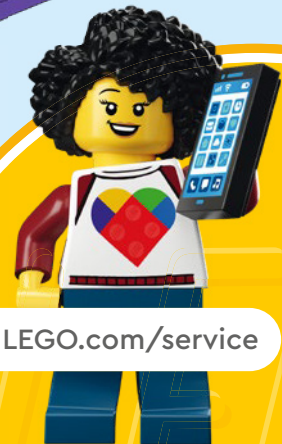

YOU COULD **WIN**

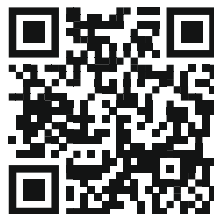

Scan this QR code or go to **LEGO.COM/PRODUCTFEEDBACK** and give us your short feedback about this LEGO® set for a chance to win a cool LEGO prize.

Terms and Conditions apply\*

**EN: YOU COULD WIN.** Terms and Conditions apply\* **DE: Du könntest GEWINNEN.** Es gelten die Teilnahmebedingungen\* **FR: Tu pourrais GAGNER.** Des conditions s'appliquent\* **IT: Potresti VINCERE tu.** Termini e condizioni sono applicabili\* **ES: Puedes GANAR.** Aplican términos y condiciones\* **PT: Poderá GANHAR.** Aplicam-se termos e condições\* **ZH: 轻松获奖. 条款和条件适用\*** **PL: Szansa na WYGRANĄ.** Obowiązują warunki korzystania\* **CS: Máte šanci VYHRÁT.** Platí všeobecné smluvní podmínky\* **SK: Máte šancu VYHRAŤ.** Platia všeobecné zmluvné podmienky\* **HU: TE IS NYERHETSZ.** Felhasználási feltételek érvényesek\* **RO: Ai putea CÂȘTIGA.** Se aplică termeni și condiții\* **BG: Можете да СПЕЧЕЛИТЕ.** Има определени правила и условия\* **LV: Tu vari LAIMĒT.** Ir spēkā noteikumi un nosacījumi.\* **ET: Sul on võimalus VÕITA.** Kehtivad tingimused\* **LT: Jūs galite LAIMĖTI.** Taikomos sąlygos\*

\*[LEGO.com/productfeedback-terms](https://www.lego.com/productfeedback-terms)

LEGO, the LEGO logo and the Brick and Knob configurations are trademarks of the/son des marques de commerce du/son marcas registradas de LEGO Group. ©2024 The LEGO Group.

TM & © 2024 Nintendo.

6497690