

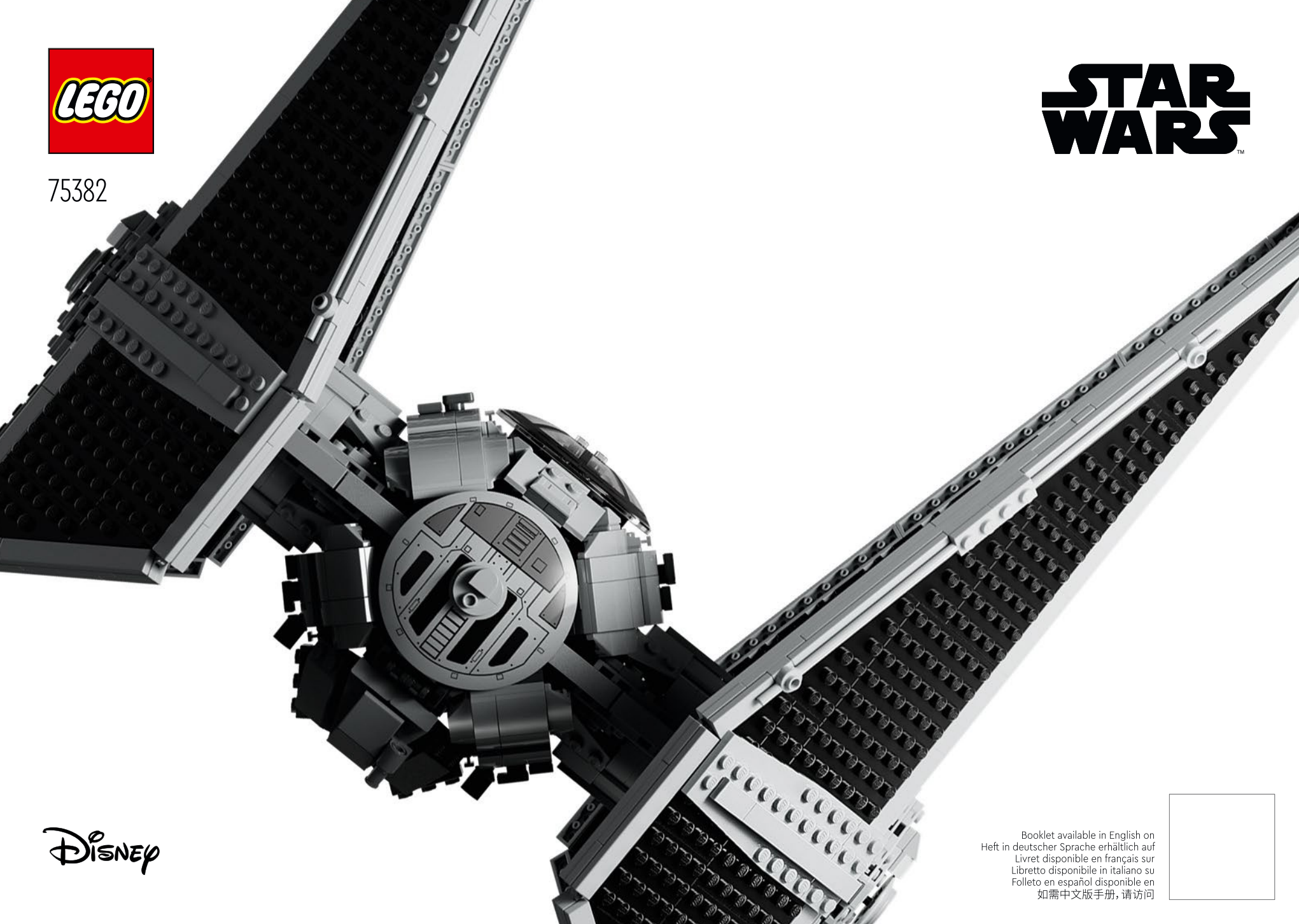

75382

**STAR  
WARS**



**Disney**

Booklet available in English on  
Heft in deutscher Sprache erhältlich auf  
Livret disponible en français sur  
Libretto disponibile in italiano su  
Folleto en español disponible en  
如需中文版手册, 请访问

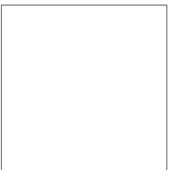



LEGO.com/sustainable-packaging



FR  
**DONNEZ**  
OU  
**RECYCLEZ**



OU



OU



ASSOCIATION    MAGASIN    DÉCHÈTERIE

Adresses sur [quefairedemesdechets.fr](http://quefairedemesdechets.fr)





# BUILDER



Apple and the Apple logo are trademarks of Apple Inc., registered in the U.S. and other countries and regions. App Store is a service mark of Apple Inc. Google Play and the Google Play logo are trademarks of Google LLC. Tencent and the Tencent logo are trademarks of Tencent Inc.

LEGO.com/devicecheck



LEGO® Builder

# A RARE GEM IN THE ULTIMATE COLLECTOR SERIES

When the first *Star Wars*™ films were released, fans were awestruck by the high level of detail and authentic looks of the starship fleets in this intriguing galaxy. Rugged or pristine, they often have as much personality as the live characters. Ever since the first LEGO® *Star Wars*™ sets were released in 1999, we have shared that love of the saga with fans of all ages and recreated its starships and vehicles in various scales. Rebel or Imperial, we keep every set as authentic-looking and detailed as possible.

The TIE Interceptor, infamous for its role in the Battle of Endor, was released as part of our first Ultimate Collector Series in 2000. It became an instant fan favourite. To celebrate our 25<sup>th</sup> anniversary, we're relaunching it in a new and even more detailed version.

Enjoy building!



**Jens Kronvold Frederiksen**

Creative Director, LEGO® *Star Wars*™









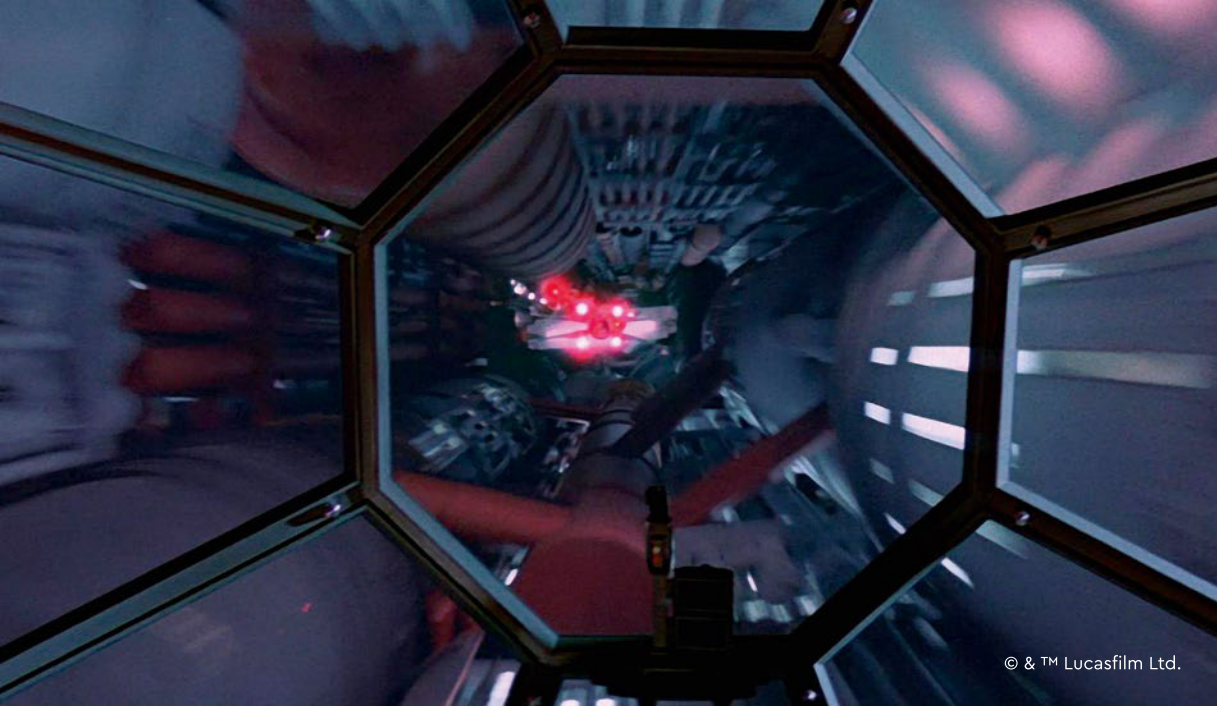

© & ™ Lucasfilm Ltd.



© & ™ Lucasfilm Ltd.

## THE TIE INTERCEPTOR

Size matters not when it comes to the TIE Interceptor. At 7.7 m (25 ft. 3 in.), it is designed for maximum speed and agility in battle. Originally employed by Palpatine's Galactic Empire, the Interceptor is faster and more manoeuvrable than other TIE fighters of its time. A new dagger-shaped wing design with large solar panel areas provides the necessary additional power for the large twin ion engines. To enhance performance in battle, Imperial designers increased firepower with four Siemar Fleet Systems L-s9.3 laser cannons and mounts for optional extra laser cannons.

While the TIE Interceptor boasts impressive armament and power, other essential design features had lower priority. With no hyperdrive system, minimal armour and no deflector shield, its strength lies in numbers – and the skills of its pilots. During the Battle of Endor, a swarm of TIE Interceptors proved a formidable fleet for the Rebellion's A-wings in particular.





© & ™ Lucasfilm Ltd.



## MEET THE MODEL DESIGNER

"In 1999, I began working on what would become the first LEGO® Star Wars™ Ultimate Collector Series version of the TIE Interceptor. This model is a redesigned version of the starship, hopefully with equal parts authenticity and engaging design, wrapped in a fun building experience!"

"The Interceptor's design and story are quite unique. If the Empire had not fallen in the Battle of Endor, this would have been the mass-produced successor to Darth Vader's TIE Advanced x1 prototype. The cutaway wing design means that (at least in the film version) the starship is lighter and more aerodynamic. The pilot's lateral vision is improved compared to previous TIE models, giving the Imperial Navy an edge in star battles against the Rebels."

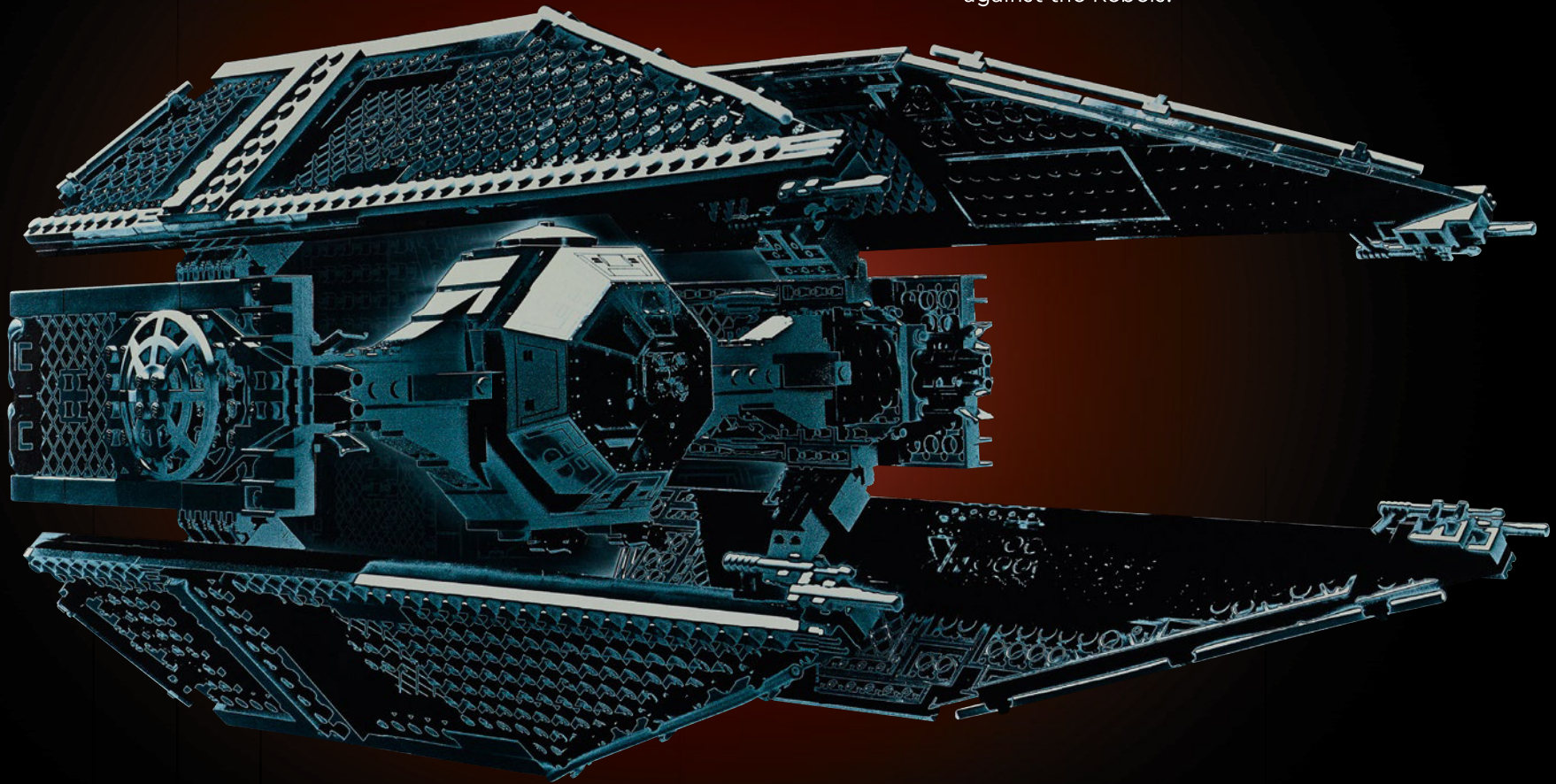

Design Master Henrik Andersen's first LEGO® Star Wars™ TIE Interceptor (7181) from 2000, and the new model (75382)



"The model is mounted on a stand with a 25<sup>th</sup>-anniversary plaque. The TIE Pilot minifigure with a new arm print is exclusive to this set. The miniature brick-built Mouse Droid is one we often see in Imperial and First Order hangars, bases and starships."

**Henrik Andersen**  
LEGO® Star Wars™  
Design Master

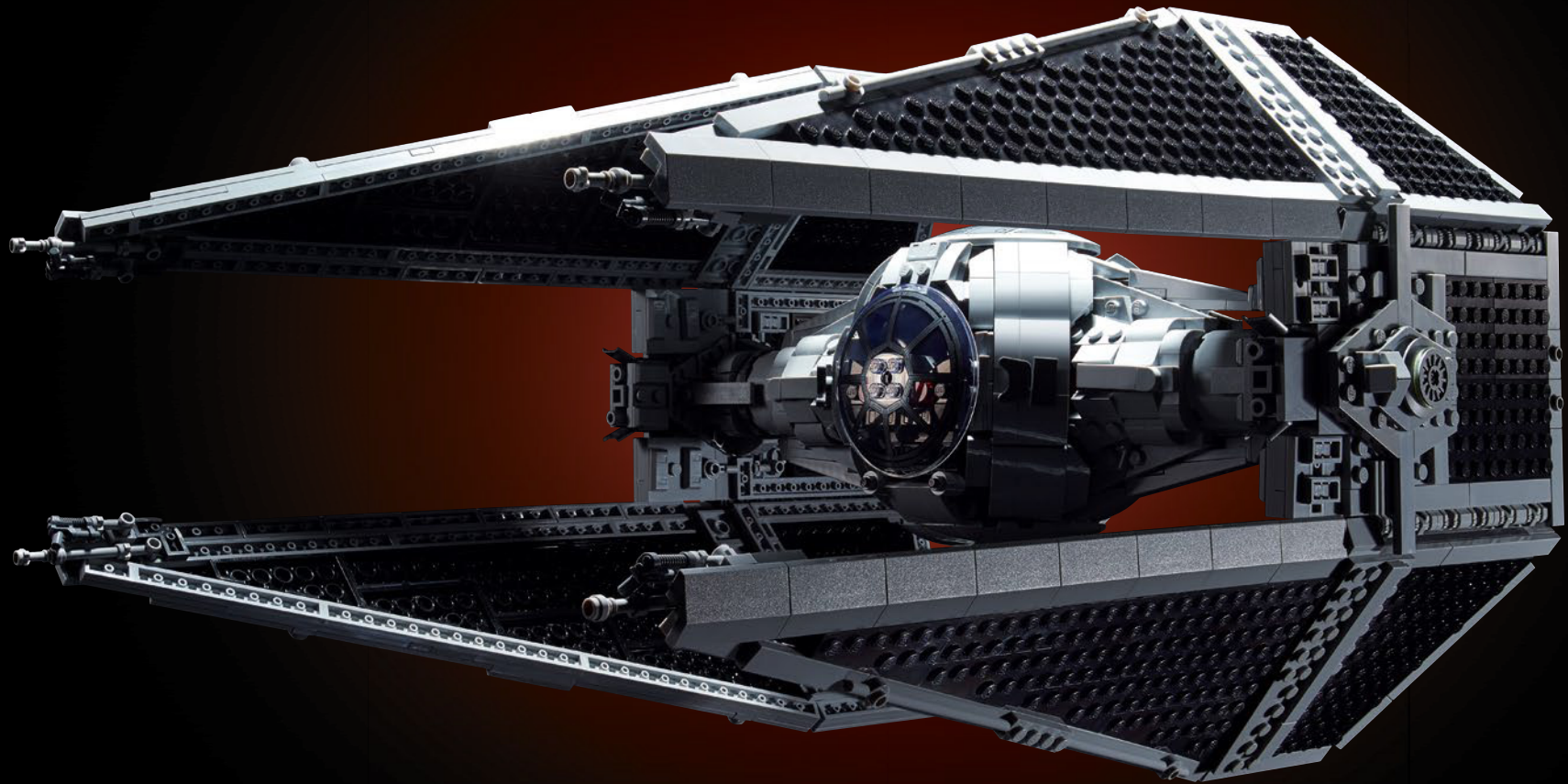



STAR  
WARS

TIE Interceptor

Manufacturer:  
Affiliation:  
Length:  
Max Acceleration:  
Engine:  
Weapons:

Sienar Fleet Systems  
Galactic Empire  
72 m  
4,040 G  
SF5 P-25.4 turbo jet engine  
4 L-17.3 laser cannons





# INNOVATIVE IMPERIAL DESIGN

- Behind the transparisteel viewport is a fully equipped cockpit with features characteristic of the TIE fighter-class starships
- Open the top hatch to see the pilot's seat
- Detailed octagonal engine section with inside greebling
- Unique new LEGO® building techniques were used to achieve a more authentic replica of the sphere-shaped exterior, compared to previous LEGO TIE fighters
- Train wheel elements in a new grey colour represent the wing struts
- Angled hinges and 32 new 2x4 sloped elements without studs were used to frame the bent-wing solar wings
- The two shovels representing the advanced targeting sensors were also featured in the original UCS model from 2000 – the first time a special element was used for a purpose other than its original use
- Whereas TIE fighters have twin chin-mounted lasers, the TIE Interceptor's four wingtip blaster cannons are attached to its solar arrays
- The rear of the wings is densely constructed, and the wingtips are slightly hollower to ensure optimal weight distribution

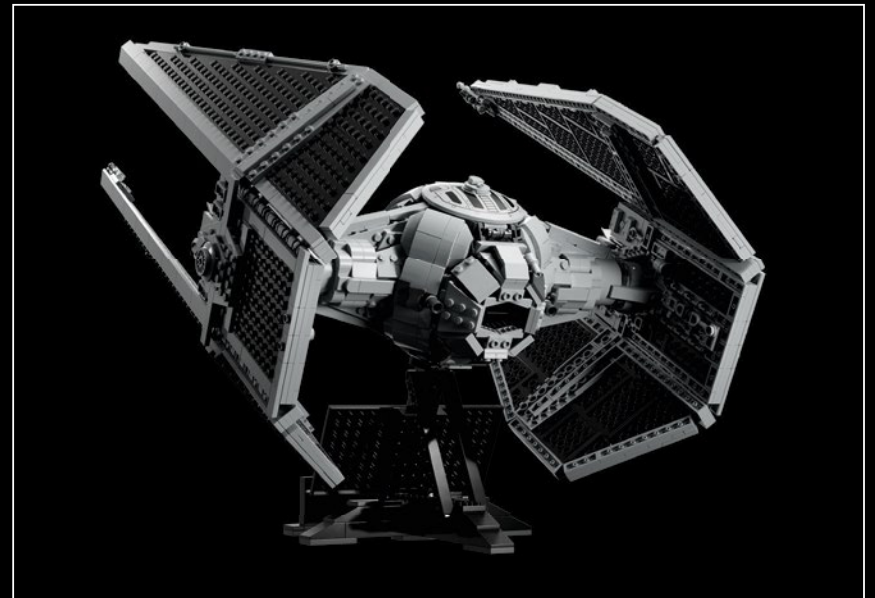





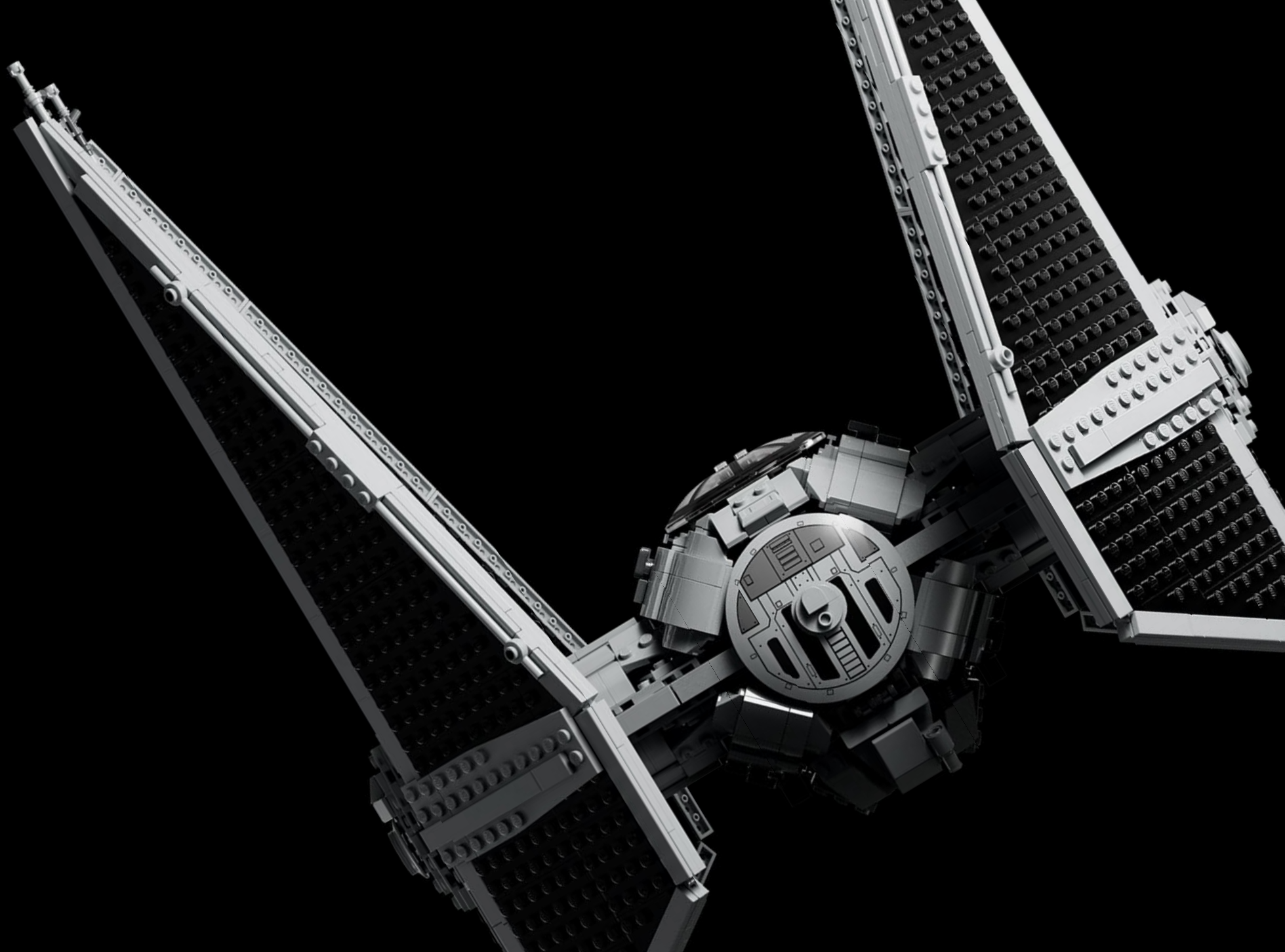



# Join the 25<sup>th</sup> Anniversary at [LEGO.com/LSW-25](http://LEGO.com/LSW-25)



# STAR WARS

© & ™ Lucasfilm Ltd.

25 years of LEGO® Star Wars™  
25 Jahre LEGO® Star Wars™  
25 ans de LEGO® Star Wars™  
25 anni di LEGO® Star Wars™

Join the 25<sup>th</sup> Anniversary at  
[LEGO.com/LSW-25](http://LEGO.com/LSW-25)  
Feiere mit uns das 25-jährige Jubiläum  
auf [LEGO.com/LSW-25](http://LEGO.com/LSW-25)  
Venez célébrer notre 25<sup>e</sup> anniversaire  
sur [LEGO.com/LSW-25](http://LEGO.com/LSW-25)  
Festeggia con noi il 25<sup>o</sup> anniversario su  
[LEGO.it/LSW-25](http://LEGO.it/LSW-25)

25 años de LEGO® Star Wars™  
25 anos de LEGO® Star Wars™  
乐高®星球大战™ 25周年  
25 lat LEGO® Star Wars™

Participa en el 25 aniversario en  
[LEGO.com/LSW-25](http://LEGO.com/LSW-25)  
Junte-se ao 25.º Aniversário em  
[LEGO.com/LSW-25](http://LEGO.com/LSW-25)  
访问 [LEGO.com/LSW-25](http://LEGO.com/LSW-25),  
参加 25 周年庆典  
Świętuj z nami 25. rocznicę na stronie  
[LEGO.pl/LSW-25](http://LEGO.pl/LSW-25)

25 let LEGO® Star Wars™  
25 rokov LEGO® Star Wars™  
25 évnyi LEGO® Star Wars™  
25 de ani de LEGO® Star Wars™

Oslavte s námi 25. výročí na  
[LEGO.com/LSW-25](http://LEGO.com/LSW-25)  
Osláve s nami 25. výročie na  
[LEGO.com/LSW-25](http://LEGO.com/LSW-25)  
Csatlakozz a 25. évfordulóhoz a  
[LEGO.hu/LSW-25](http://LEGO.hu/LSW-25) oldalon!  
Alătură-te celei de-a 25-a aniversări  
pe [LEGO.com/LSW-25](http://LEGO.com/LSW-25)

25 години LEGO® Star Wars™  
LEGO® Star Wars™ 25 gadi  
25 aastat LEGO® Star Wars™  
25 metai LEGO® Star Wars™

Присъединете се към 25тата  
годишнина на [LEGO.com/LSW-25](http://LEGO.com/LSW-25)  
Pievienojies 25. jubilejai vietnē  
[LEGO.com/LSW-25](http://LEGO.com/LSW-25)  
Liitu 25.th aastapäevaga aadressil  
[LEGO.com/LSW-25](http://LEGO.com/LSW-25)  
Švęskime 25-ąją sukaktį drauge  
svetainėje [LEGO.com/LSW-25](http://LEGO.com/LSW-25)



# The ultimate insider's guide

Deluxe book package with collectible prints

[LEGO.com/LSW25Book](http://LEGO.com/LSW25Book)



NEW  
JULY



25 years of LEGO® Star Wars™  
25 Jahre LEGO® Star Wars™  
25 ans de LEGO® Star Wars™  
25 anni di LEGO® Star Wars™  
25 años de LEGO® Star Wars™  
25 anos de LEGO® Star Wars™  
乐高® 星球大战™ 25 周年  
25 lat LEGO® Star Wars™  
25 let LEGO® Star Wars™  
25 rokov LEGO® Star Wars™  
25 évnyi LEGO® Star Wars™  
25 de ani de LEGO® Star Wars™  
25 години LEGO® Star Wars™  
LEGO® Star Wars™ 25 gadi  
25 aastat LEGO® Star Wars™  
25 metai LEGO® Star Wars™

# STAR WARS

© & TM Lucasfilm Ltd.

The ultimate insider's guide | Das ultimative Insider-Handbuch | Le guide ultime des Insiders | La guida definitiva per i fan | La guía definitiva para auténticos entusiastas | O derradeiro guía para iniciantes | 终极内部指南 | Wspólny przewodnik dla wtajemniczonych | Nepřekonatelná příručka pro zasvěcené | Nepřekonatelná příručka pre zasvätených | Útműtató bennfentes rajongóknak | Ghidul complet al fanilor | Полгод отвѣты | Labākais iekšējās informācijas ceļvedis | Ūlim Insideri juhend | Įspūdingas pažintinis vadovas

Deluxe book package with collectible prints | Deluxe-Mappe mit Grafiken zum Sammeln | Pack Deluxe avec tirages collector | Confezione con libro deluxe e stampe collezionabili | Edición de lujo en estuche con láminas coleccionables | Pack de livros deluxe com impressões colecionáveis | 豪华图书套装, 带有值得收藏的图片 | Luksusowy album z kolekcjonerskimi grafikami | Exkluzivní knižní balení se sběratelskými plakáty | Exkluzívne knižné balenie so zberateľskými plagátmi | Exkluzív könyvcsomag gyűjthető nyomatokkal | Carte de lux cu pagini de colecție | Луксозен пакет – книга и колекционерски принтове | Luksusa grāmatas komplekts ar kolecionējamām izdrukām | Luksuslik raamatupakett koos kogutavate trükistega | Išskirtinės knygos pakuotė su kolekciniais spaudiniais

New July | Neu ab Juli | Nouveauté juillet | Novità luglio | Lanzamiento en julio | Novidade Julho | 七月新品 | Nowość lipiec | Vyjde v červenci | Vyjde v júli | Júliusi újdonáság | Nou din luna iulie | Ново юли | Jaunums jūlijā | Uued tooted on saadaval juulist | Liepos mėn. naujiena

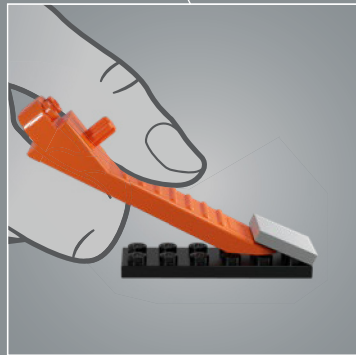
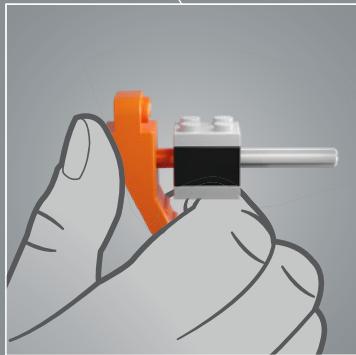
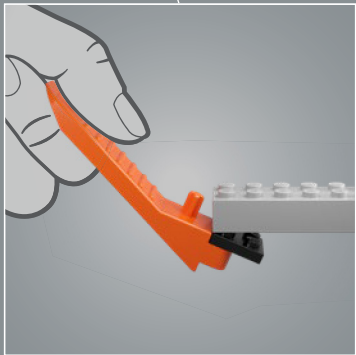
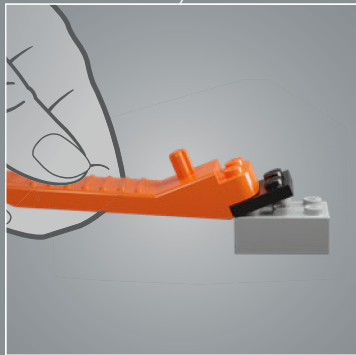
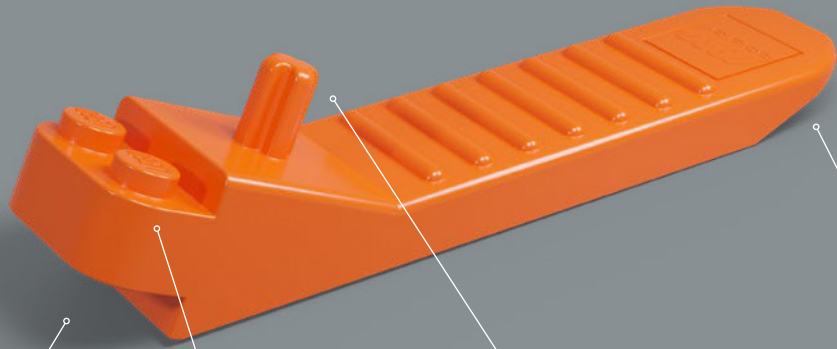





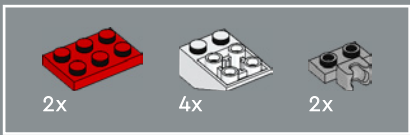

3

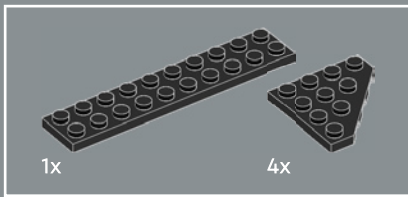
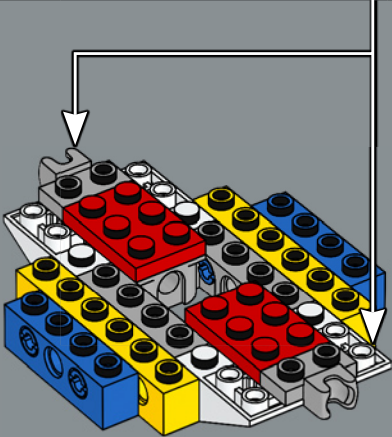
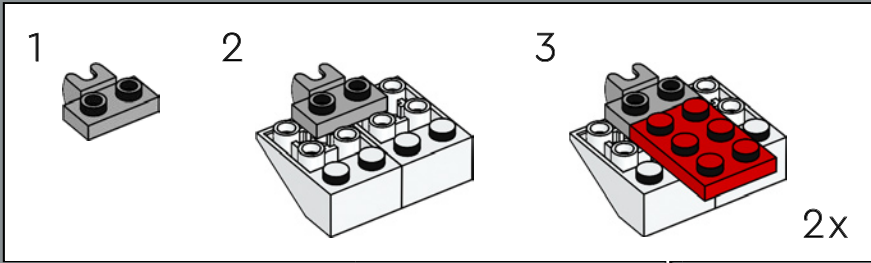

4

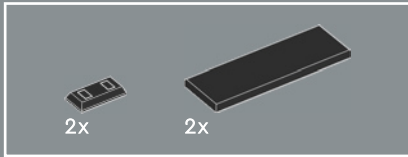
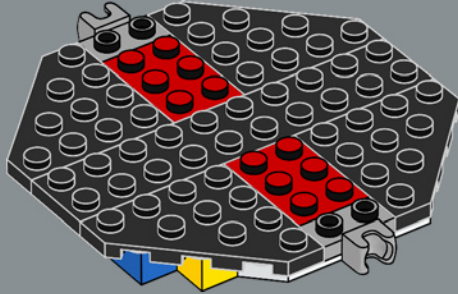

5

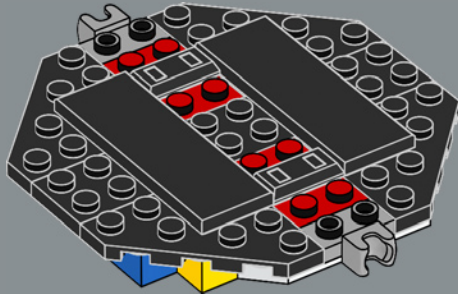





6

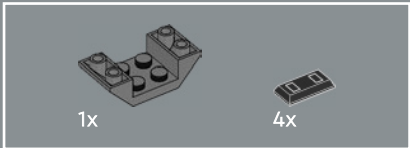
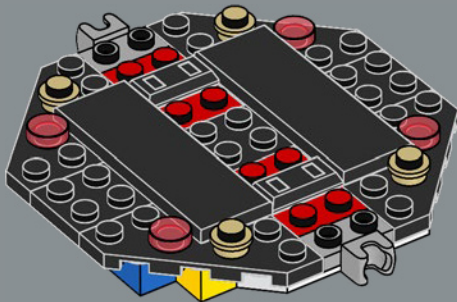

7

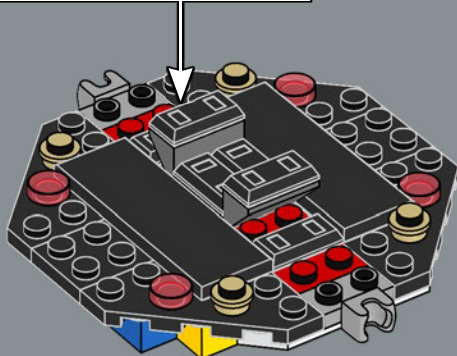
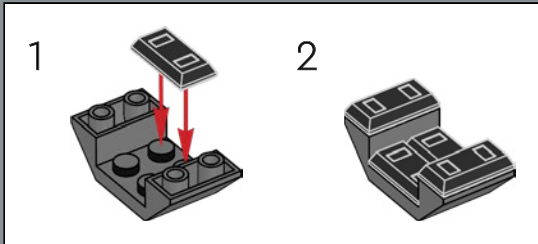

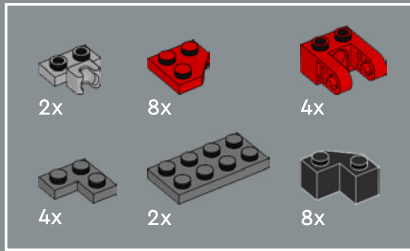
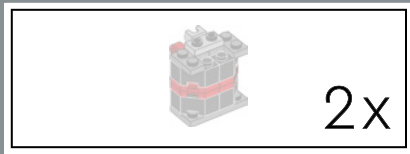

8

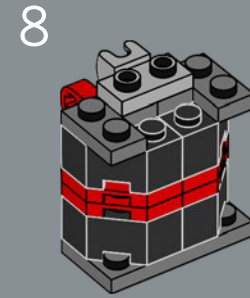
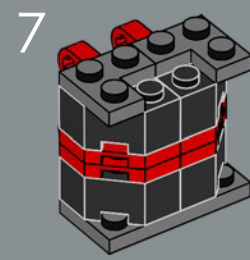
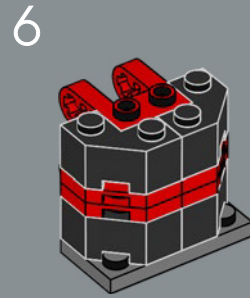
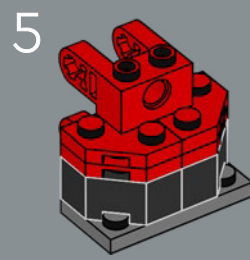
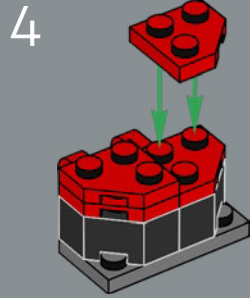
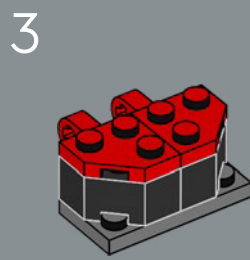
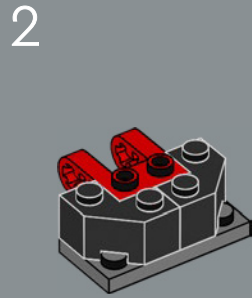
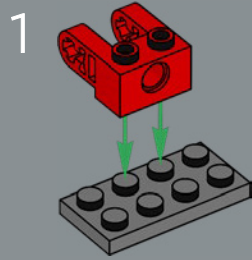

2x

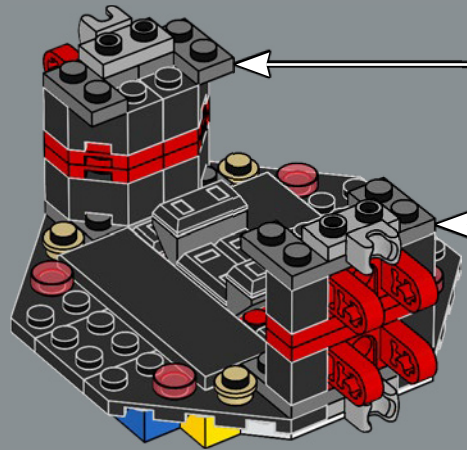



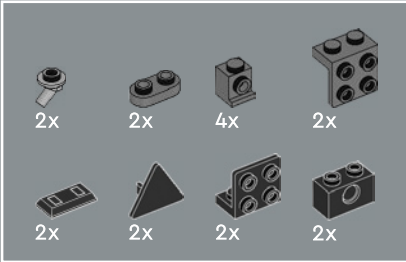
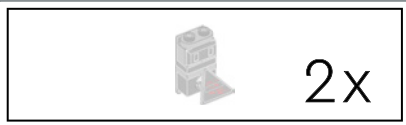

9

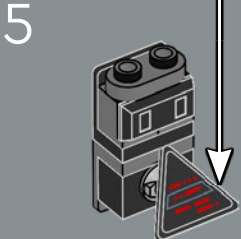
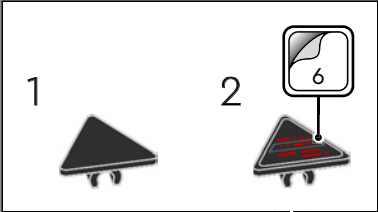
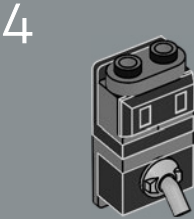
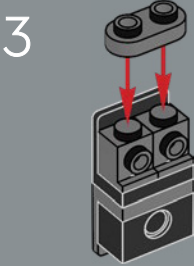
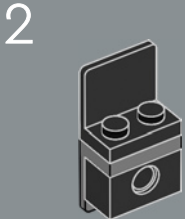
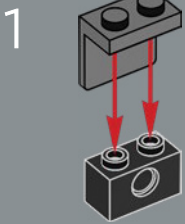

2x

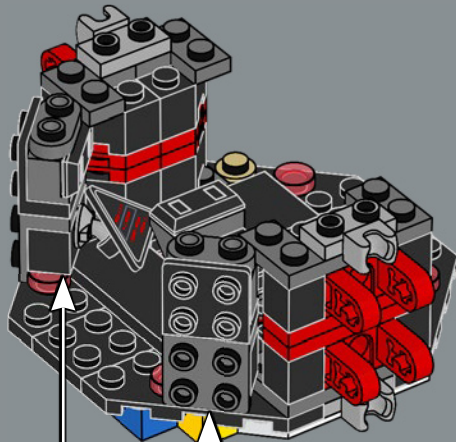



2x

10

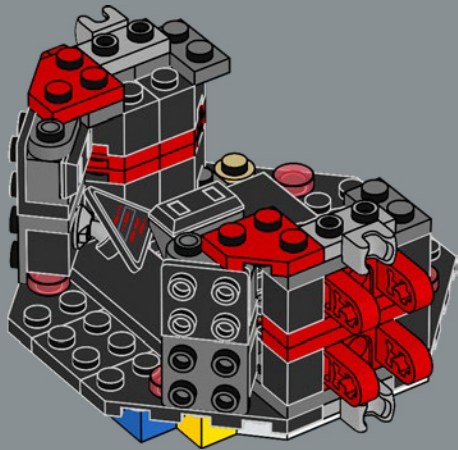

1x



1x



1x



1x

11

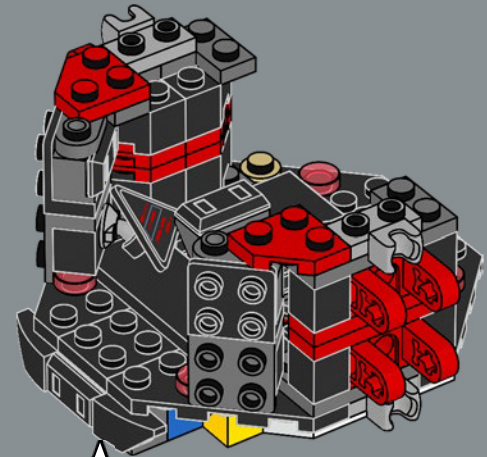

1

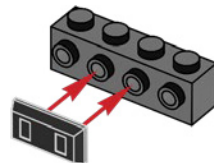

2

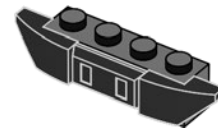



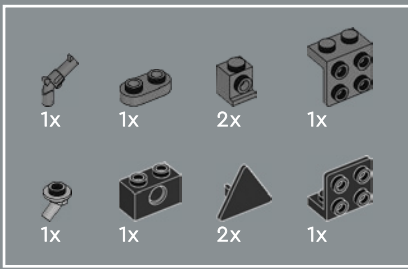

12

1

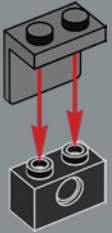

2

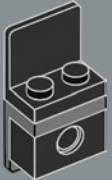

3

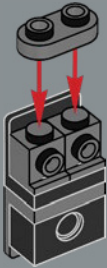

4

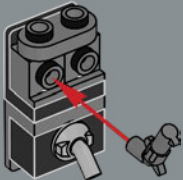

5



6

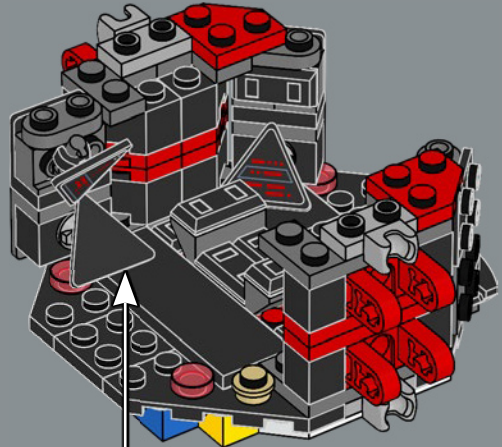
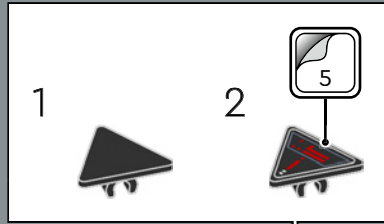

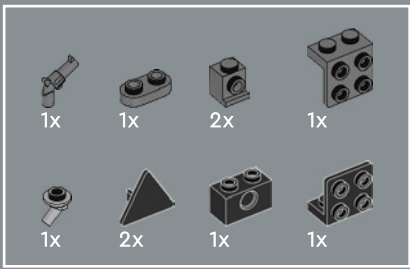

# 13

1

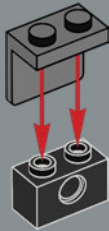

2



3

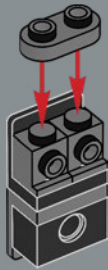

4

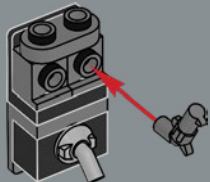

5

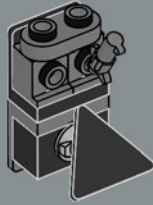

6

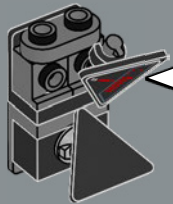
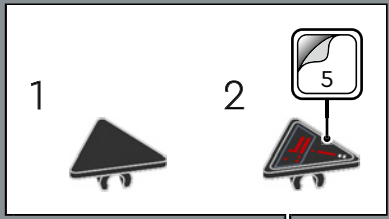



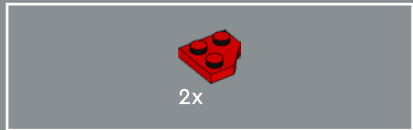

14

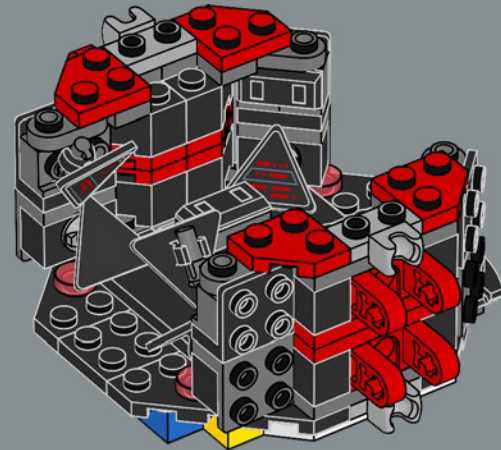
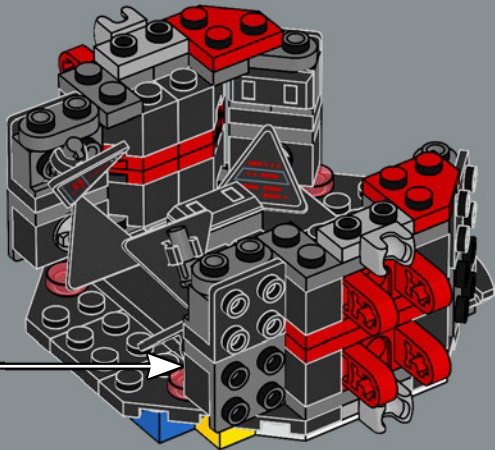

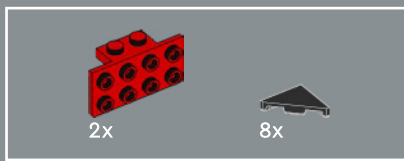

15

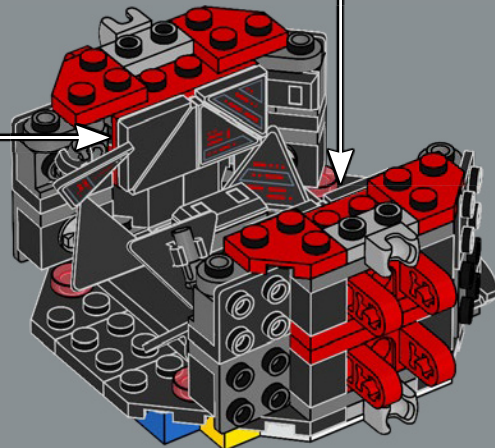
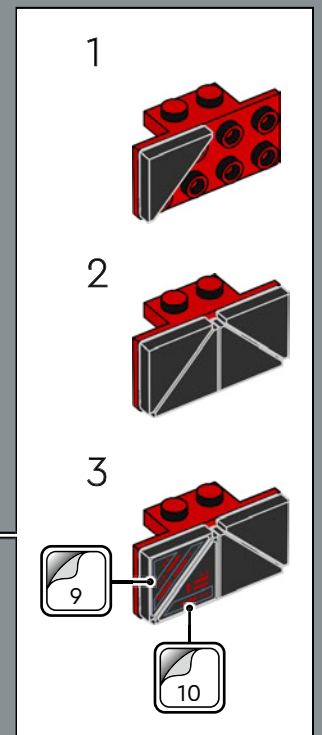
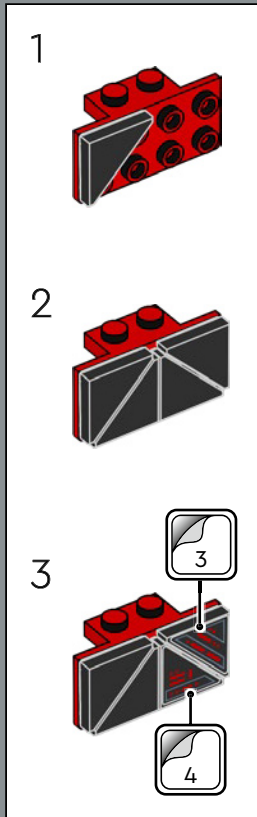



16

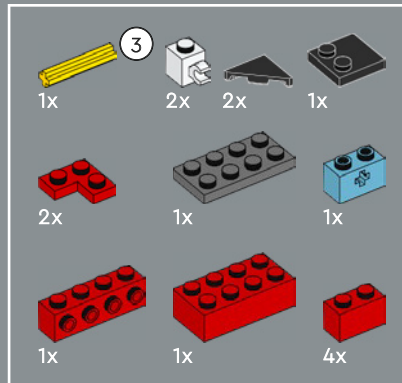
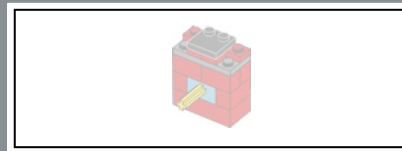
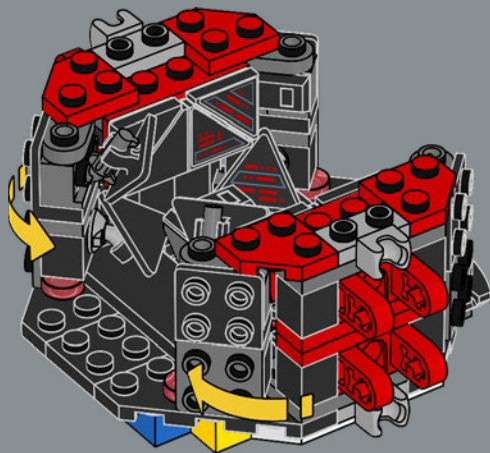

17

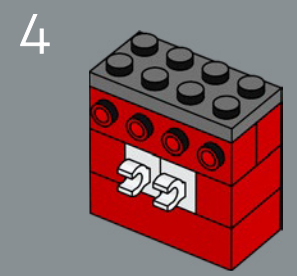
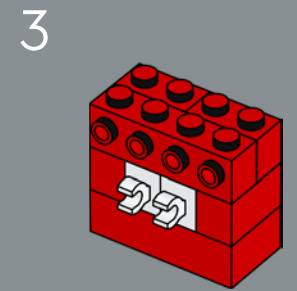
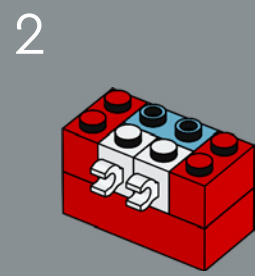
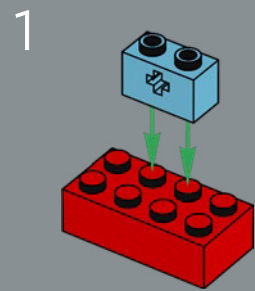

5

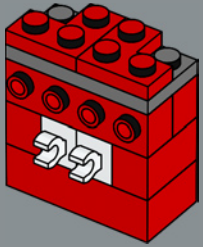

7

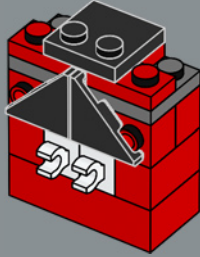

6

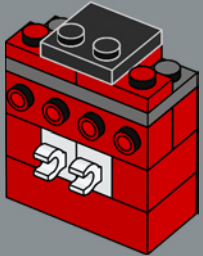

8

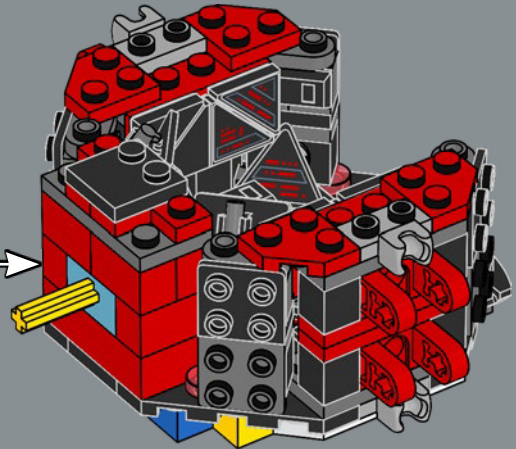
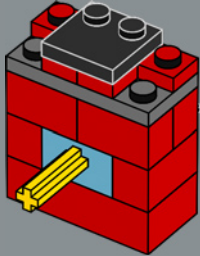

 3 1:1

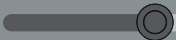



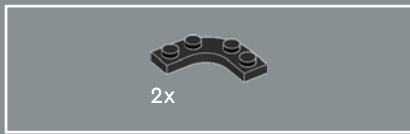

18

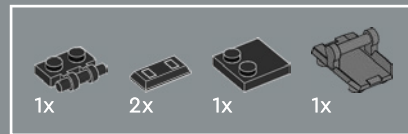
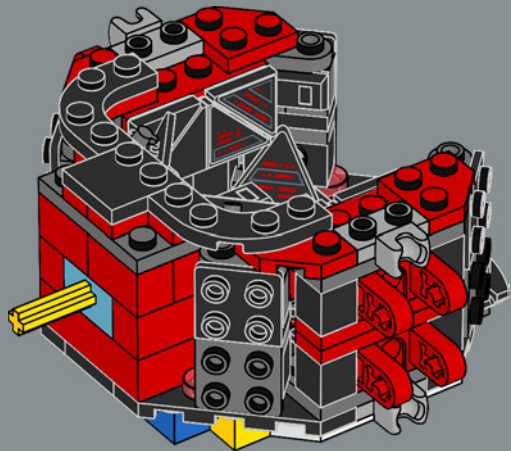

19

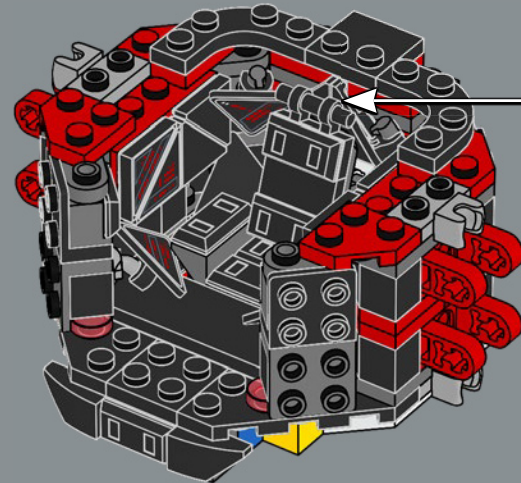
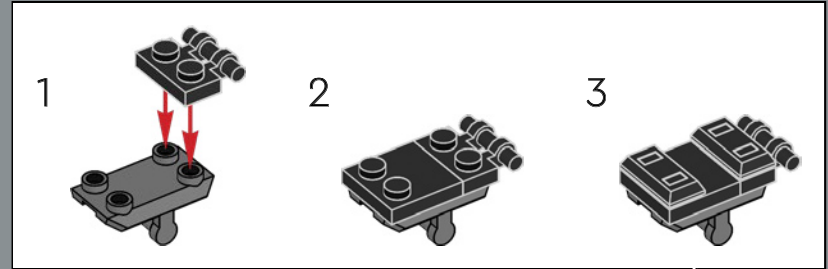



20

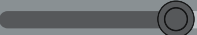
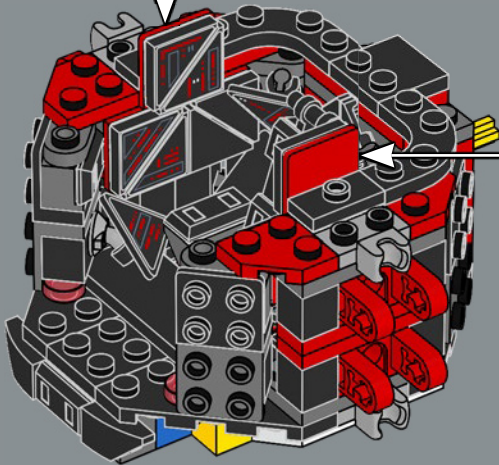
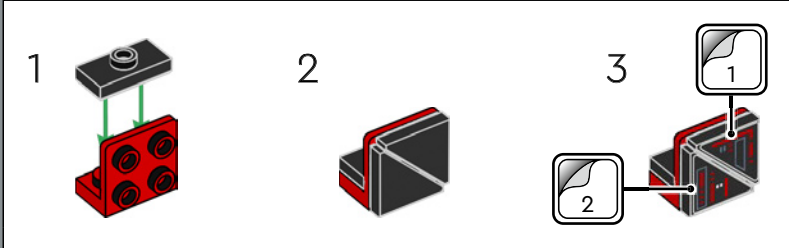
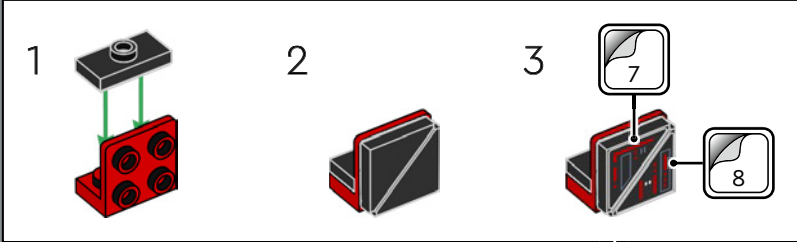



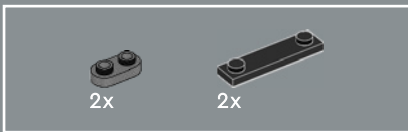

21

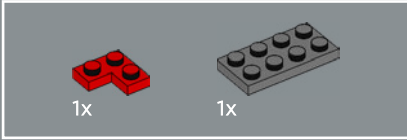
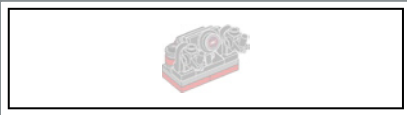
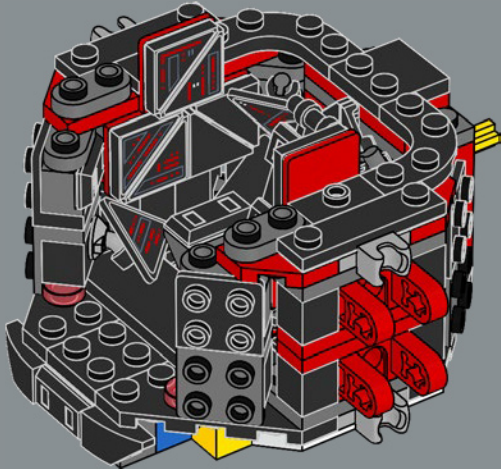

22

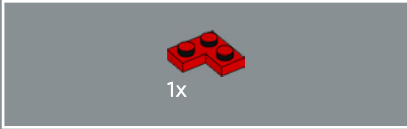
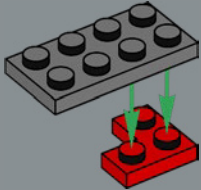

23

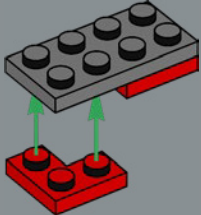



1x

24

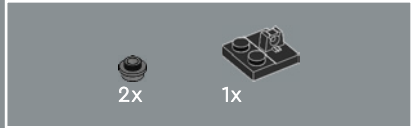

25

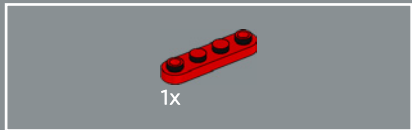
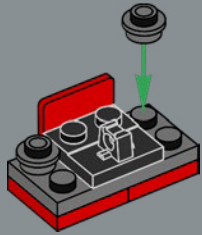

26



1x



2x

27

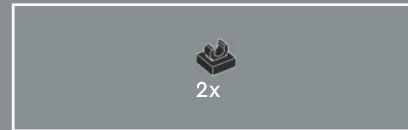
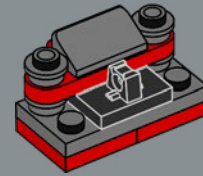

28

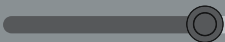
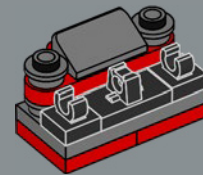



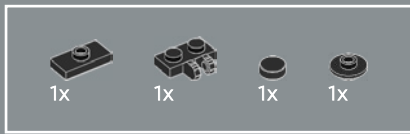

29

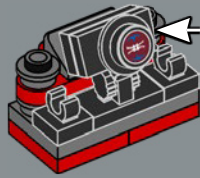
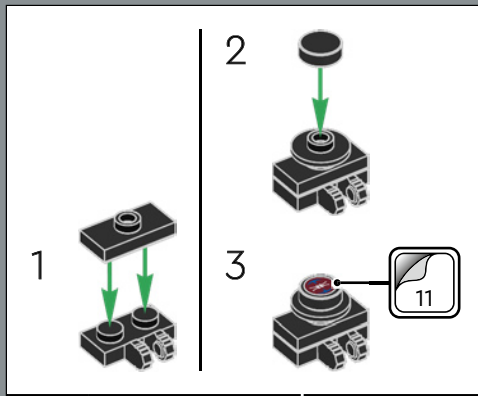

30

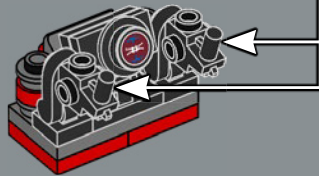
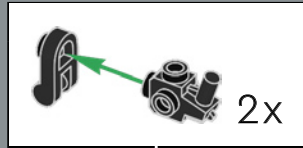

31

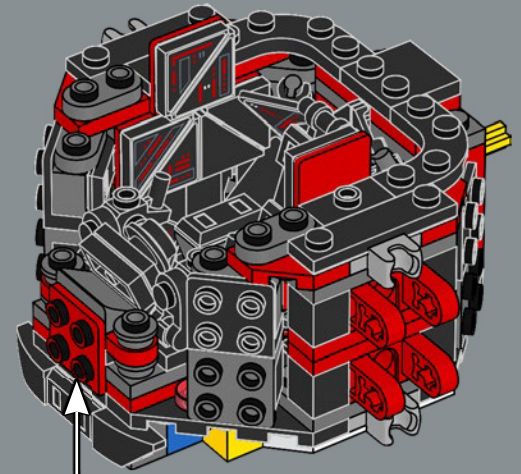

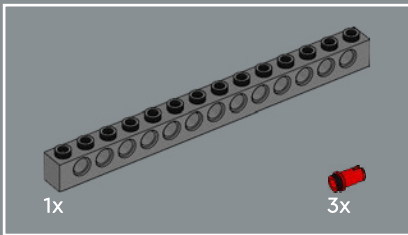
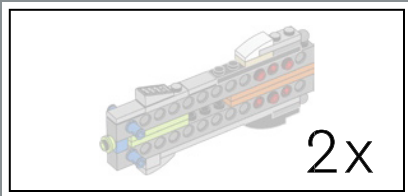

32

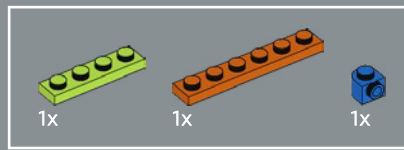
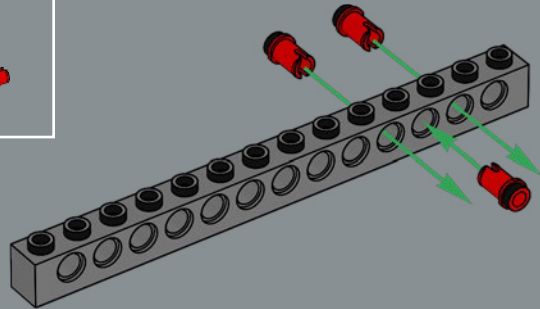

33

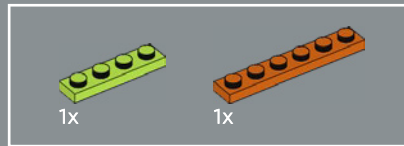
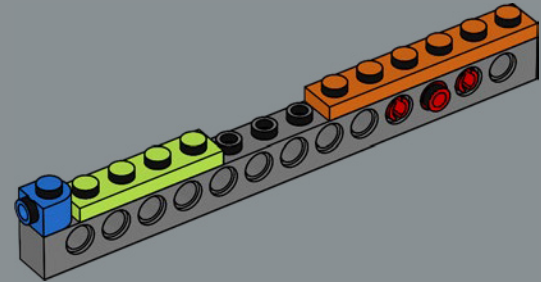

34

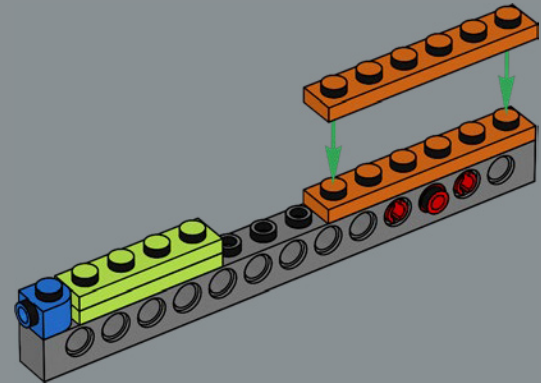

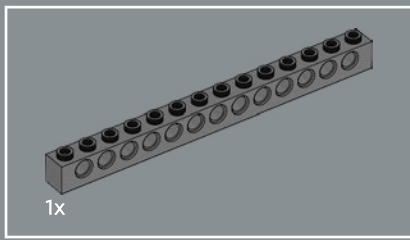

35

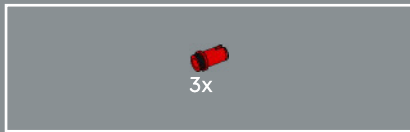
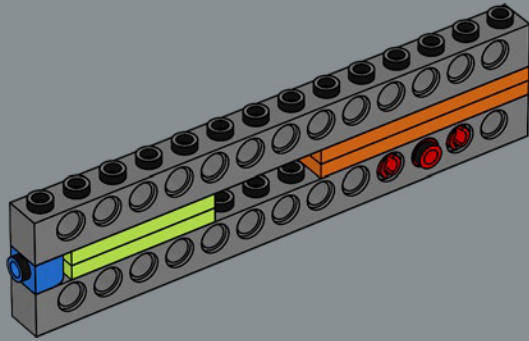

36

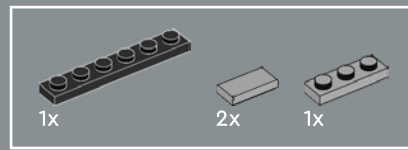
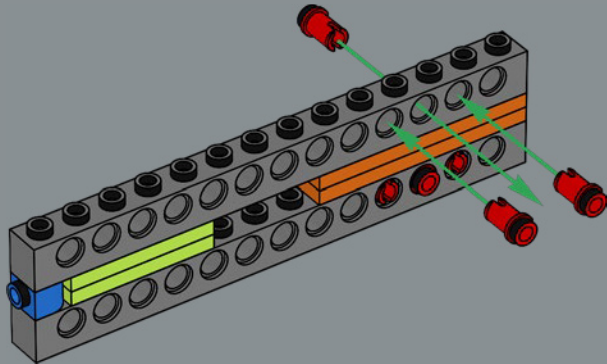

37

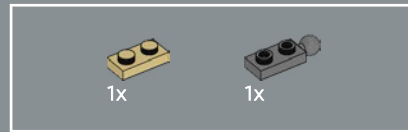
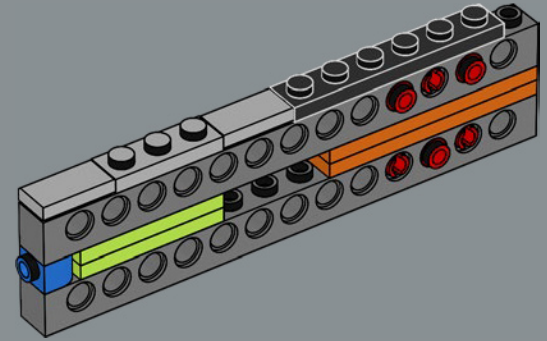

38

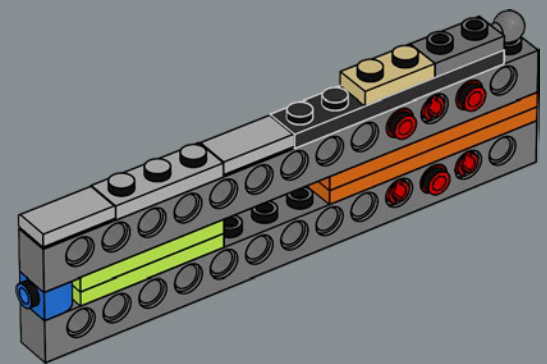



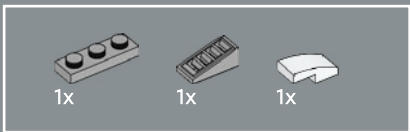

39

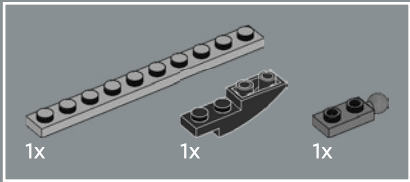
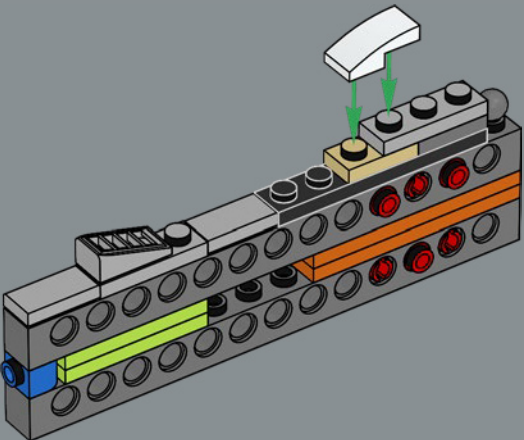

40

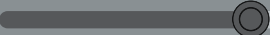
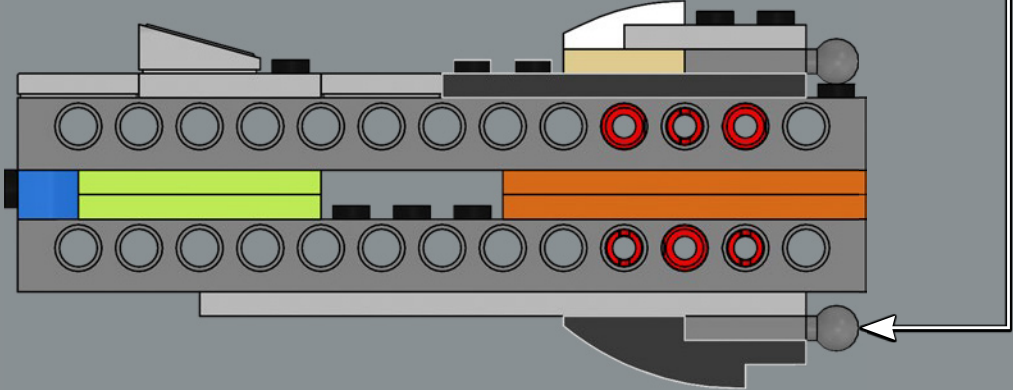
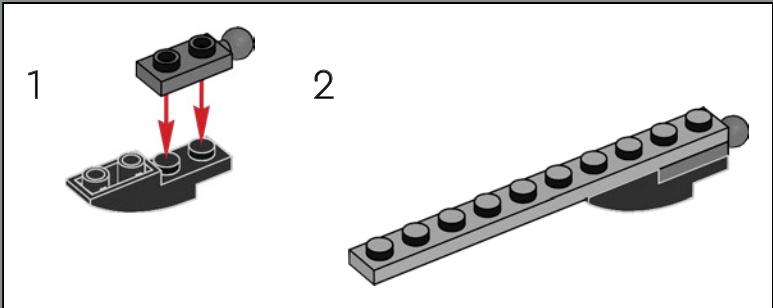

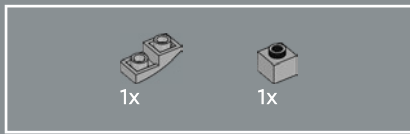

41

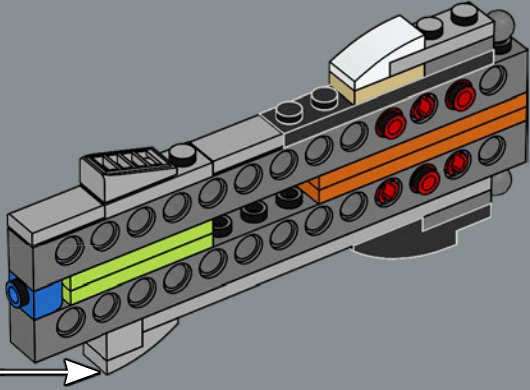
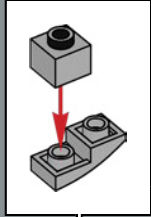

42

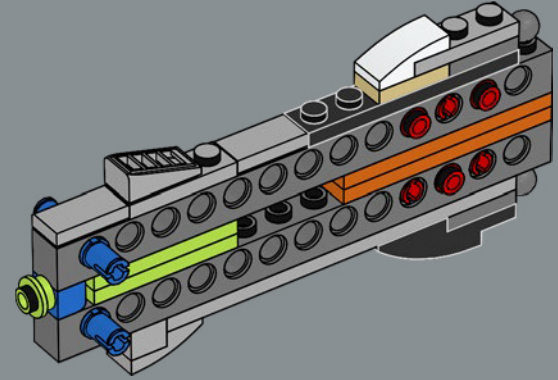

2x

43

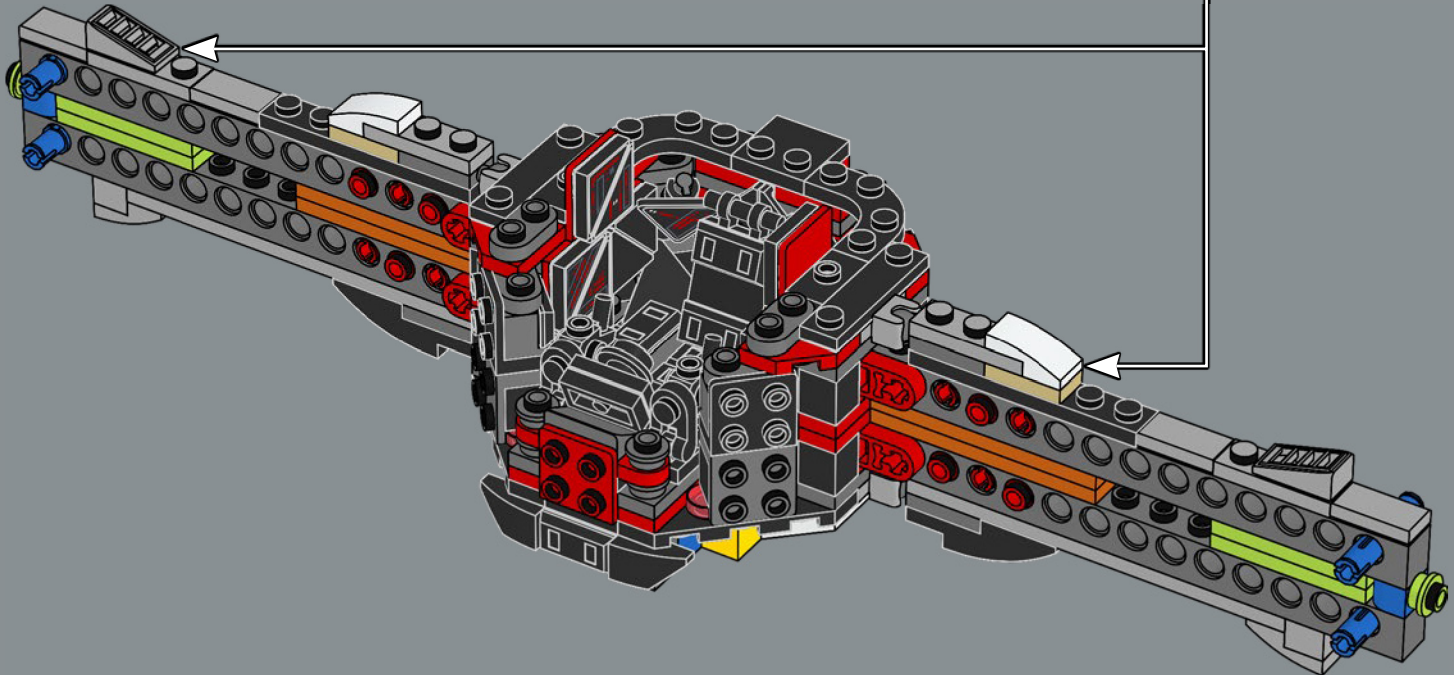

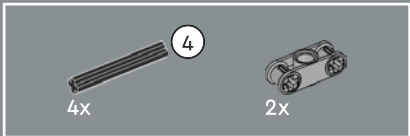

44

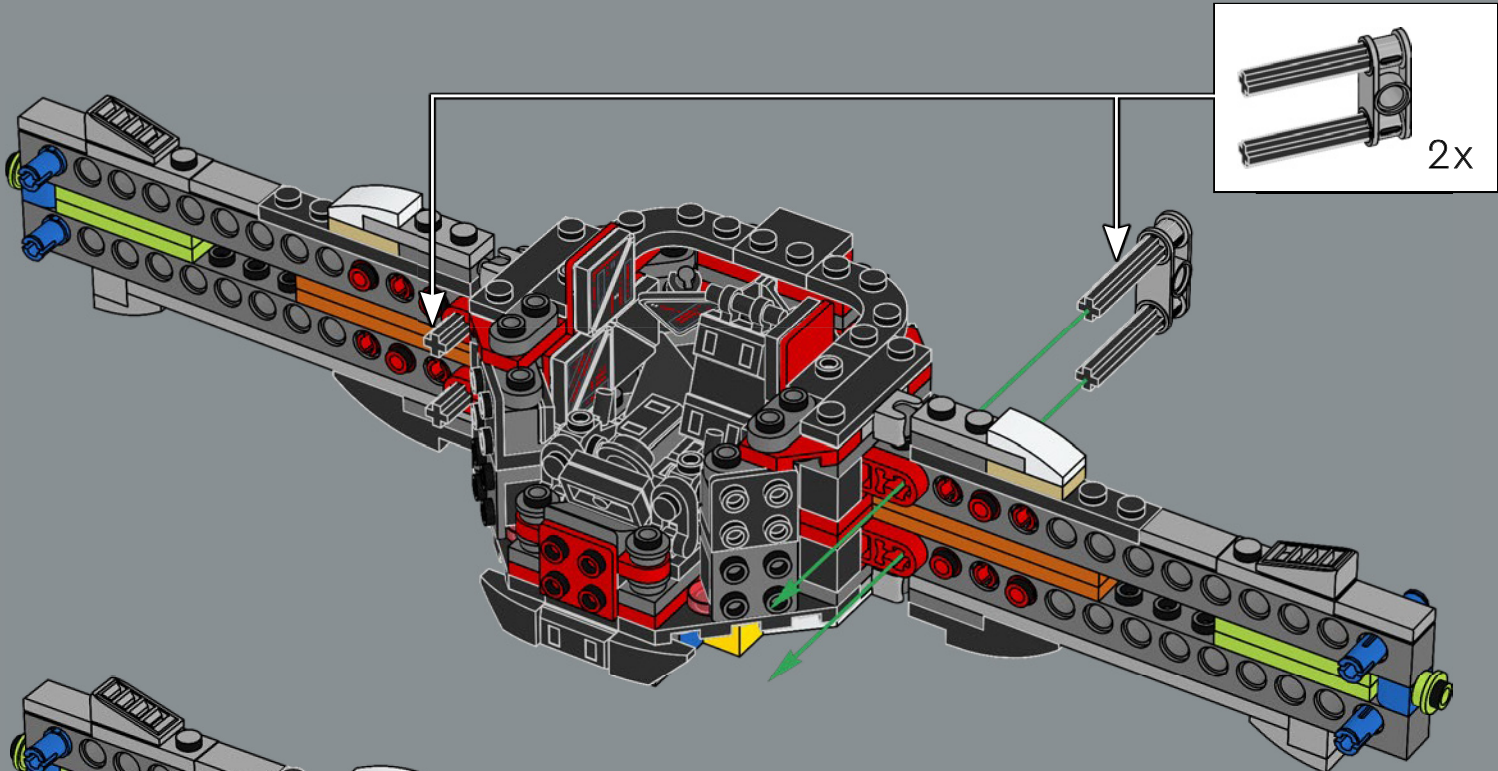

45

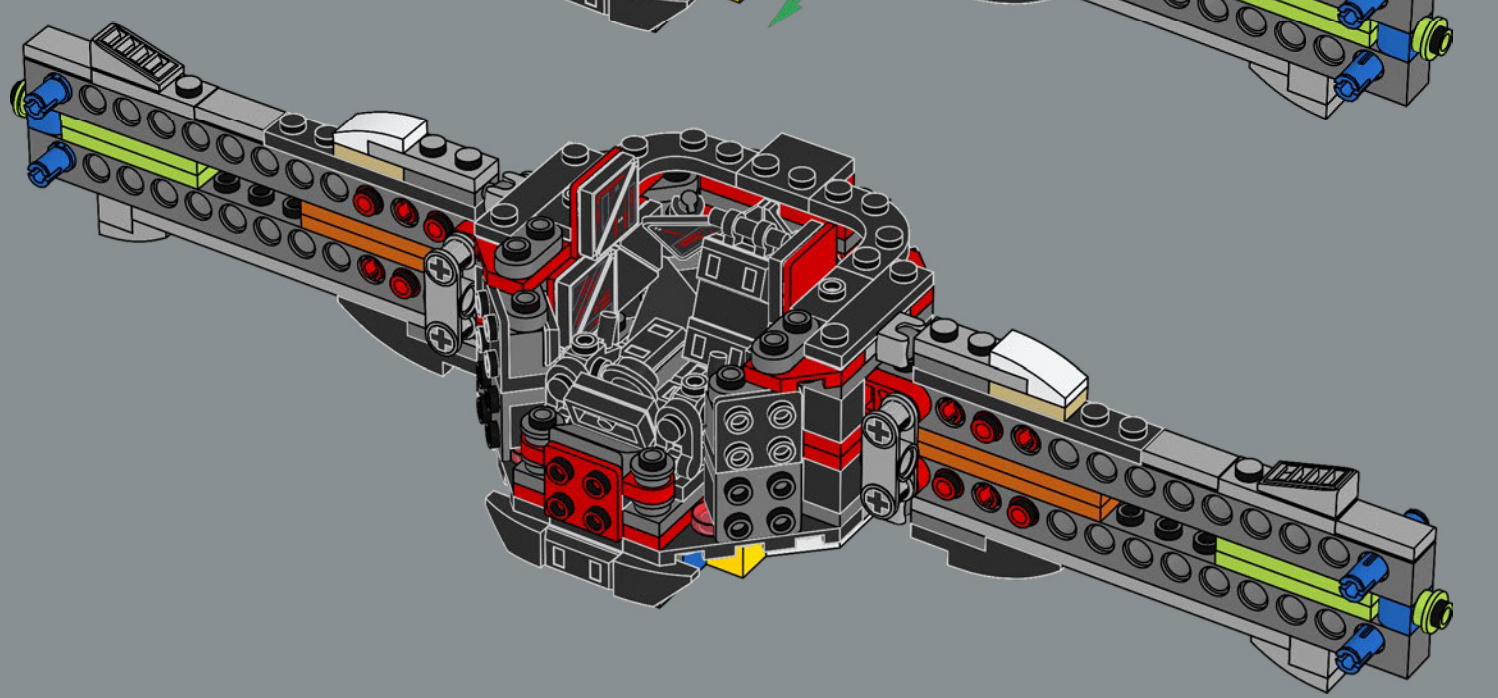



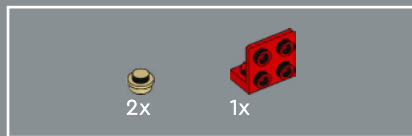

46

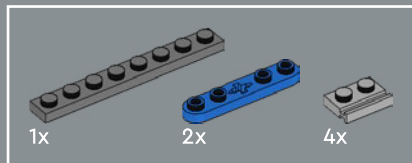
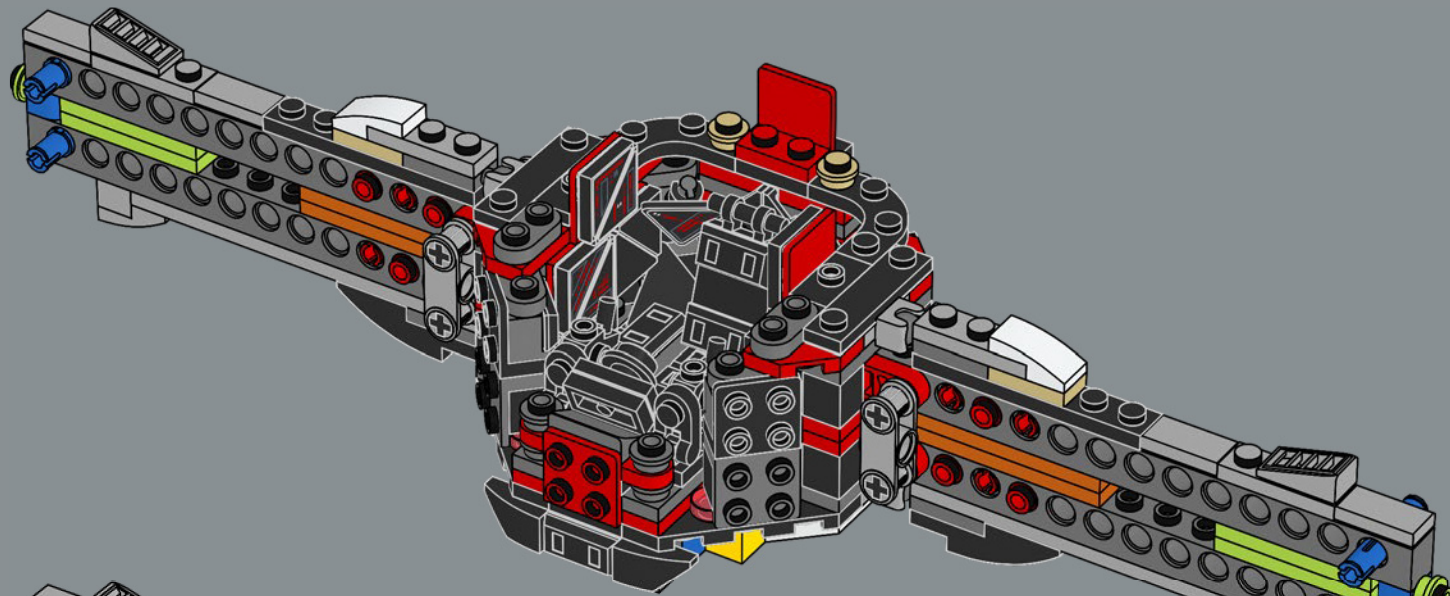

47

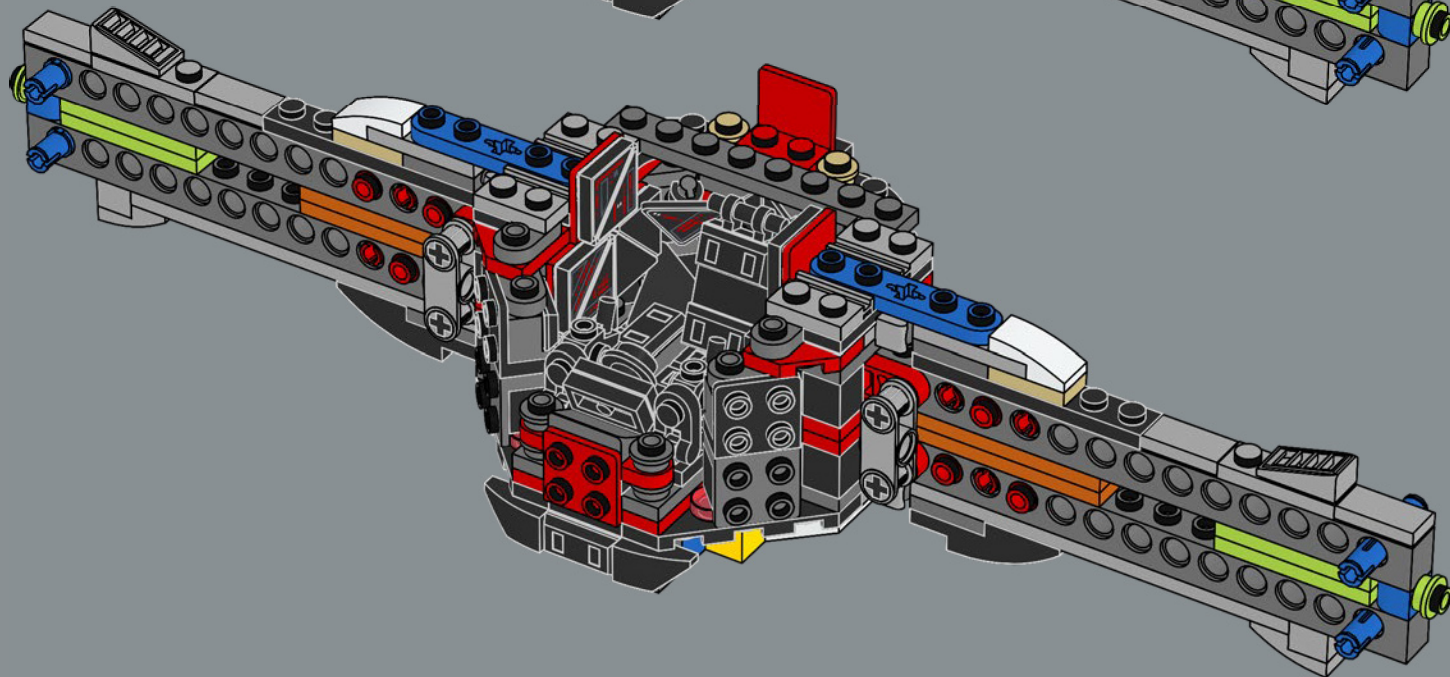



48

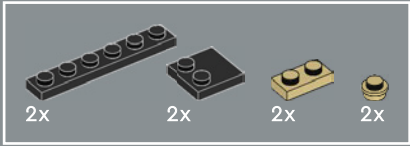
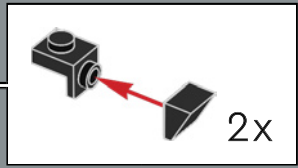
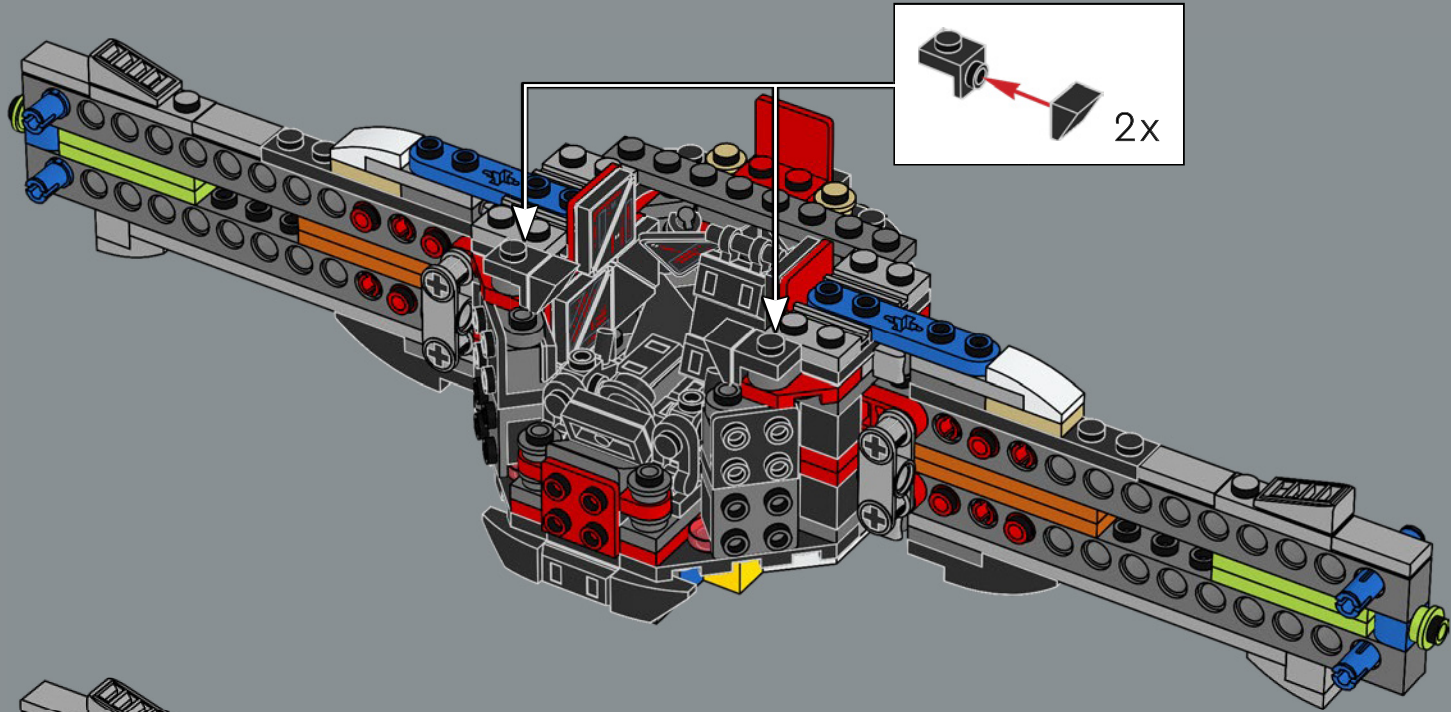

49

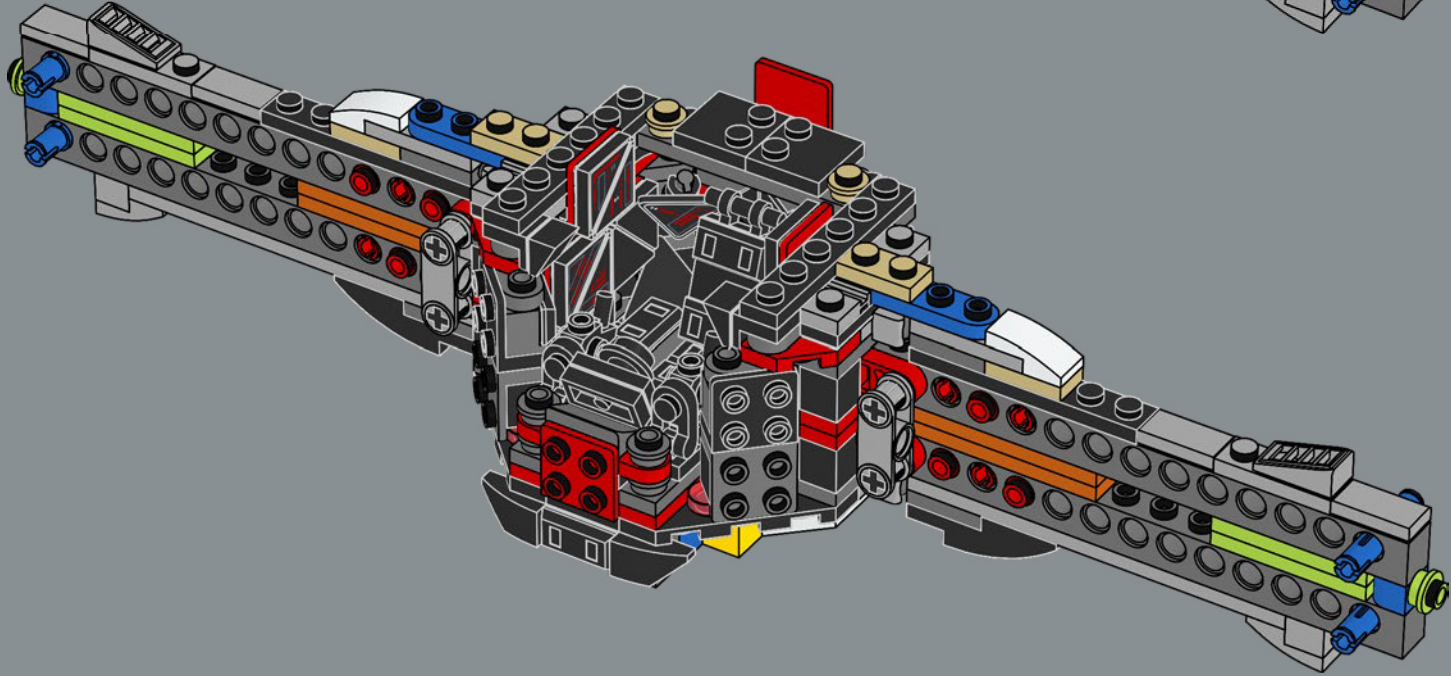



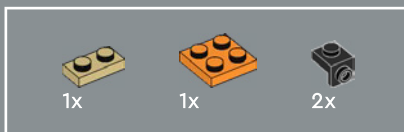

50

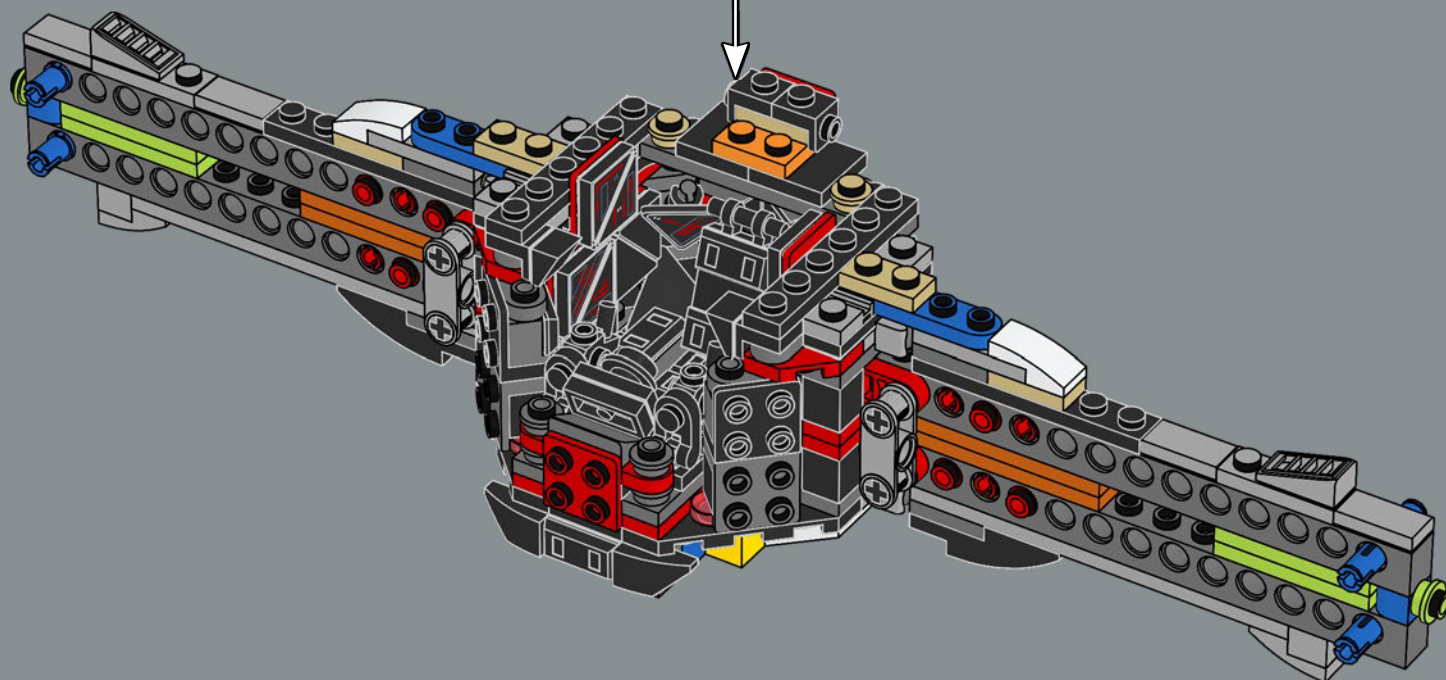
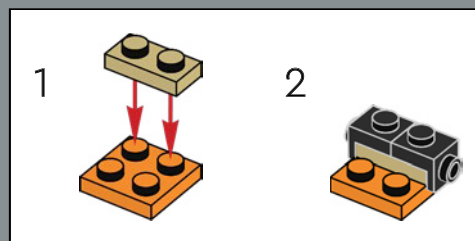



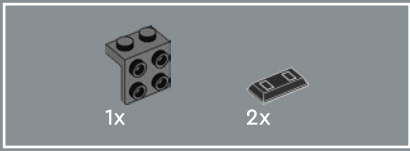

51

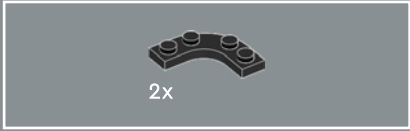
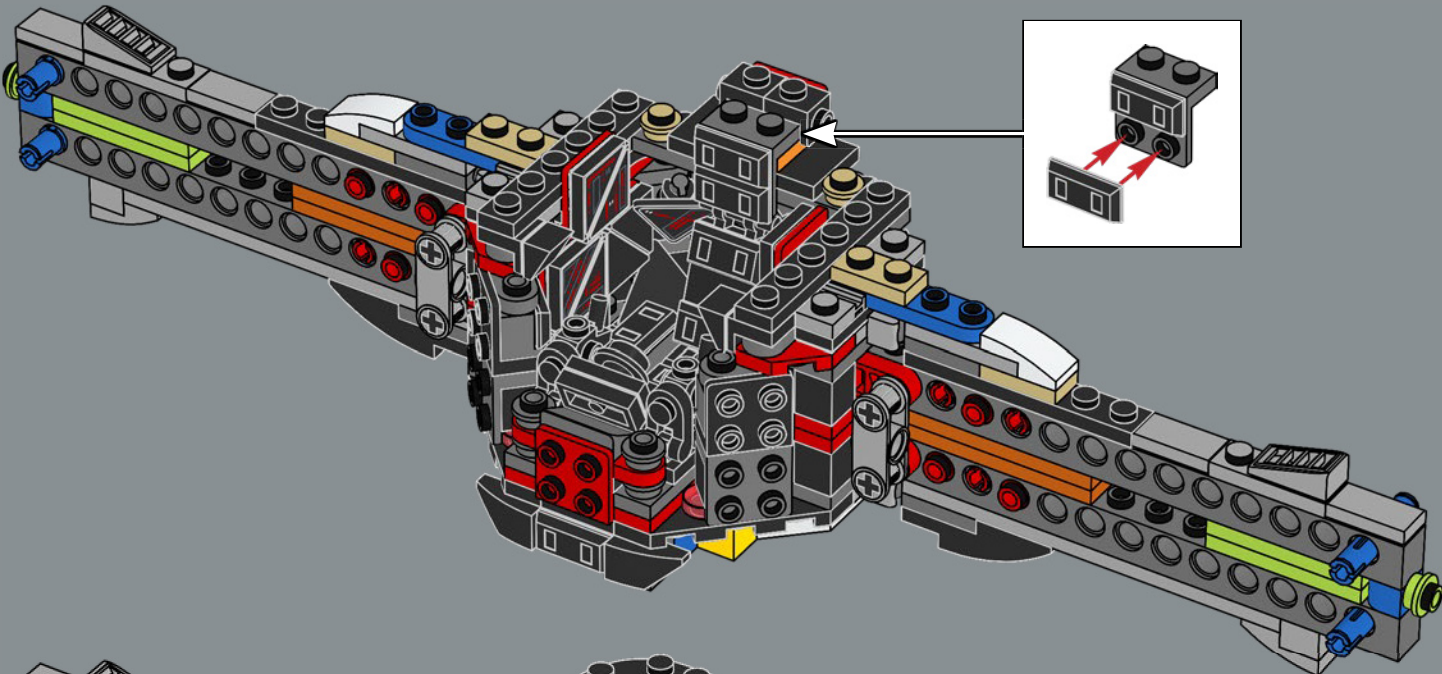

52

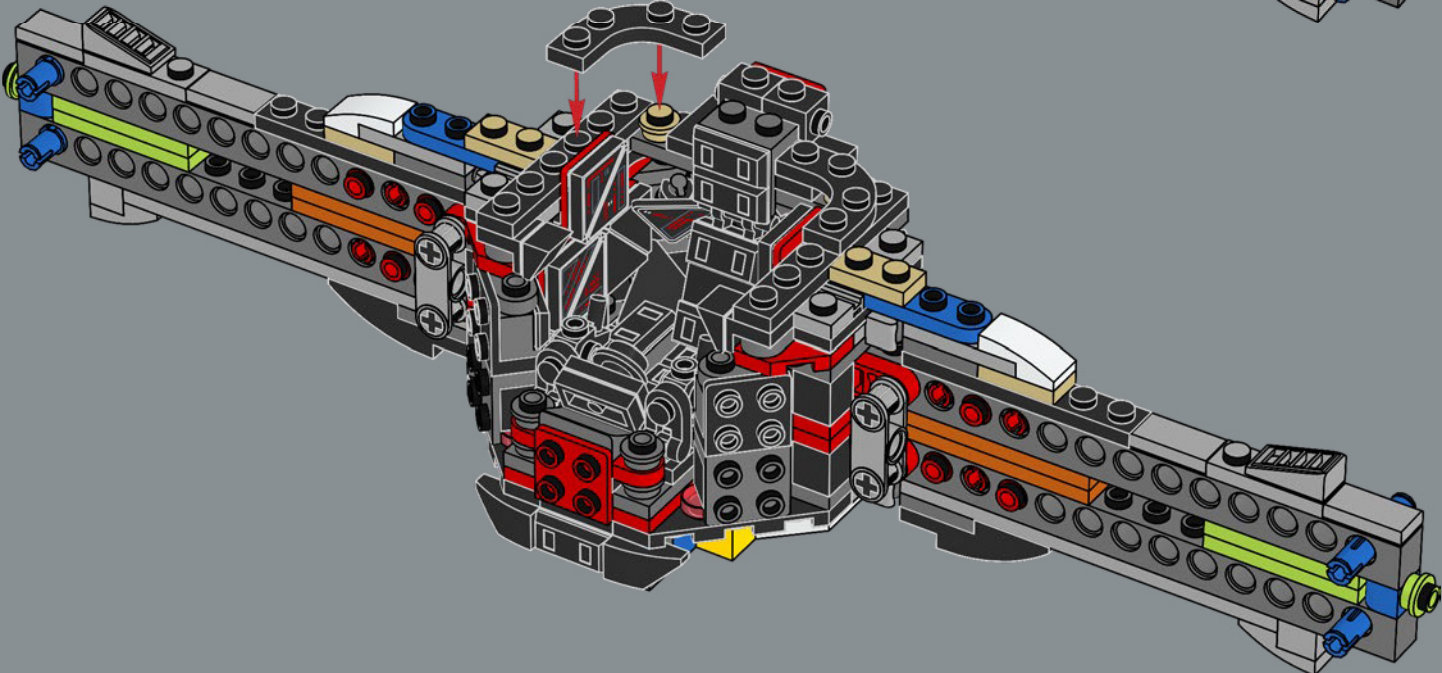



53

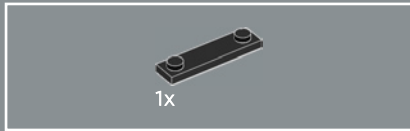
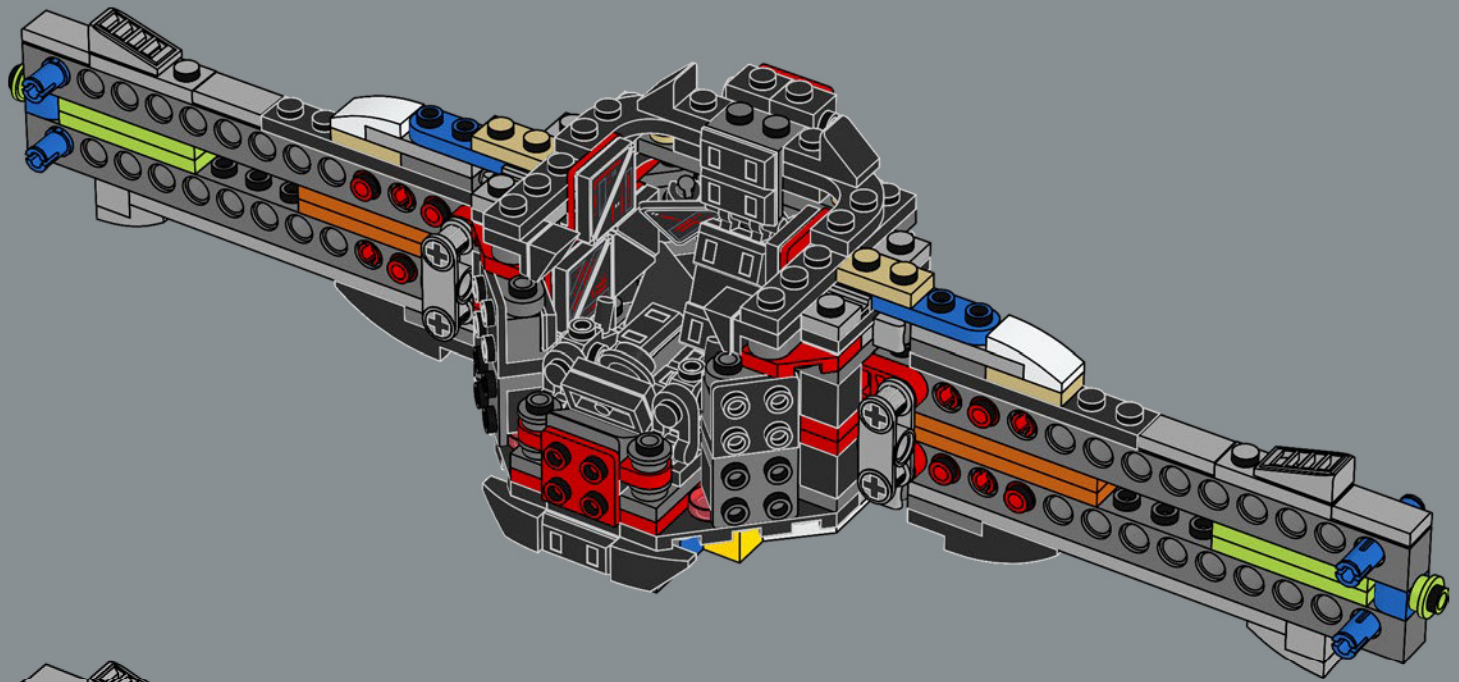

54

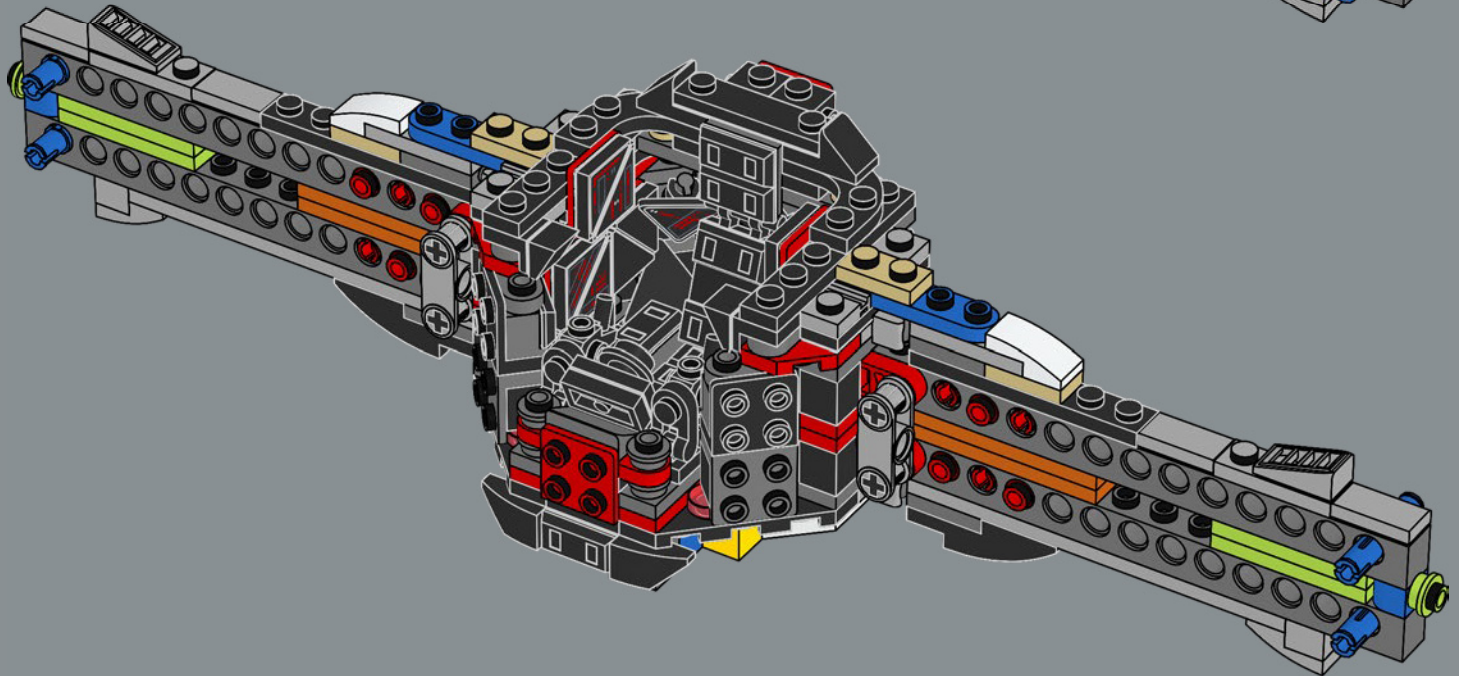



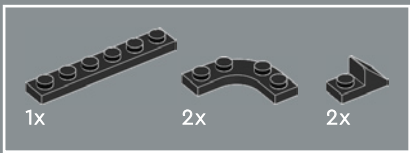

55

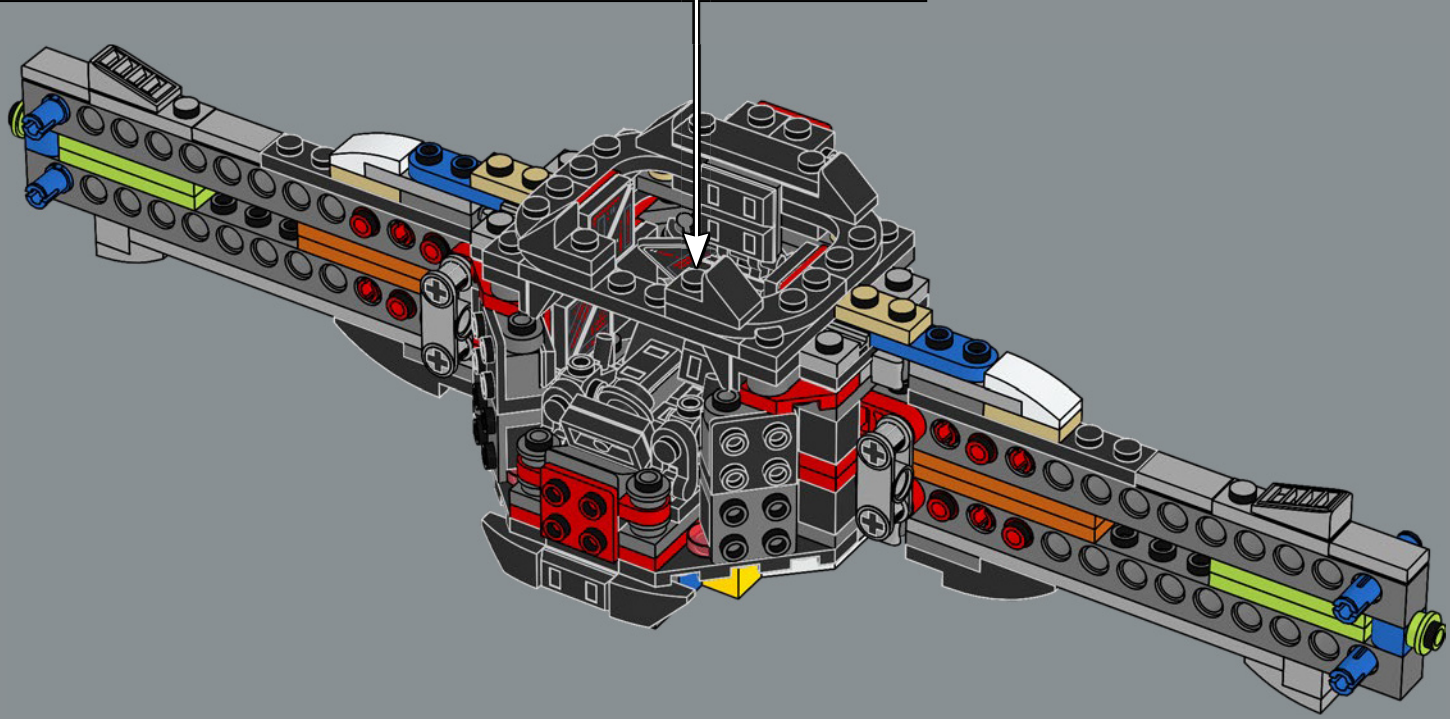
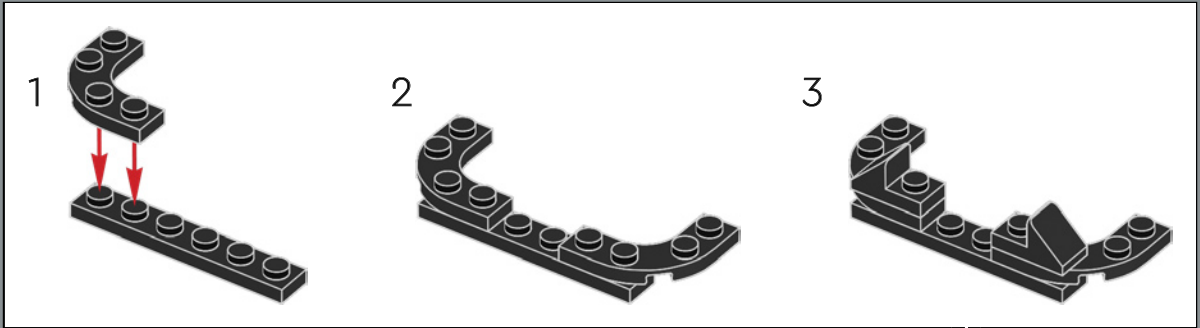





56

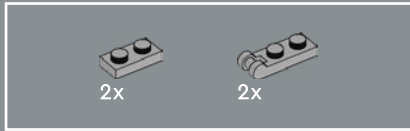
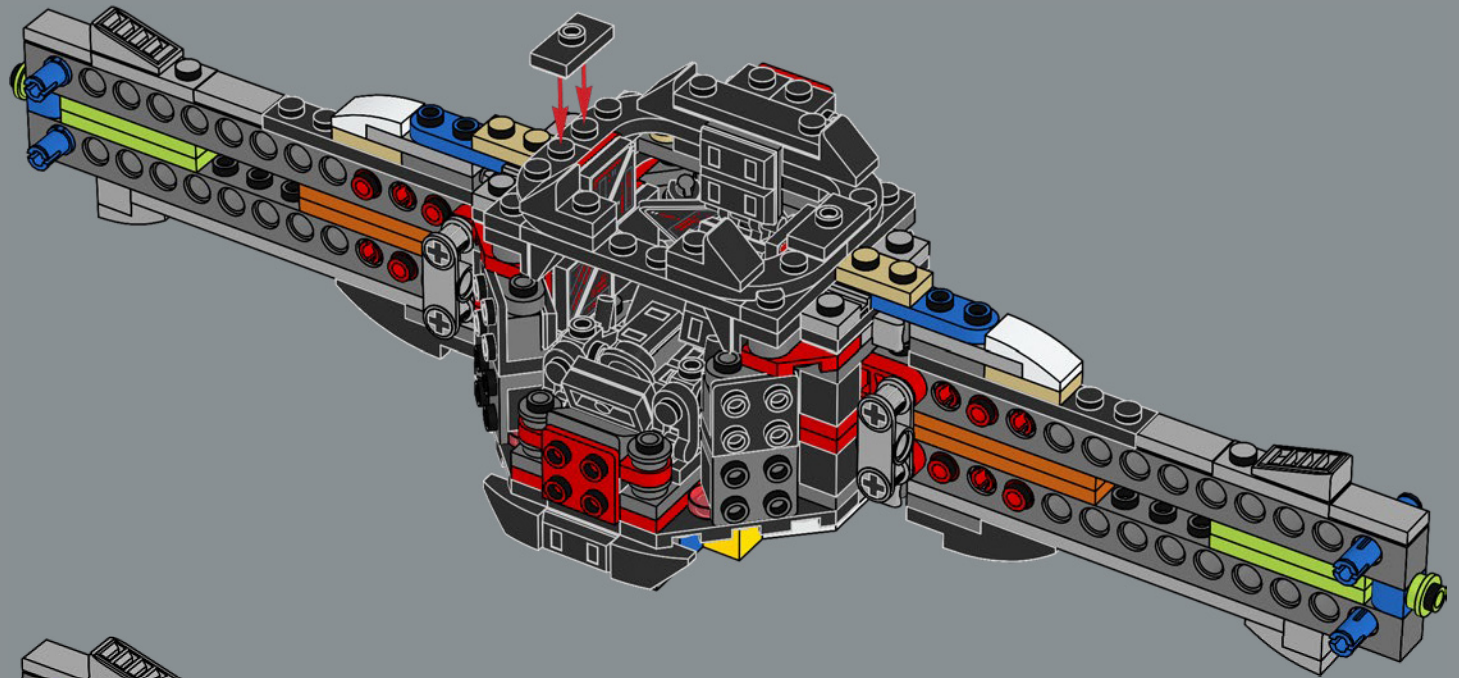

57

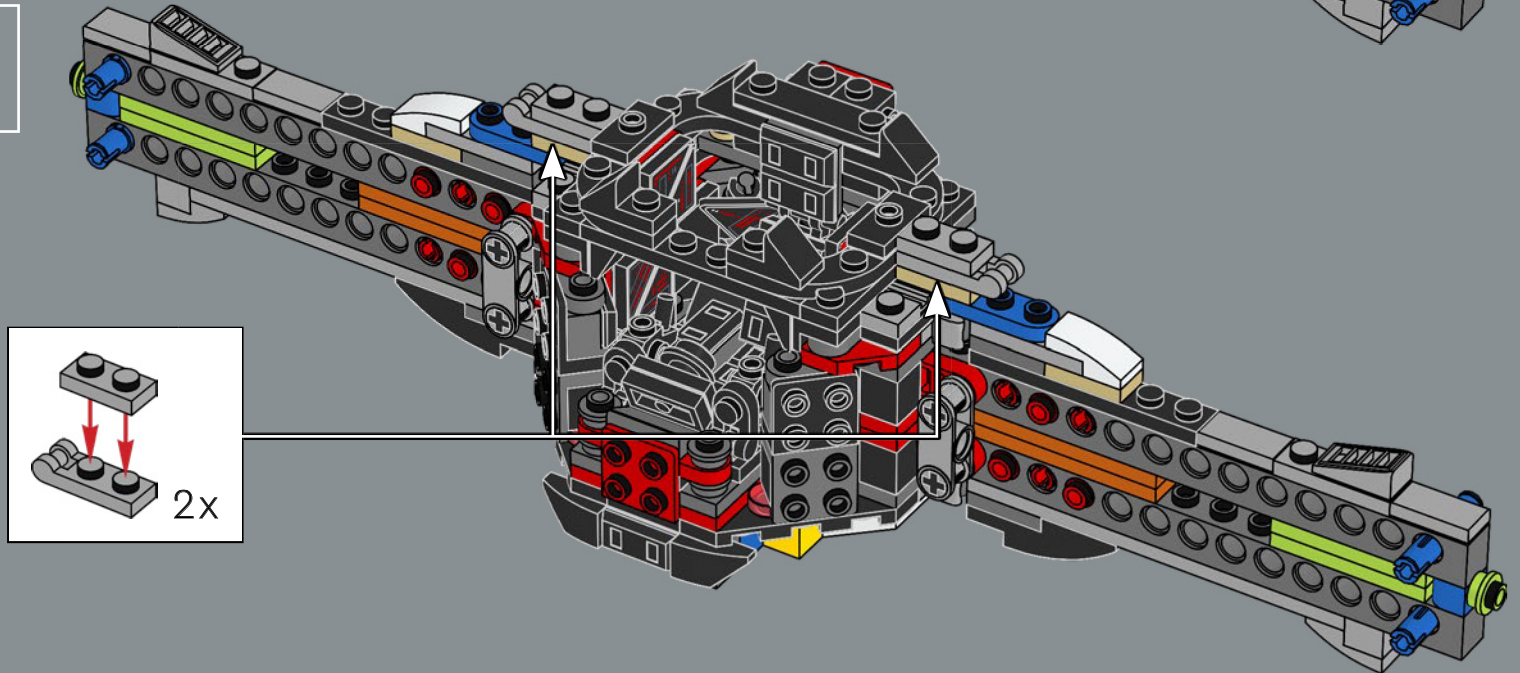

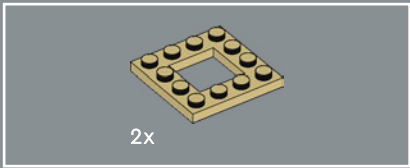

58

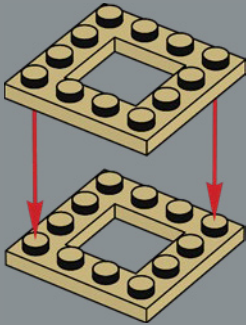

59

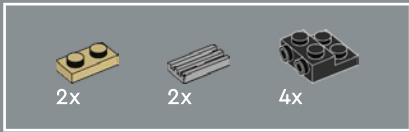
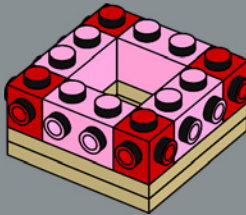

60

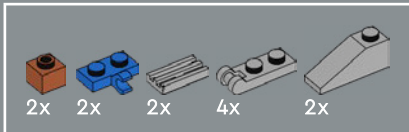
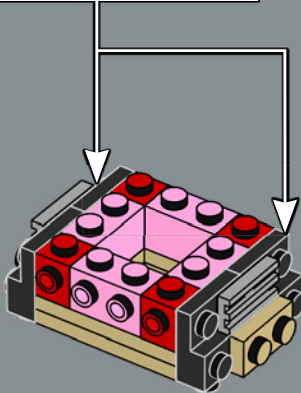
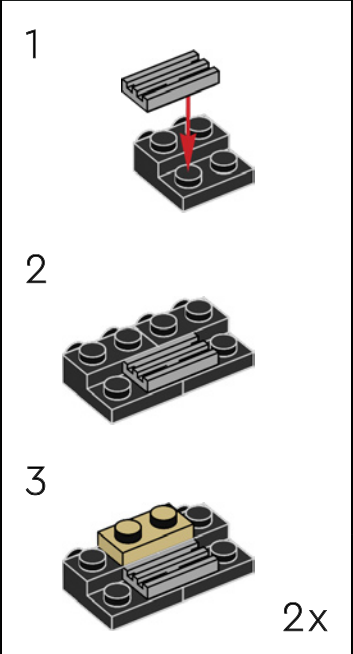

61

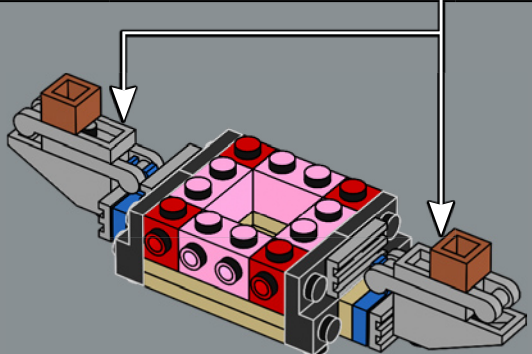
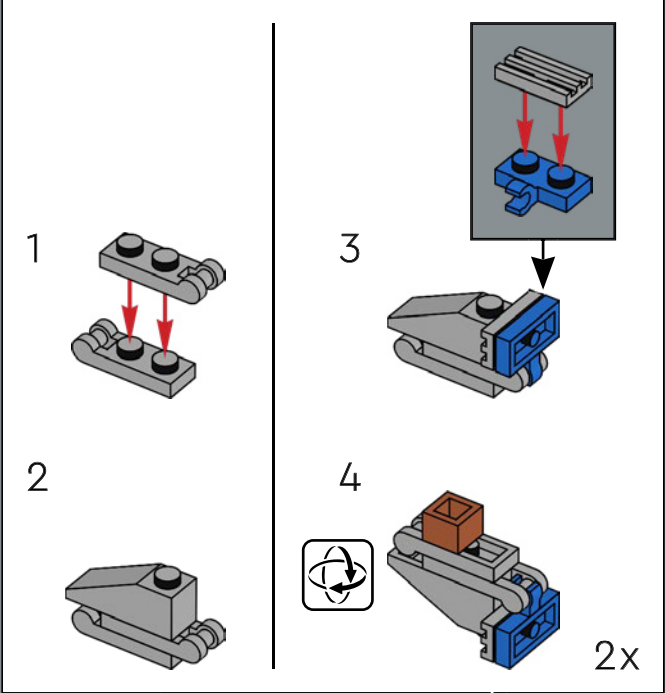

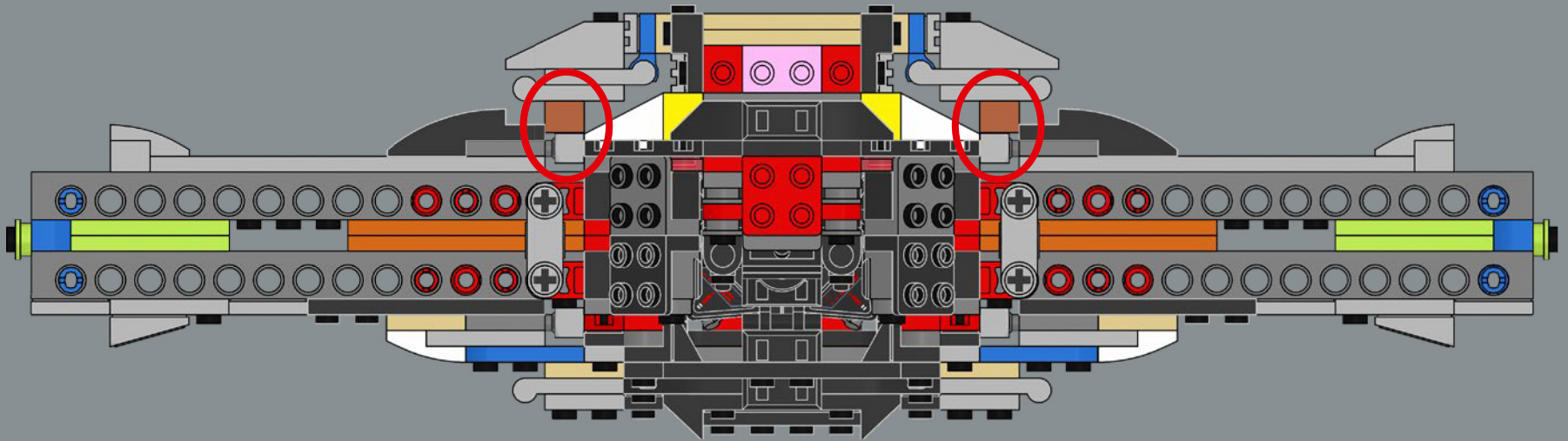
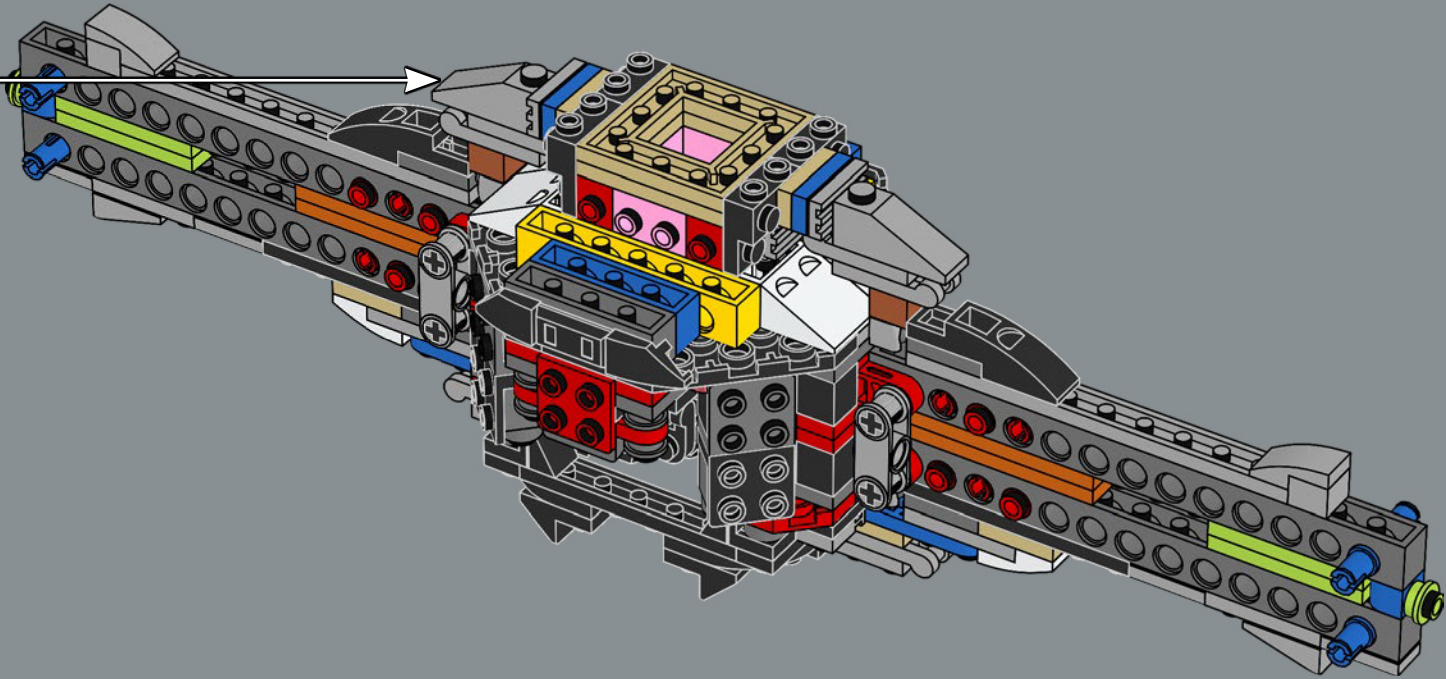





63

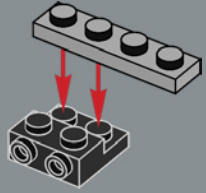

64

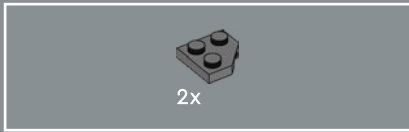
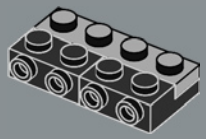

65

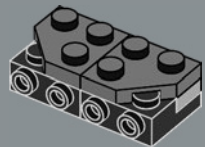

66

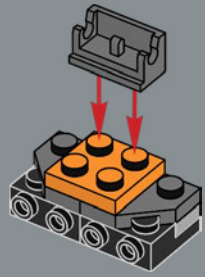

67

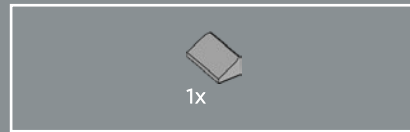

68

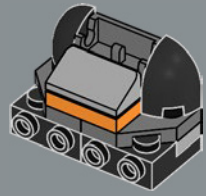

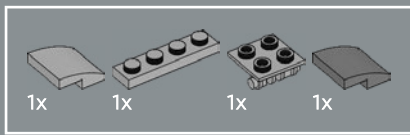

69

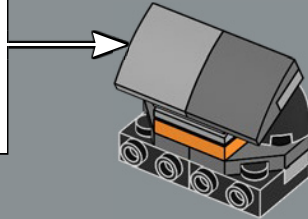
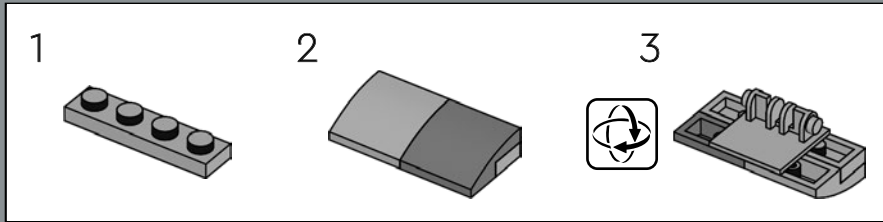

70

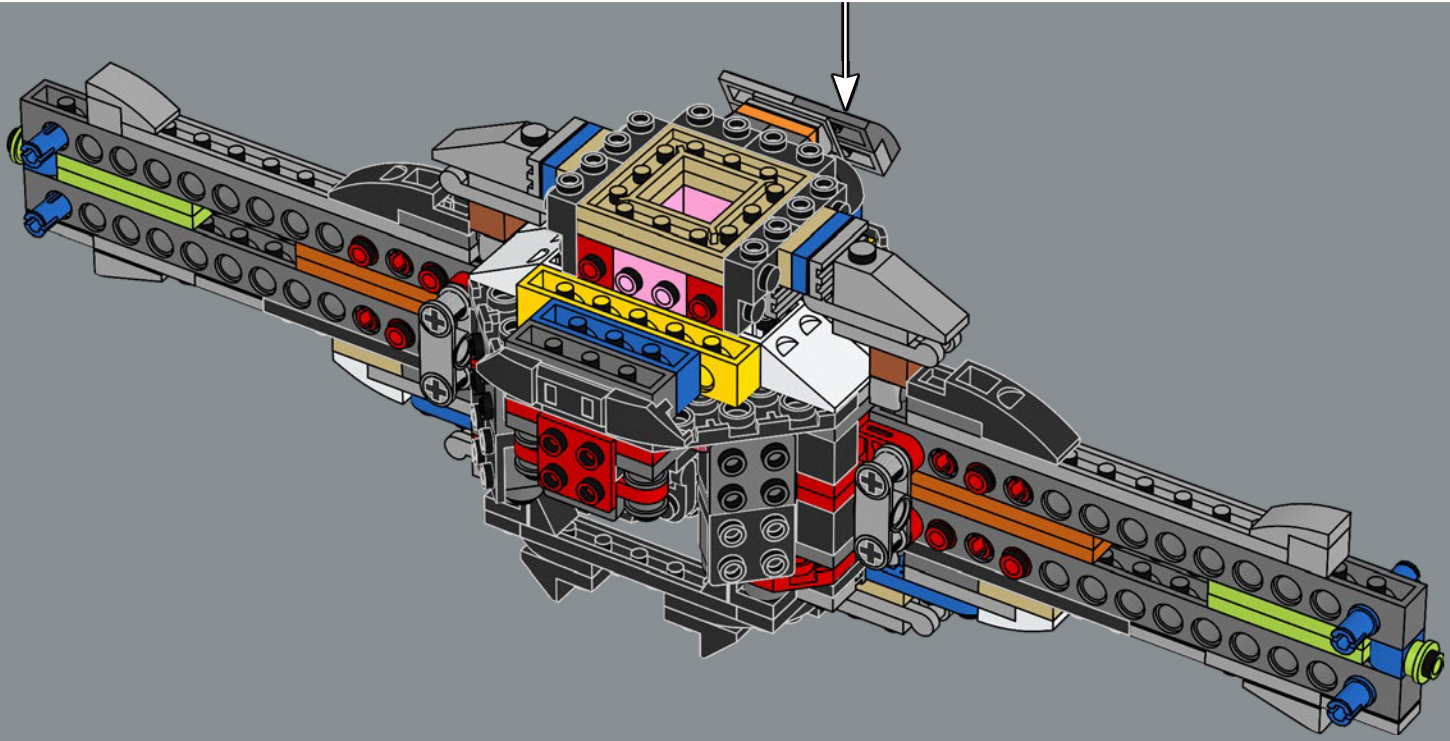

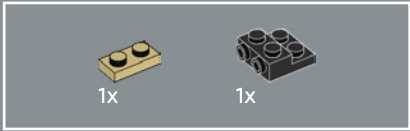
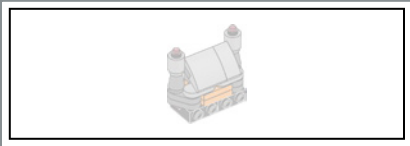

71

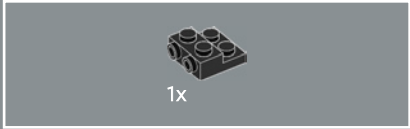
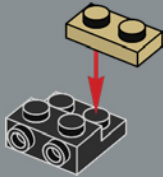

72

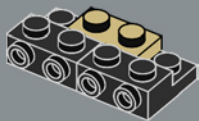

73

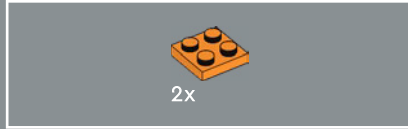
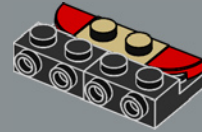

74

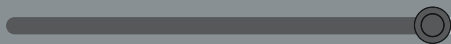
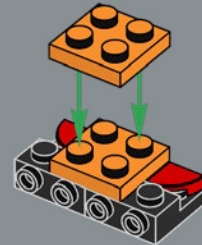



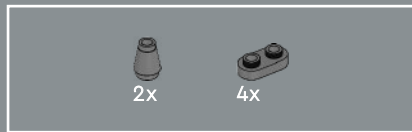

75

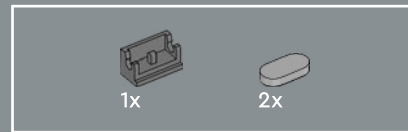
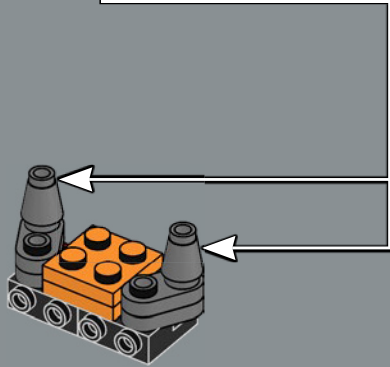
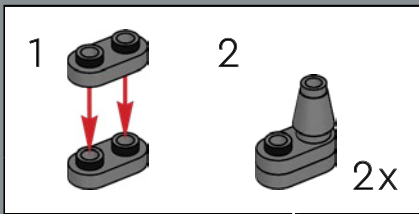

77

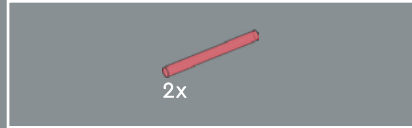
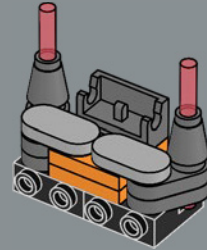

76

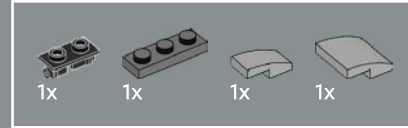
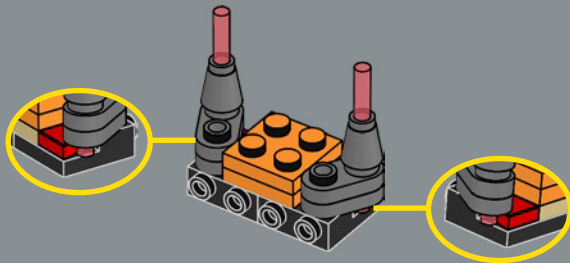

78

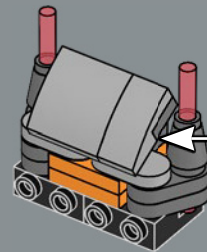
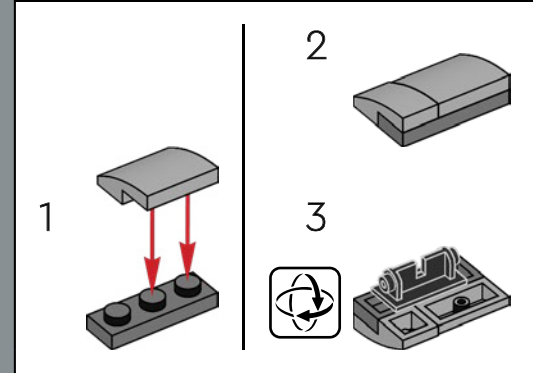



2x

79

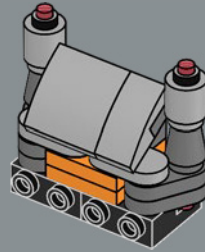

80

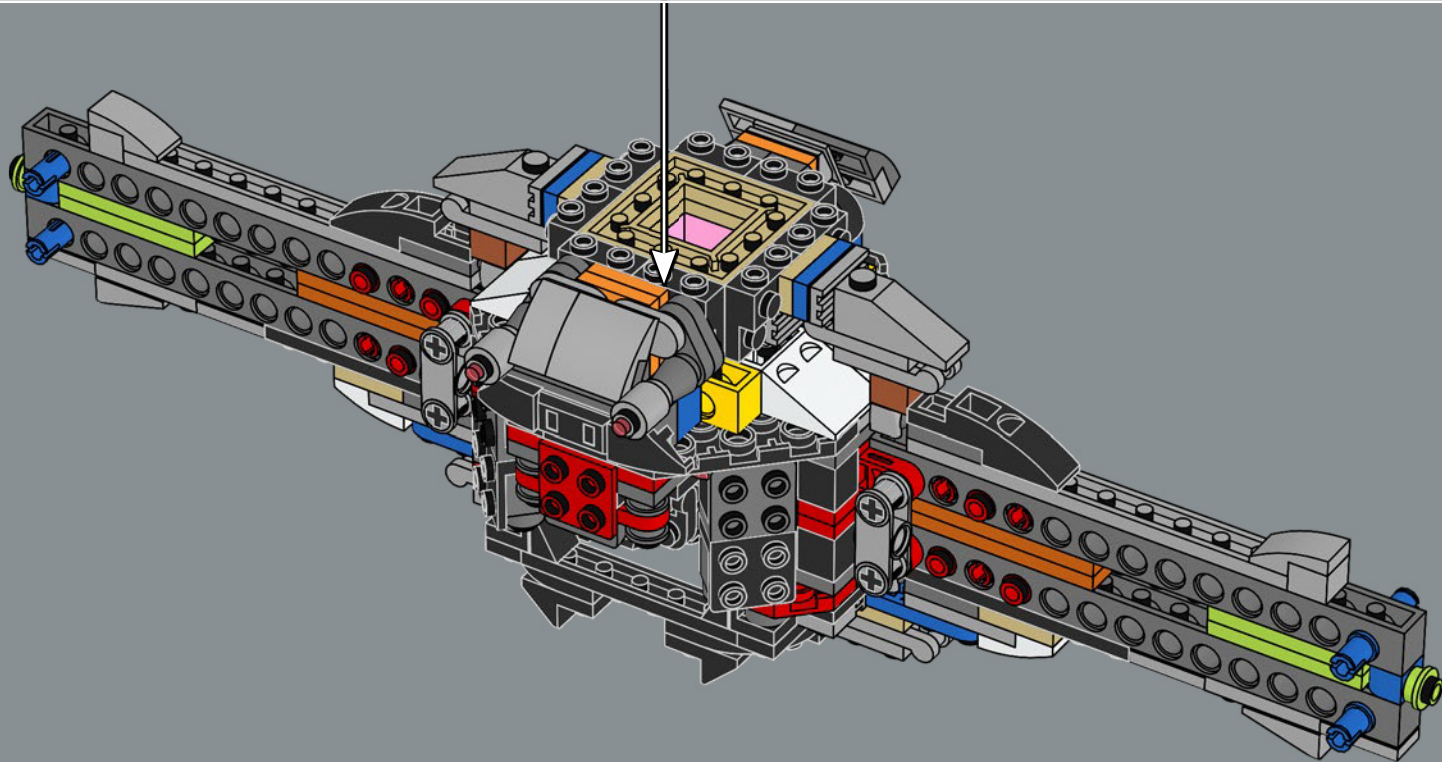

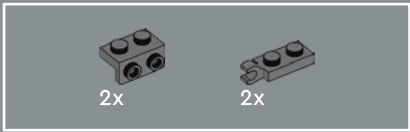

81

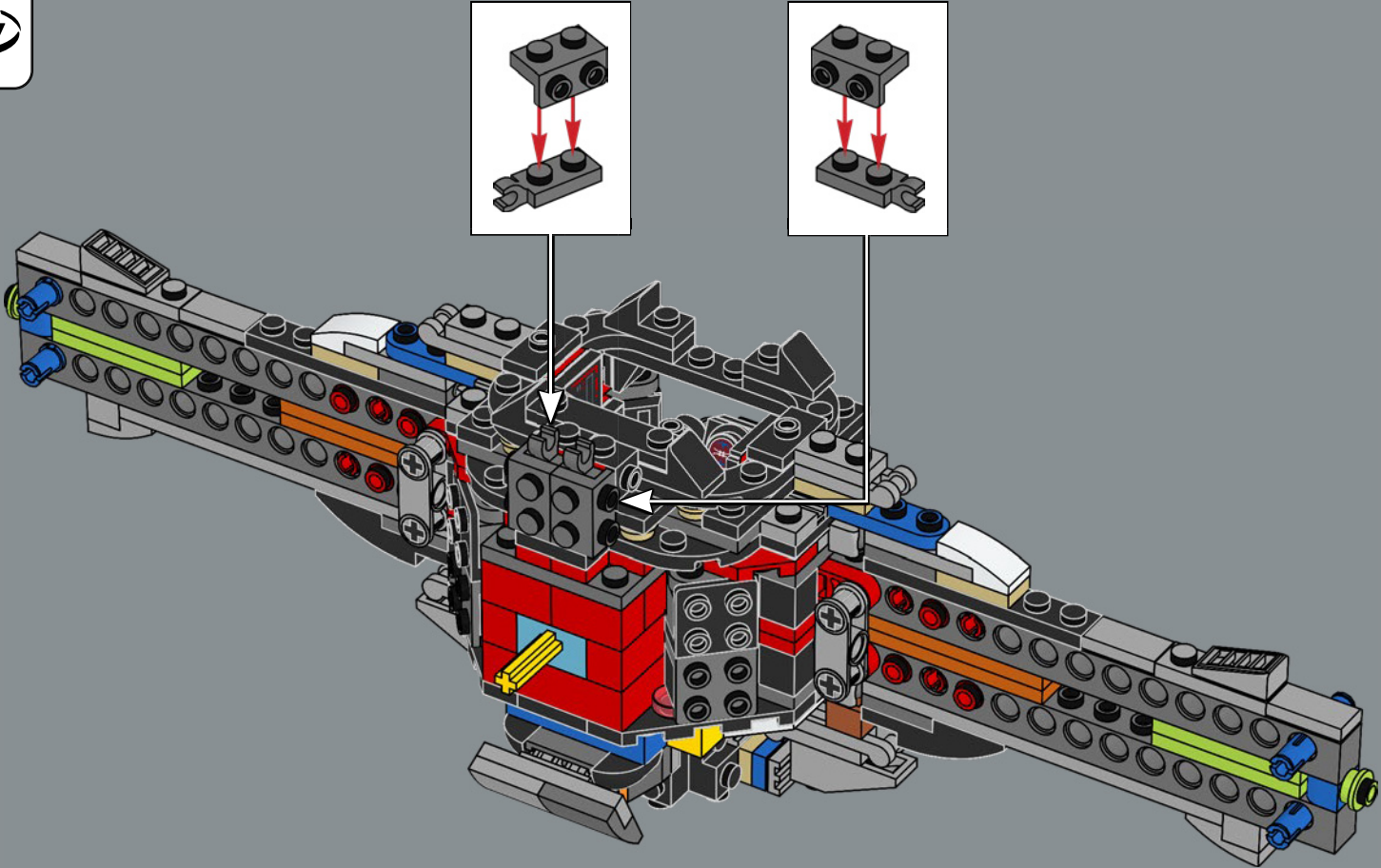



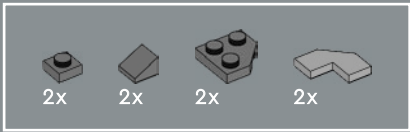

82

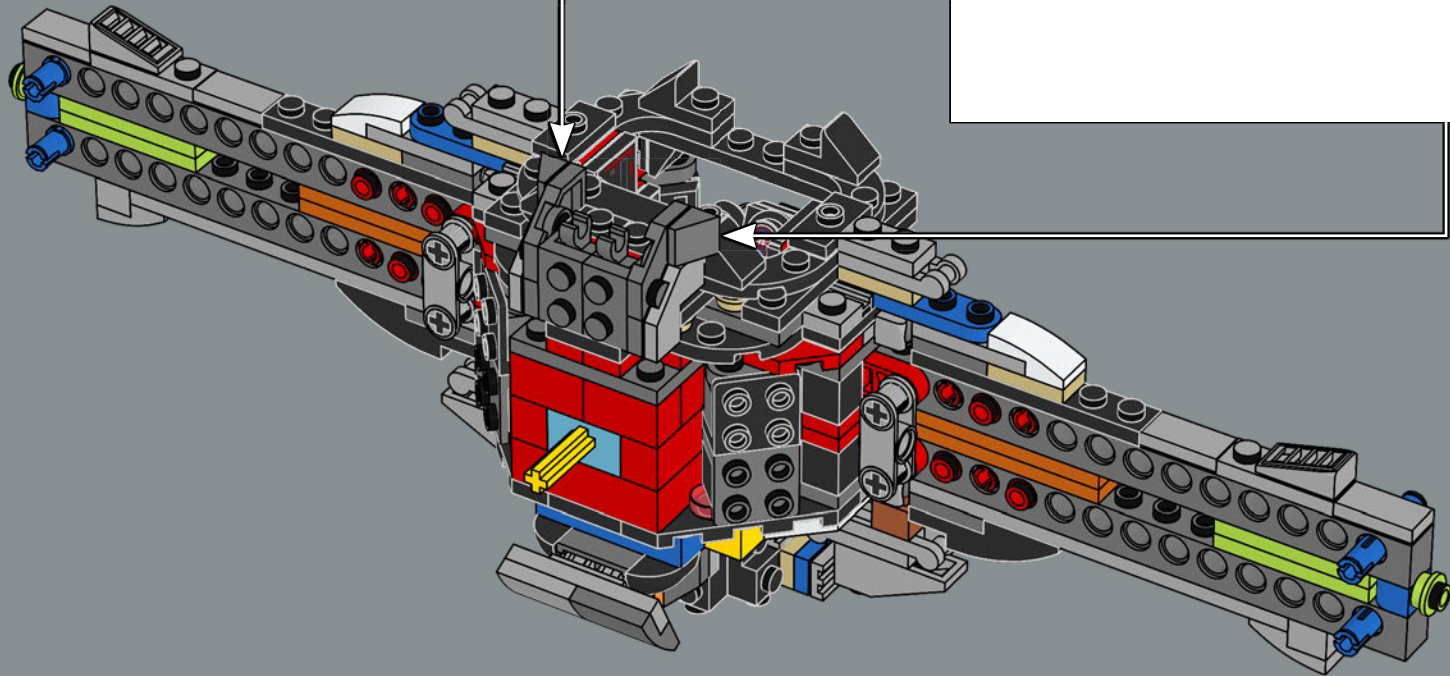
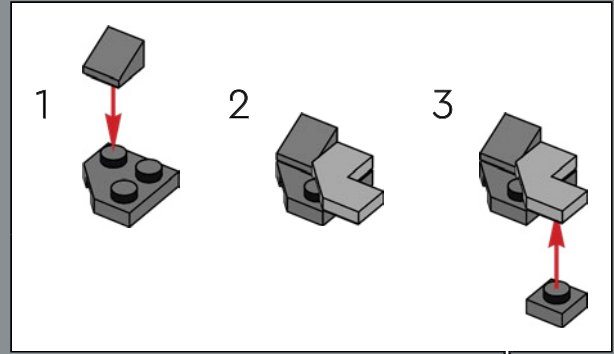
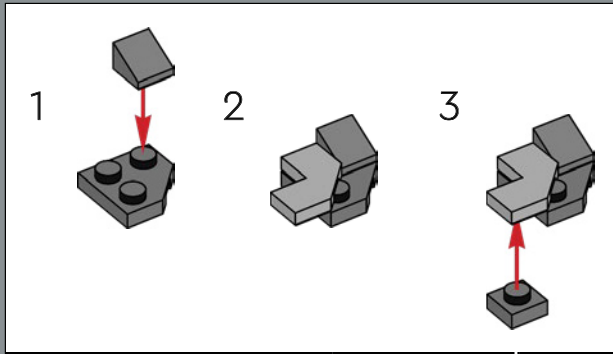

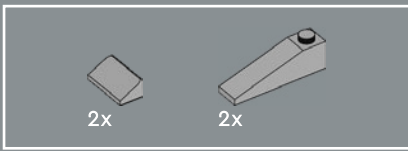

83

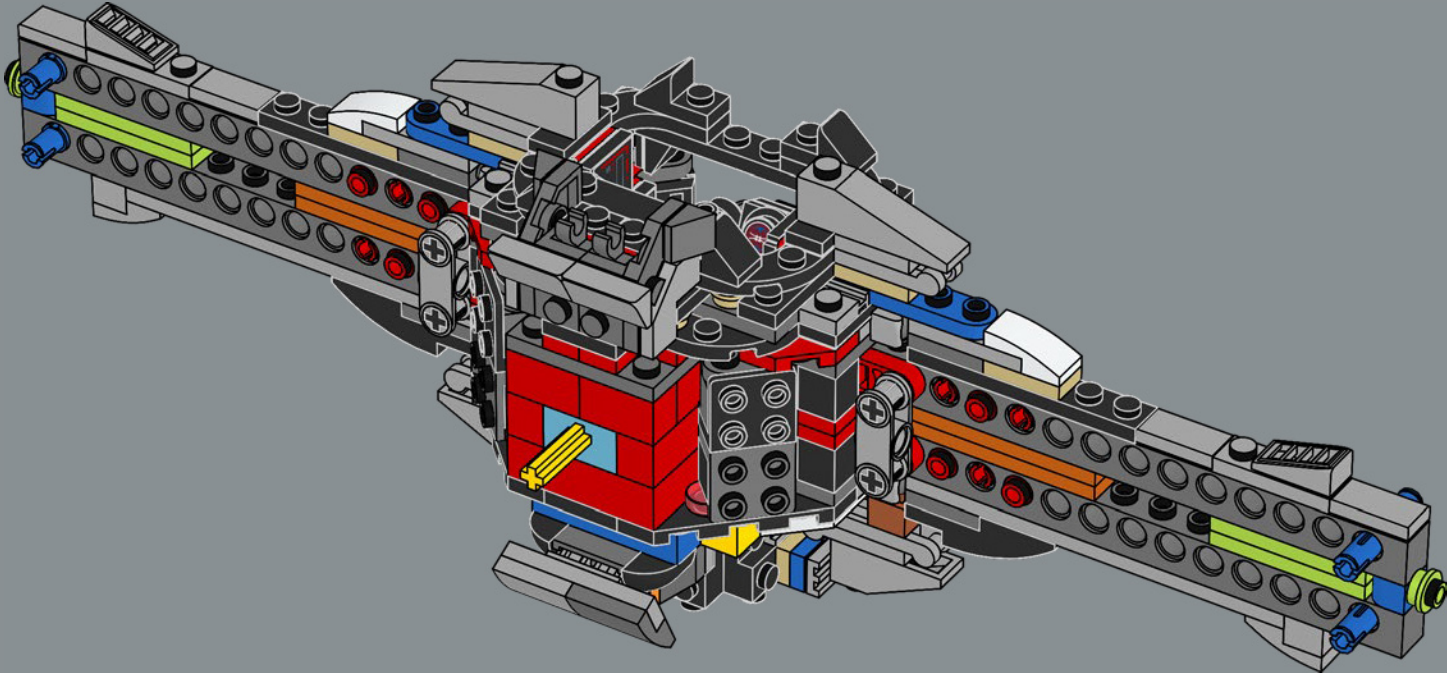



84

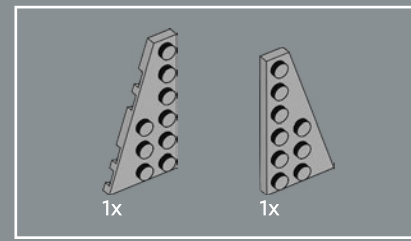
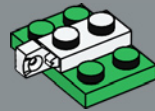

86

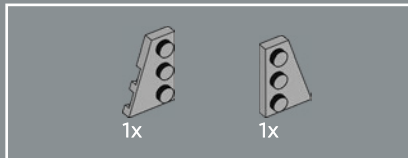
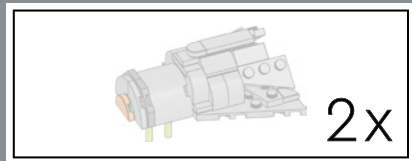
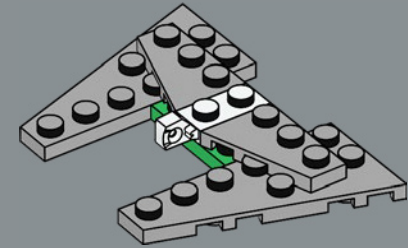

85

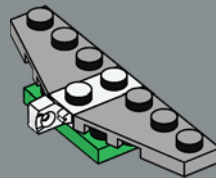

87

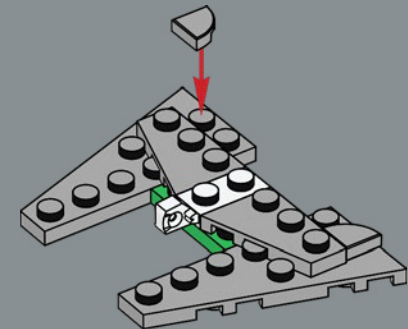



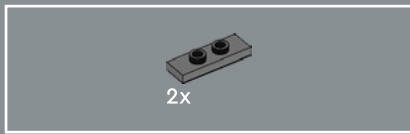

88

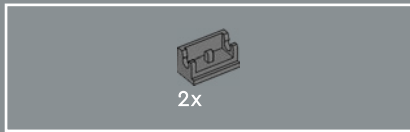
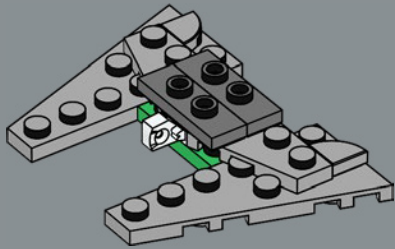

89

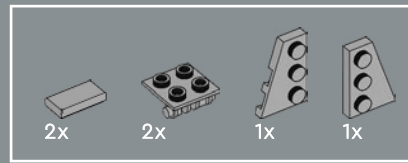
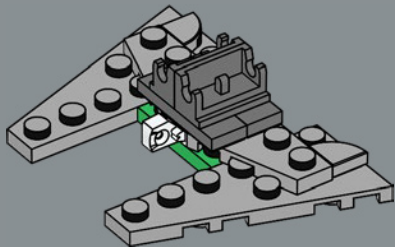

90

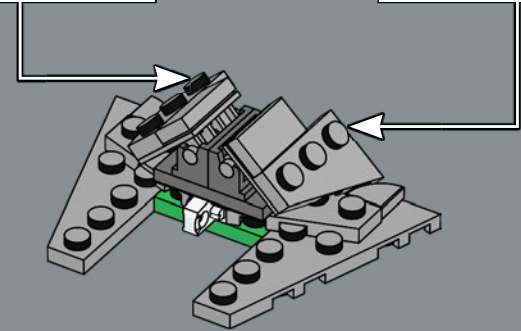
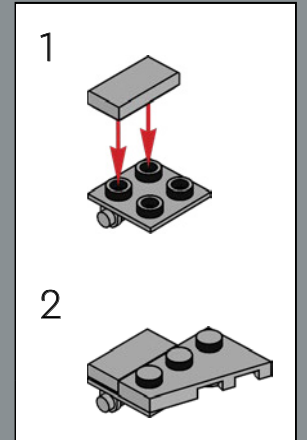
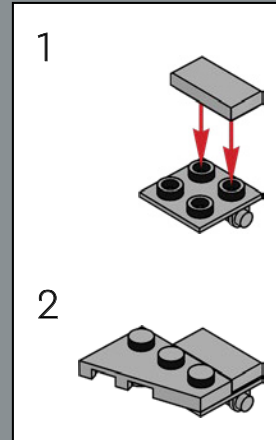



91

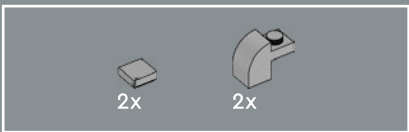
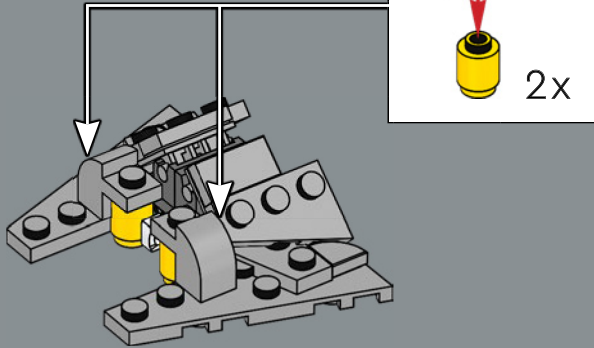

93

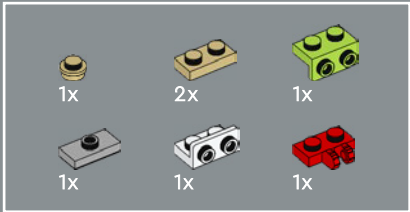
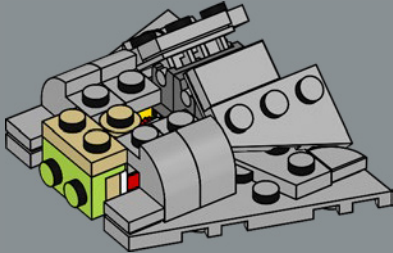

92

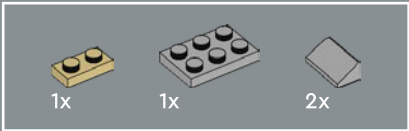
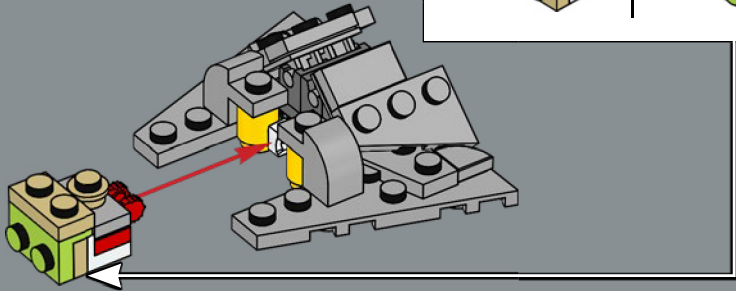
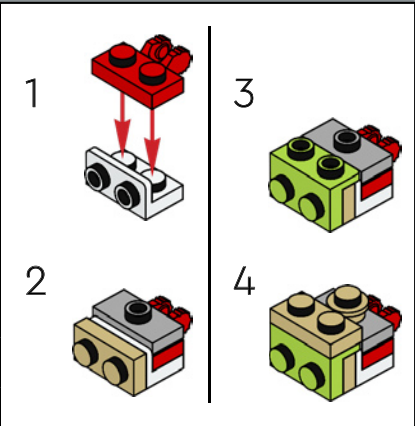

94

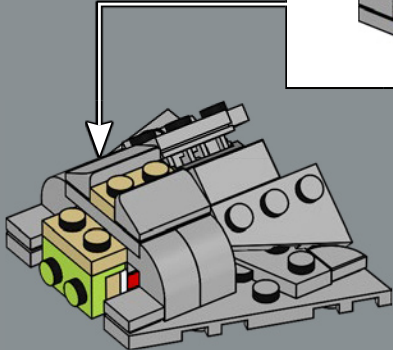
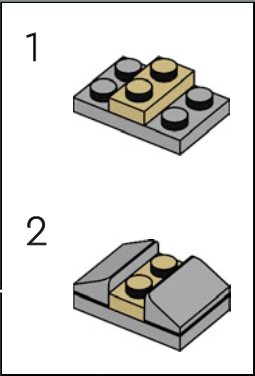





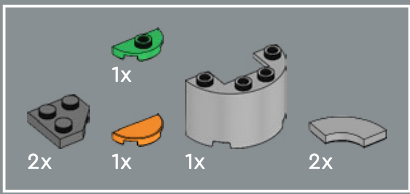

99

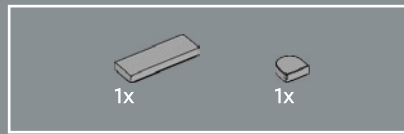
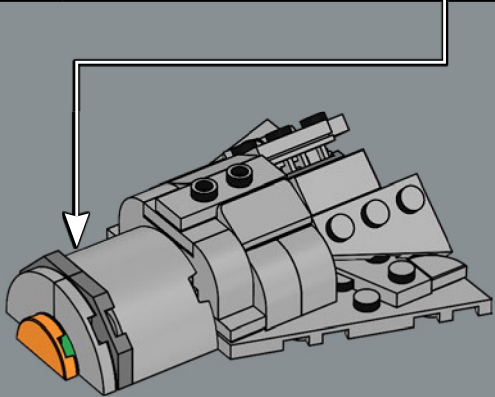
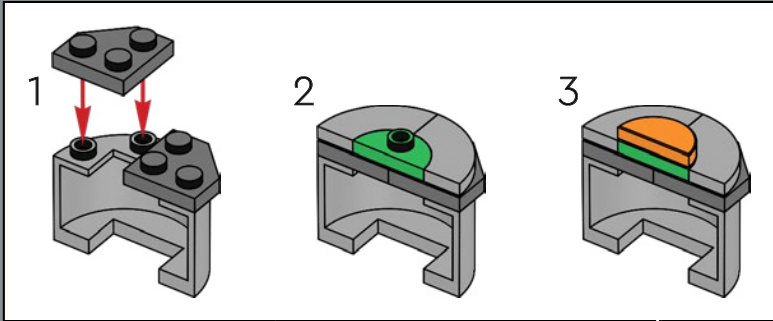

100

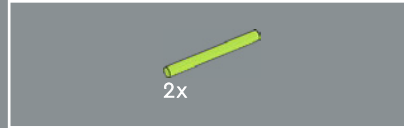
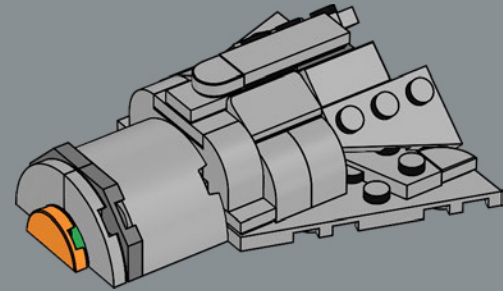

101

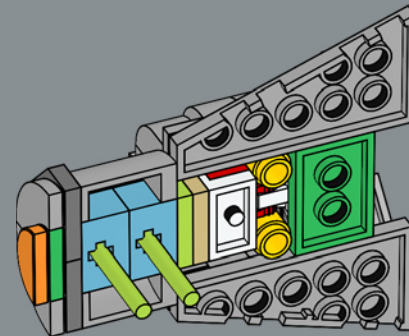

2x

102

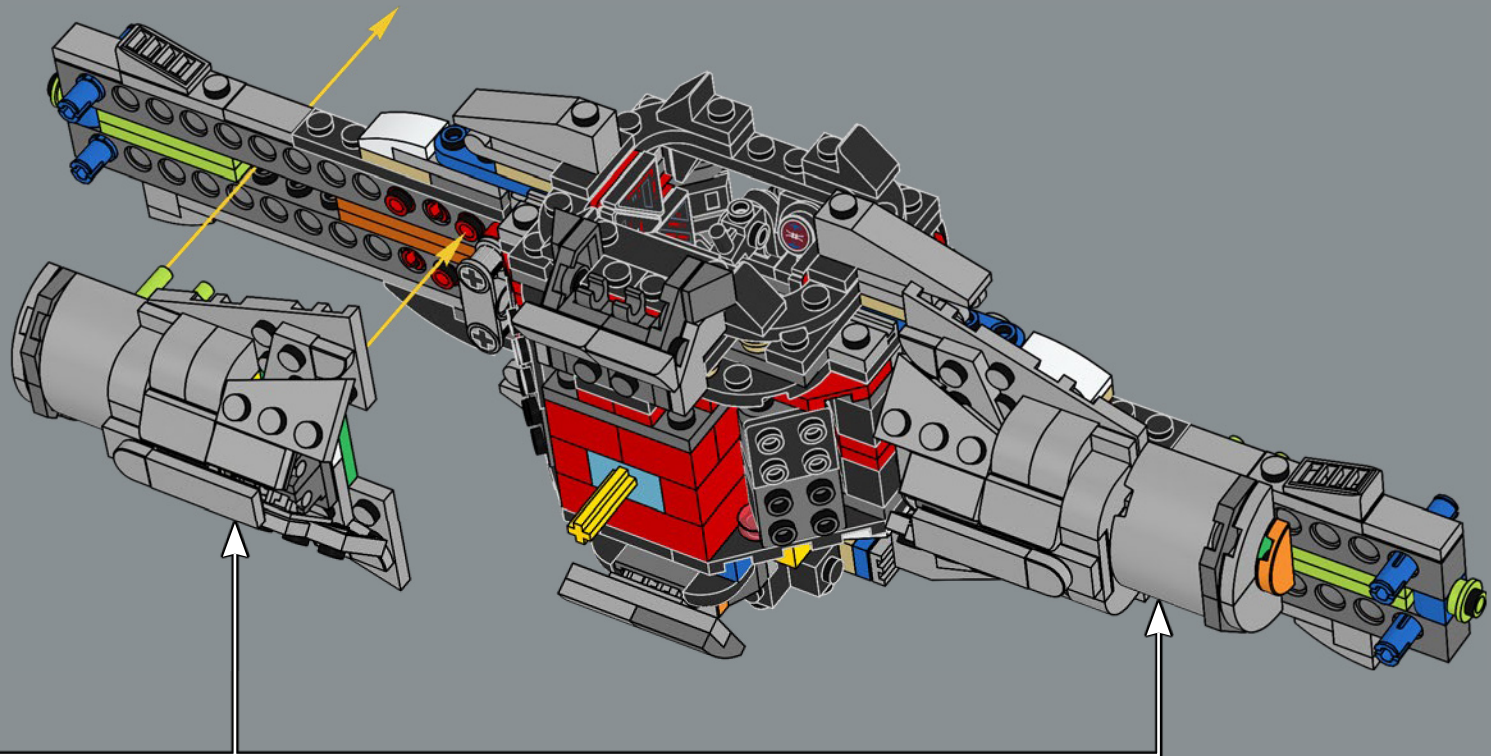

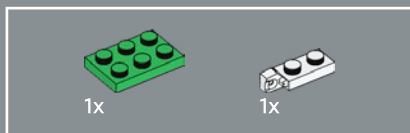

103

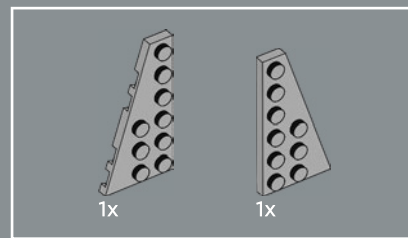
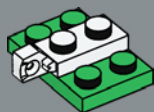

105

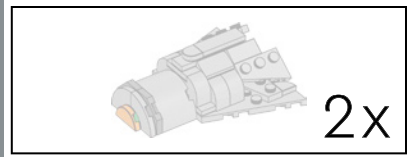
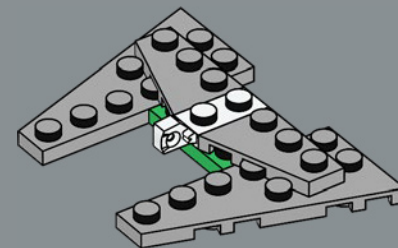

2x

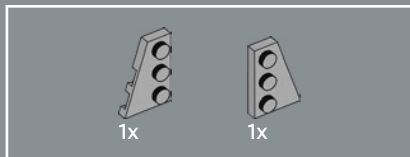

104

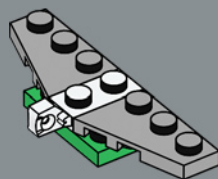

106

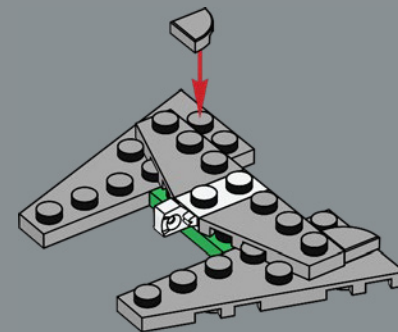



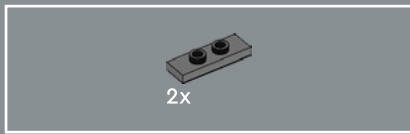

107

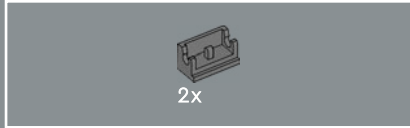
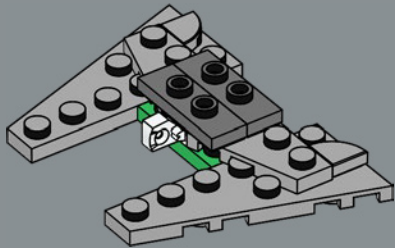

108

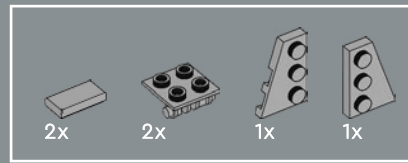
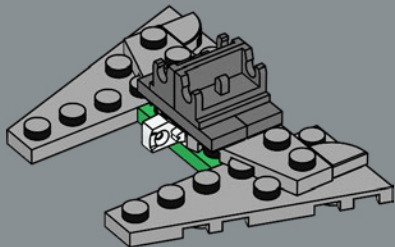

109

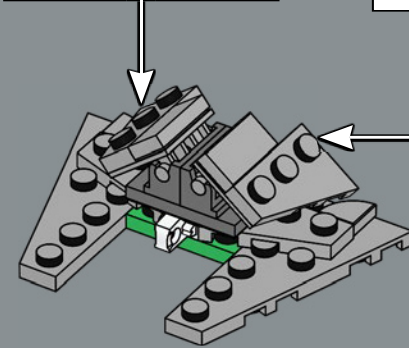
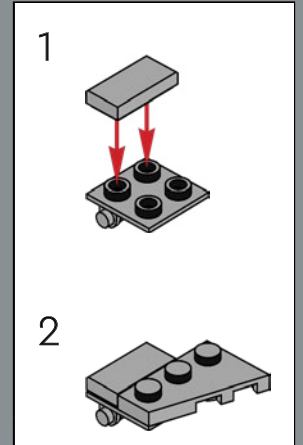
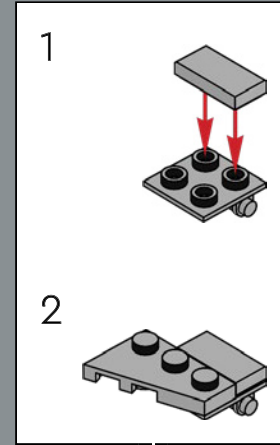



110

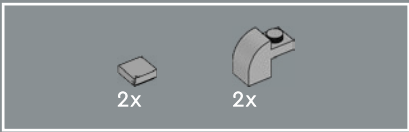
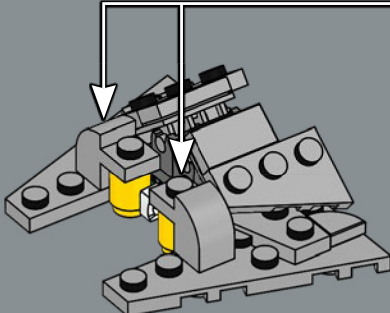
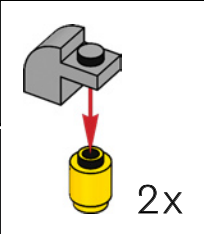

112

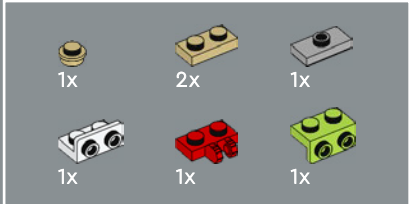
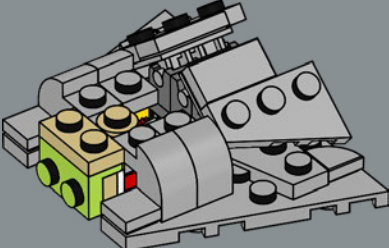

111

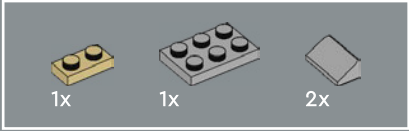
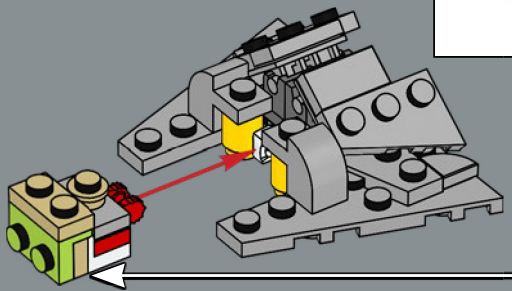
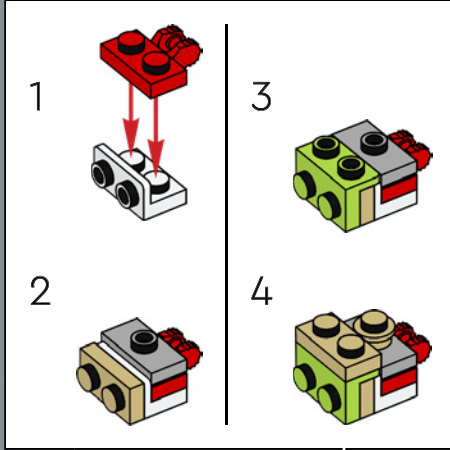

113

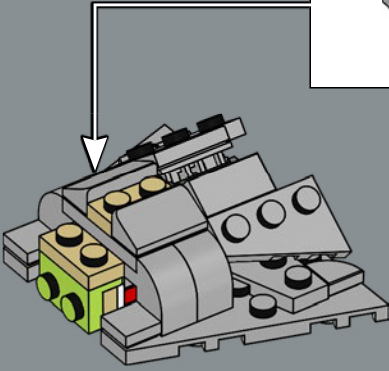
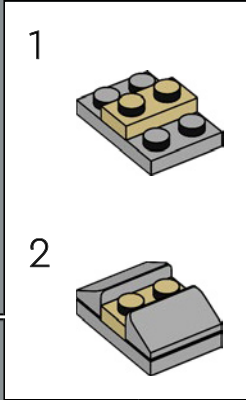



114

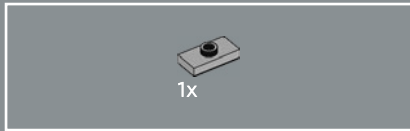
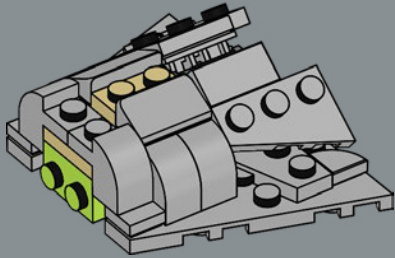

115

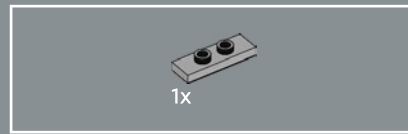
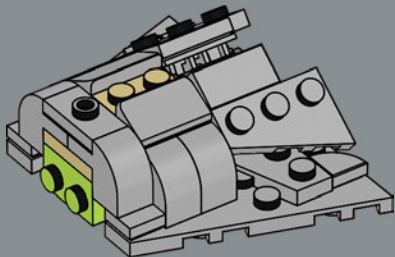

116

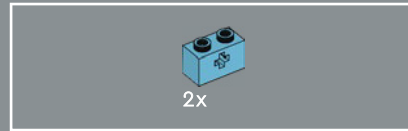
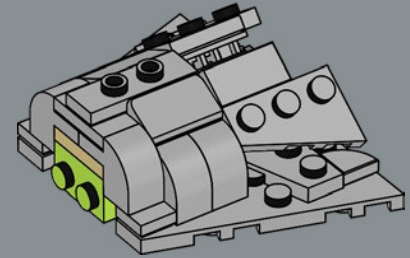

117

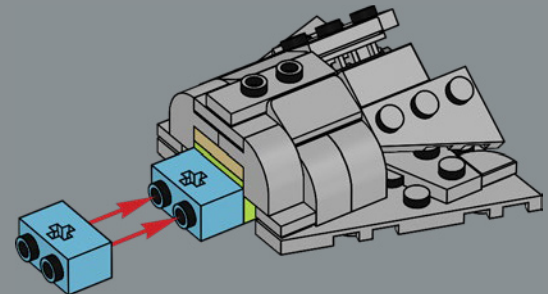



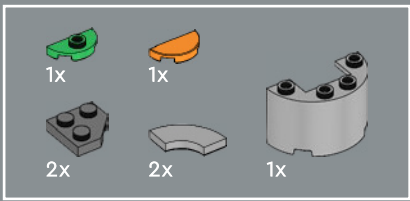

118

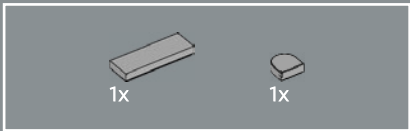
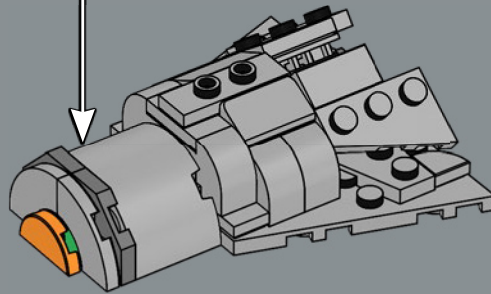
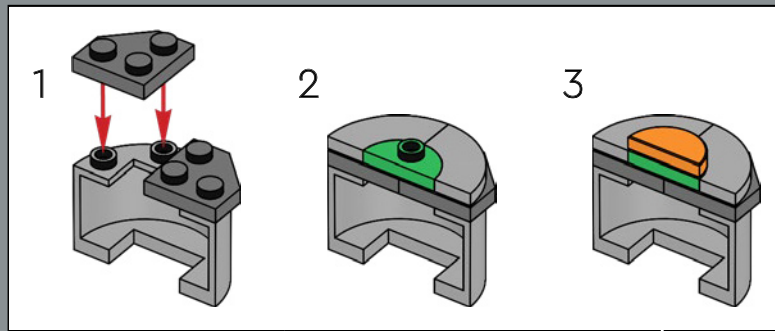

119

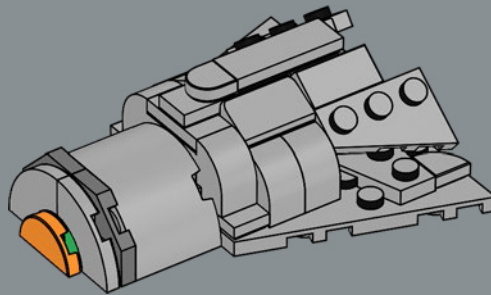

2x

120

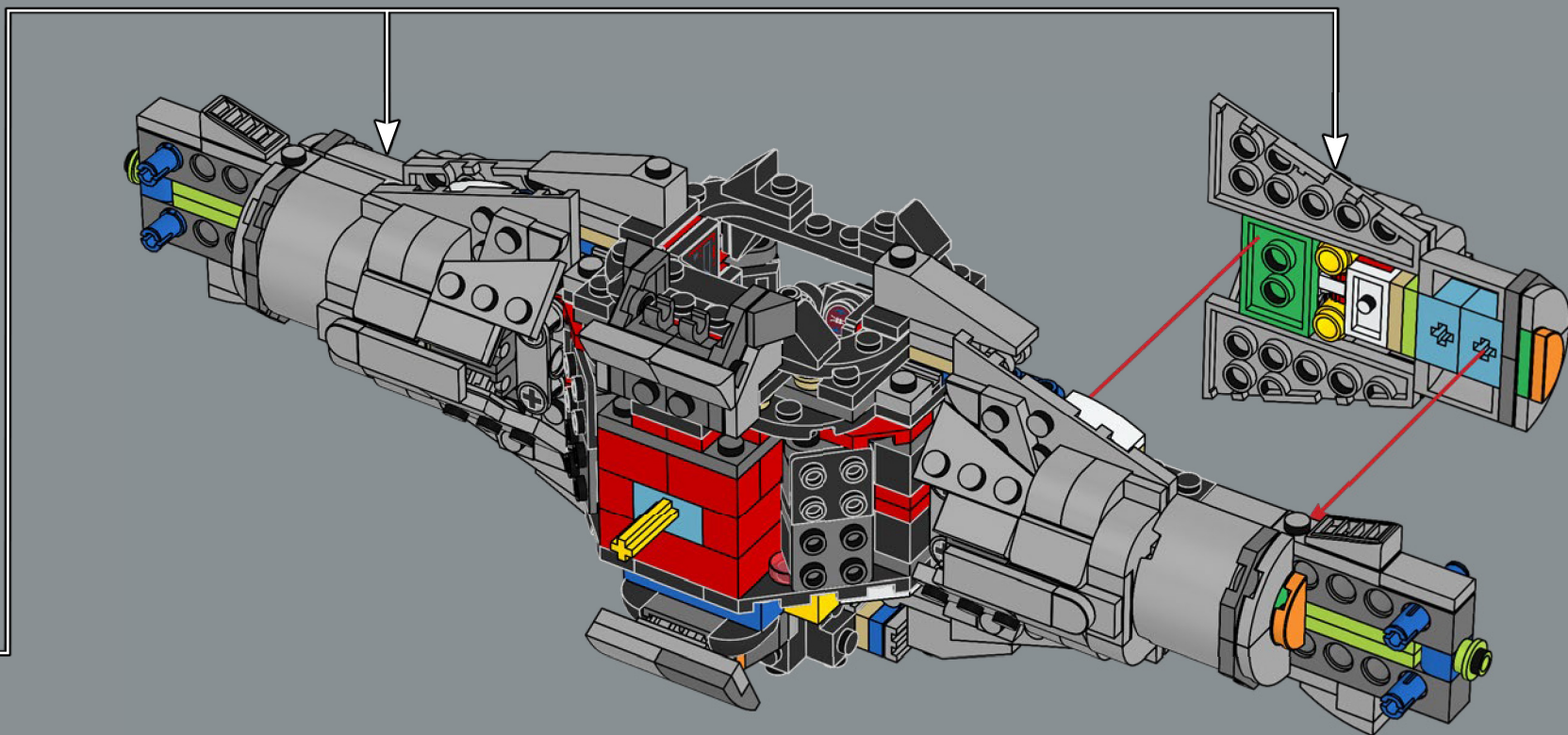

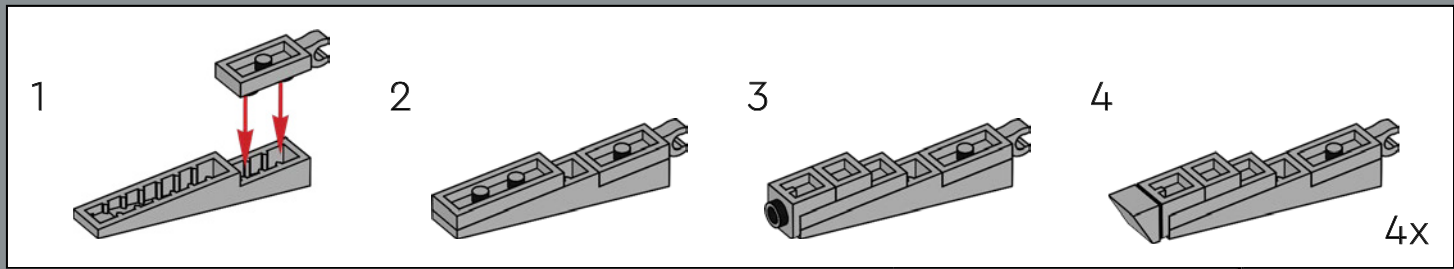
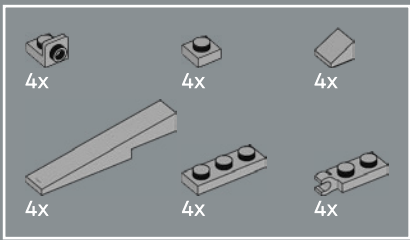

121

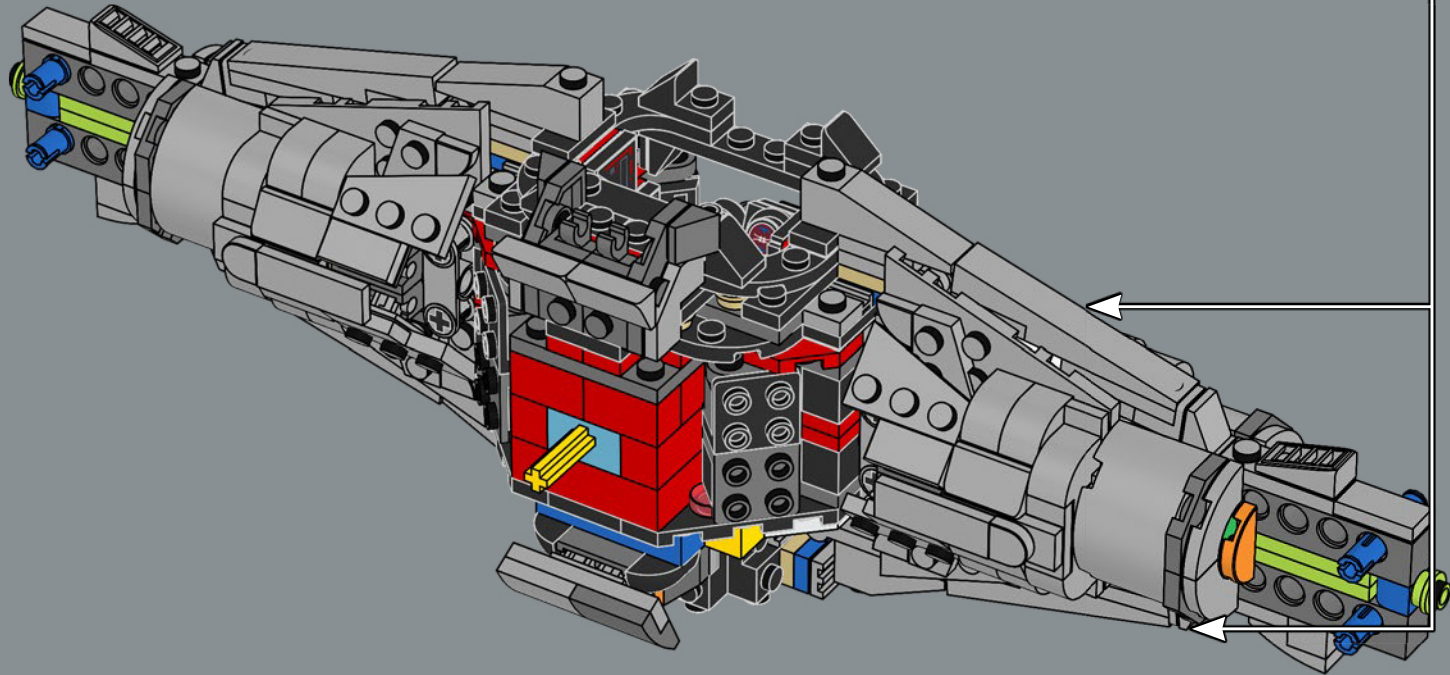



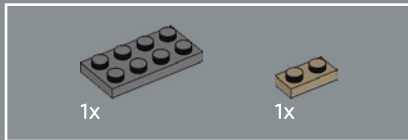
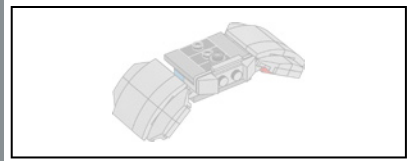

122

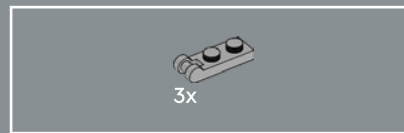
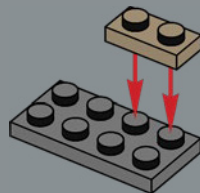

123

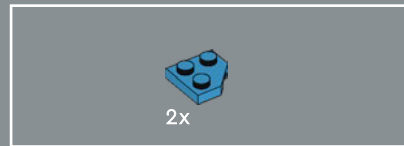
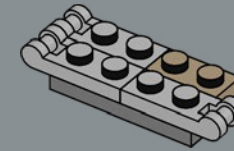

124

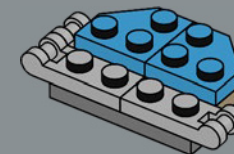



2x

125

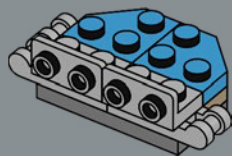

2x



3x

126

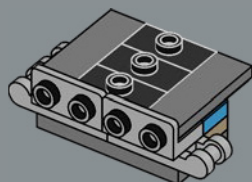

1x

127

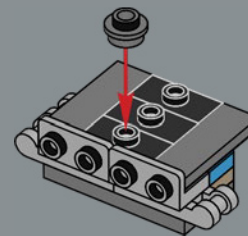

1x



2x

128

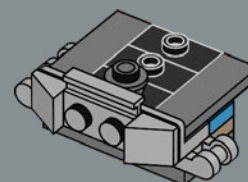

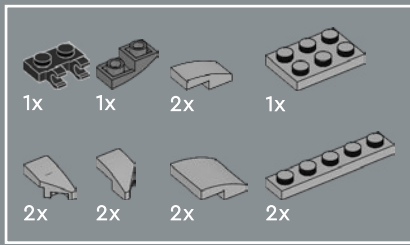

129

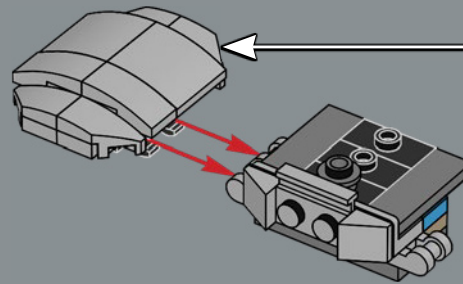
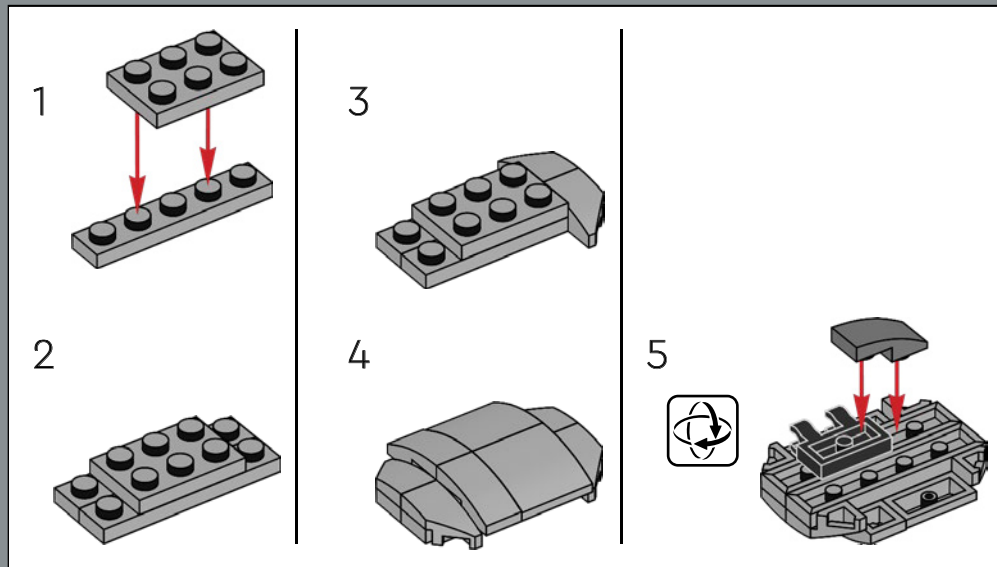



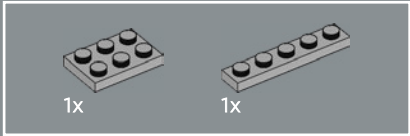

130

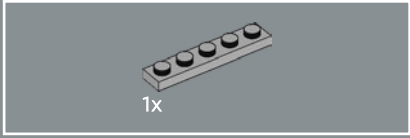
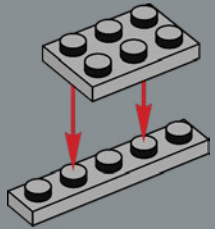

131

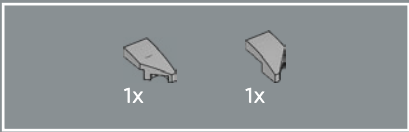
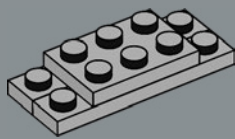

132

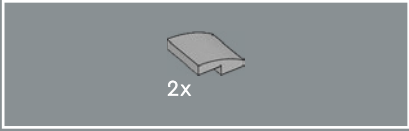
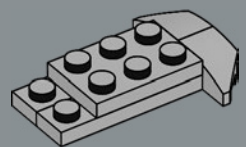

133

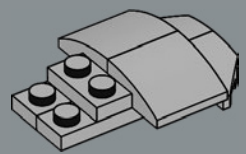

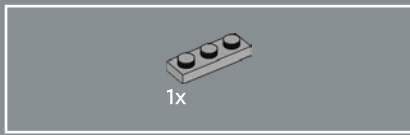

134

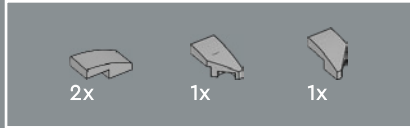
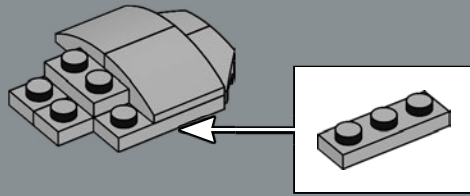

135

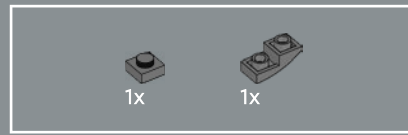
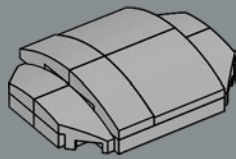

136

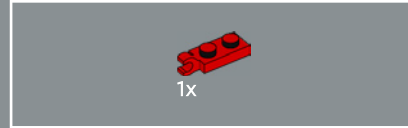
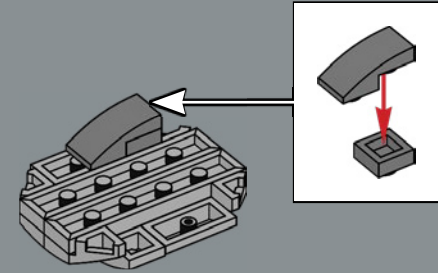

137

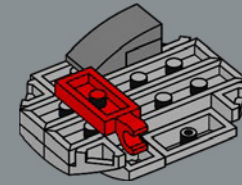

138

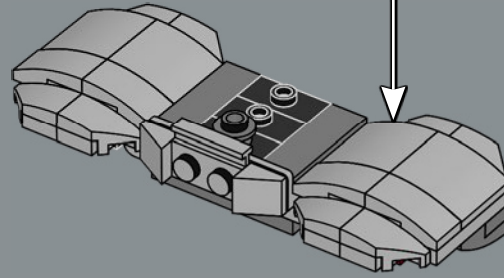

139

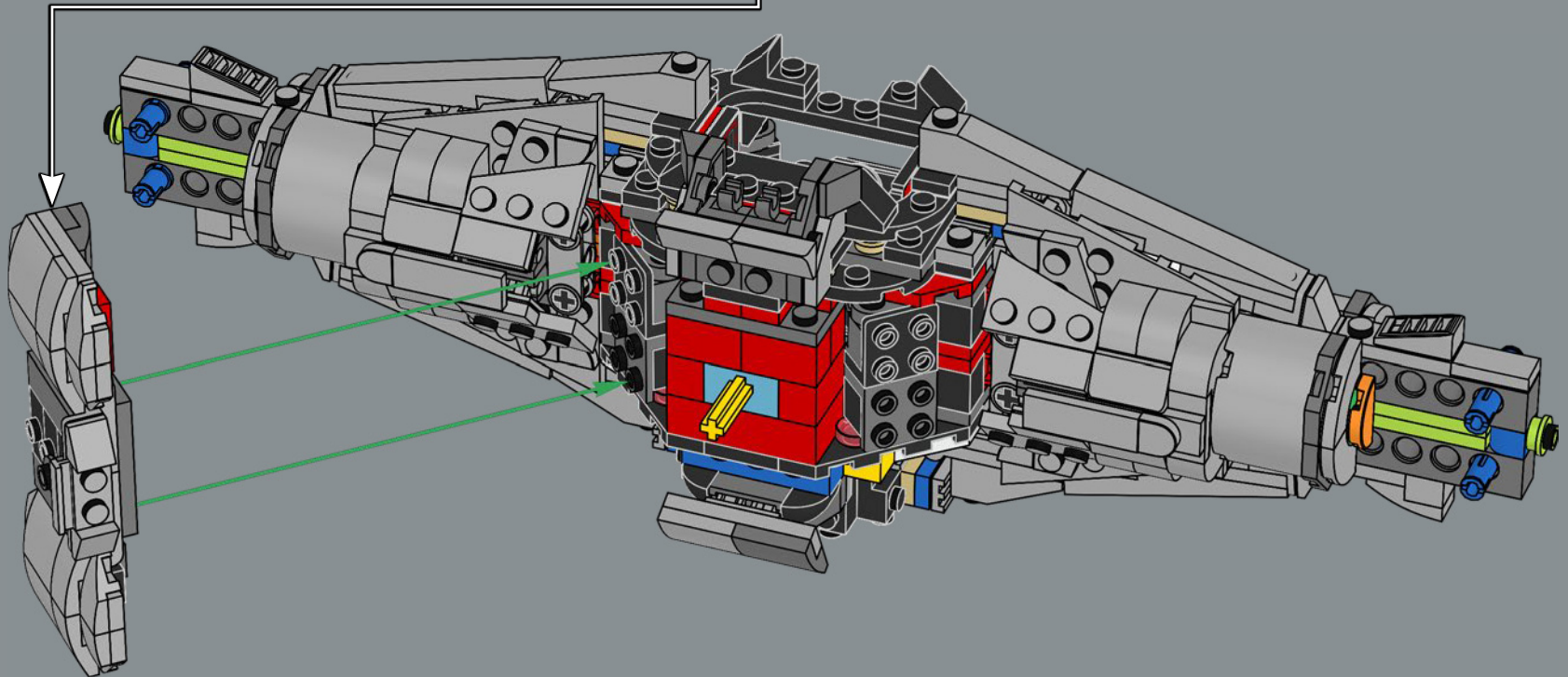

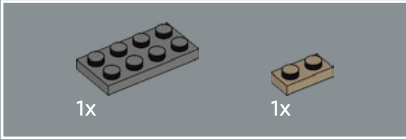
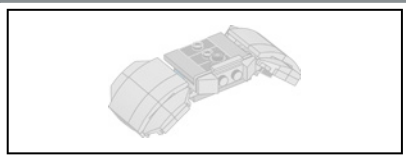

140

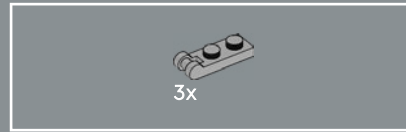
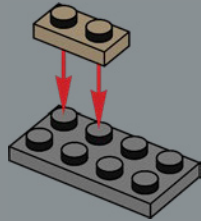

141

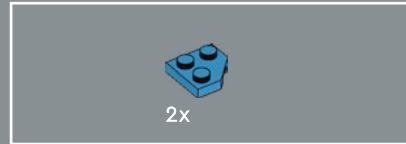
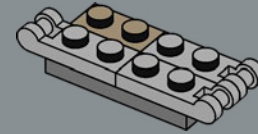

142

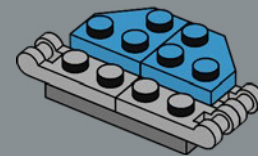





2x

143

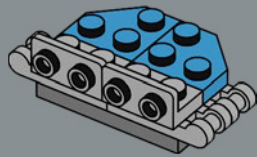

2x



3x

144

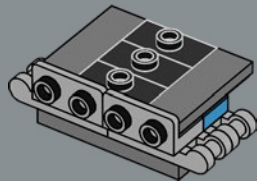

1x

145

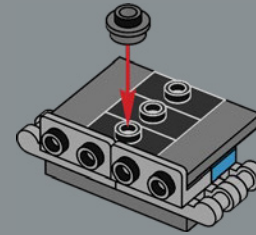

1x



2x

146

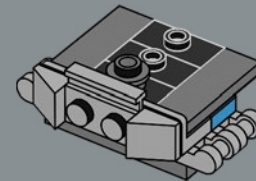

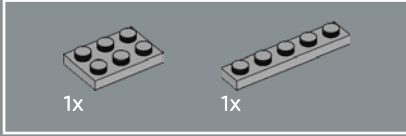
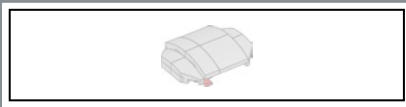

147

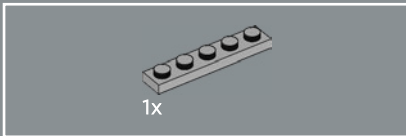
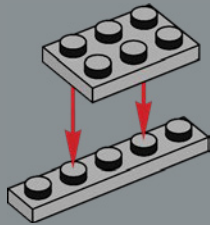

148

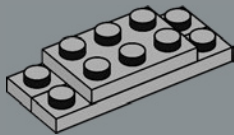

149

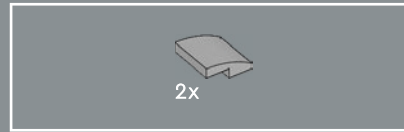
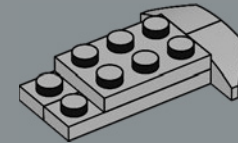

150

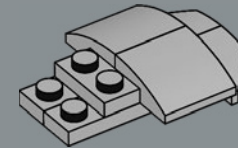

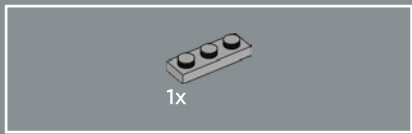

151

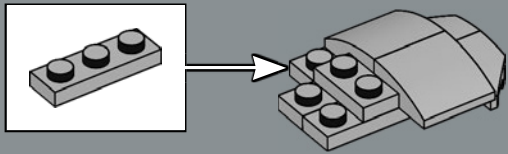

152

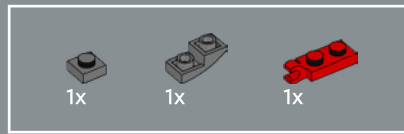
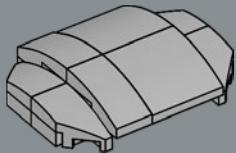

153

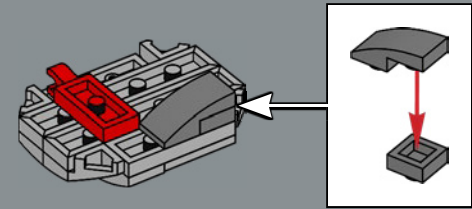

154

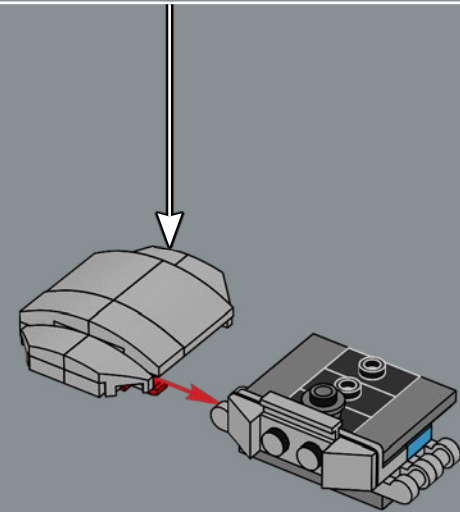

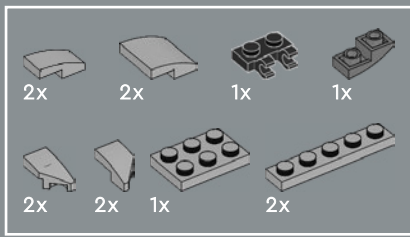

155

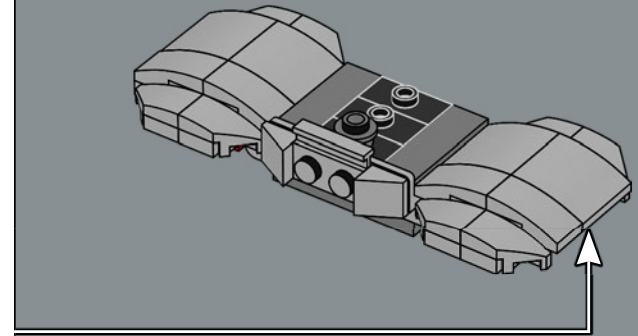
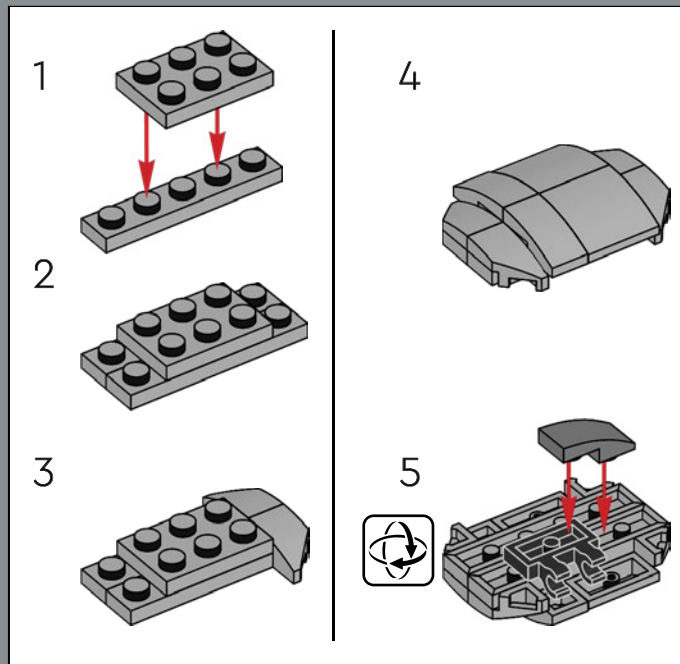

156

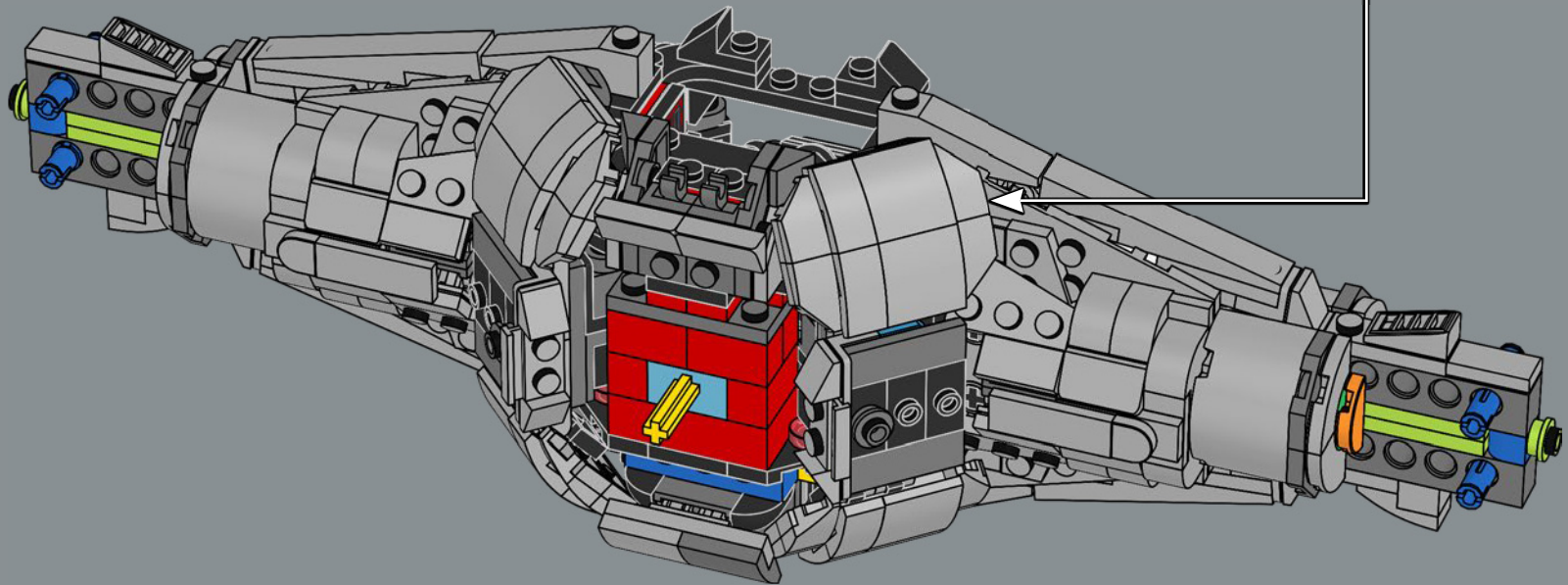



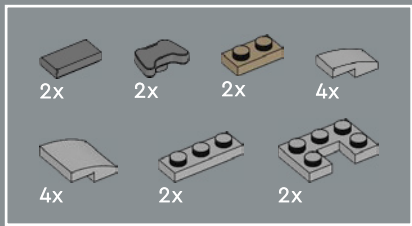

157

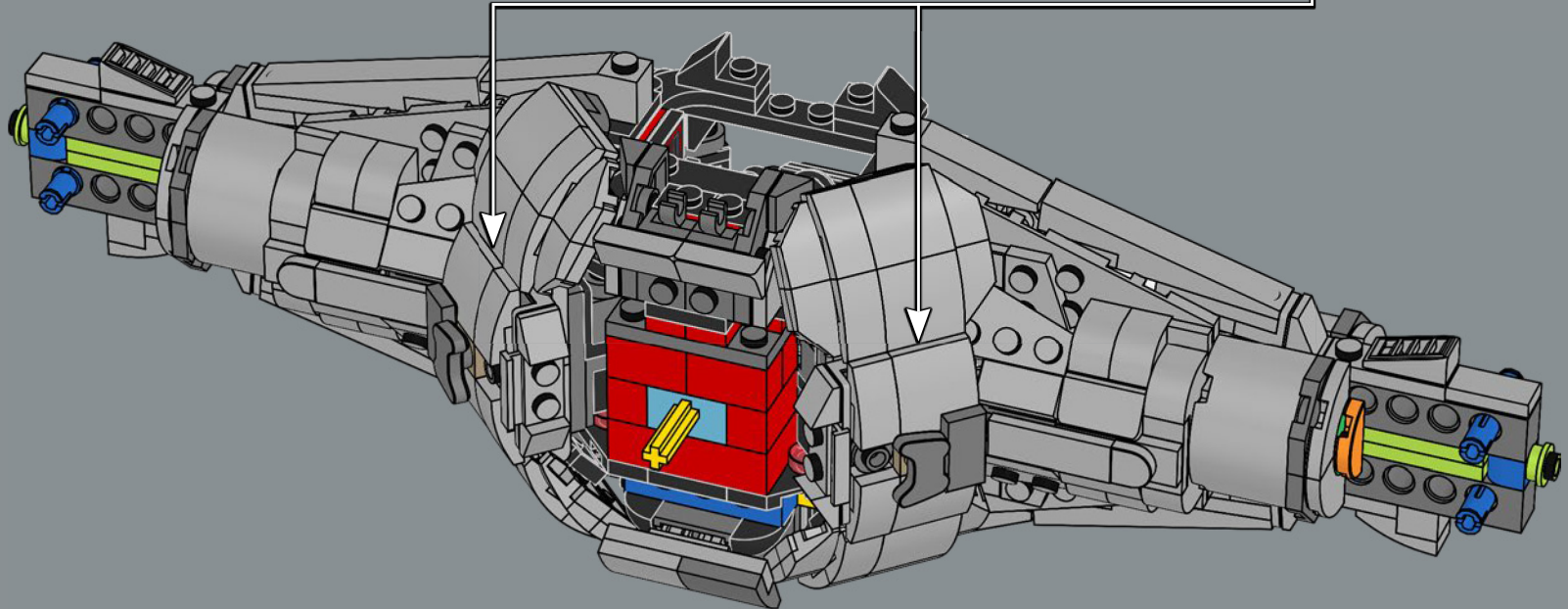
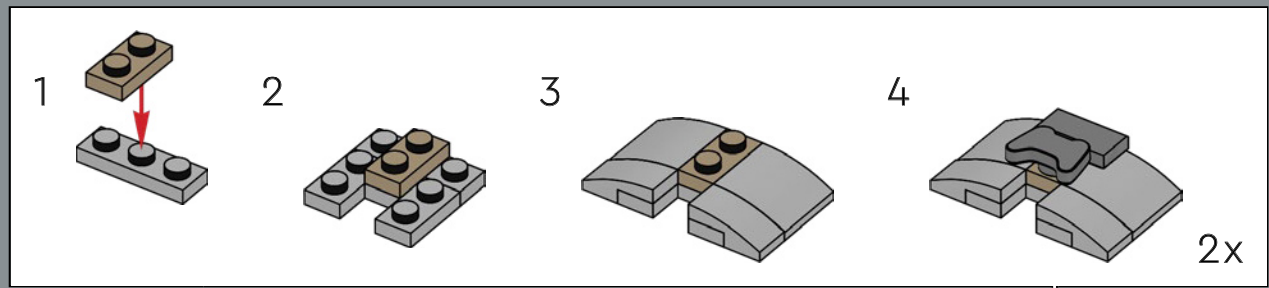

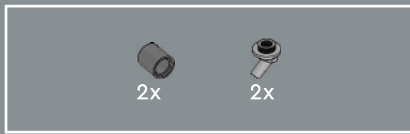

158

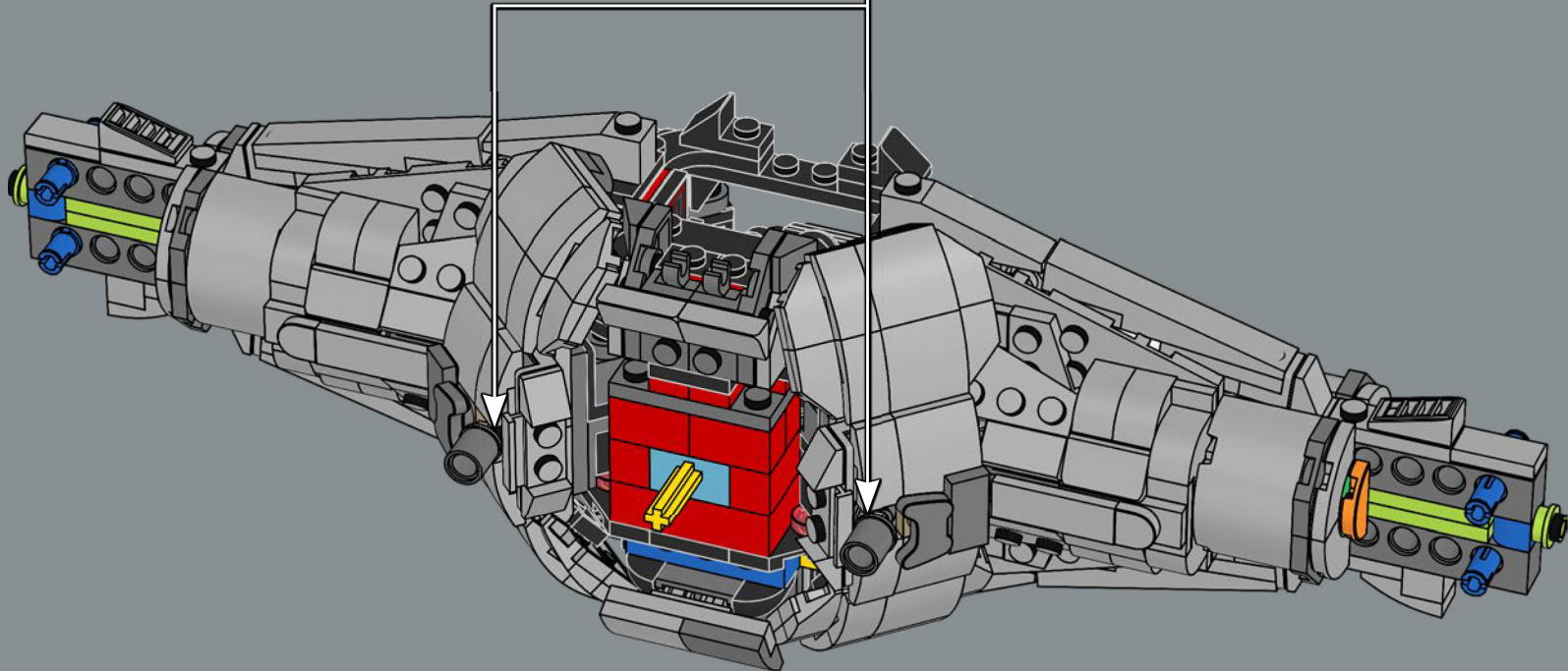
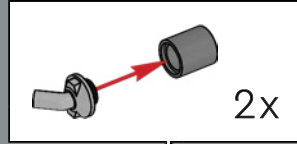



160

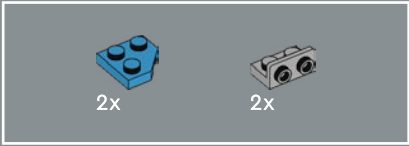
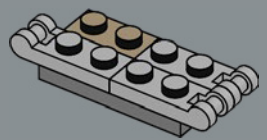

161

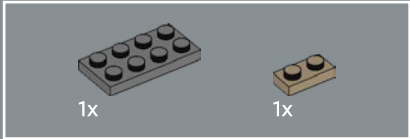
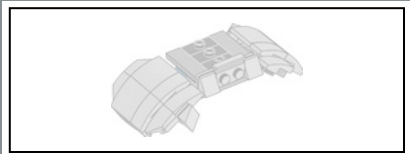
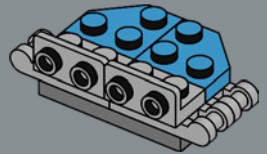

159

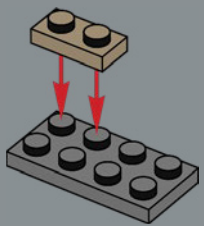

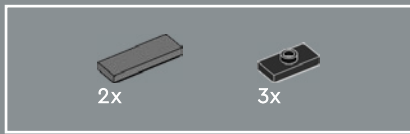

162

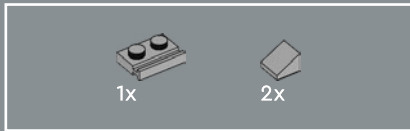
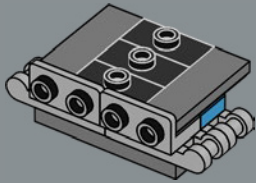

163

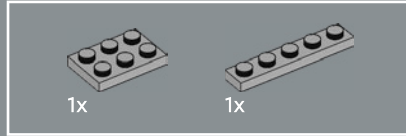
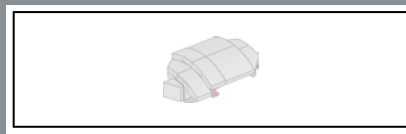
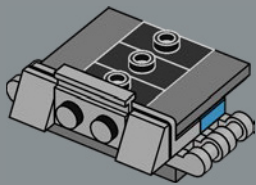

164

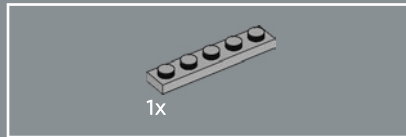
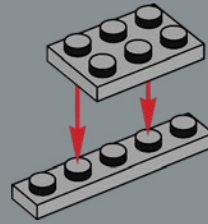

165

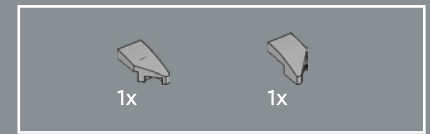
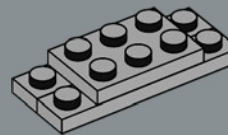

166

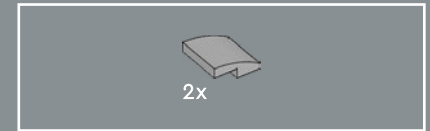
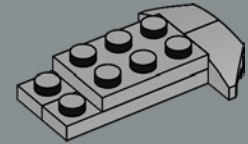

167

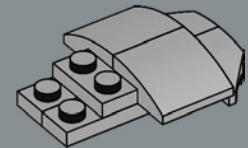



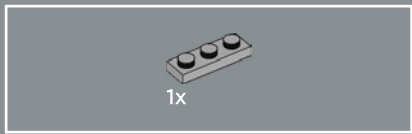

168

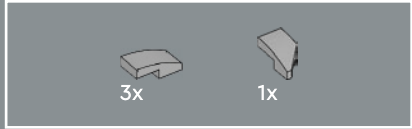
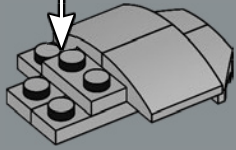
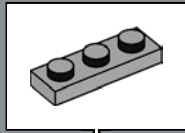

169

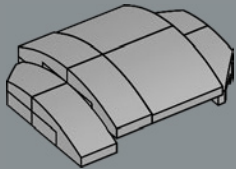

170

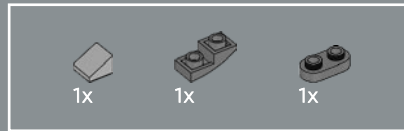
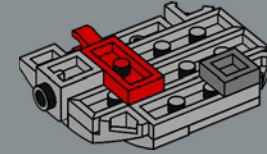

171

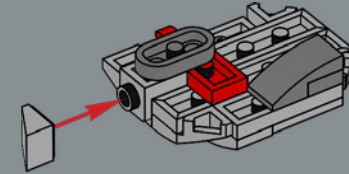

172

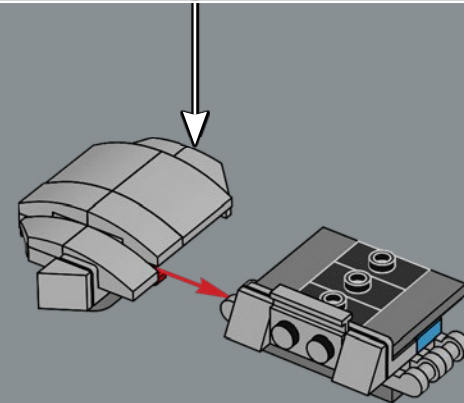

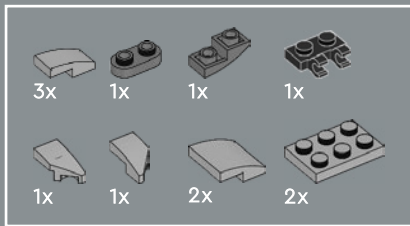

173

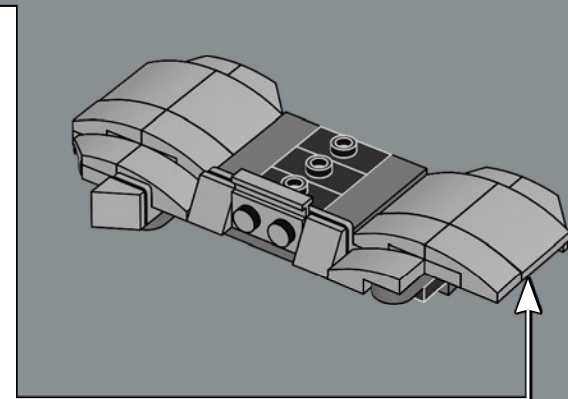
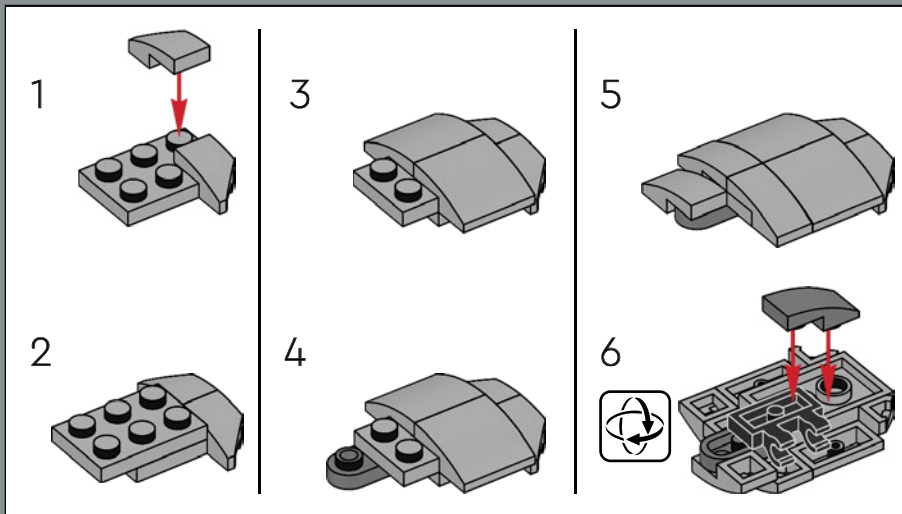

174

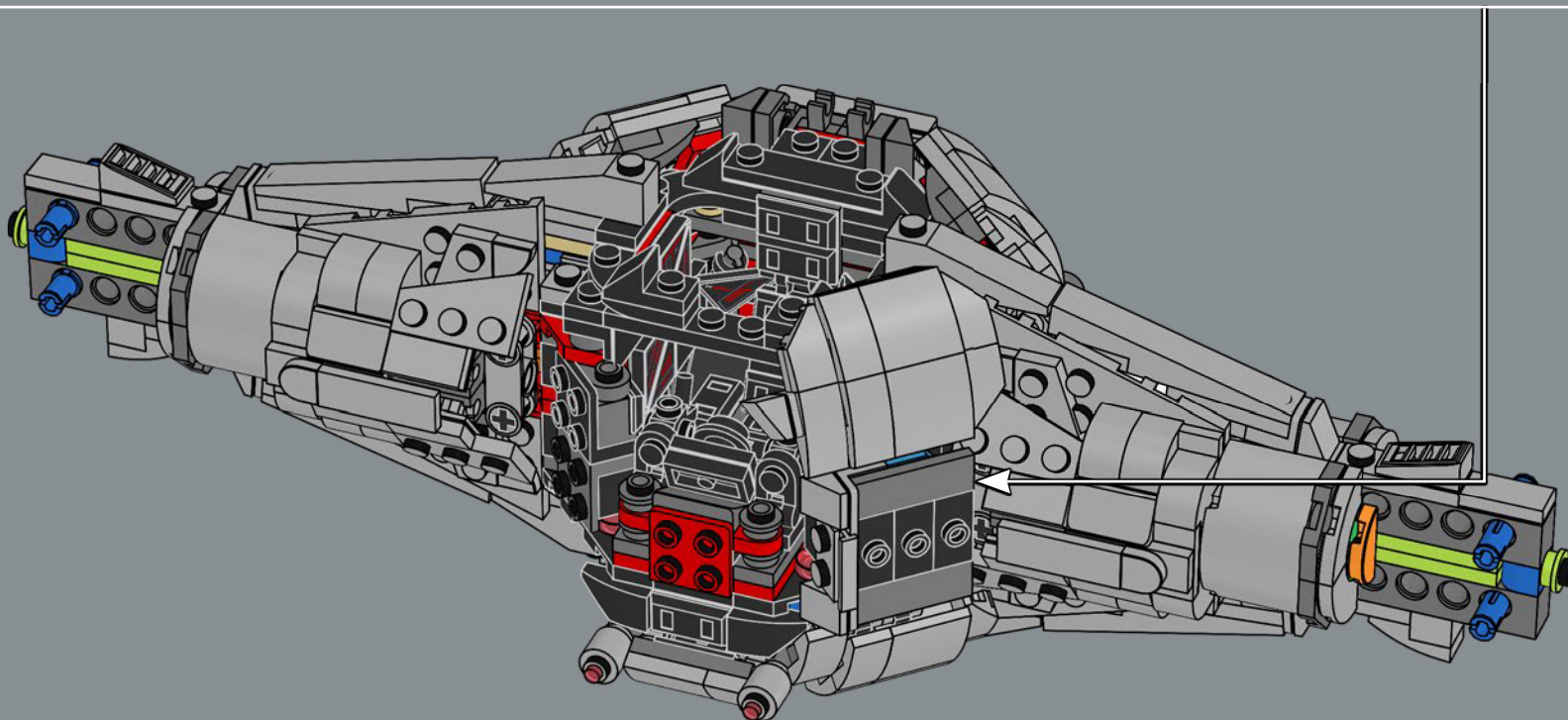

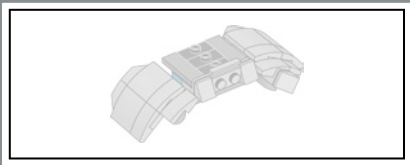

175

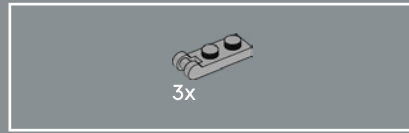
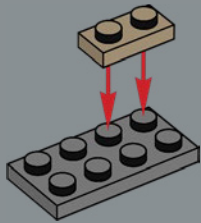

176

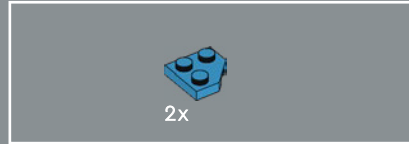
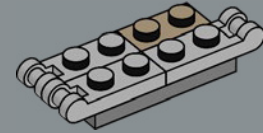

177

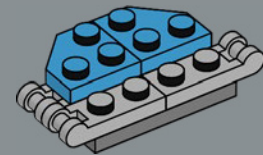



178

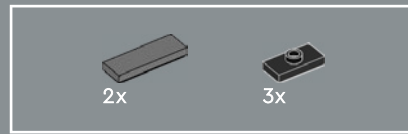
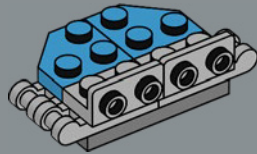

179

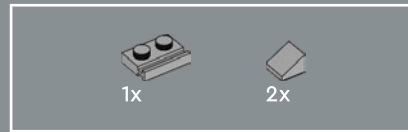
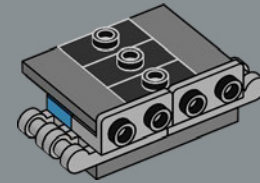

180

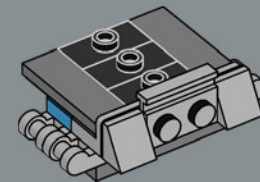



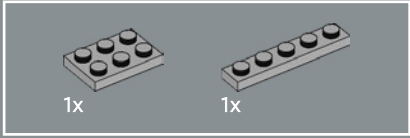
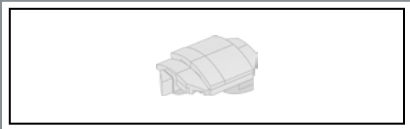

181

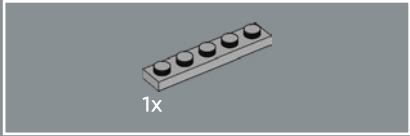
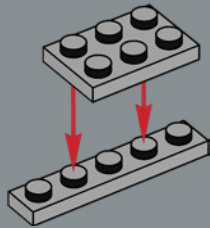

182

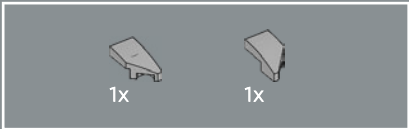
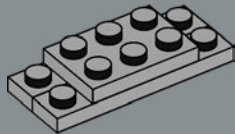

183

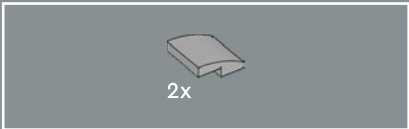
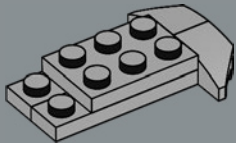

184

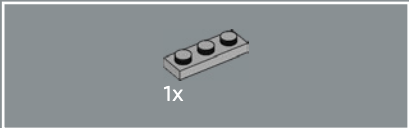
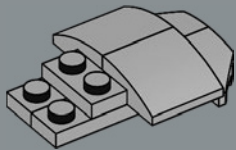

185

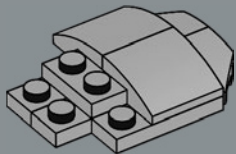

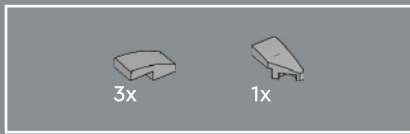

186

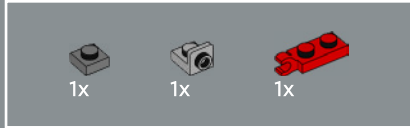
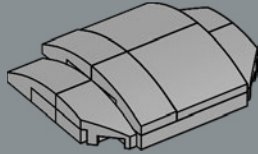

187

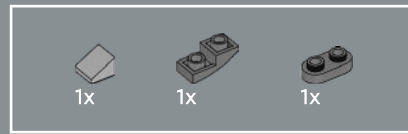
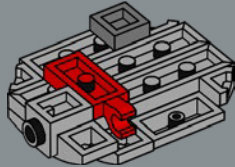

188

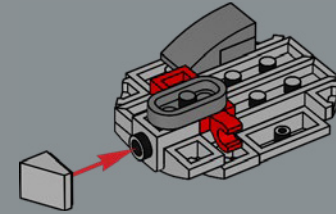

189

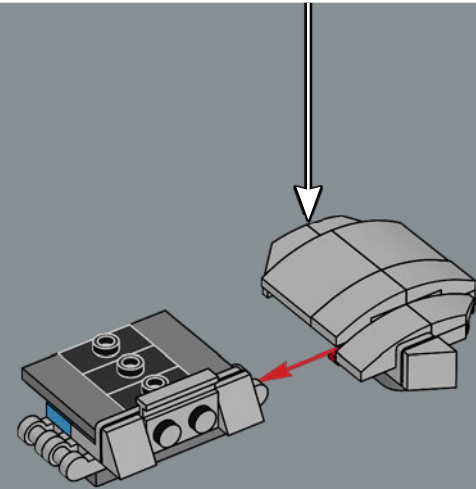

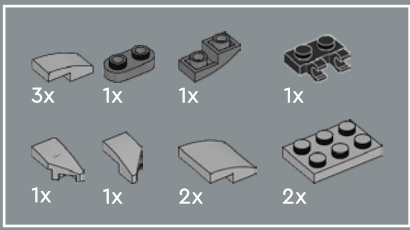

# 190

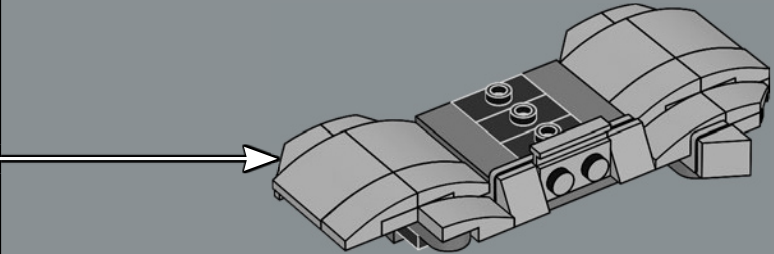
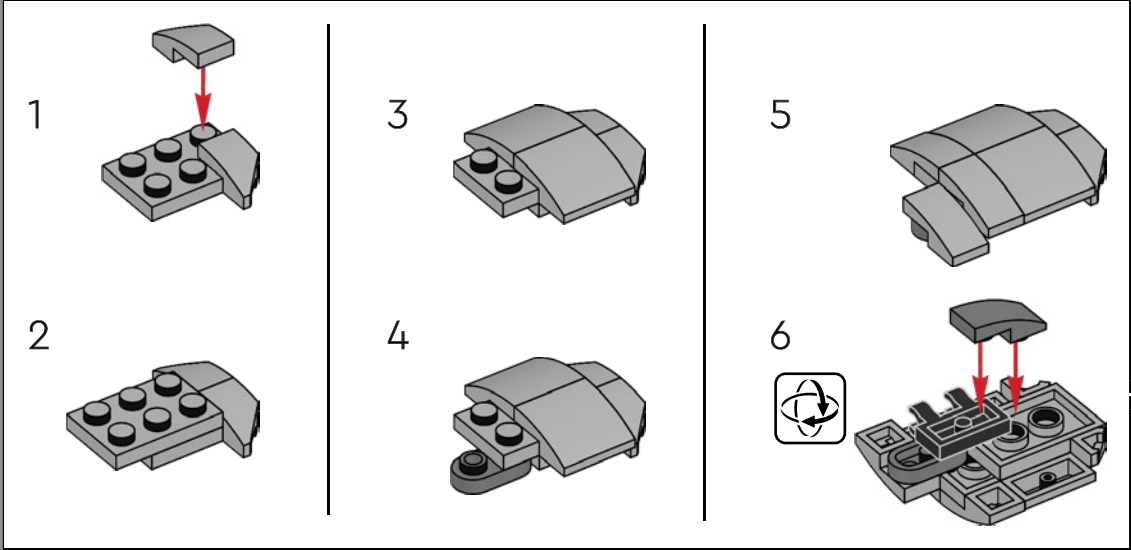

191

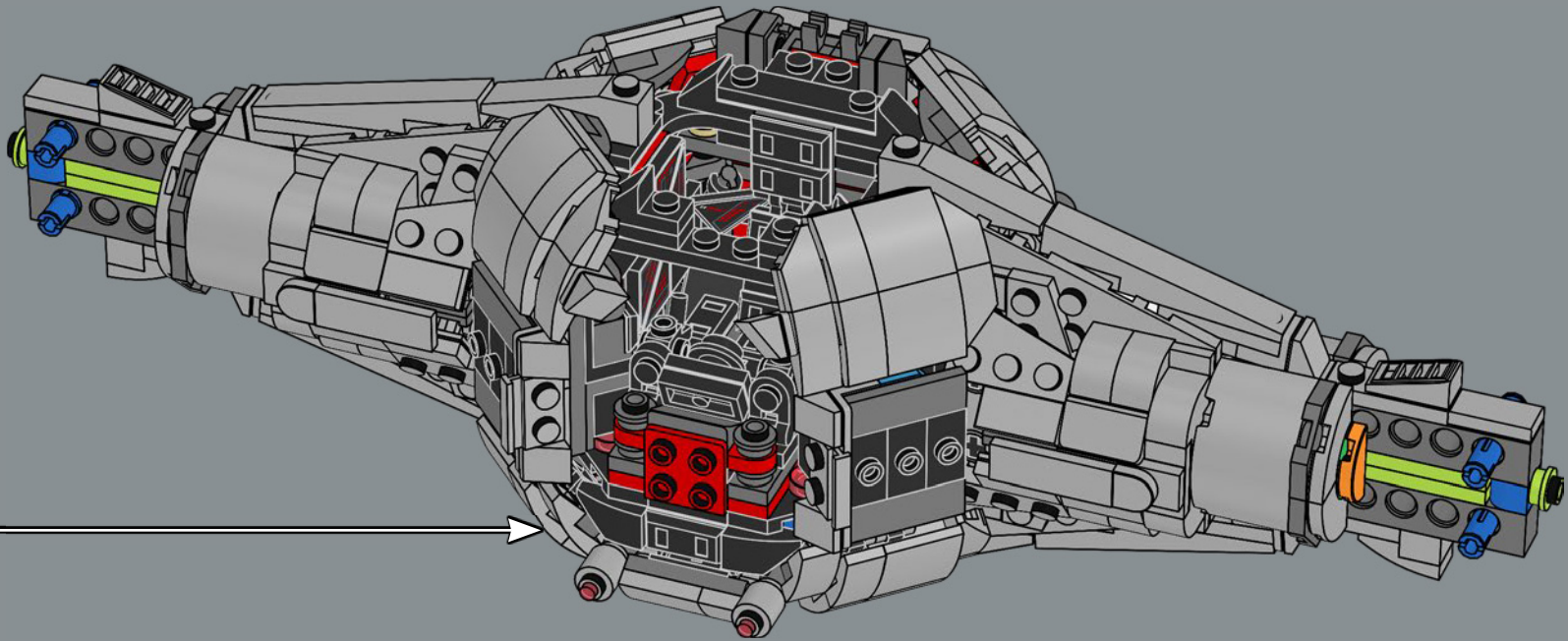



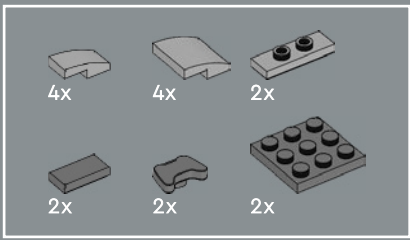

192

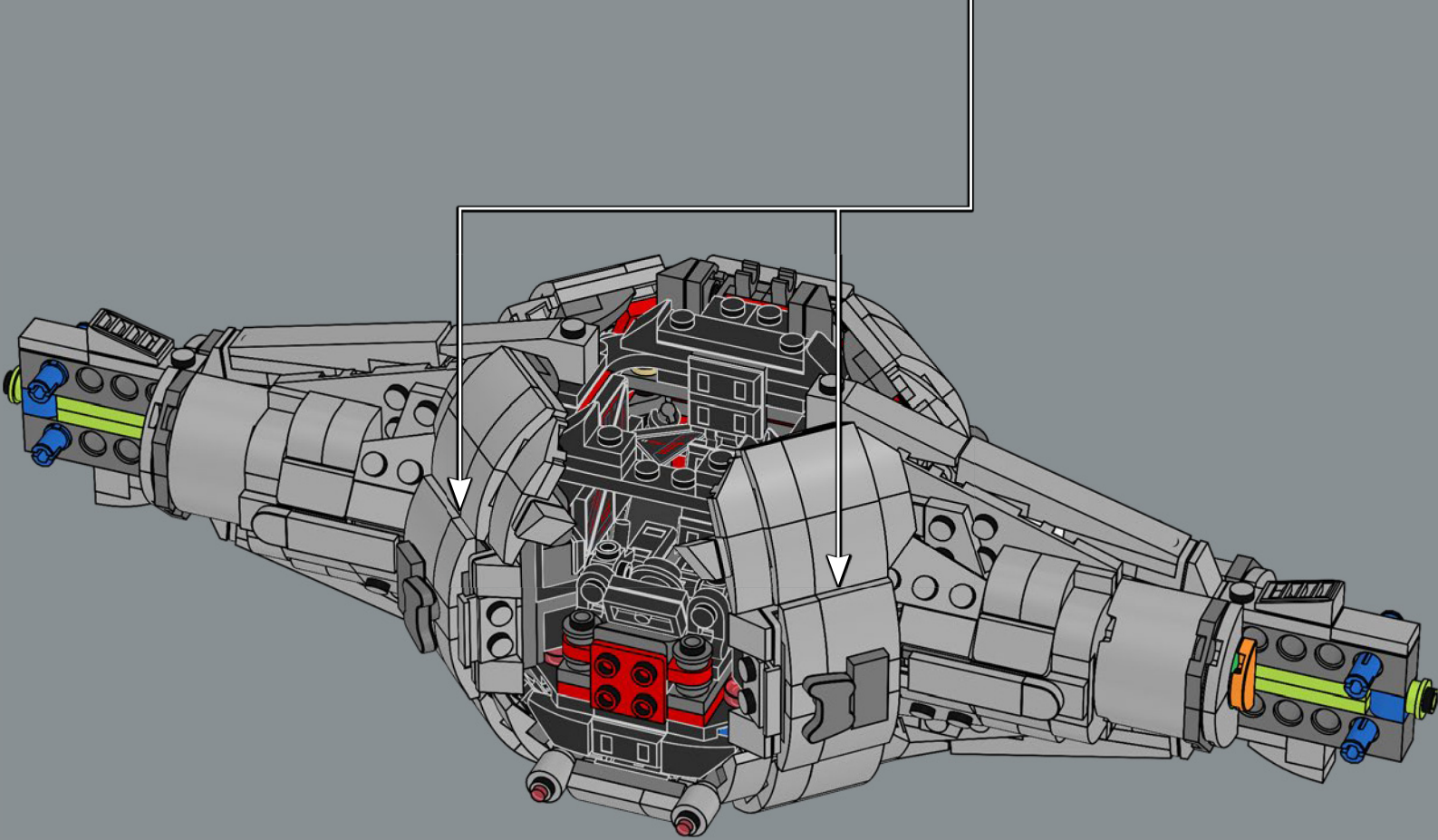
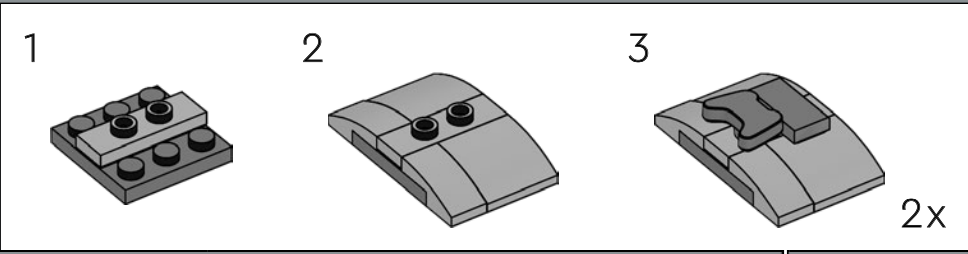



193

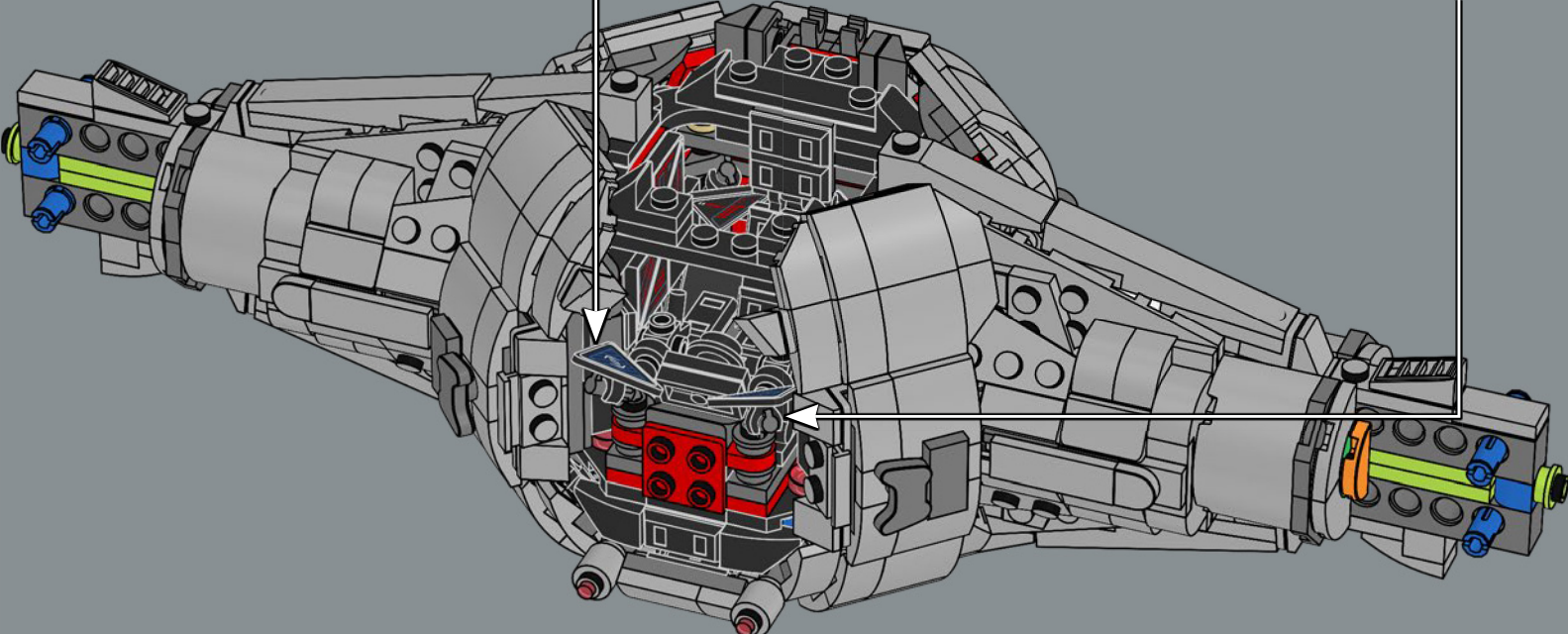
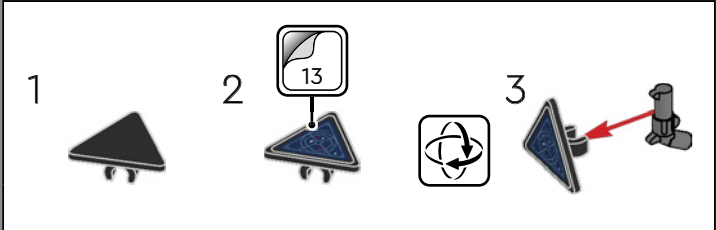
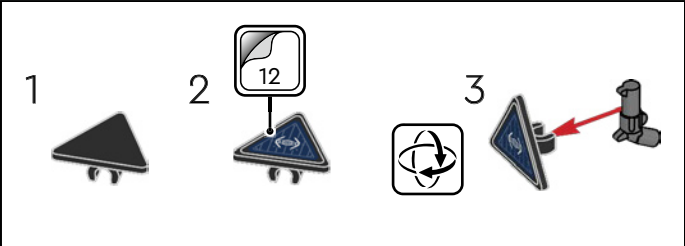

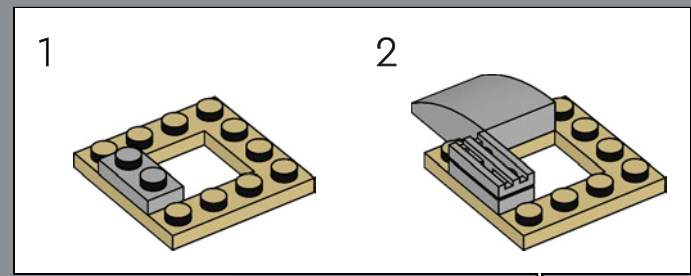
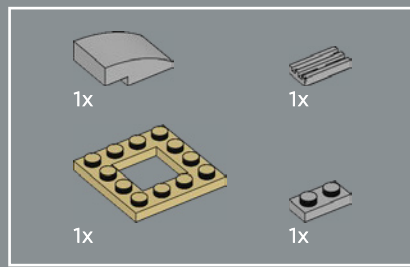

194

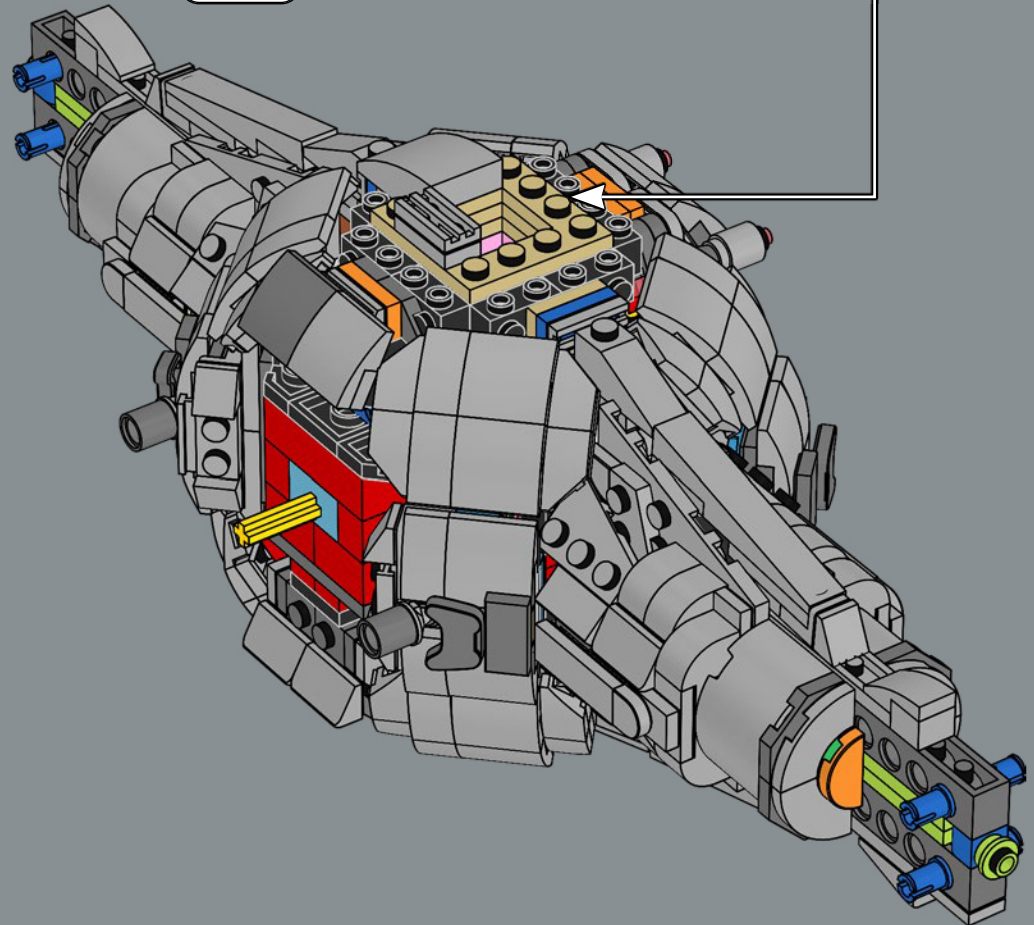

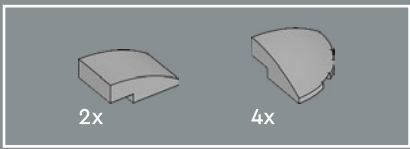

195

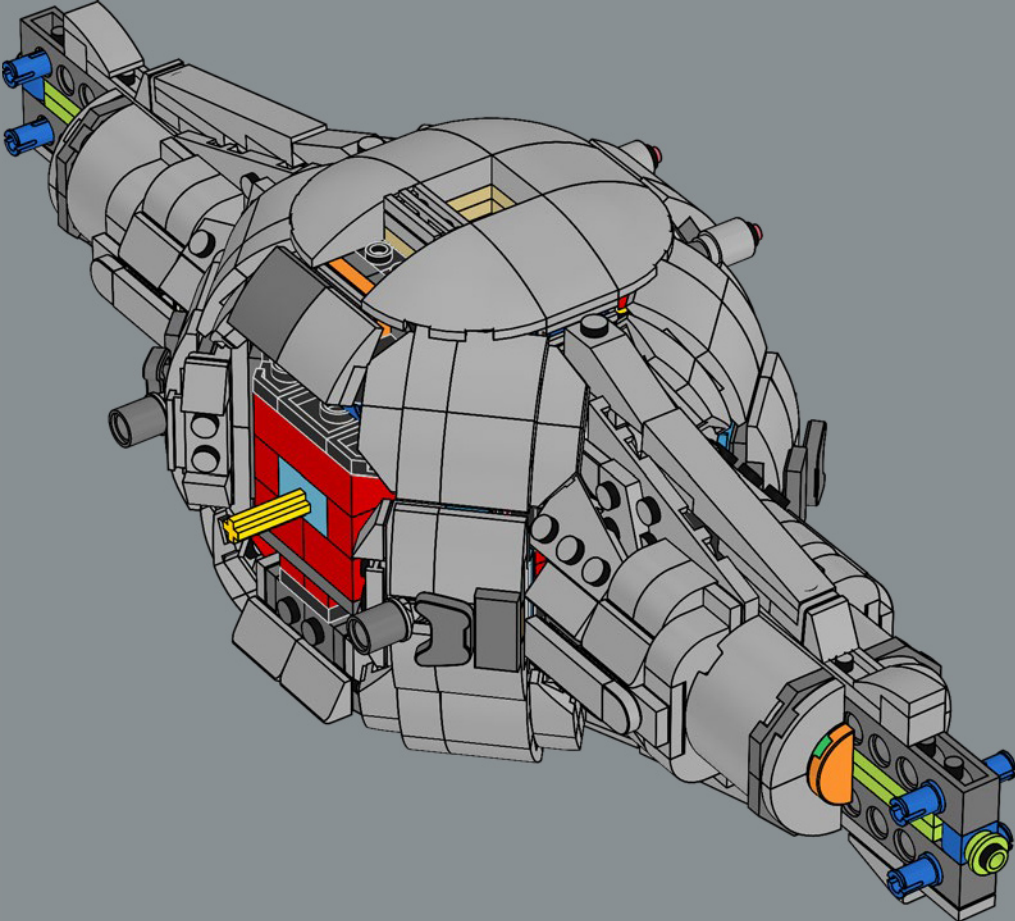



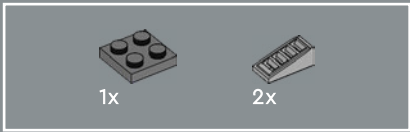

196

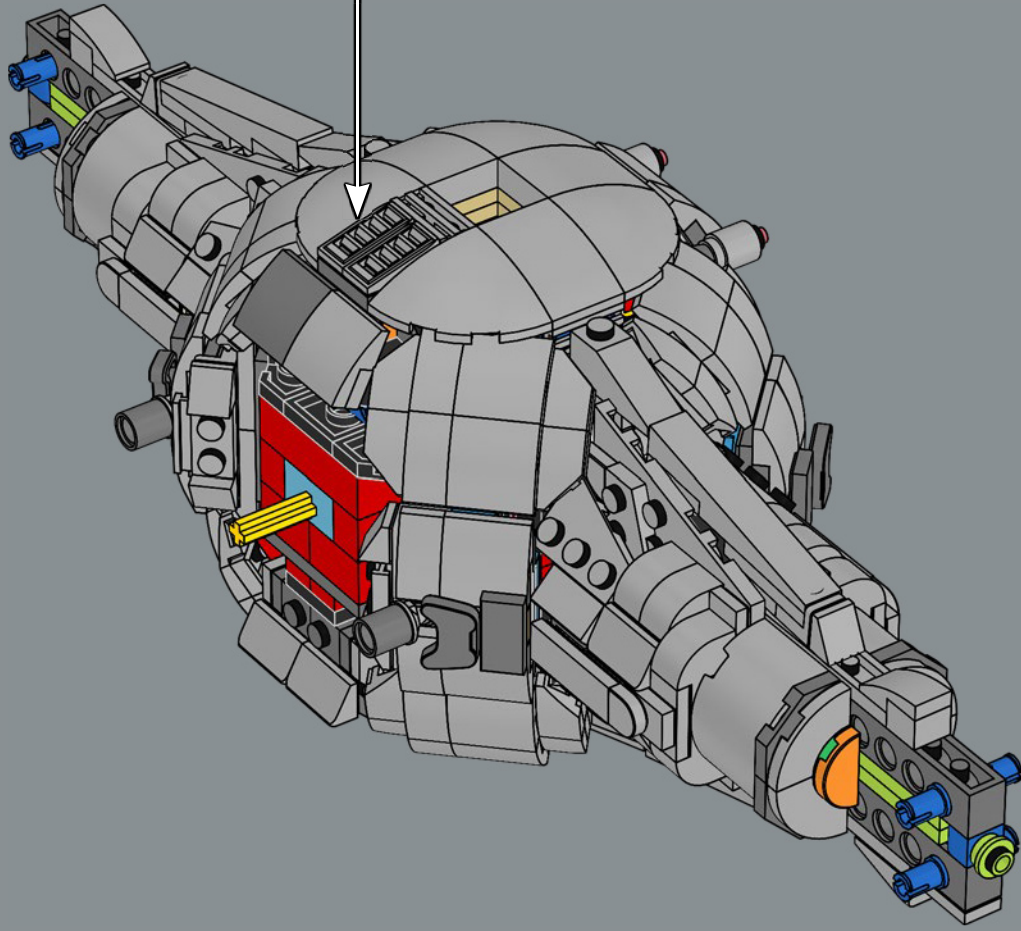
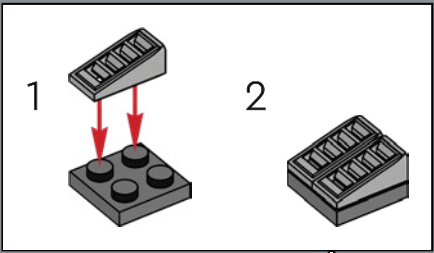

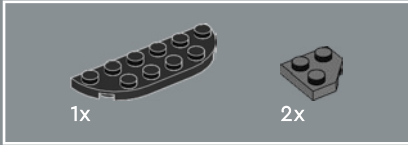

197

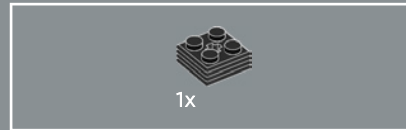
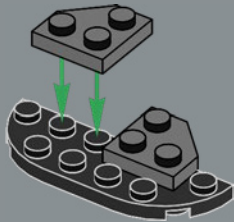

198

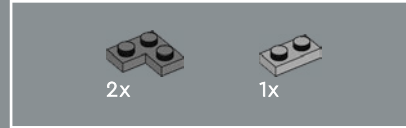
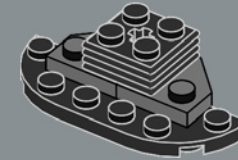

199

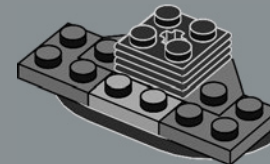

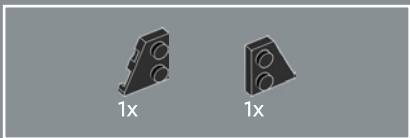

200

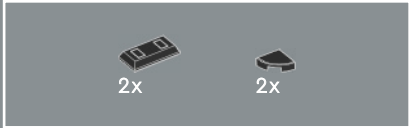
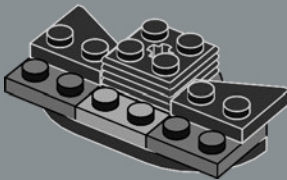

201

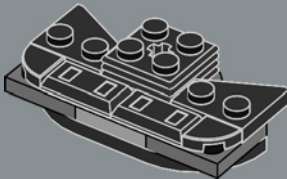

202

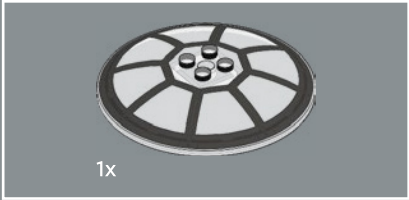
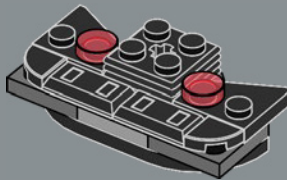

203



204

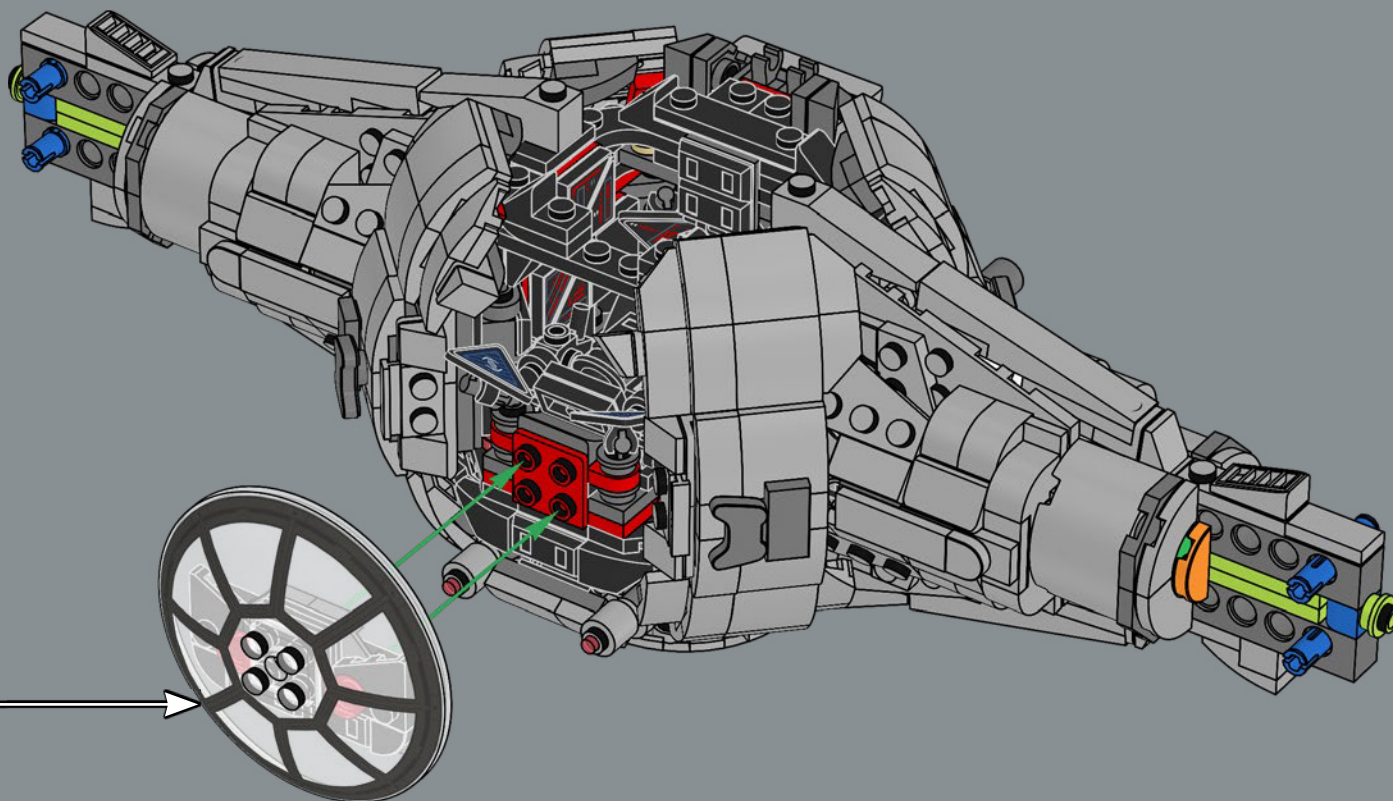





205

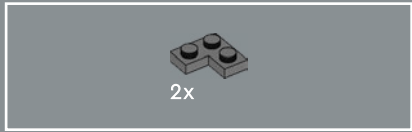
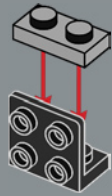

206

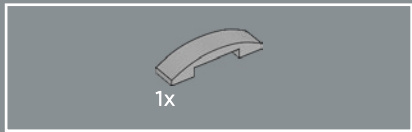
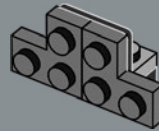

207

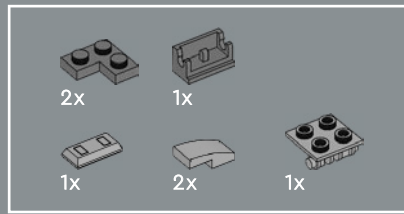
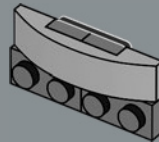

208

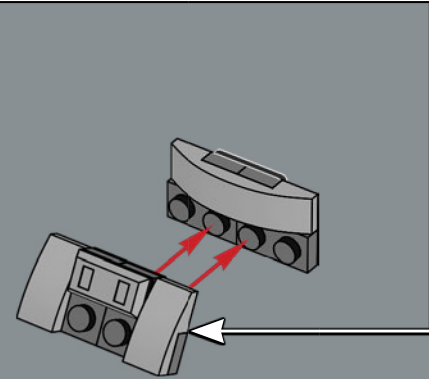
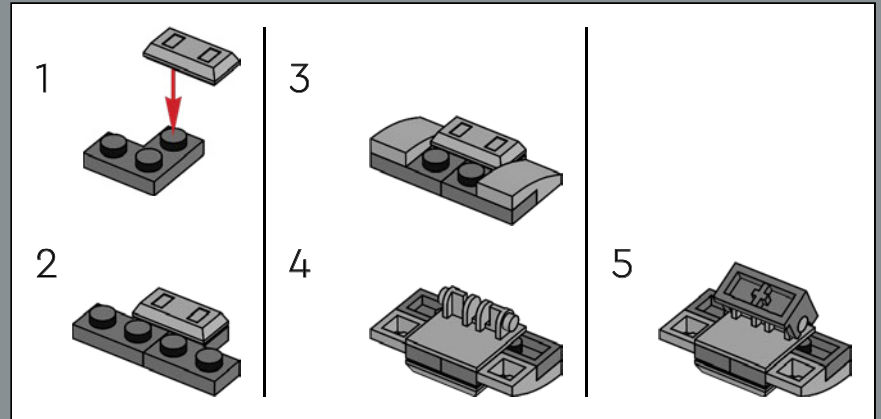

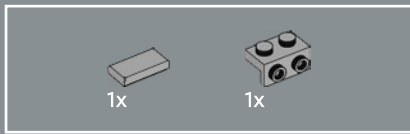

209

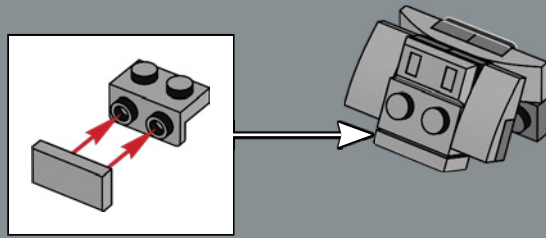

210

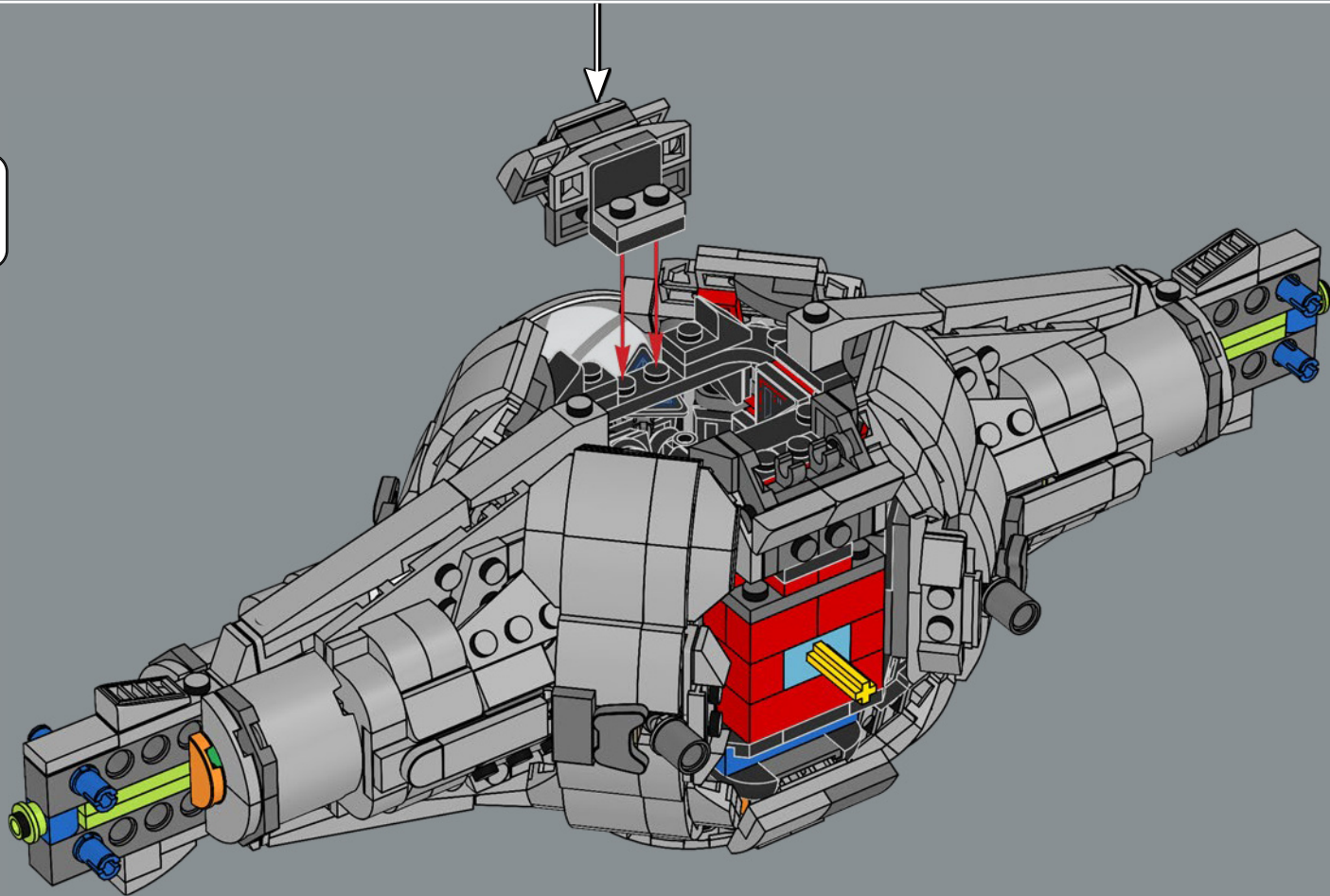

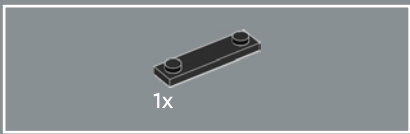

211

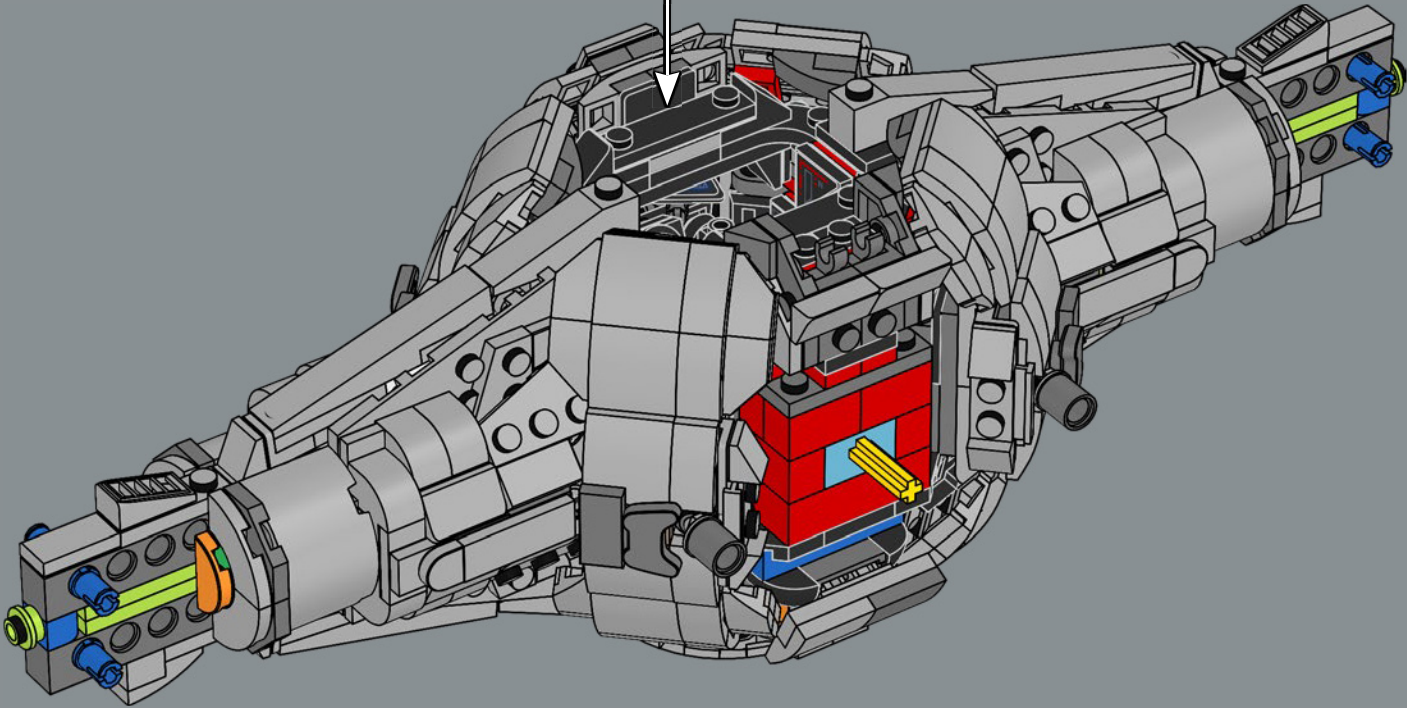
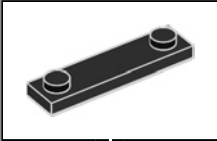

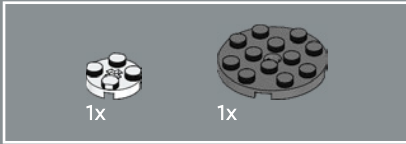
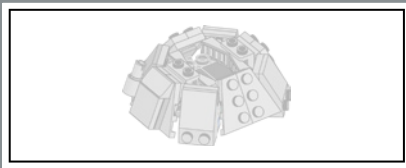

212

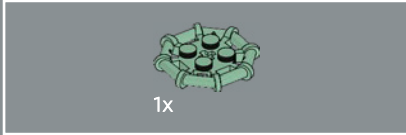

213

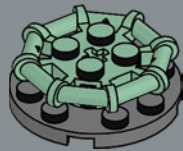

214

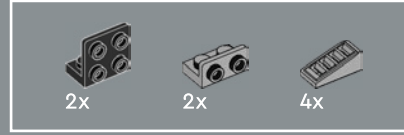
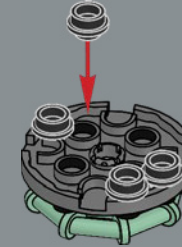

215

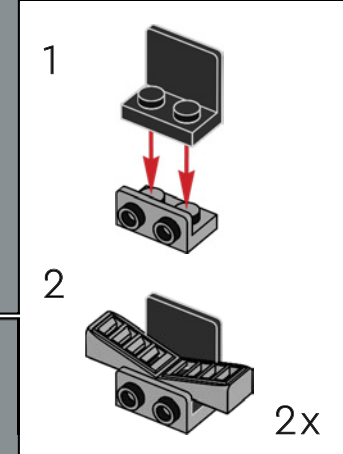
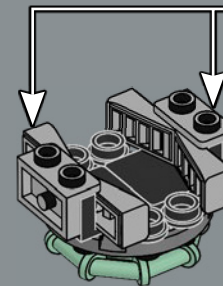





216

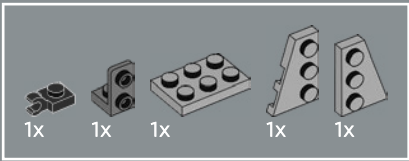
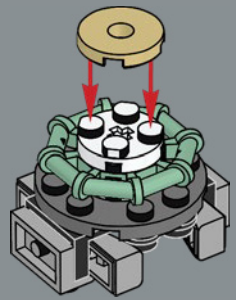

217

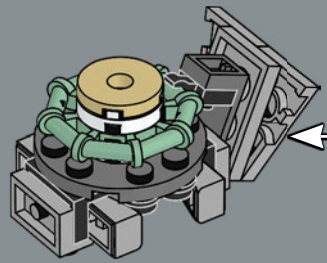
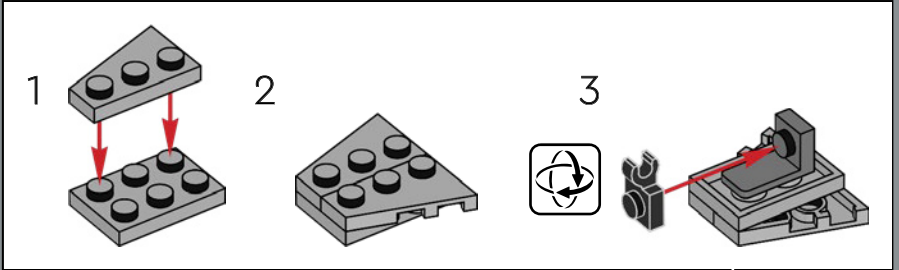

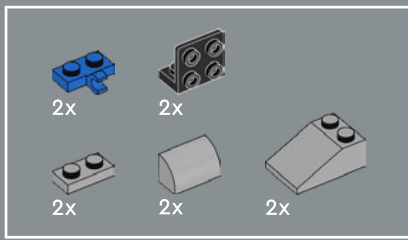

218

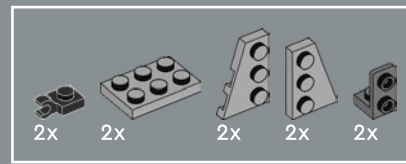
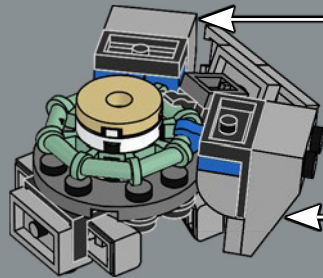
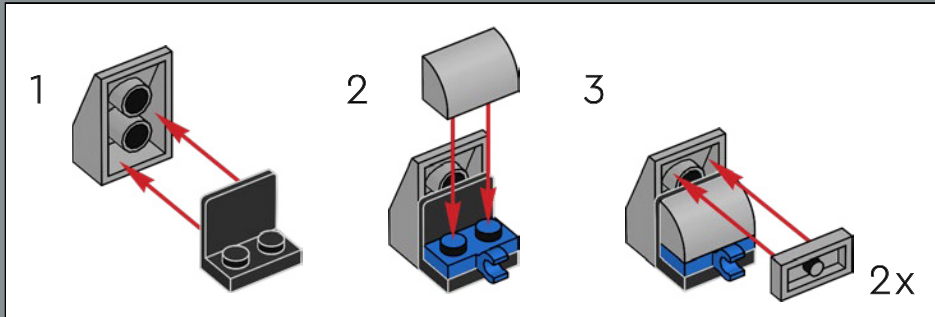

219

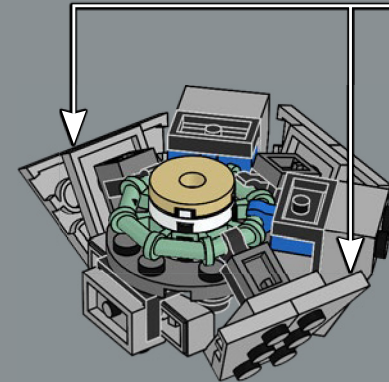
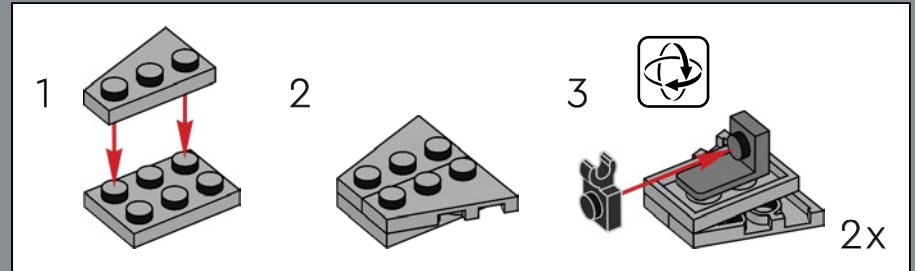

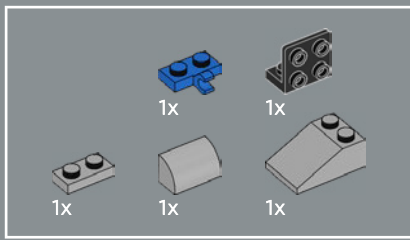

220

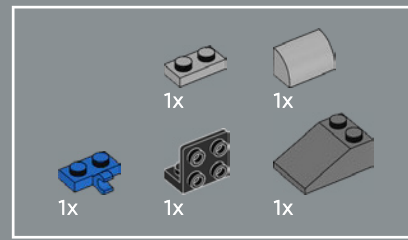
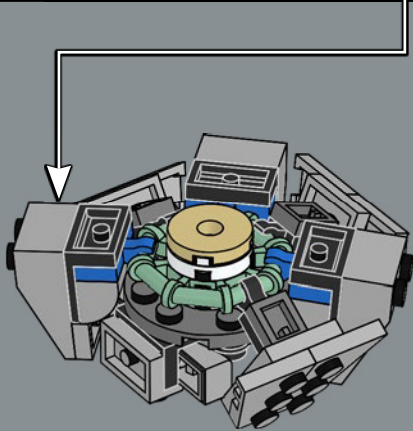
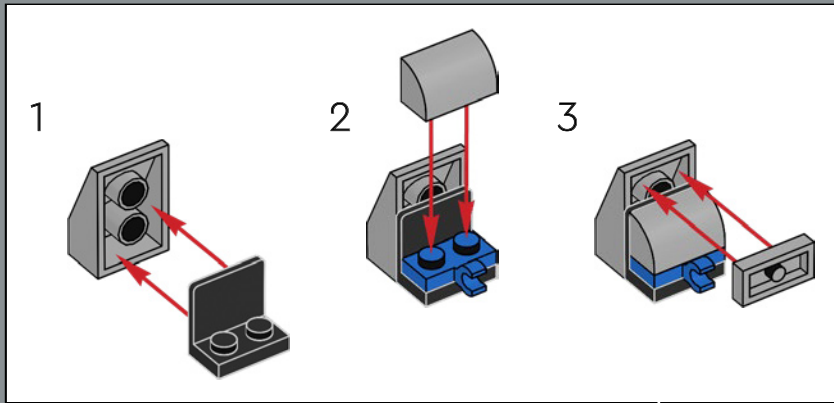

221

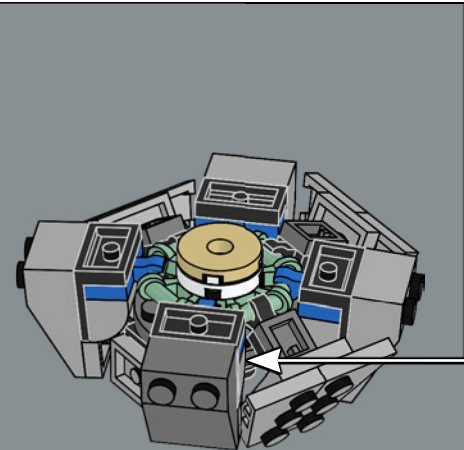
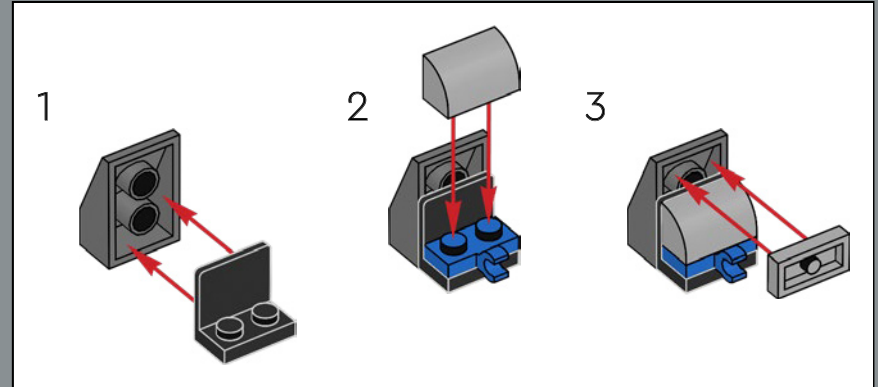

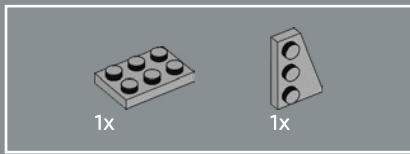

222

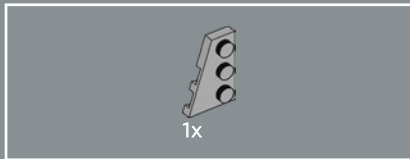
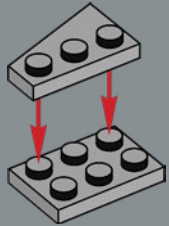

223

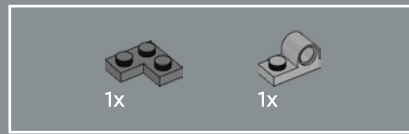
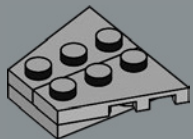

224

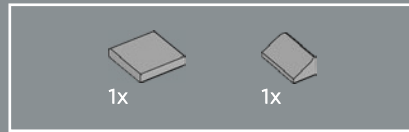
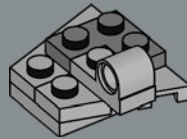

225

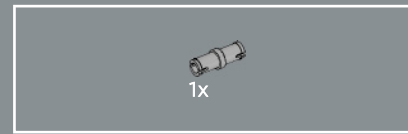
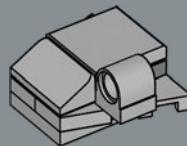

226

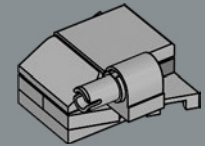

227

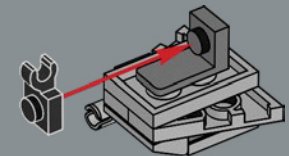



228

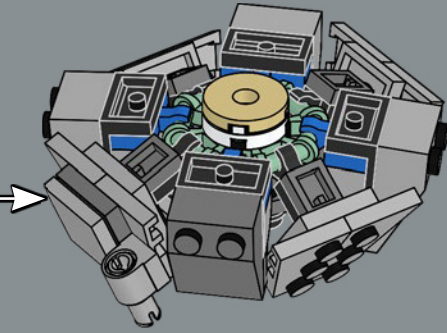

229

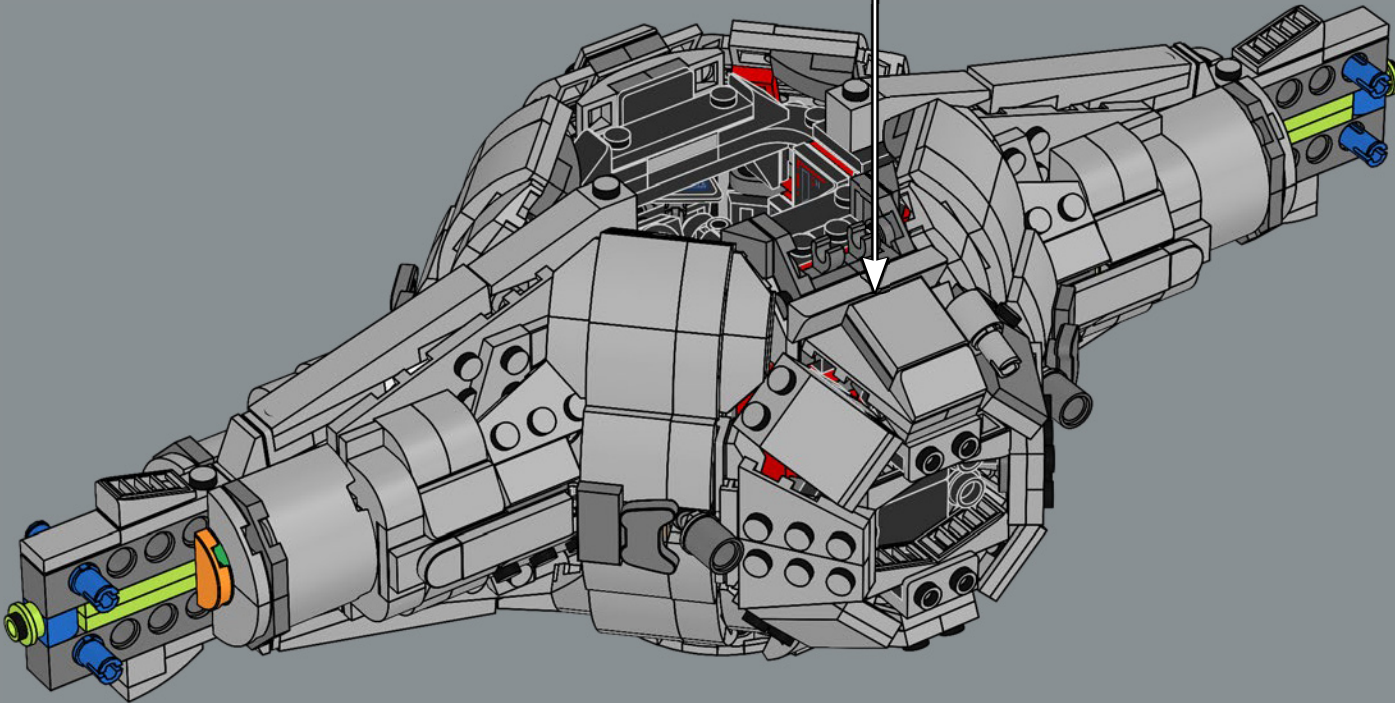

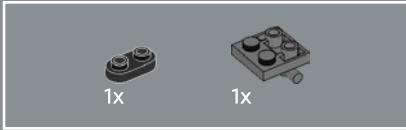

230

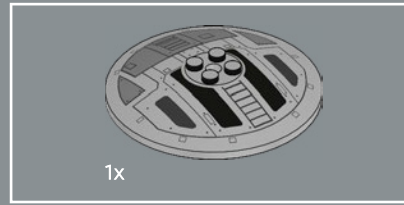
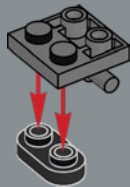

231

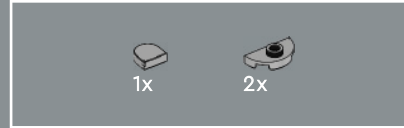
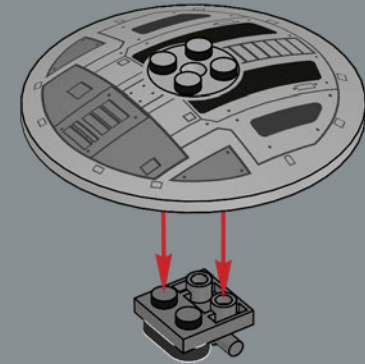

232

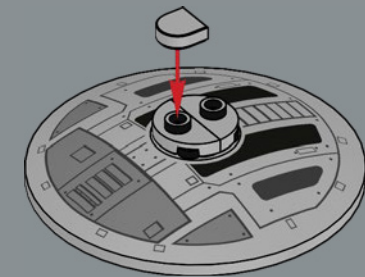

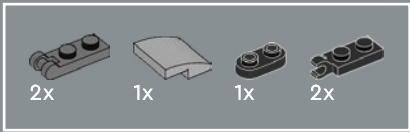

233

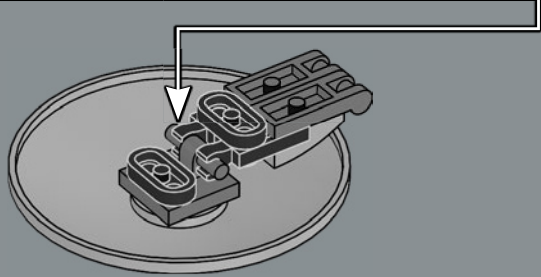
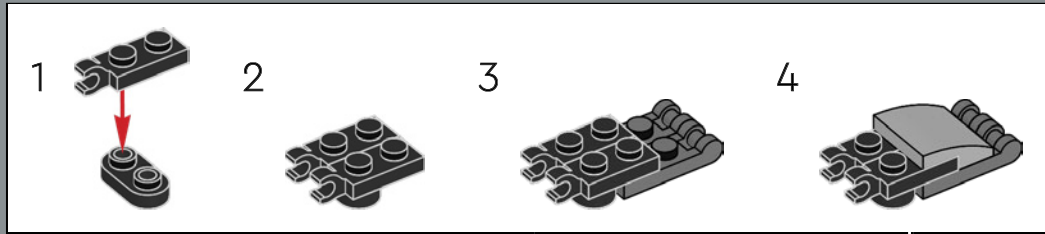

234

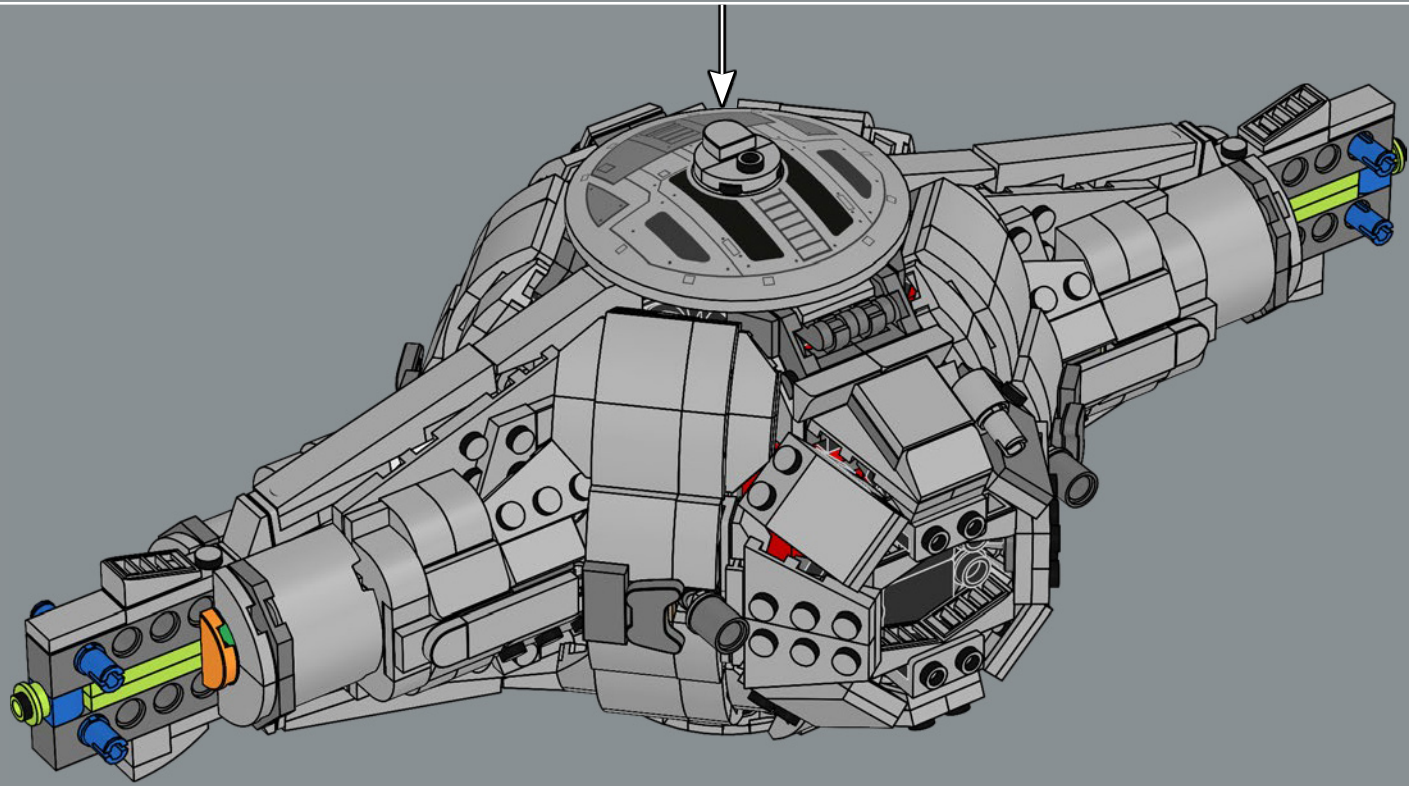

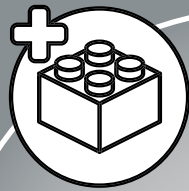

1x

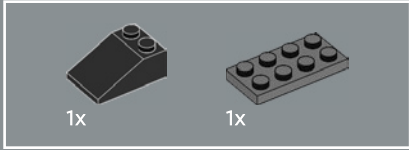
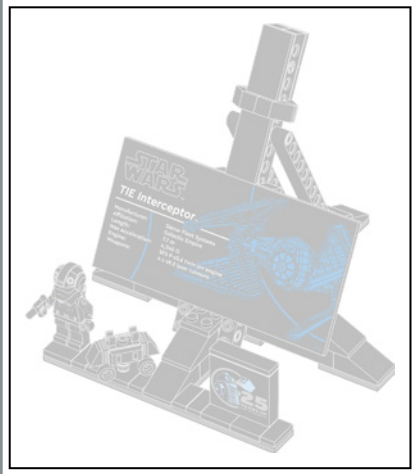

235

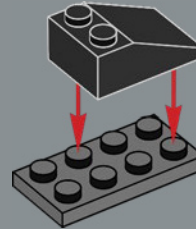



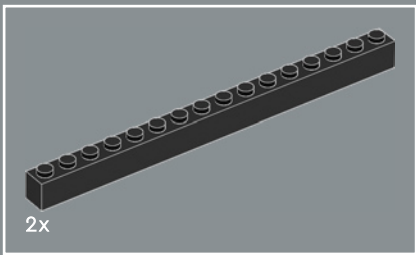

236

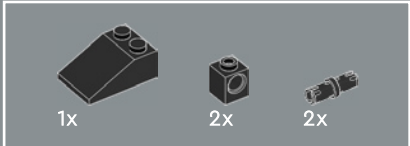
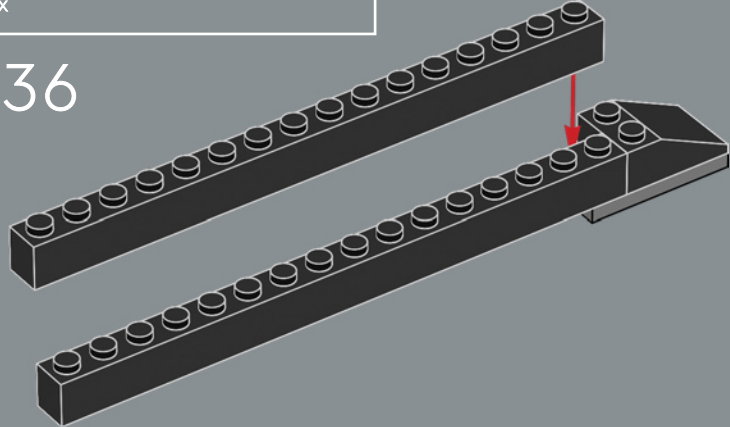

237

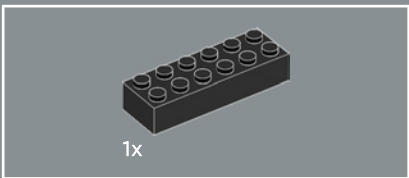
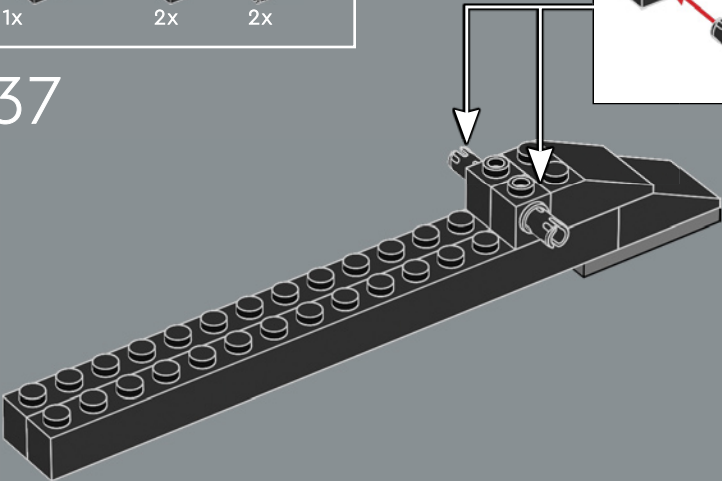
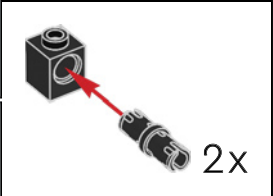

238

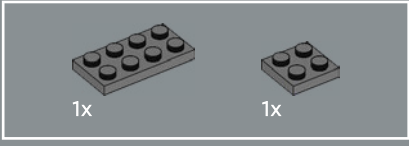
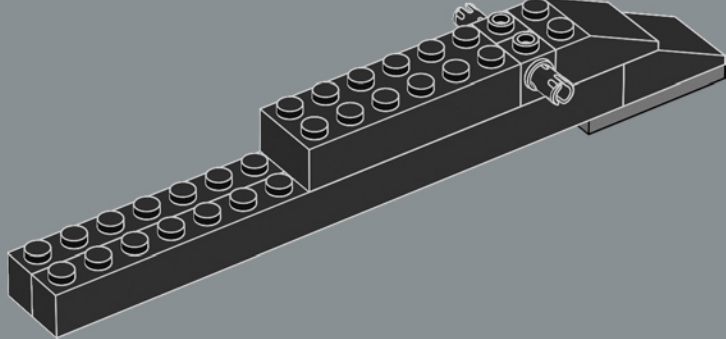

239

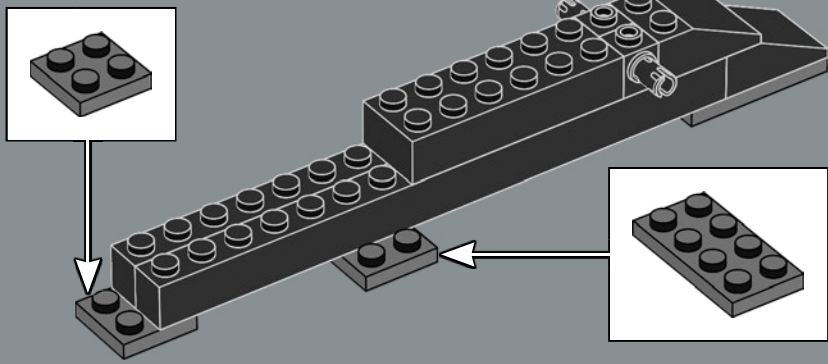

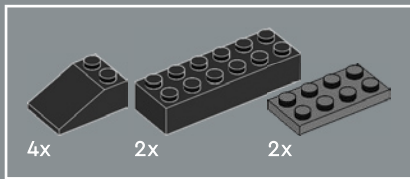

240

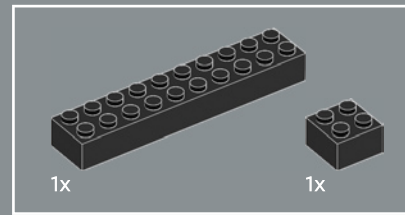
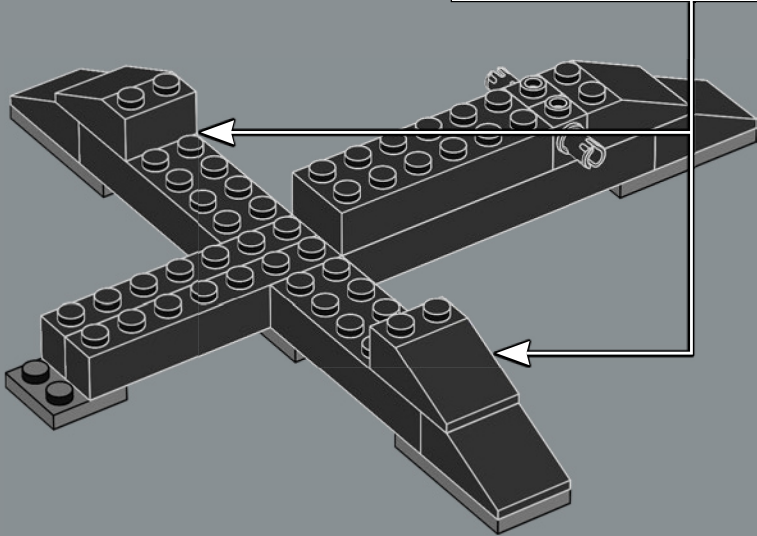
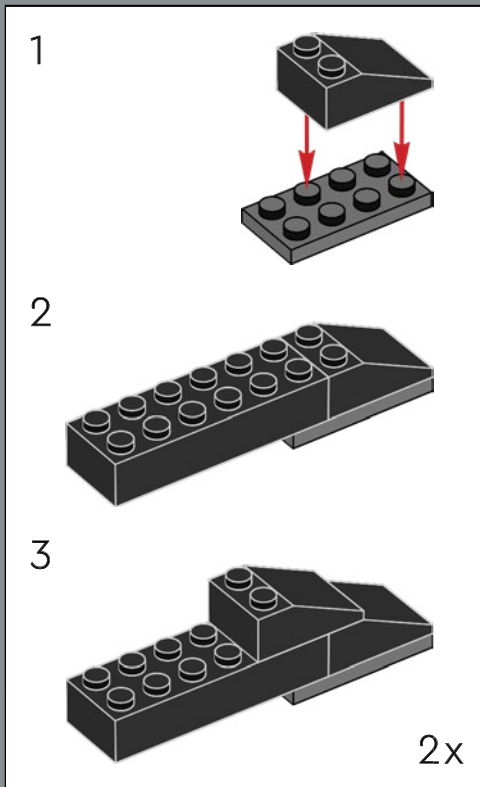

241

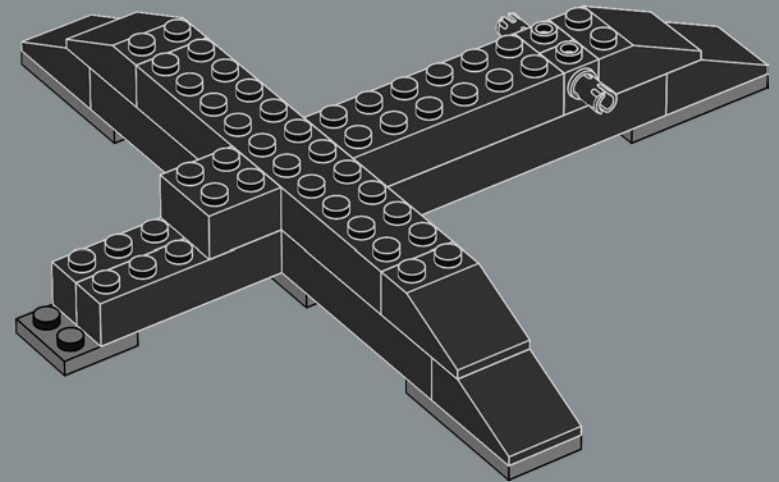

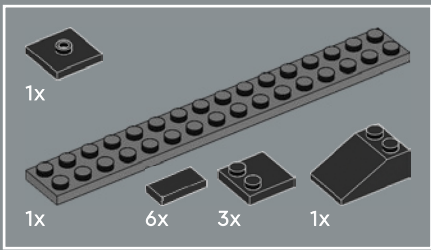

242

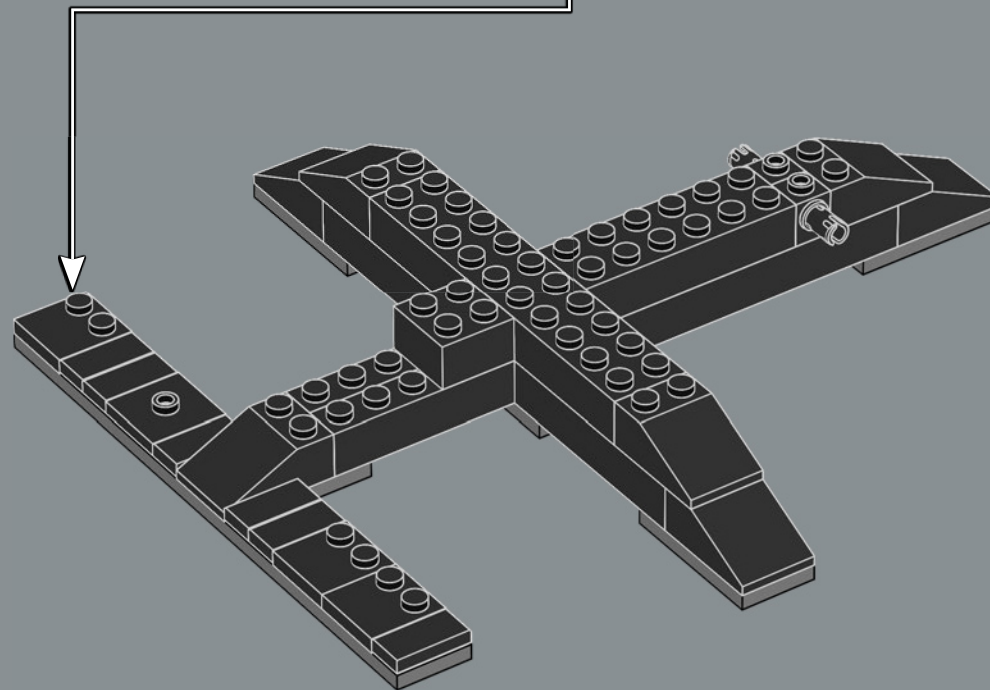
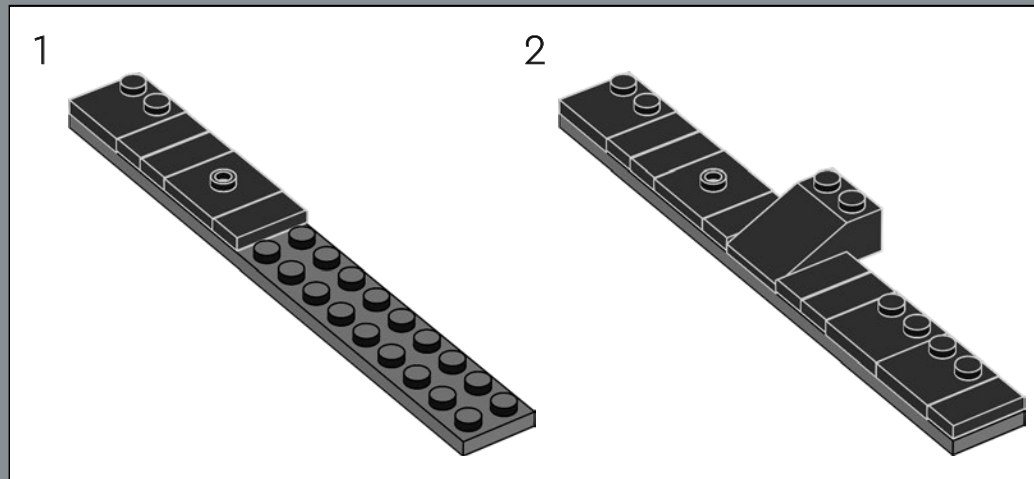

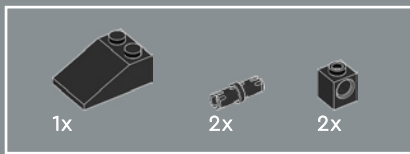

243

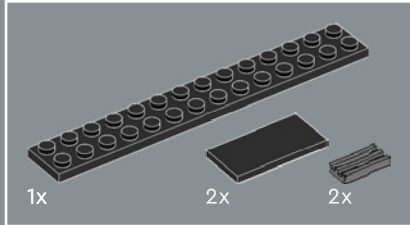
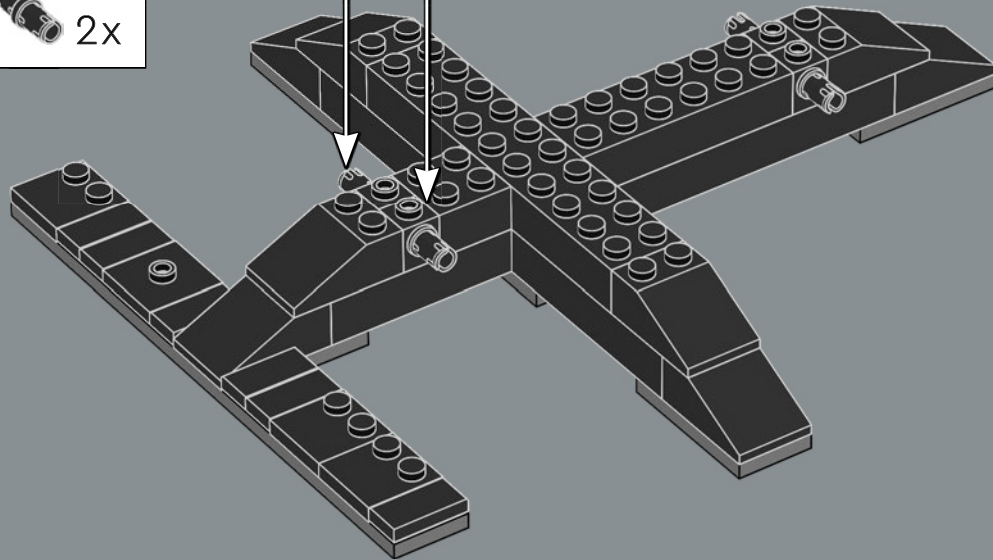
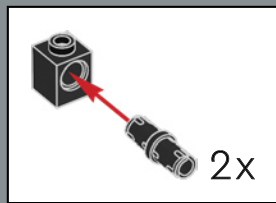

244

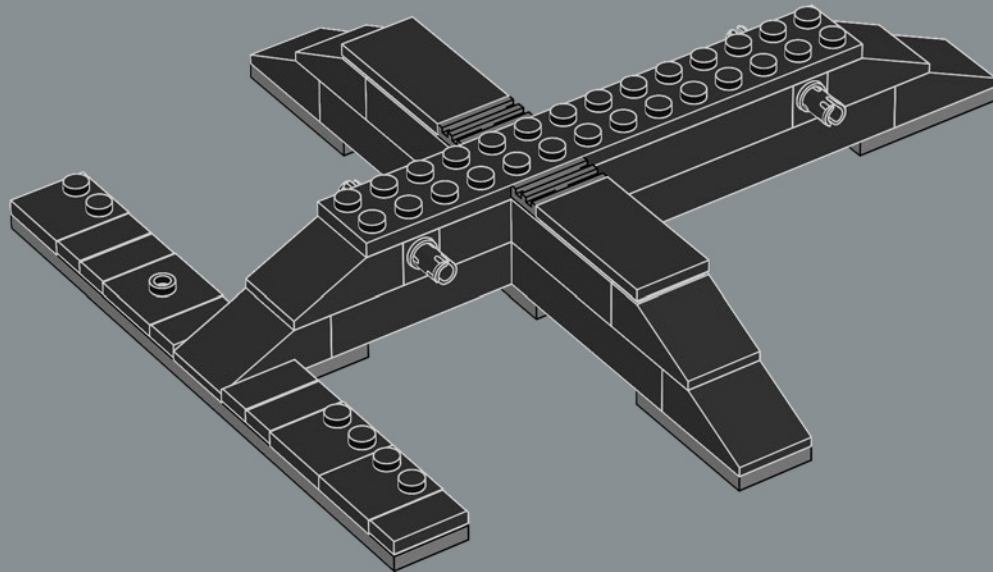



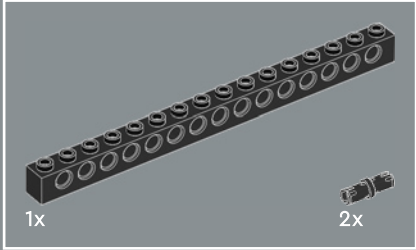
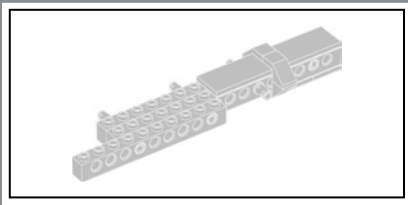

245

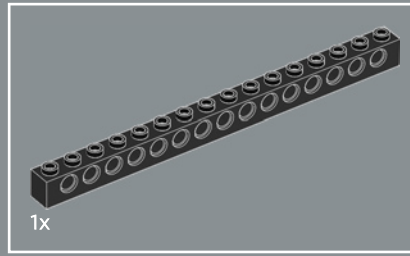
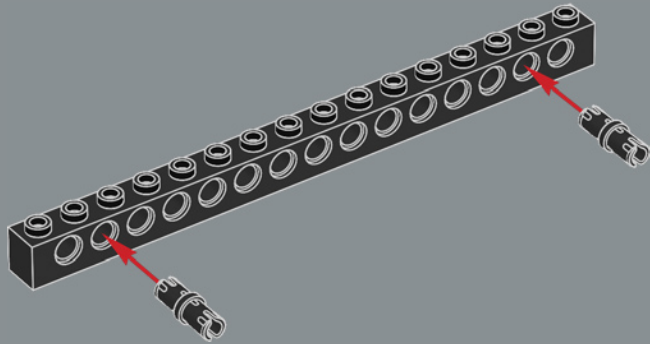

246

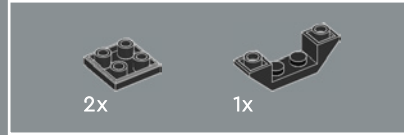
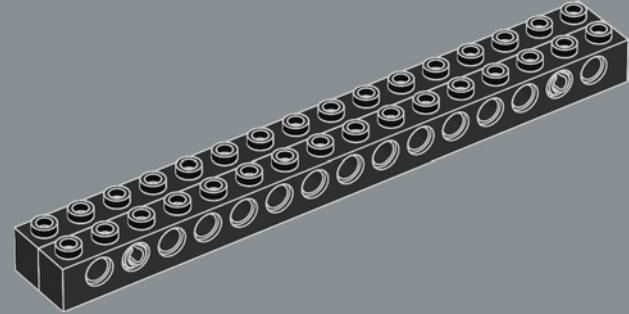

247

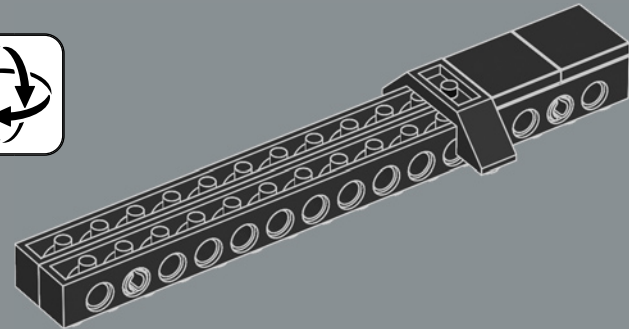

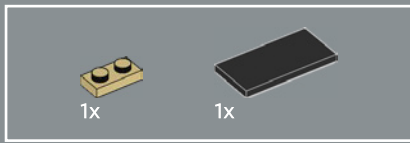

248

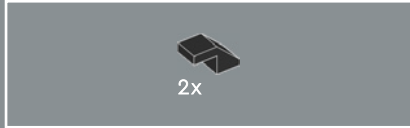
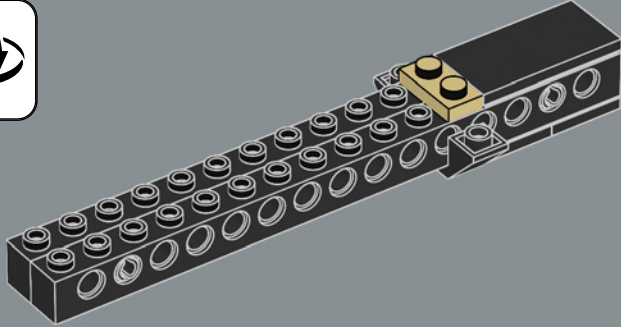

249

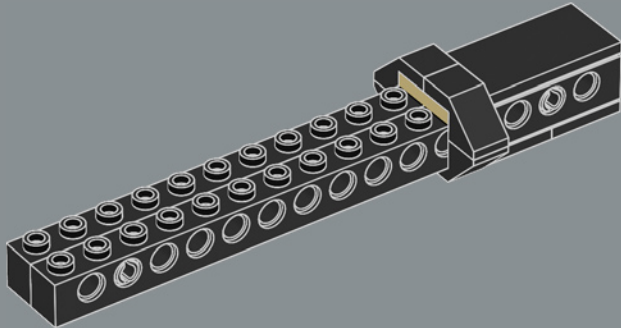

250

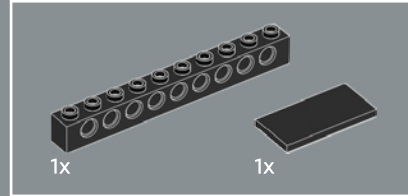
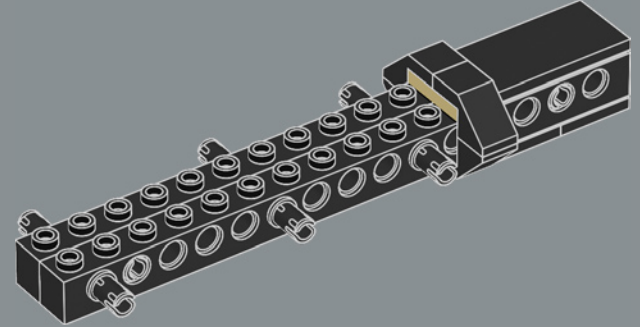

251

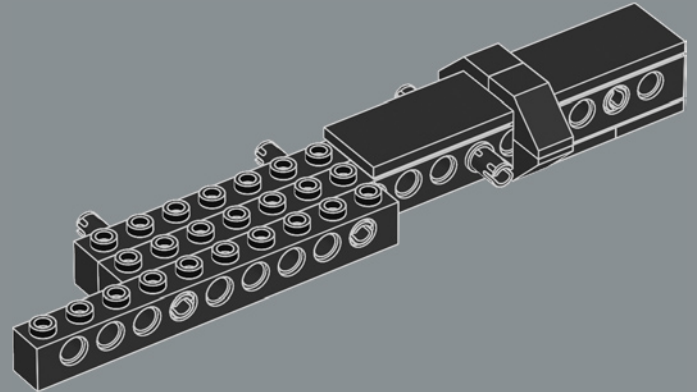

252

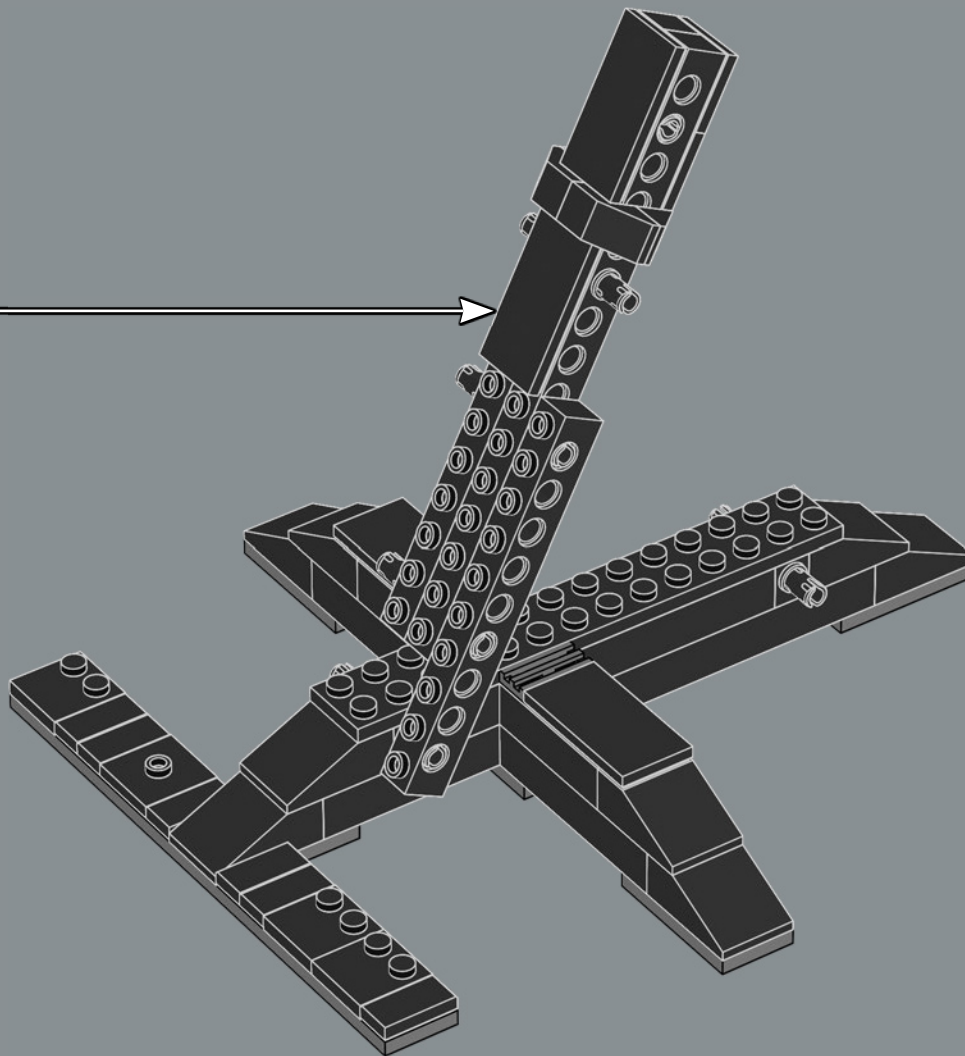

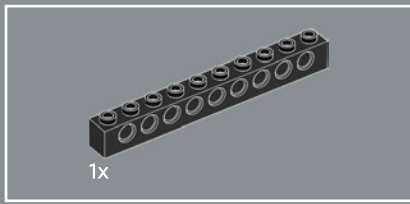

253

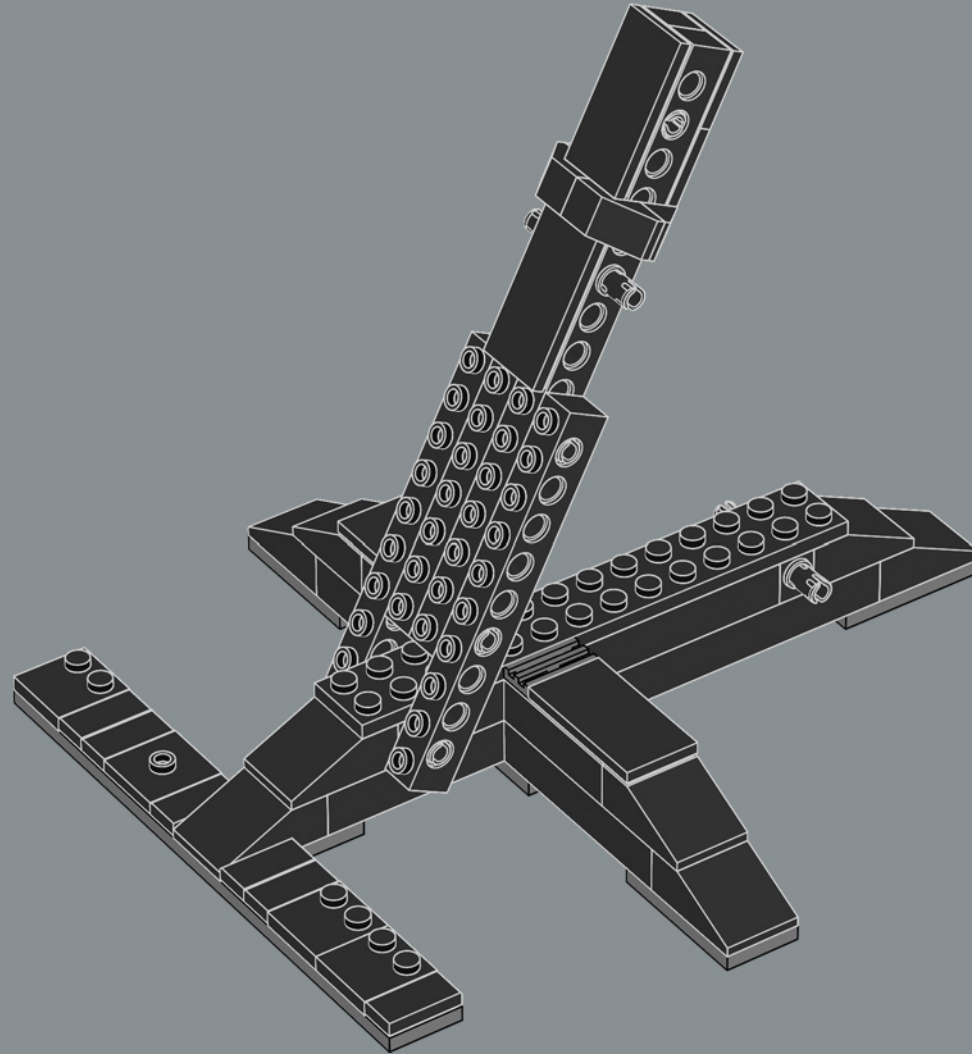



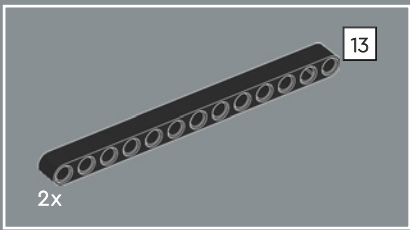

254

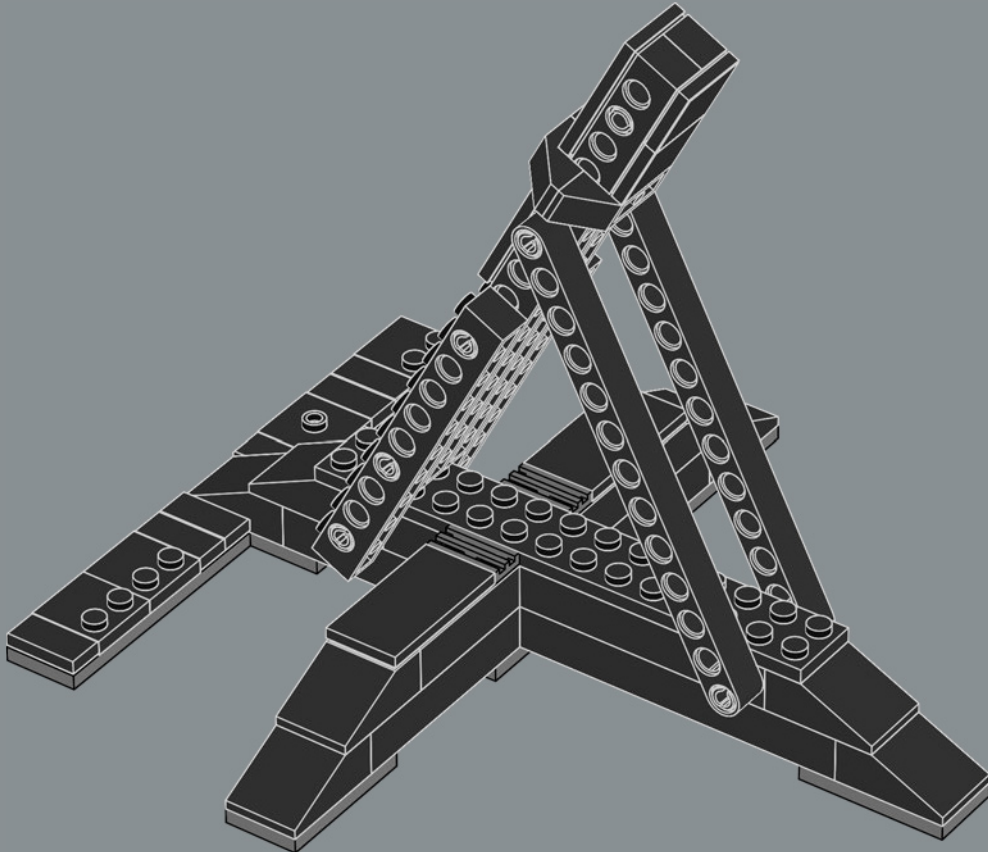



1x

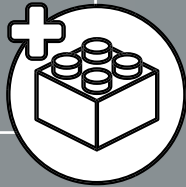

255

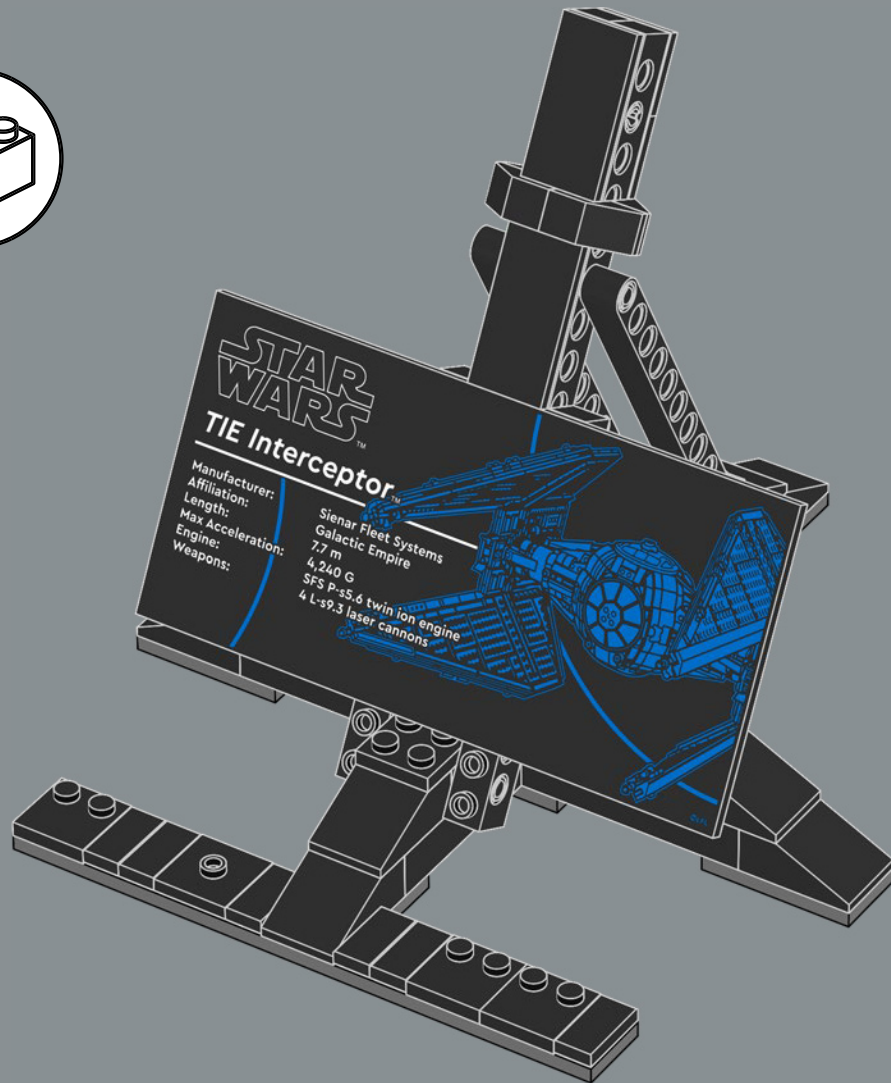

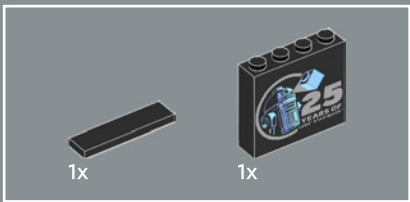

256

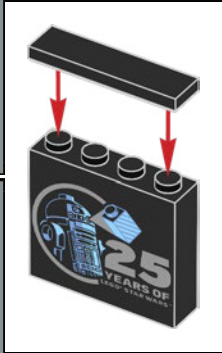
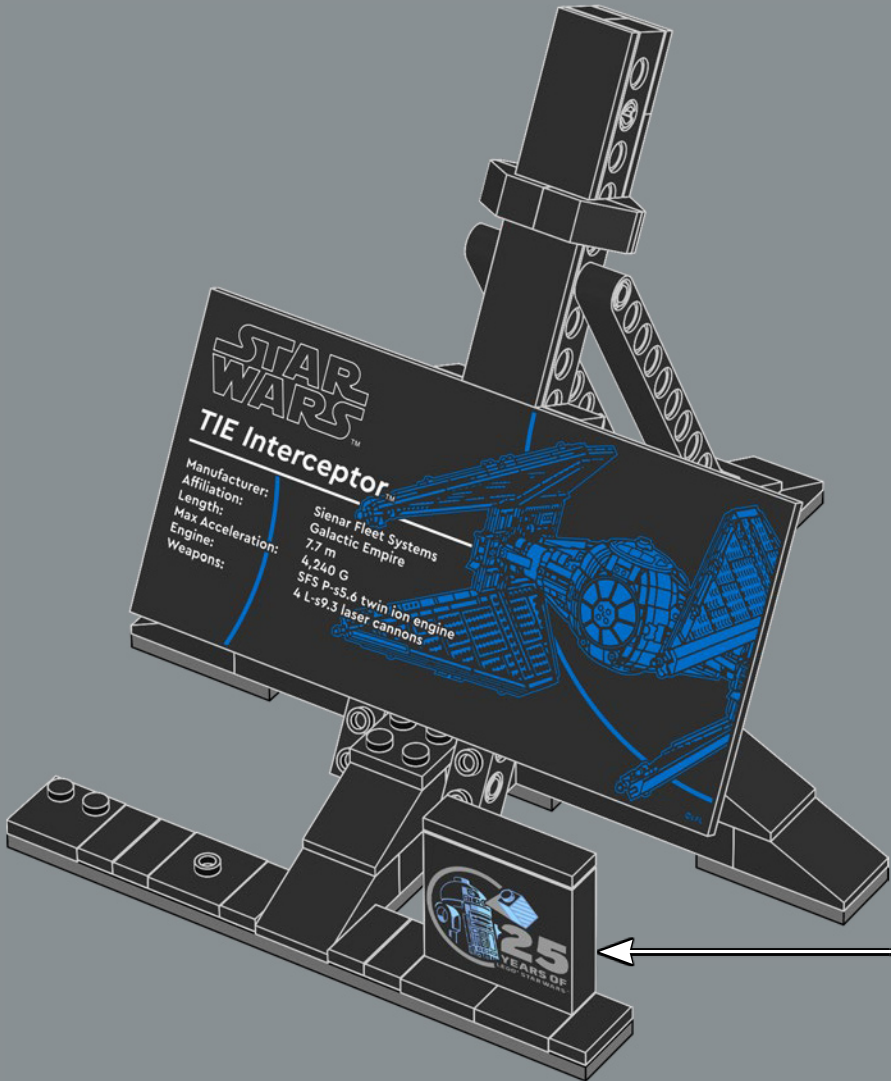

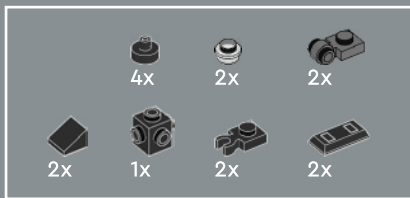

257

1

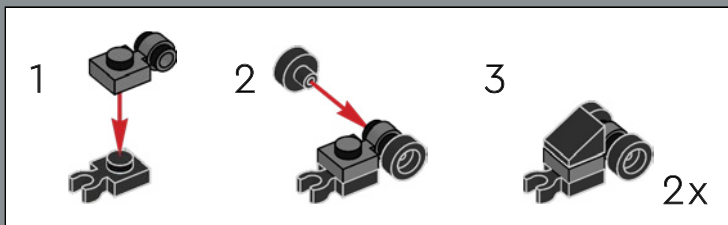

2

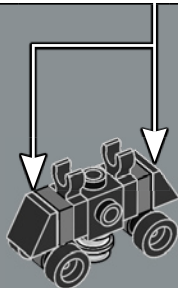

3

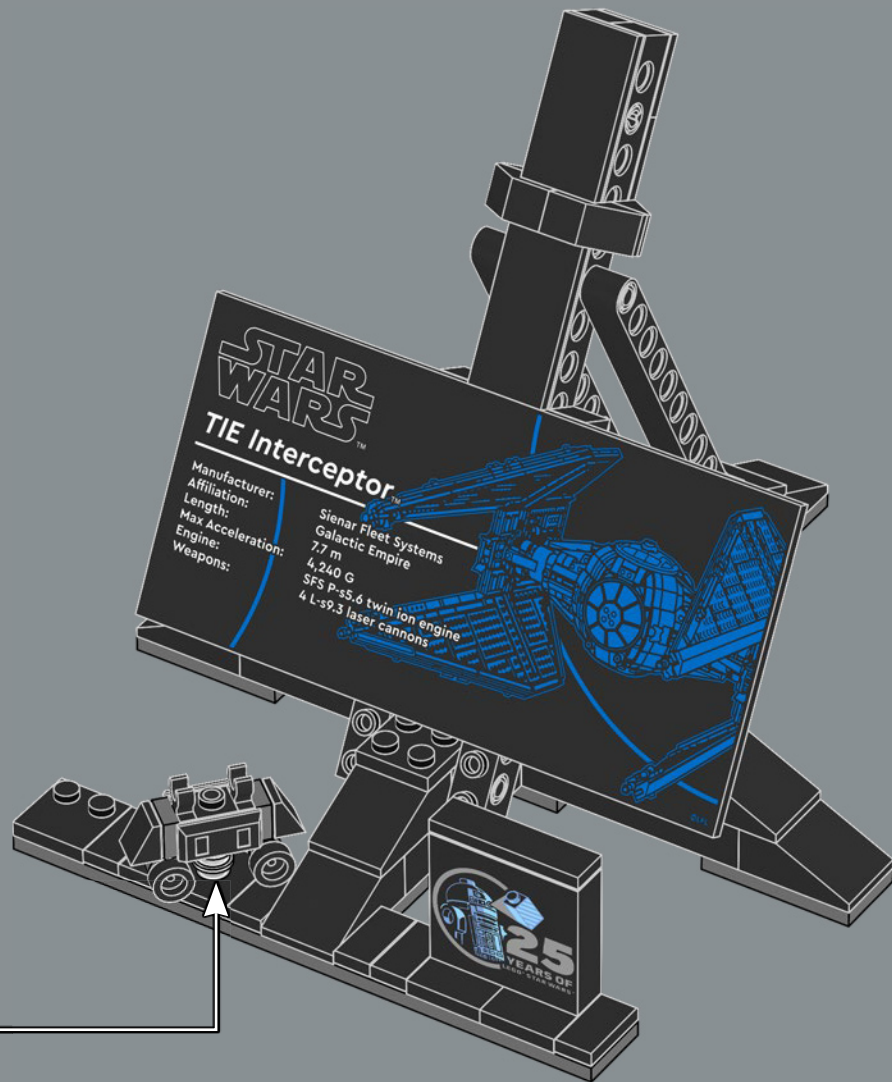
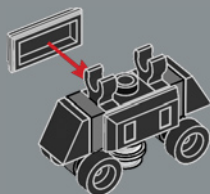



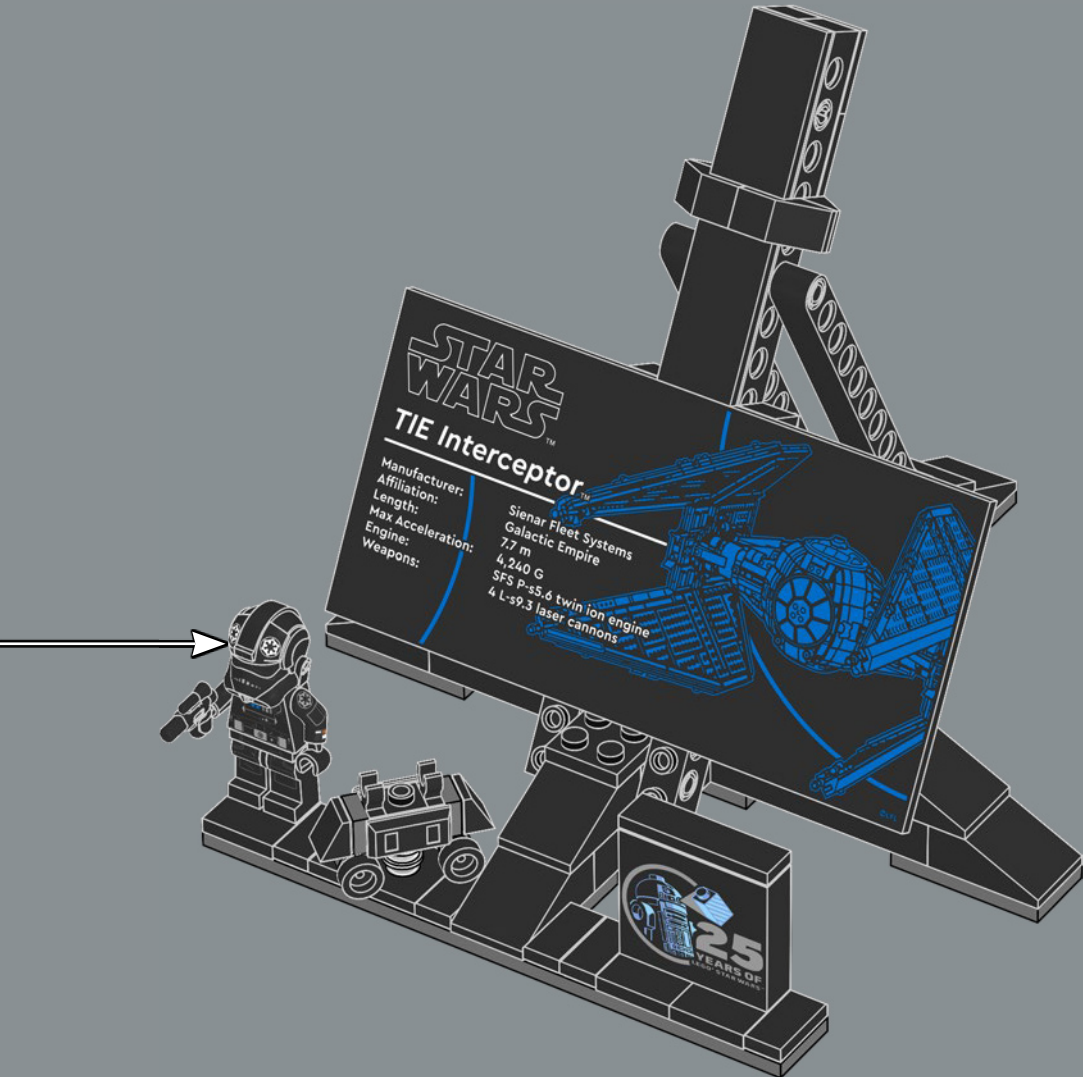
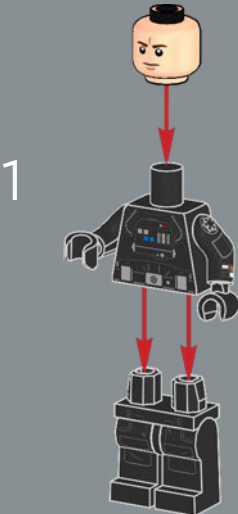

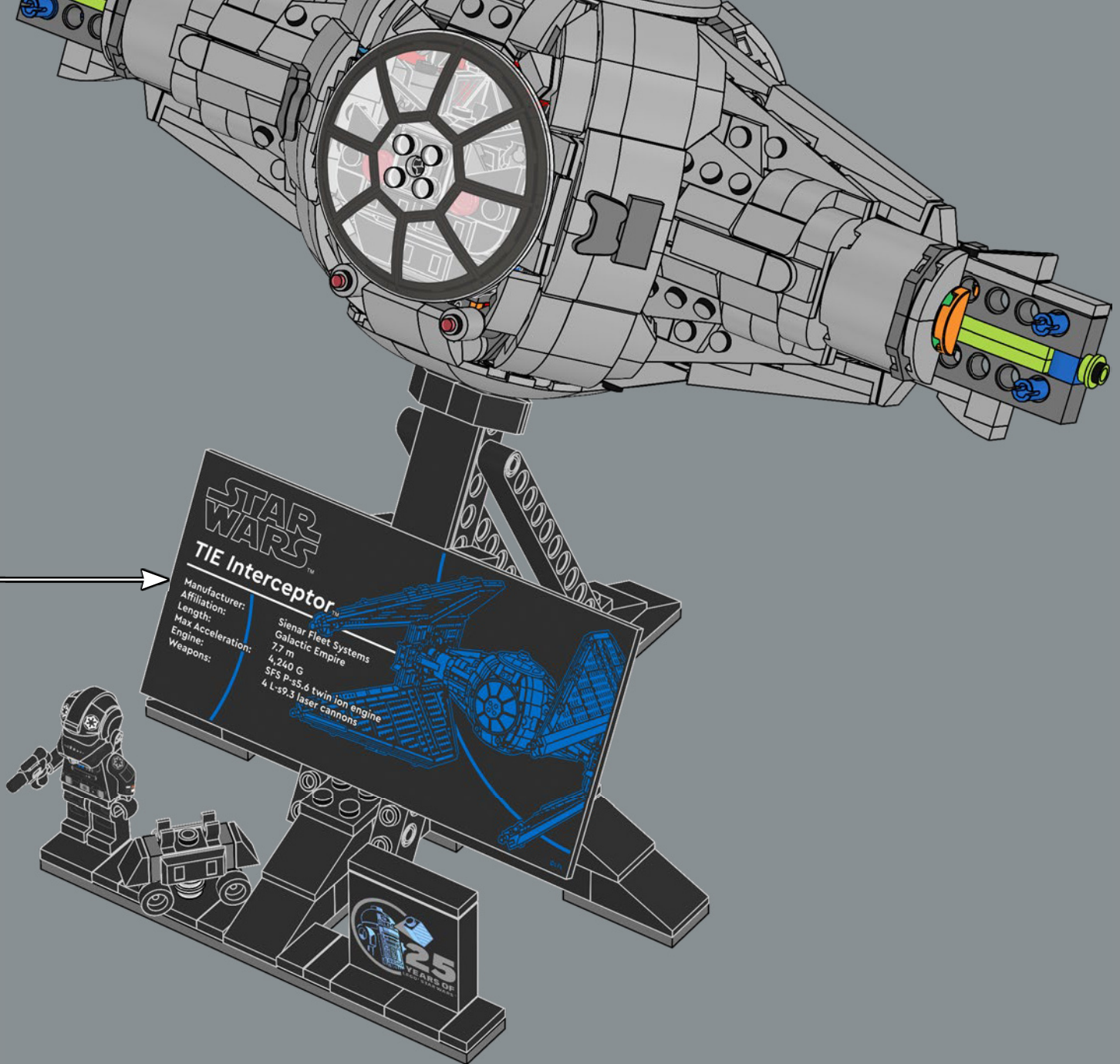

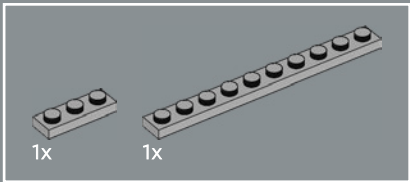
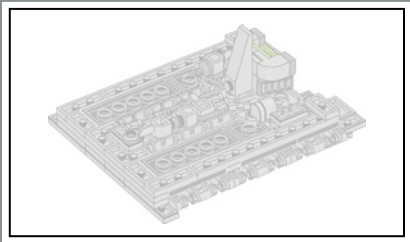

260

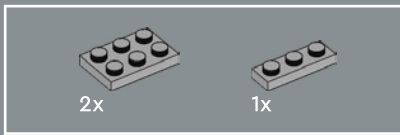
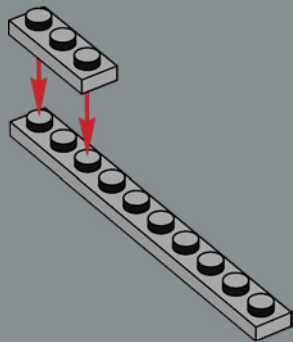

261

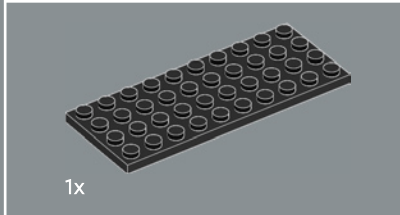
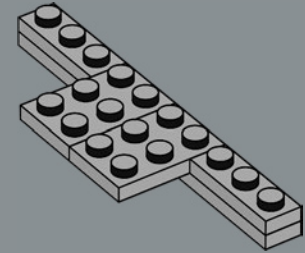

262

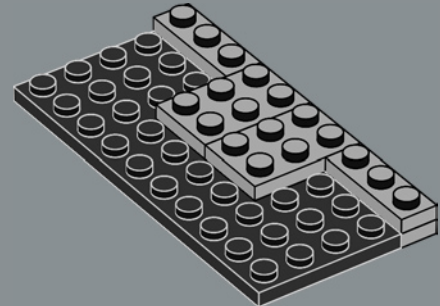



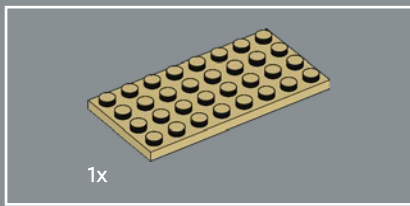

263

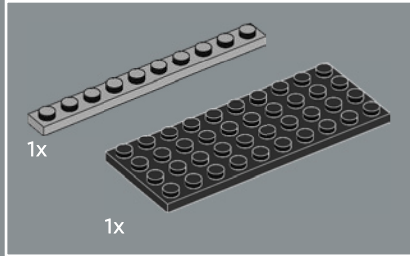
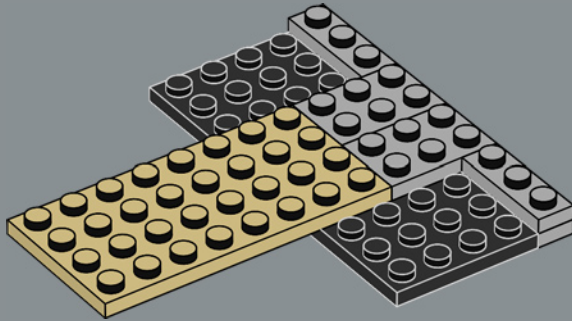

264

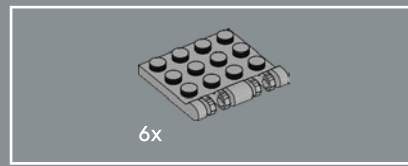
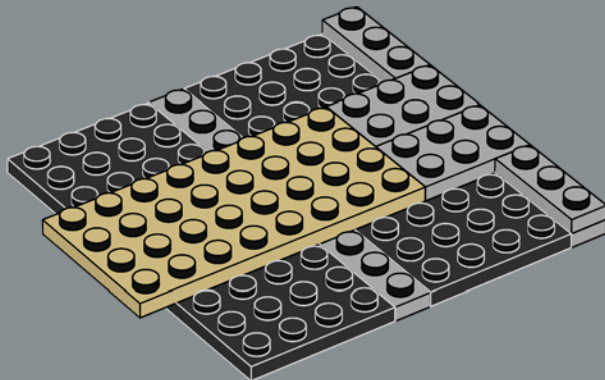

265

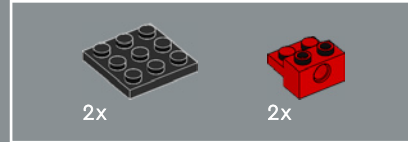
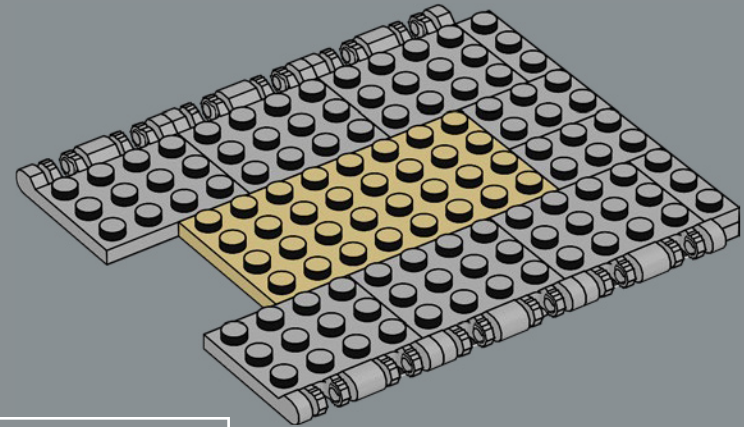

266

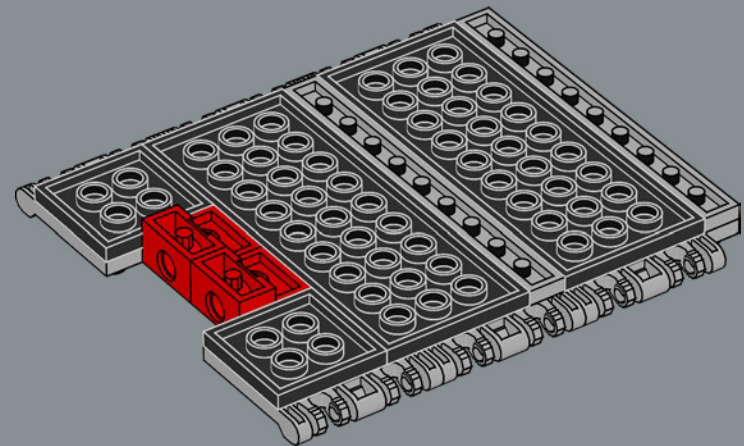



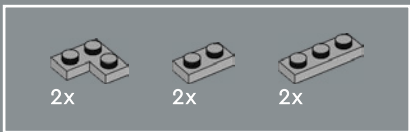

267

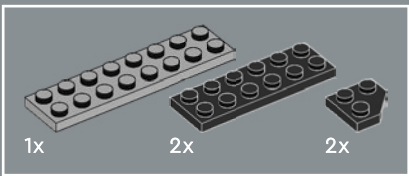
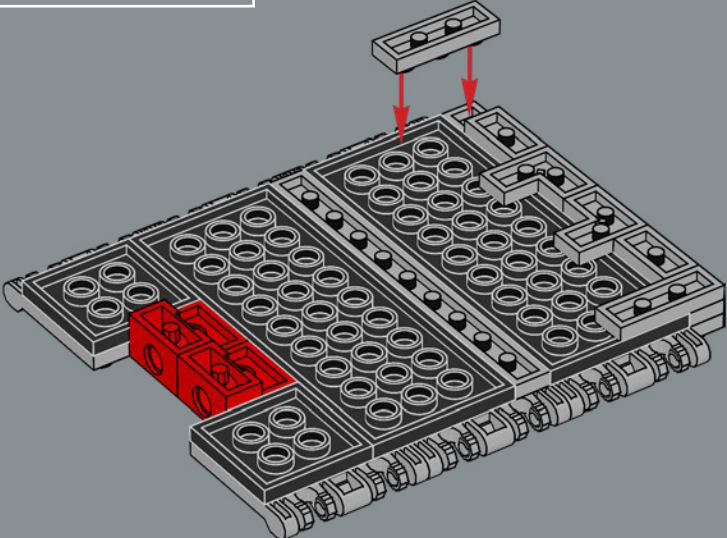

269

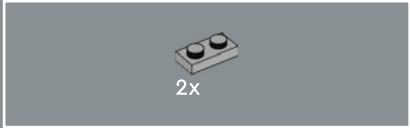
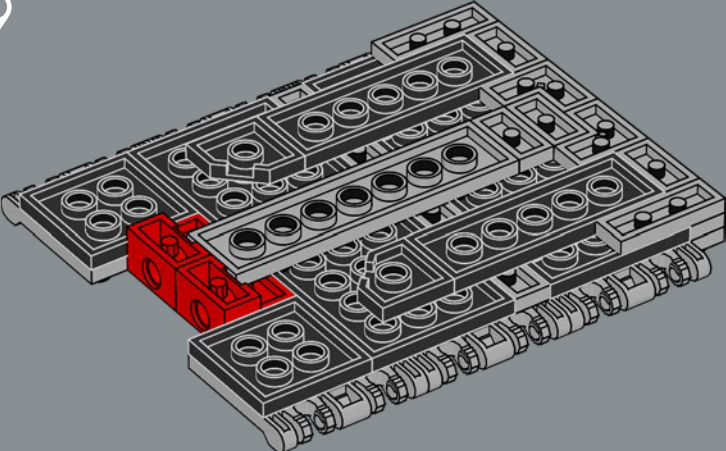

268

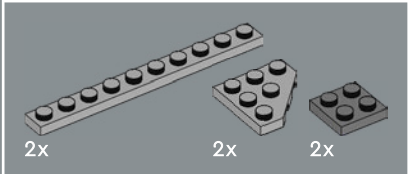
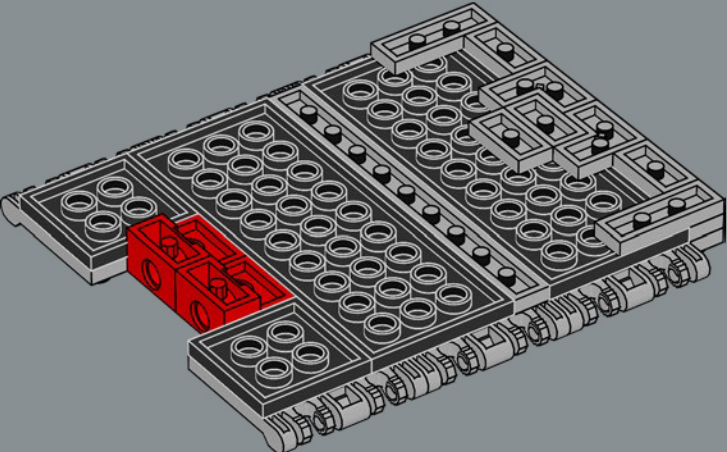

270

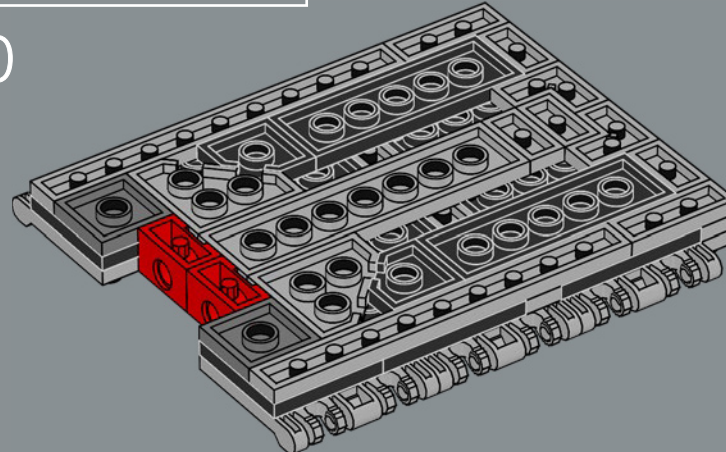

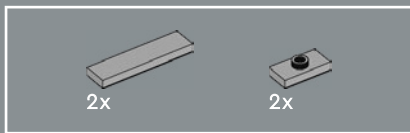

271

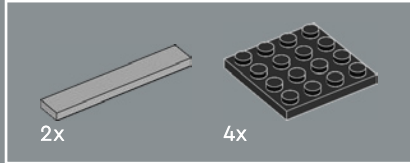
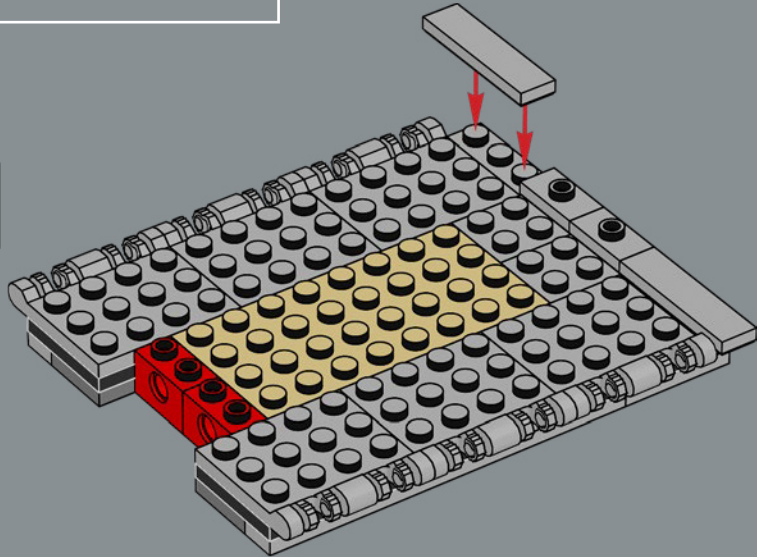

272

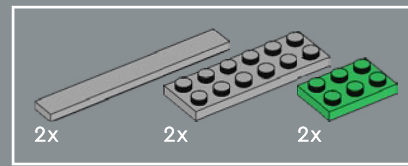
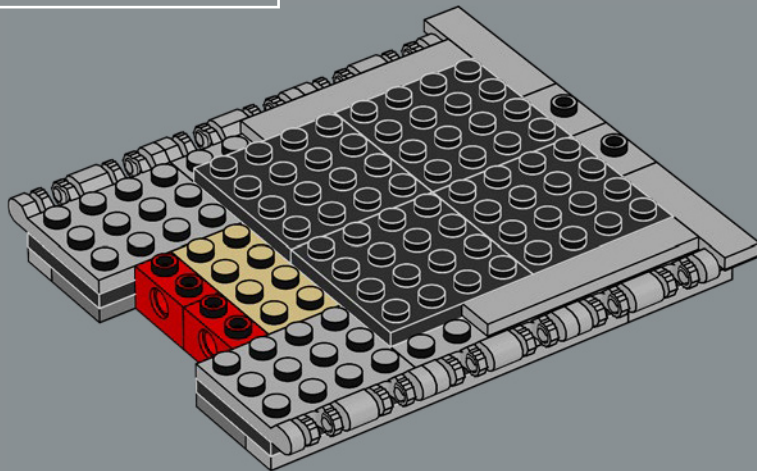

273

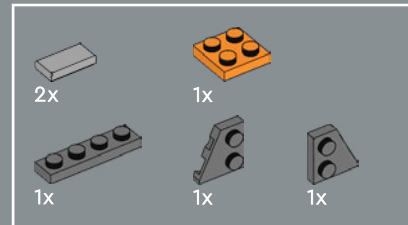
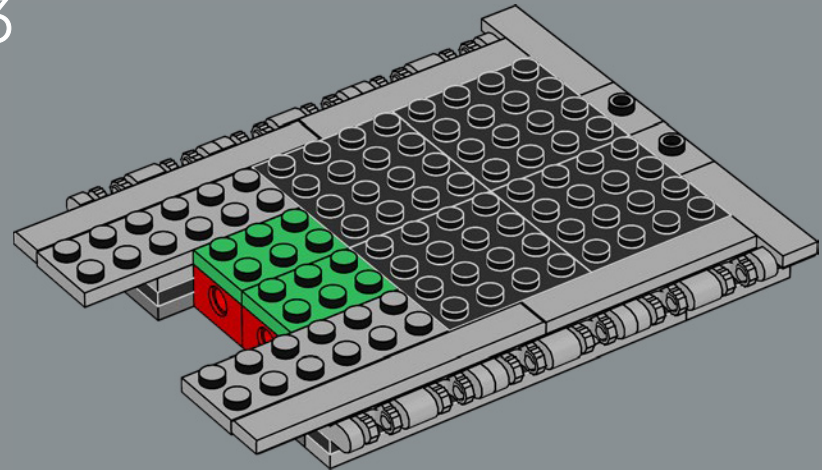

274

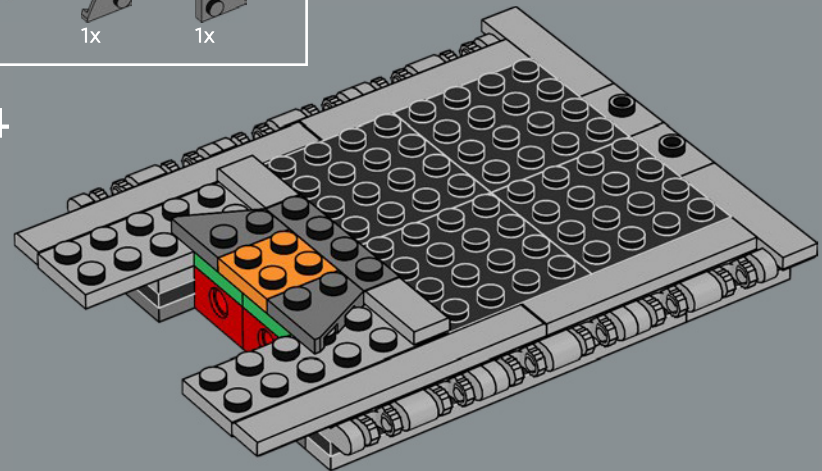



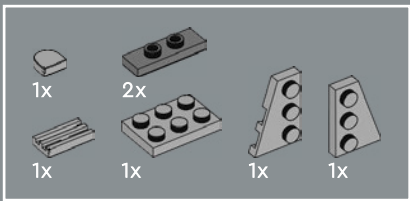

275

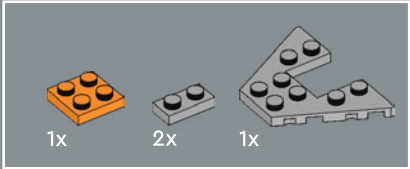
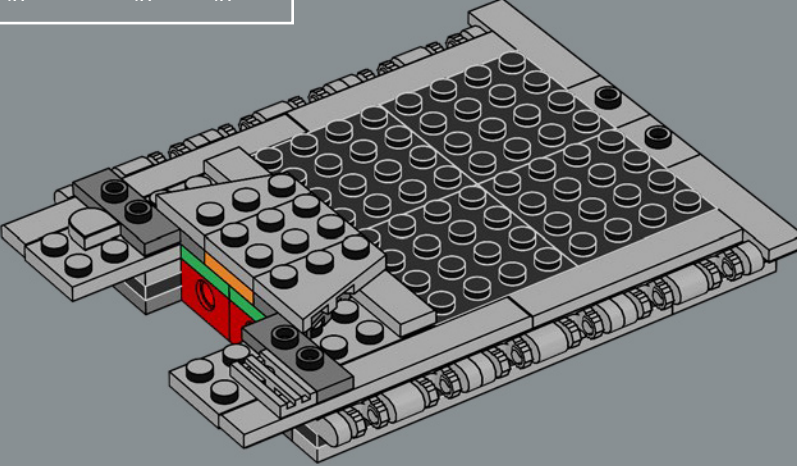

276

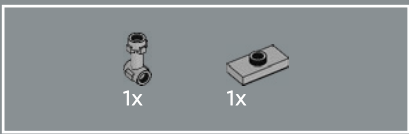
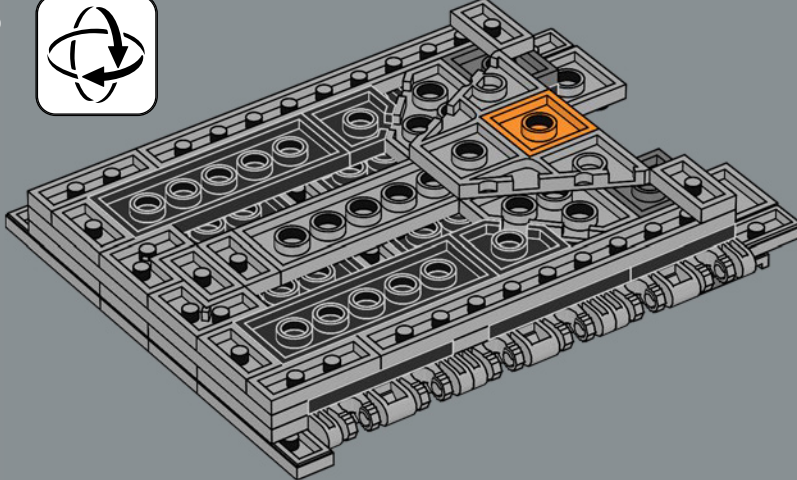

277

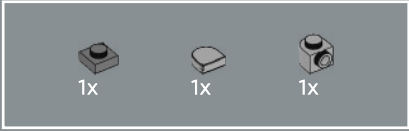
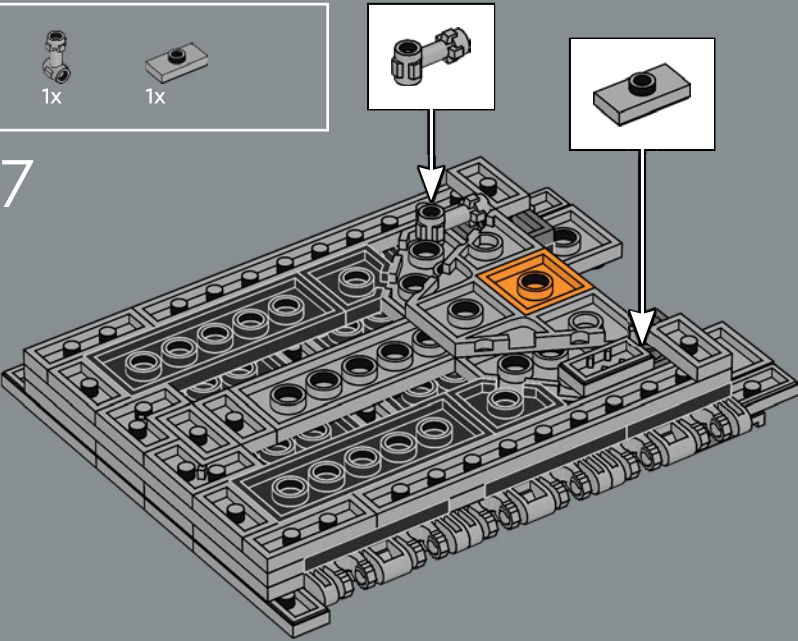

278

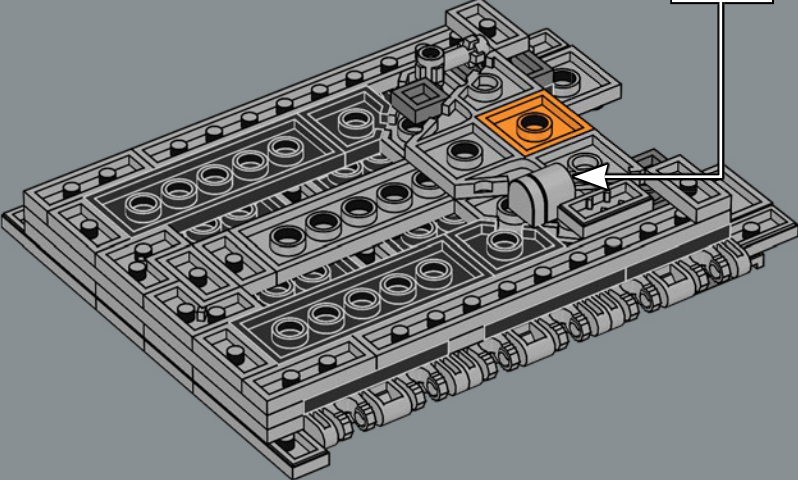
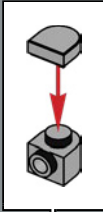

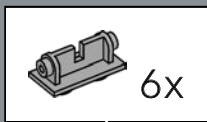
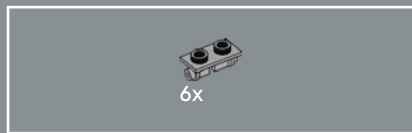

279

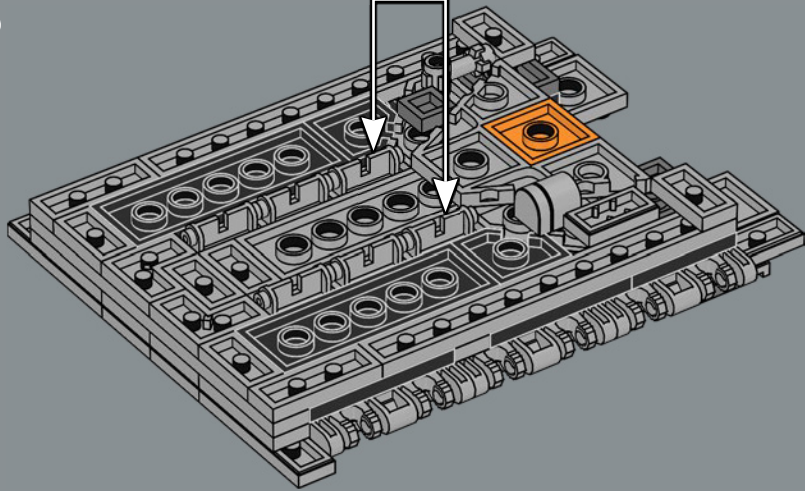

280

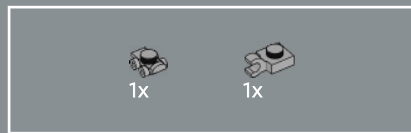
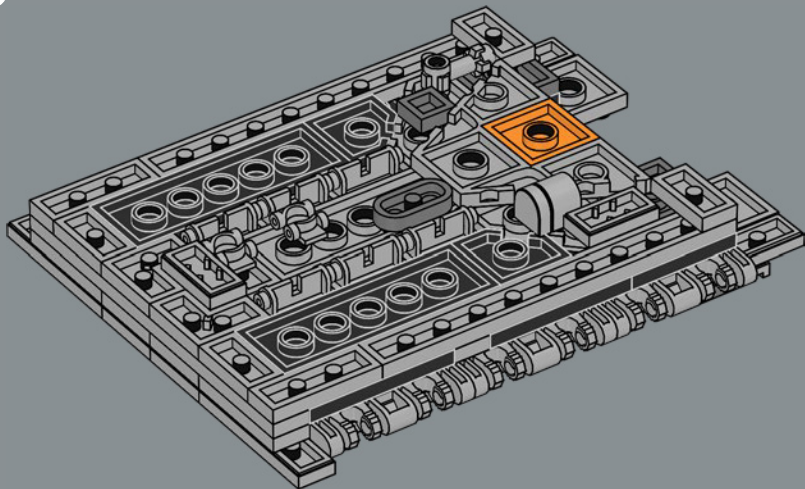

281

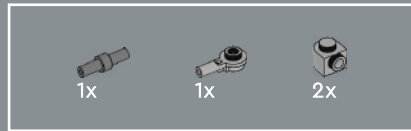
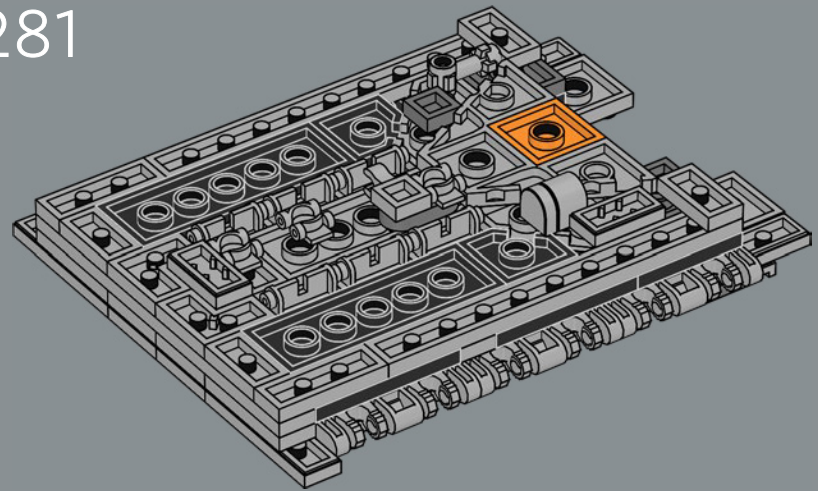

282

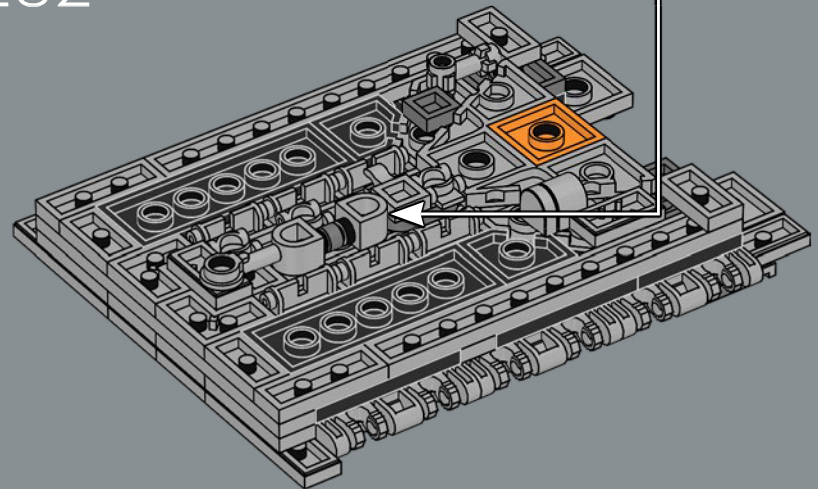
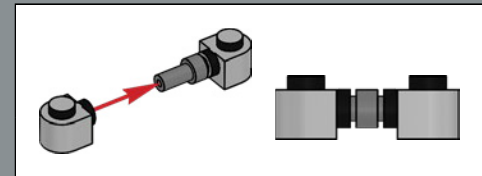





2x

283

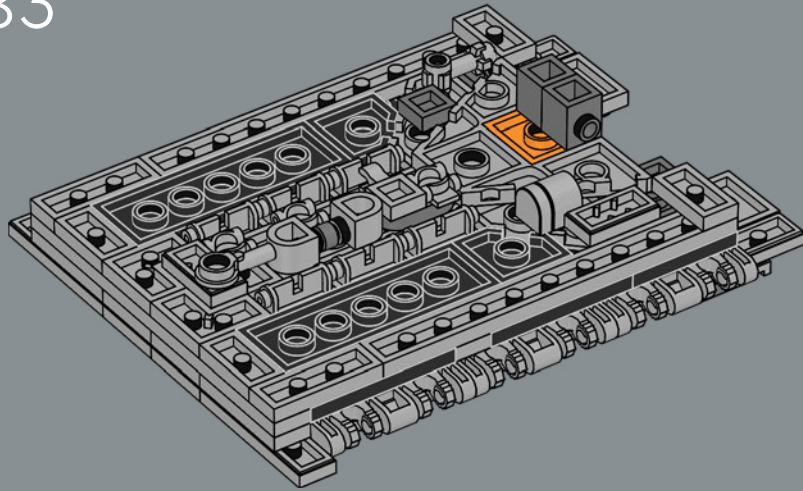

1x

284

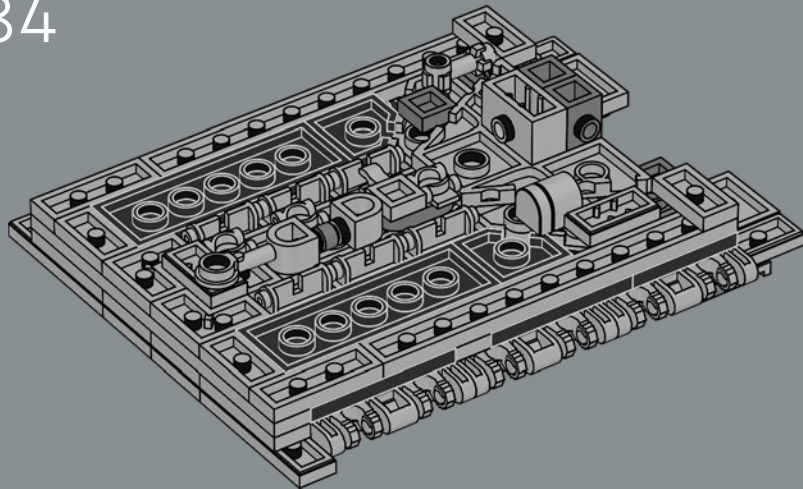

2x

285

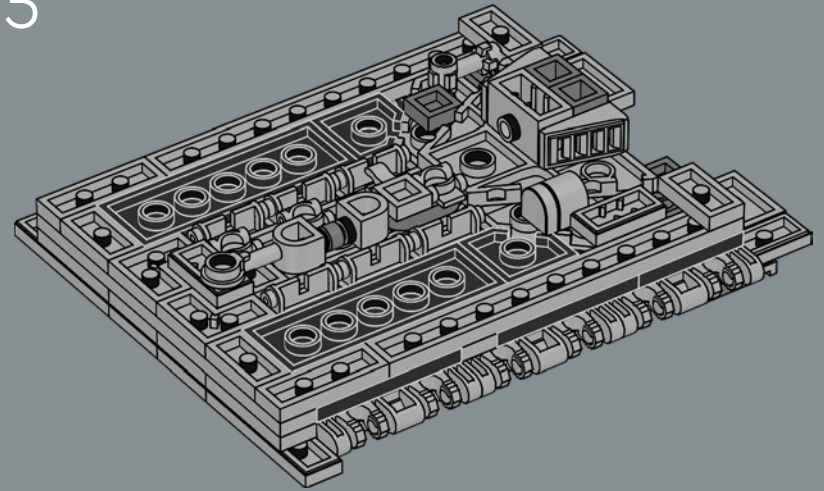

1x

286

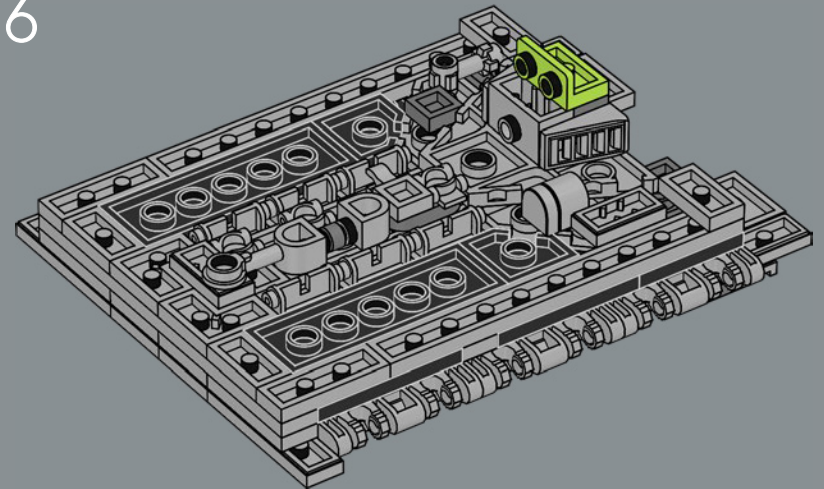

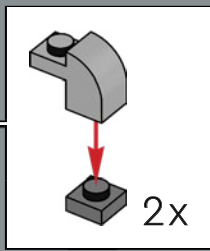
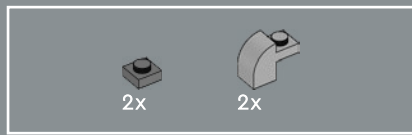

287

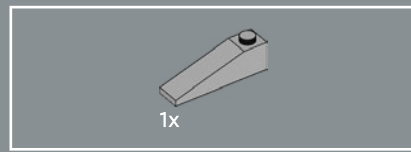
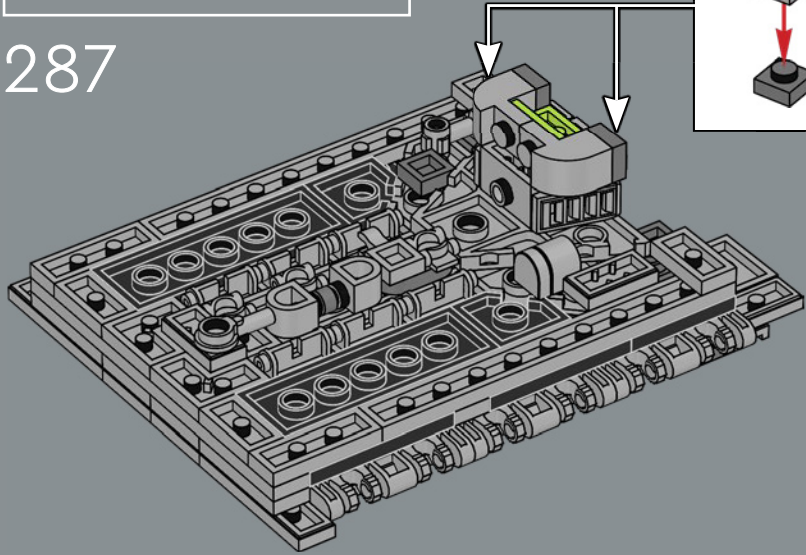

289

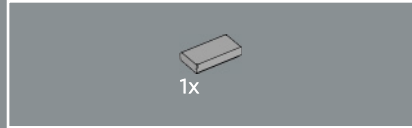
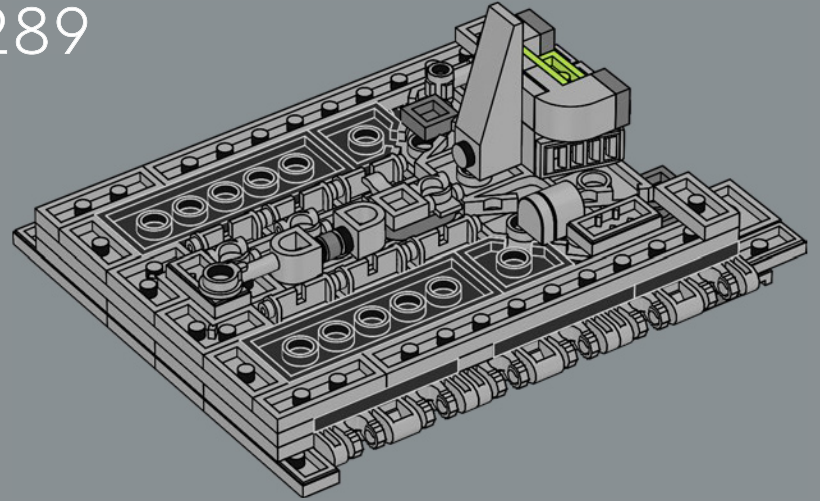

288

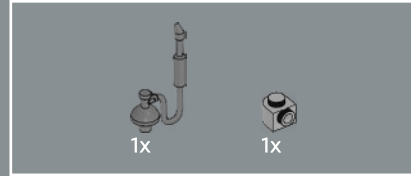
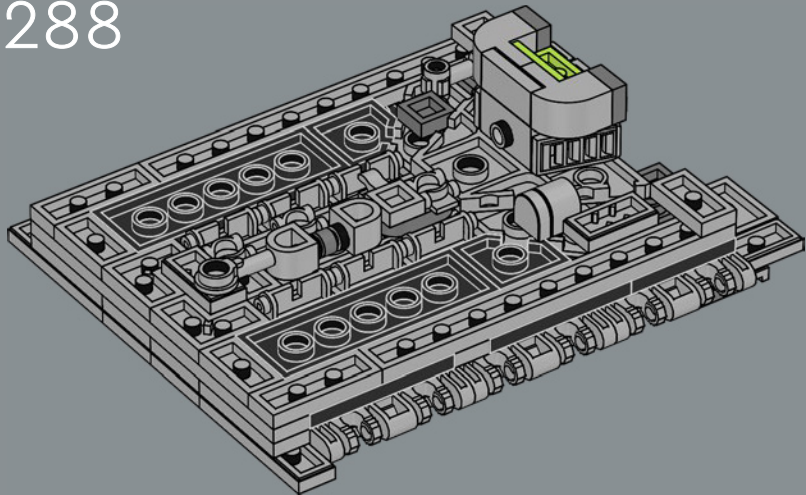

290

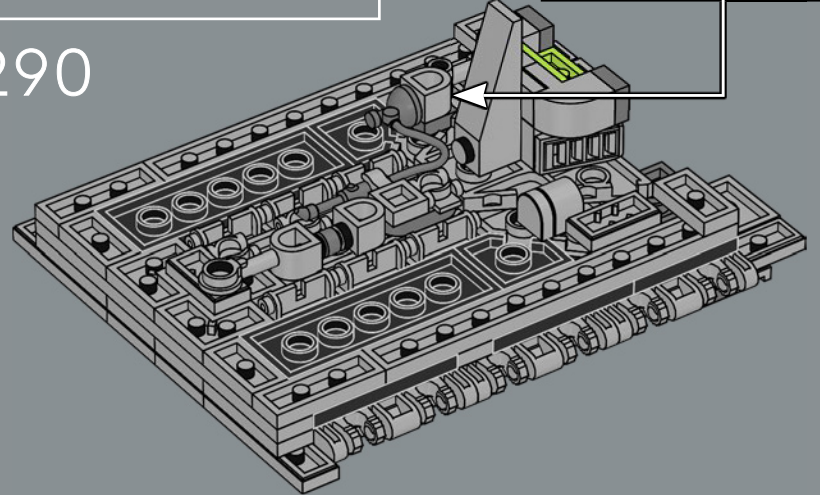
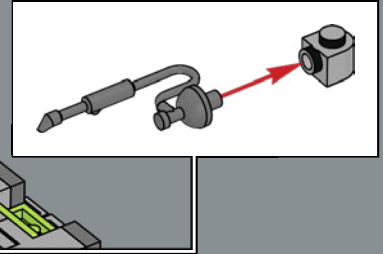



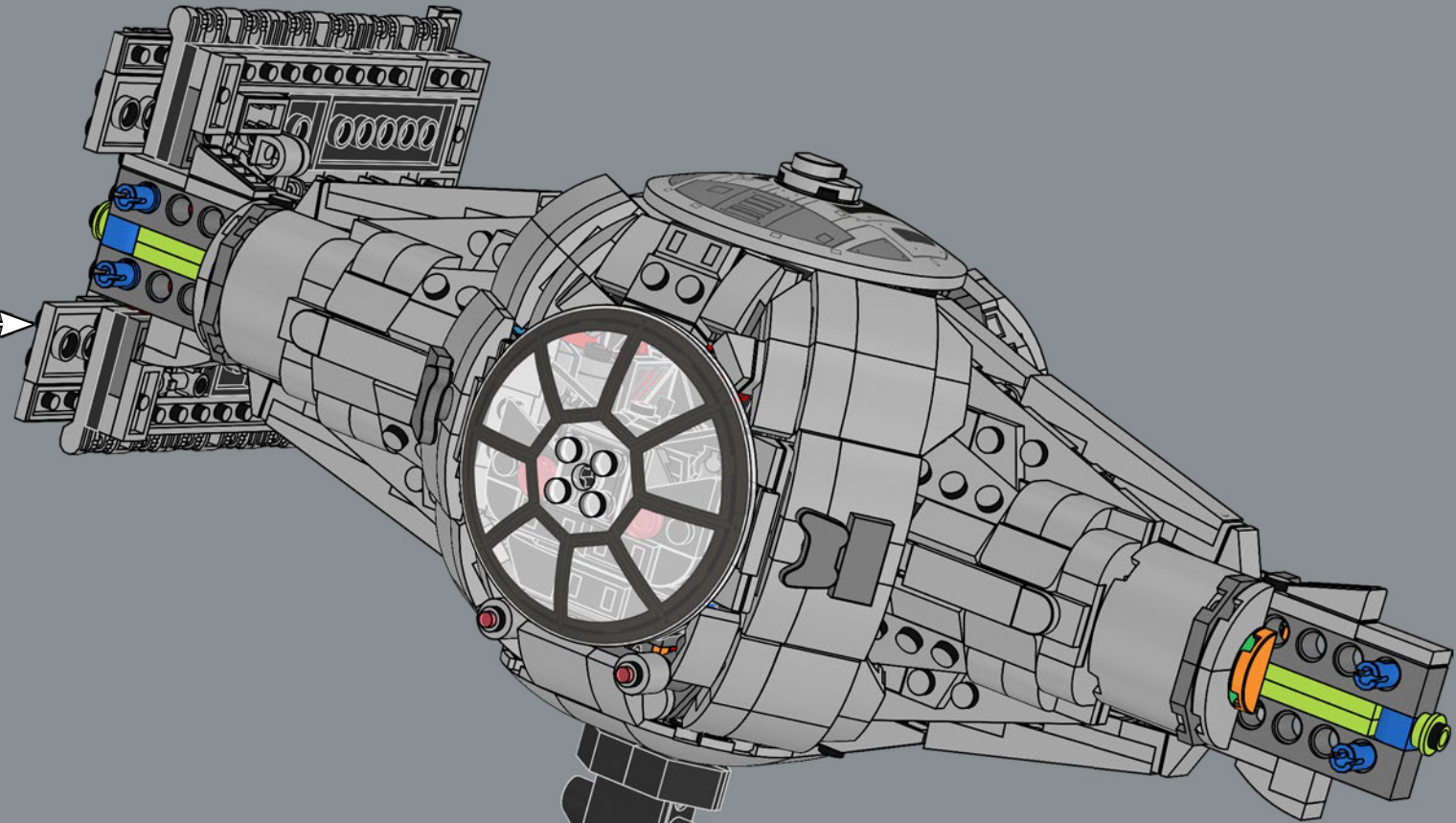

**STAR WARS**  
**TIE Interceptor™**

Manufacturer:	Siemar Fleet Systems
Affiliation:	Galactic Empire
Length:	7.7 m
Max Acceleration:	4,240 G
Engine:	SFS P-35.6 twin ion engine
Weapons:	4 L-39.3 laser cannons

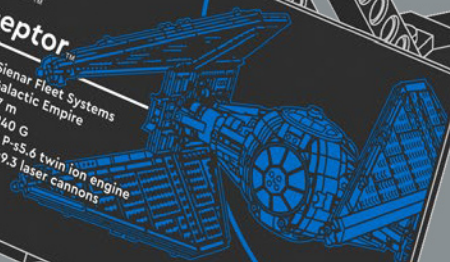

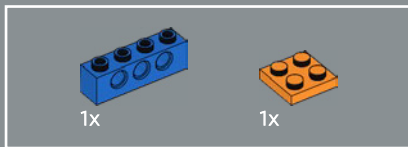
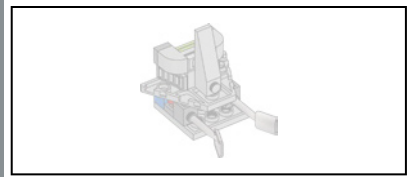

292

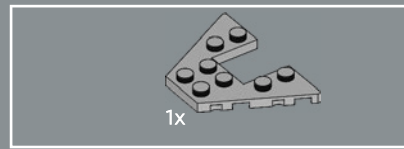
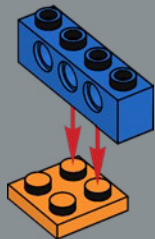

293

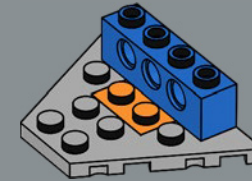

294

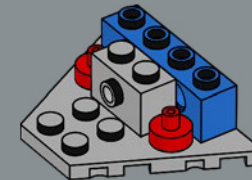



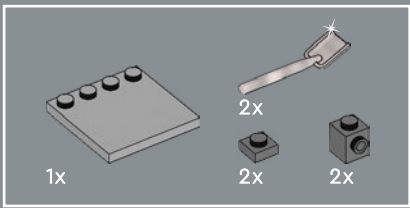

295

1

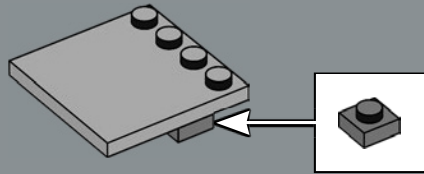

2

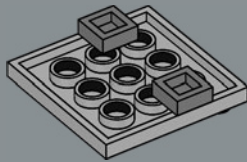

3

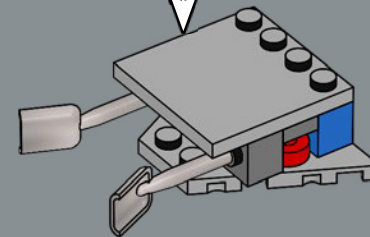
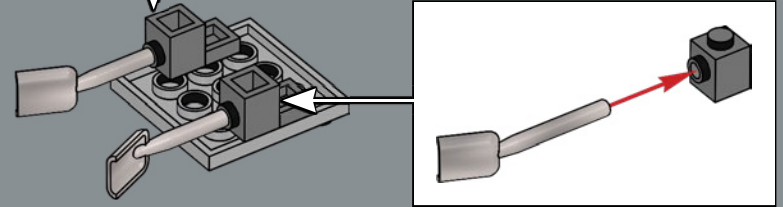
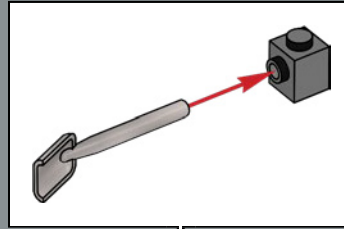



296

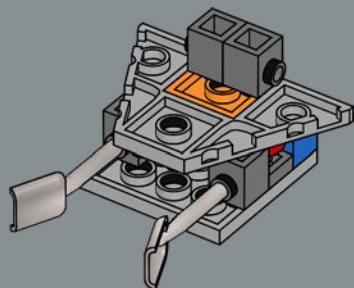

297

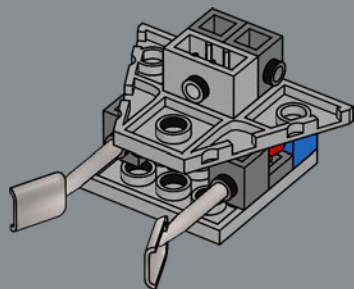

298

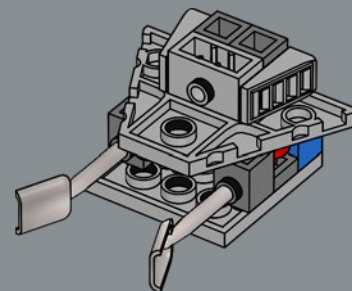

299

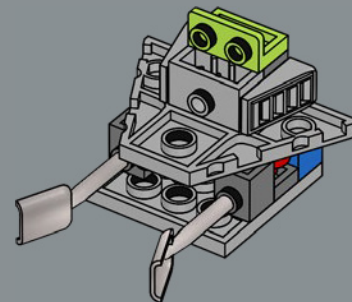

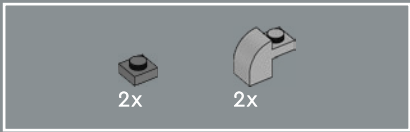

300

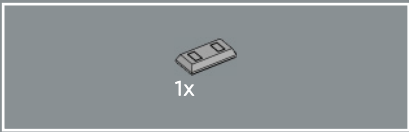
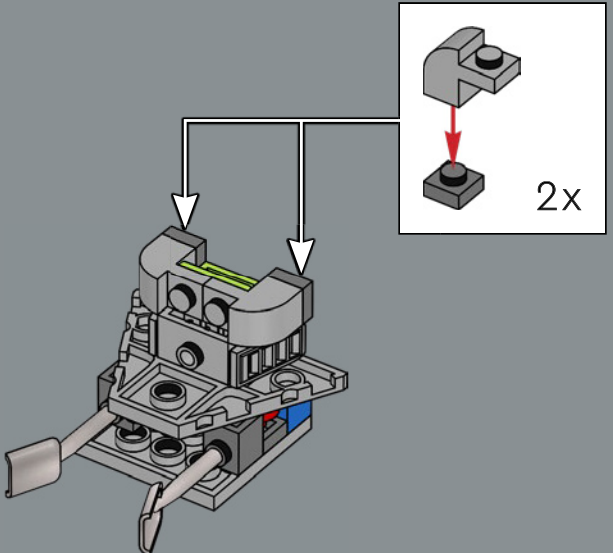

301

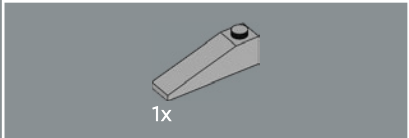
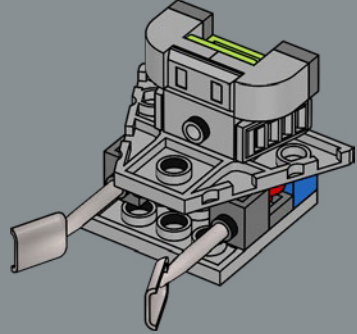

302

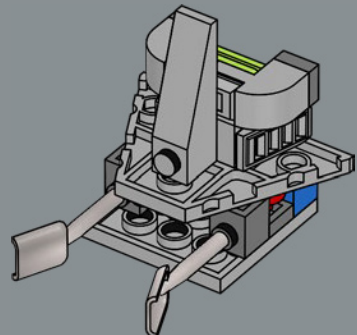

303

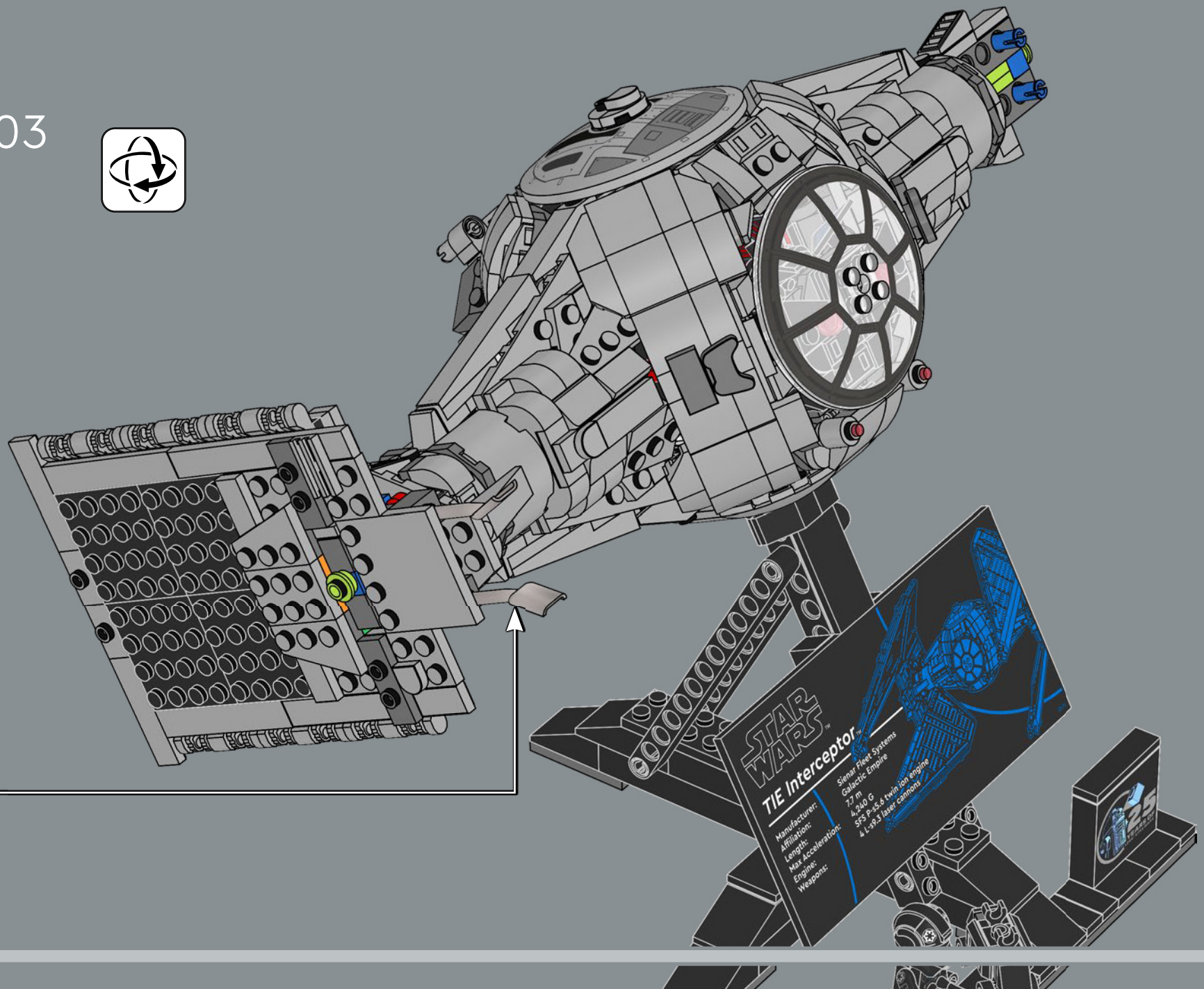

# STAR WARS™

## TIE Interceptor™

Manufacturer:  
Sienna Fleet Systems  
Galactic Empire

Length:  
7.7 m

Max. Acceleration:  
4,240 G

Engine:  
SFS P-55 & twin ion engine

Weapons:  
4 L-38 3 laser cannons



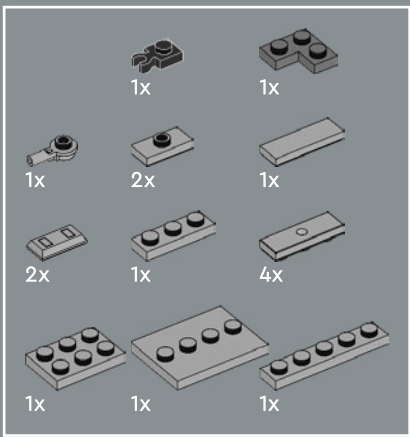

304

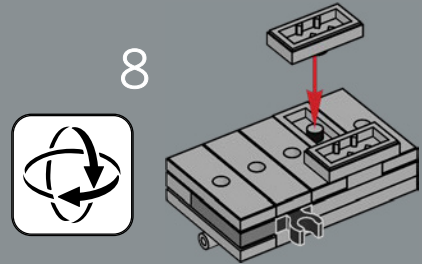
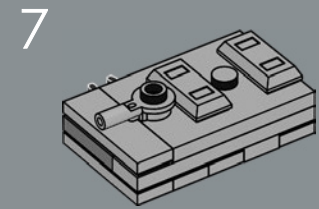
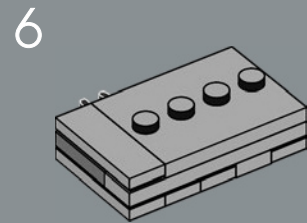
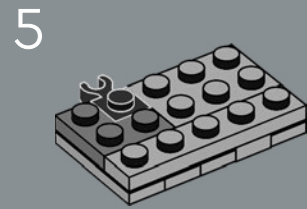
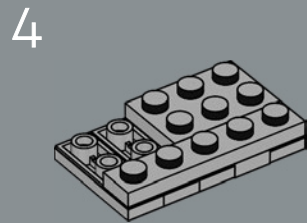
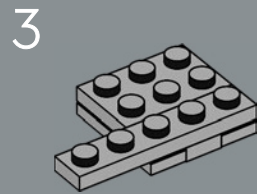
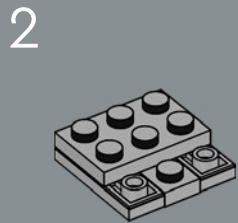
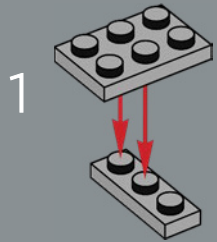

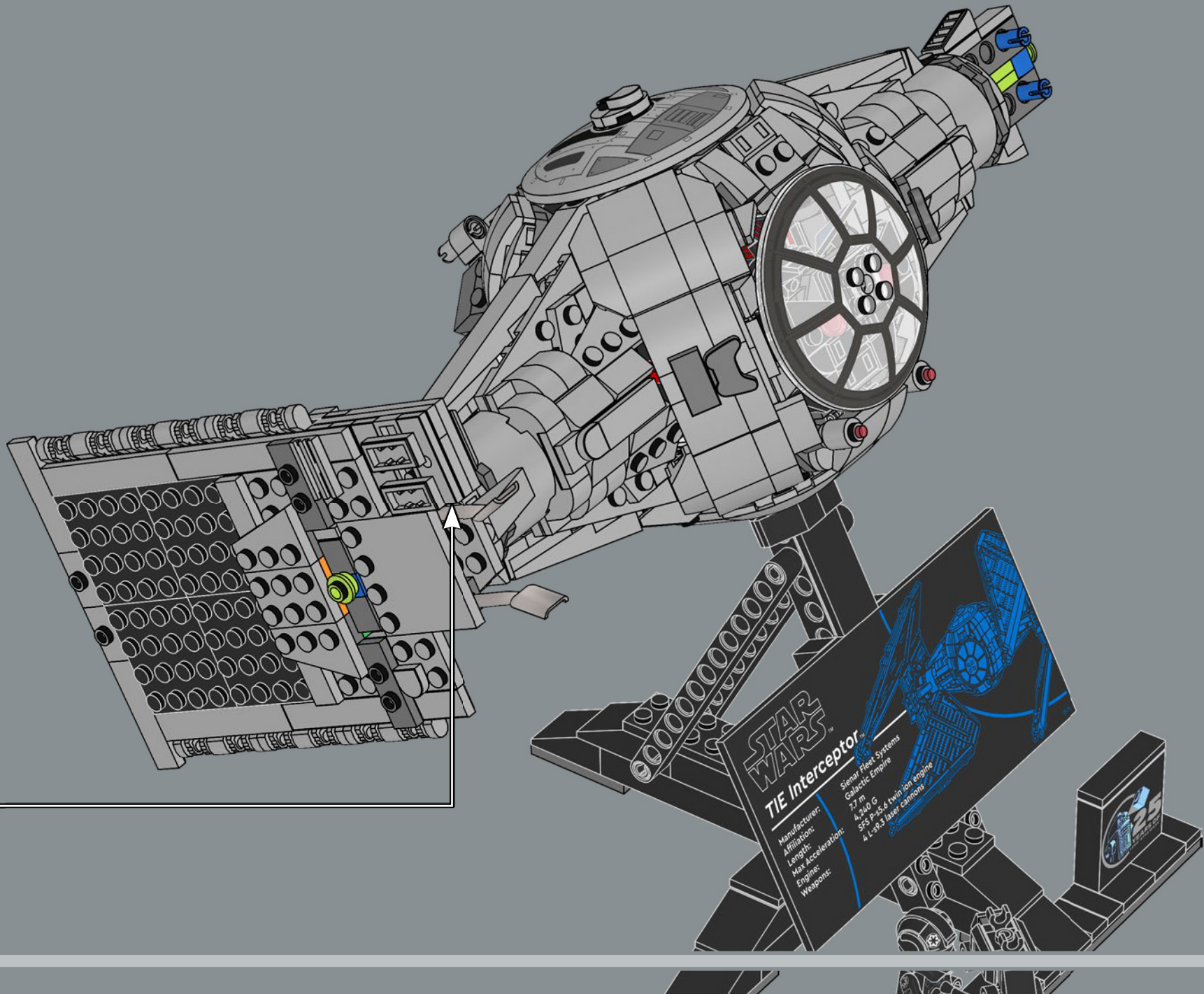

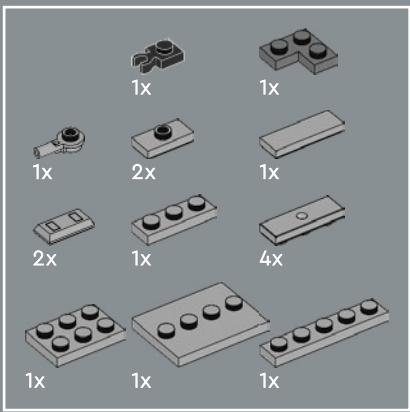

# 305

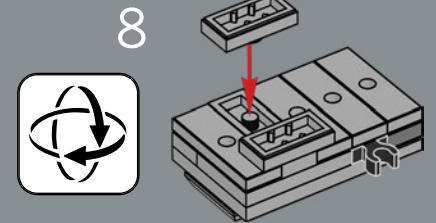
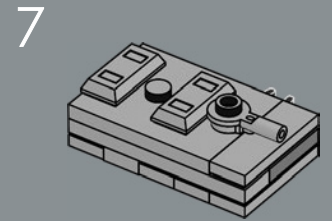
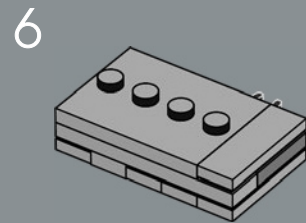
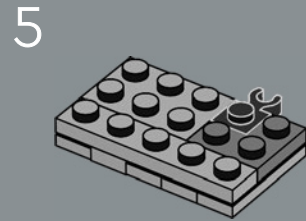
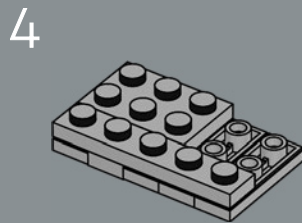
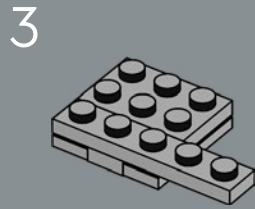
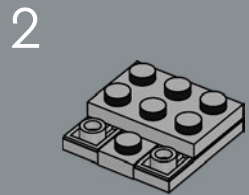
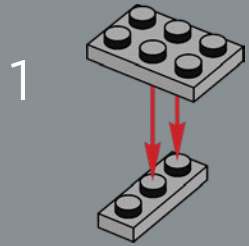



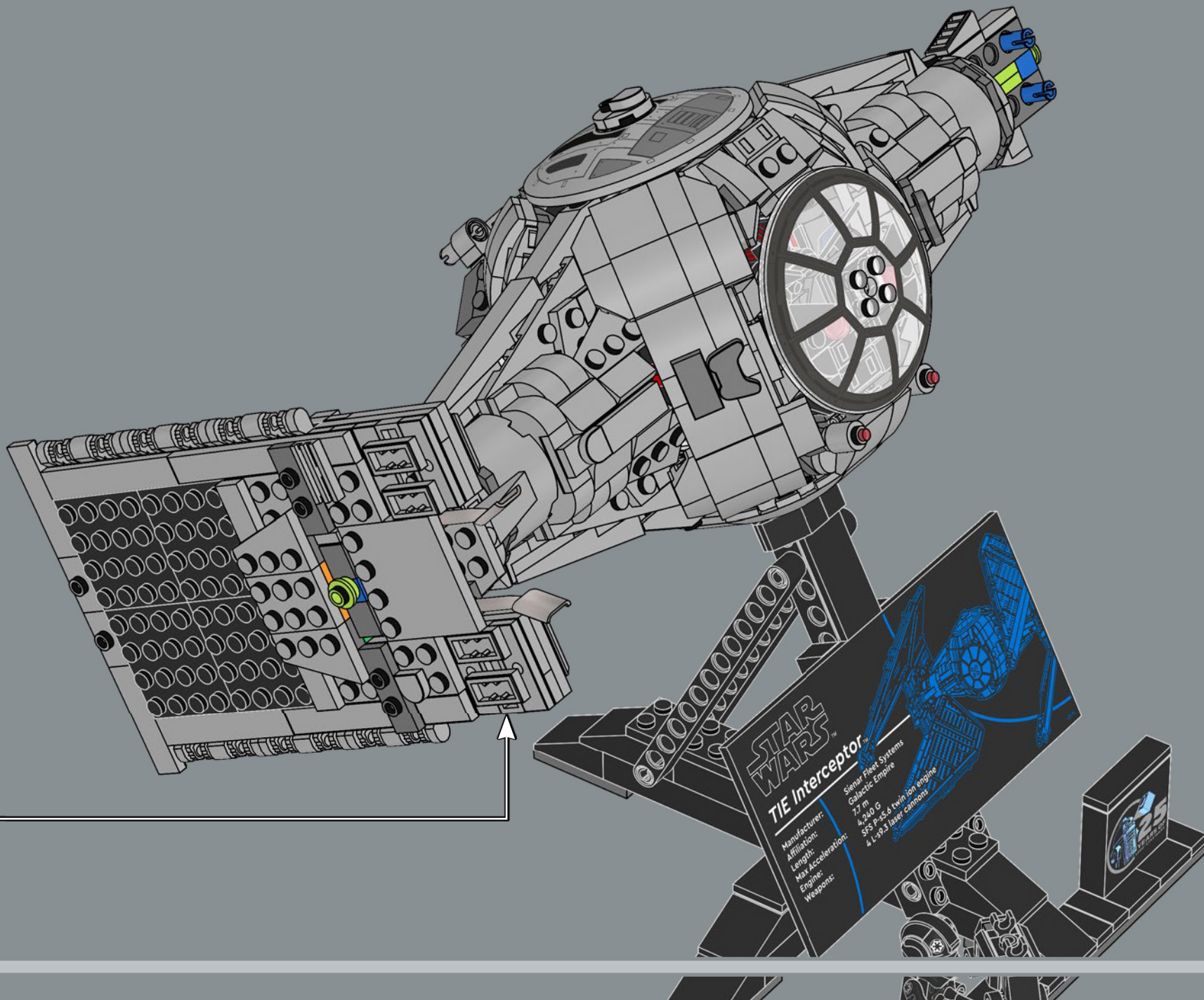

# STAR WARS™

## TIE Interceptor™

Manufacturer:  
Sienar Fleet Systems  
Affiliation:  
Galactic Empire  
Length:  
7.7 m  
Max Acceleration:  
4,240 G  
Engine:  
SFS P-5S & twin ion engine  
Weapons:  
4 L-38 3 laser cannons





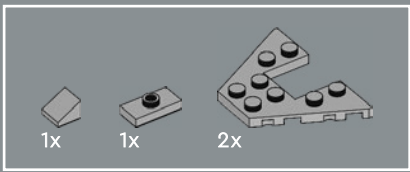

306

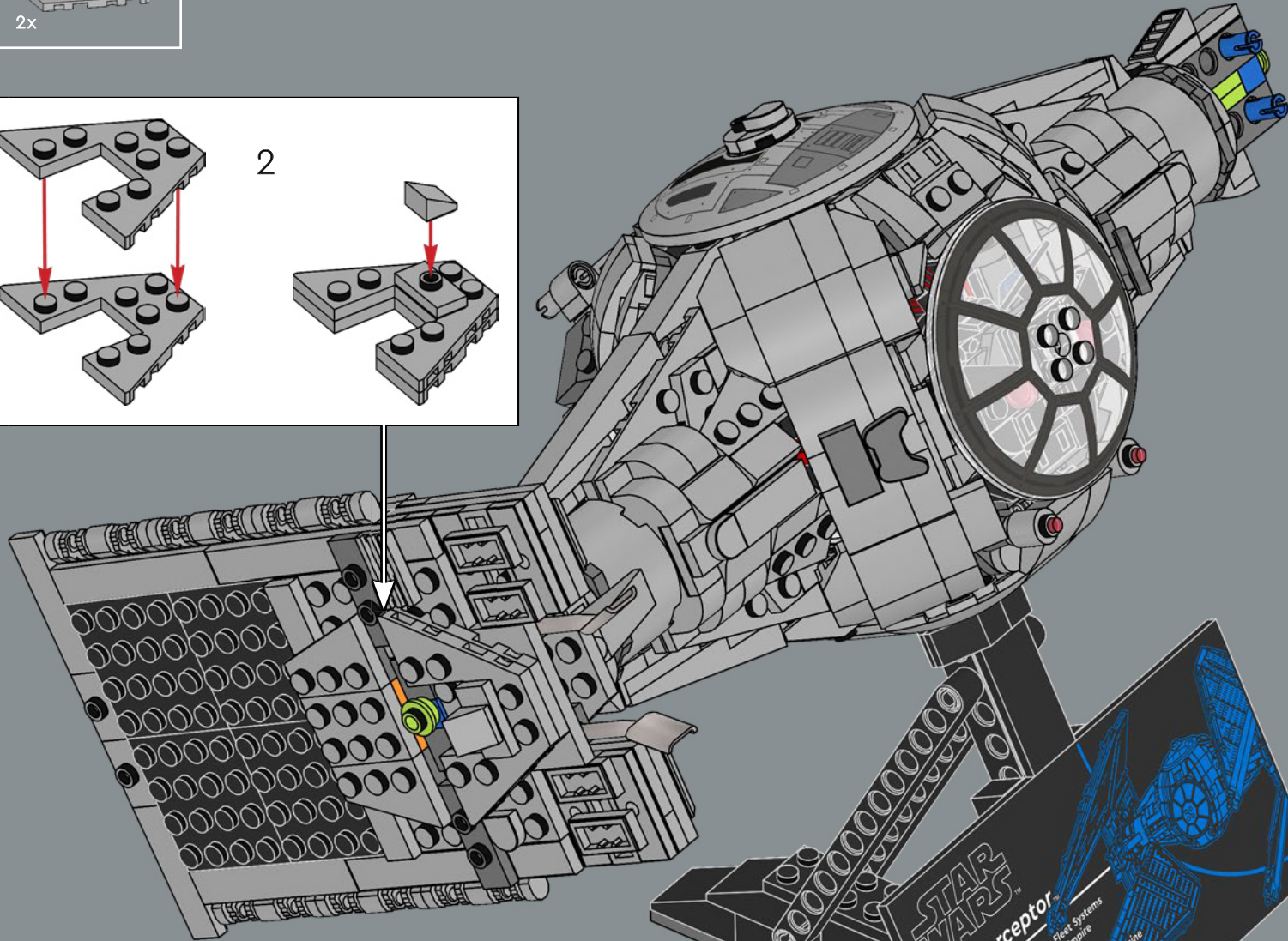
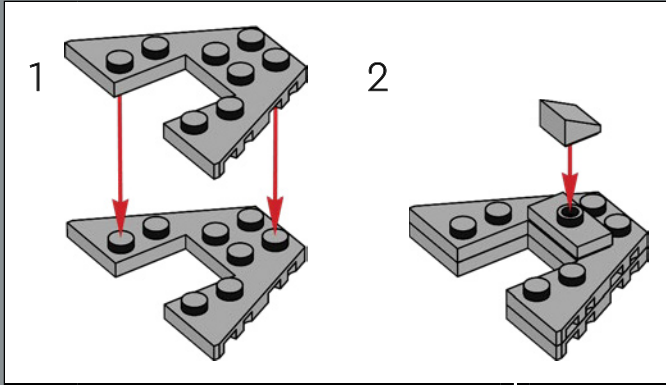

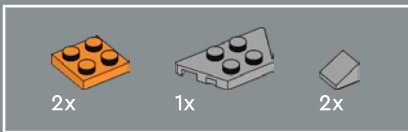

307

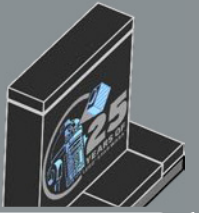
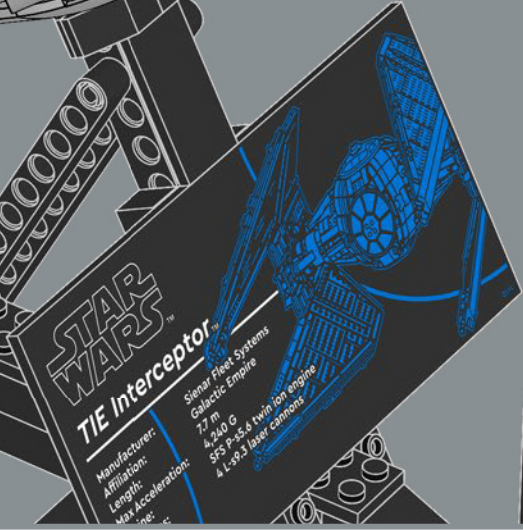
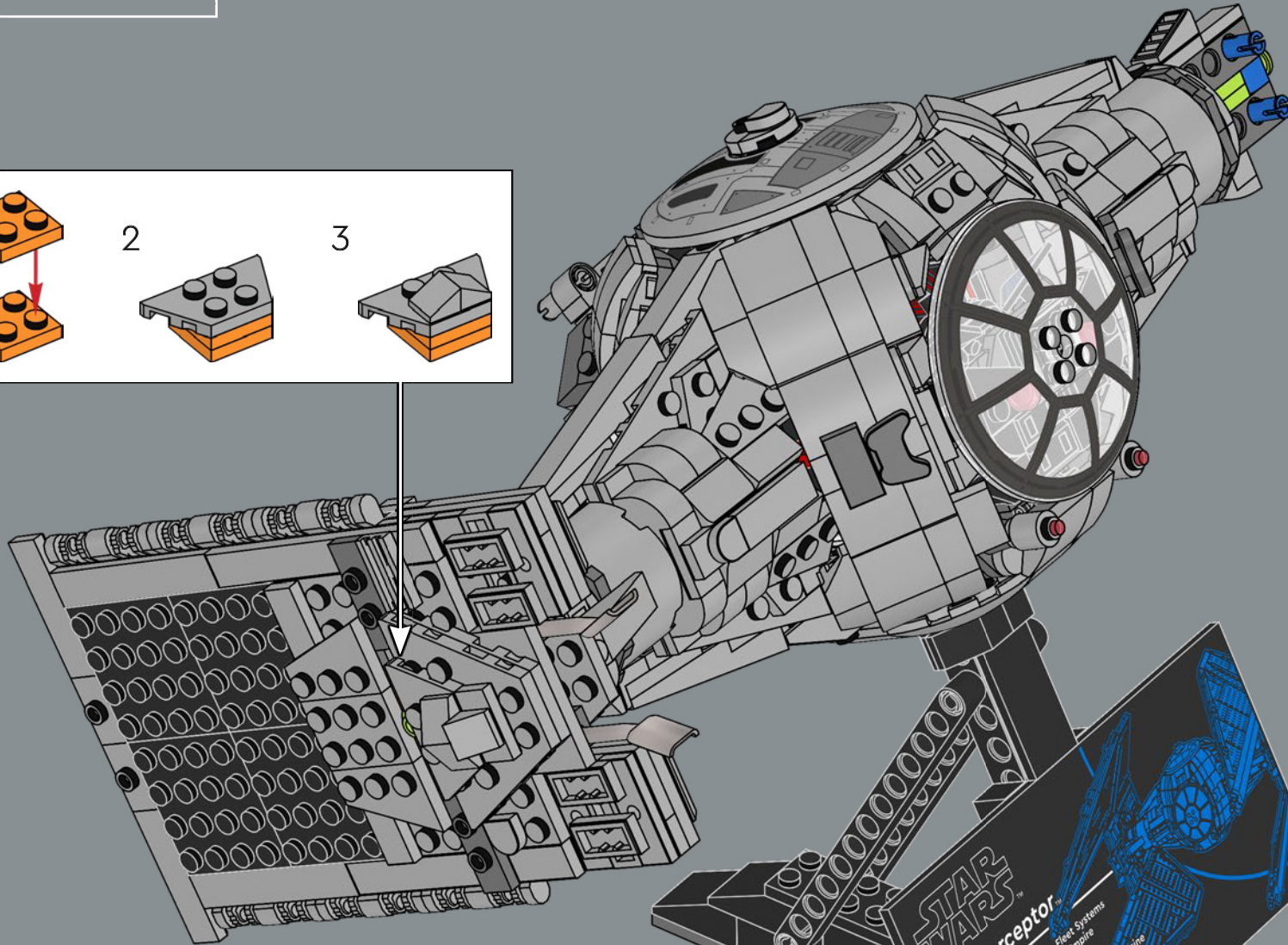
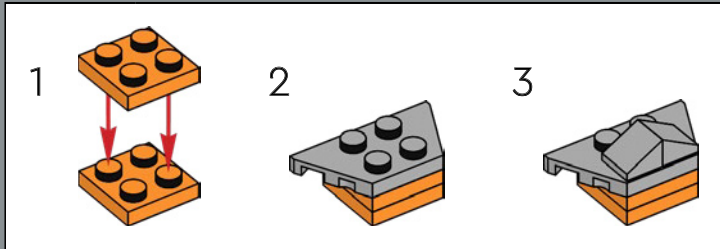



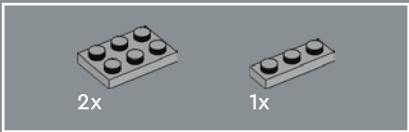

309

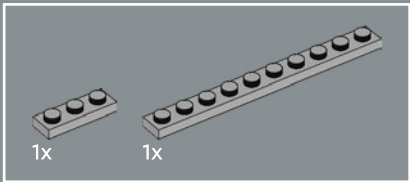
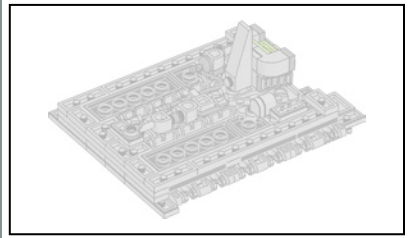
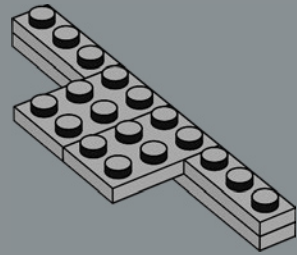

308

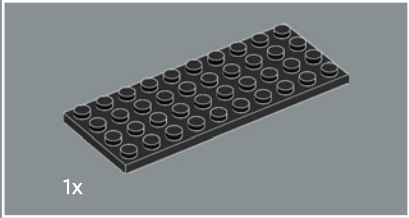
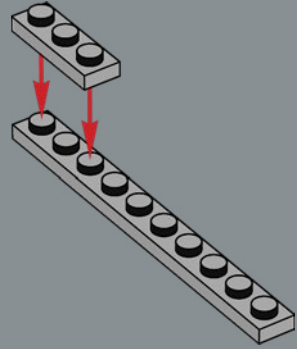

310

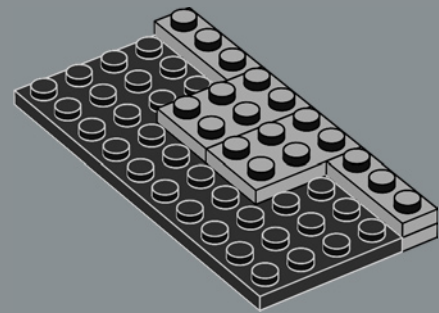

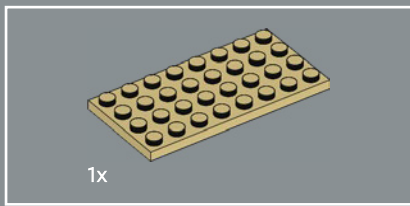

311

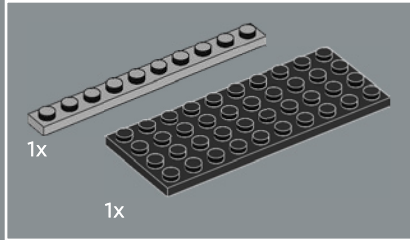
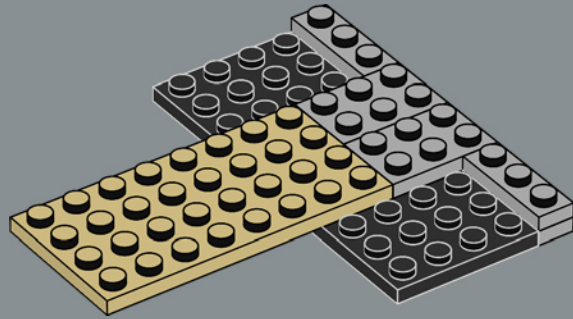

312

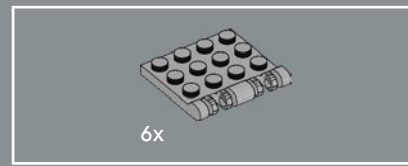
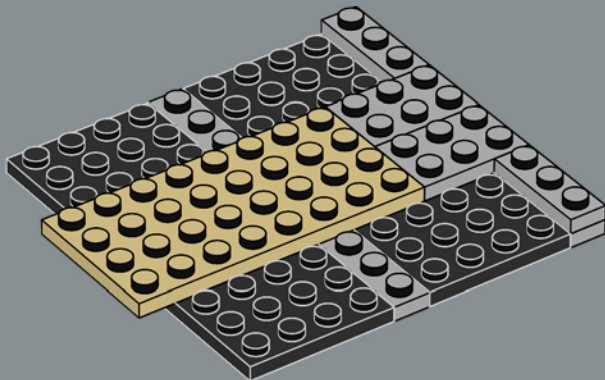

313

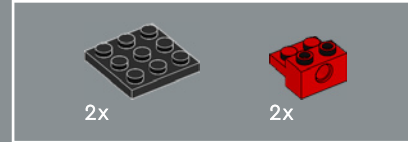
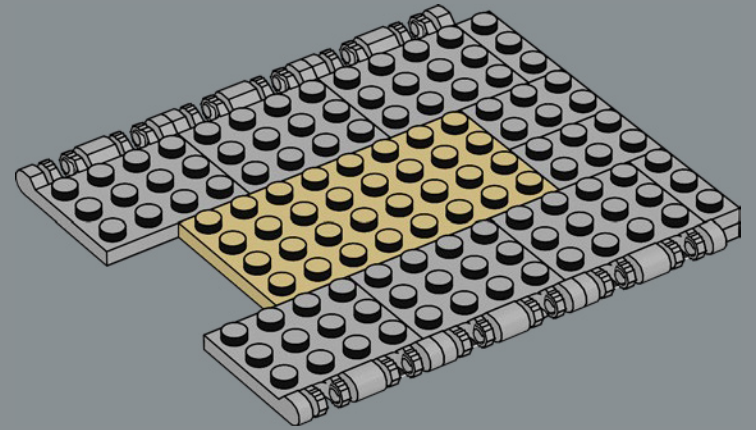

314

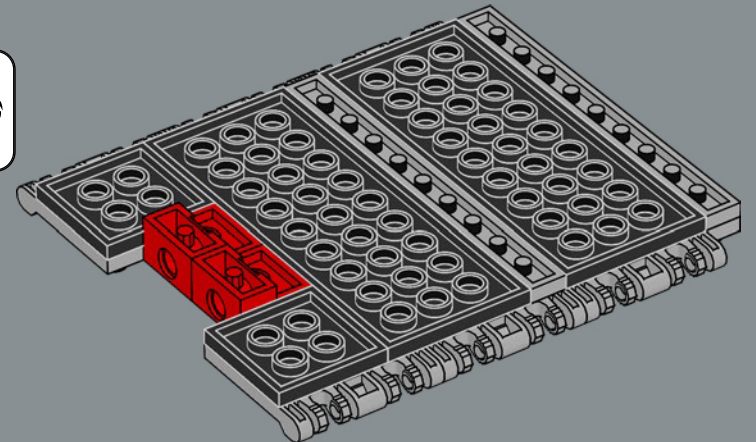





315

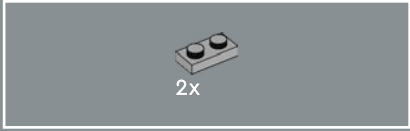
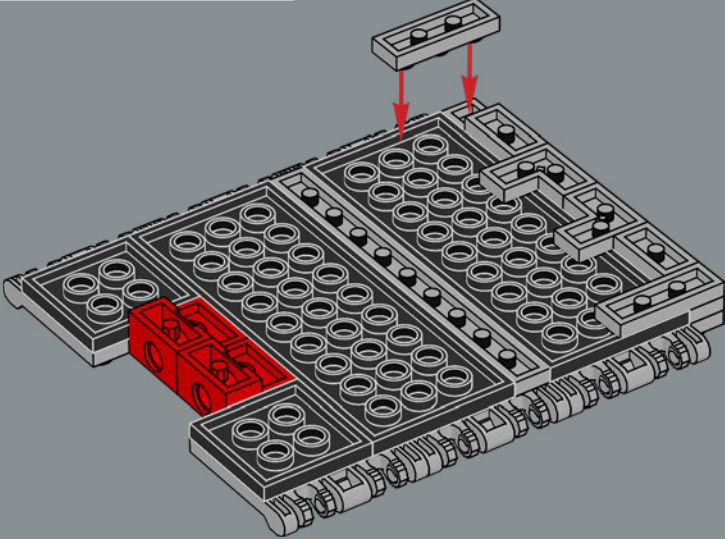

316

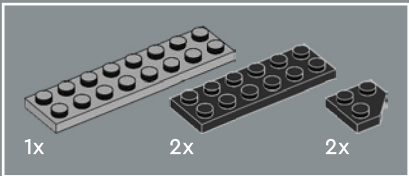
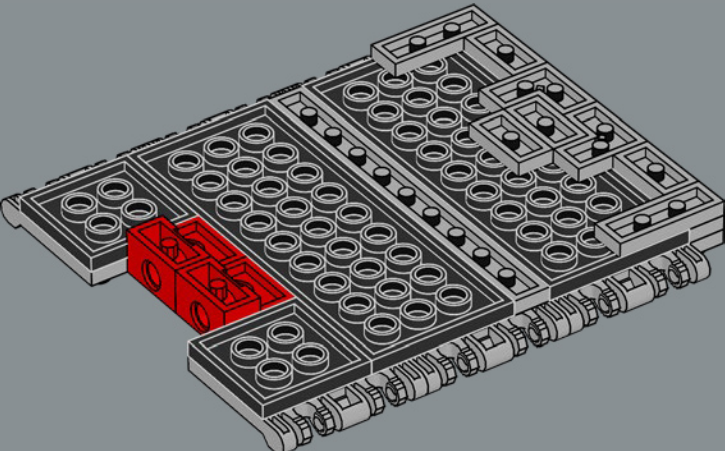

317

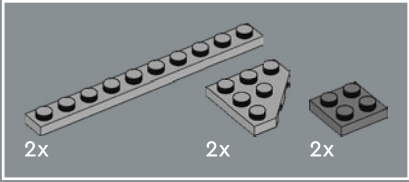
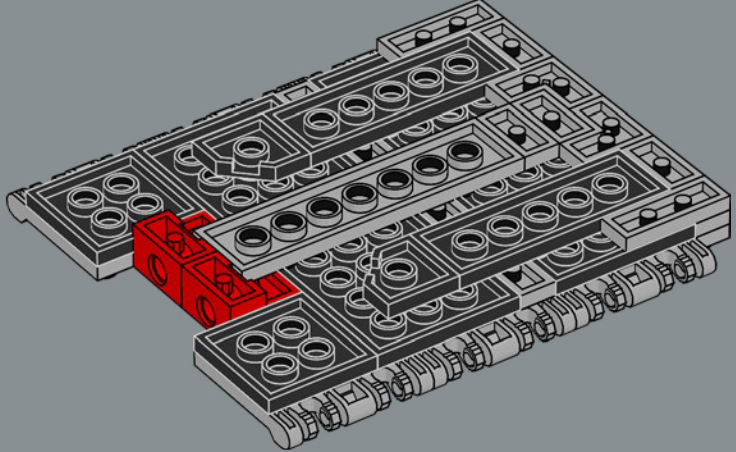

318

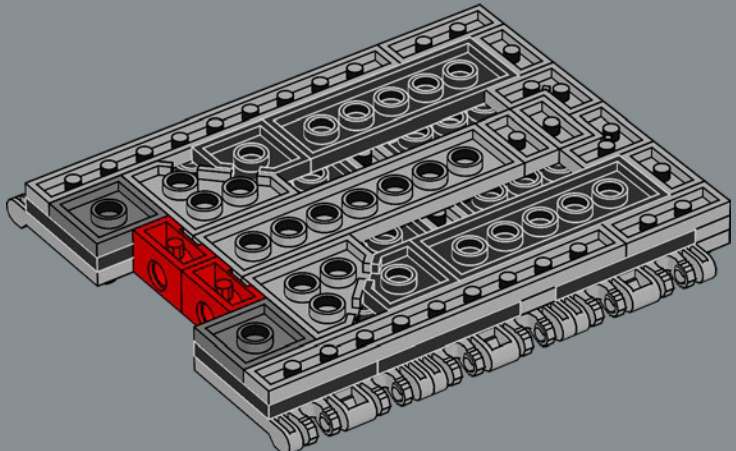

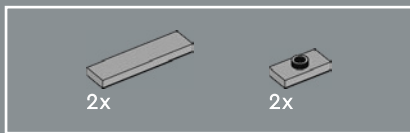

319

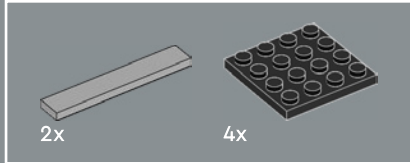
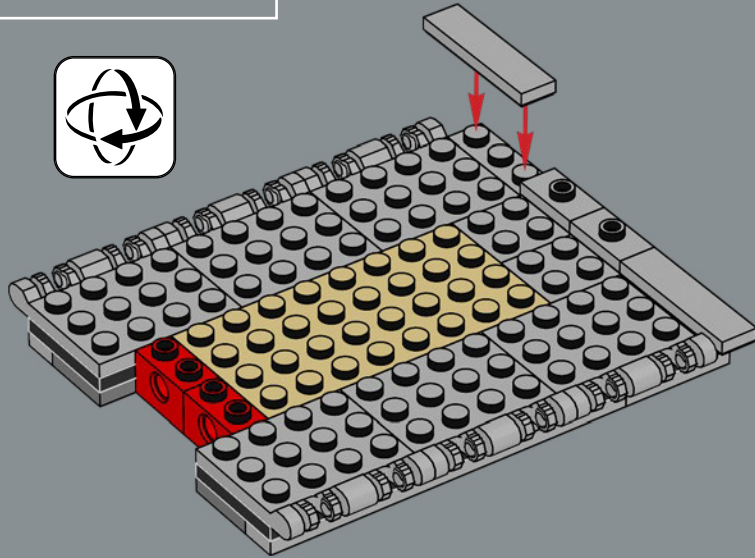

320

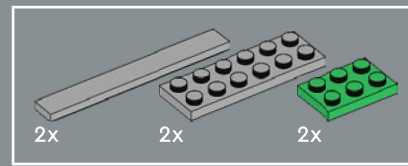
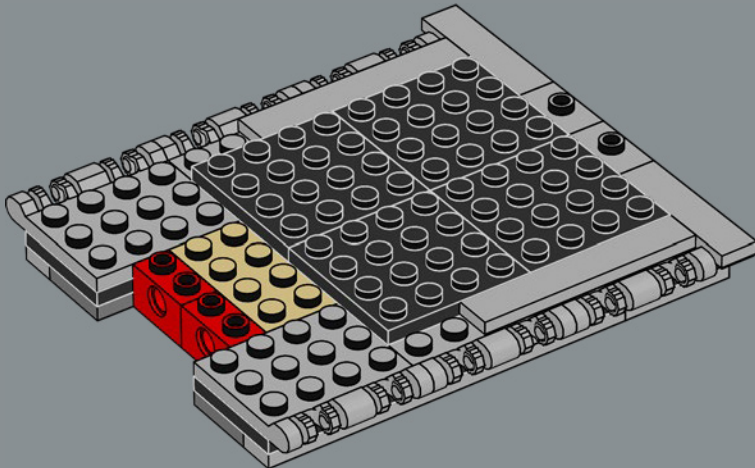

321

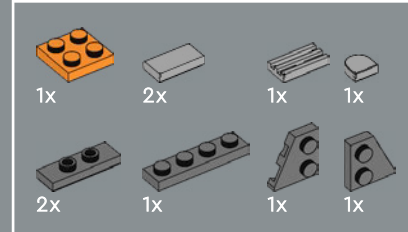
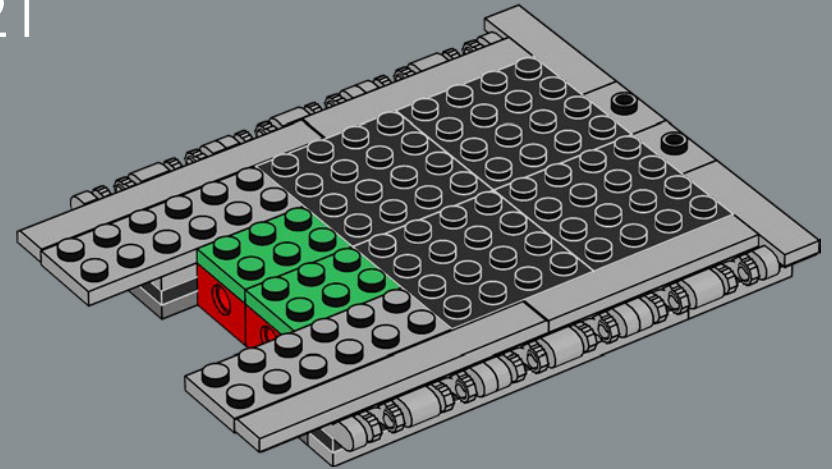

322

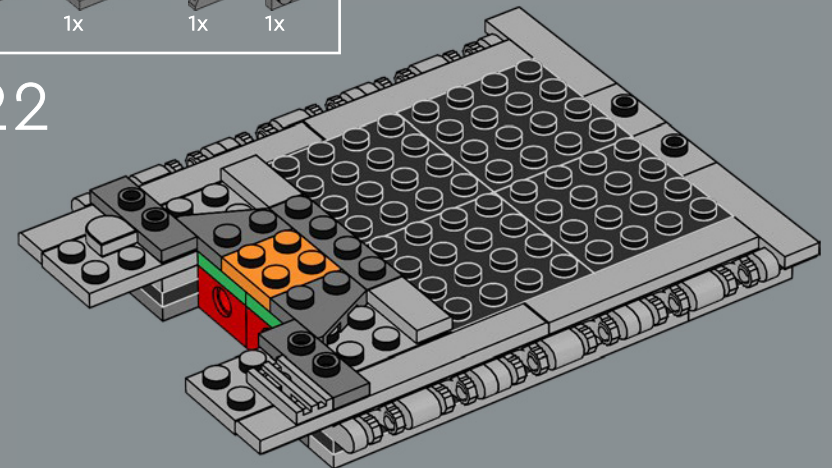



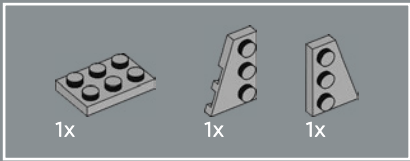

323

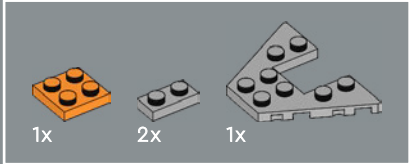
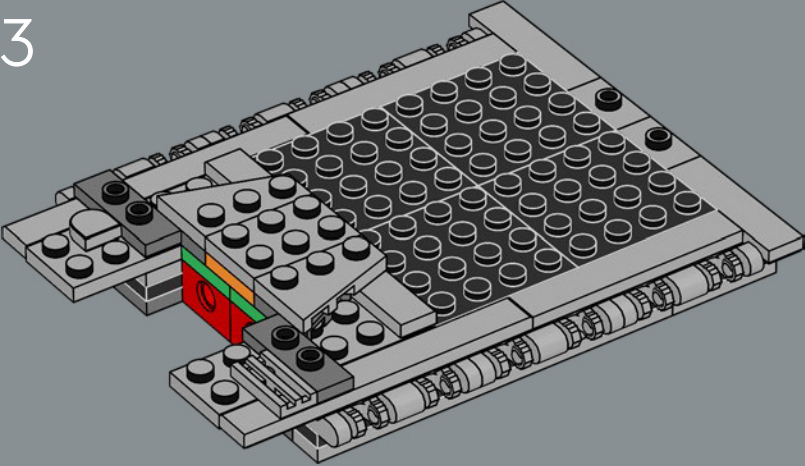

324

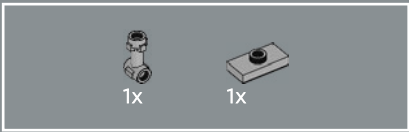
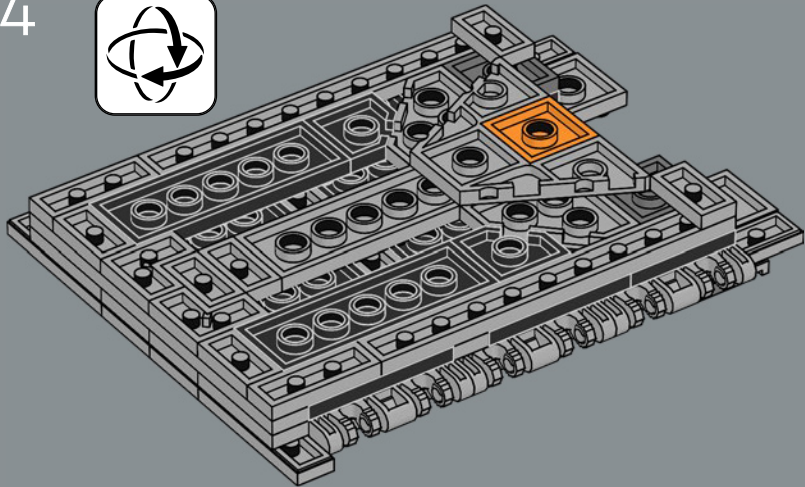

325

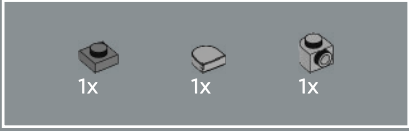
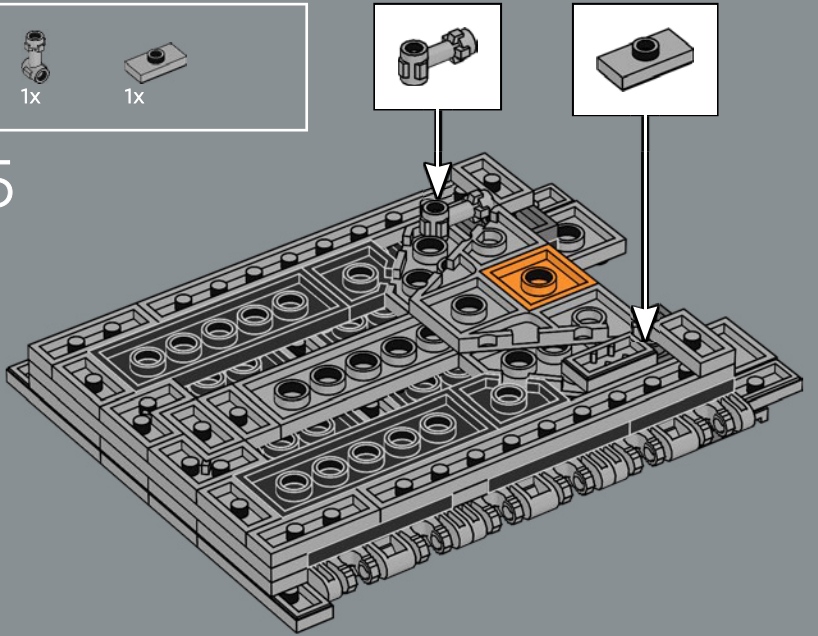

326

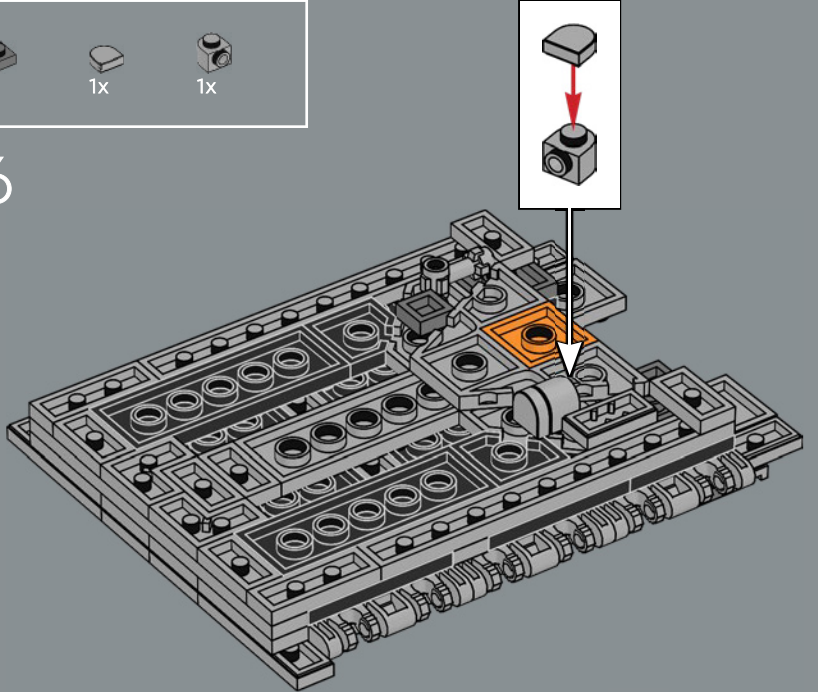

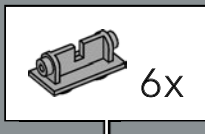

327

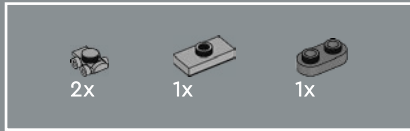
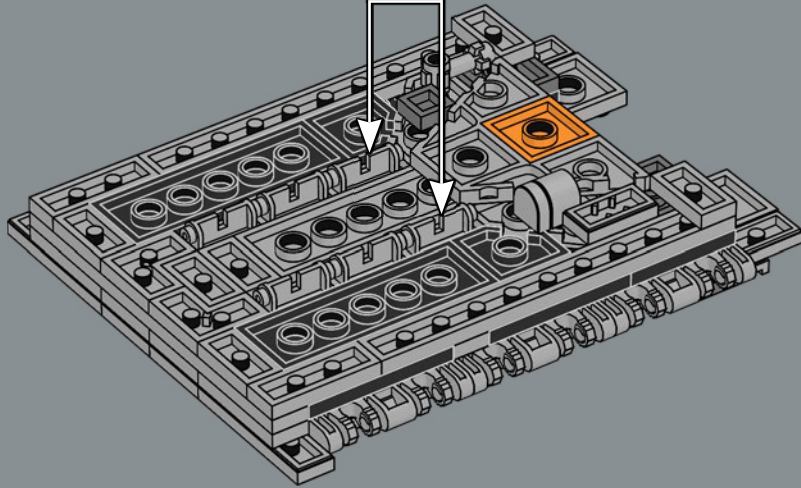

328

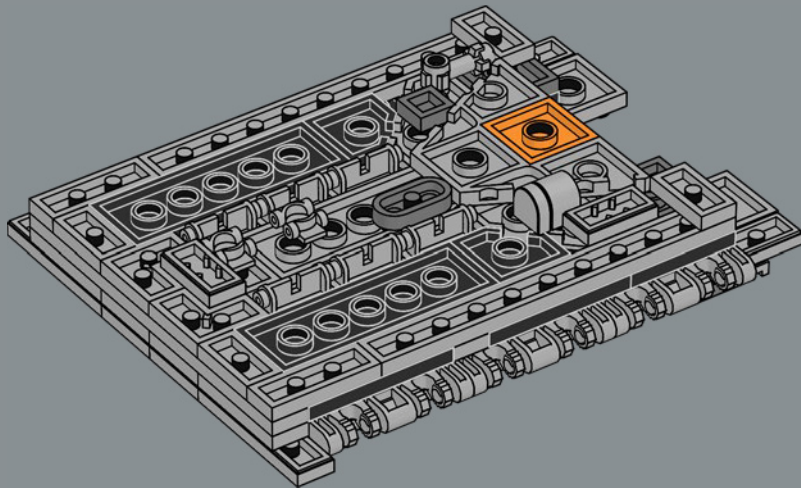

329

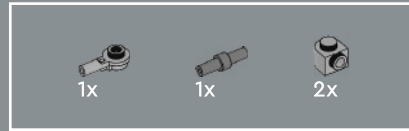
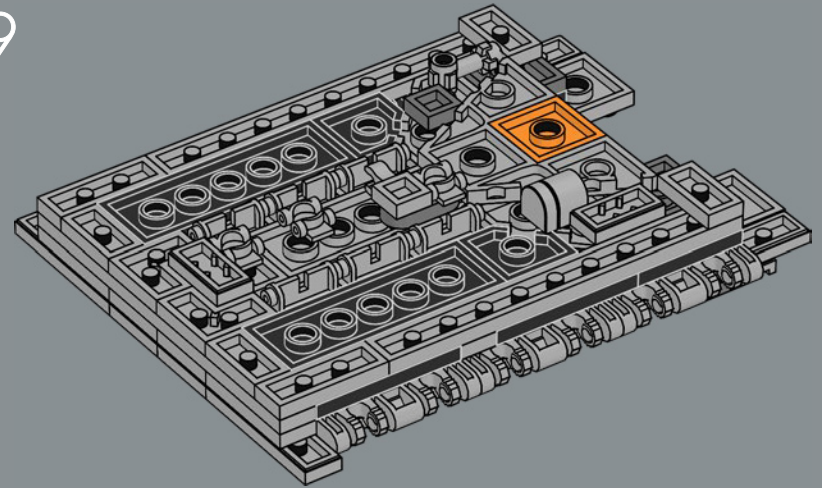

330

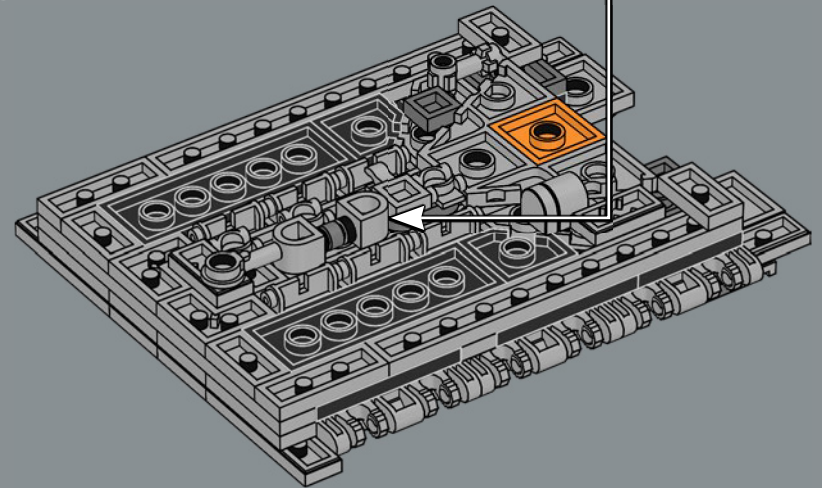
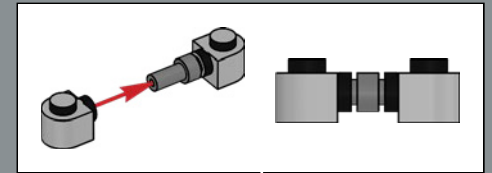





2x

331

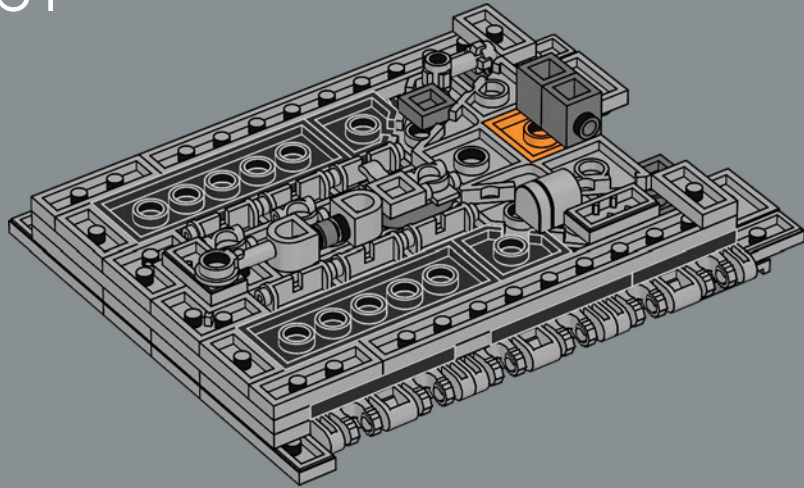

1x

332

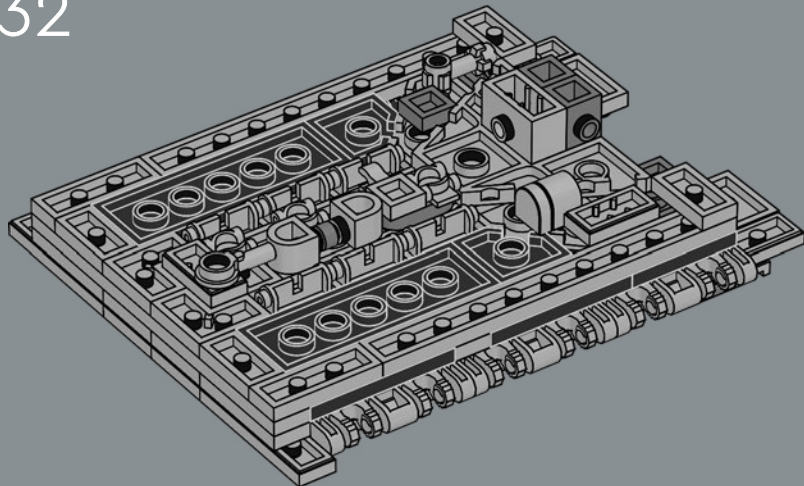

2x

333

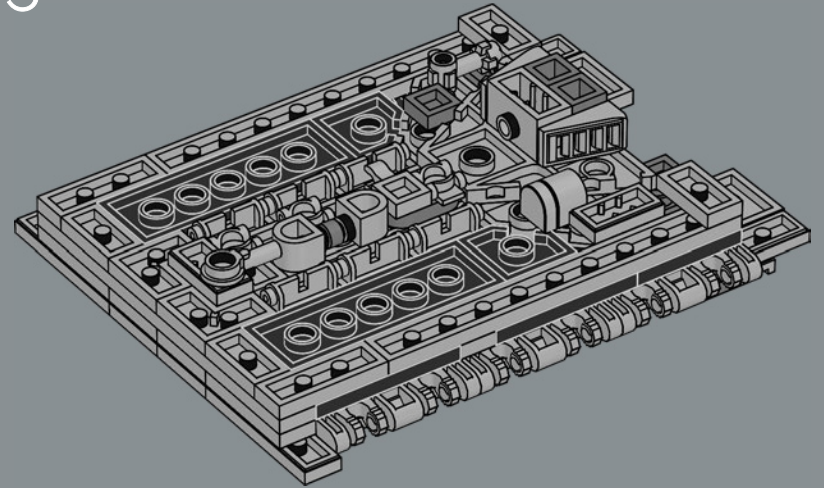

1x

334

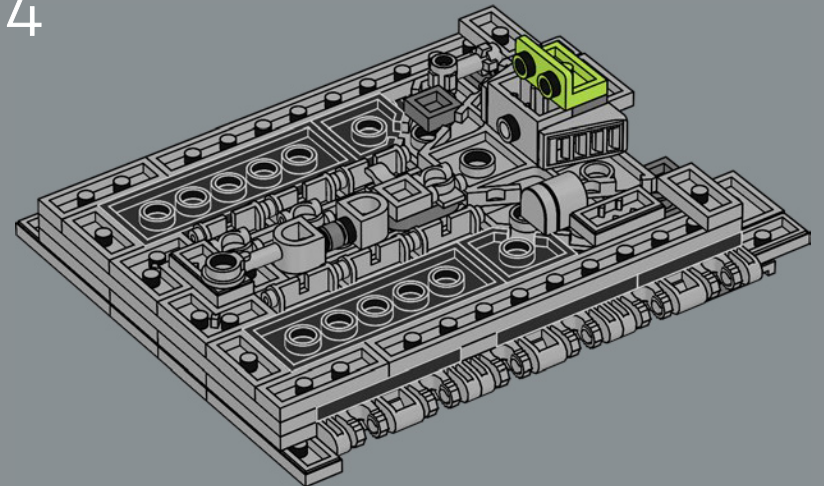

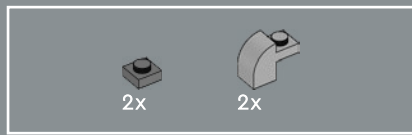

335

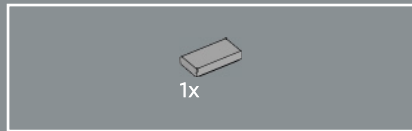
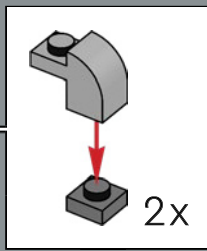
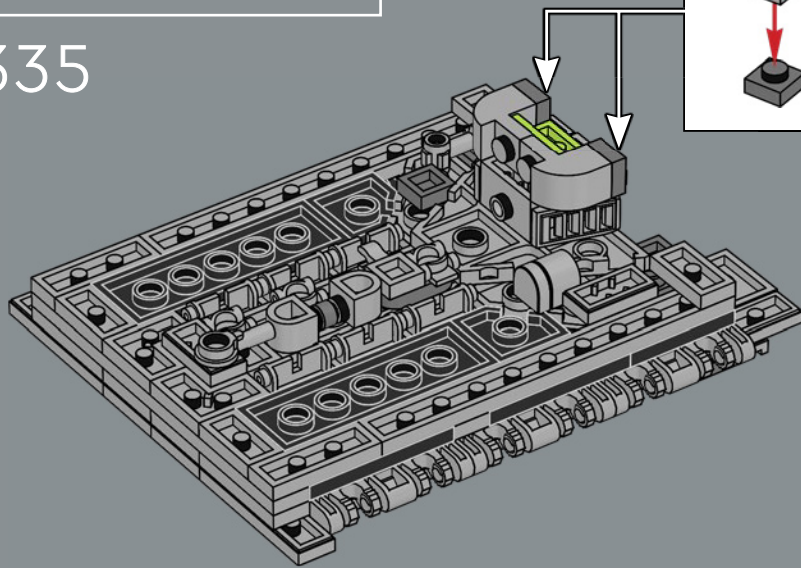

336

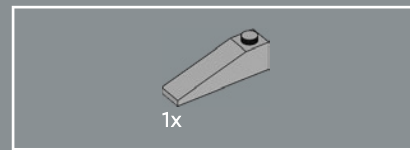
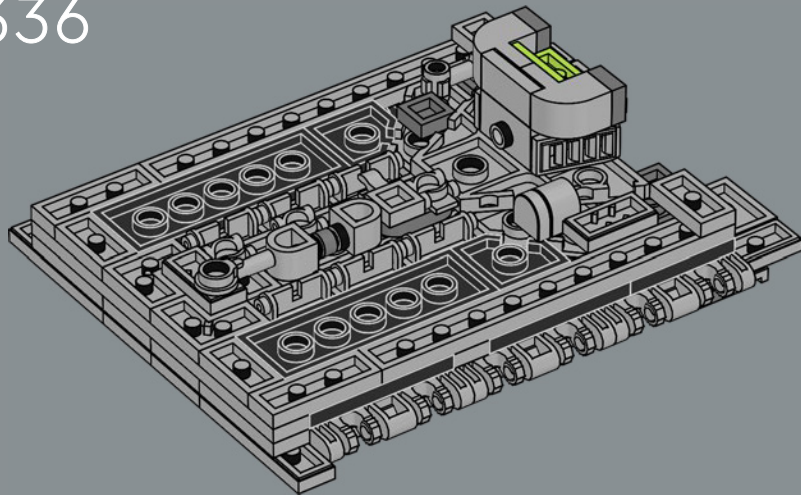

337

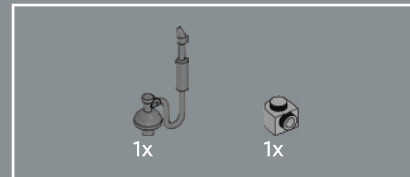
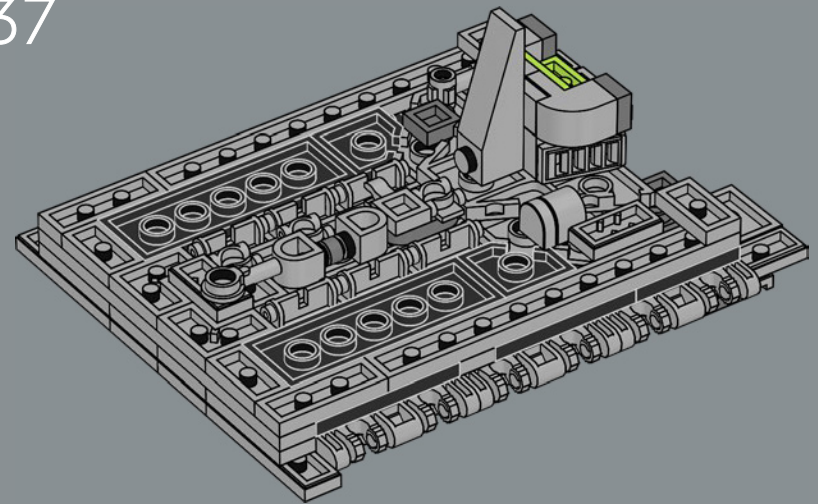

338

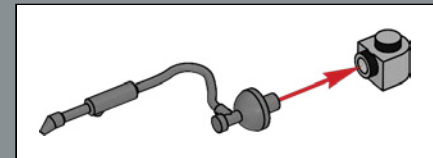
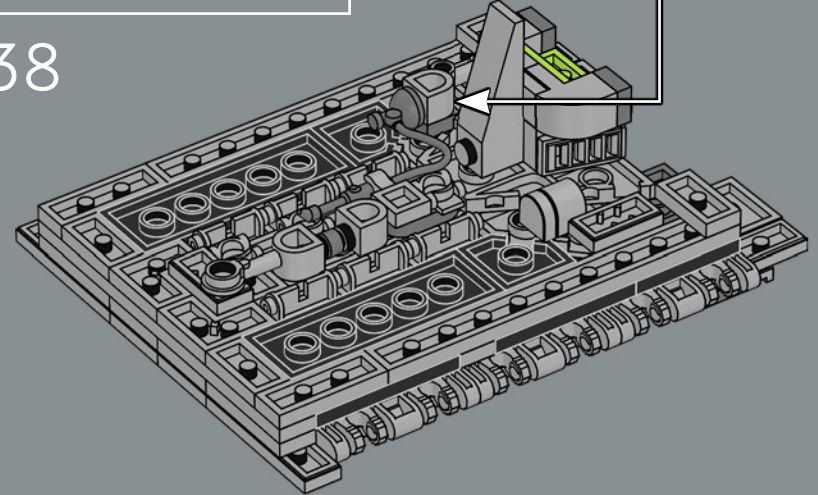



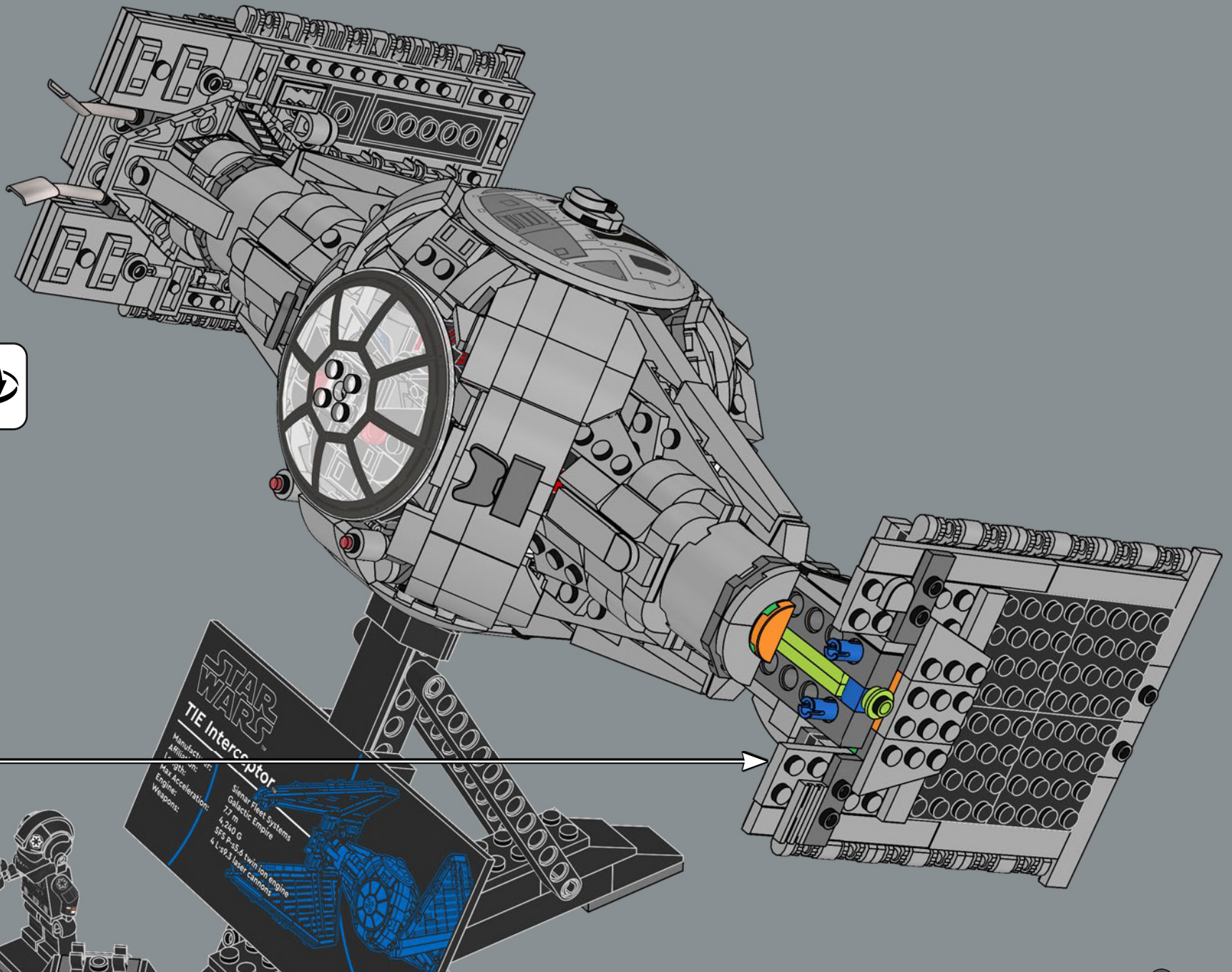

**STAR WARS**  
**TIE Interceptor™**

Manufactured by: Sienar Fleet Systems  
Manufacturer: Galactic Empire  
Length: 7.7 m  
Engines: 4x P-30.6 twin ion engine  
Weapons: 4x L3P.3 laser cannons



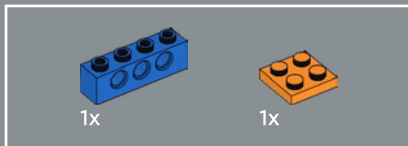
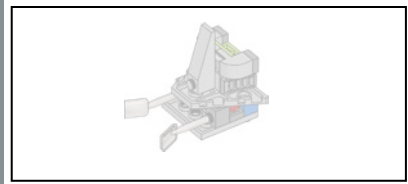

340

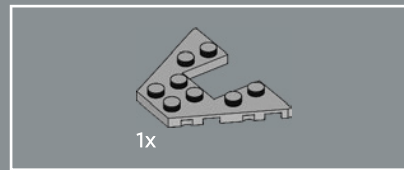
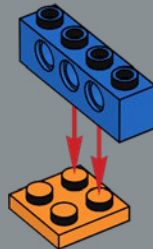

341

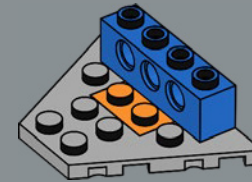

342

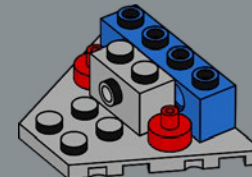



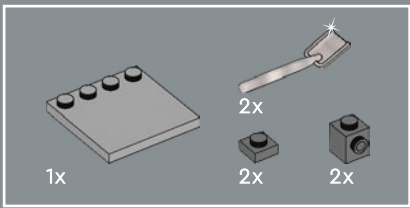

343

1

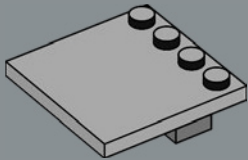

2

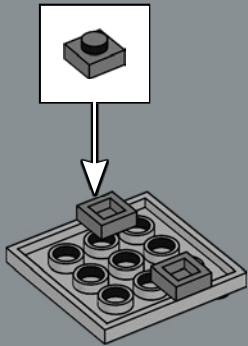

3

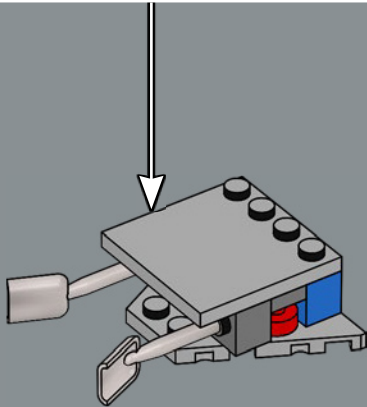
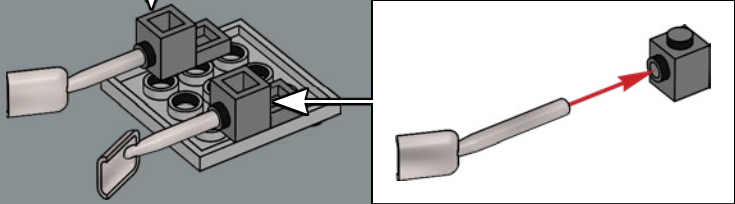
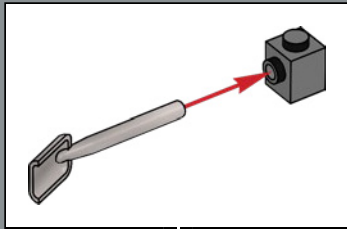



344

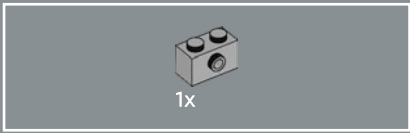
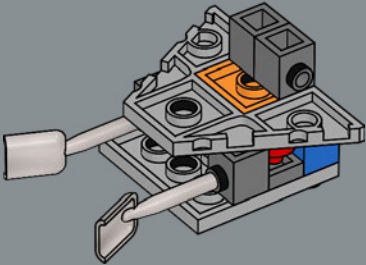

345

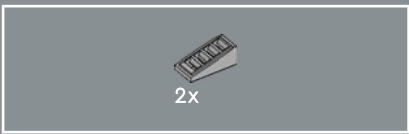
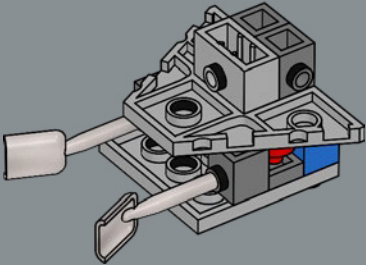

346

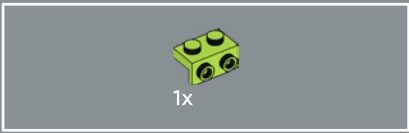
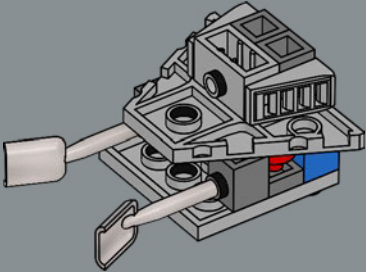

347

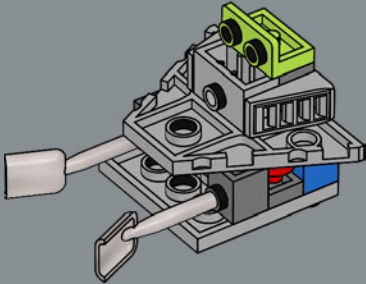

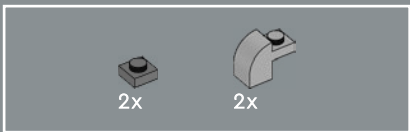

348

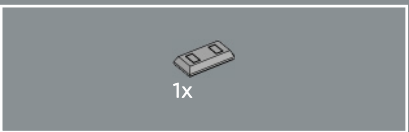
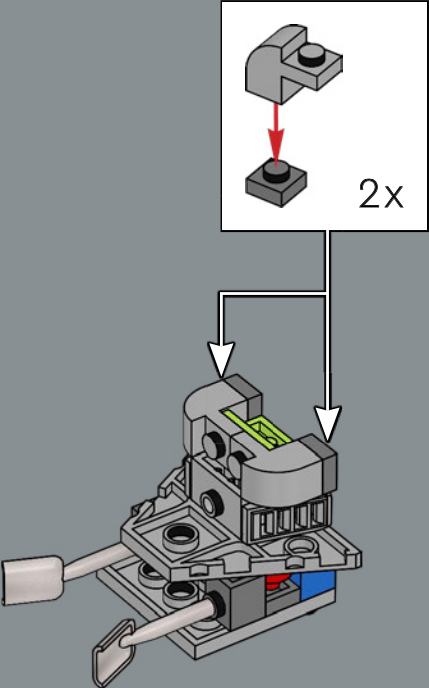

349

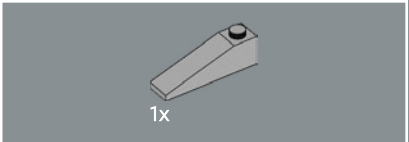
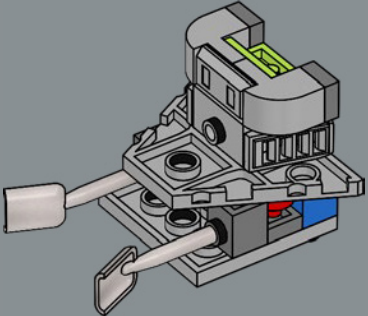

350

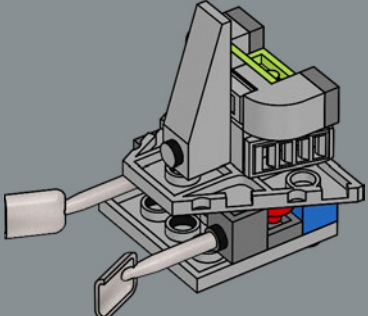

351

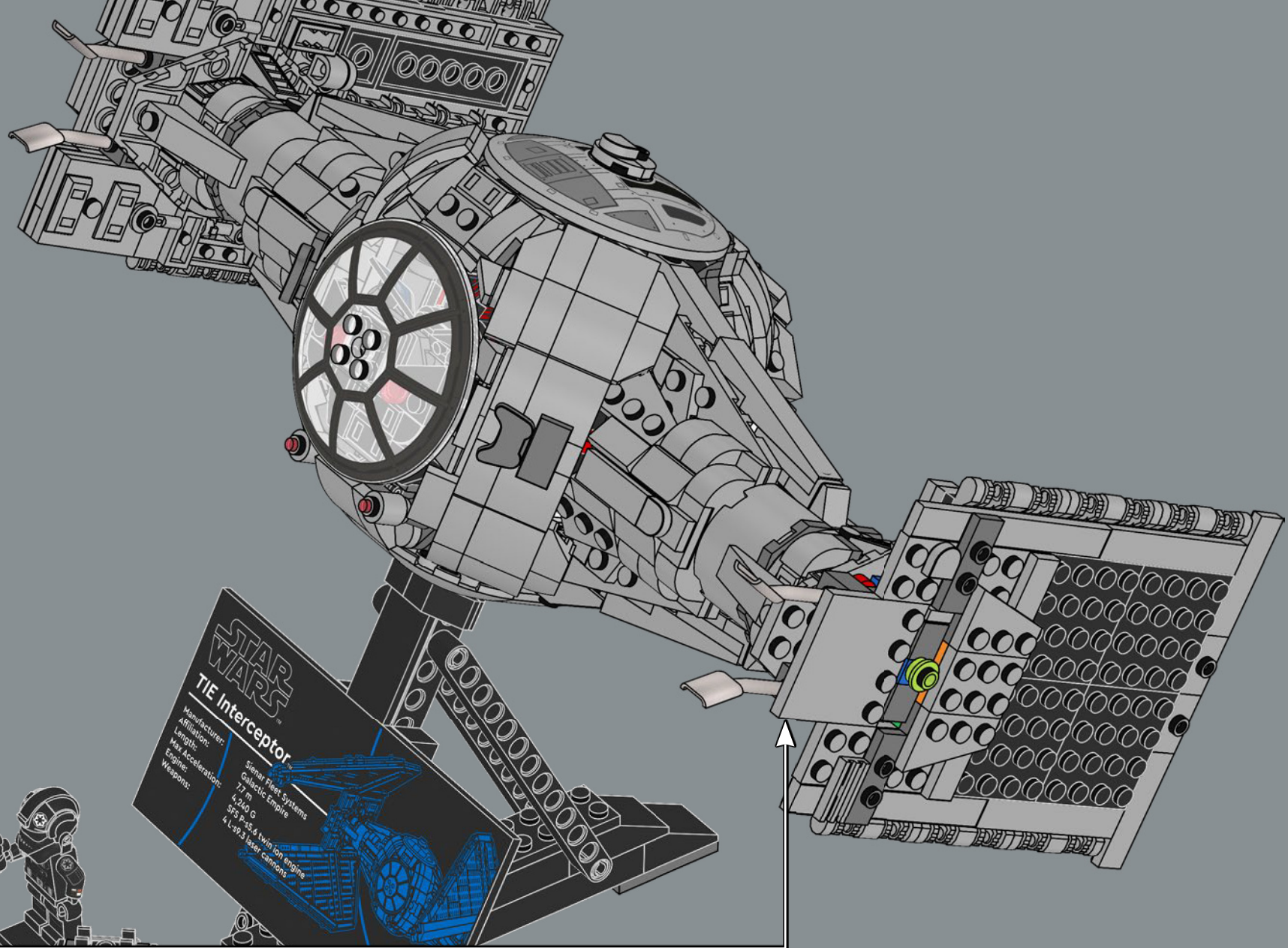

**STAR WARS**  
**TIE Interceptor**

Manufacturer: Sienar Fleet Systems  
Affiliation: Galactic Empire  
Length: 7.7 m  
Max Acceleration: 4,240 G  
Engine: SFS ps-5,4 twin ion engine  
Weapons: 4 LSP-3 laser cannons

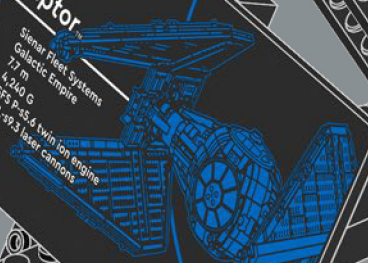



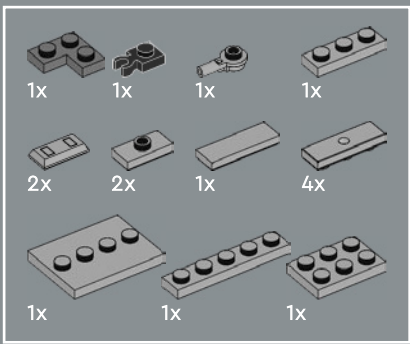

# 352

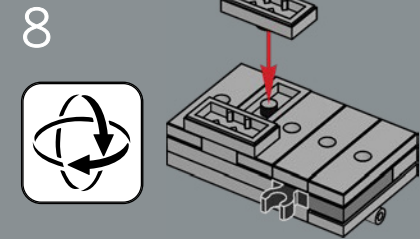
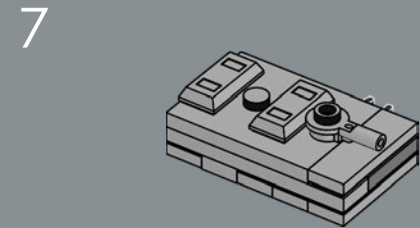
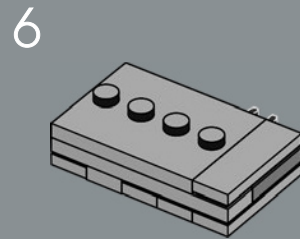
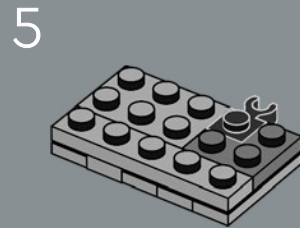
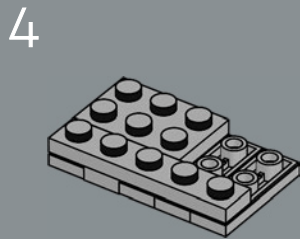
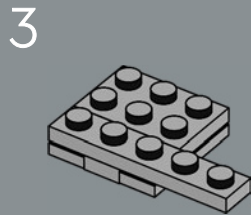
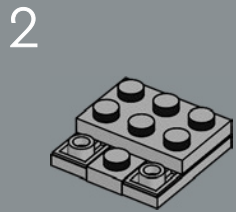
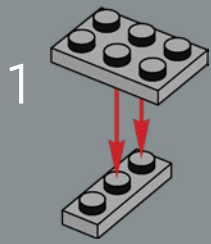

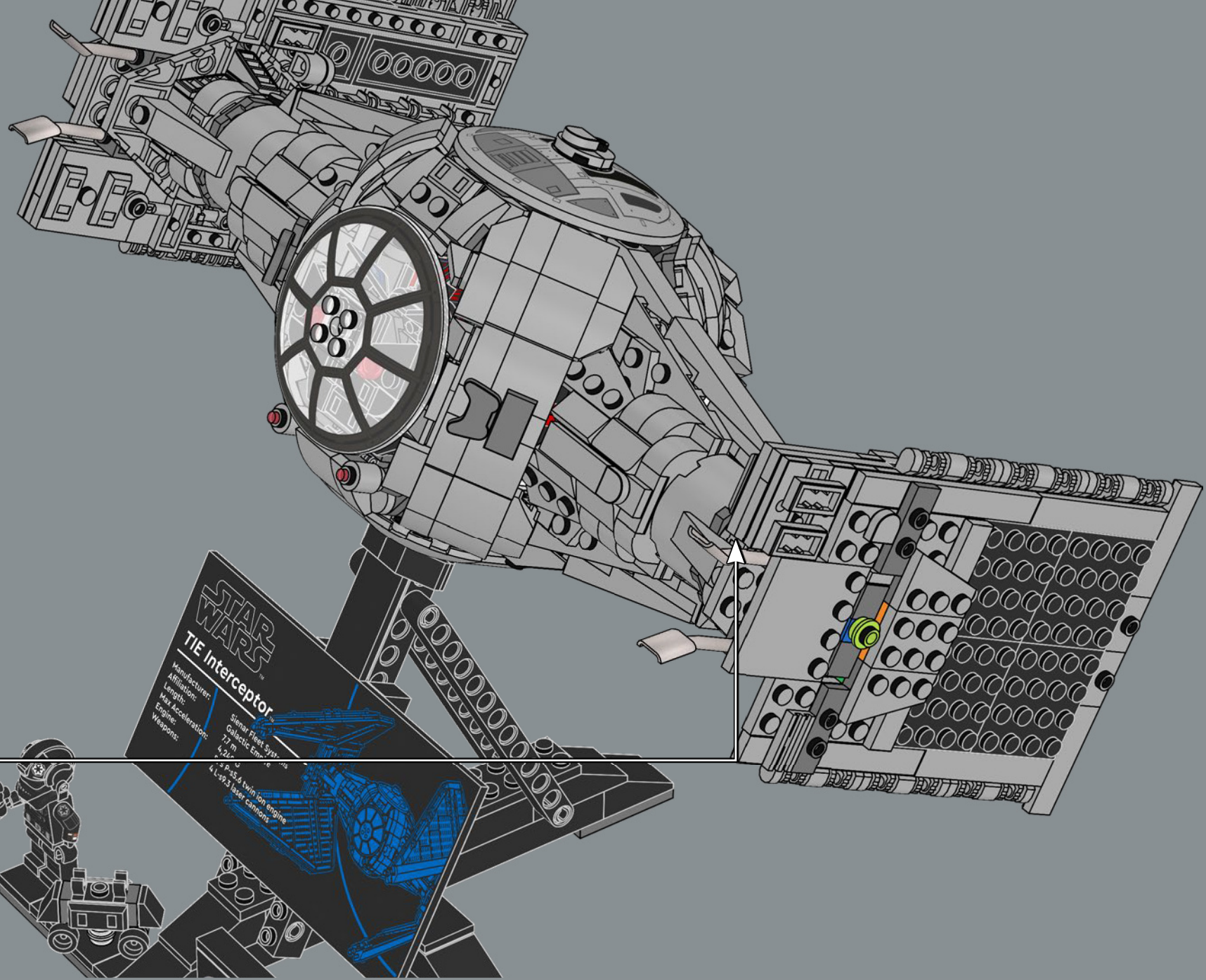

**STAR WARS**  
**TIE Interceptor**

Manufacturer:	Sienar Fleet Systems
Affiliation:	Galactic Empire
Length:	7.7 m
Max Acceleration:	4.2G
Engine:	2 P-25.5 twin ion engines
Weapons:	4 L-19.3 laser cannons

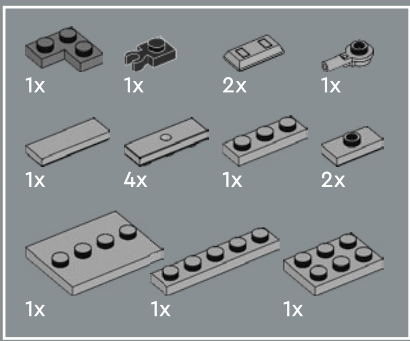

# 353

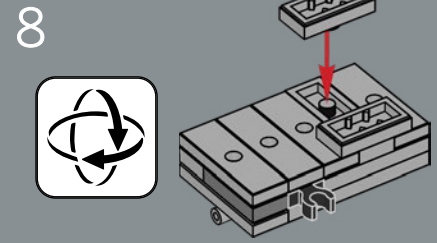
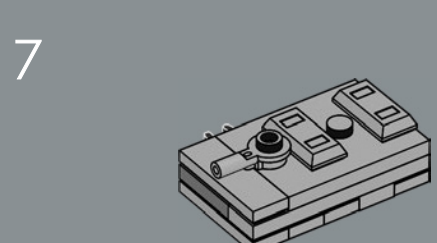
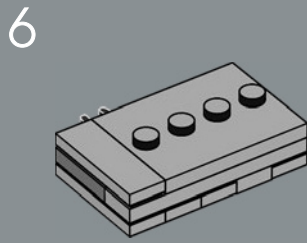
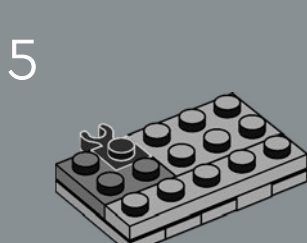
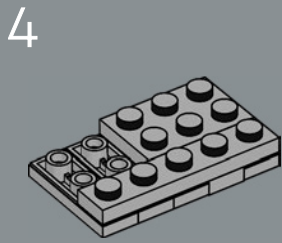
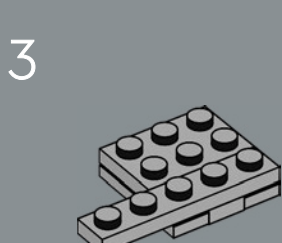
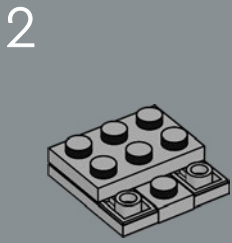
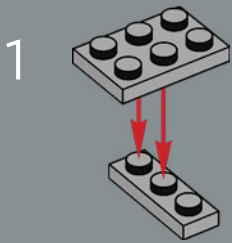



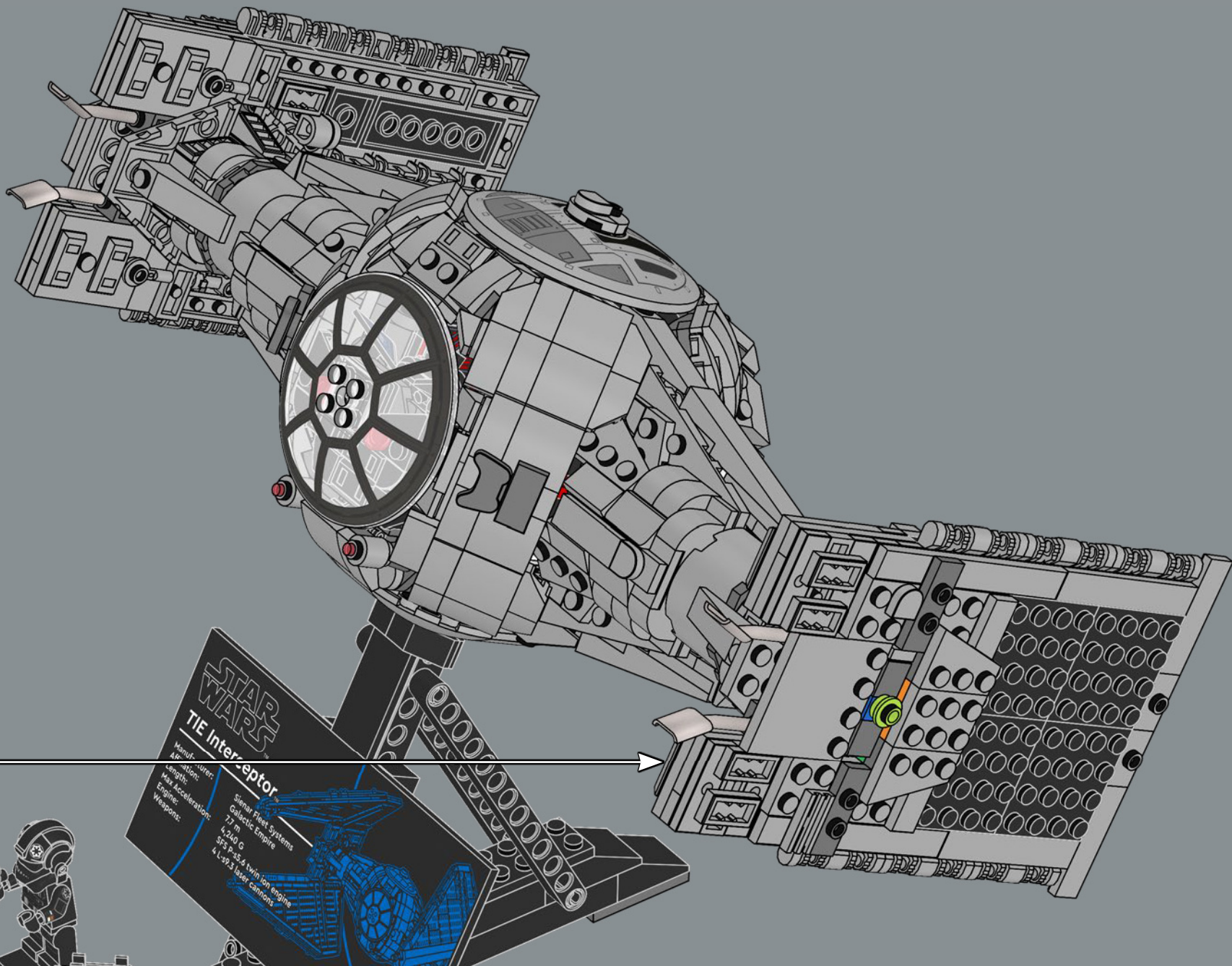

**STAR WARS**  
**TIE Interceptor™**

Manuf.: Sienar  
Alt.: Interceptor  
Length: 77 ft  
Max Acceleration: 4,240 G  
Engine: SFS P-5.4 twin ion engine  
Weapons: 4 L-29.3 laser cannons

Sienar Fleet Systems  
Galactic Empire  
4,240 G  
SFS P-5.4  
4 L-29.3 laser cannons

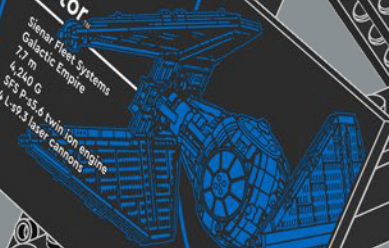



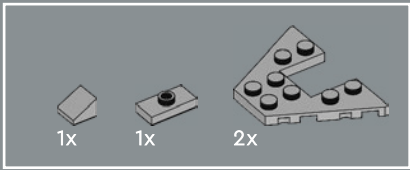

354

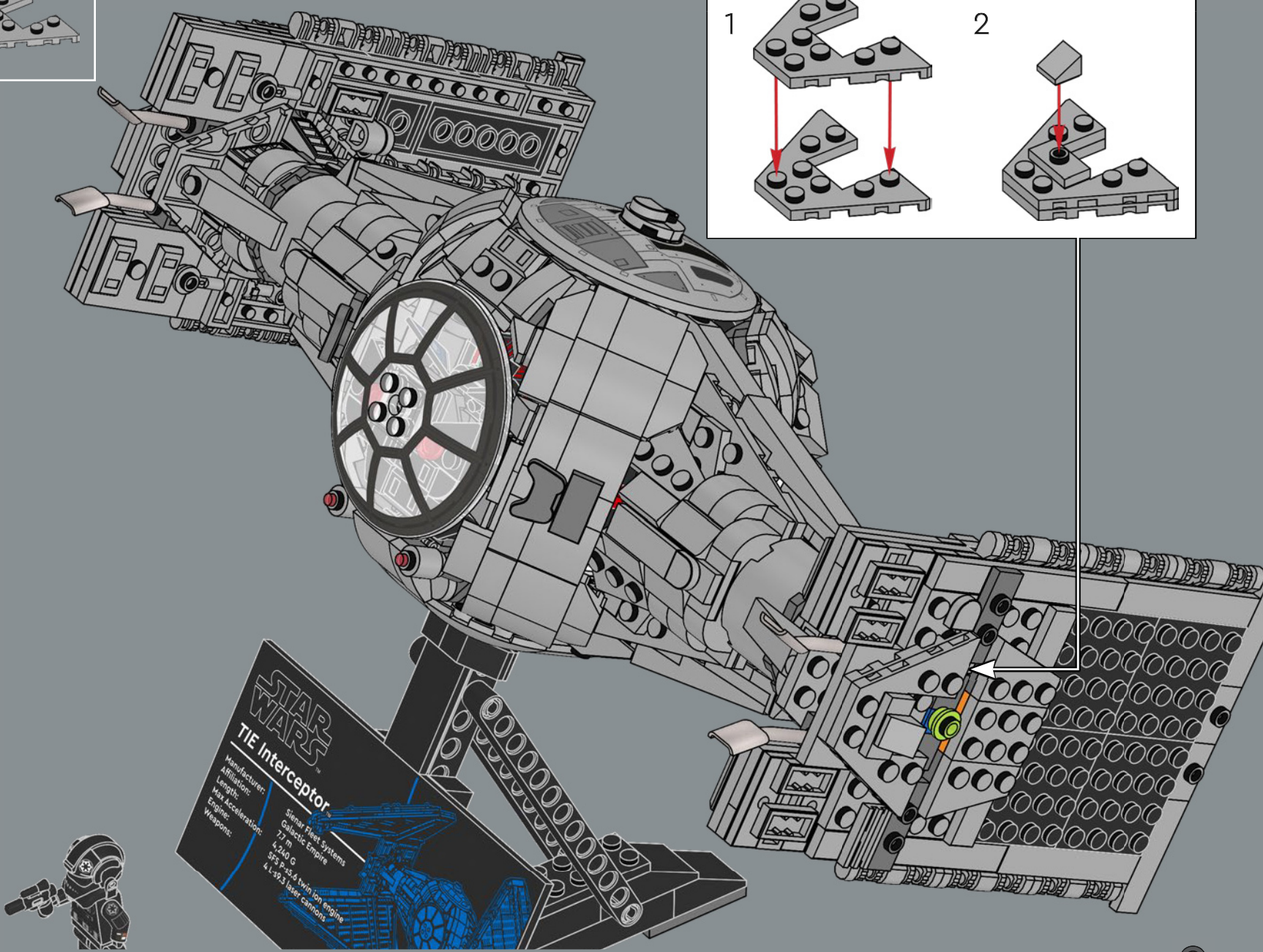
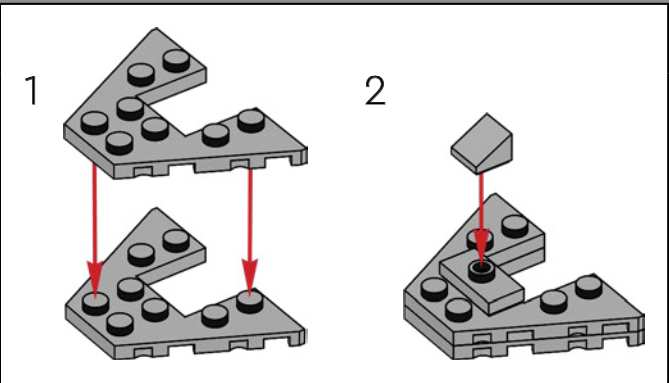

**STAR WARS™**  
**TIE Interceptor™**

Manufacturer:	Sienar Fleet Systems
Affiliation:	Galactic Empire
Length:	7.7 m
Max Acceleration:	4,240 G
Engine:	SP5 P-25.4 twin ion engine
Weapons:	4 L-9.3 laser cannons

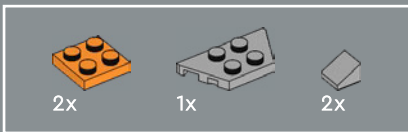

355

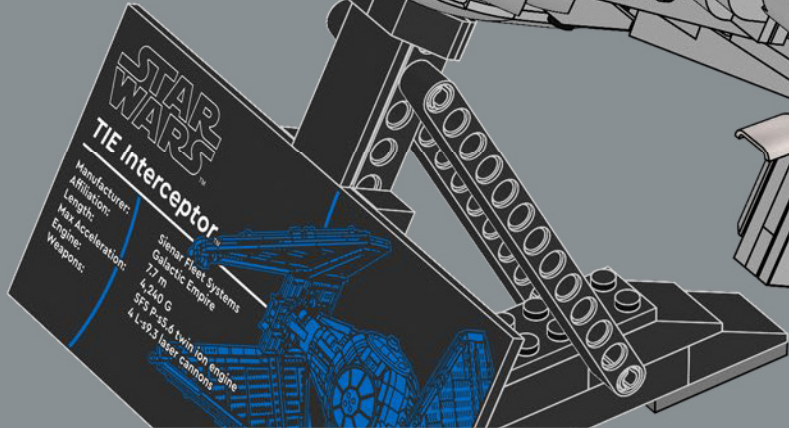
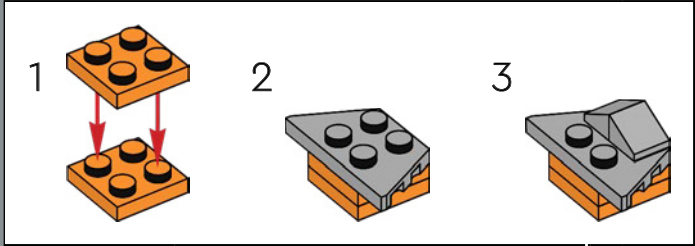
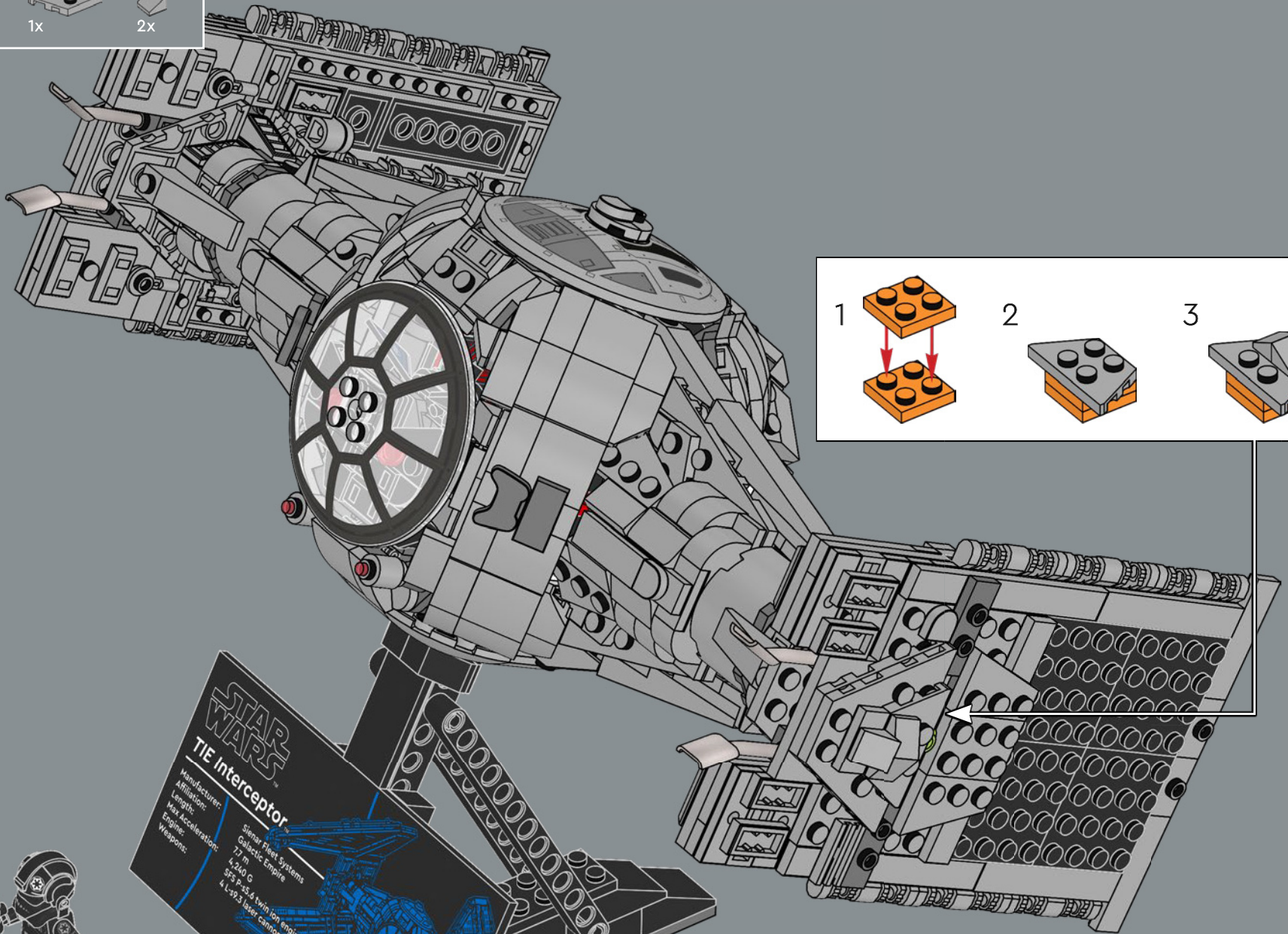



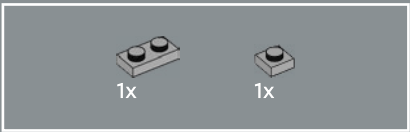
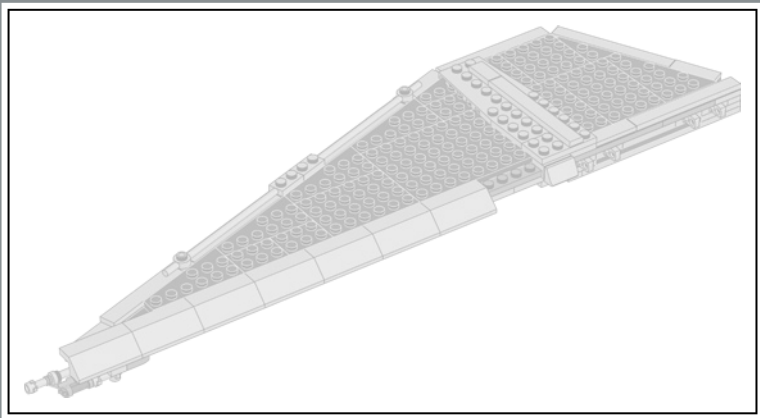

356

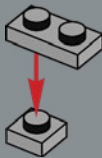

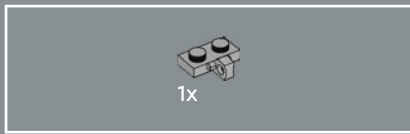

357

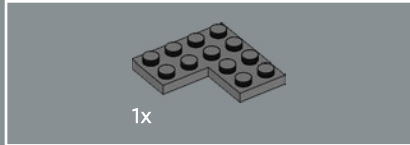
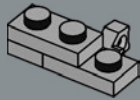

358

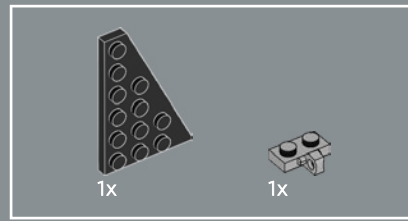
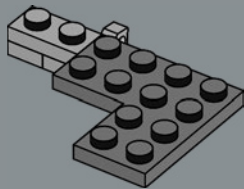

359

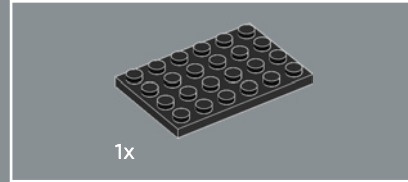
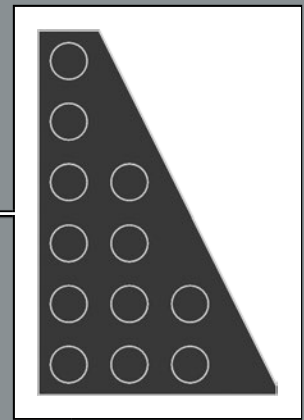
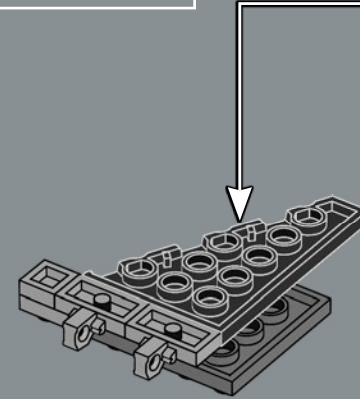

360

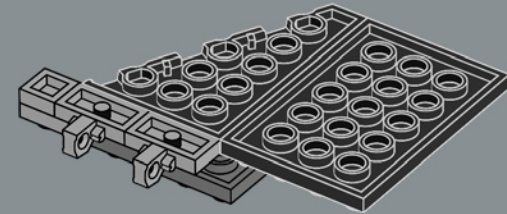



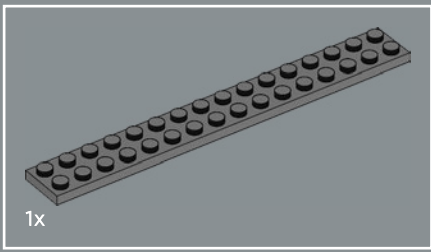

361

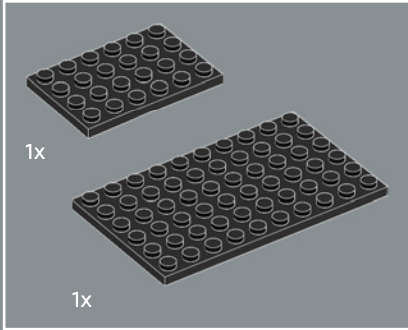
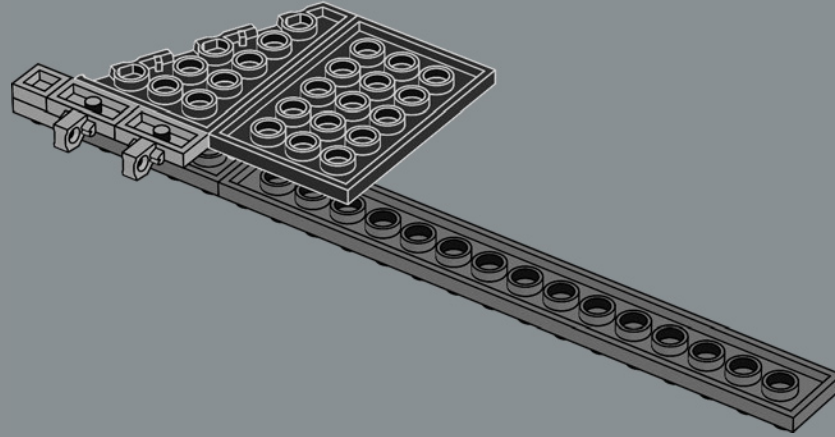

362

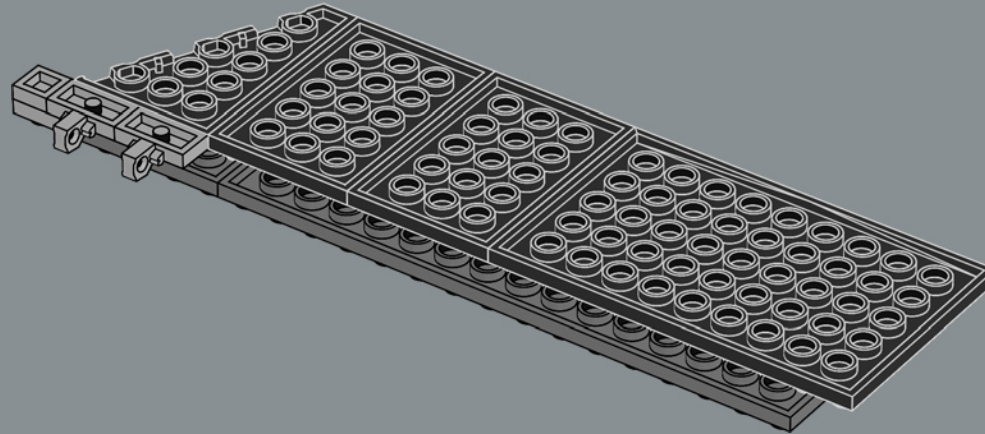

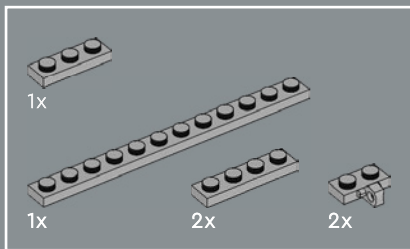

363

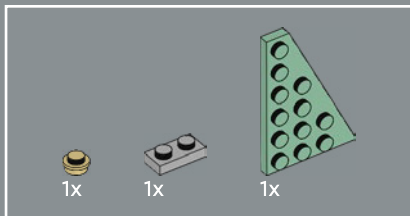
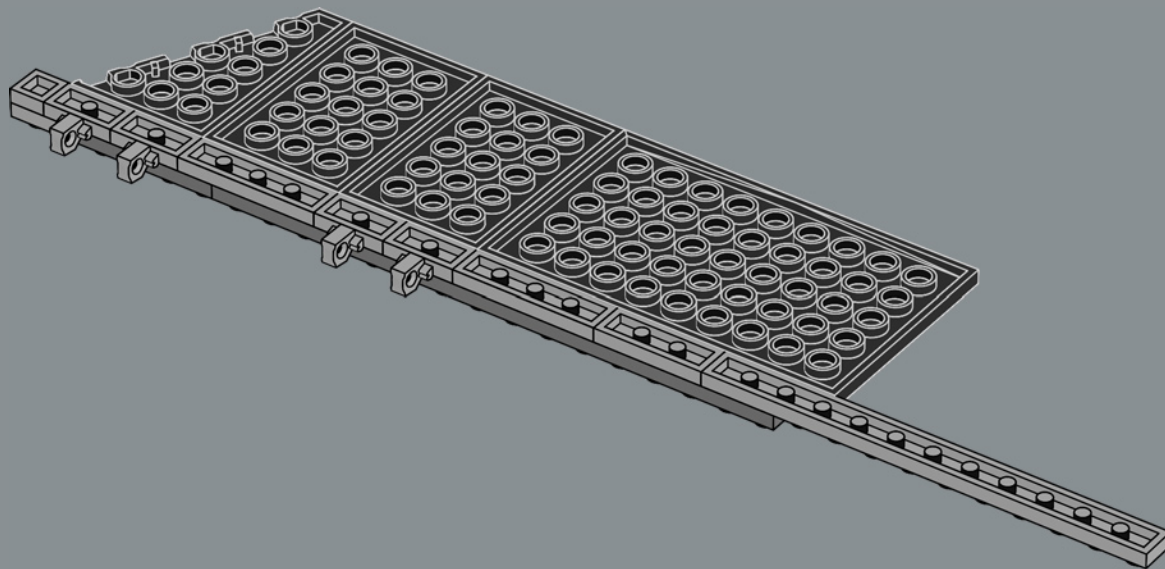

364

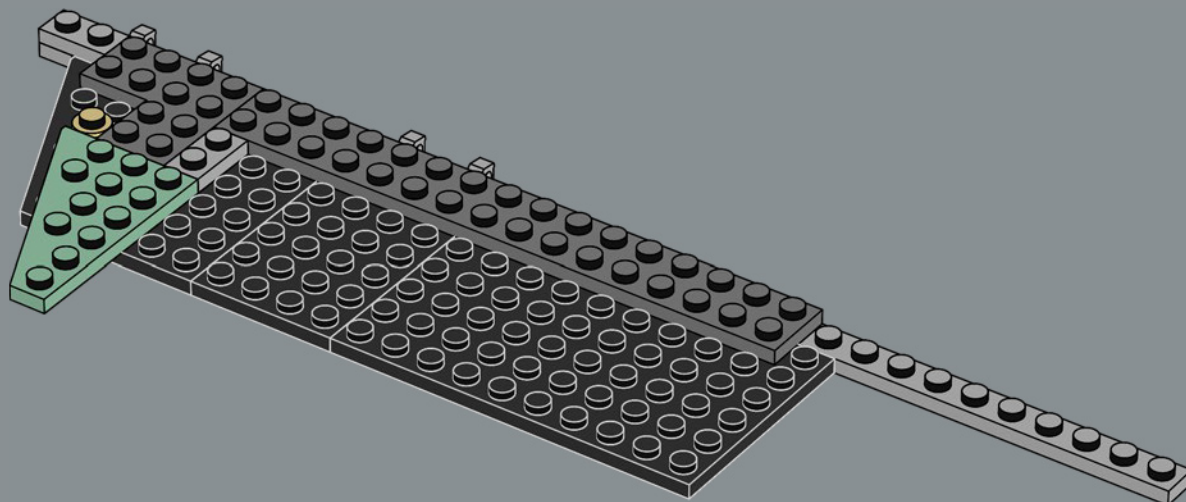

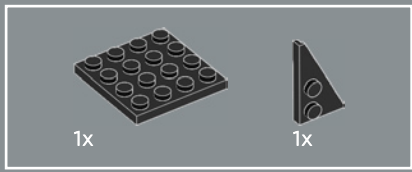

365

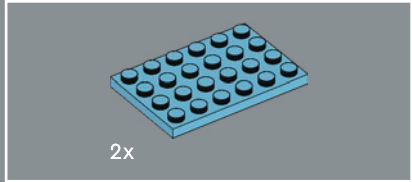
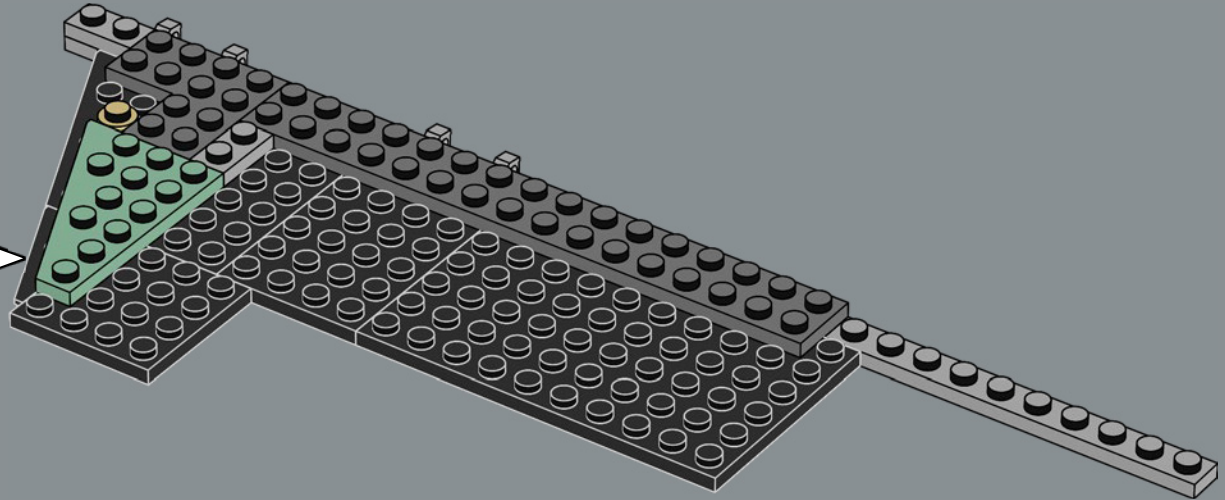
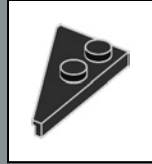

366

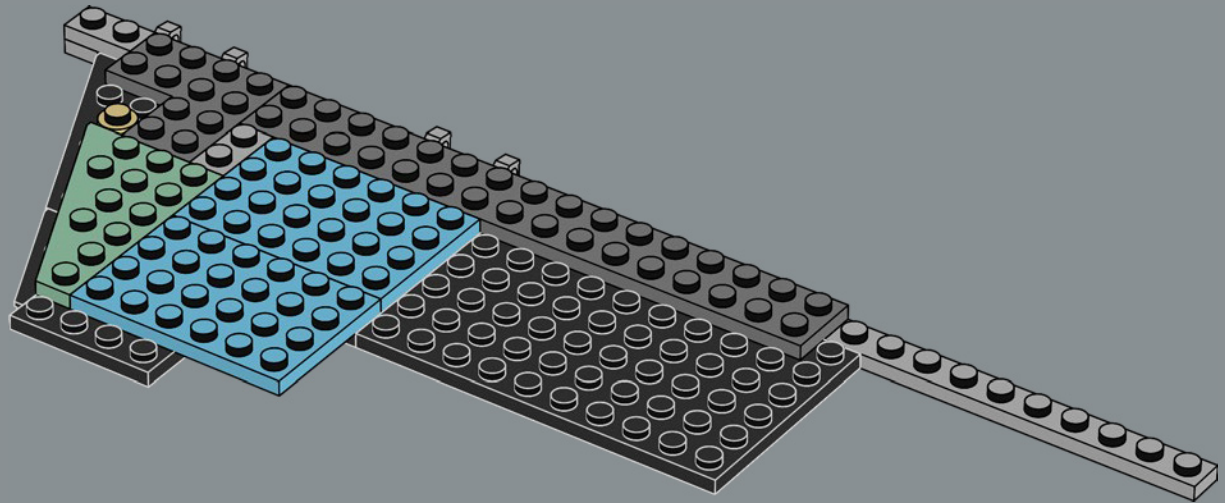

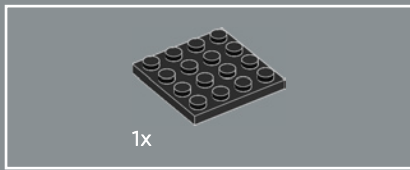

367

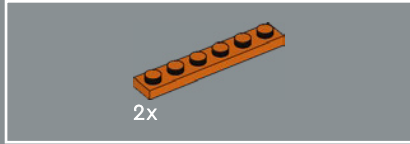
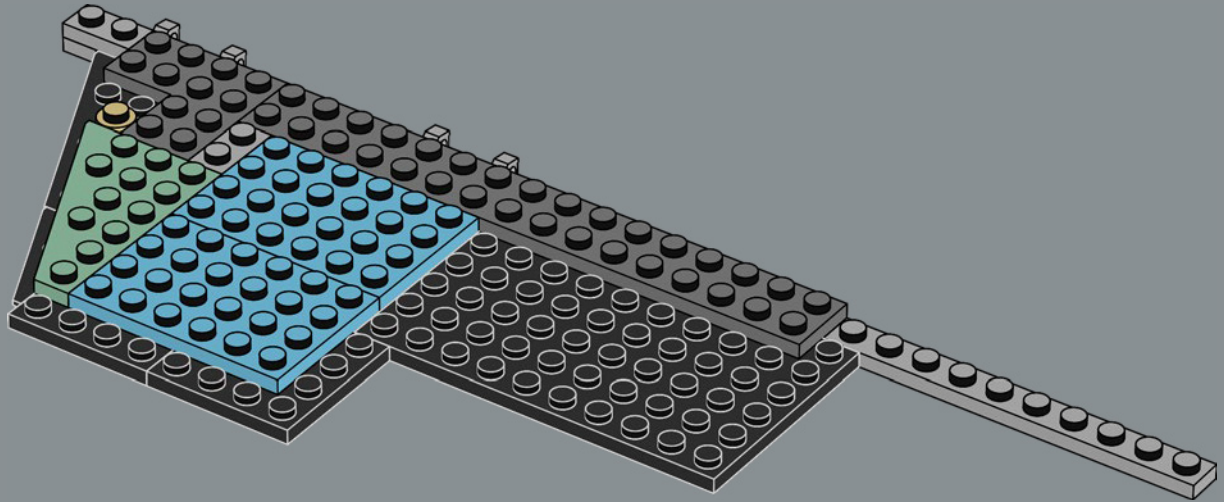

368

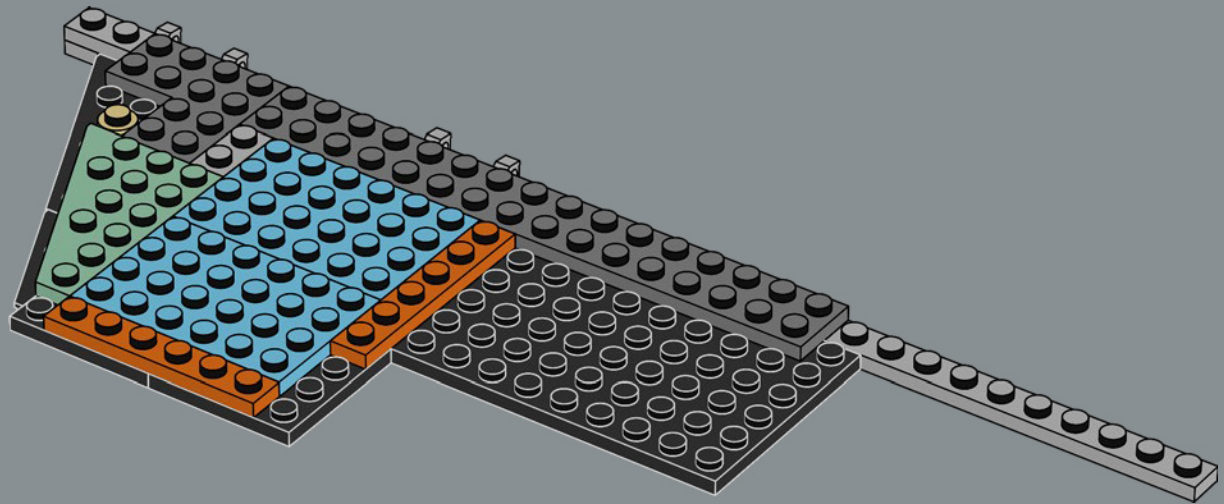



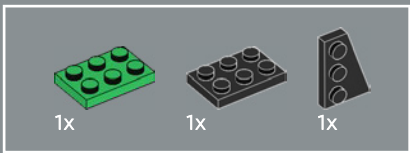

369

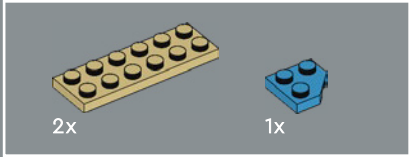
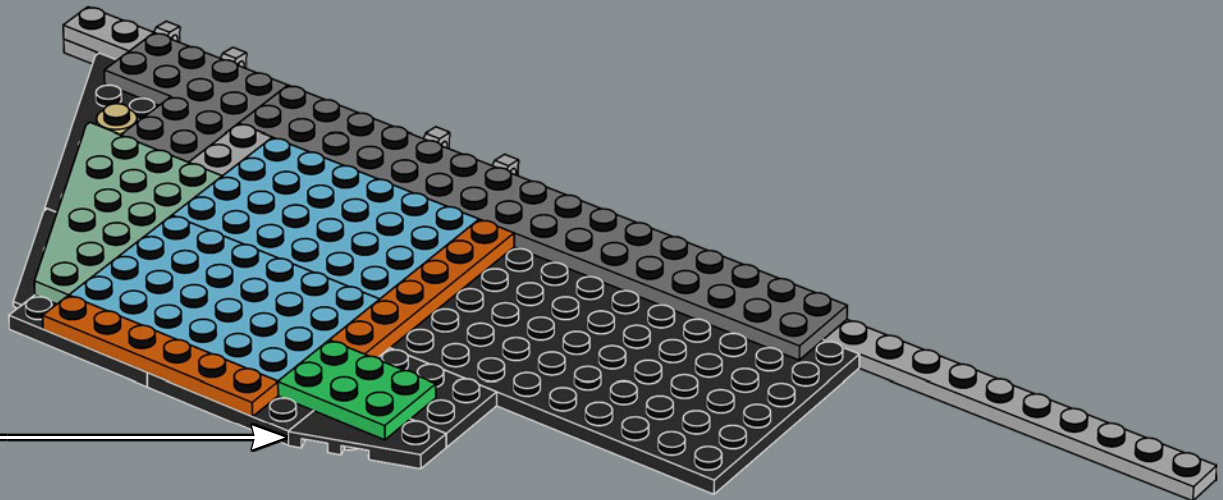
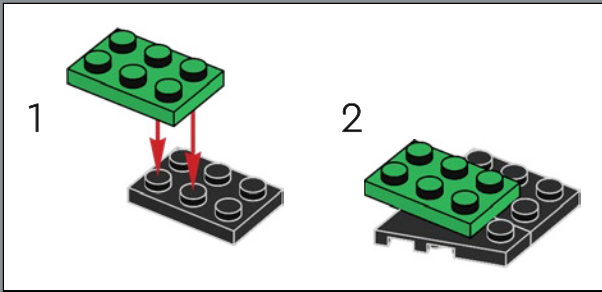

370

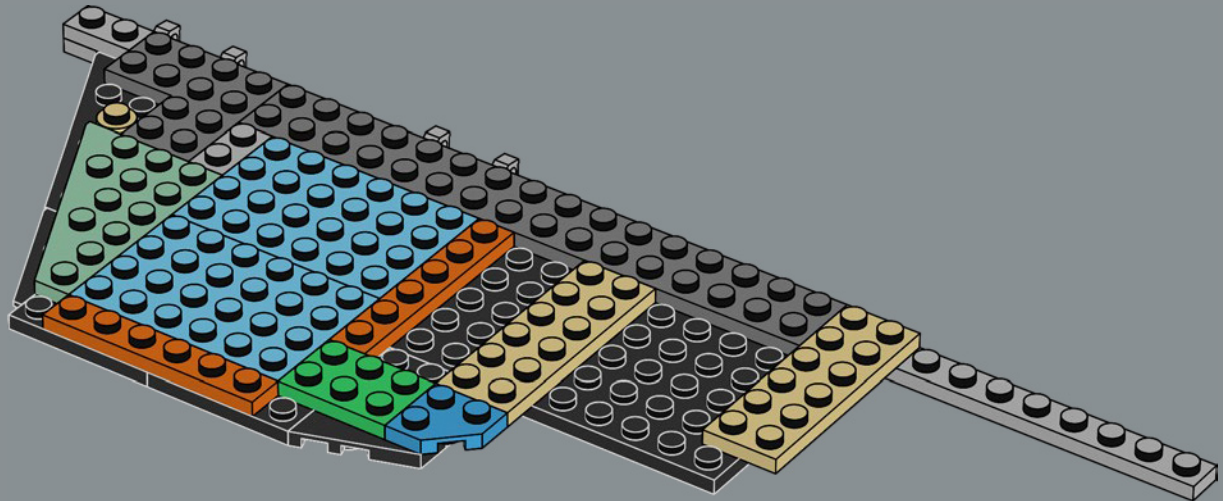

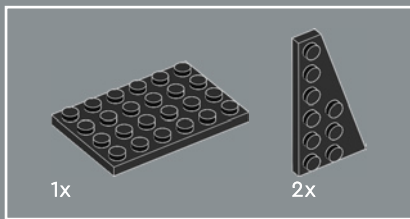

371

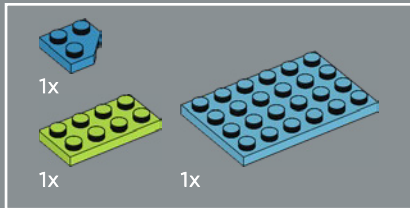
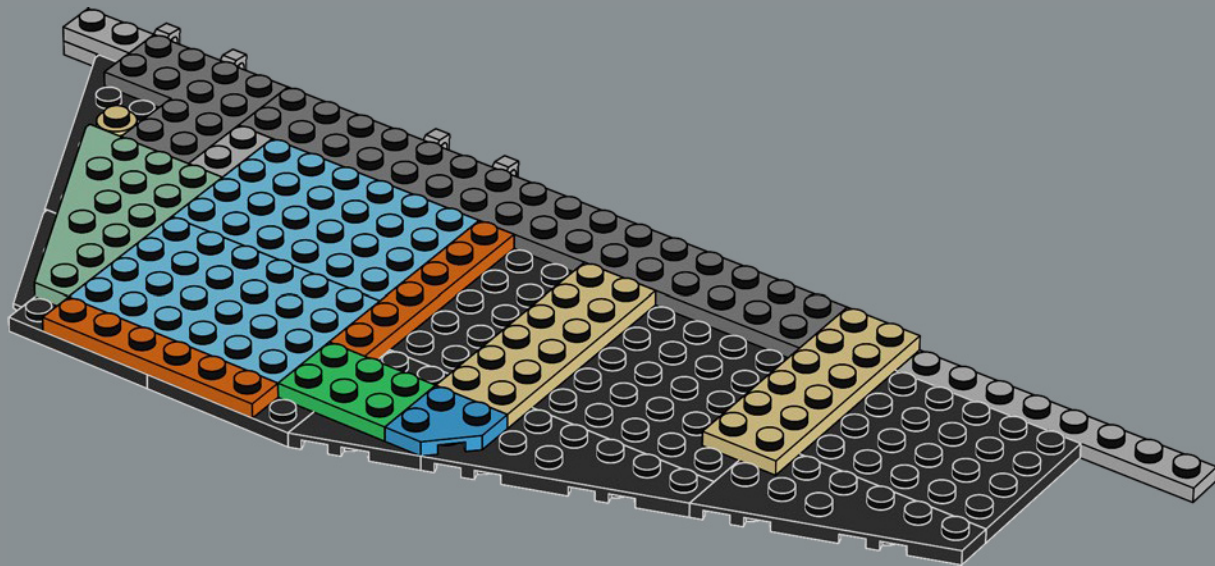

372

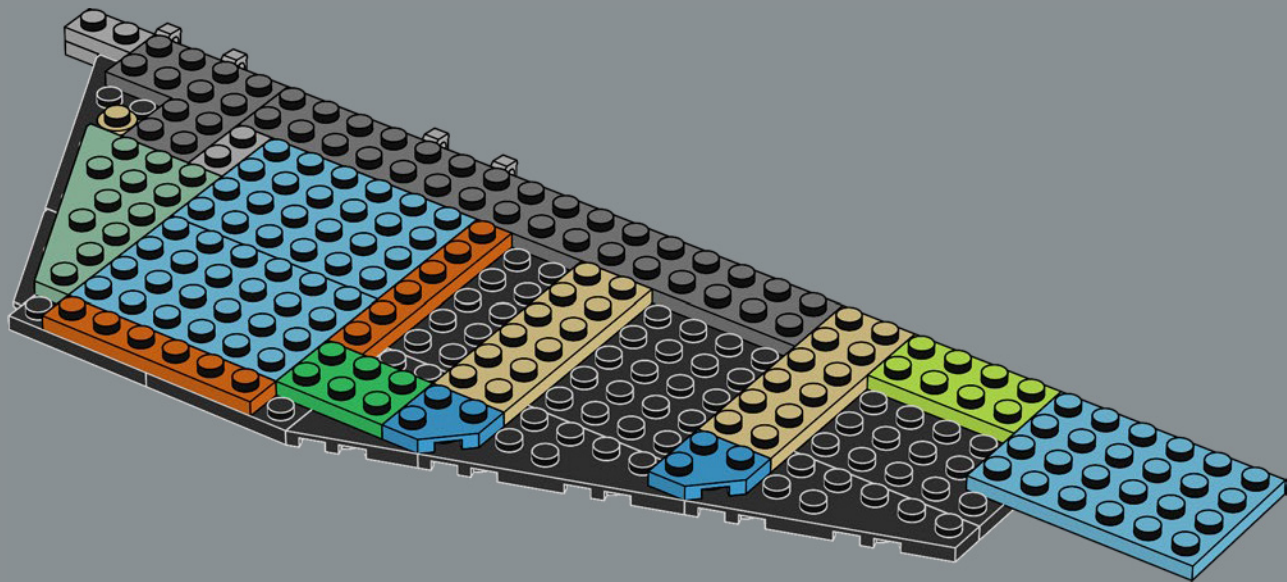

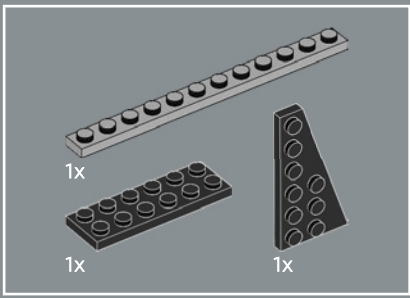

373

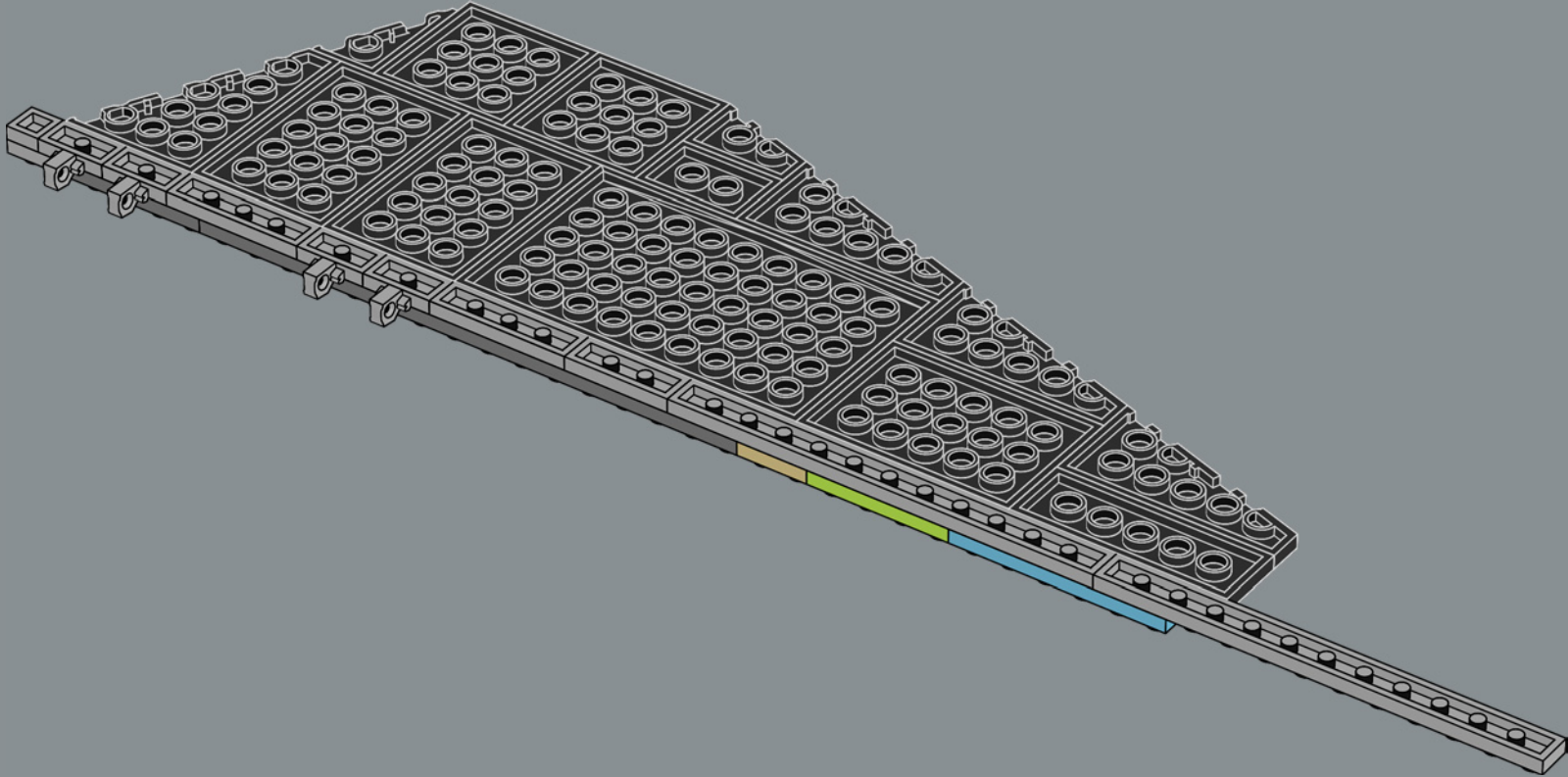



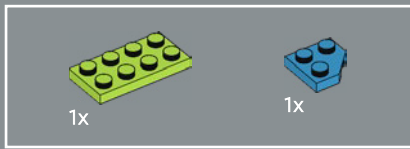

374

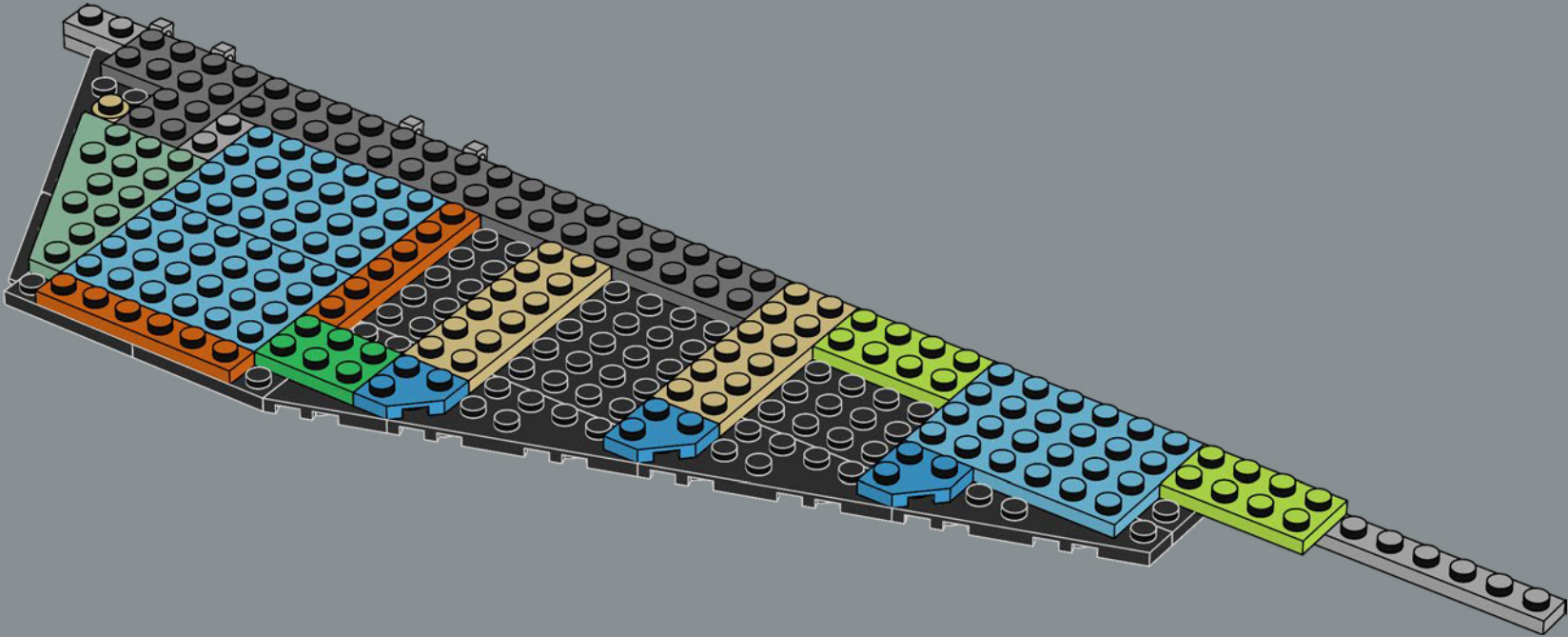



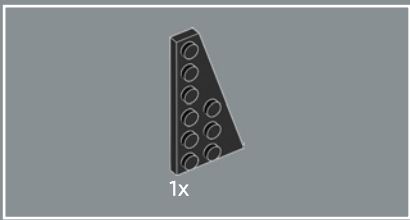

375

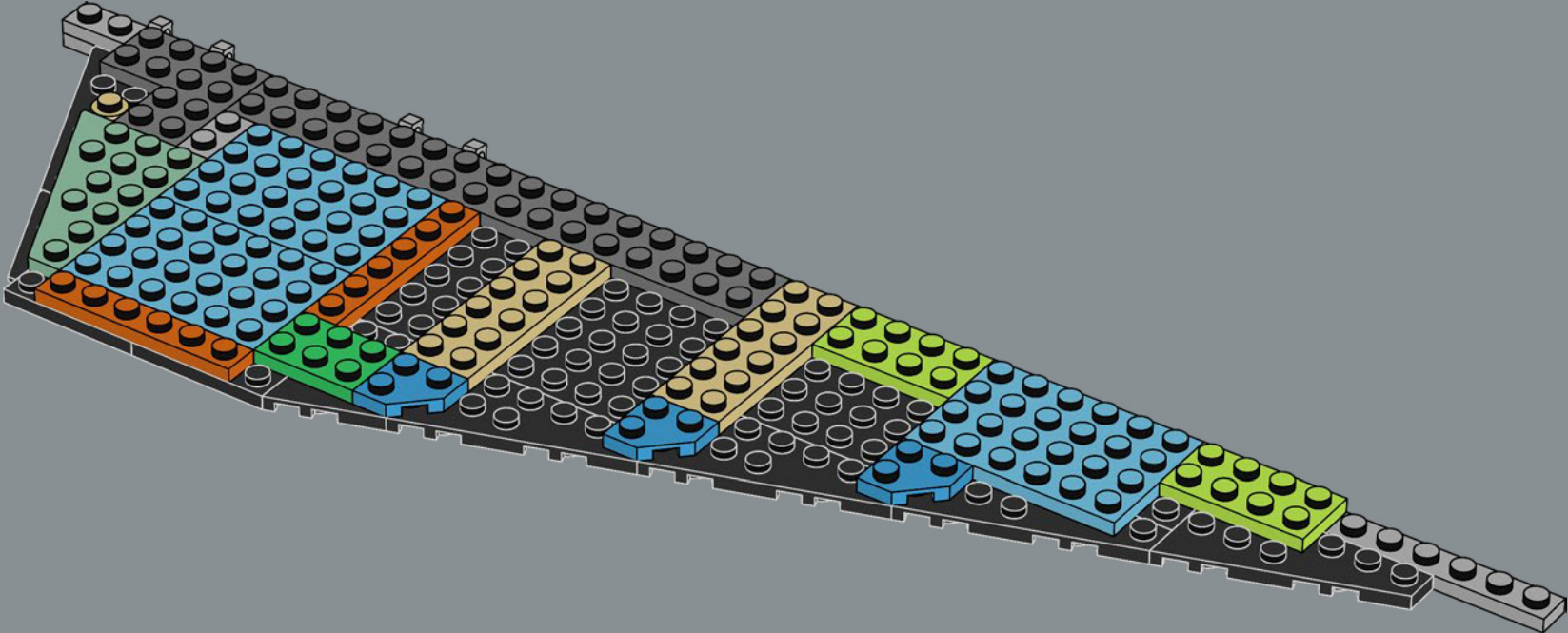

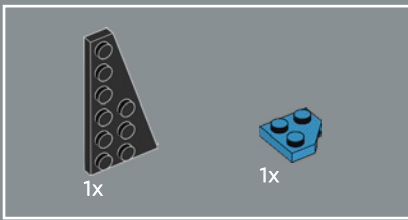

376

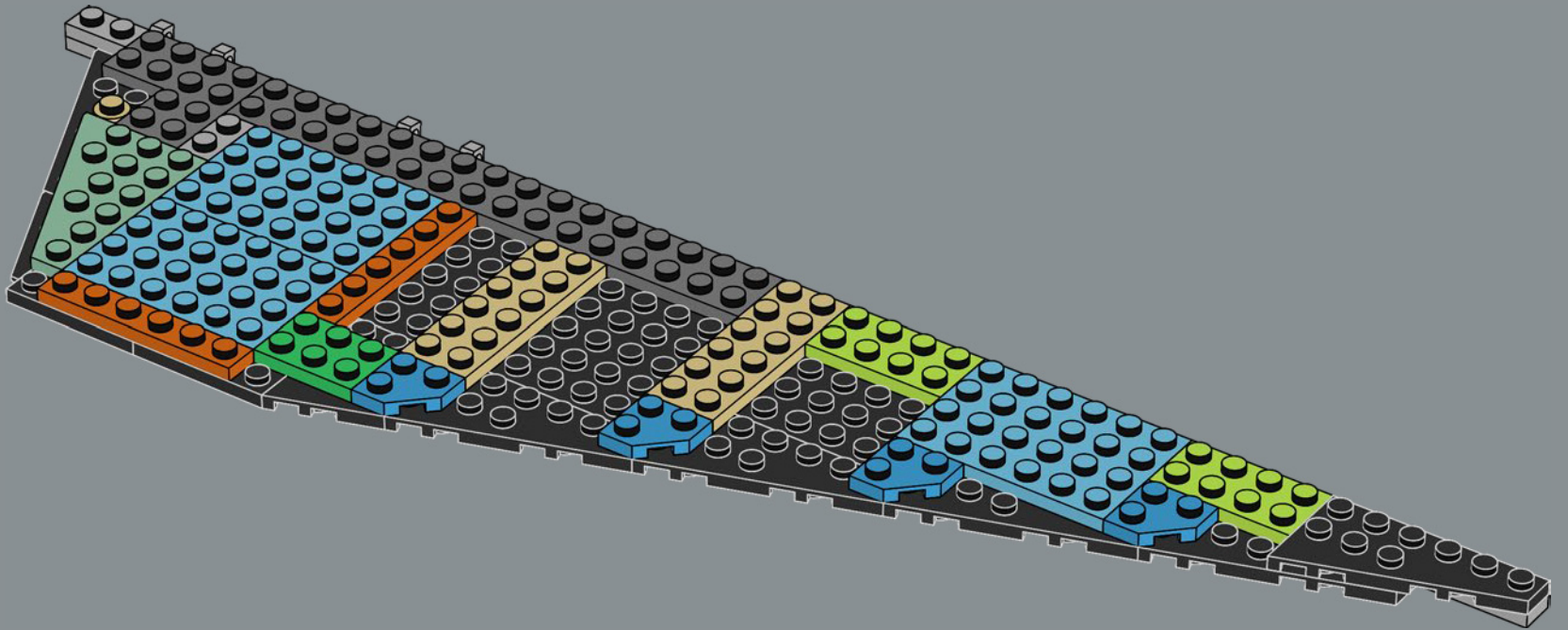

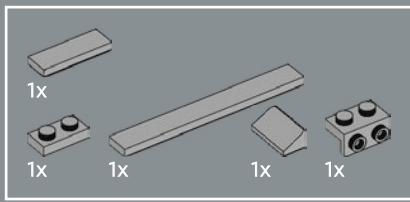

377

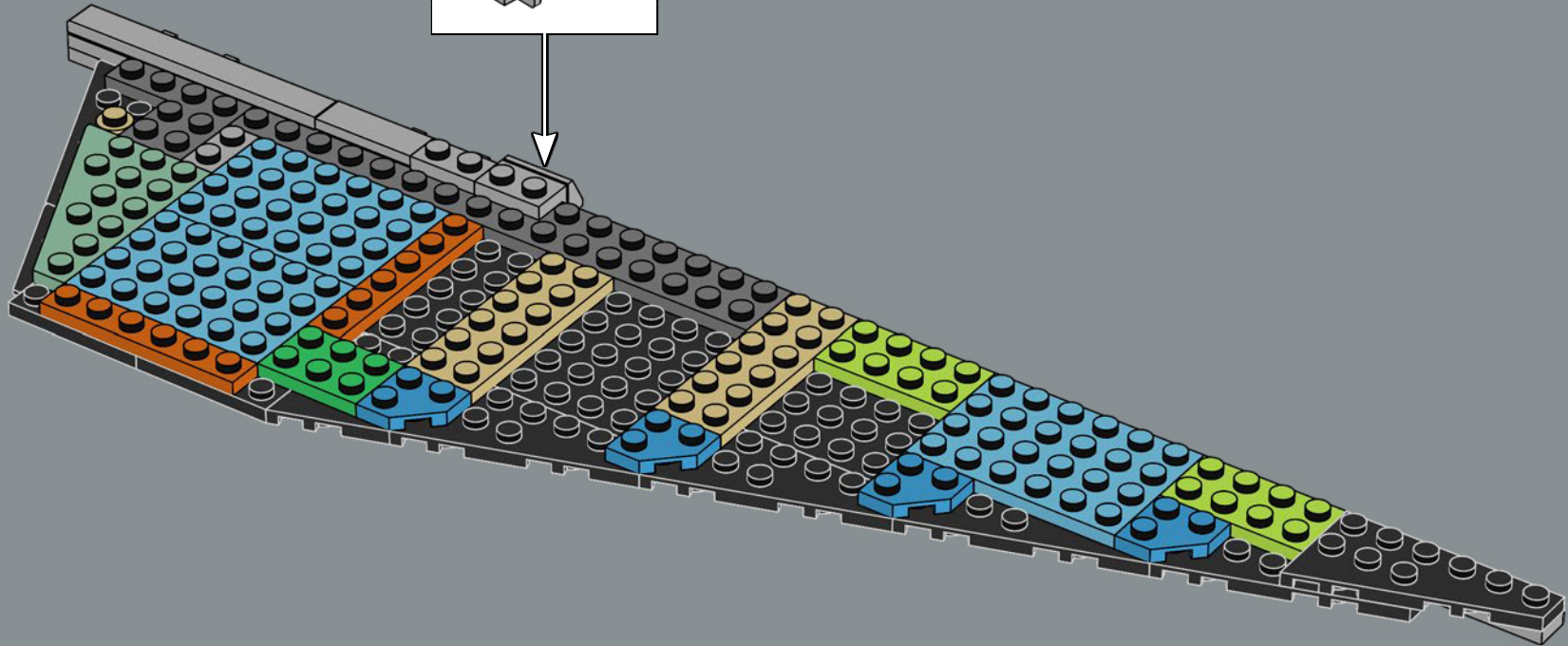
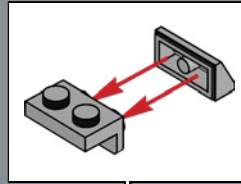

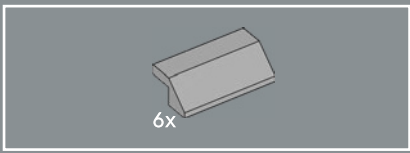

378

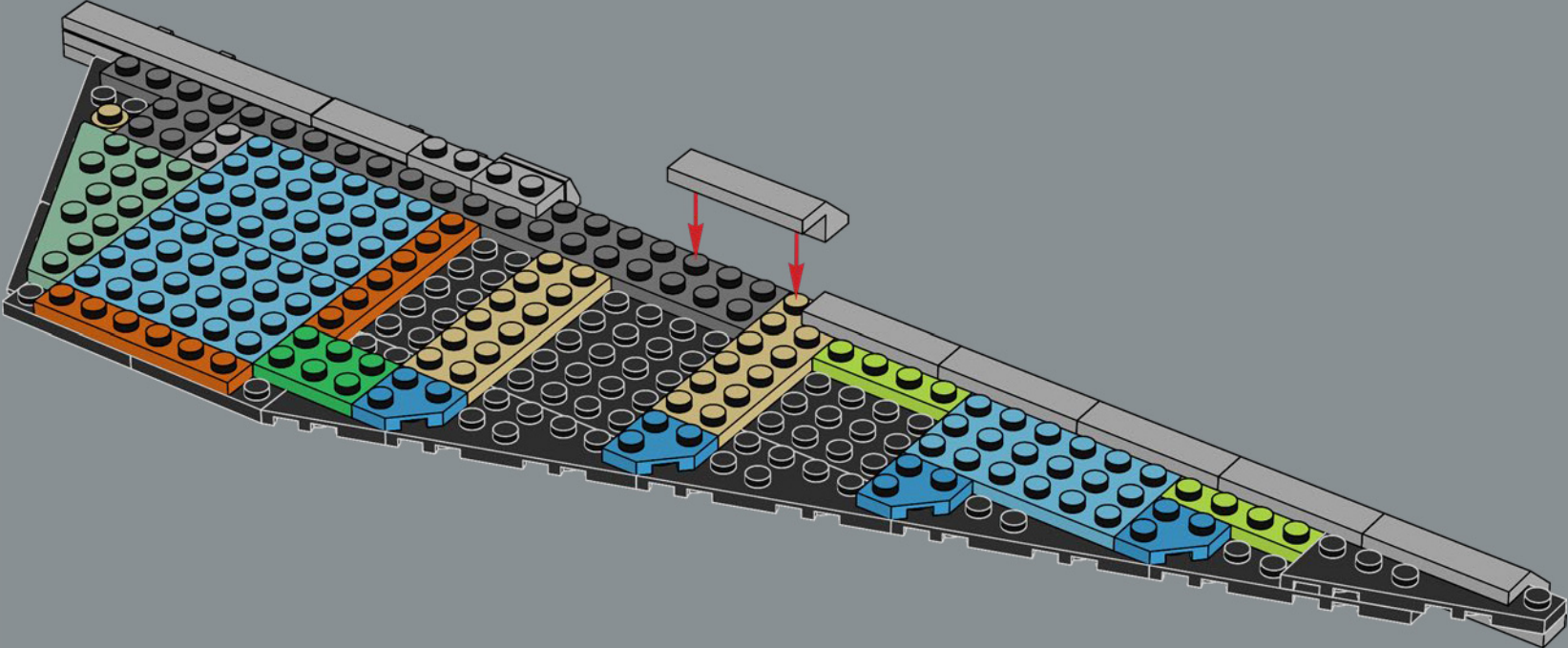



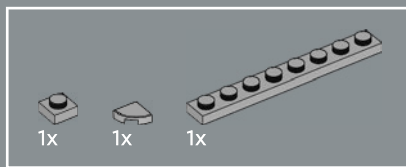

379

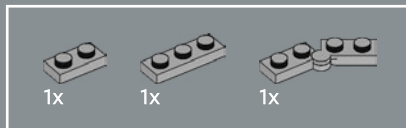
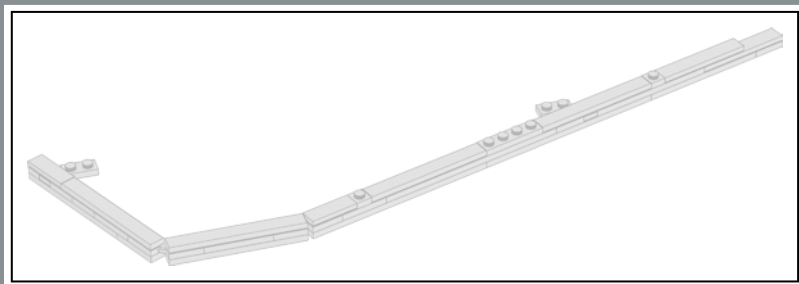
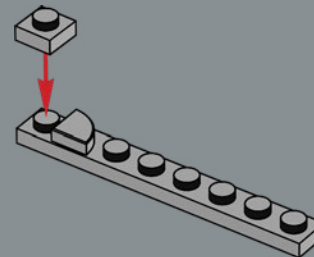

380

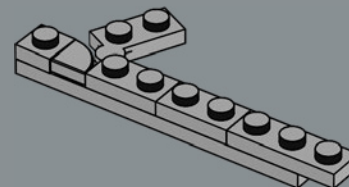

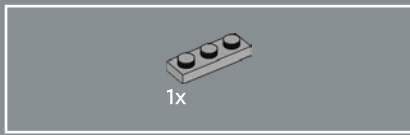

381

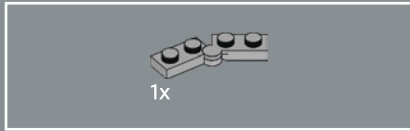
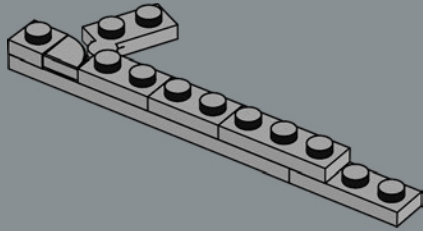

382

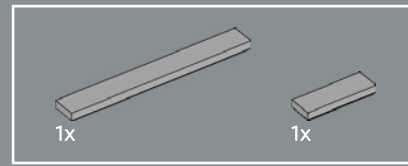
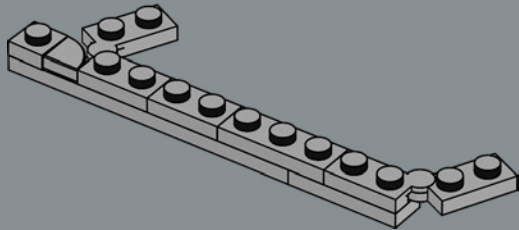

383

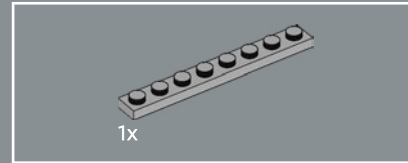
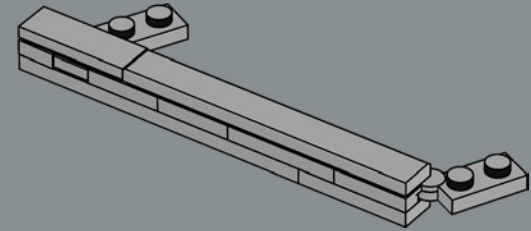

384

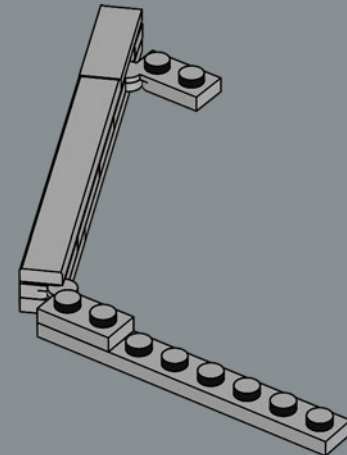

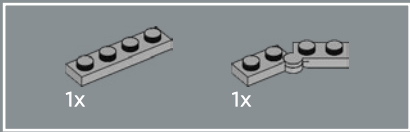

385

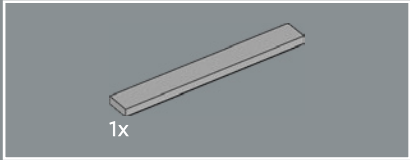
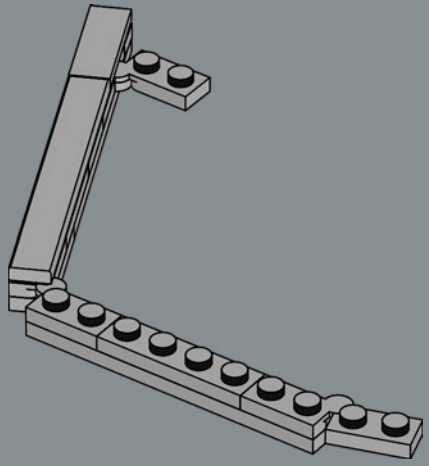

386

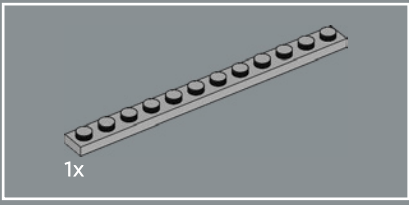
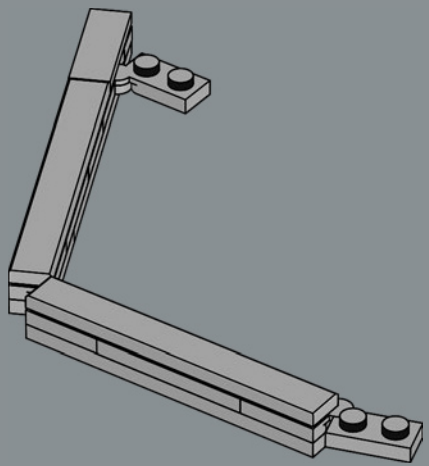

387

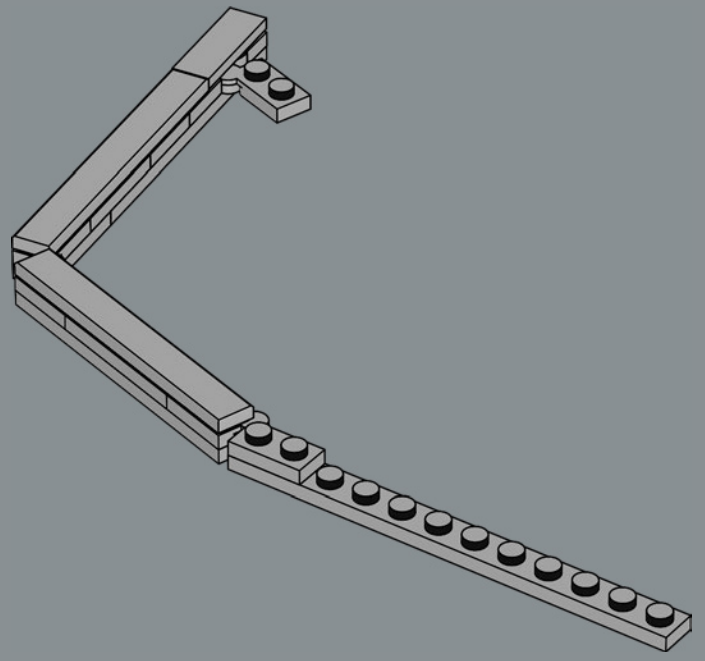

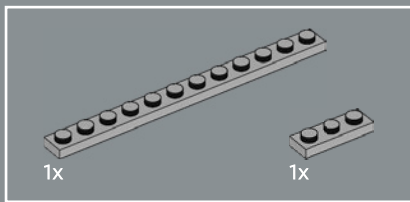

388

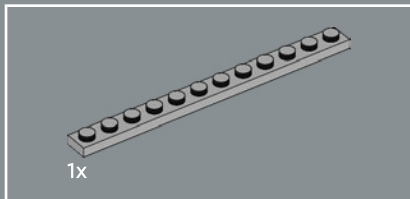
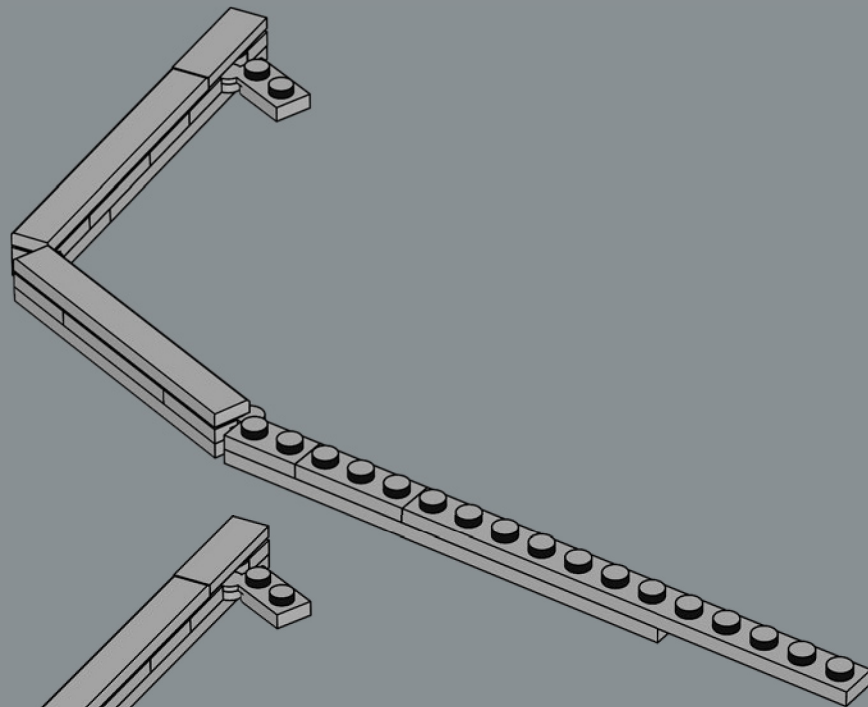

389

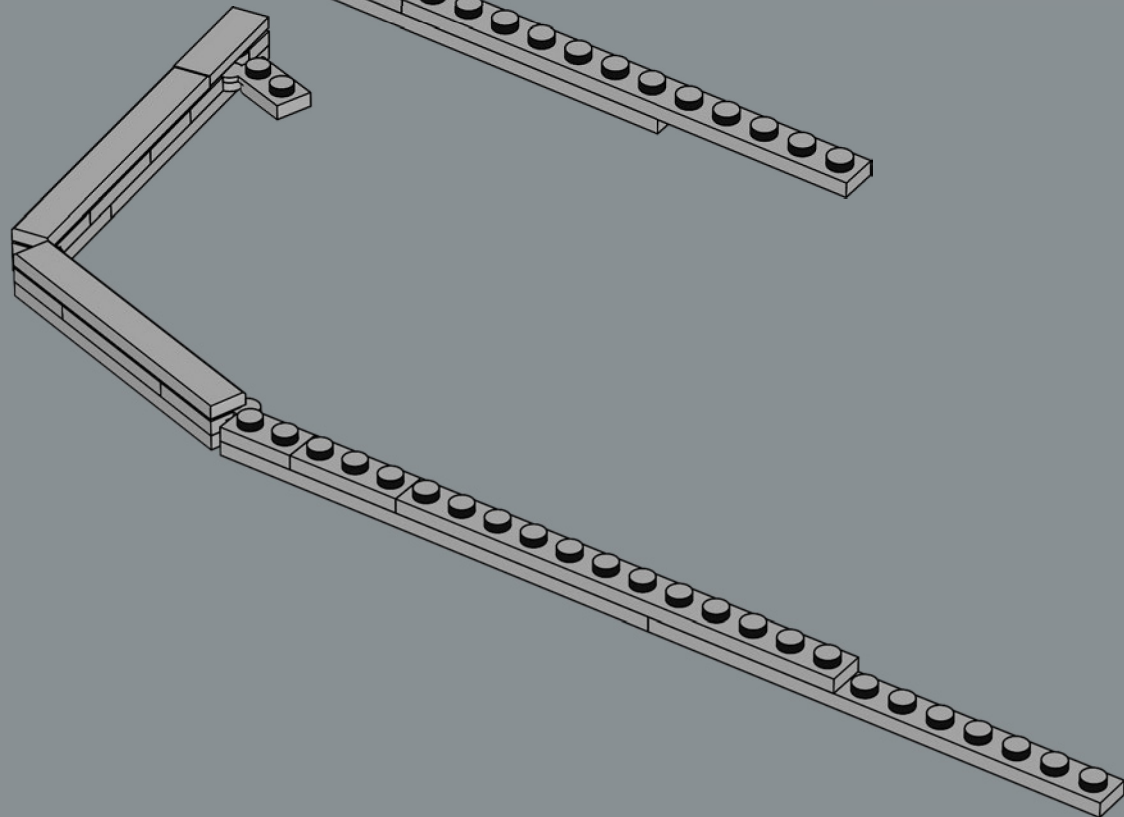



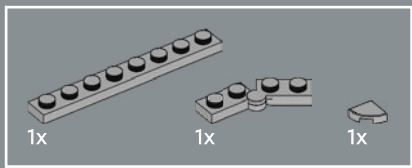

390

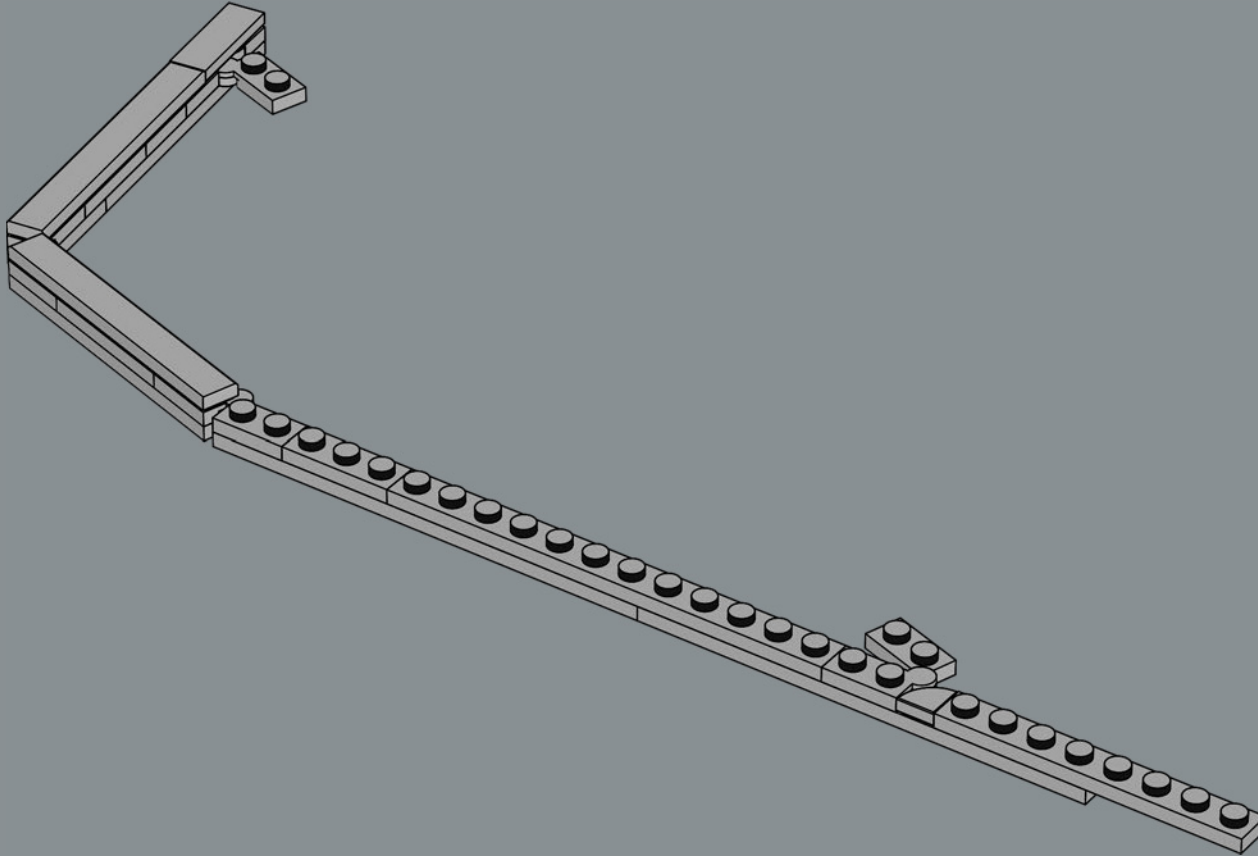

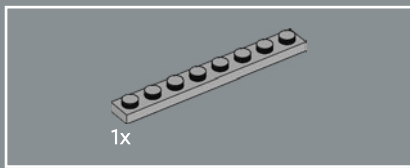

391

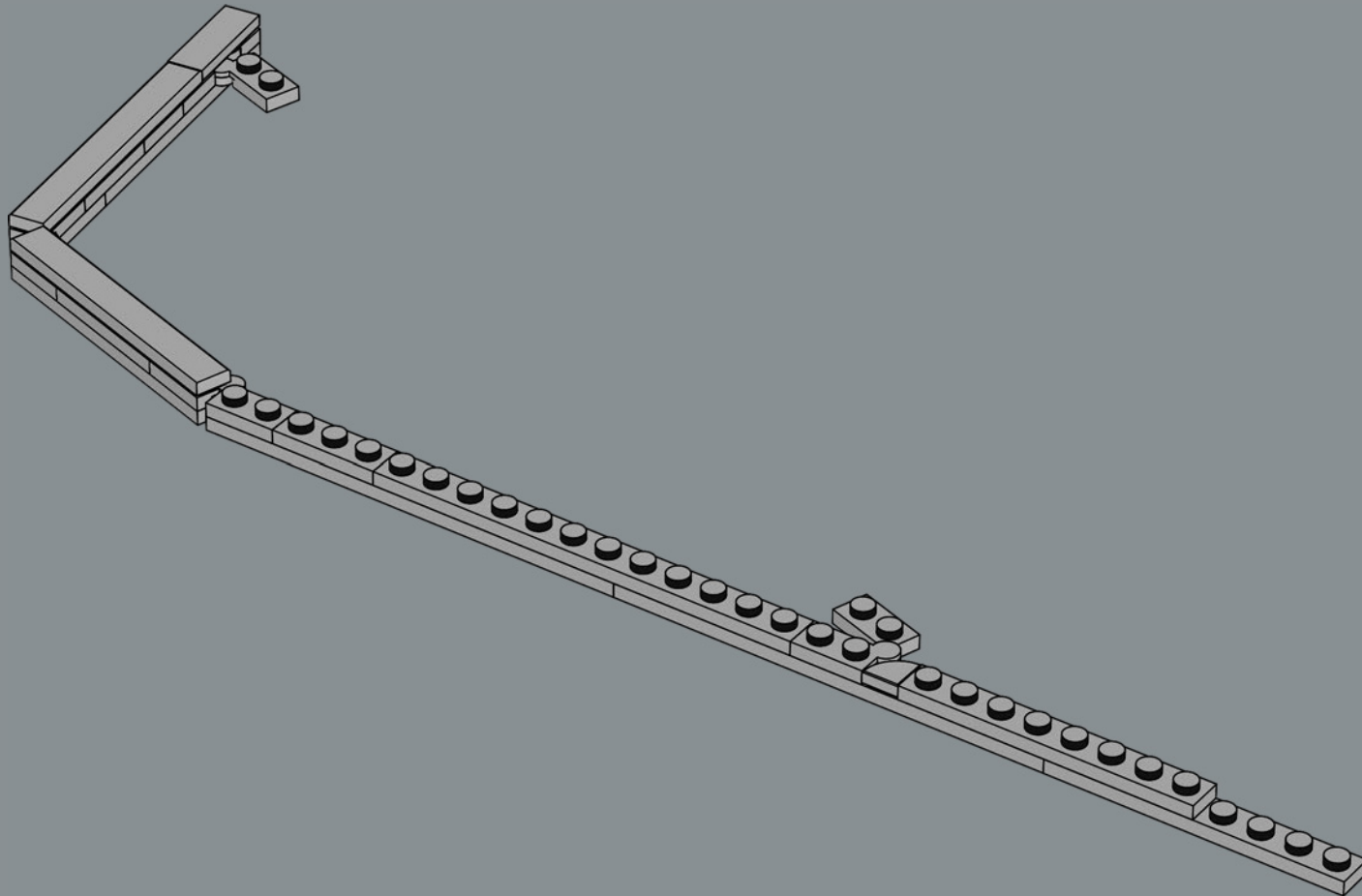

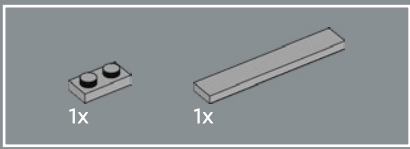

392

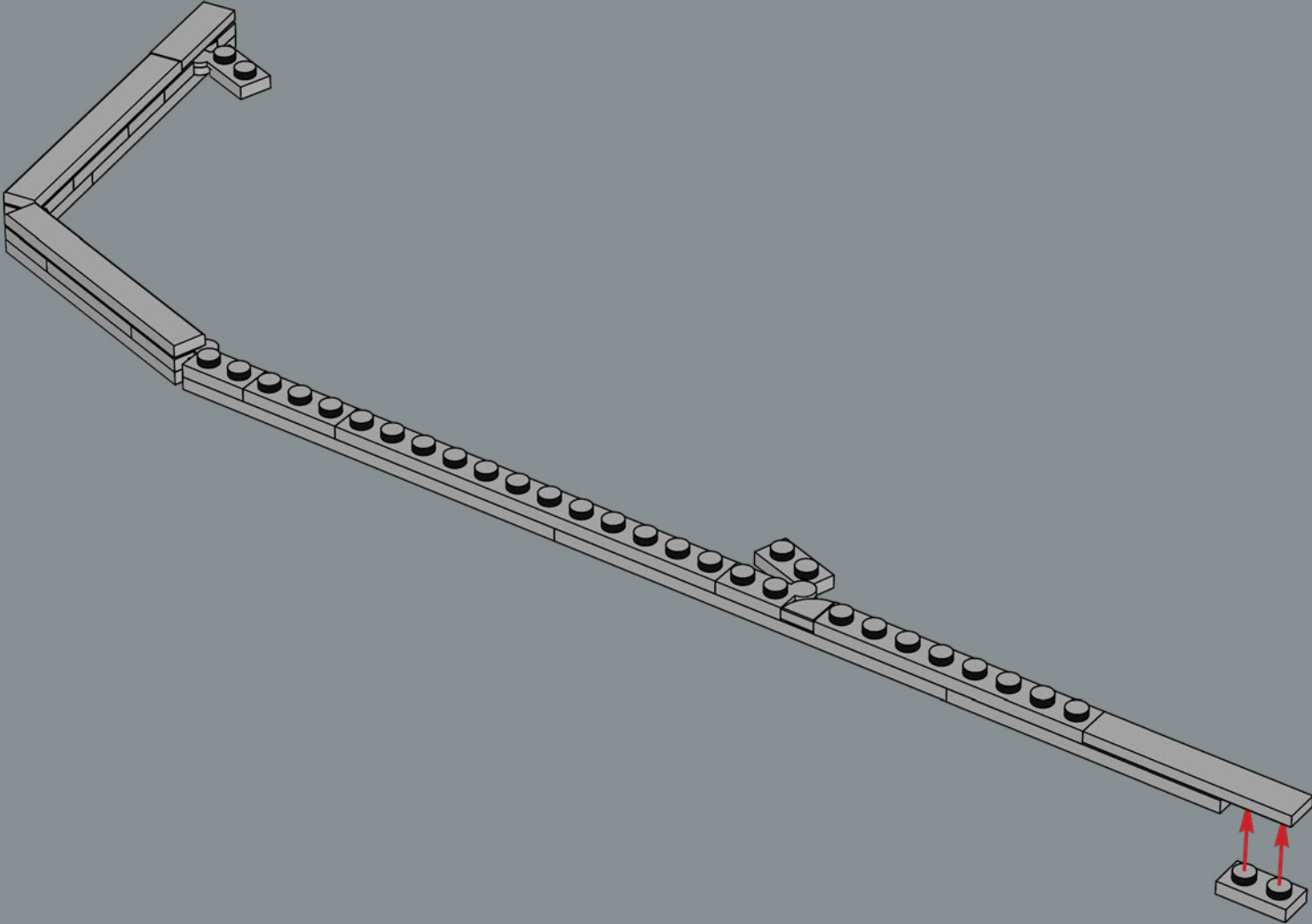

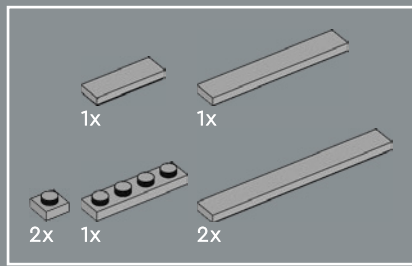

393

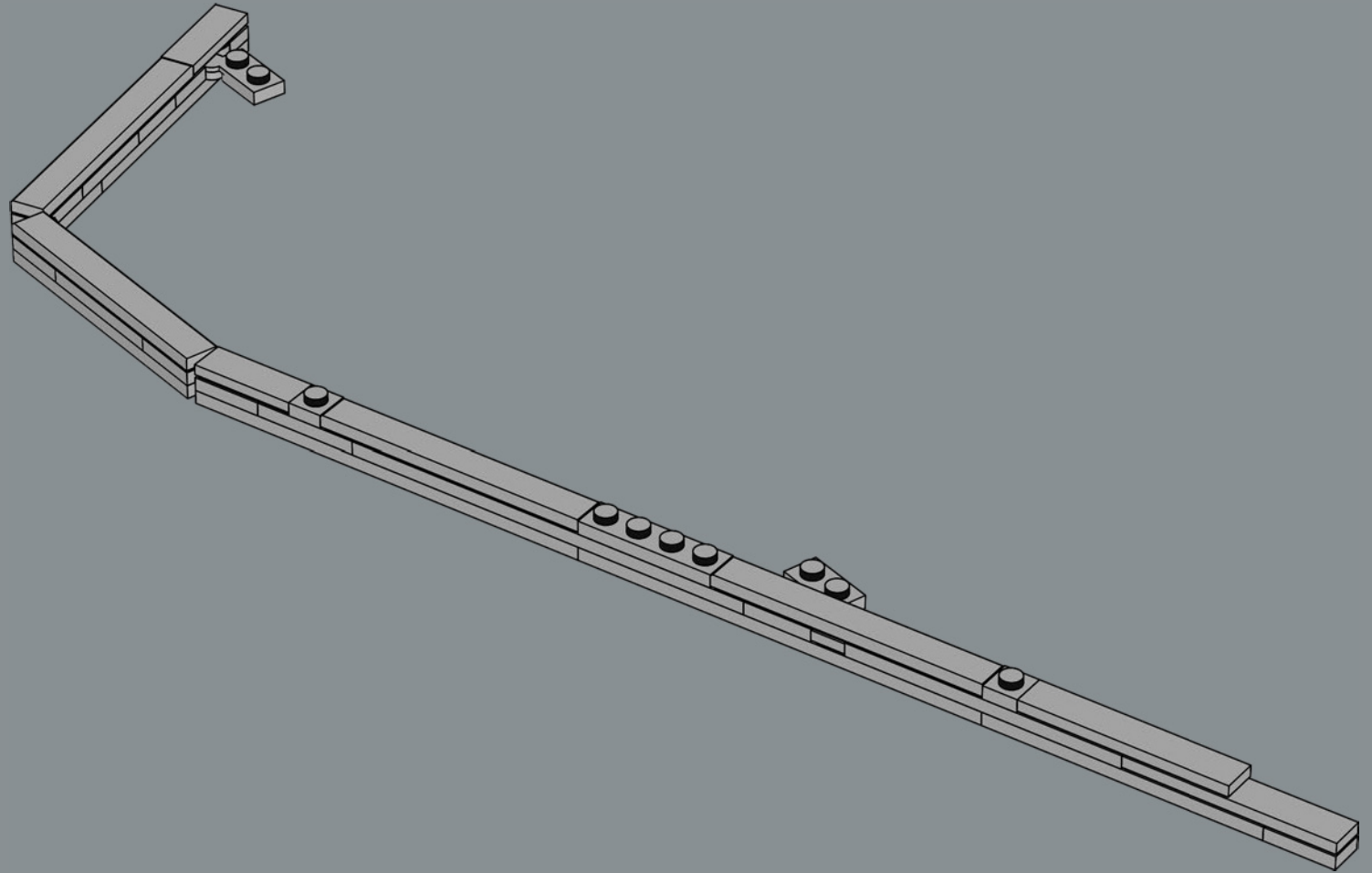



394

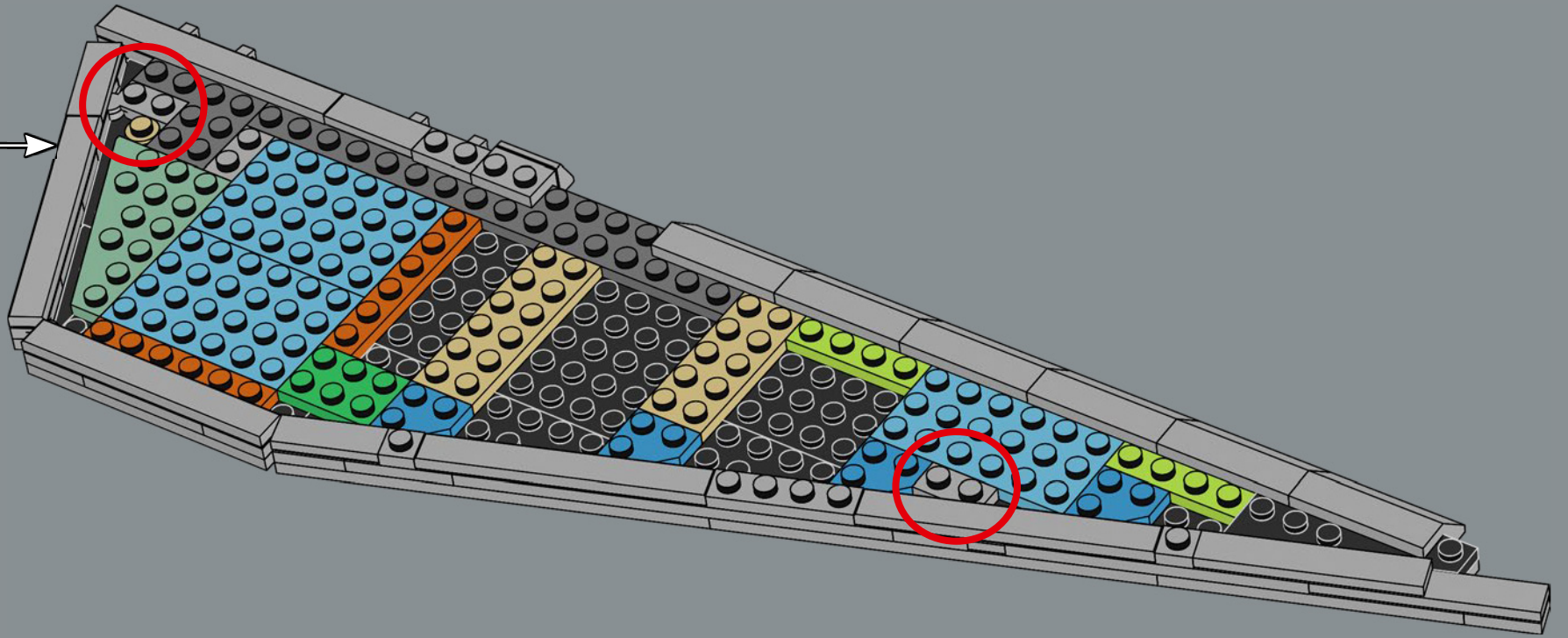

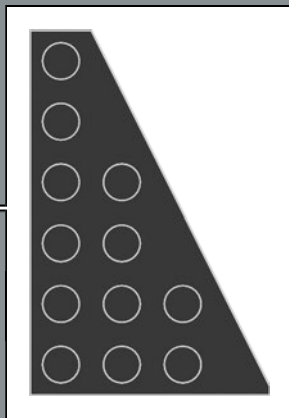
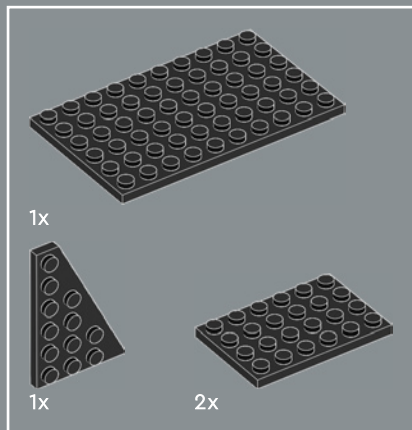

395

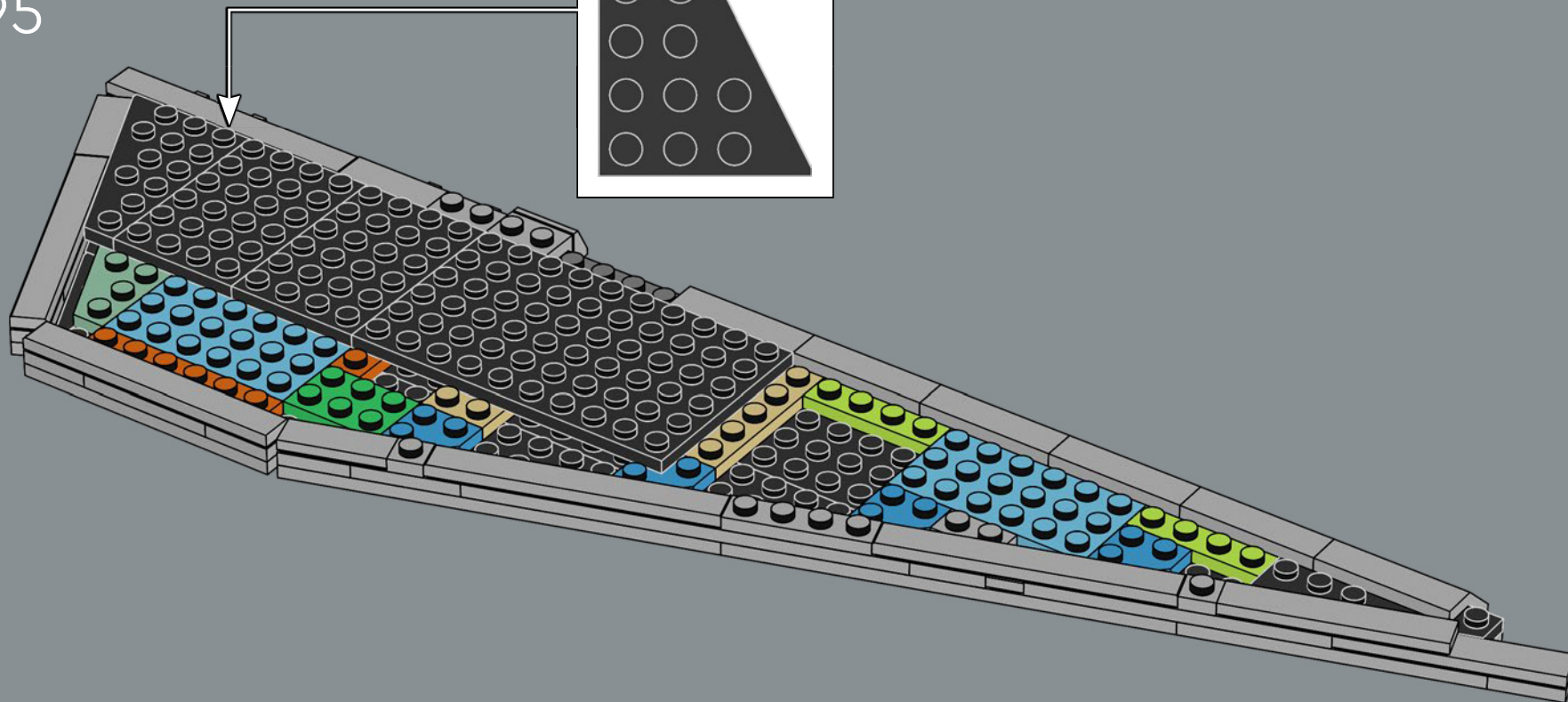

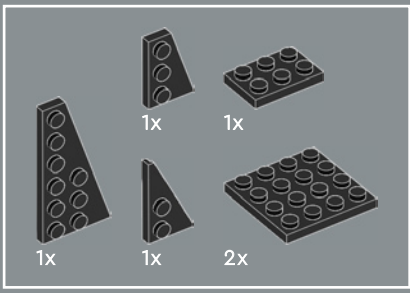

396

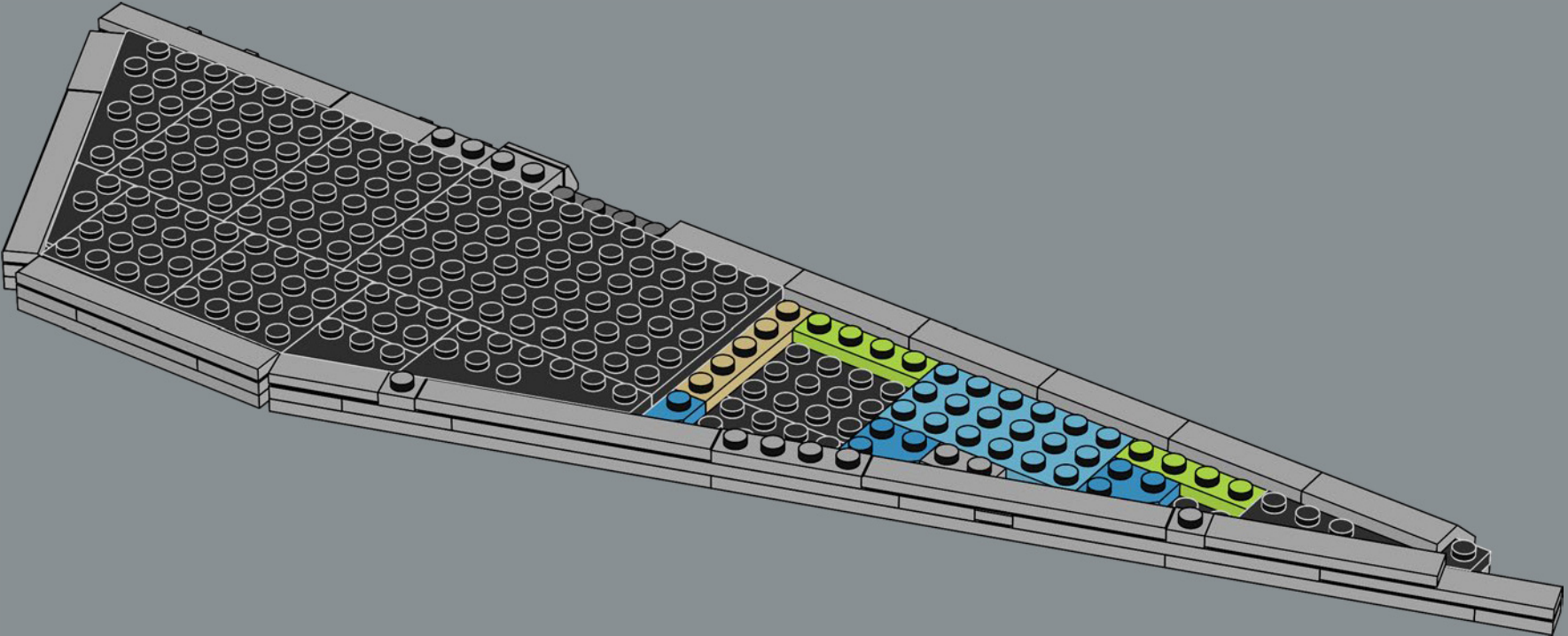

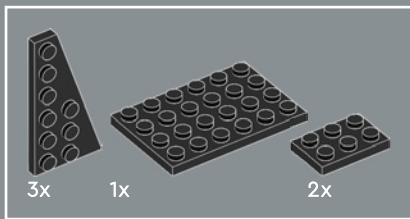

397

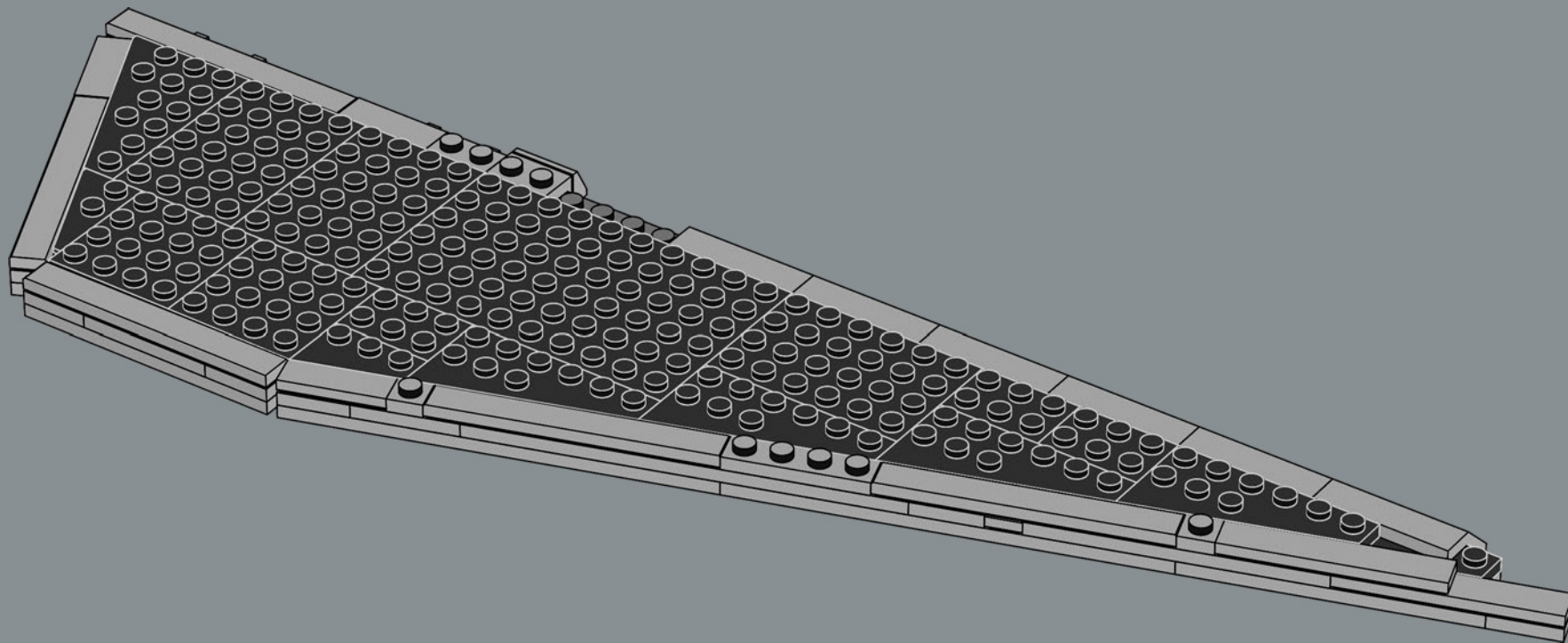



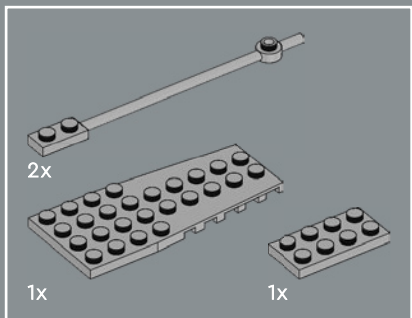

398

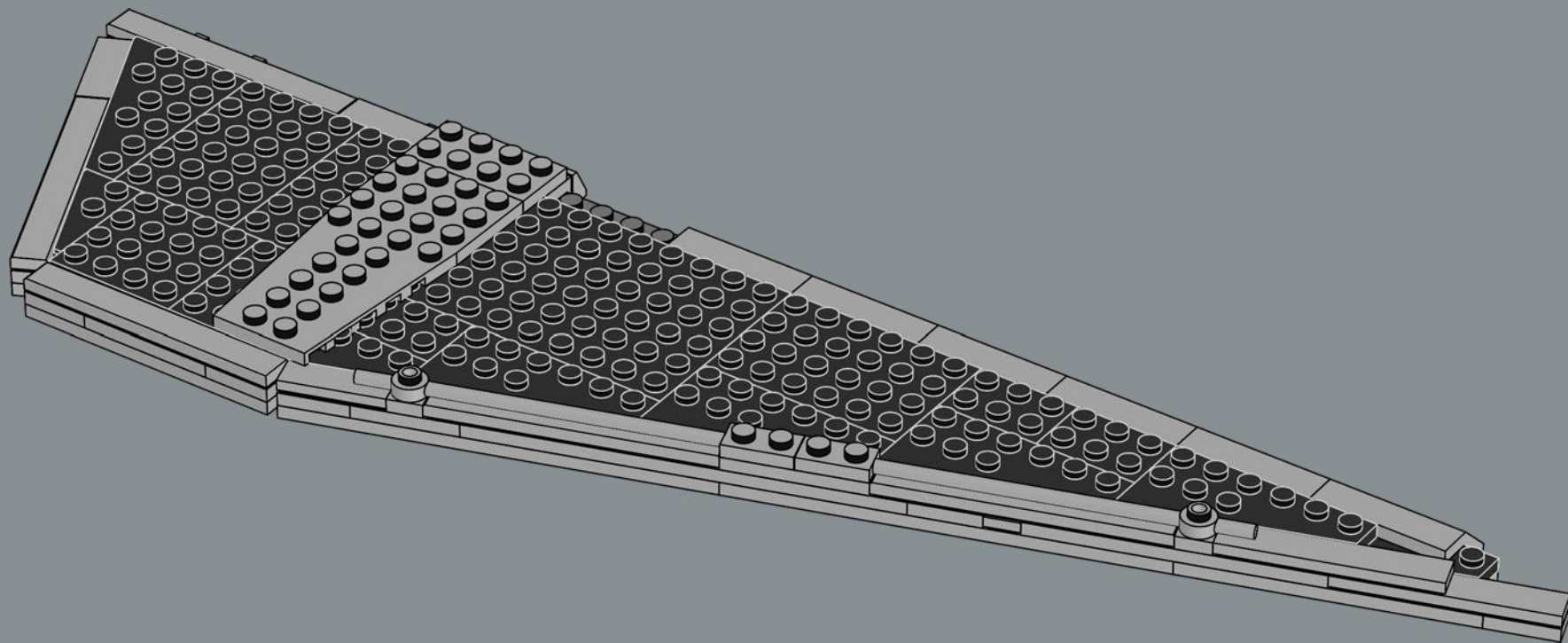

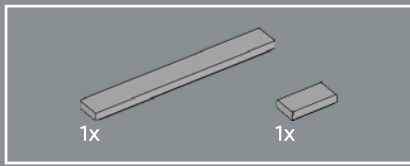

399

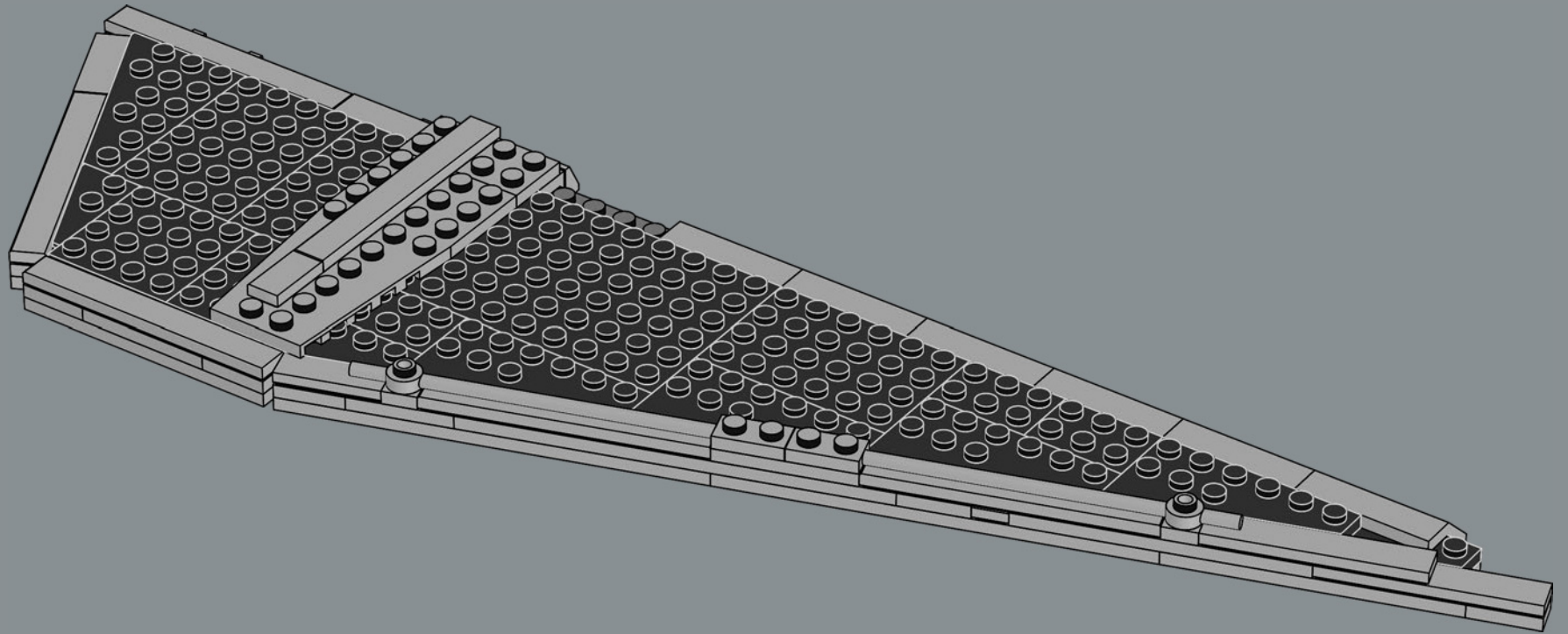

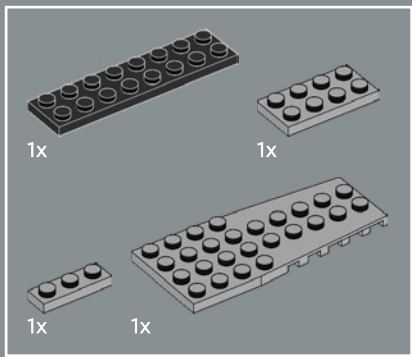

400

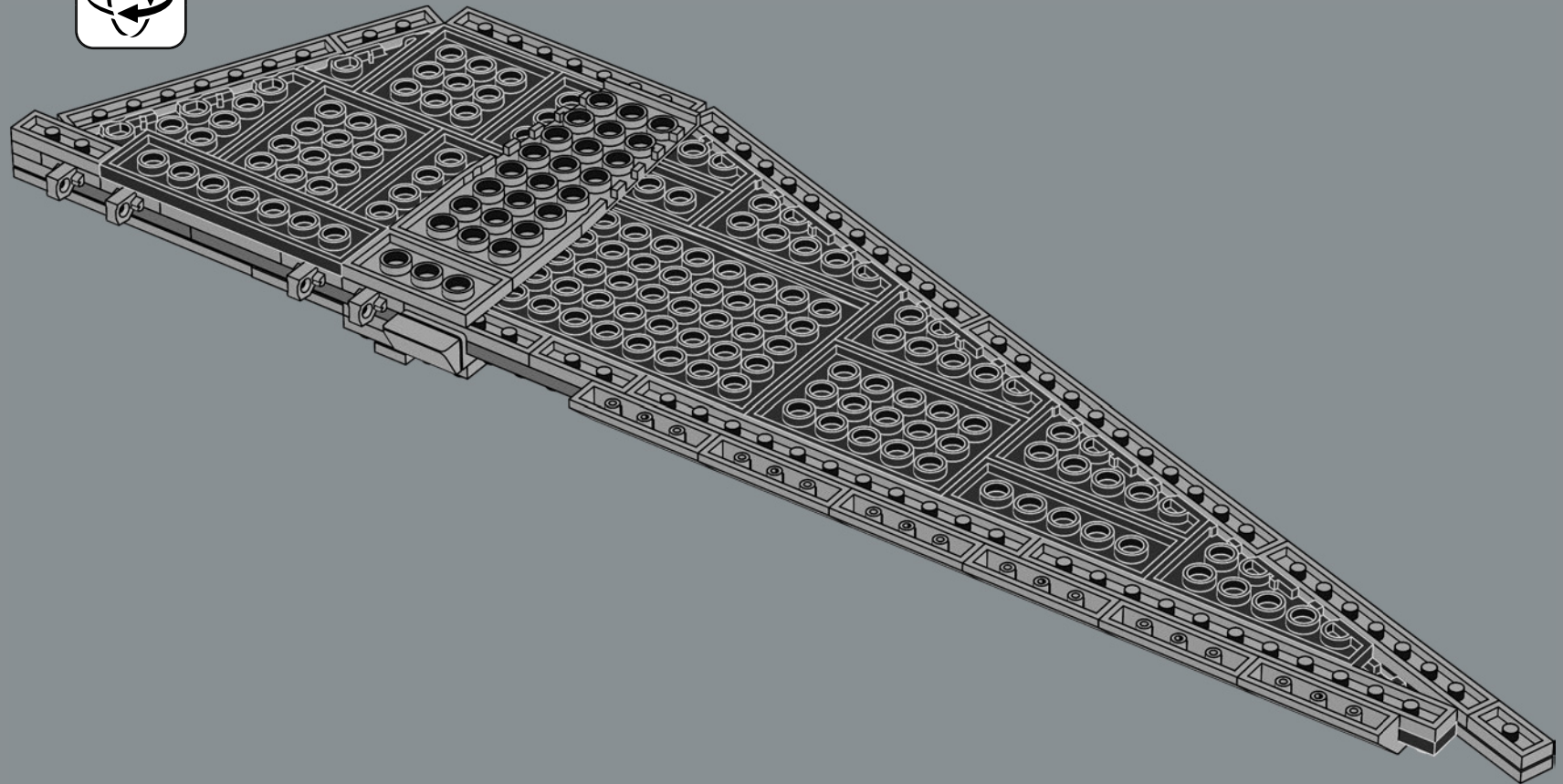

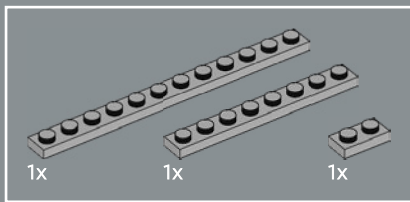

401

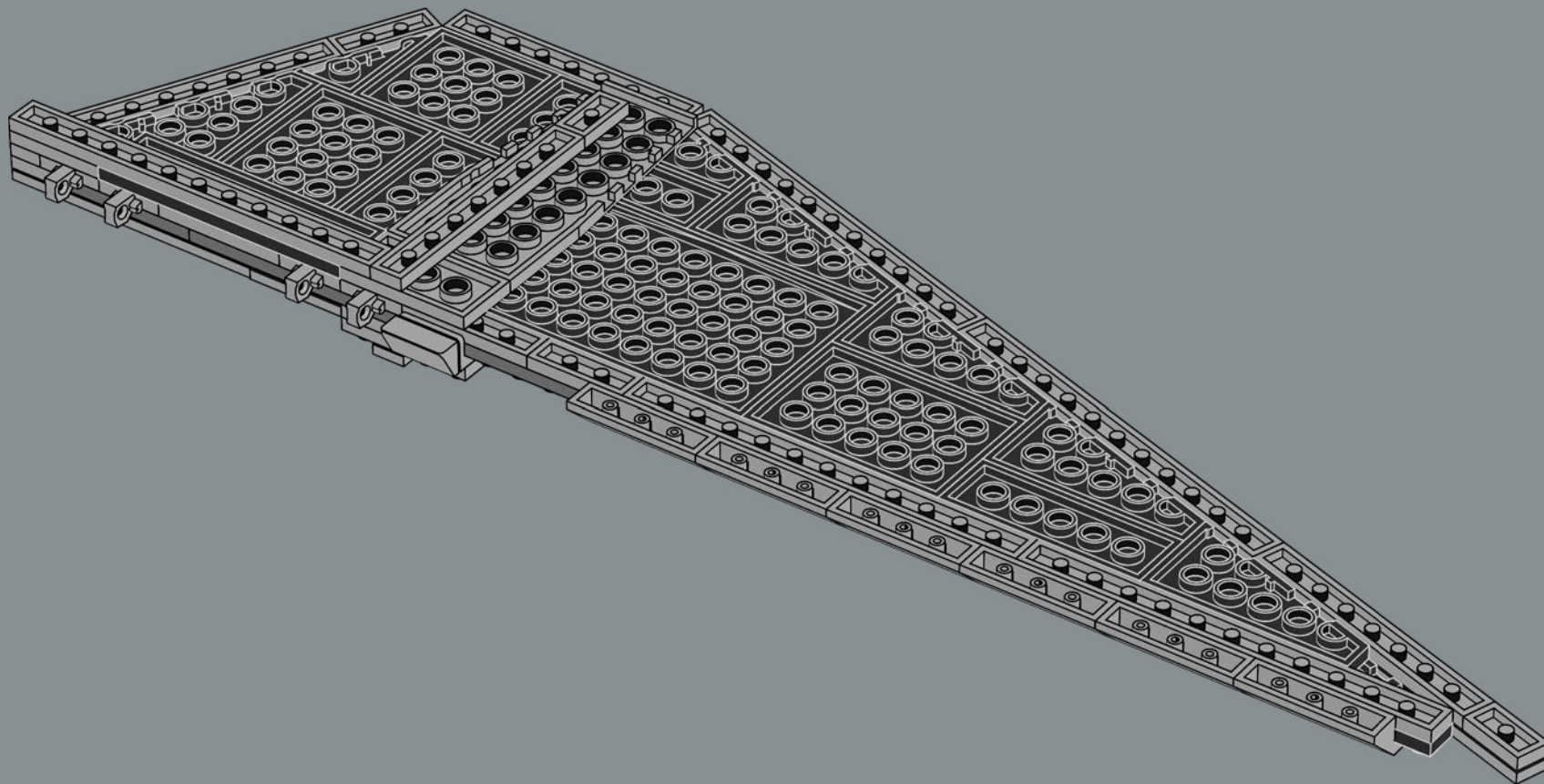



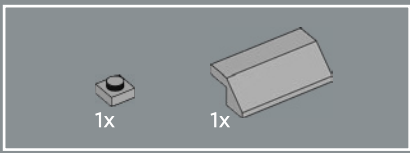

402

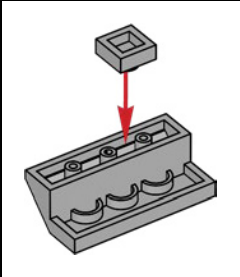
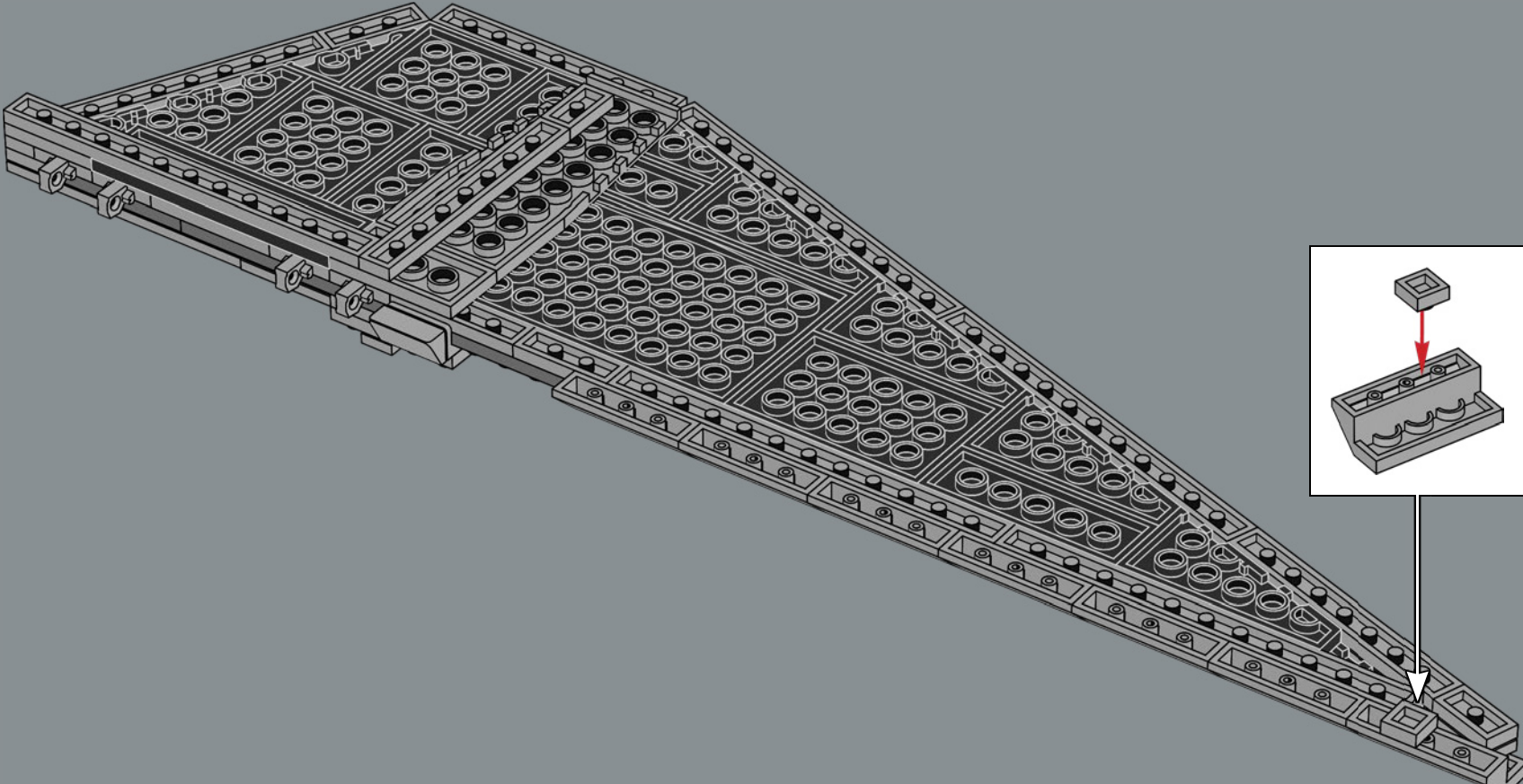

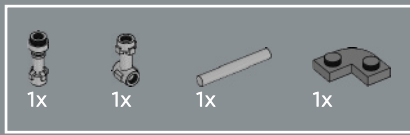

403

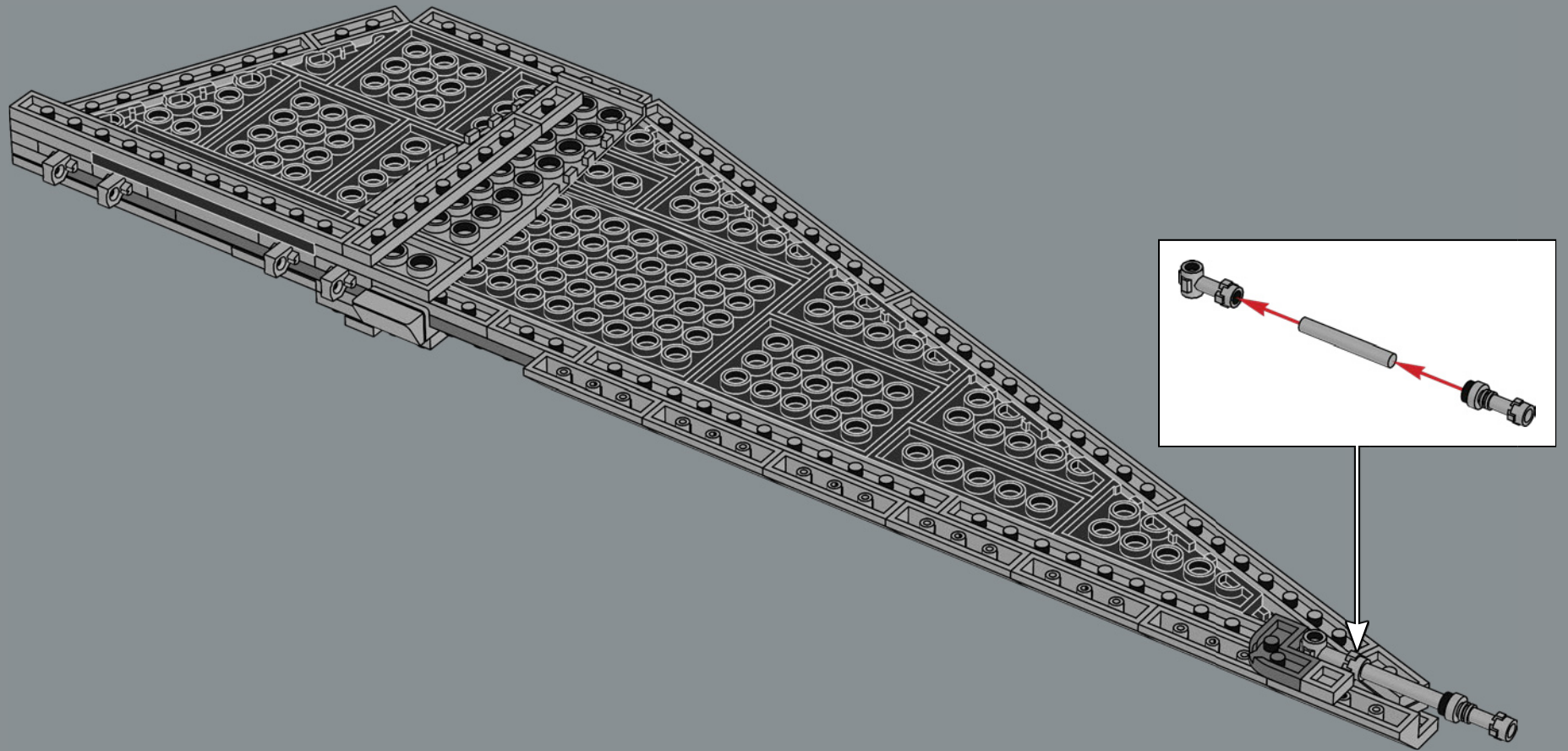



404

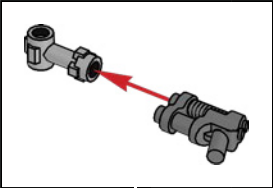
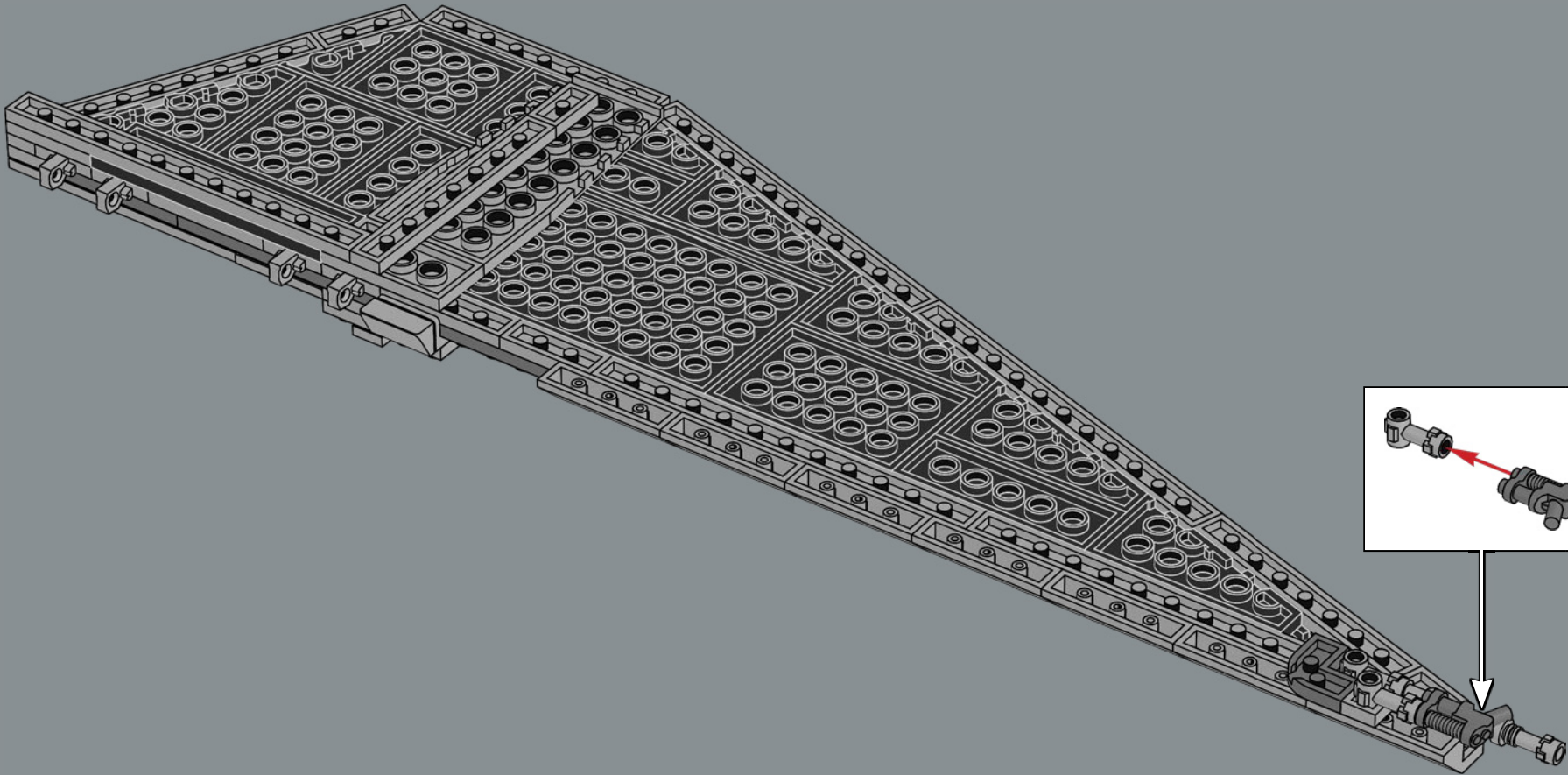



405

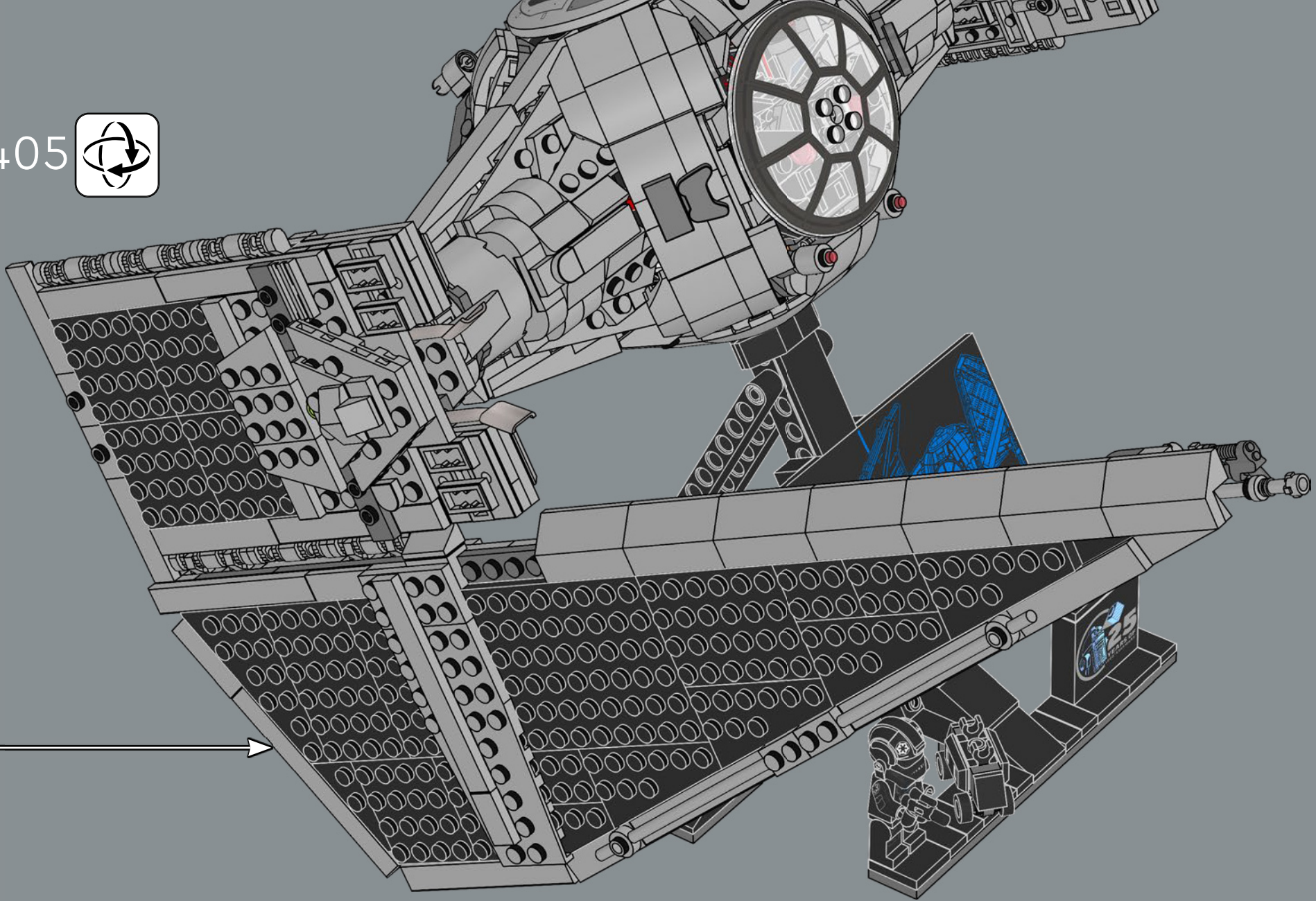



406

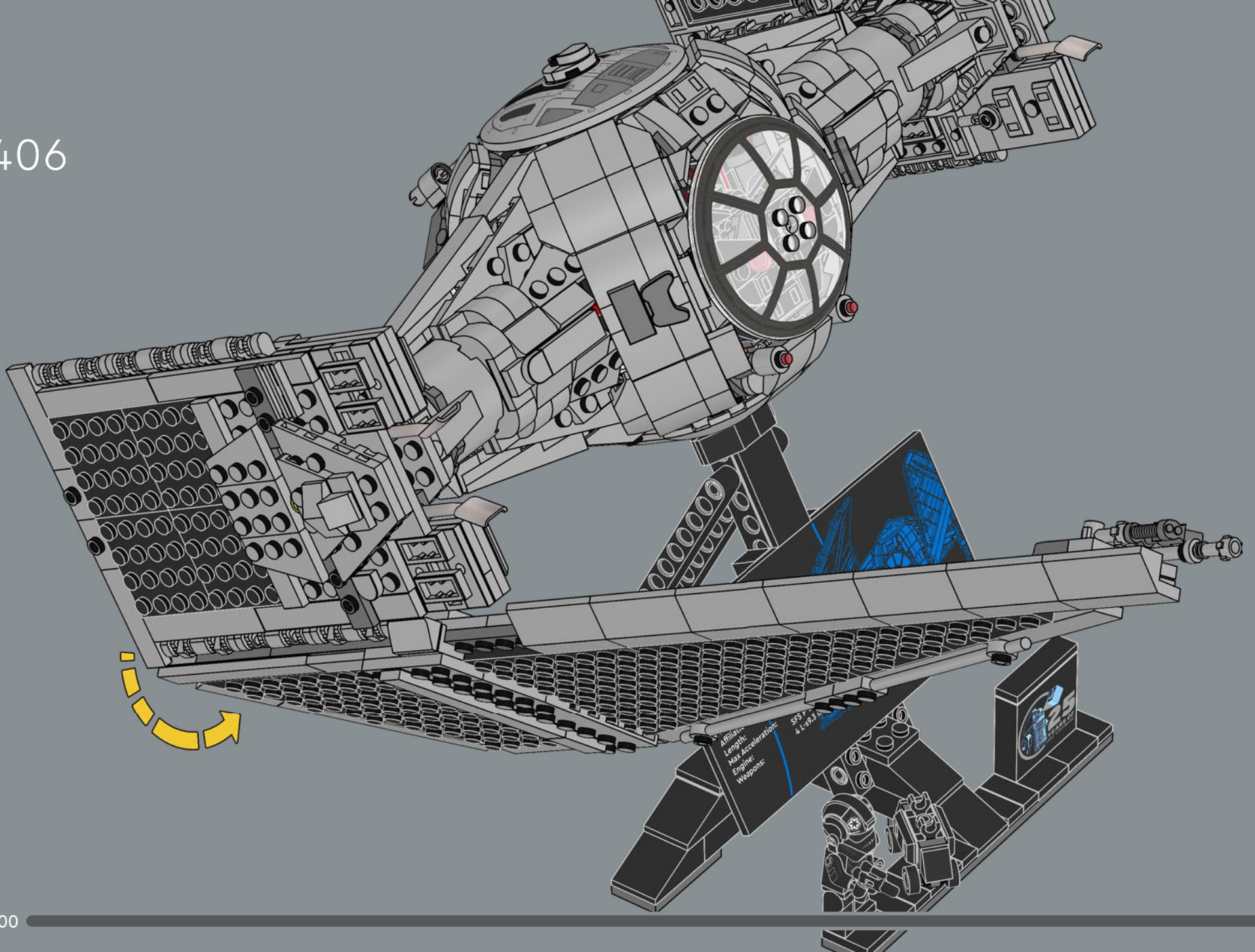



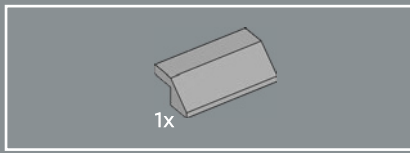

407

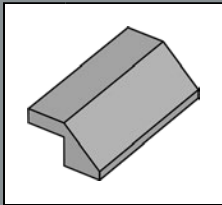
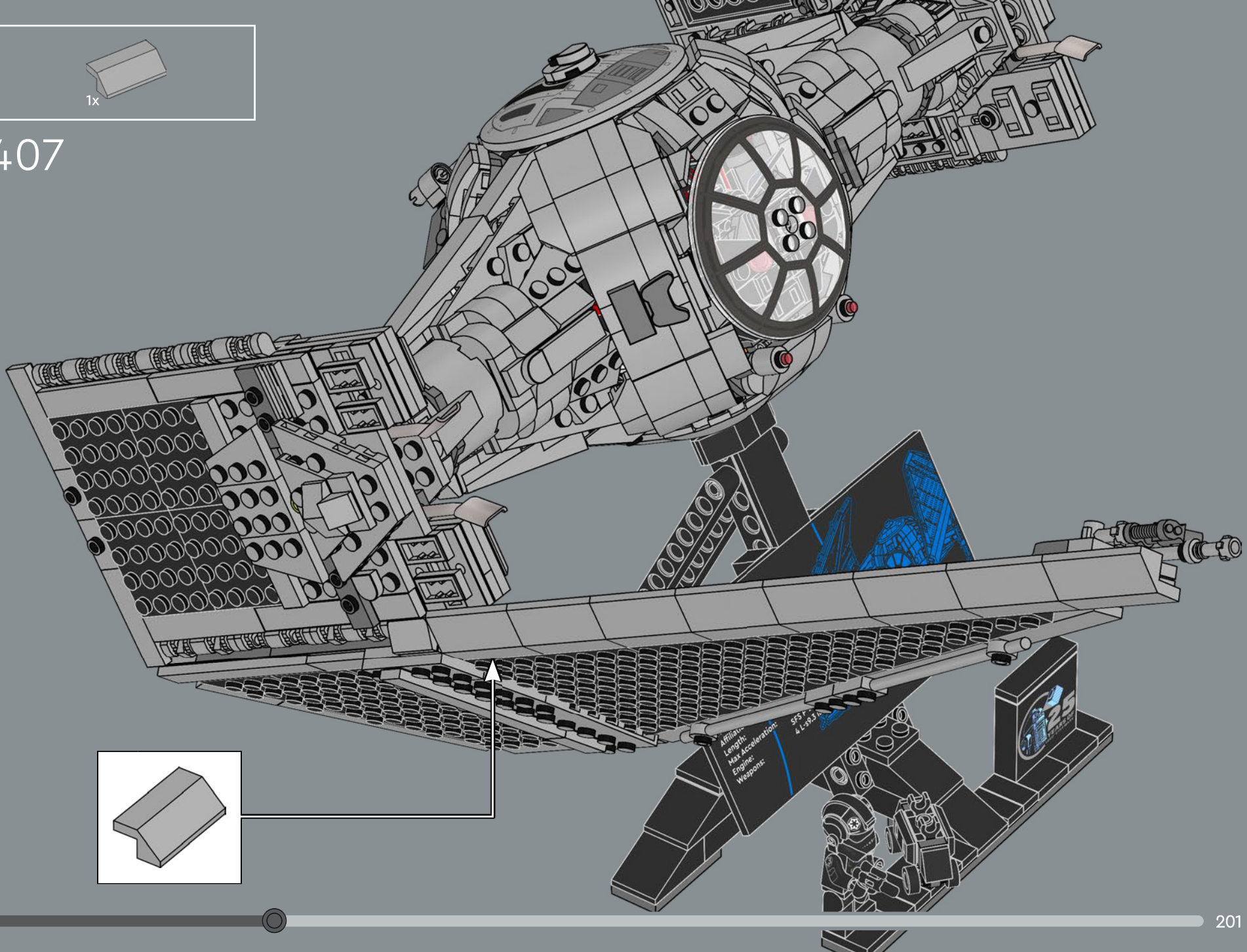

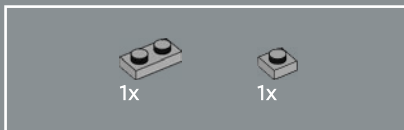
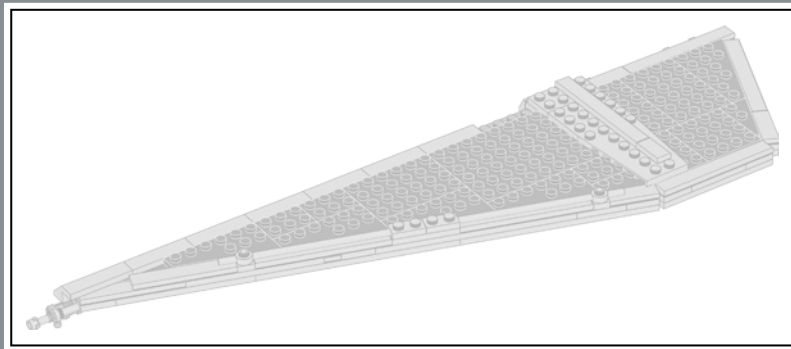

408

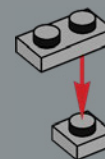

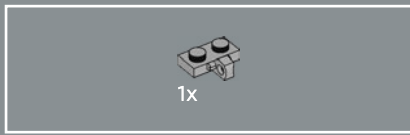

409

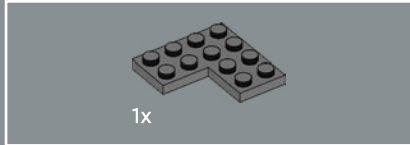
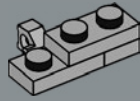

410

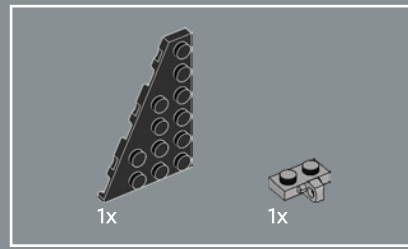
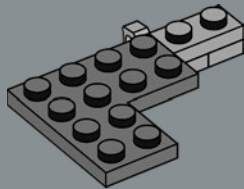

411

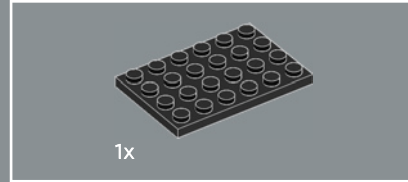
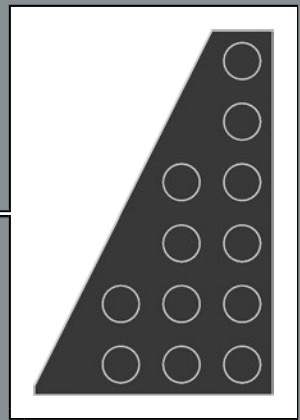
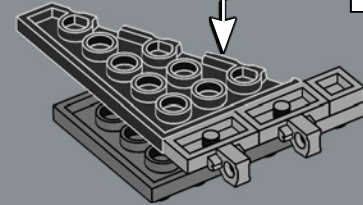

412

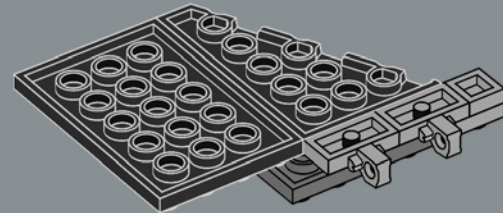



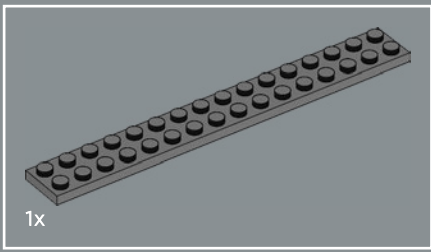

413

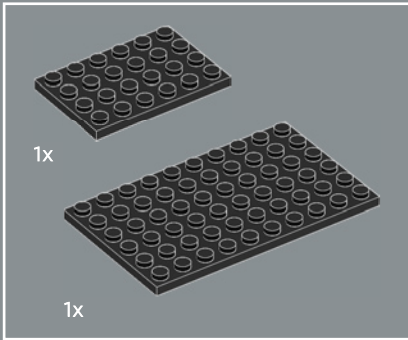
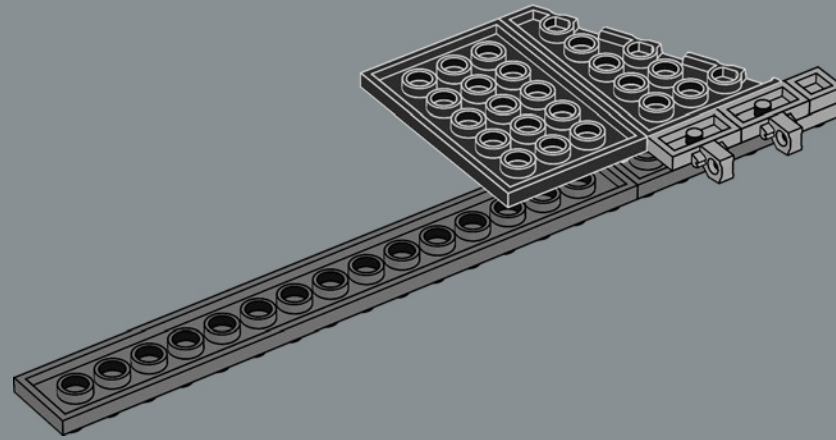

414

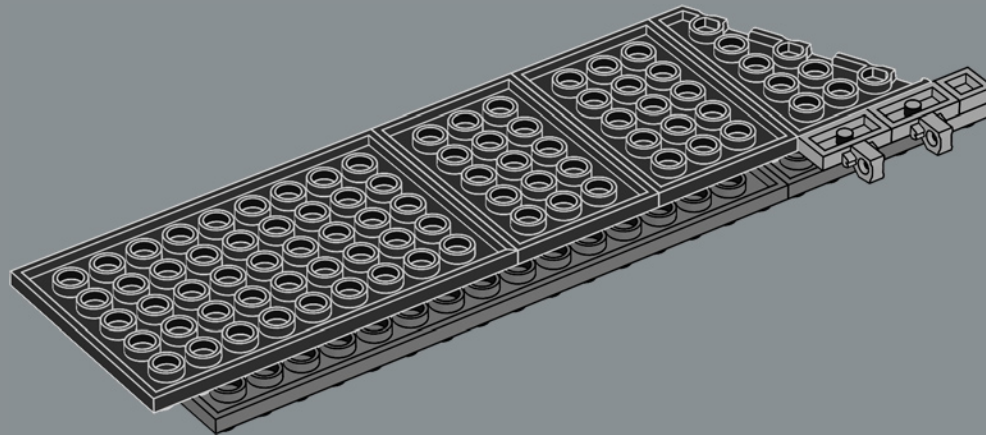

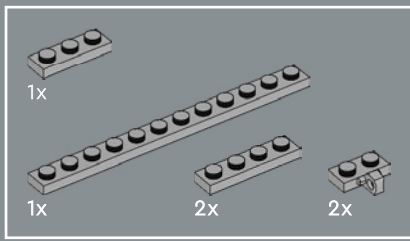

415

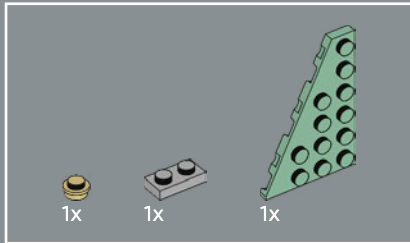
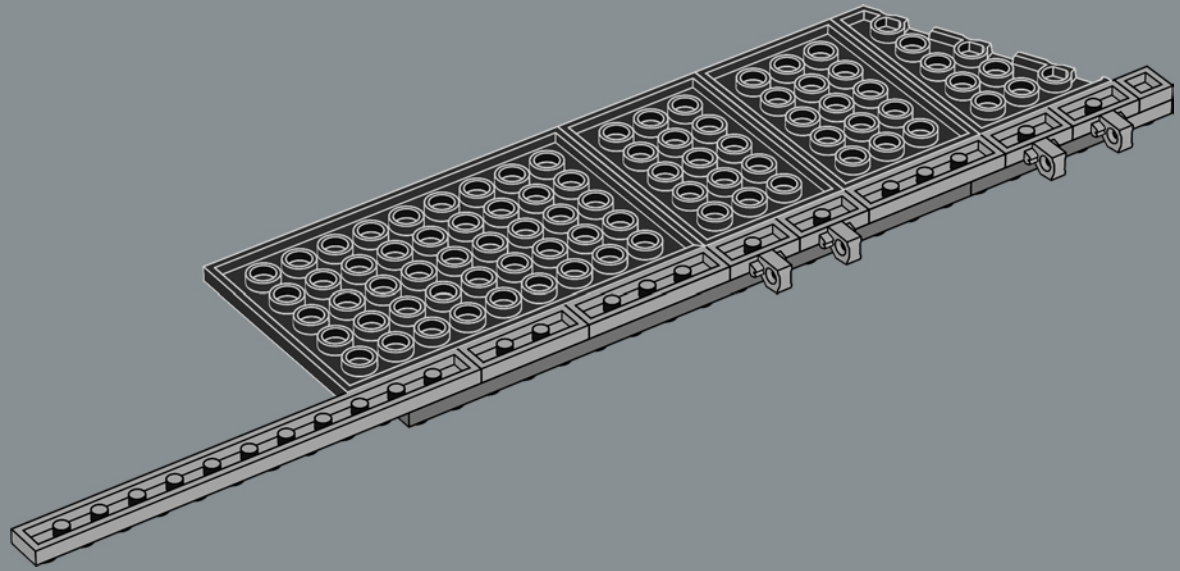

416

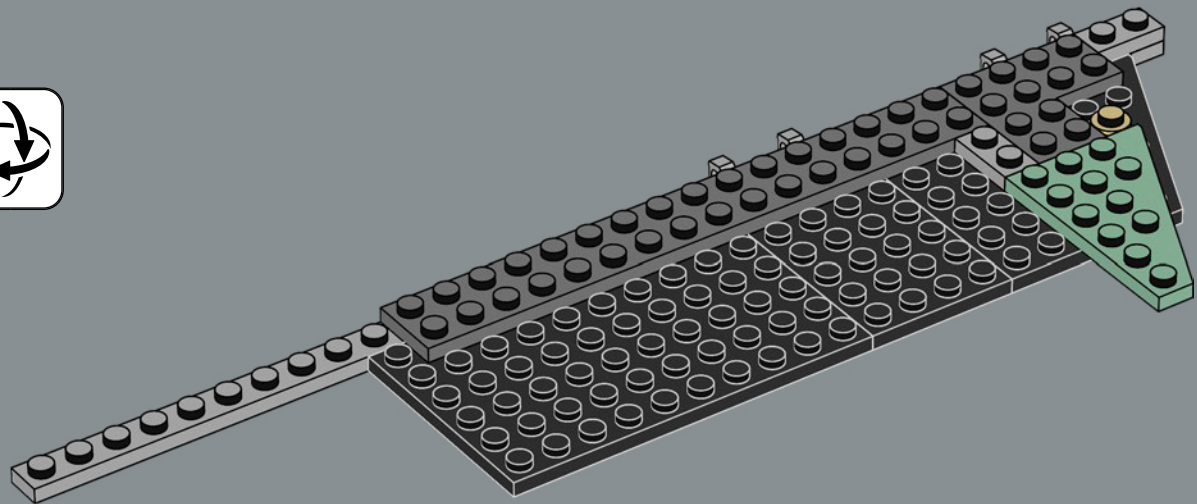

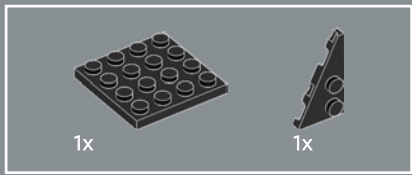

417

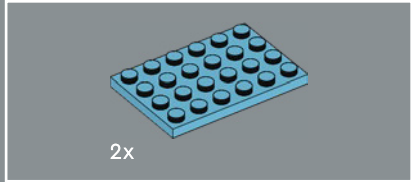
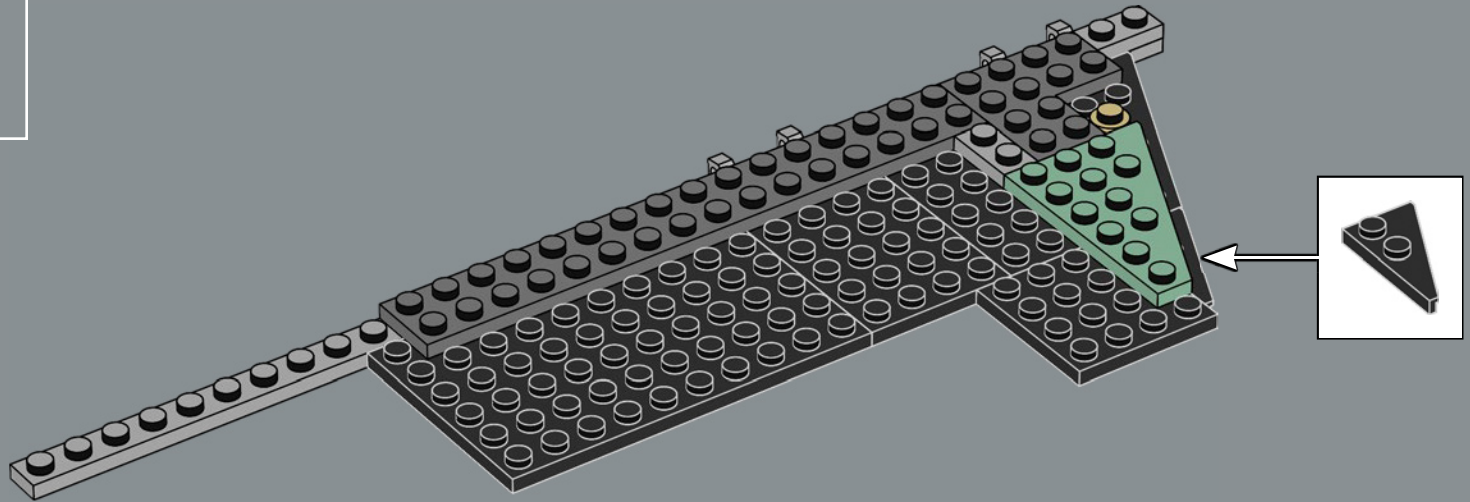

418

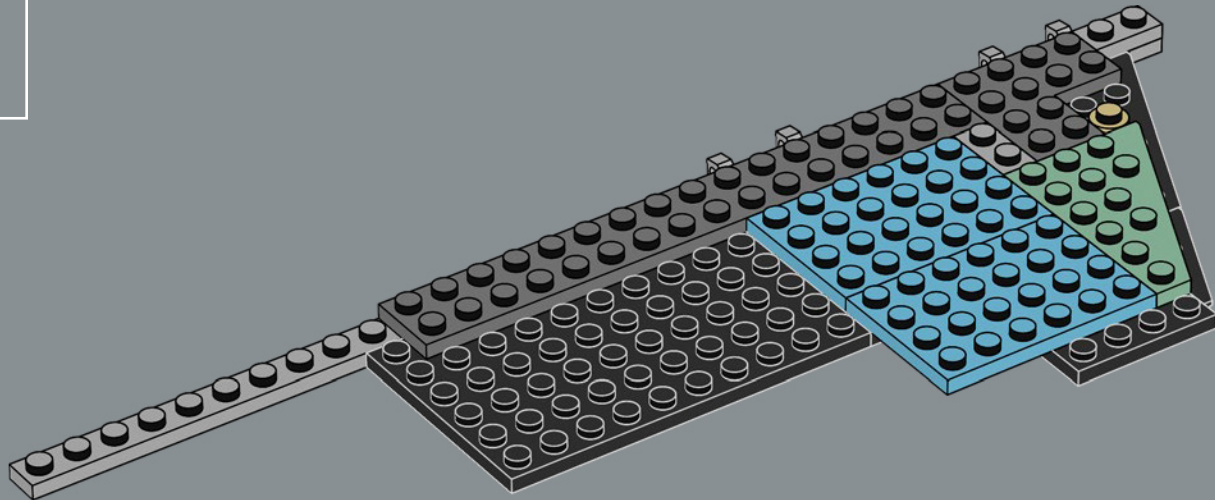

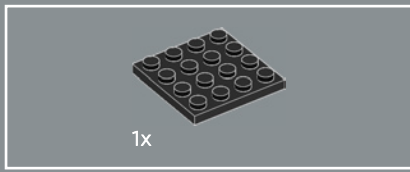

419

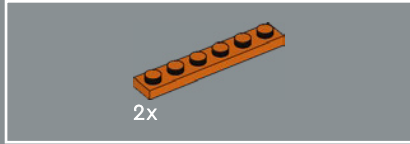
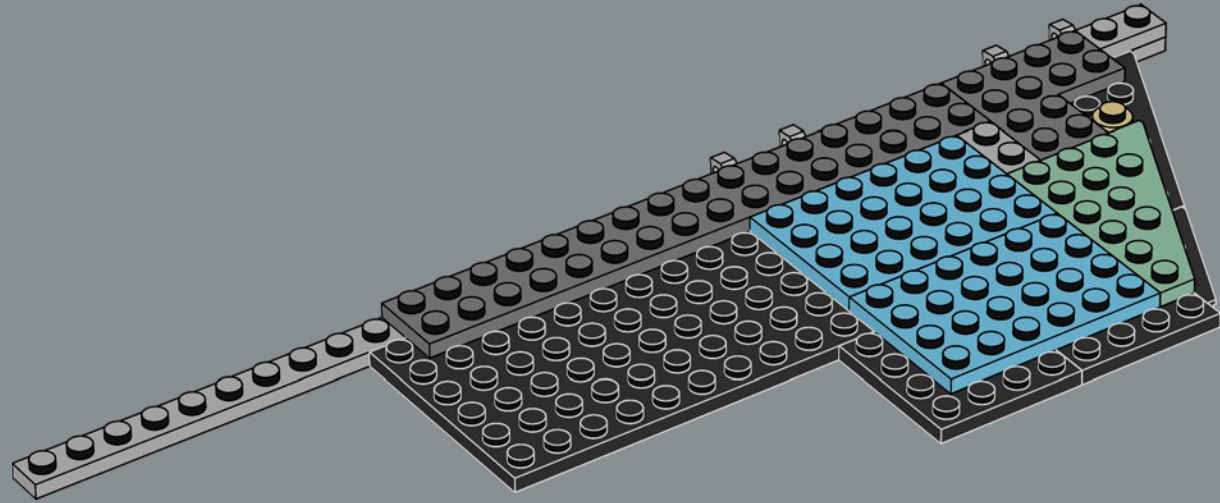

420

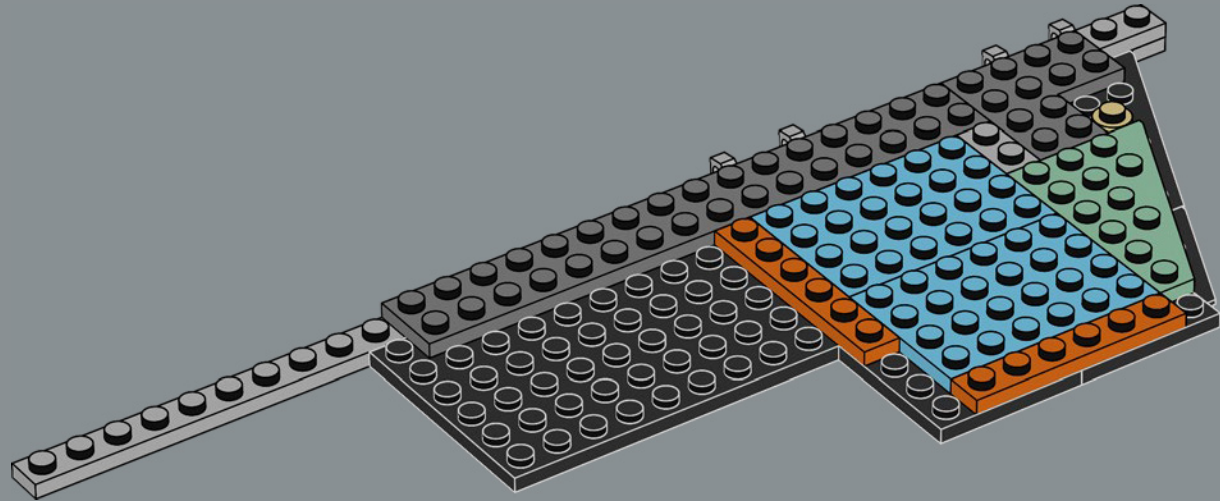



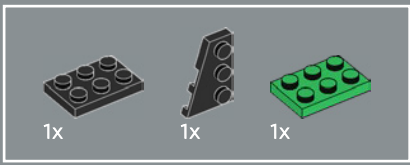

421

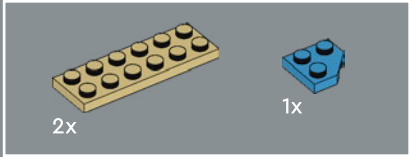
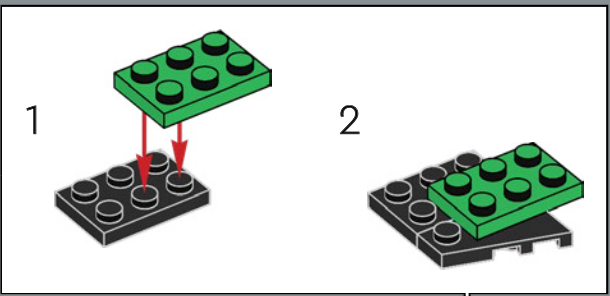
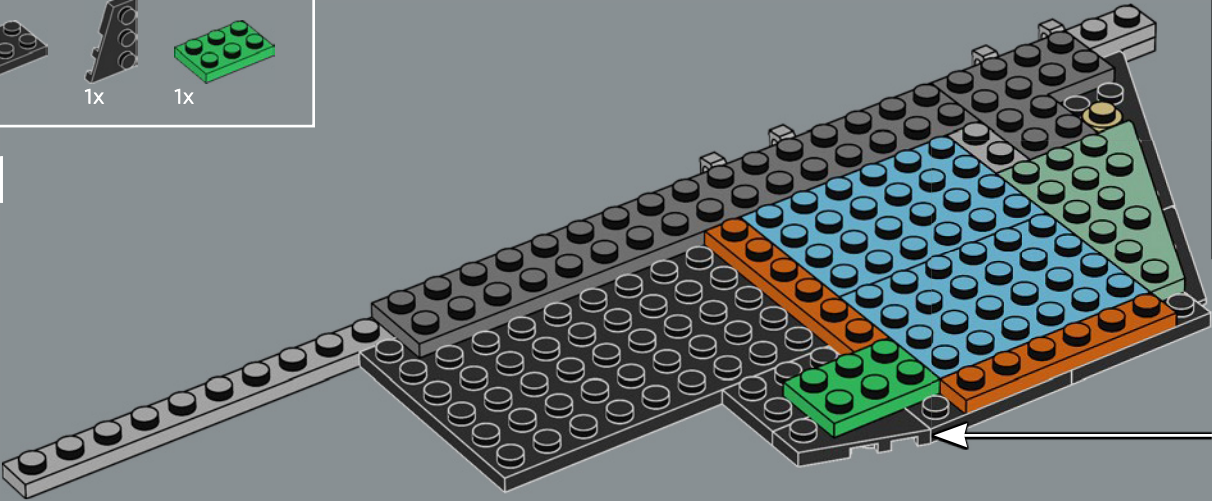

422

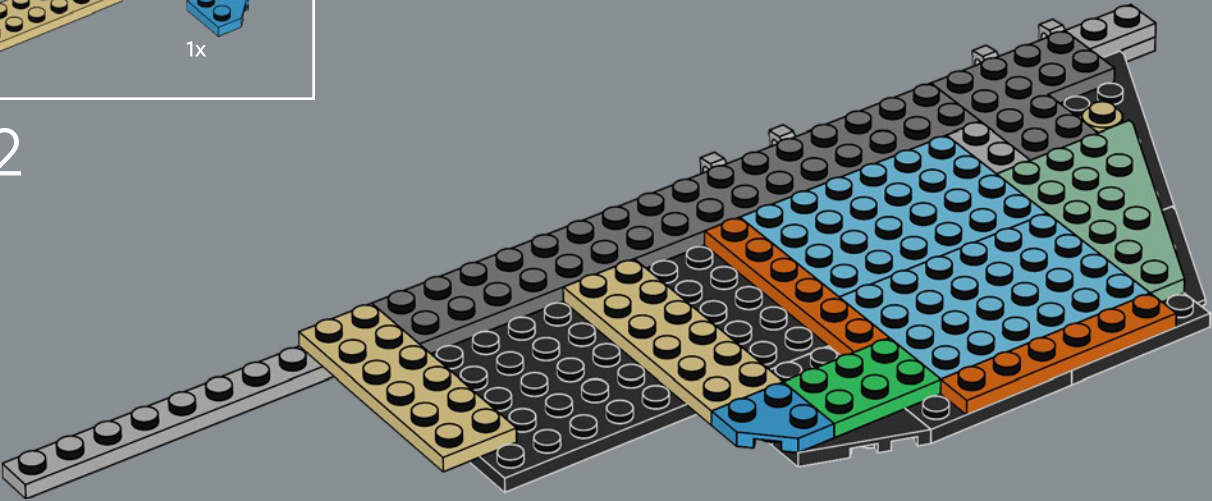

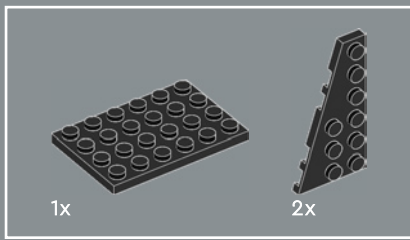

423

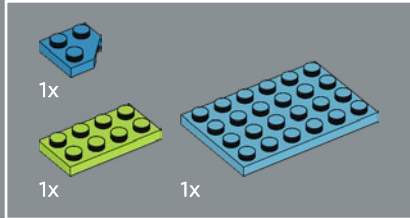
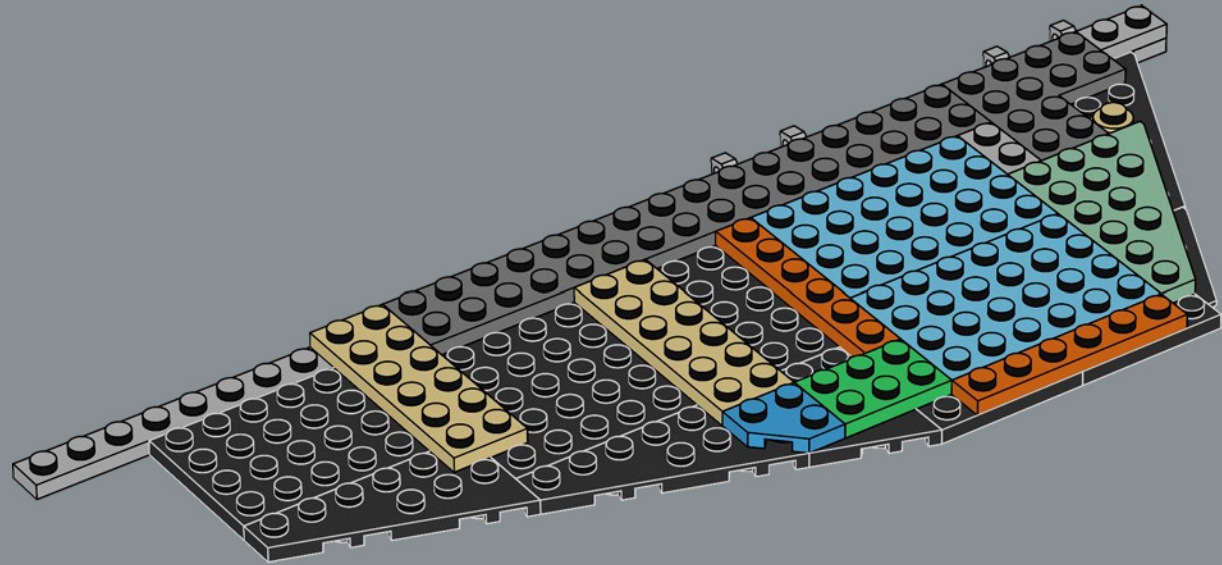

424

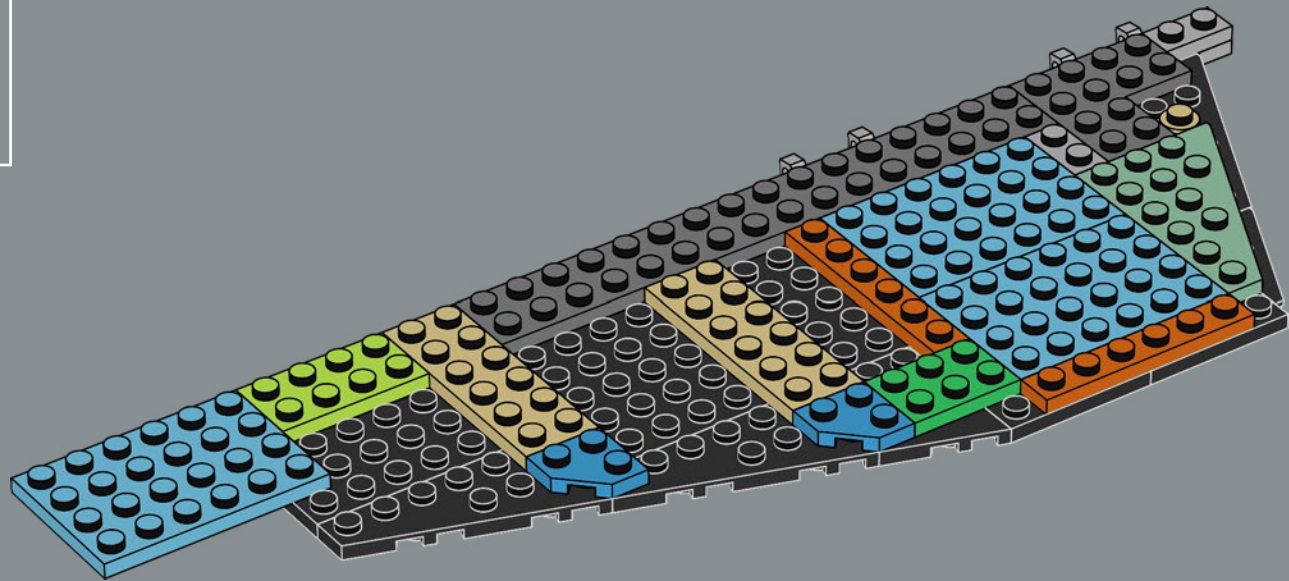



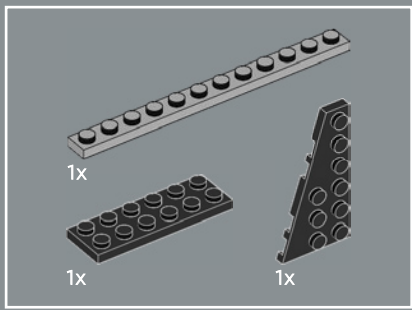

425

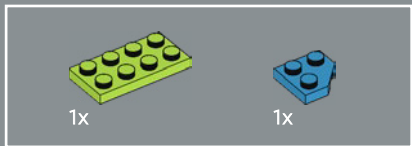
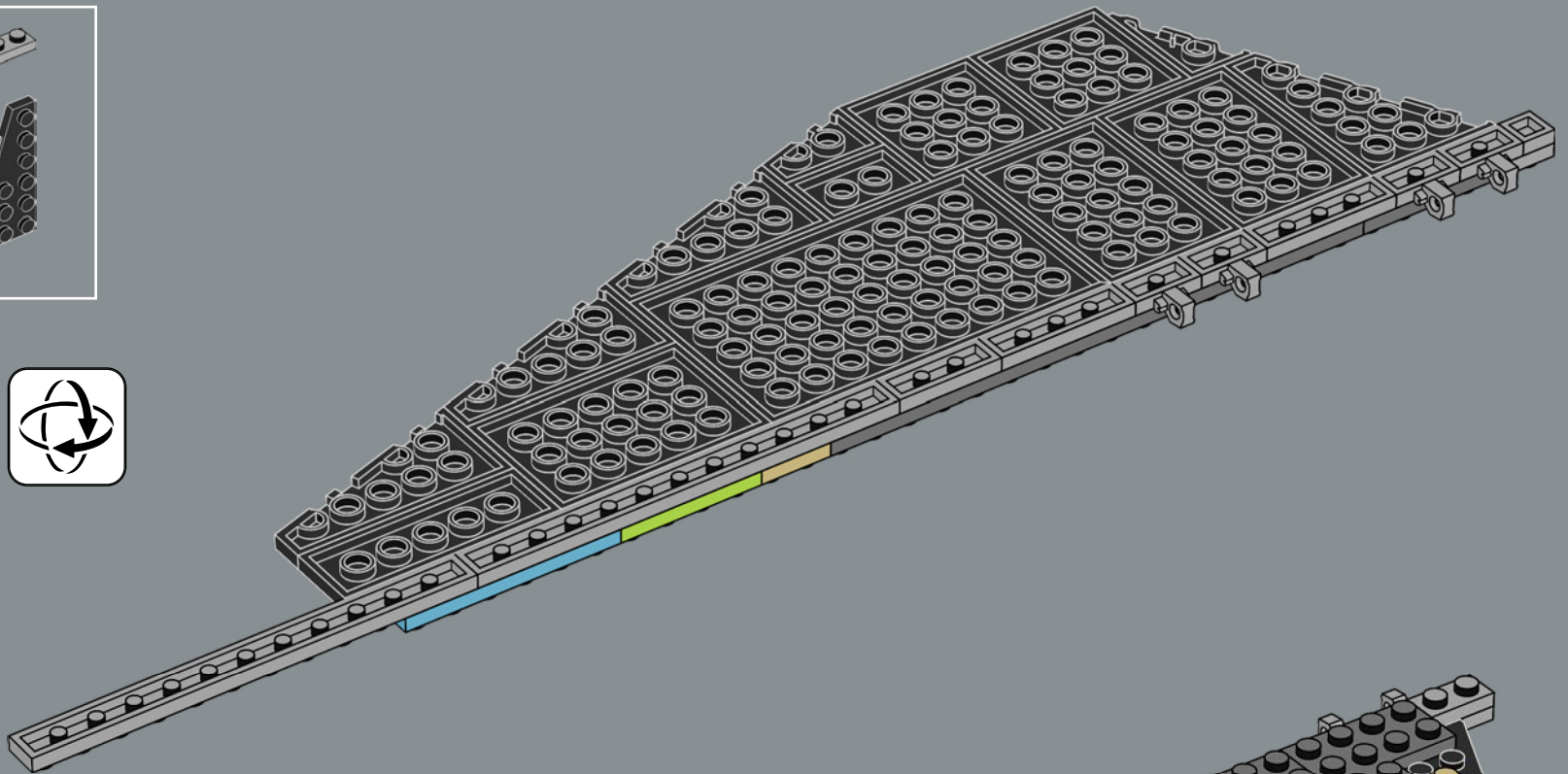

426

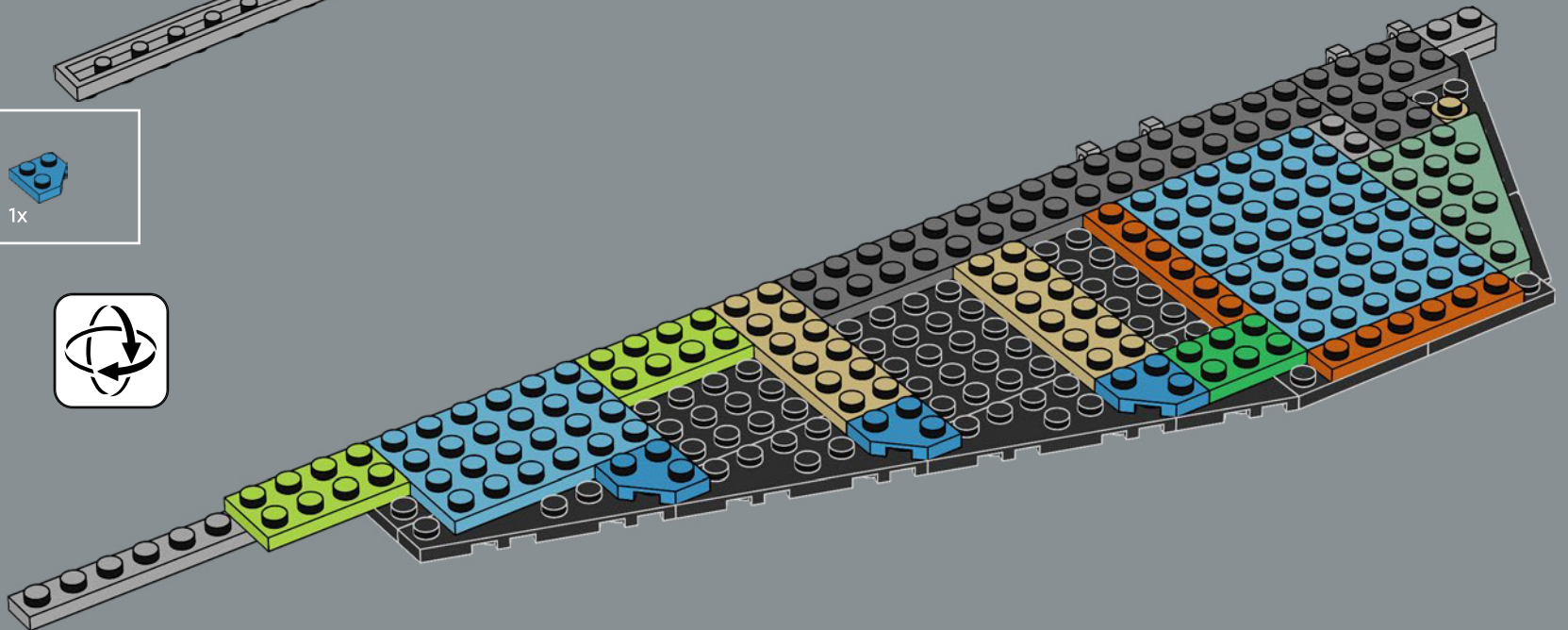

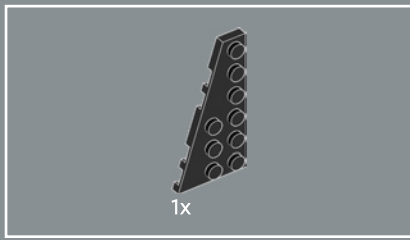

427

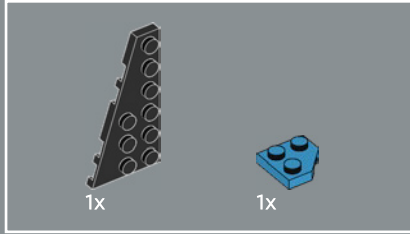
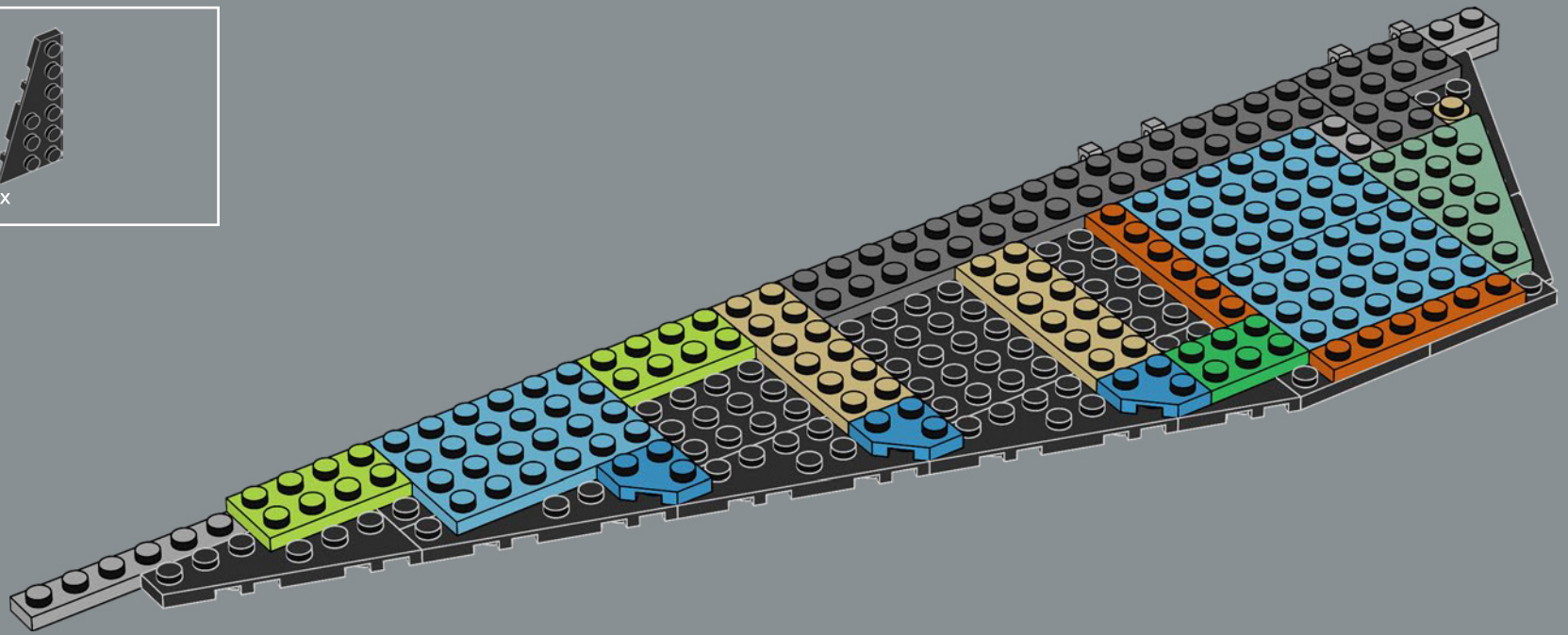

428

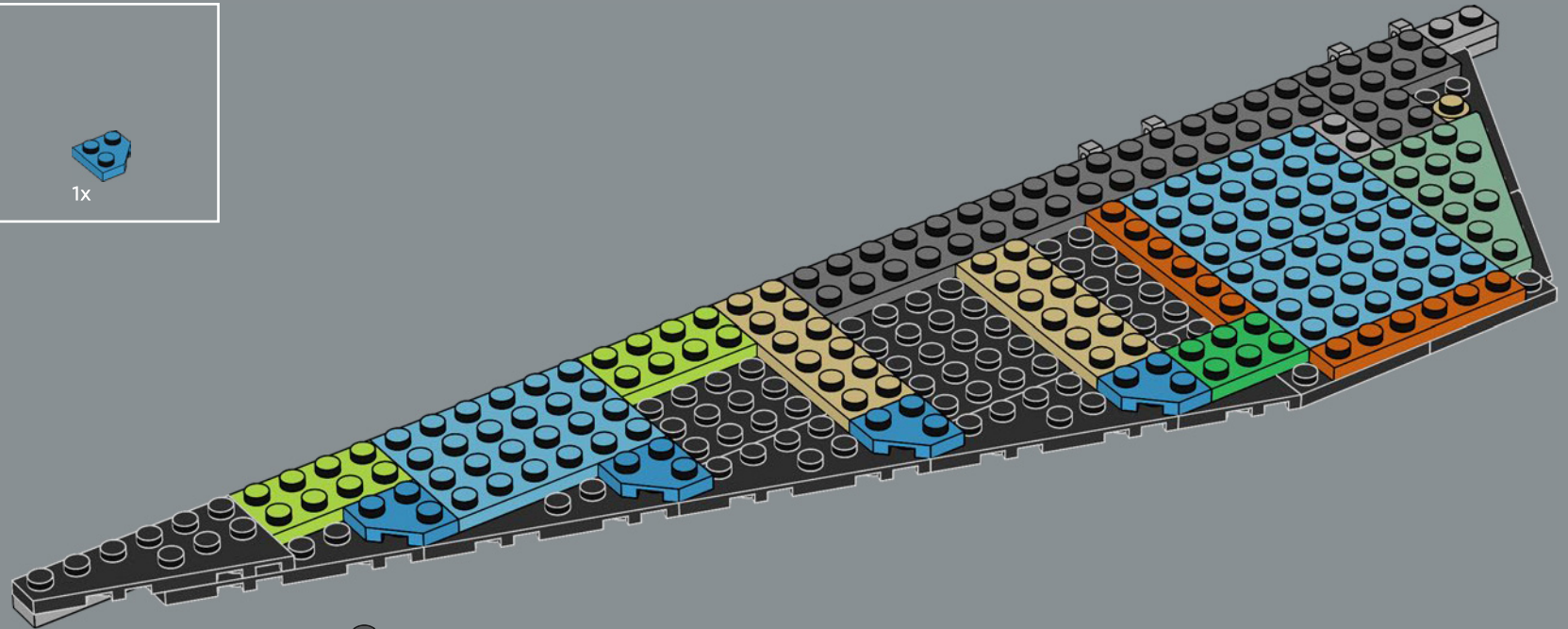



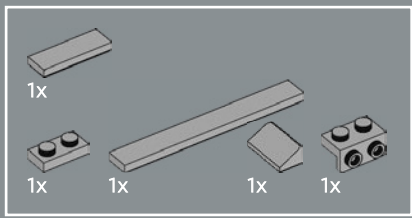

429

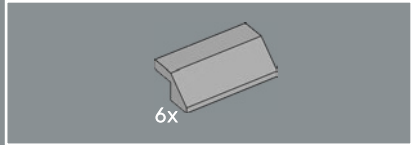
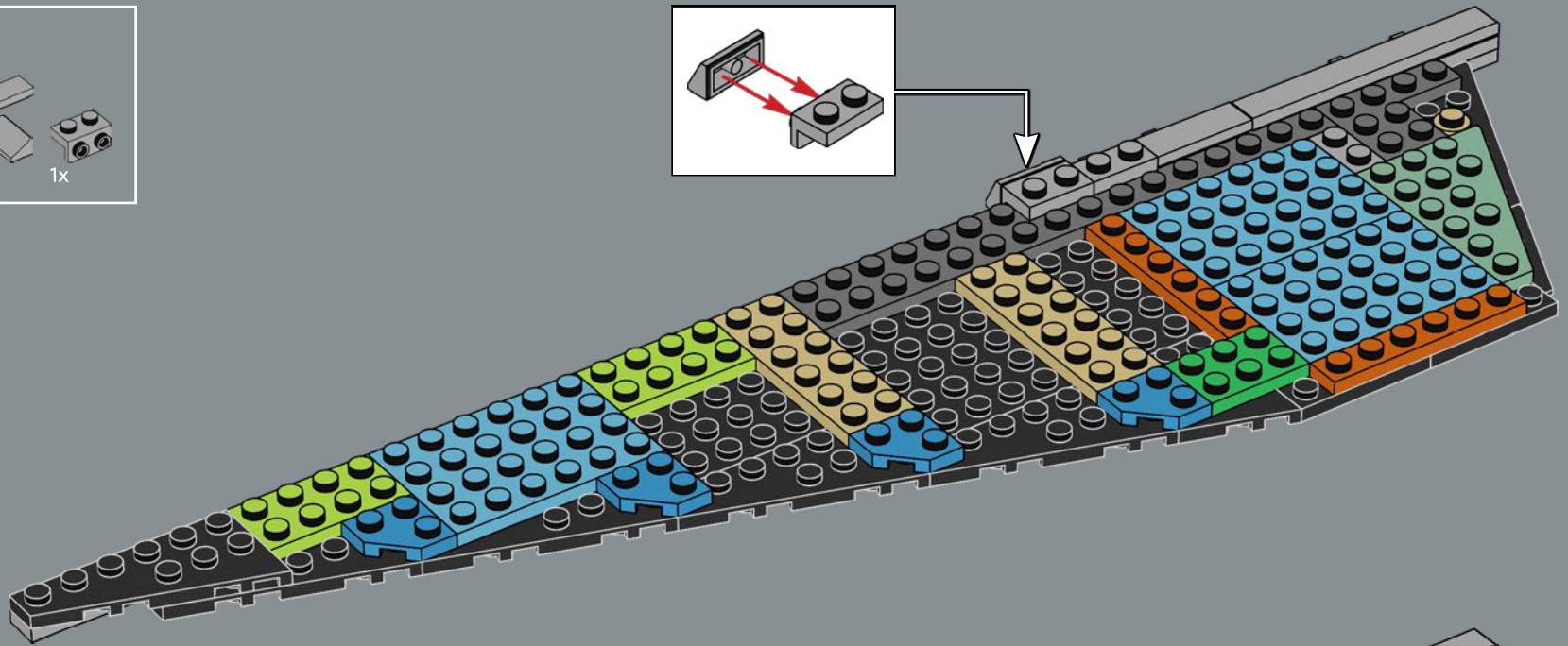
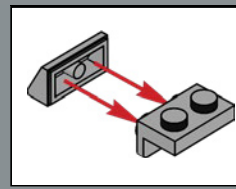

430

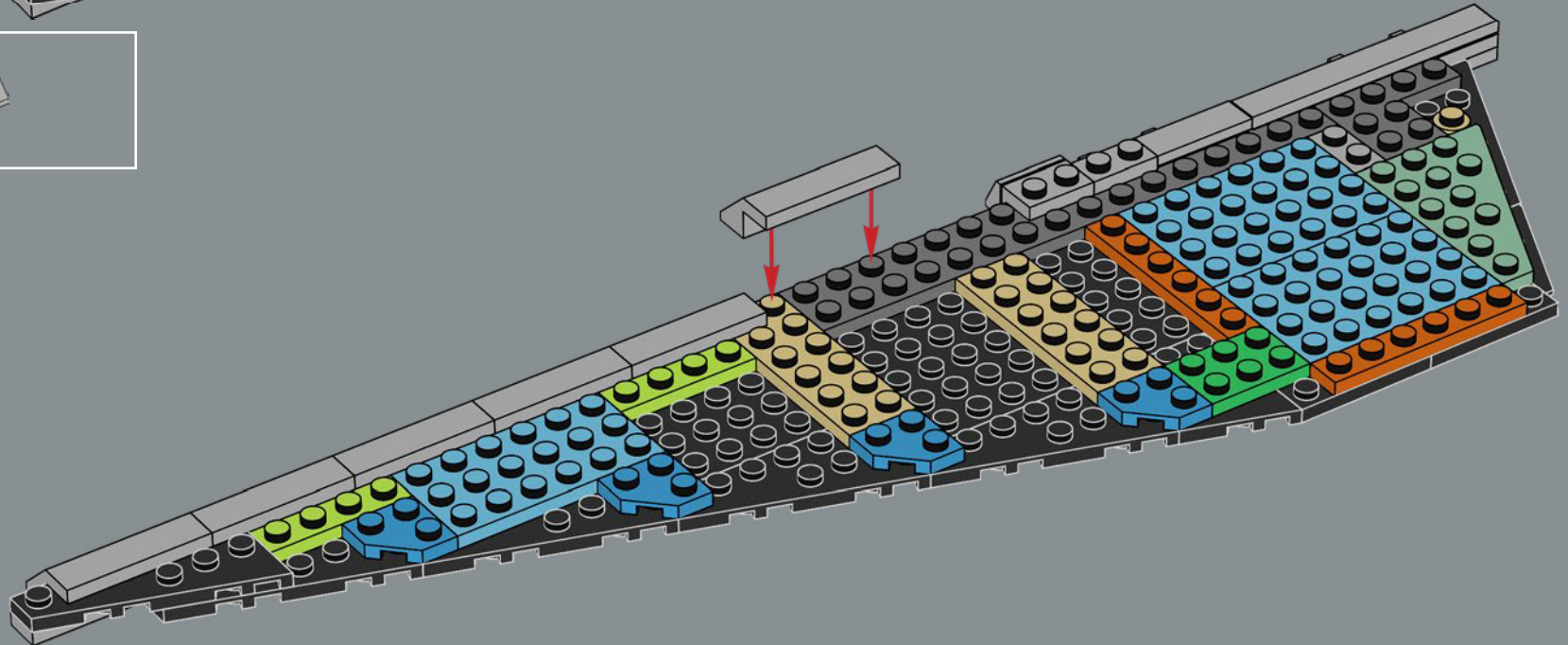

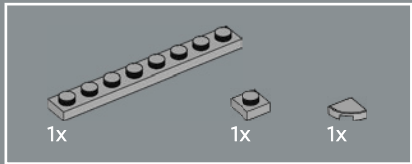
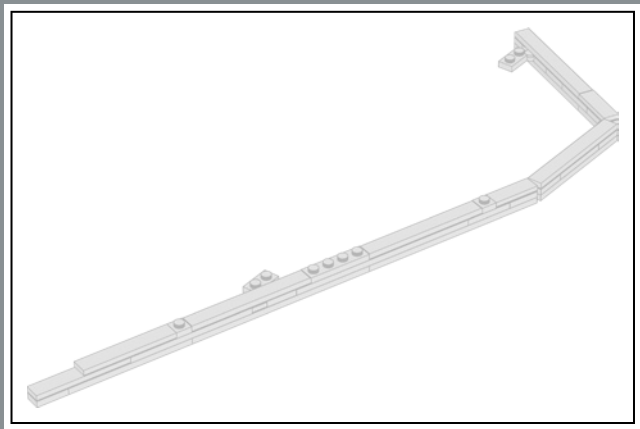

431

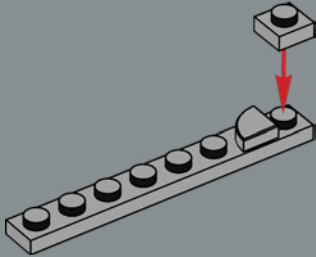

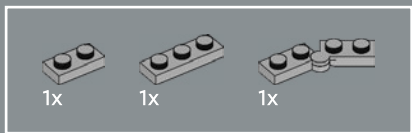

432

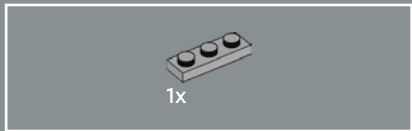
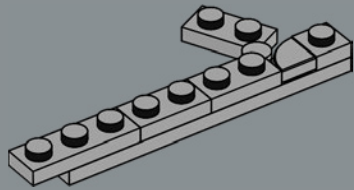

433

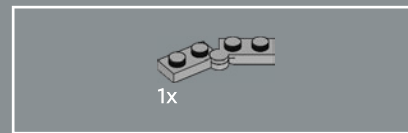
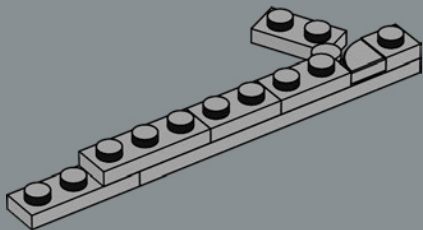

434

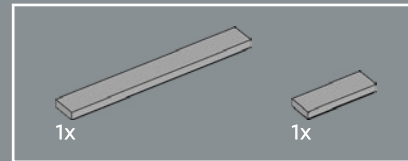
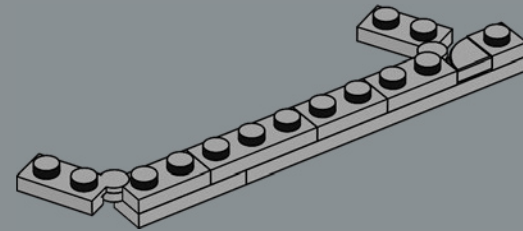

435

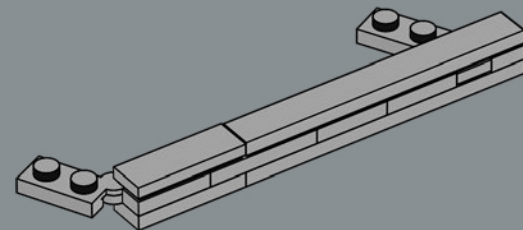

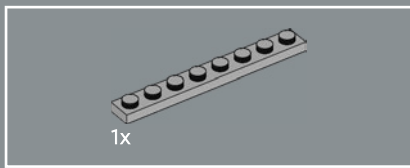

436

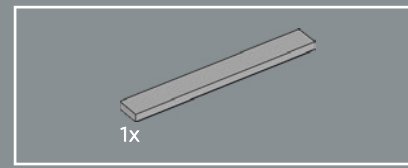
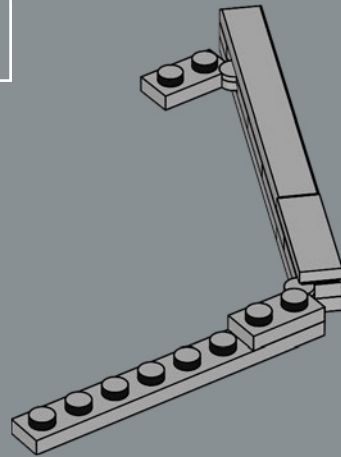

438

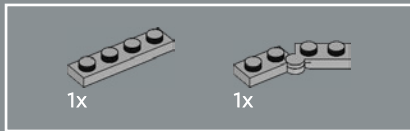
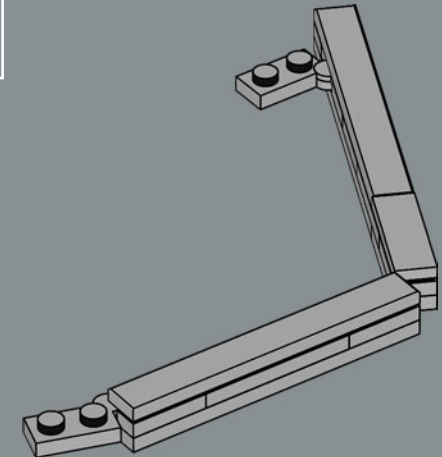

437

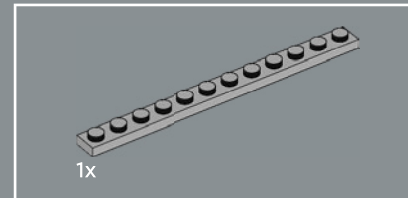
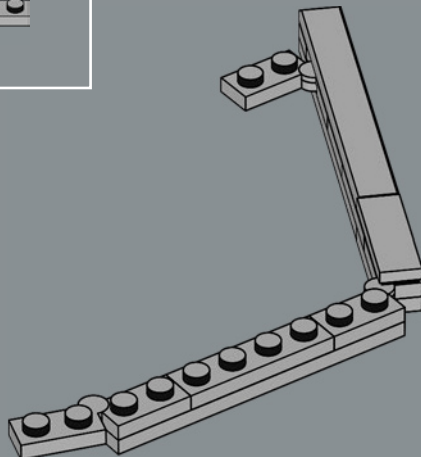

439

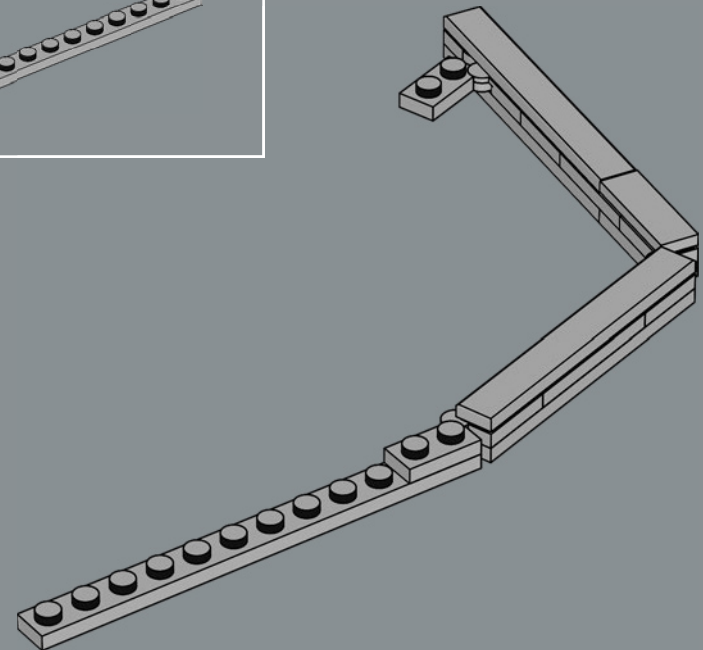



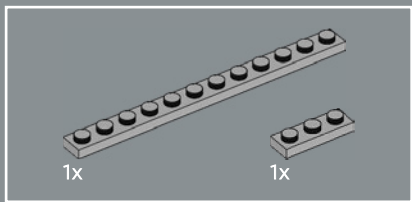

440

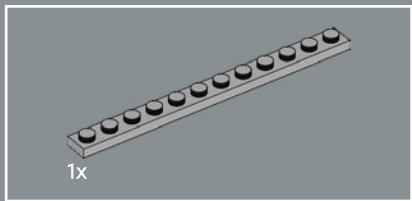
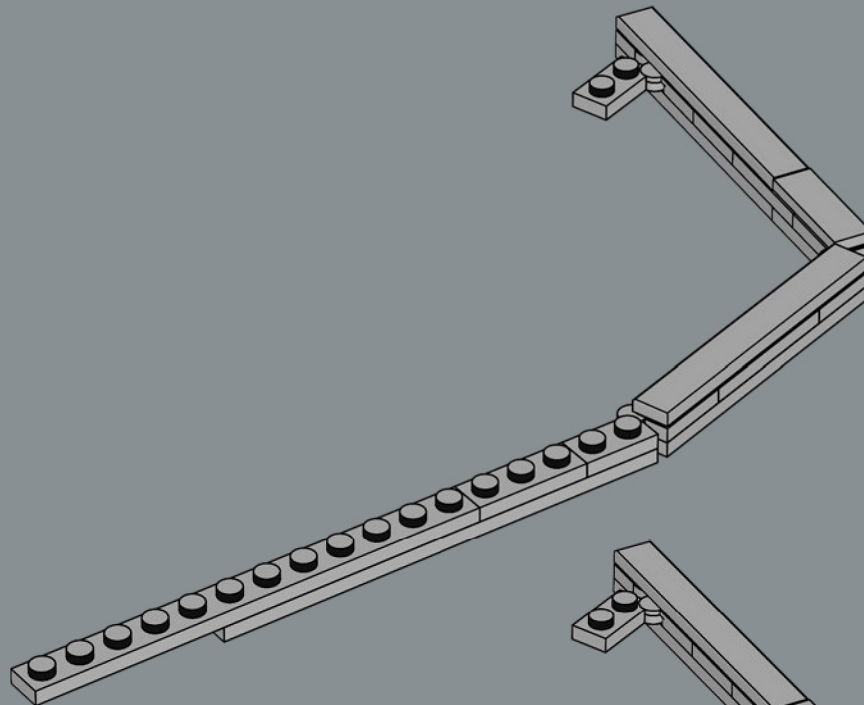

441

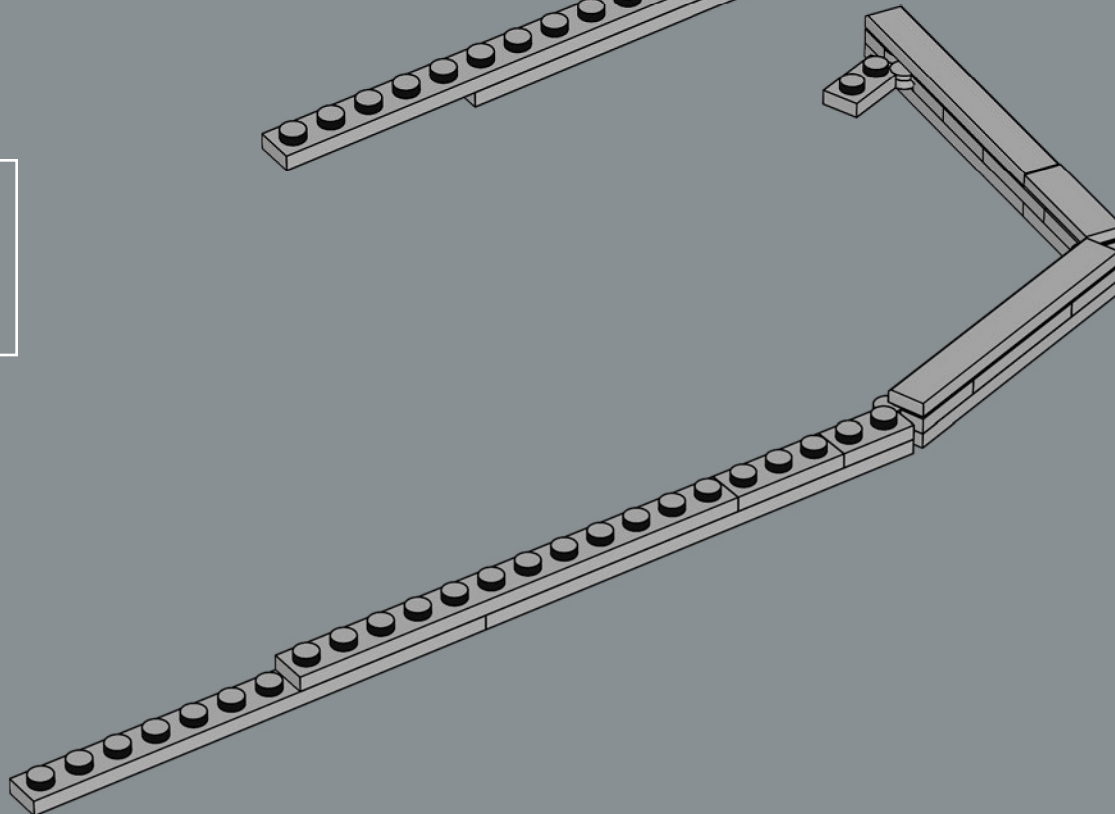

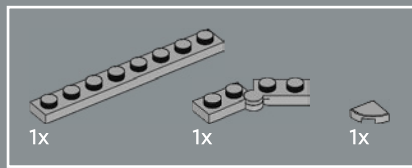

442

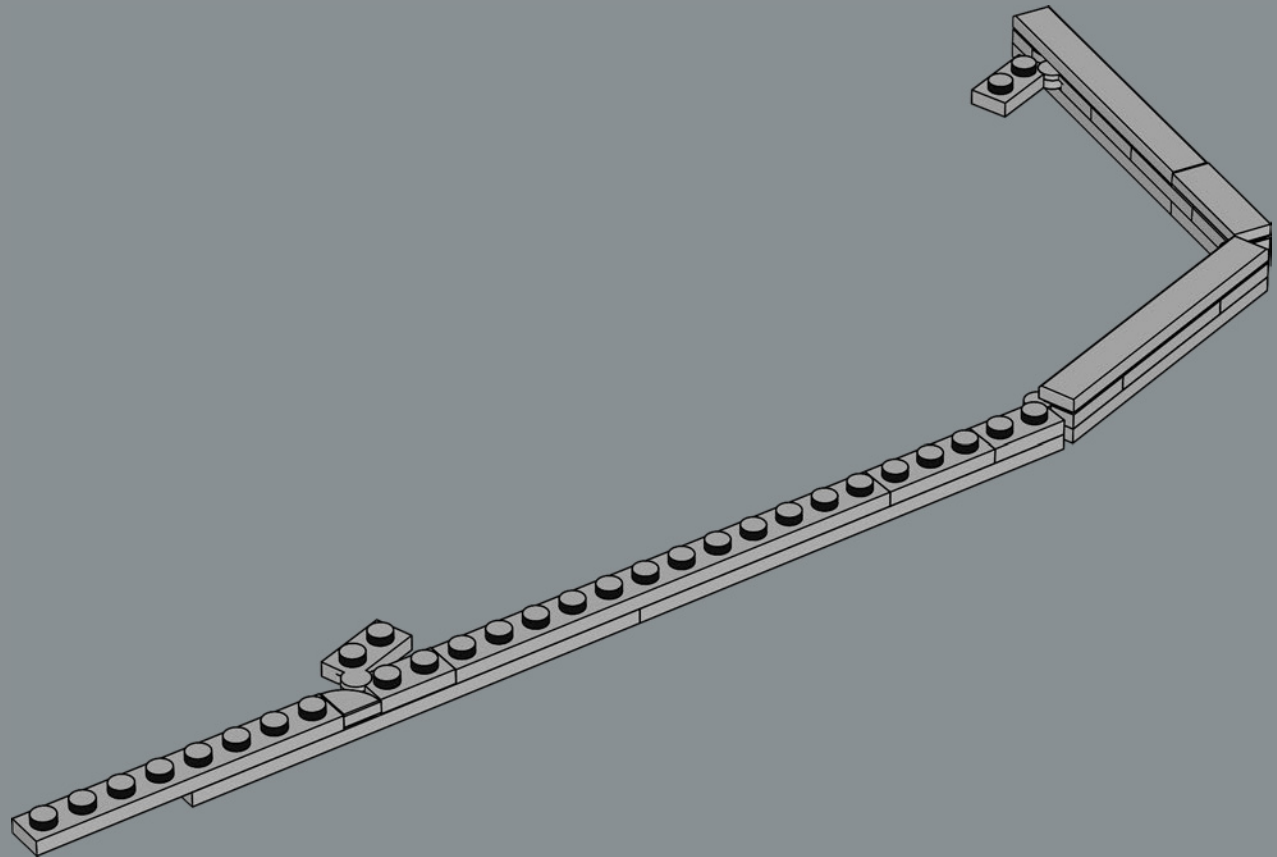

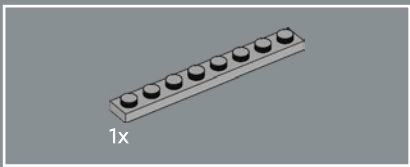

443

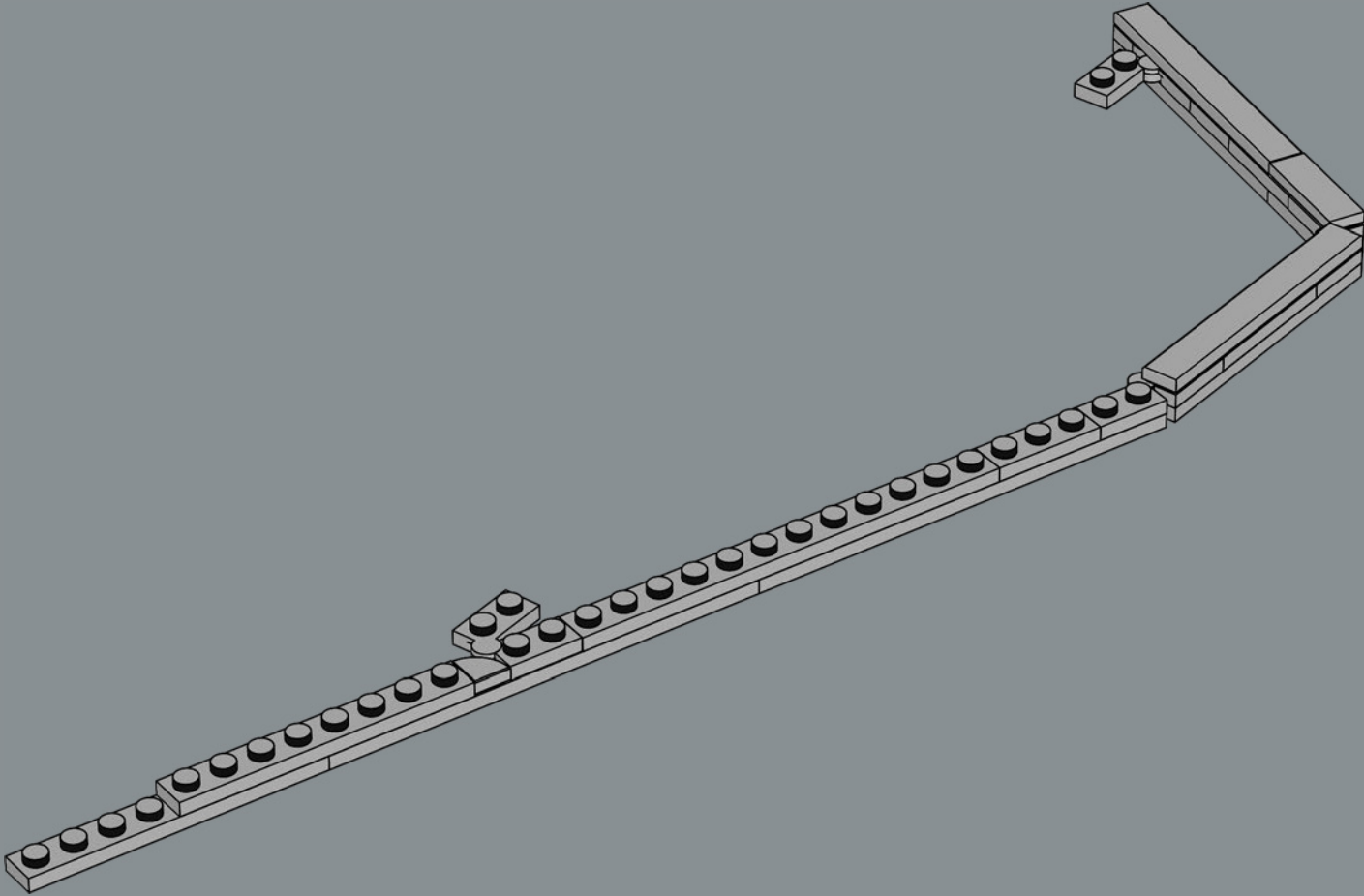

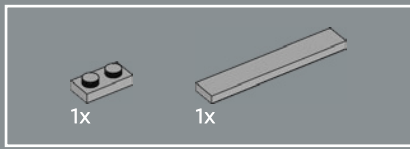

444

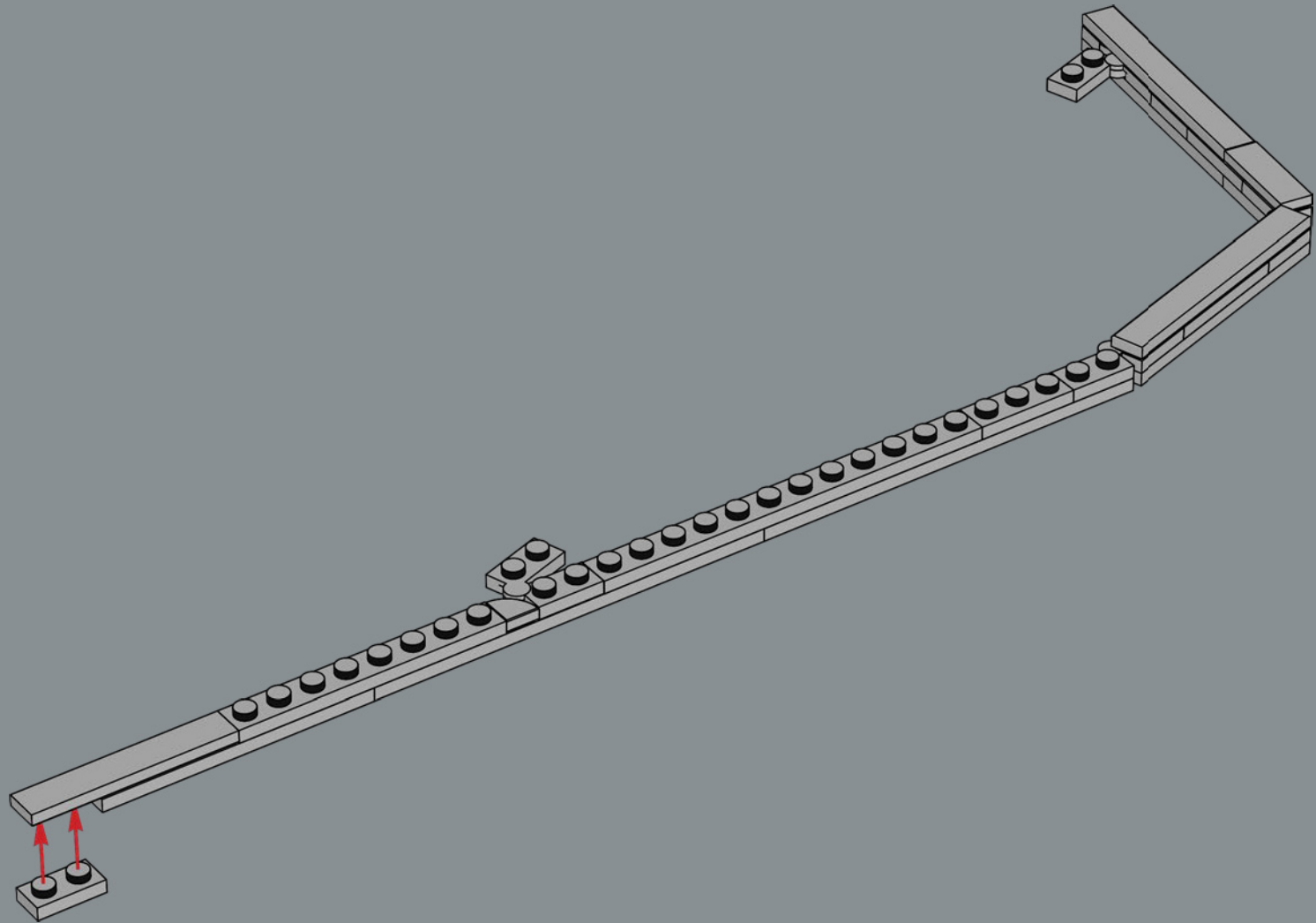



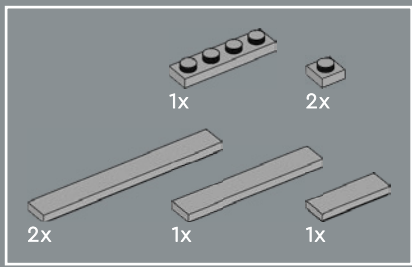

445

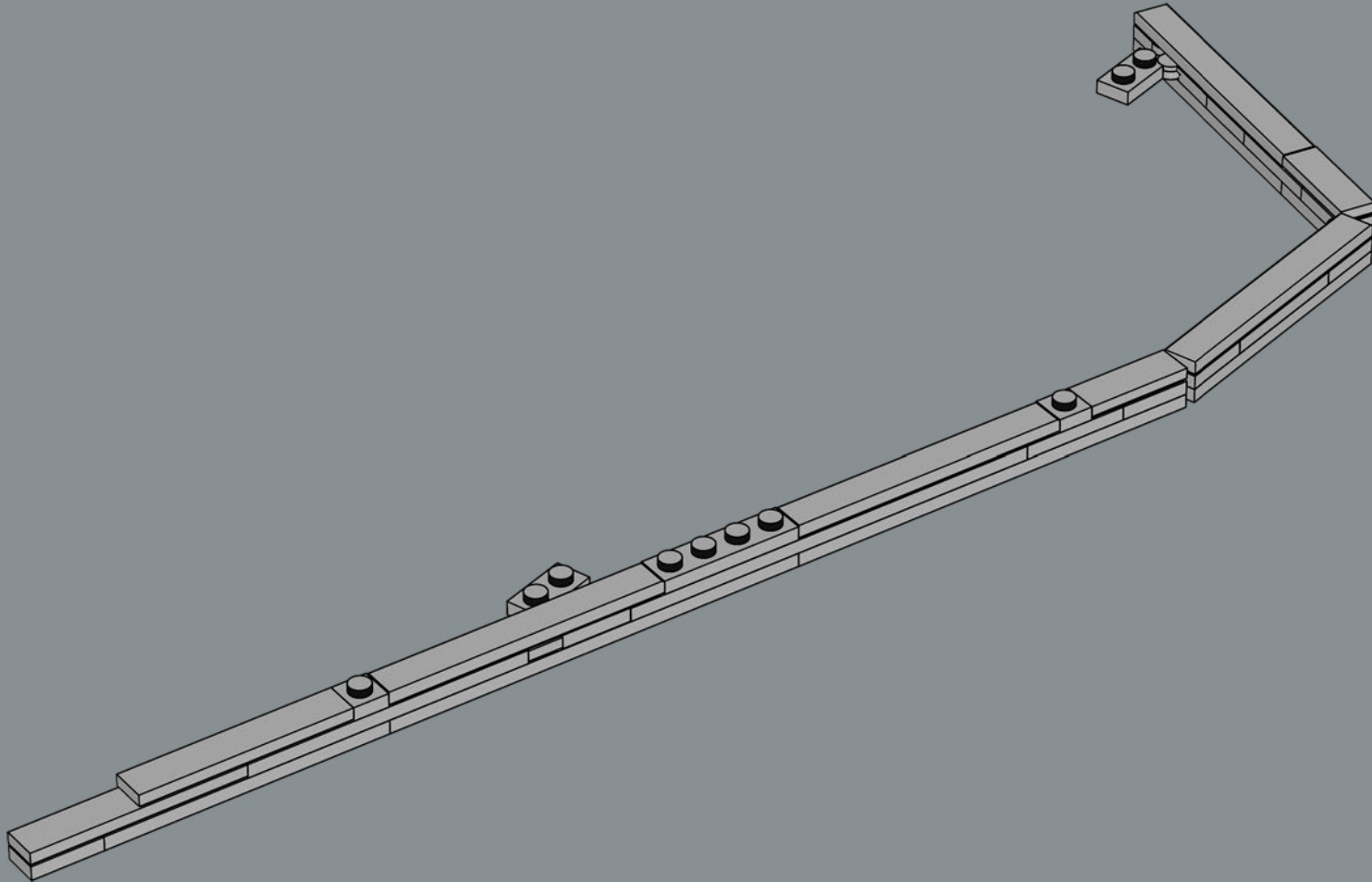

446

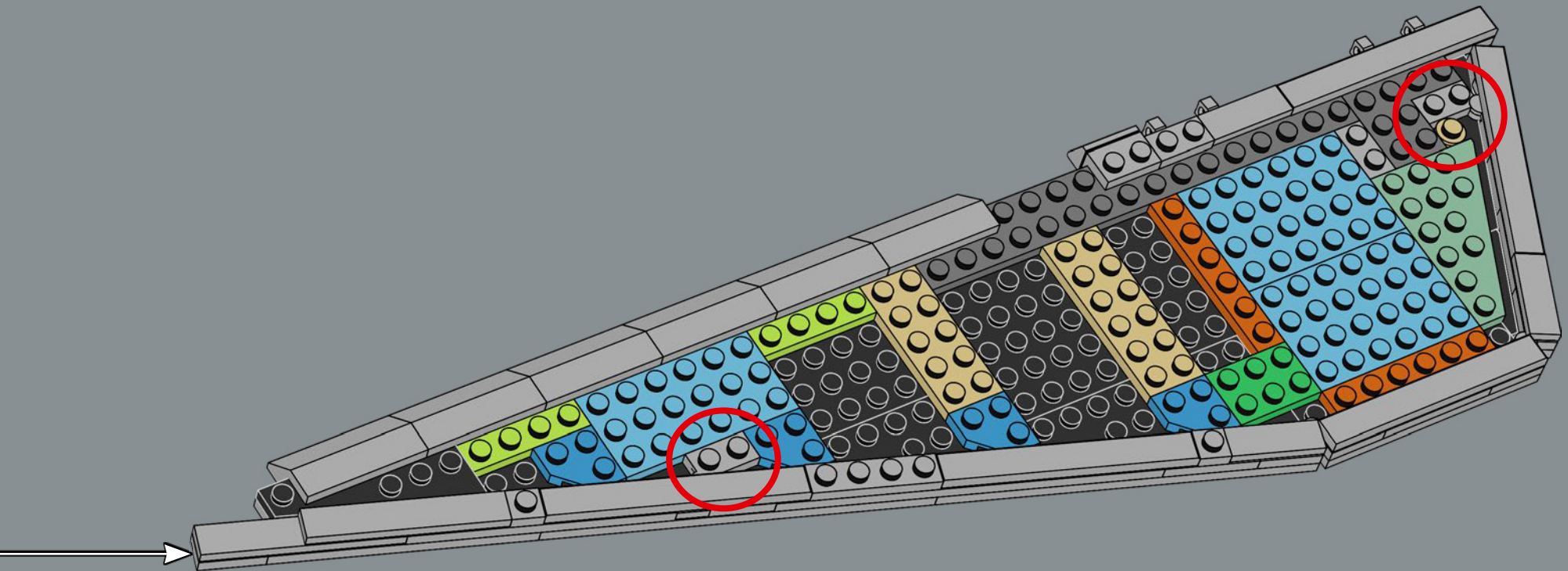

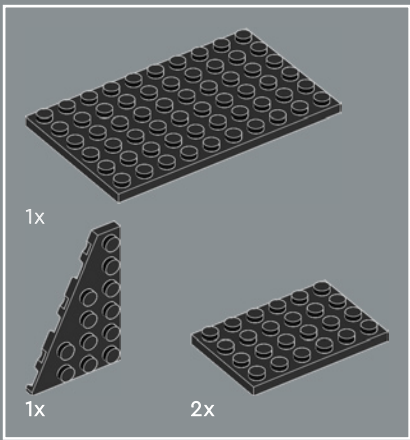

447

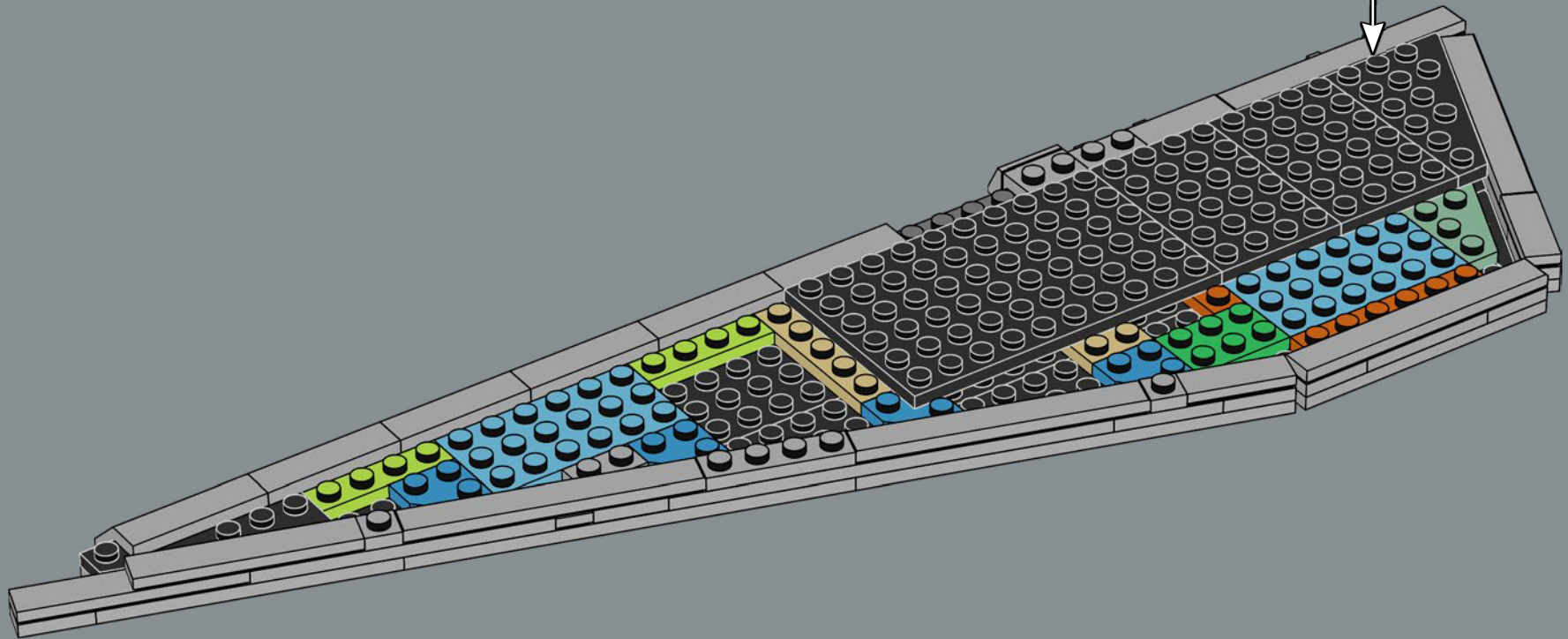
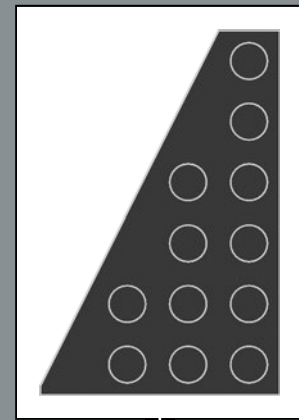

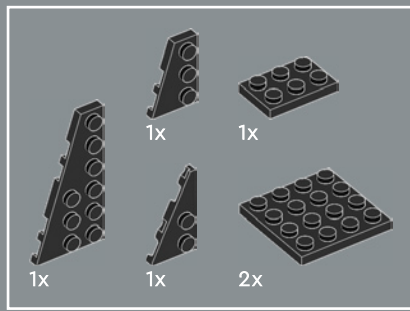

448

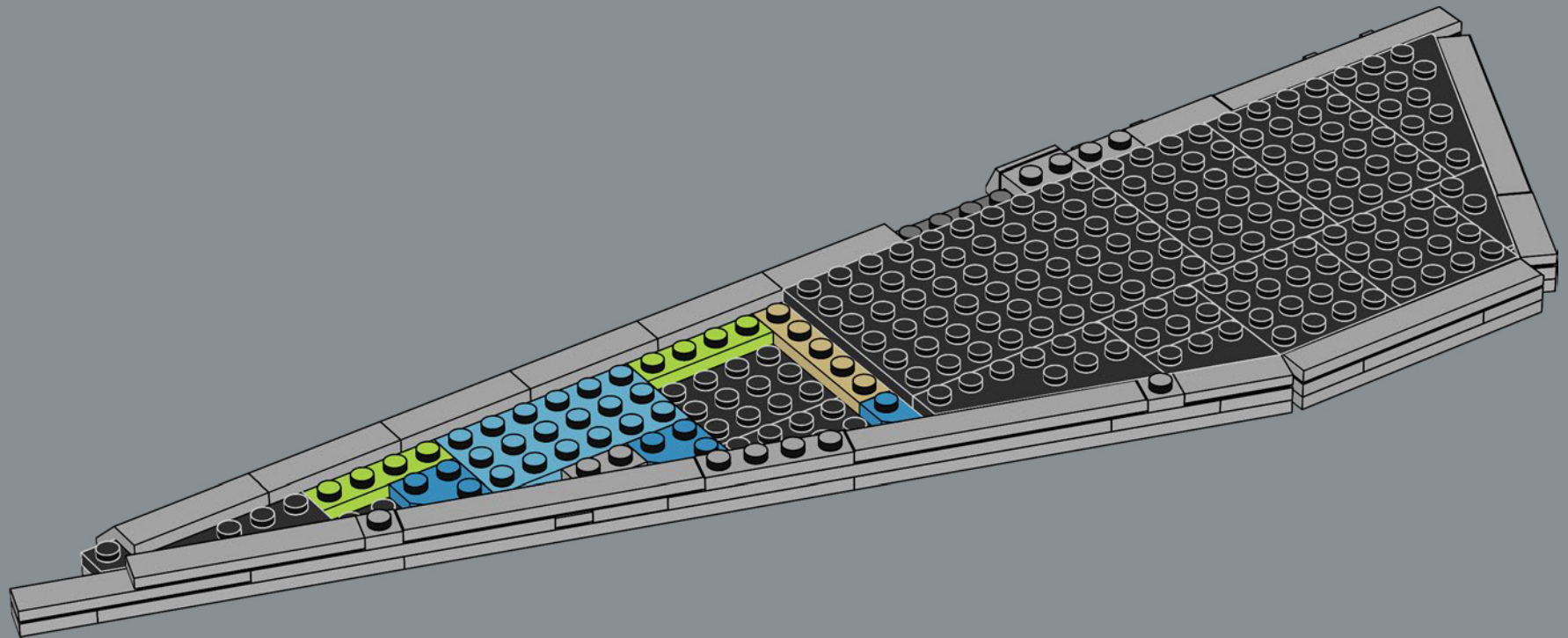



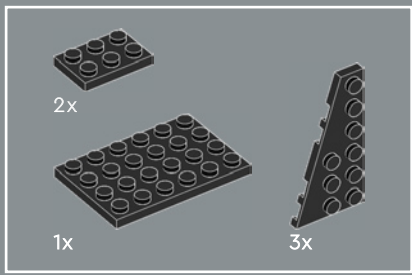

449

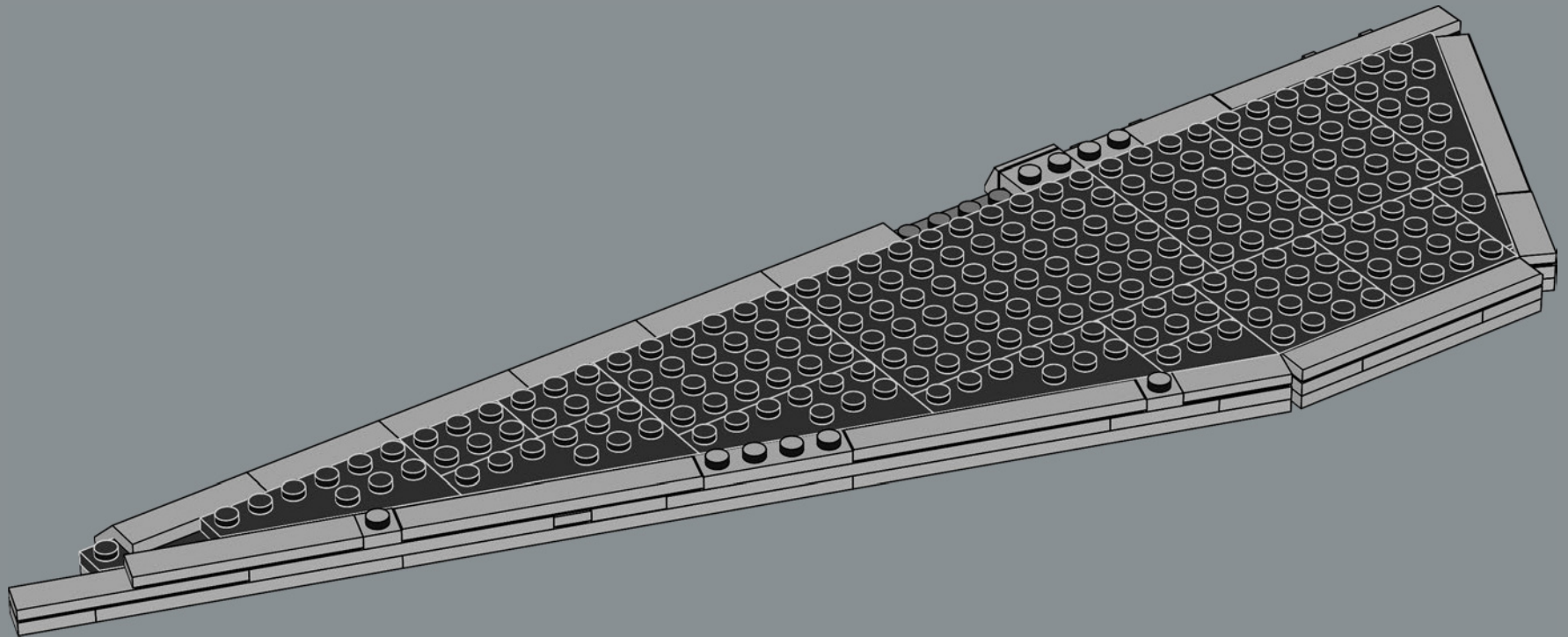

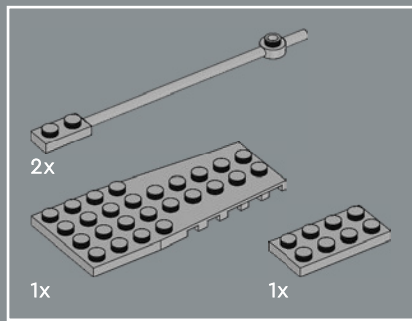

450

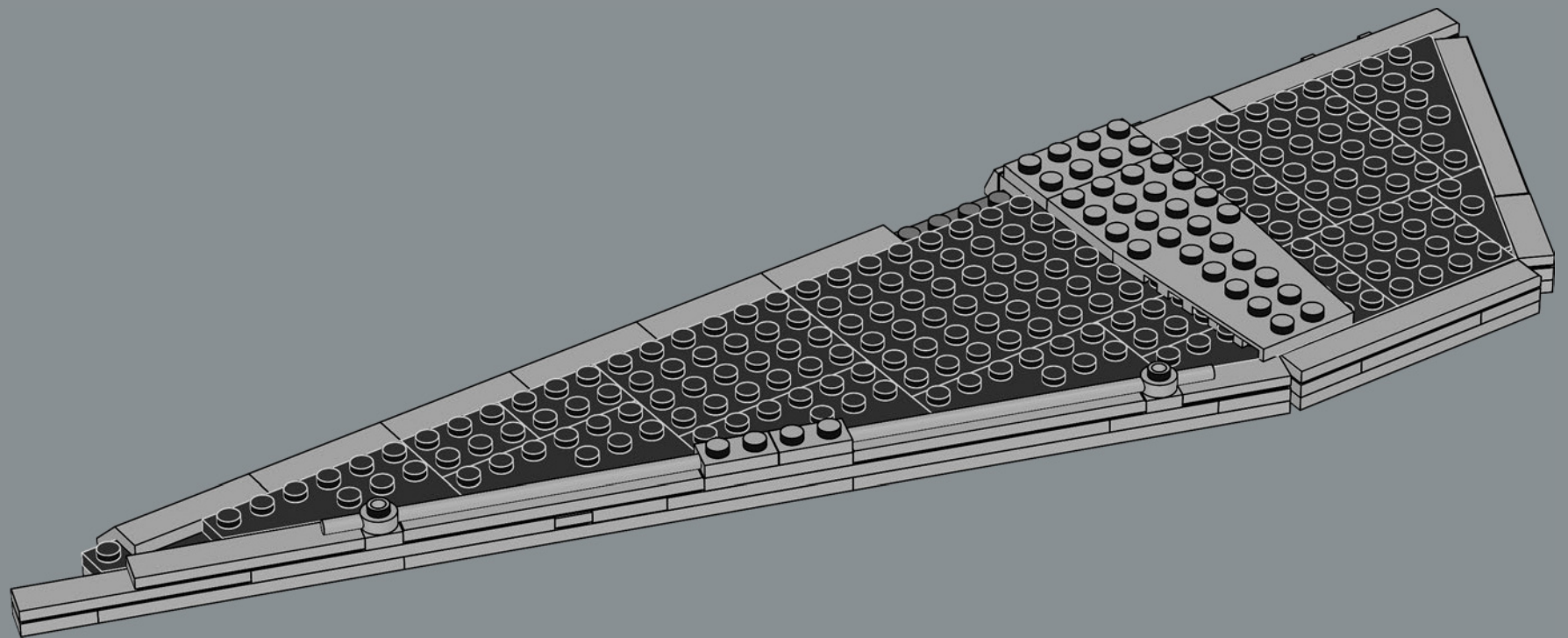

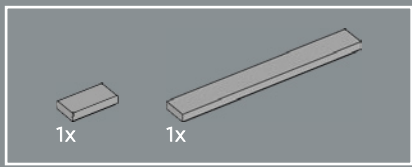

451

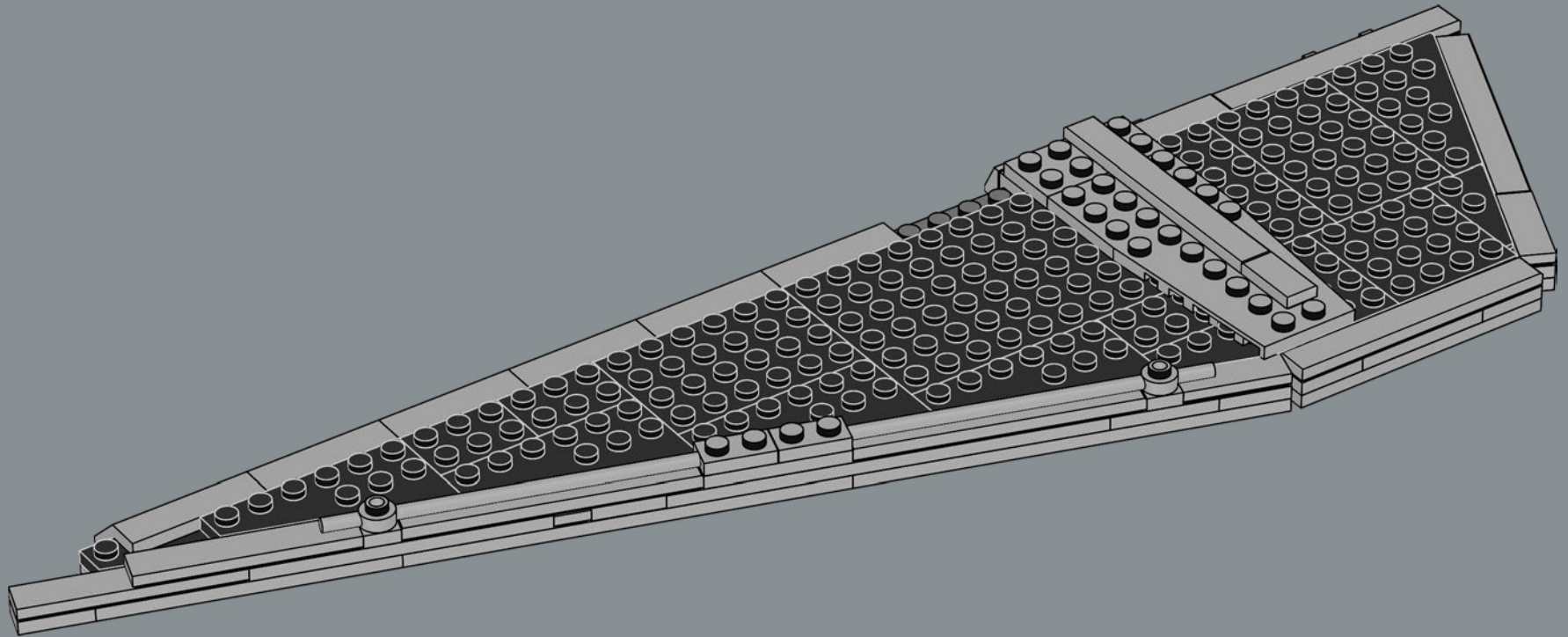

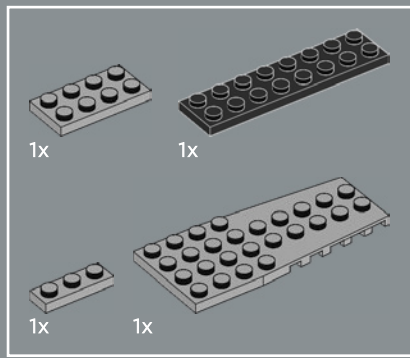

452

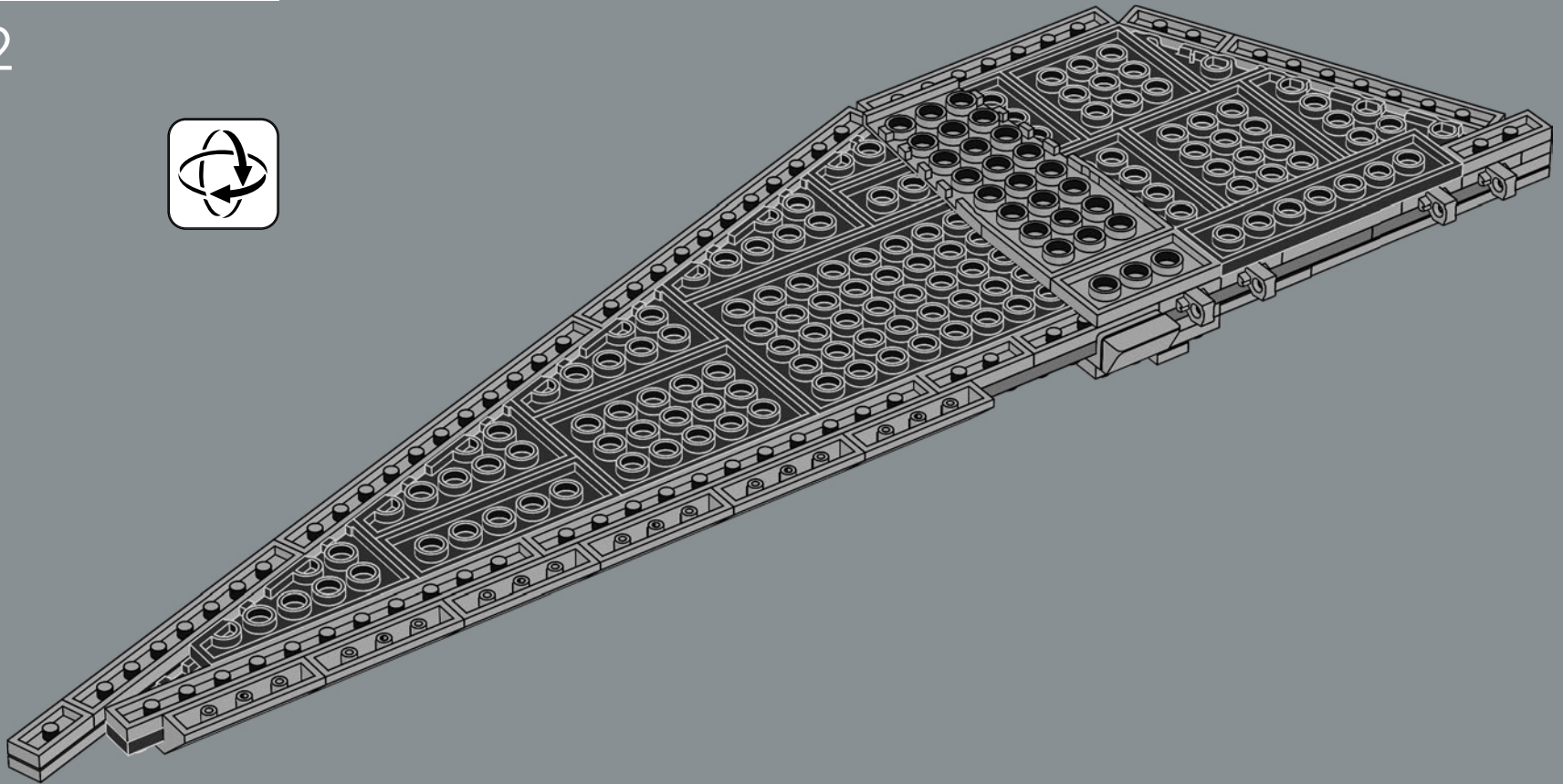



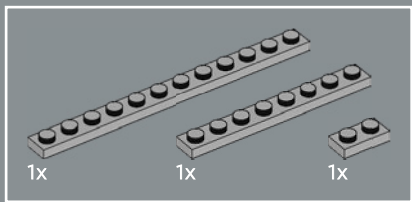

453

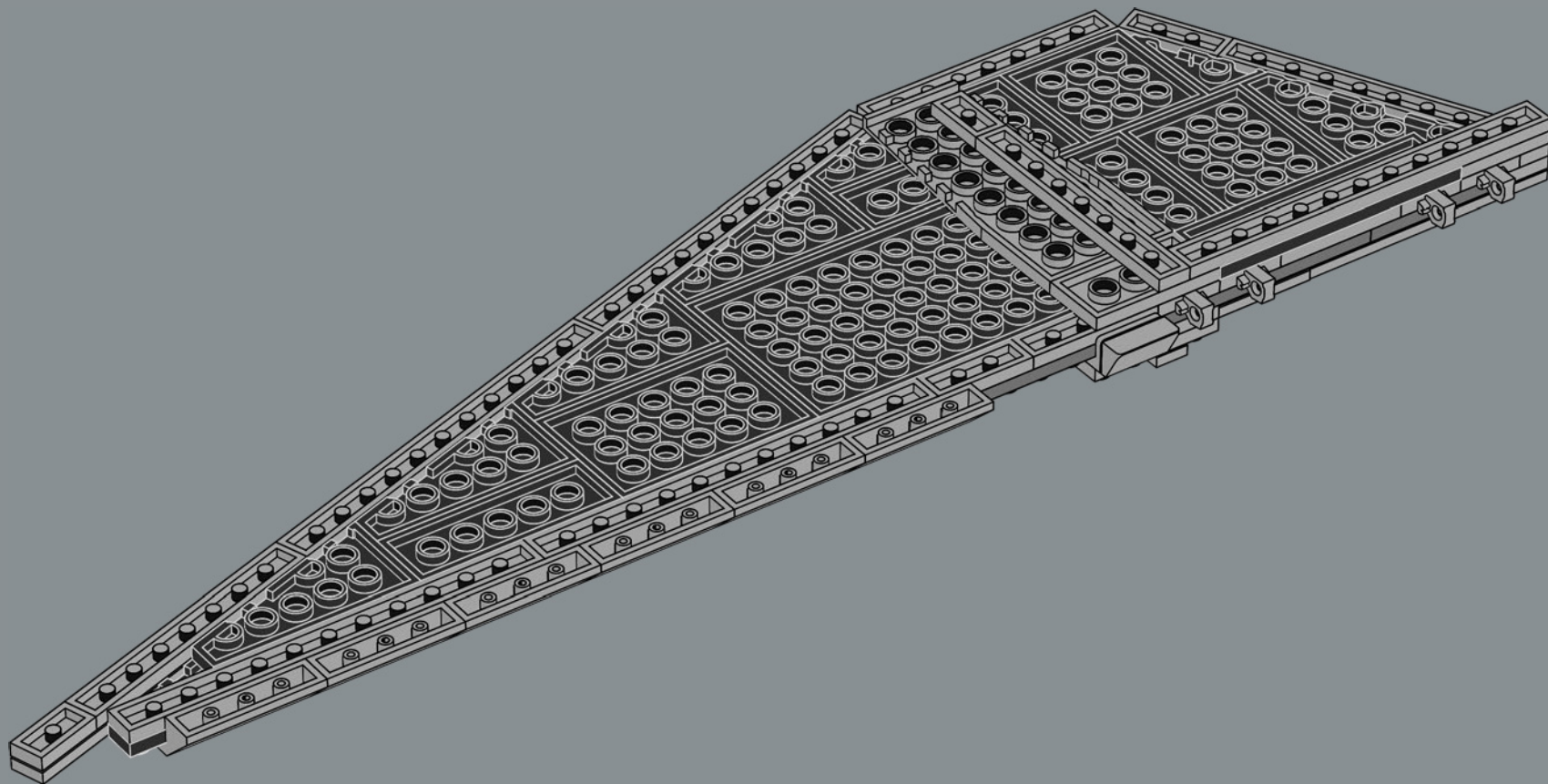

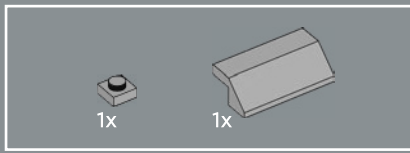

454

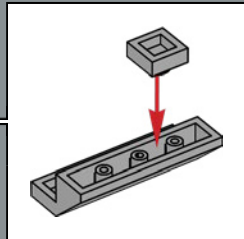
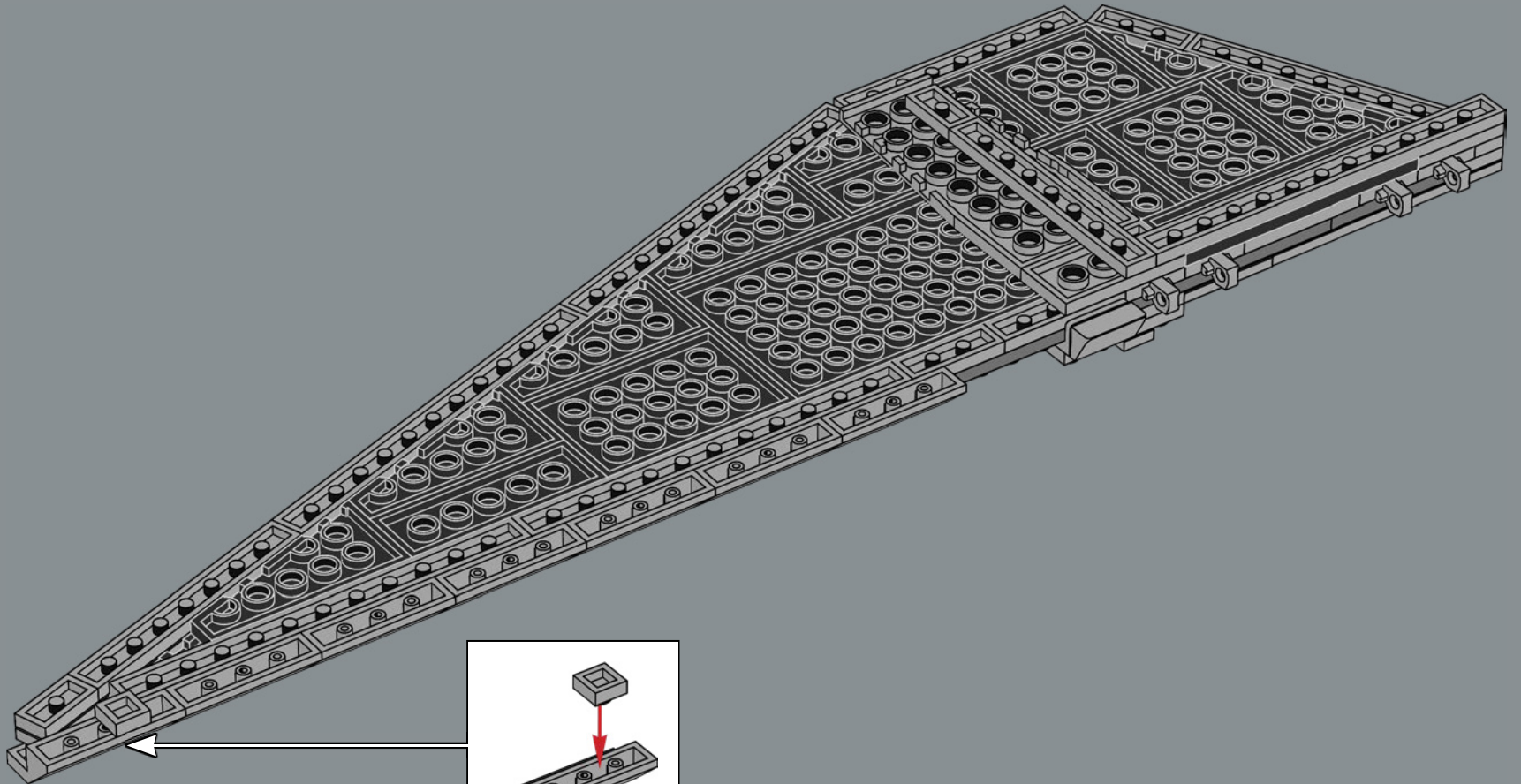



455

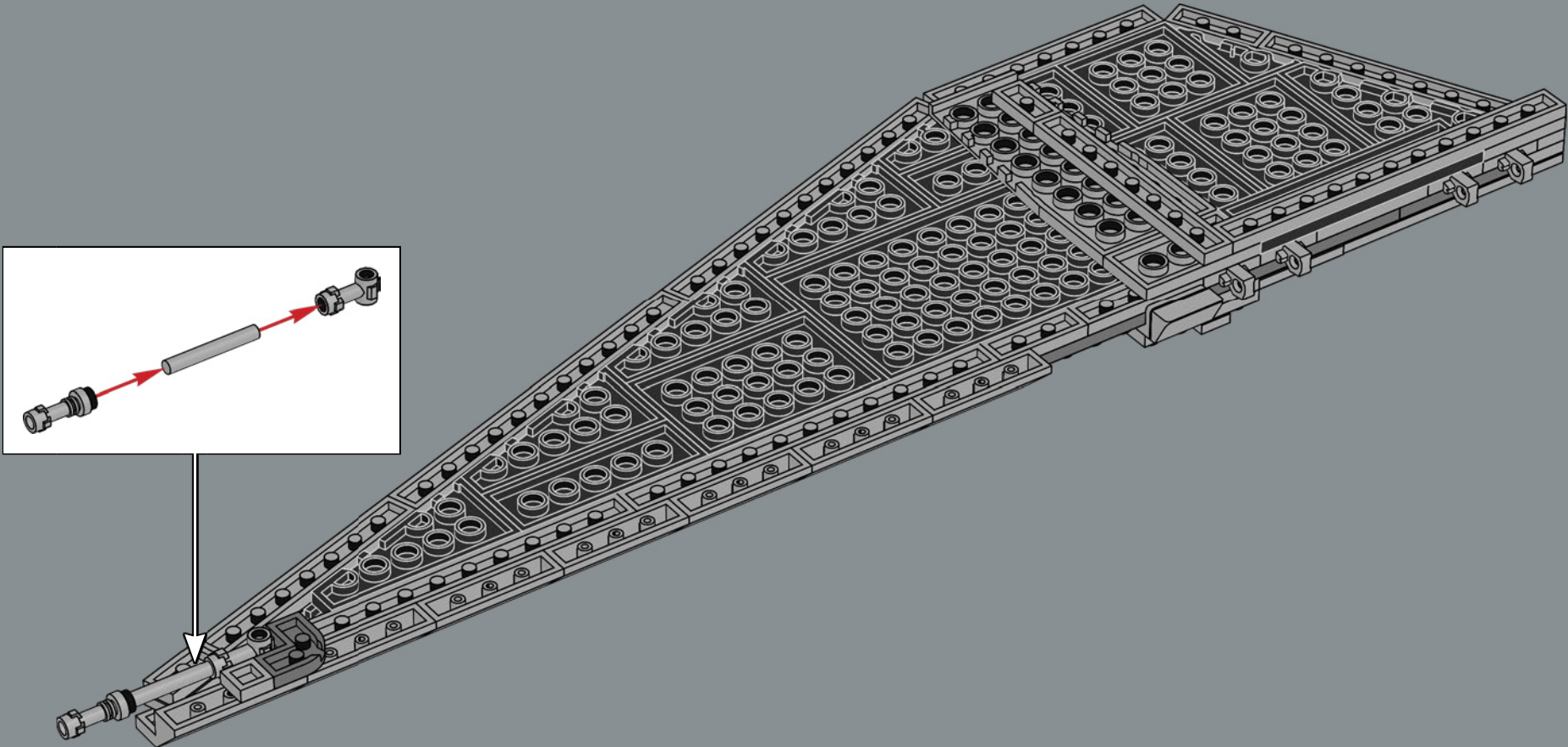



456

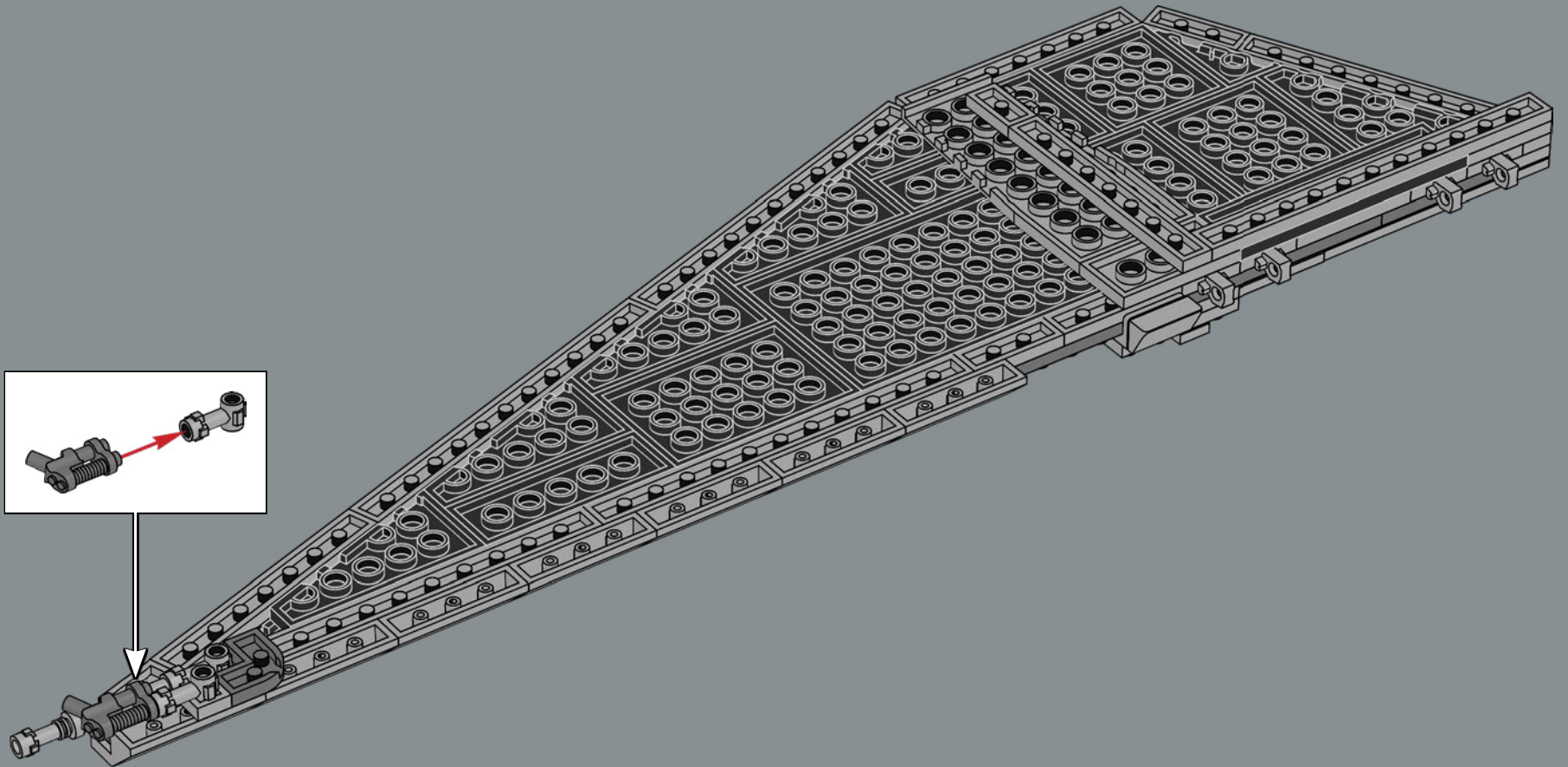



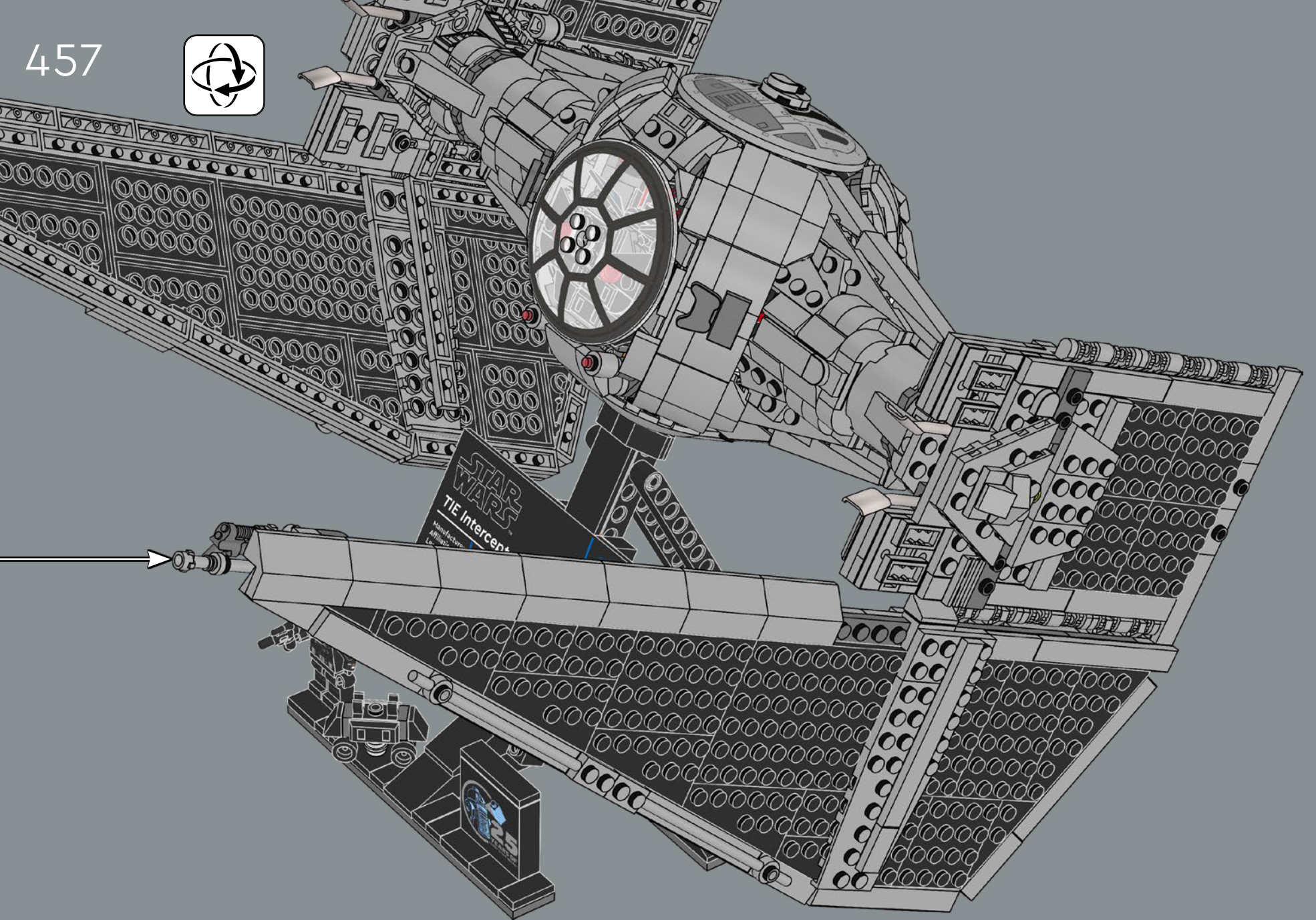



458

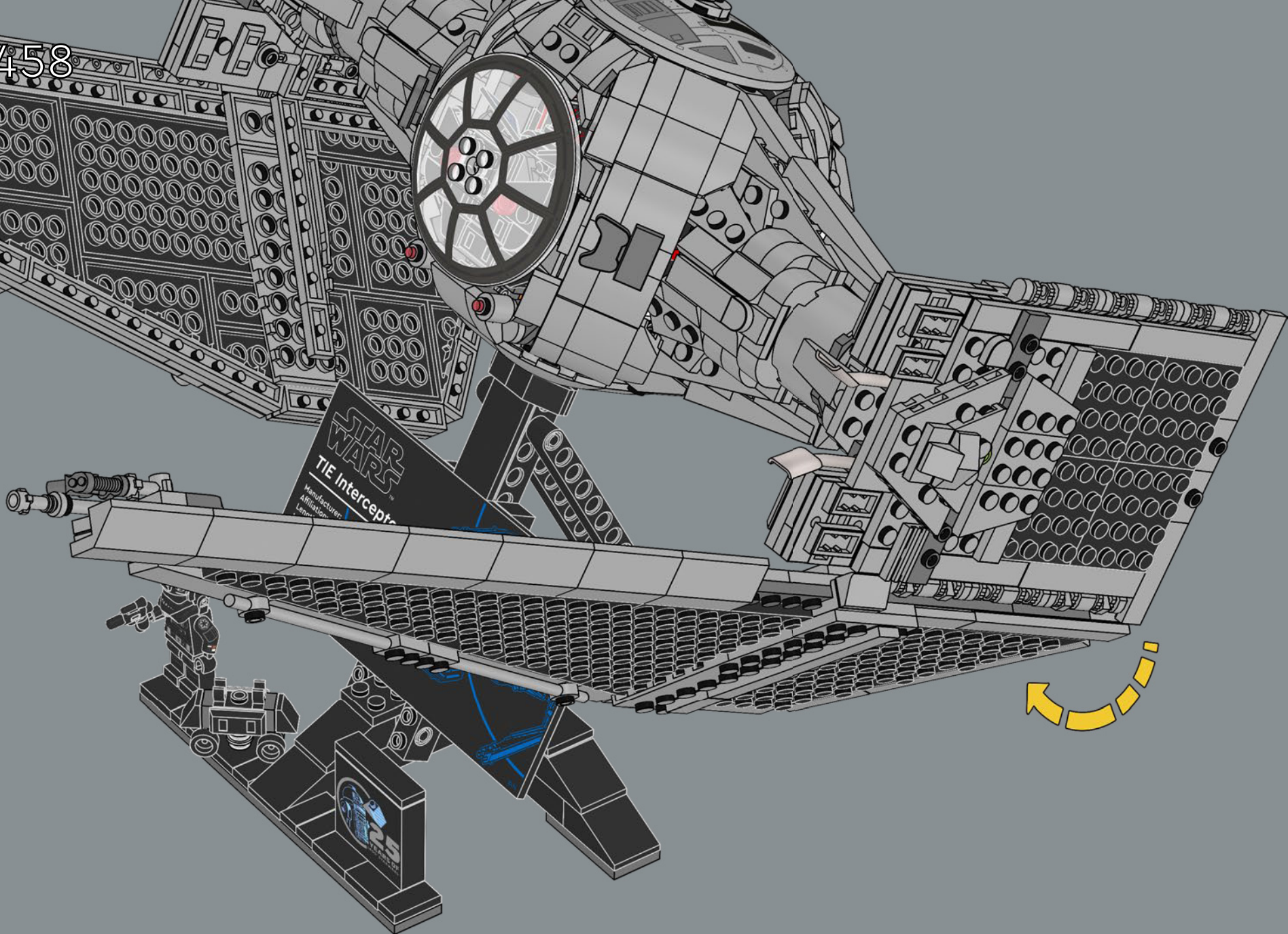



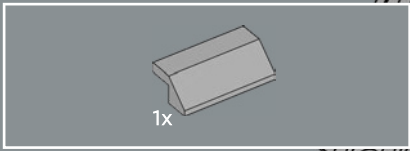

459

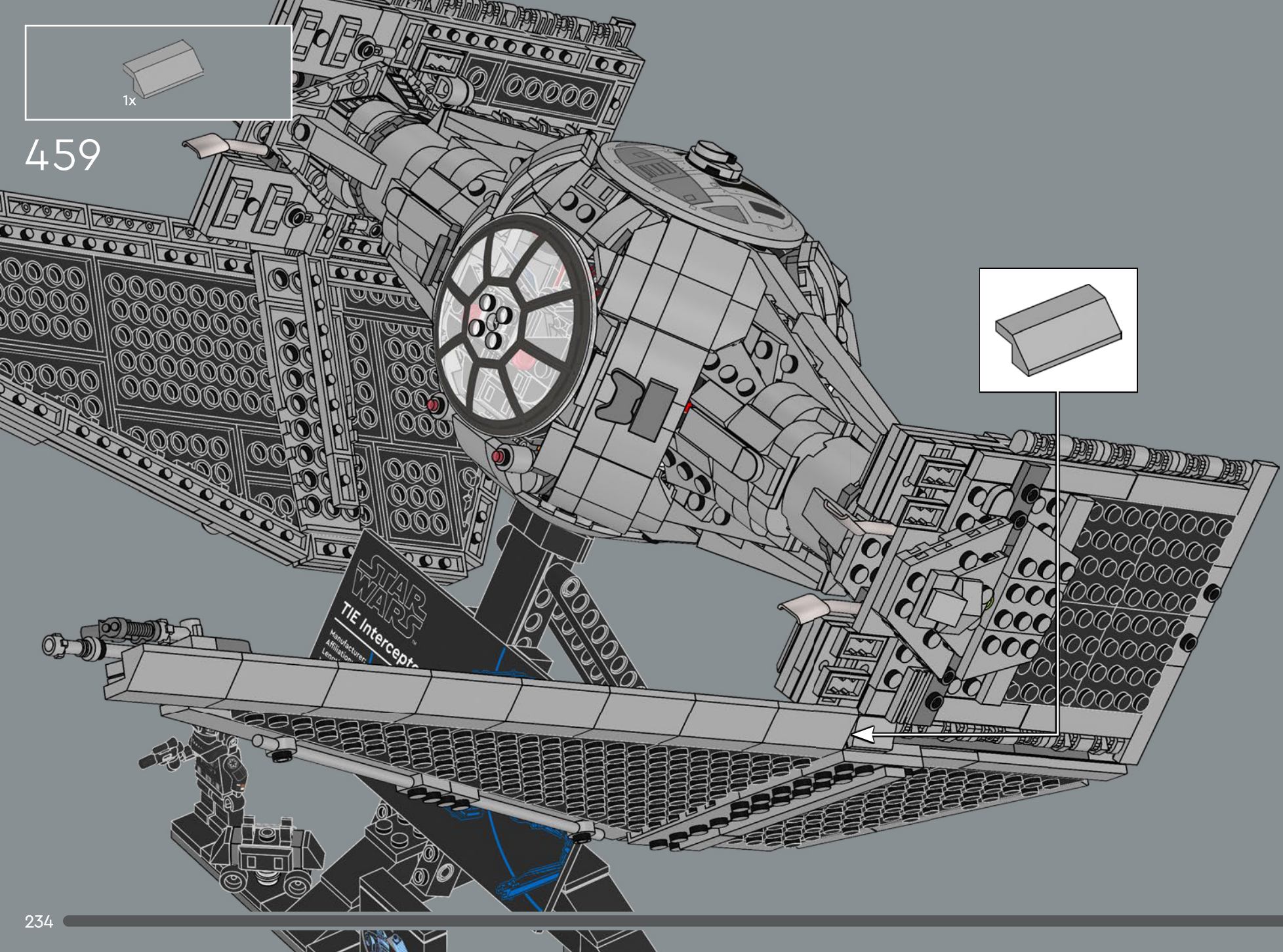
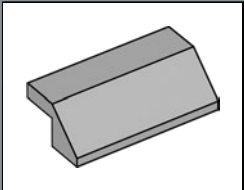

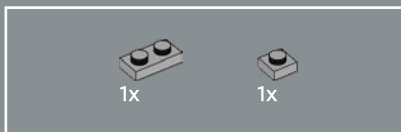
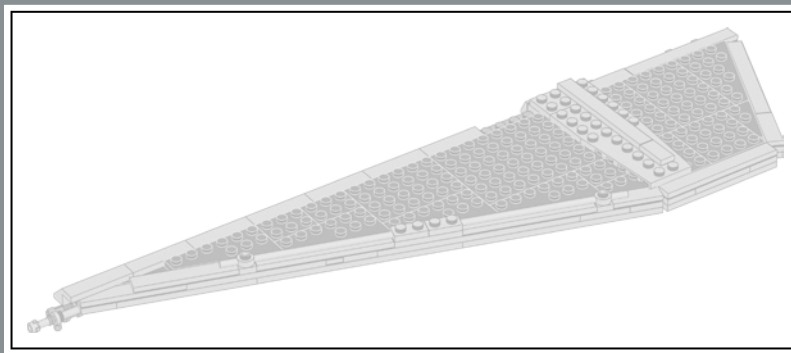

460

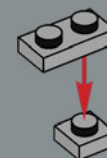





1x

461

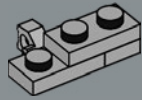

1x

462

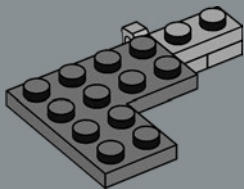

1x



1x

463

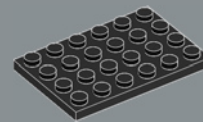
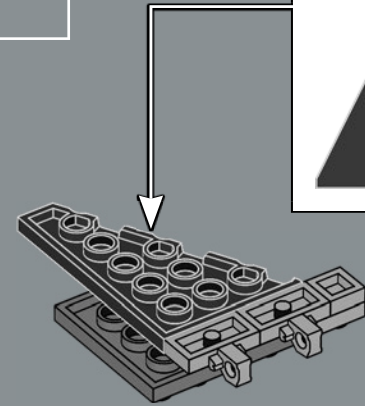

1x

464

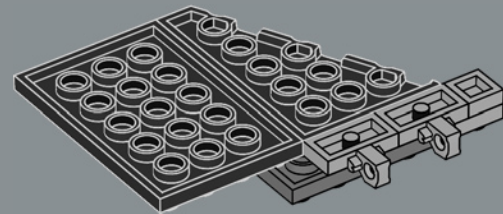

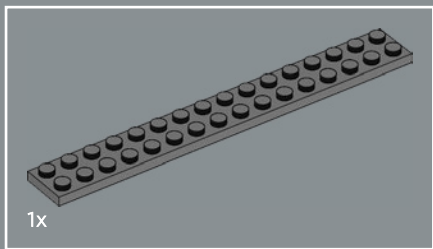

465

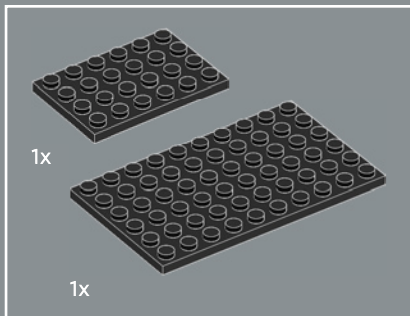
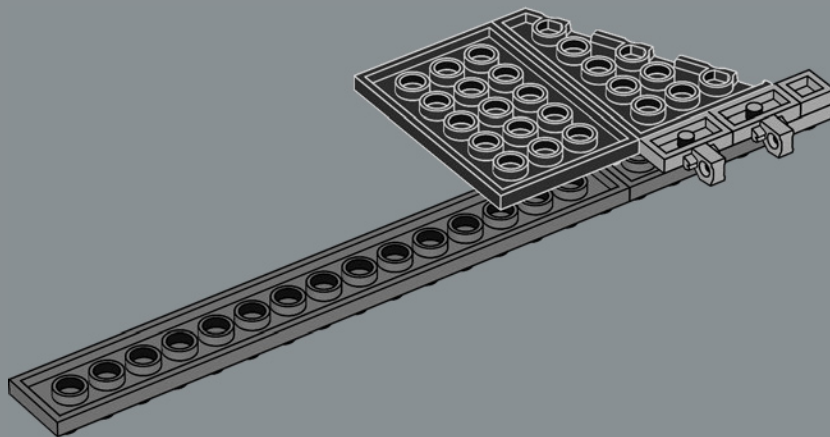

466

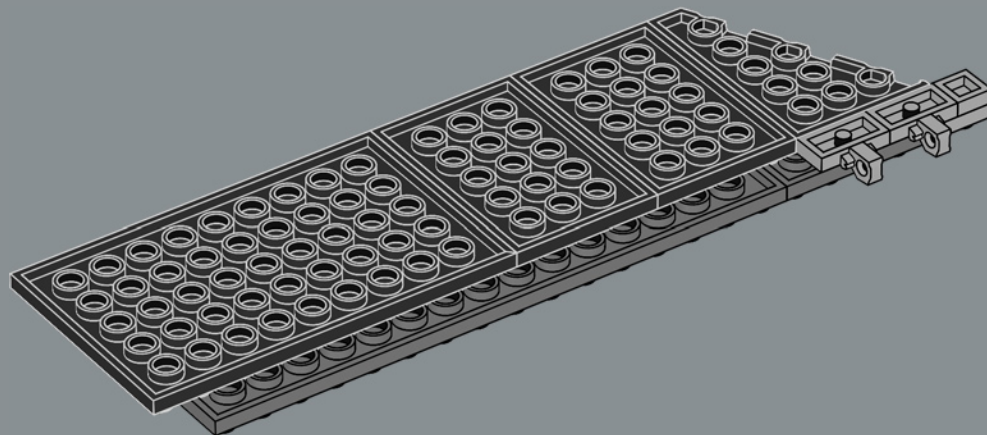

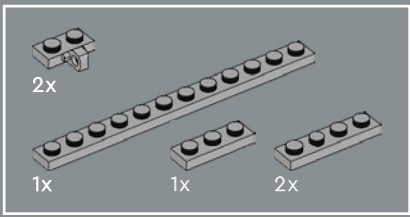

467

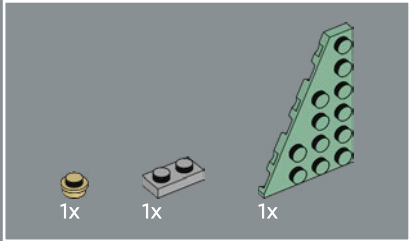
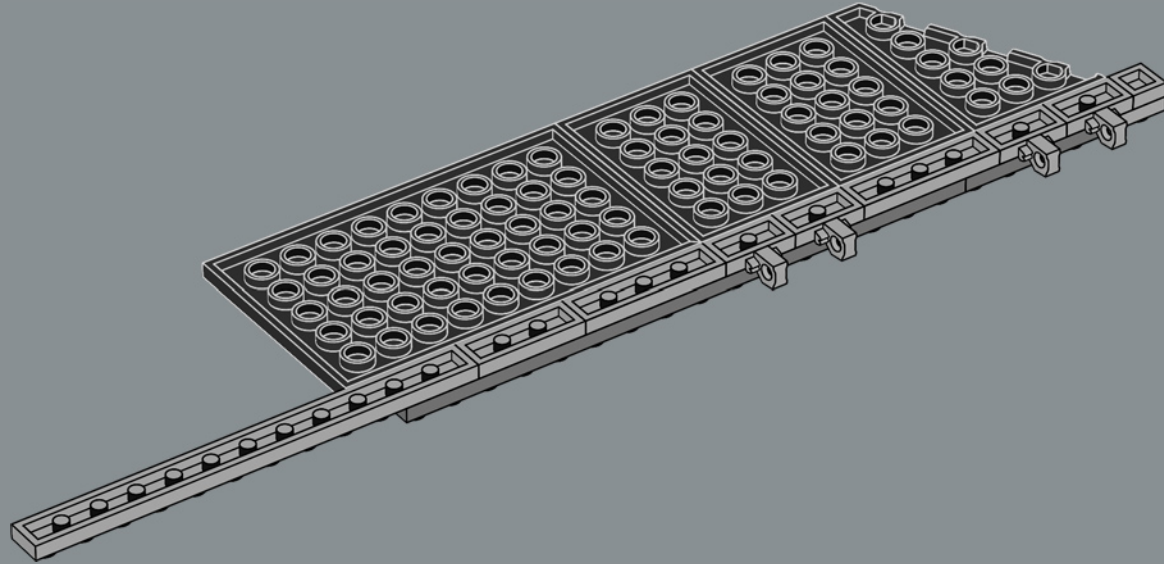

468

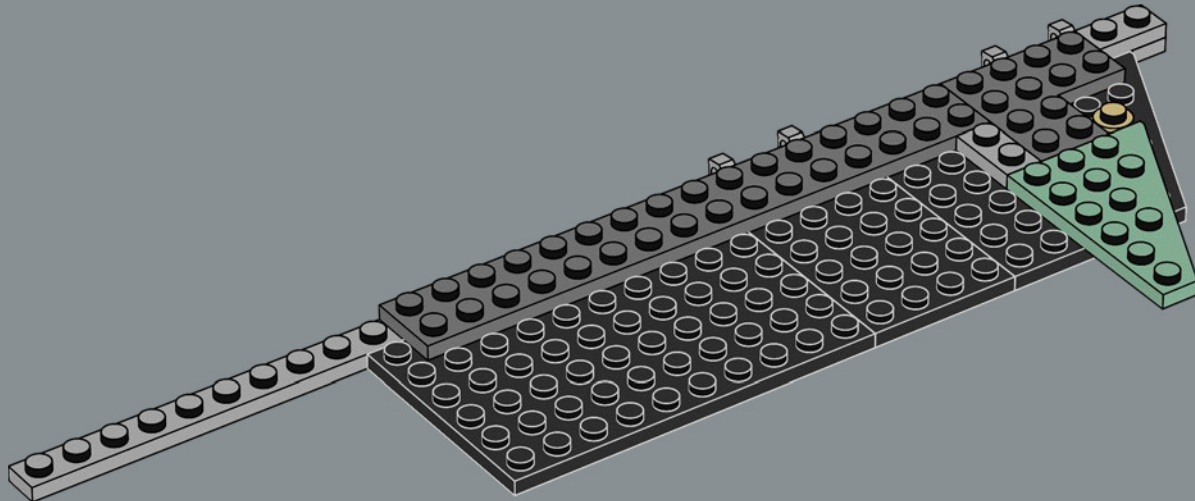

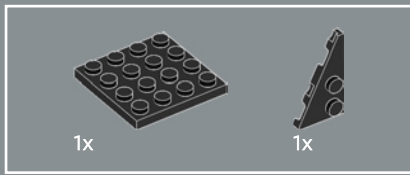

469

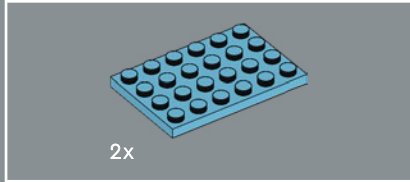
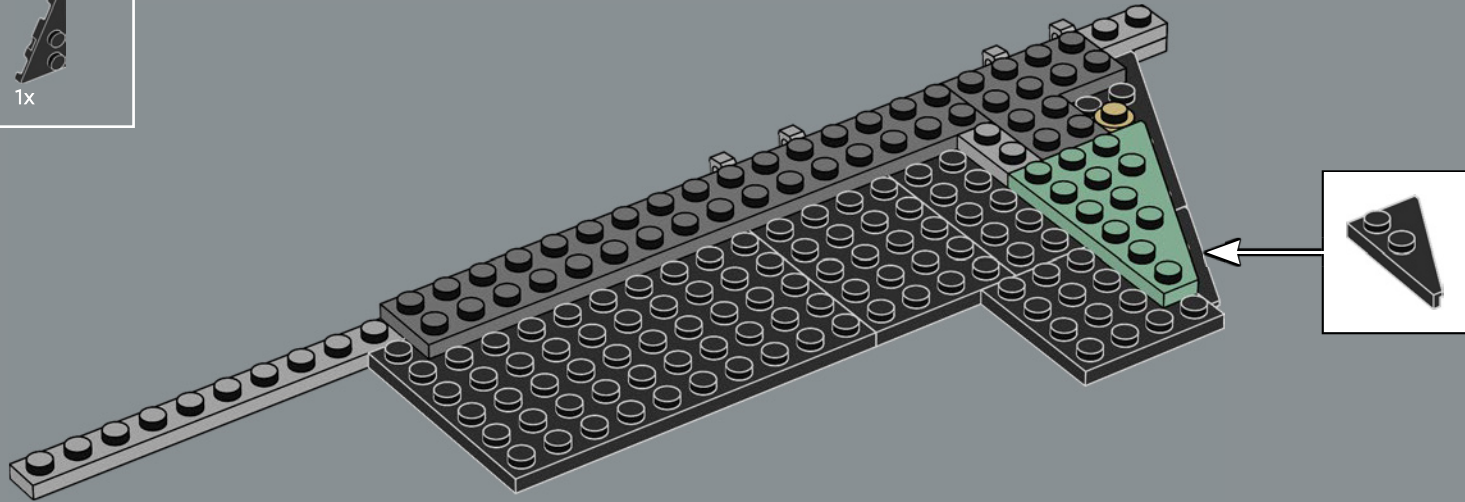

470

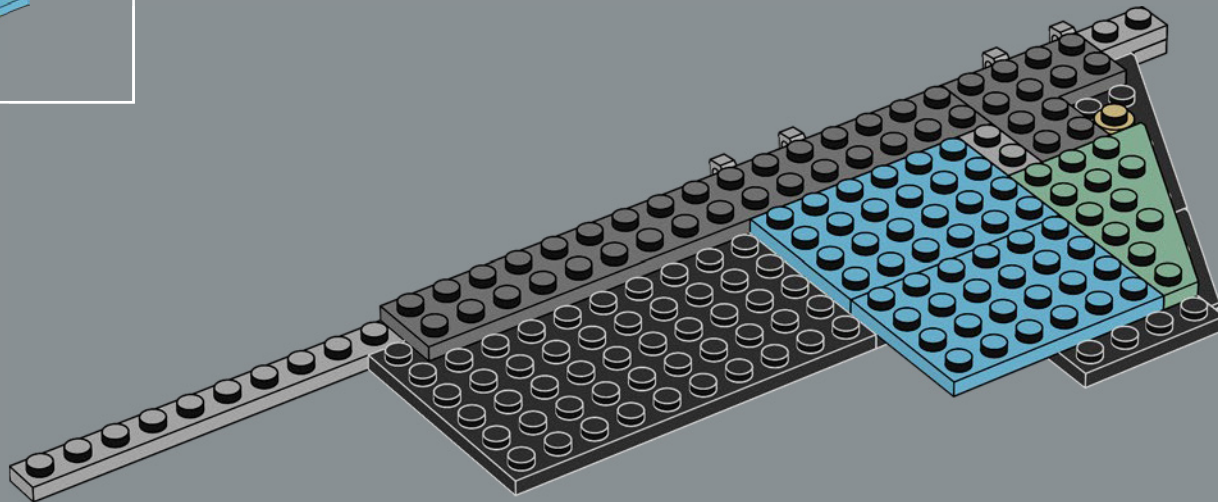



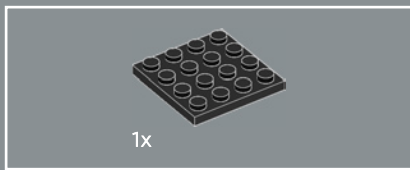

471

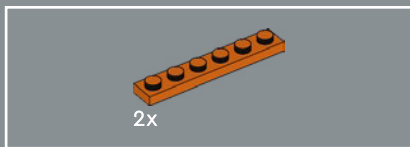
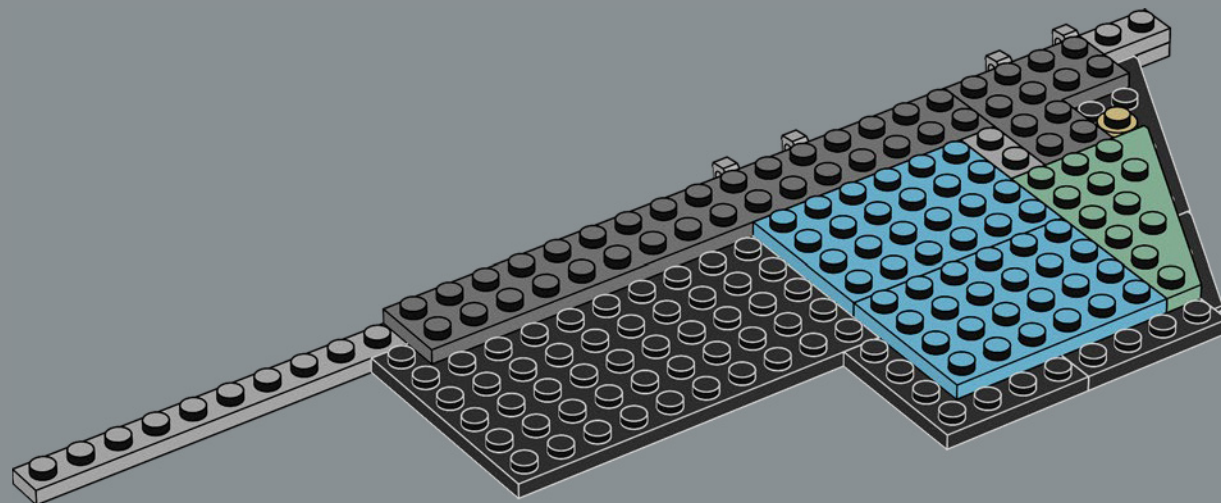

472

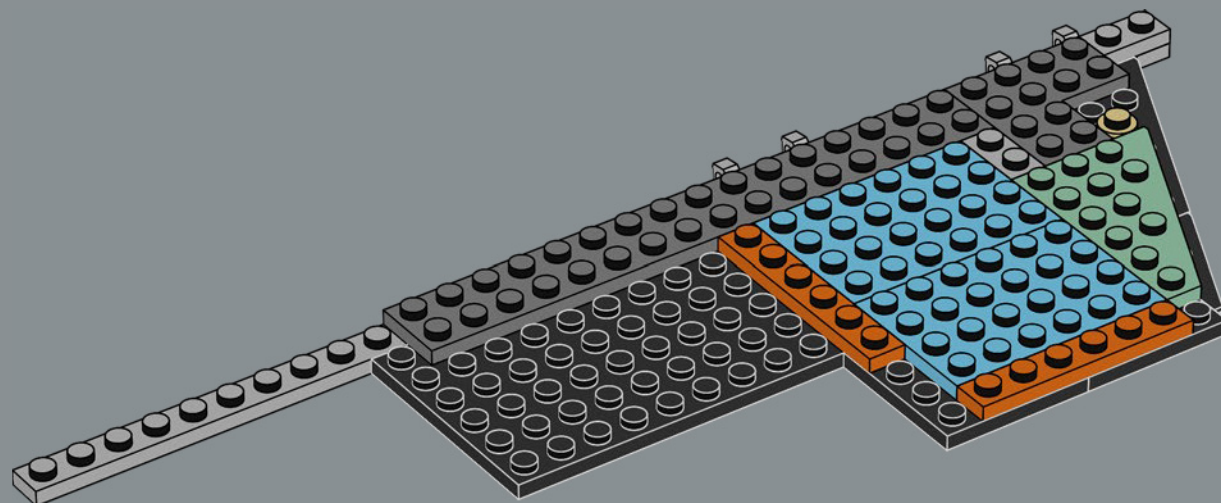

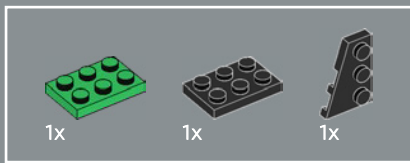

473

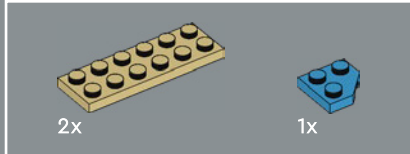
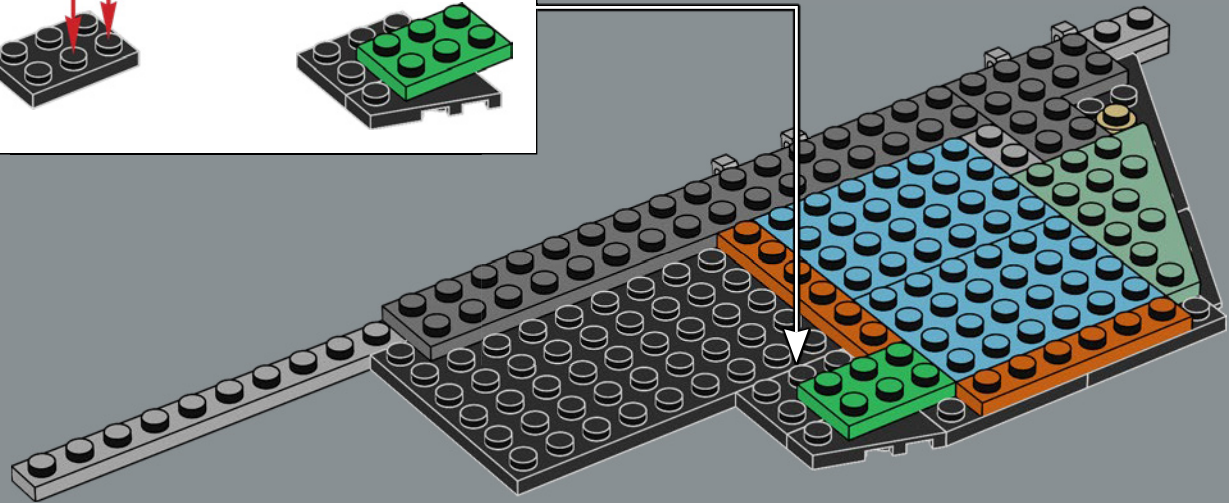
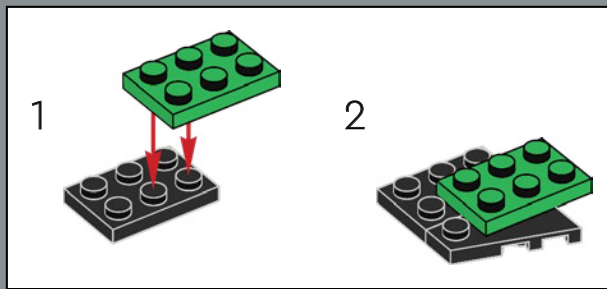

474

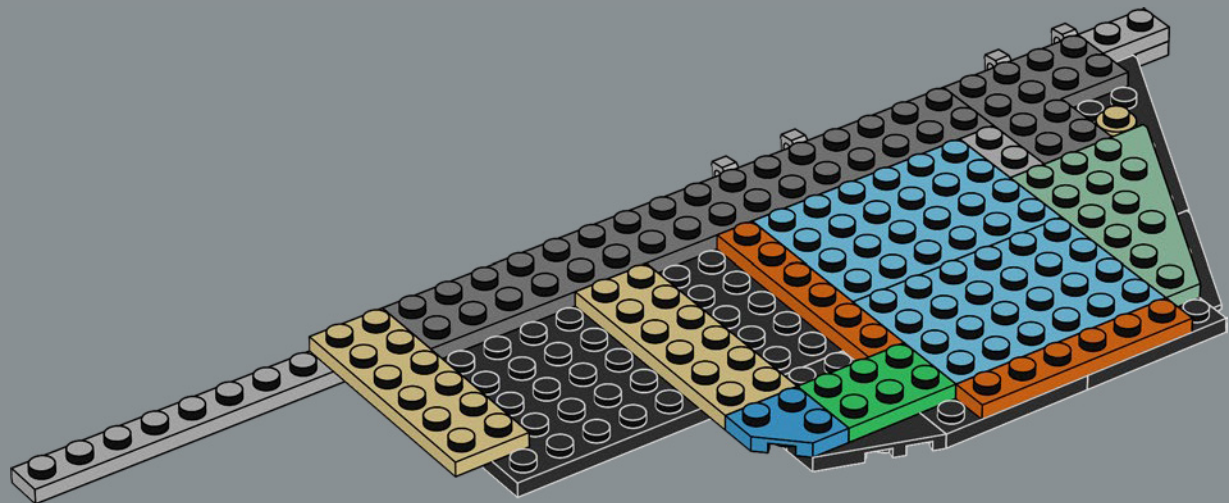

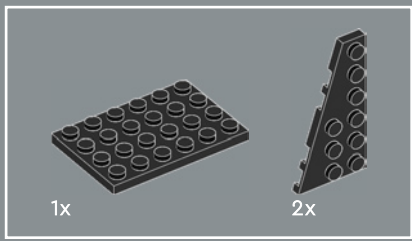

475

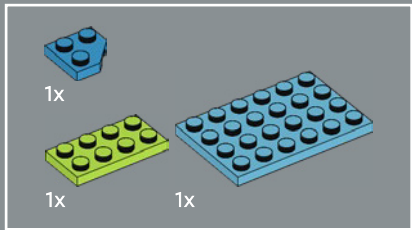
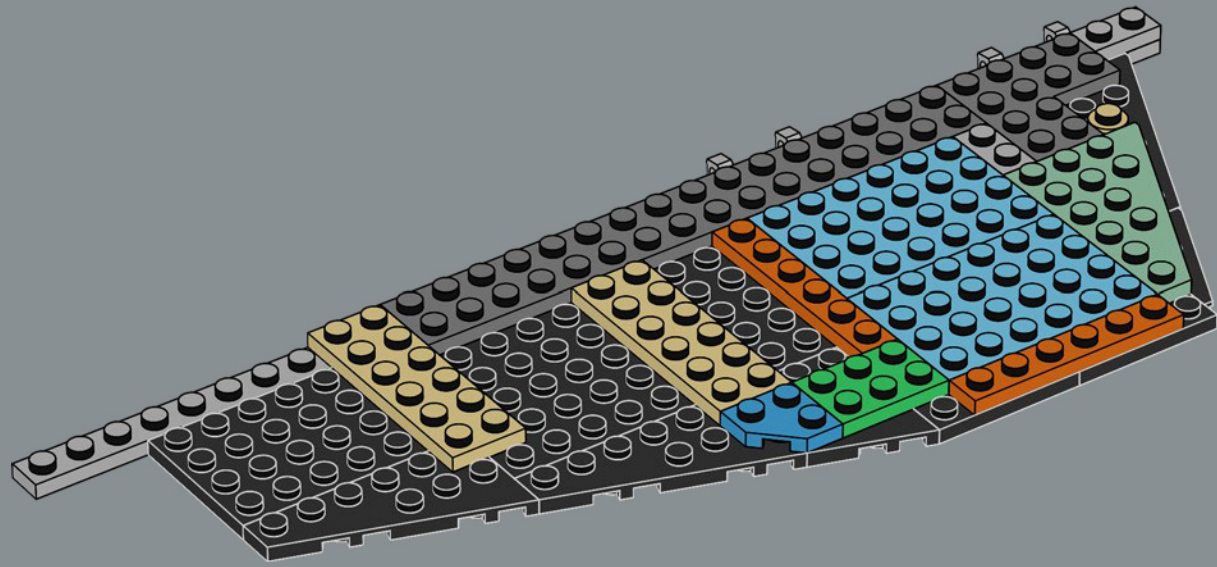

476

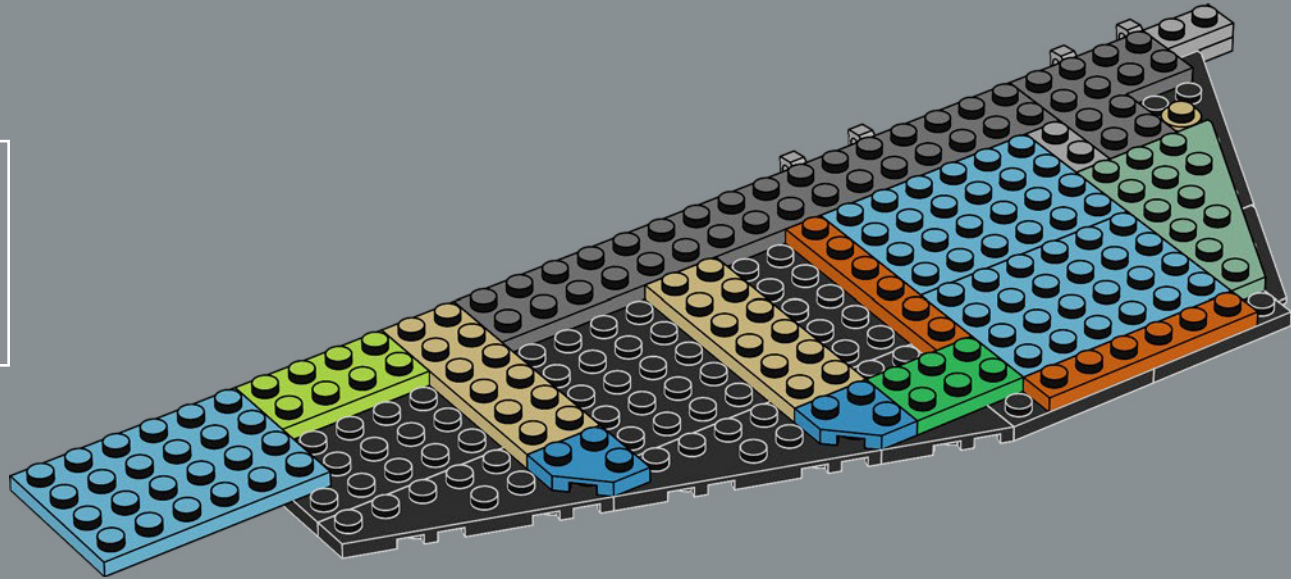



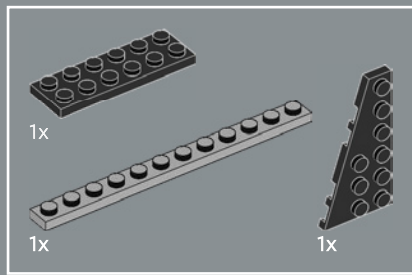

477

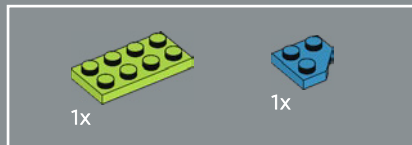
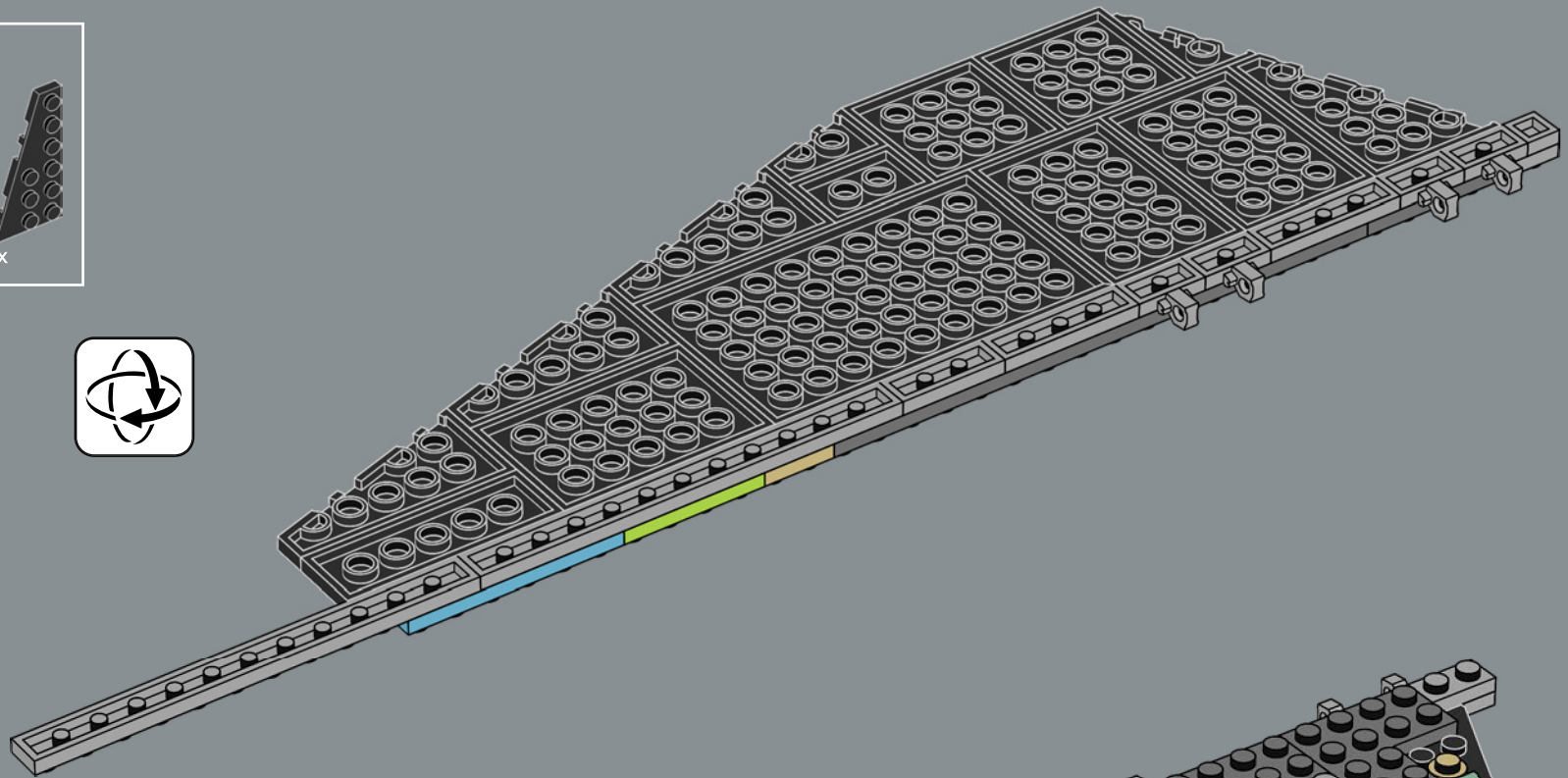

478

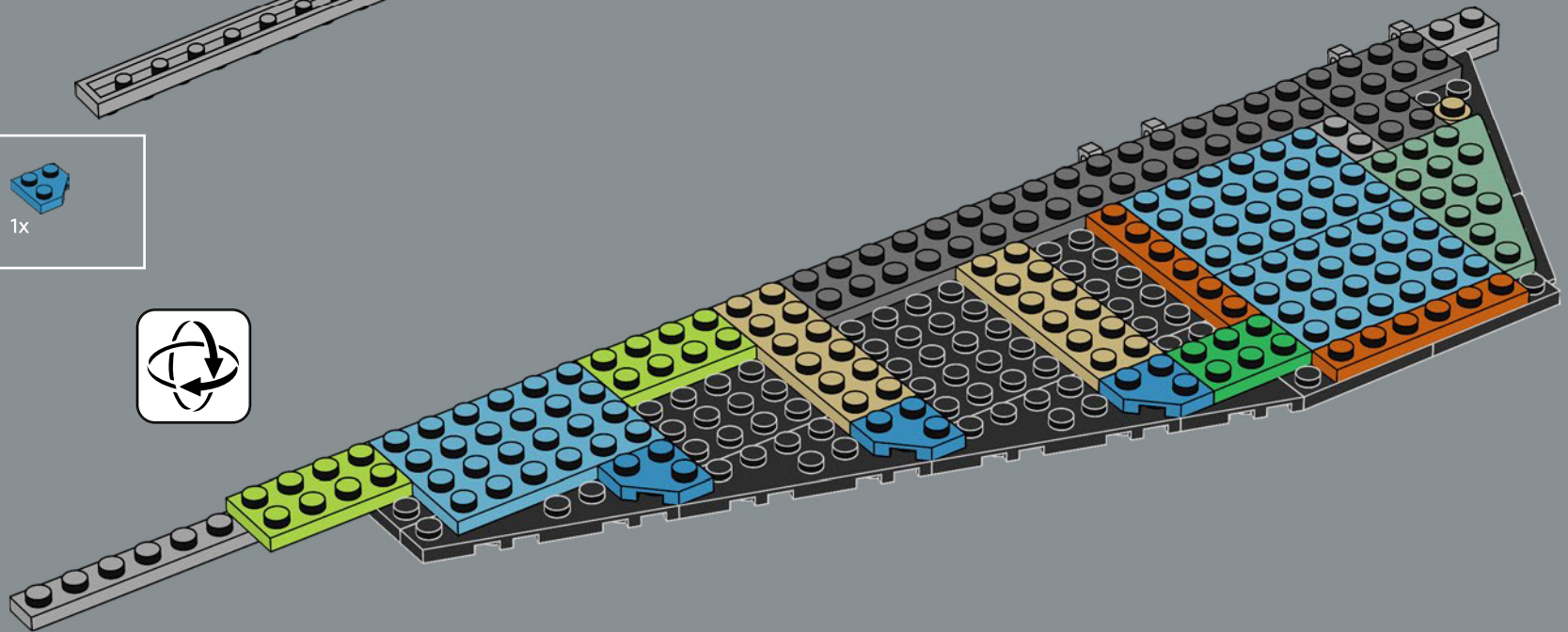



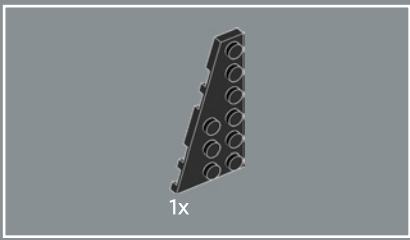

479

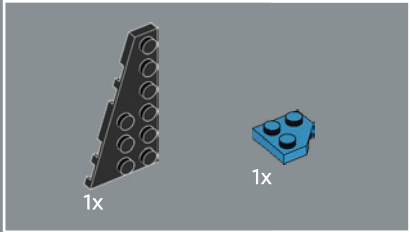
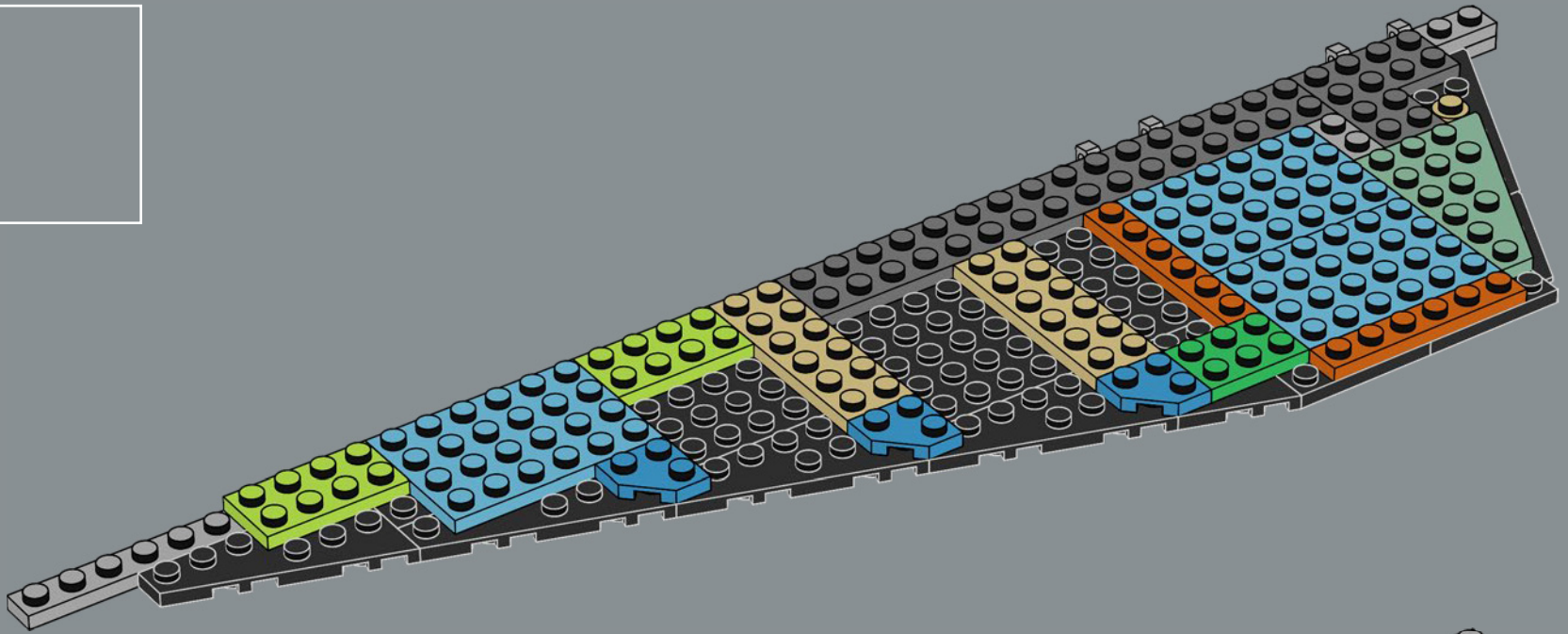

480

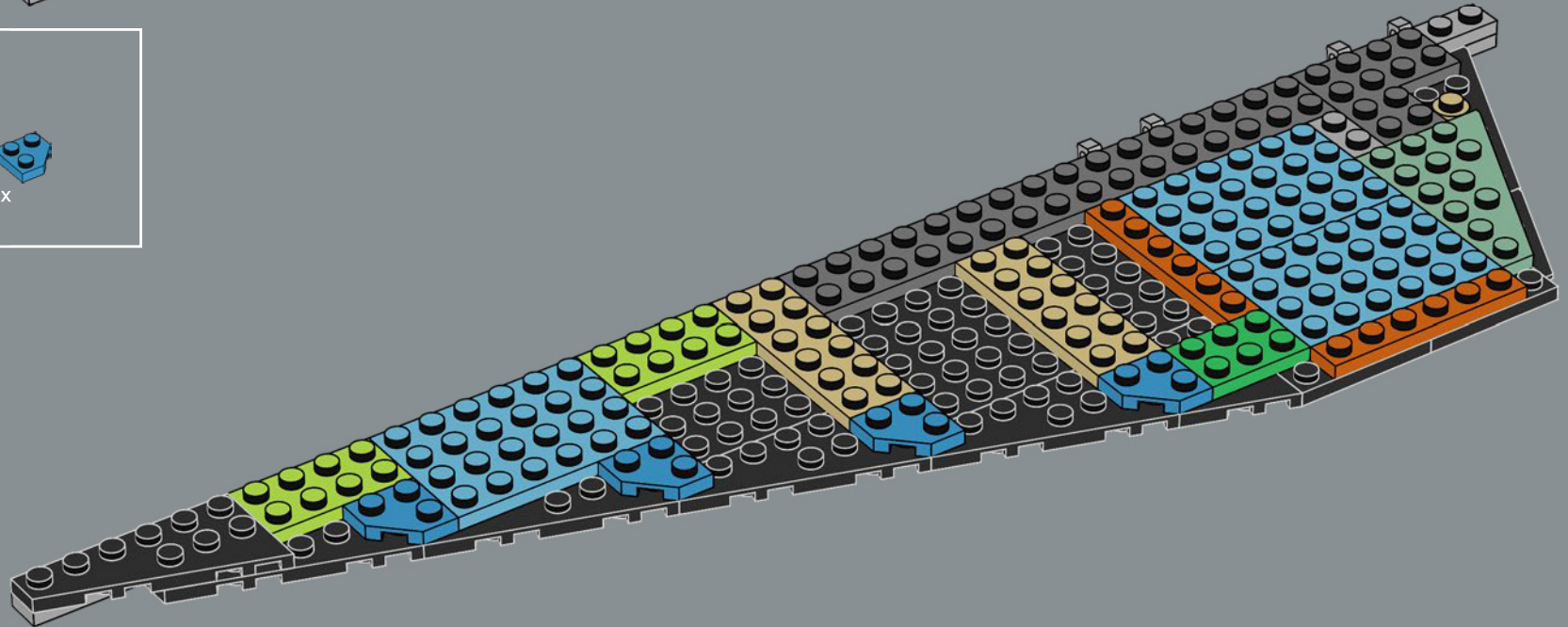

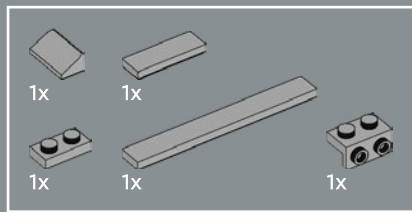

481

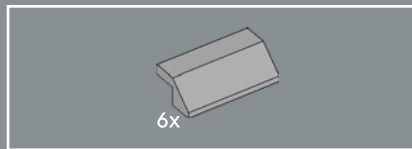
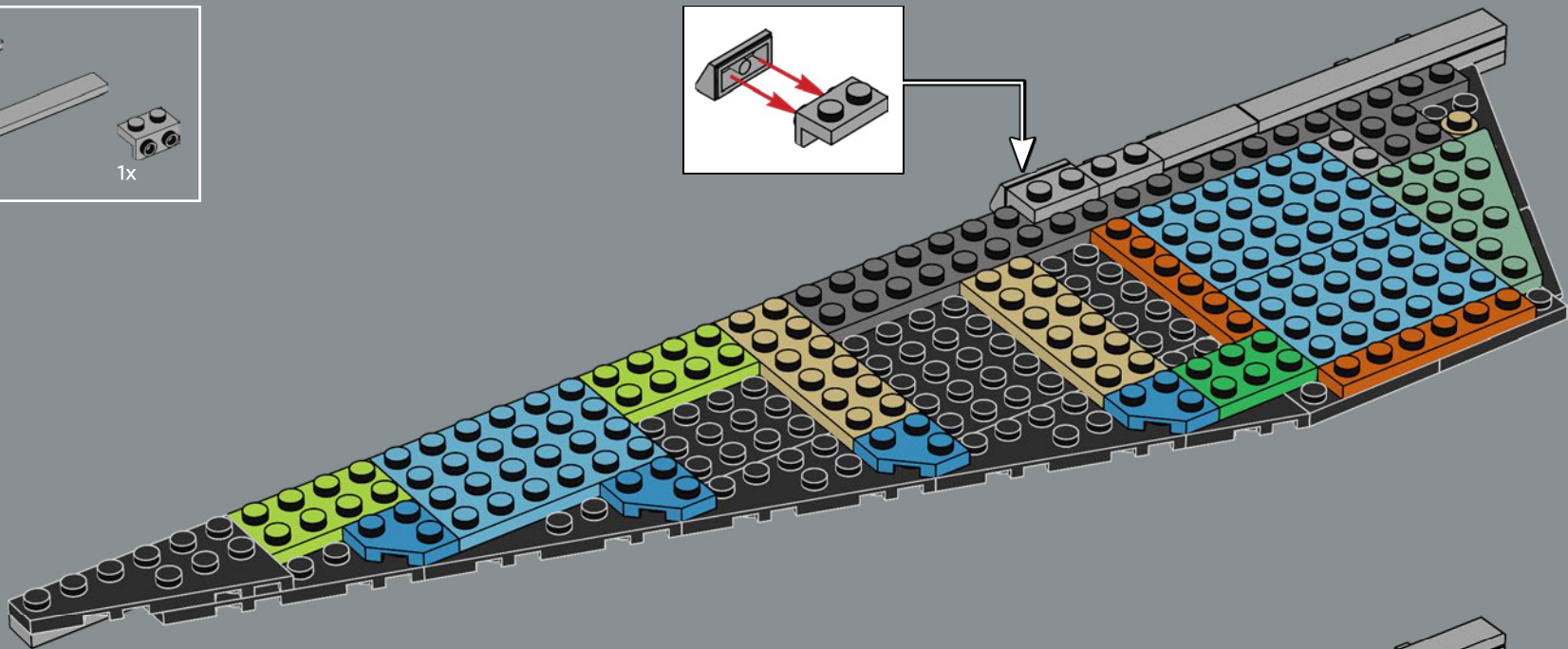
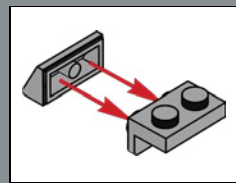

482

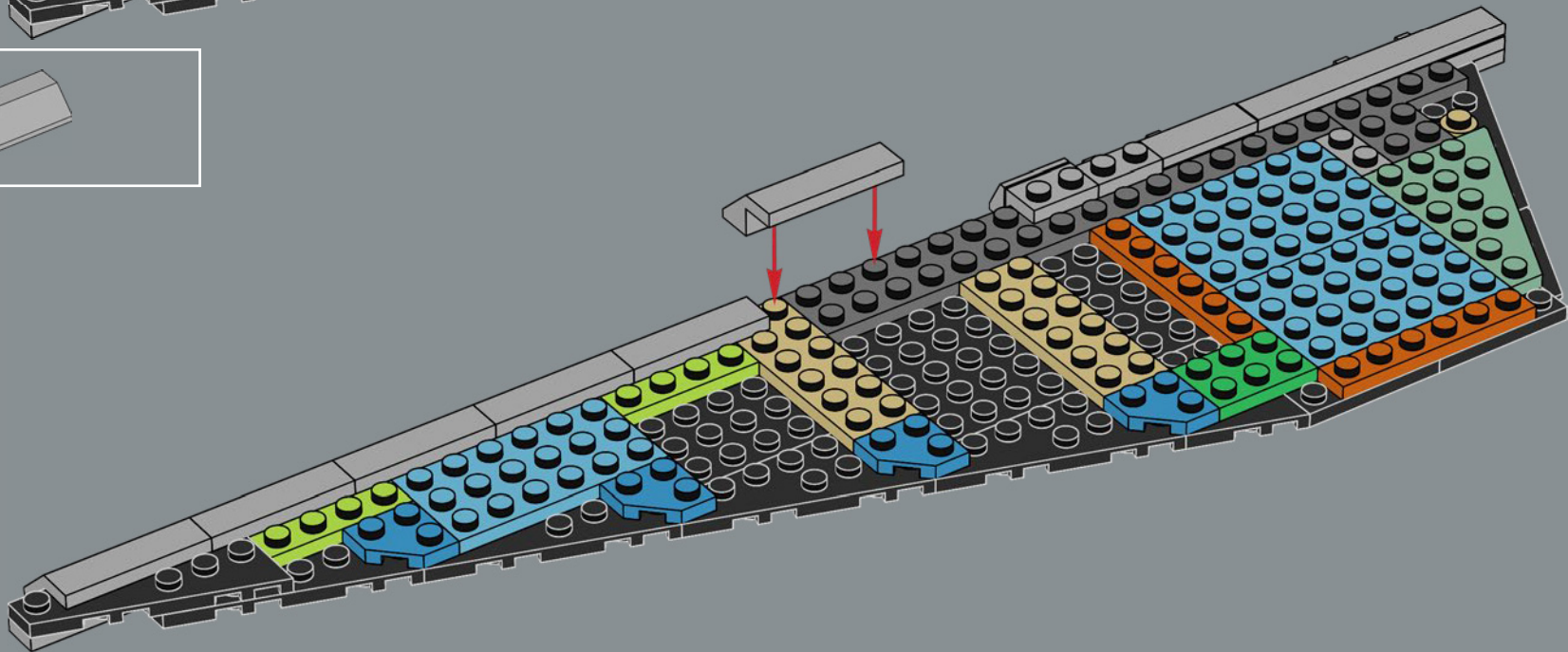

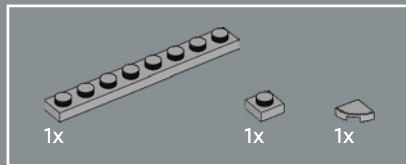
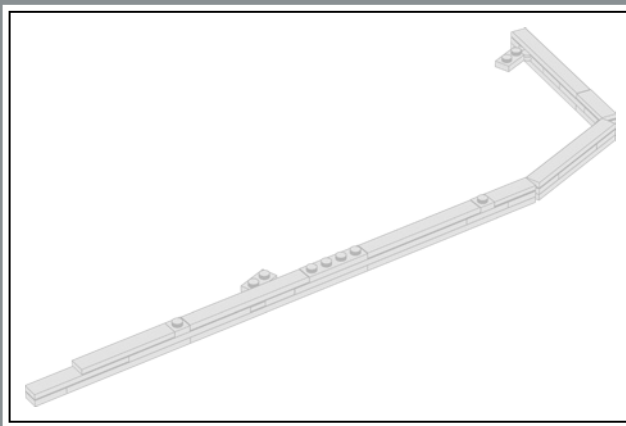

483

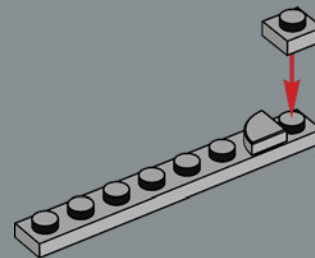

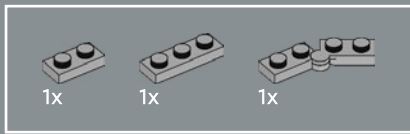

484

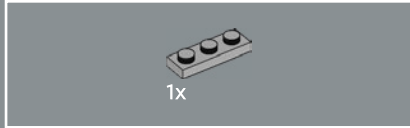
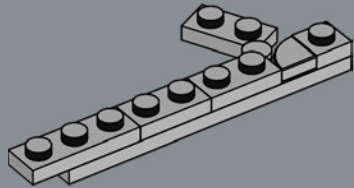

485

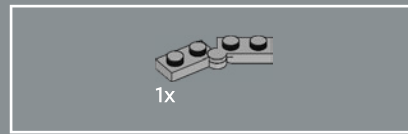
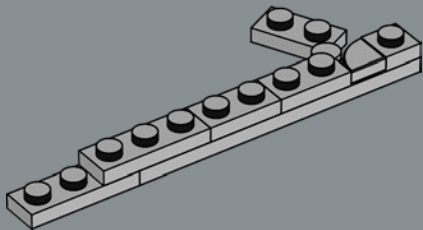

486

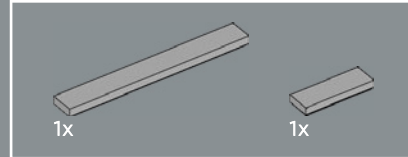
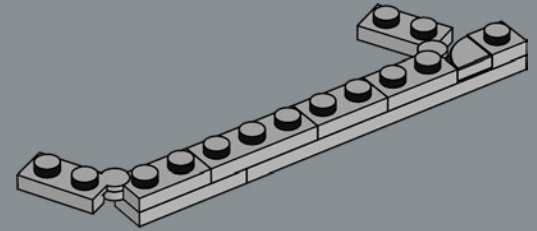

487

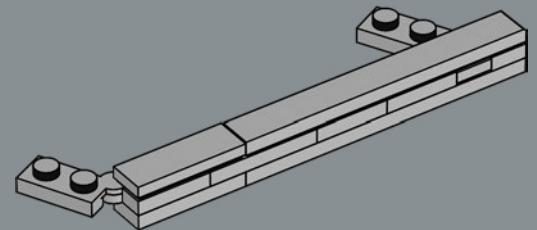



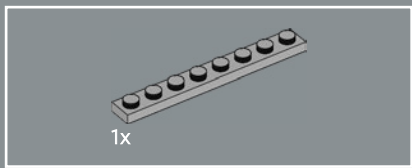

488

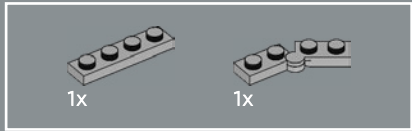
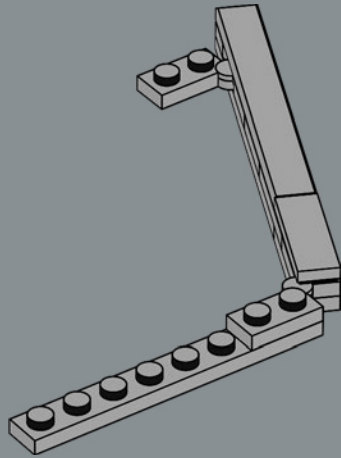

489

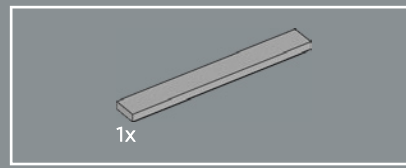
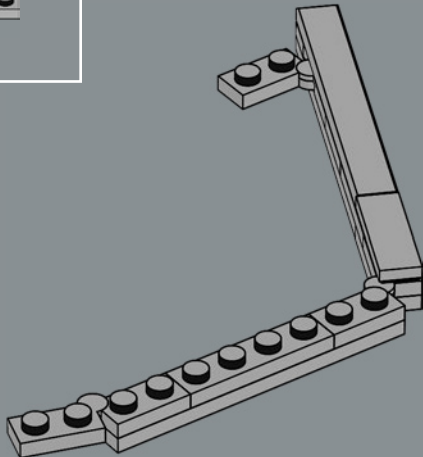

490

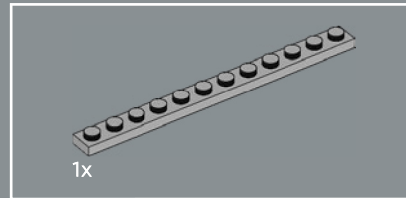
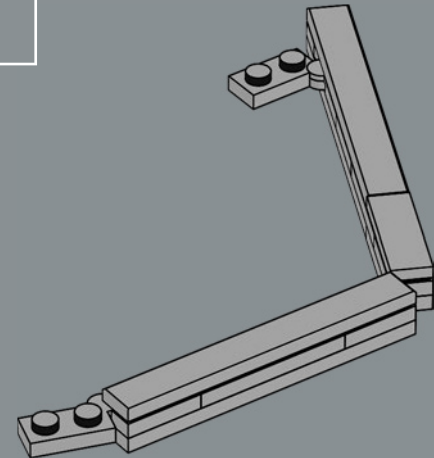

491

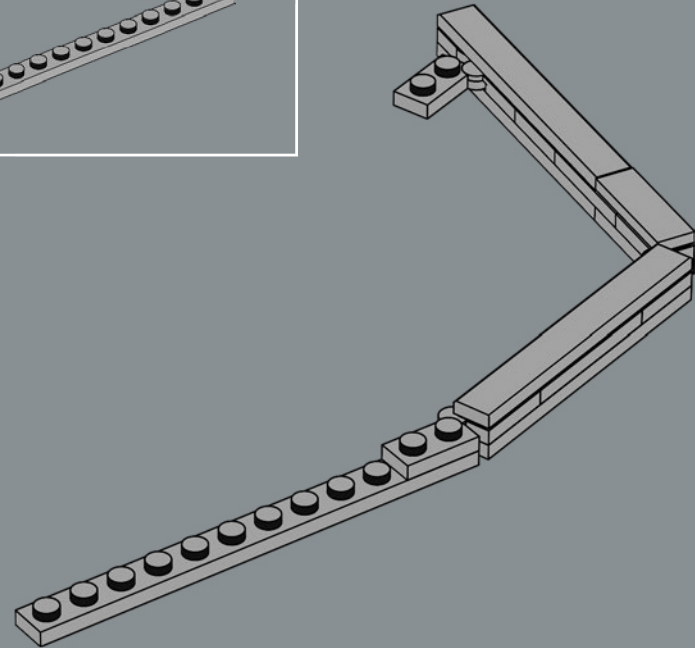

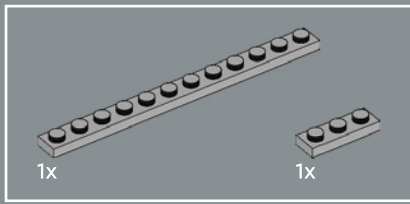

492

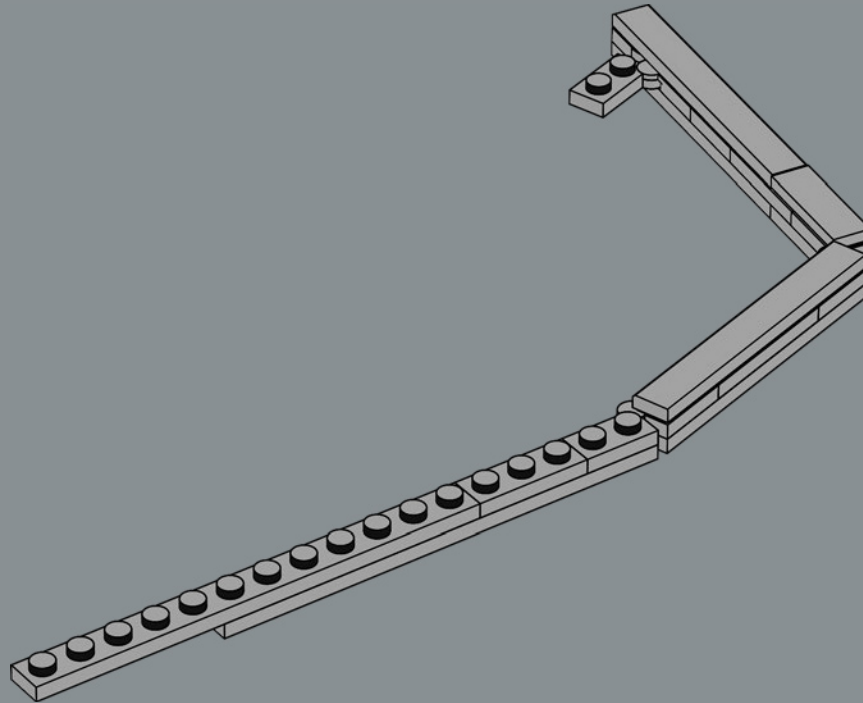

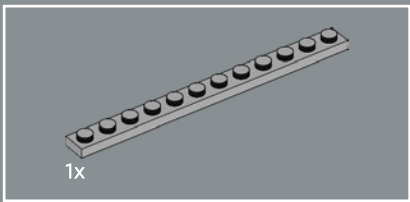

493

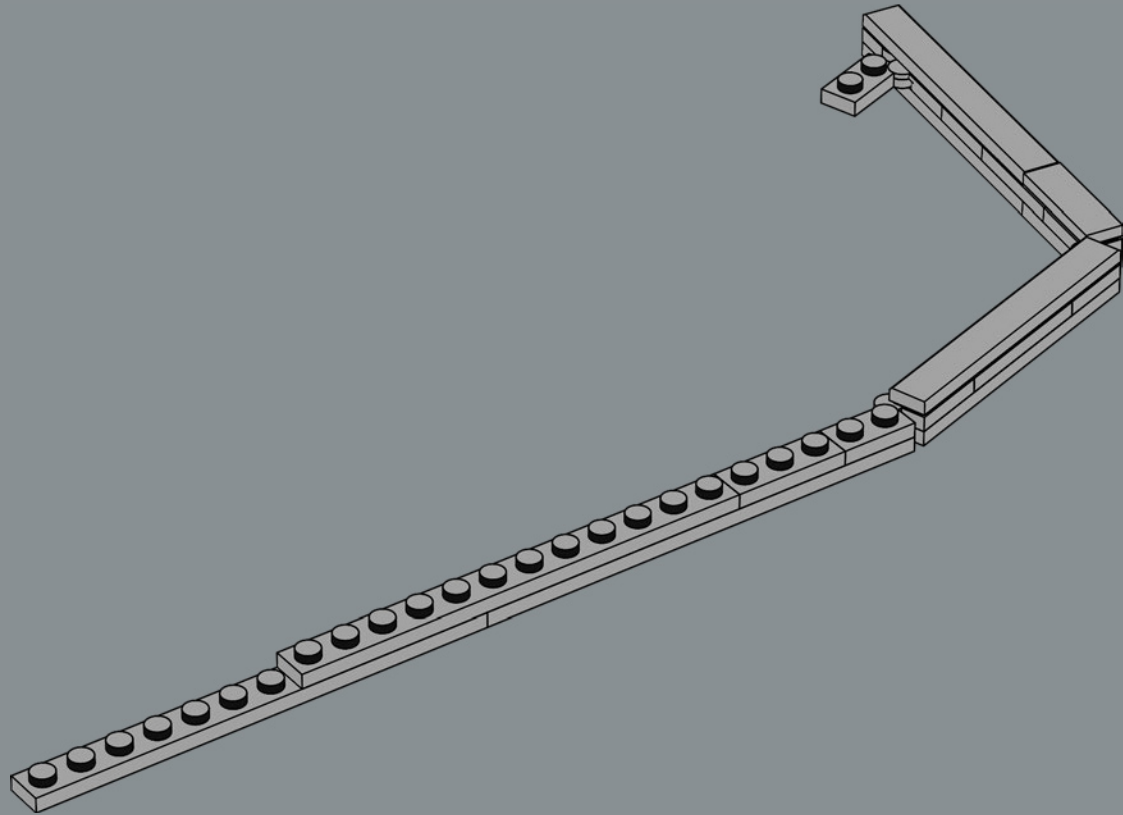

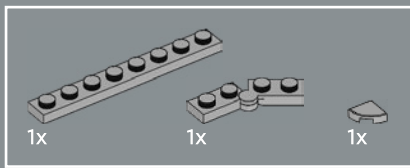

494

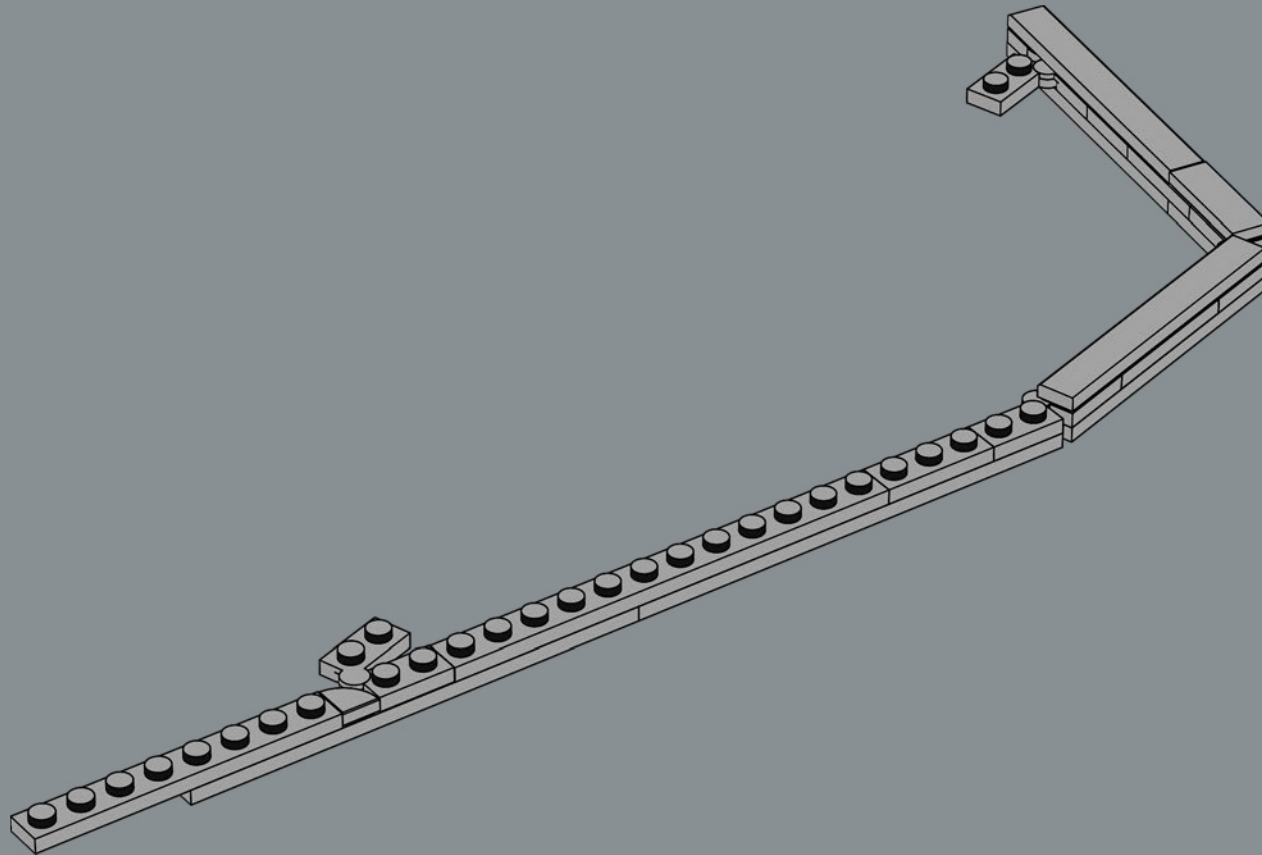



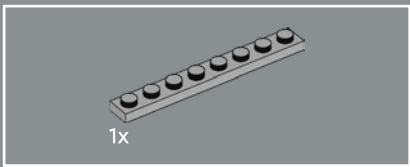

495

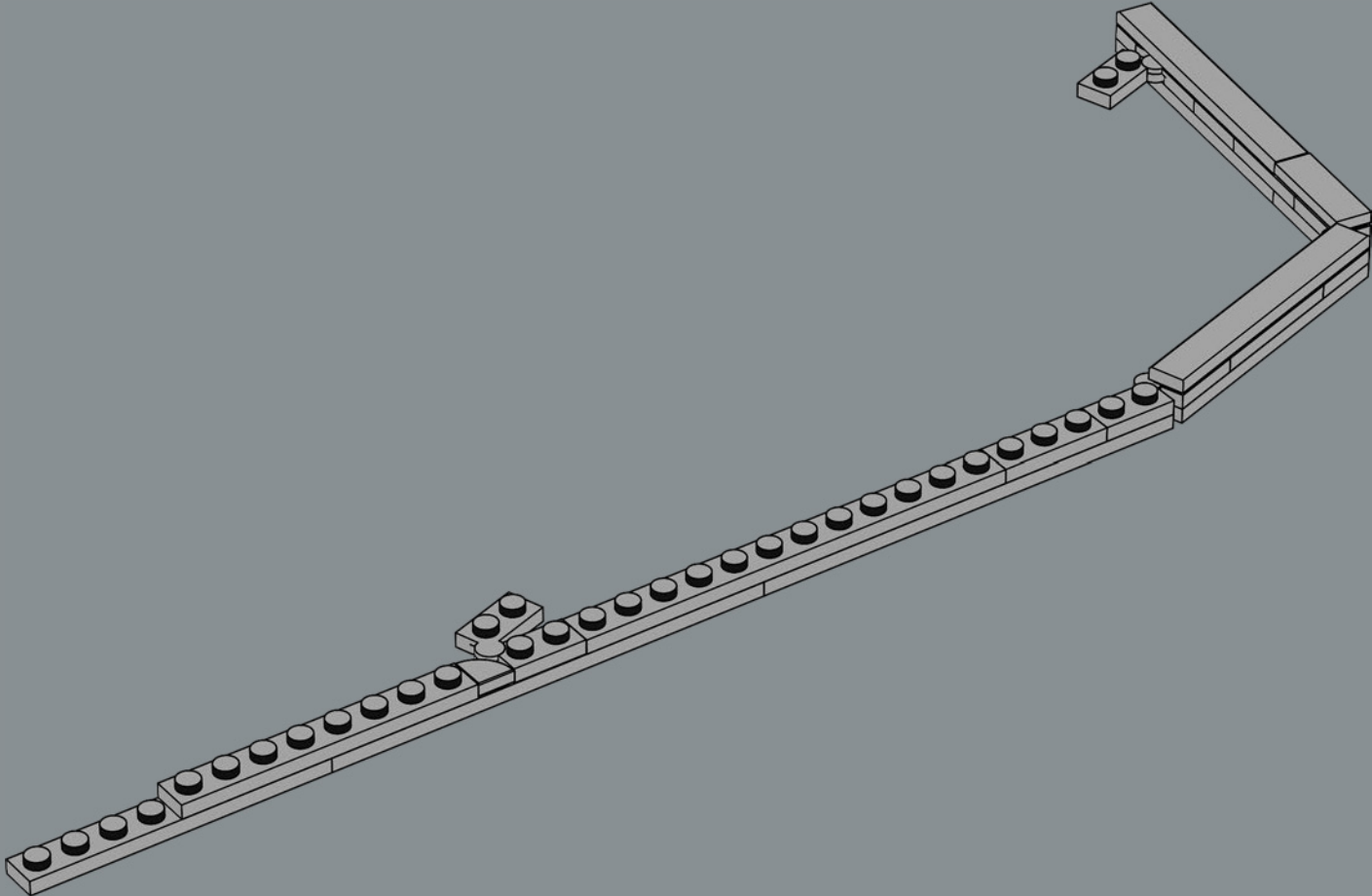

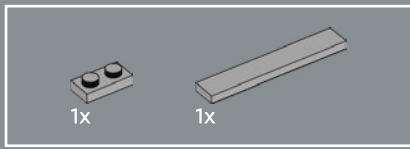

496

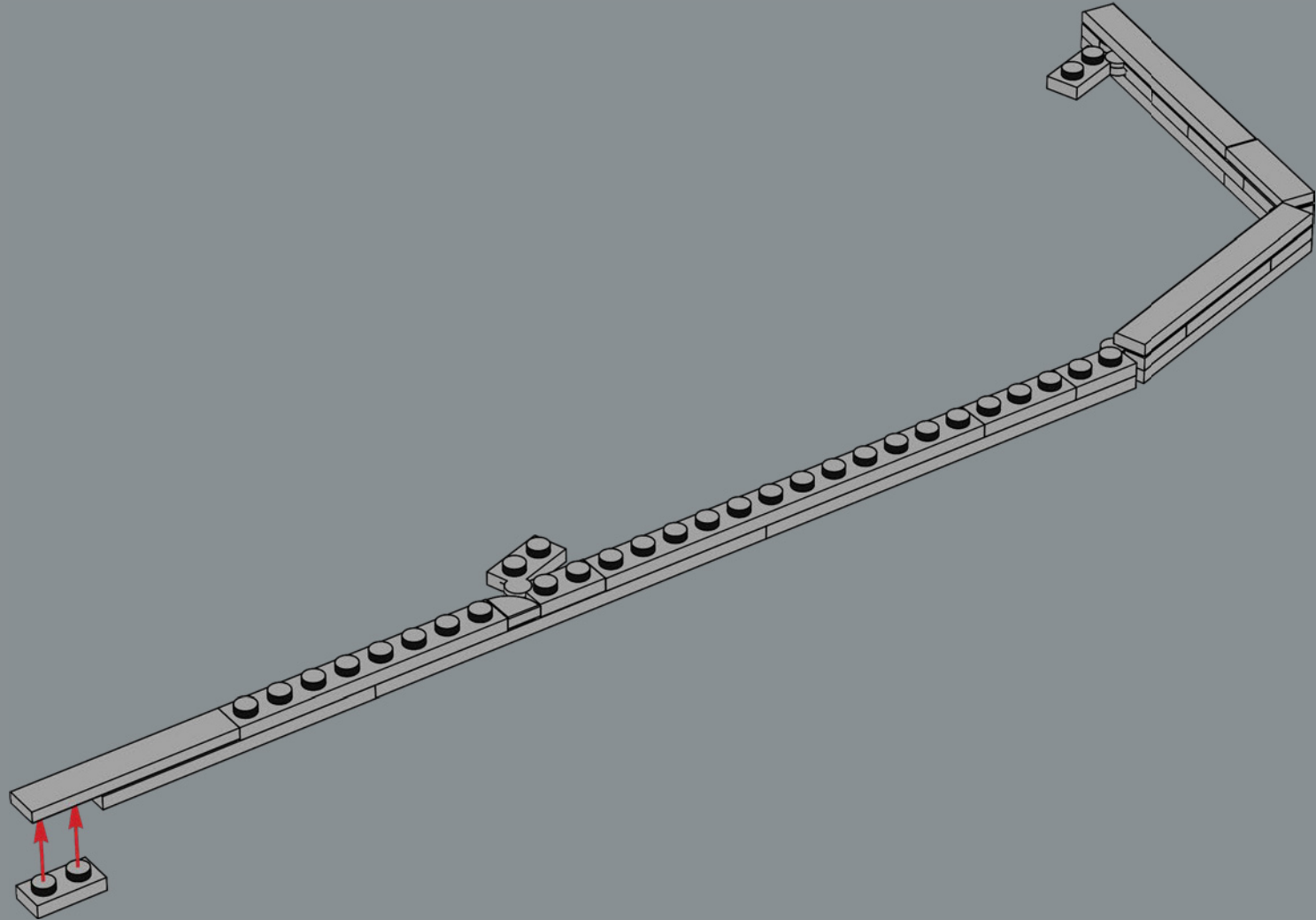

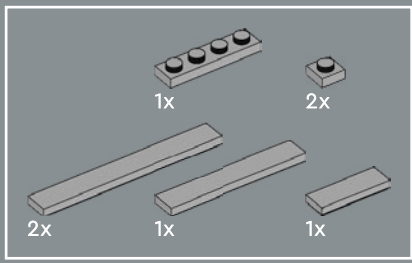

497

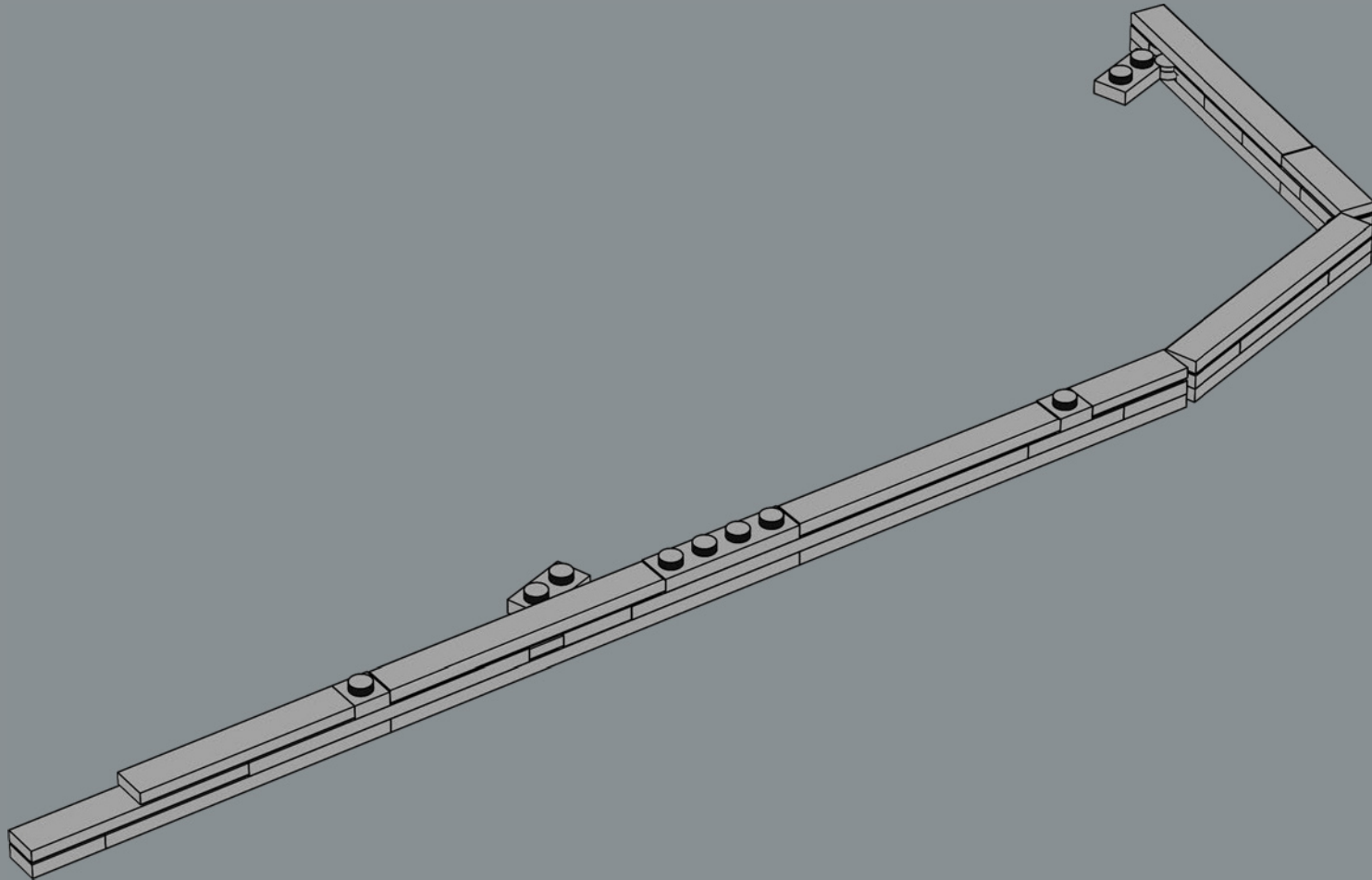

498

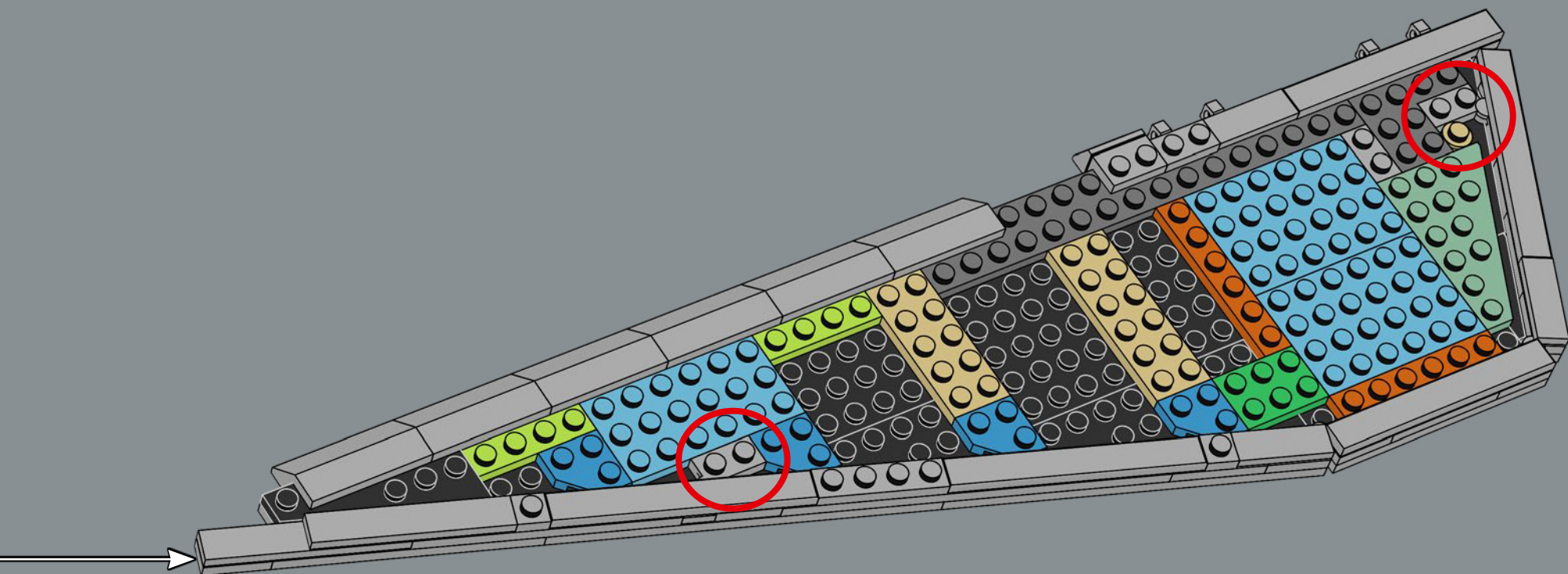



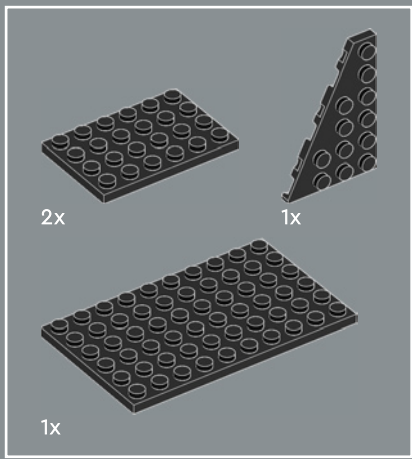

499

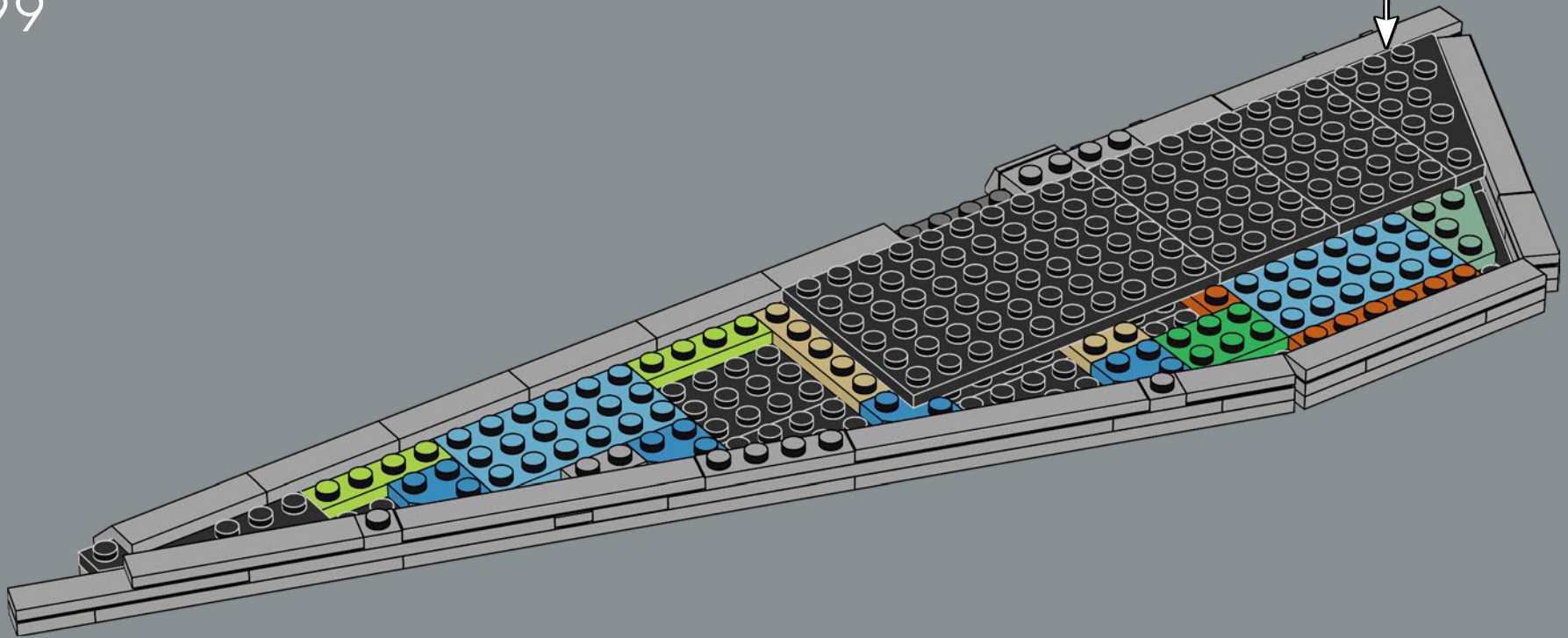
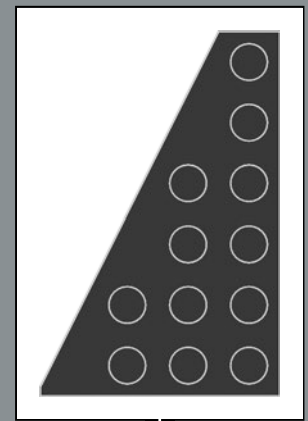

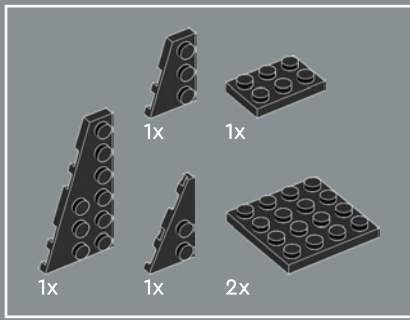

500

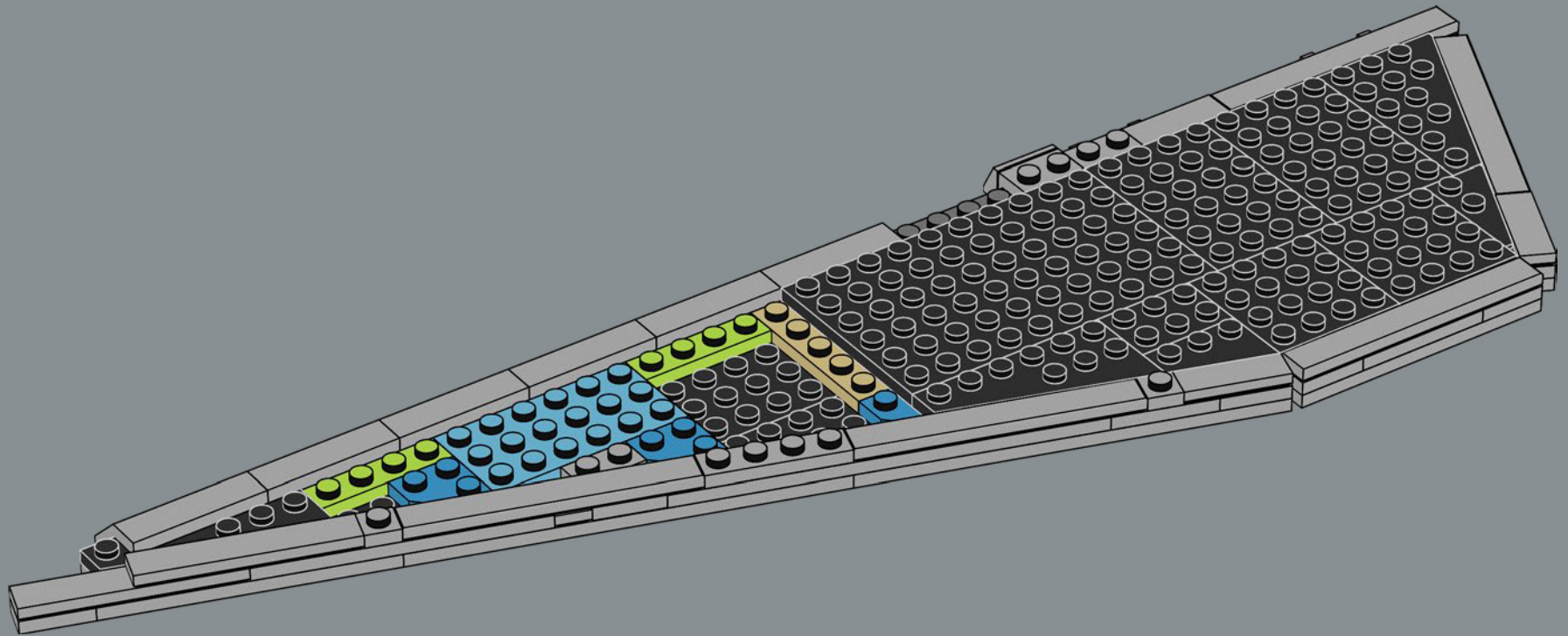

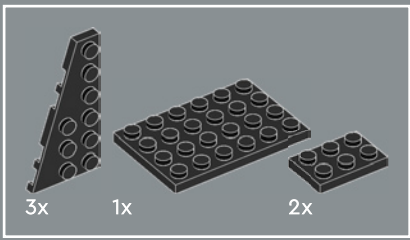

501

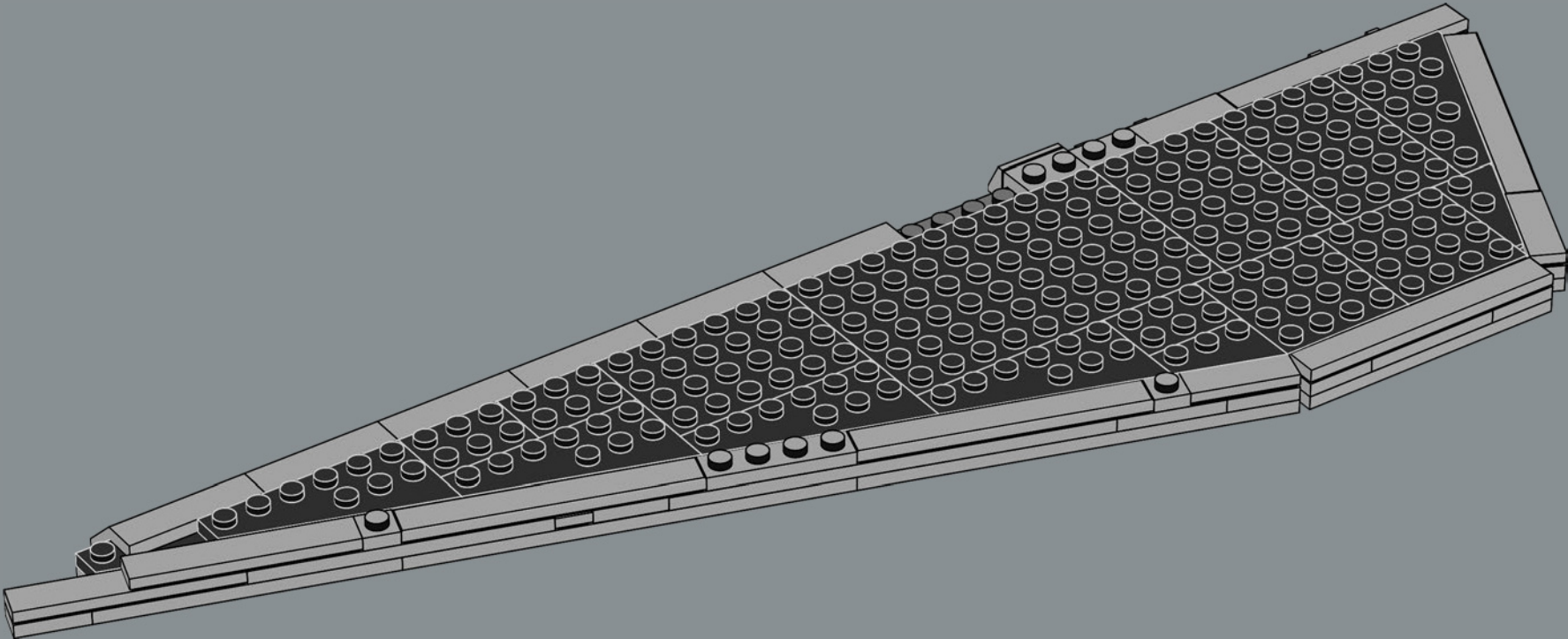

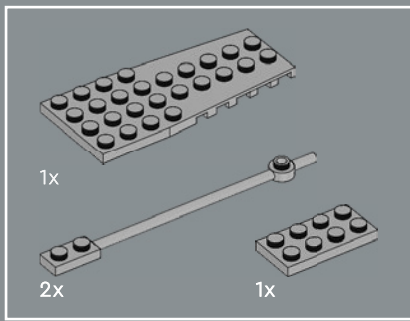

502

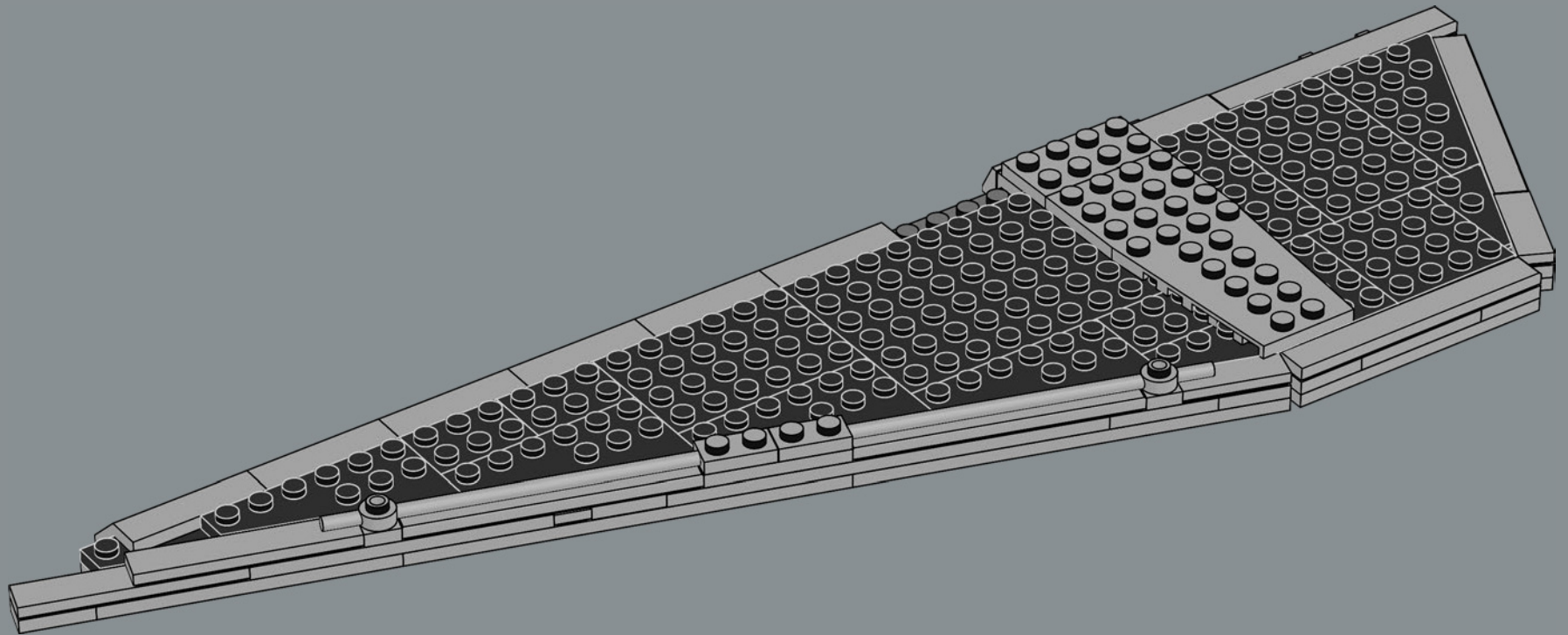



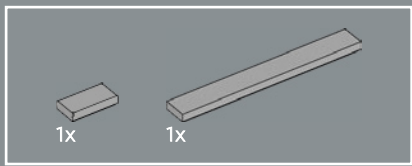

503

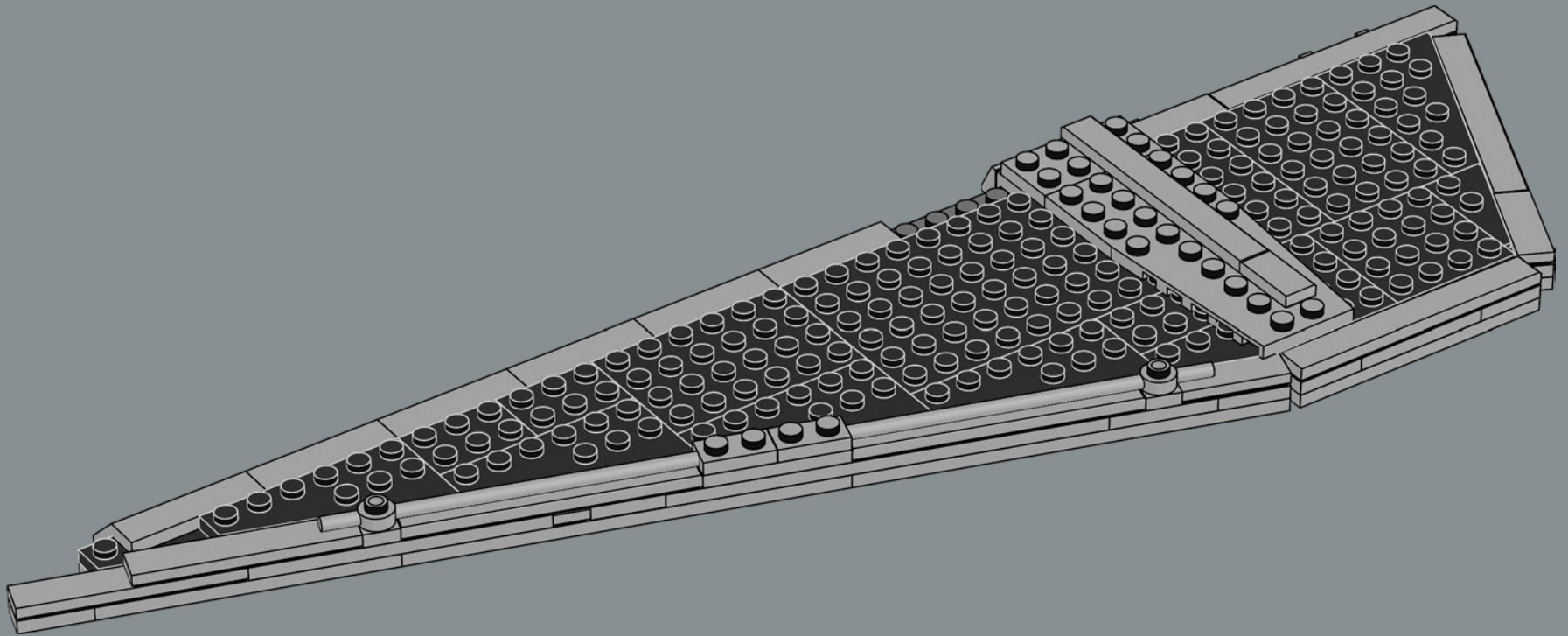

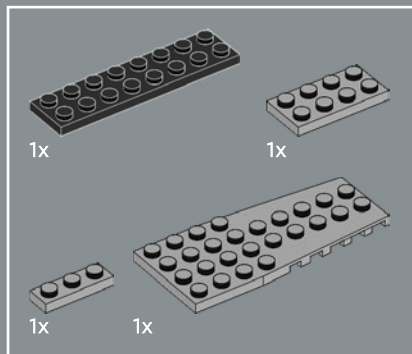

504

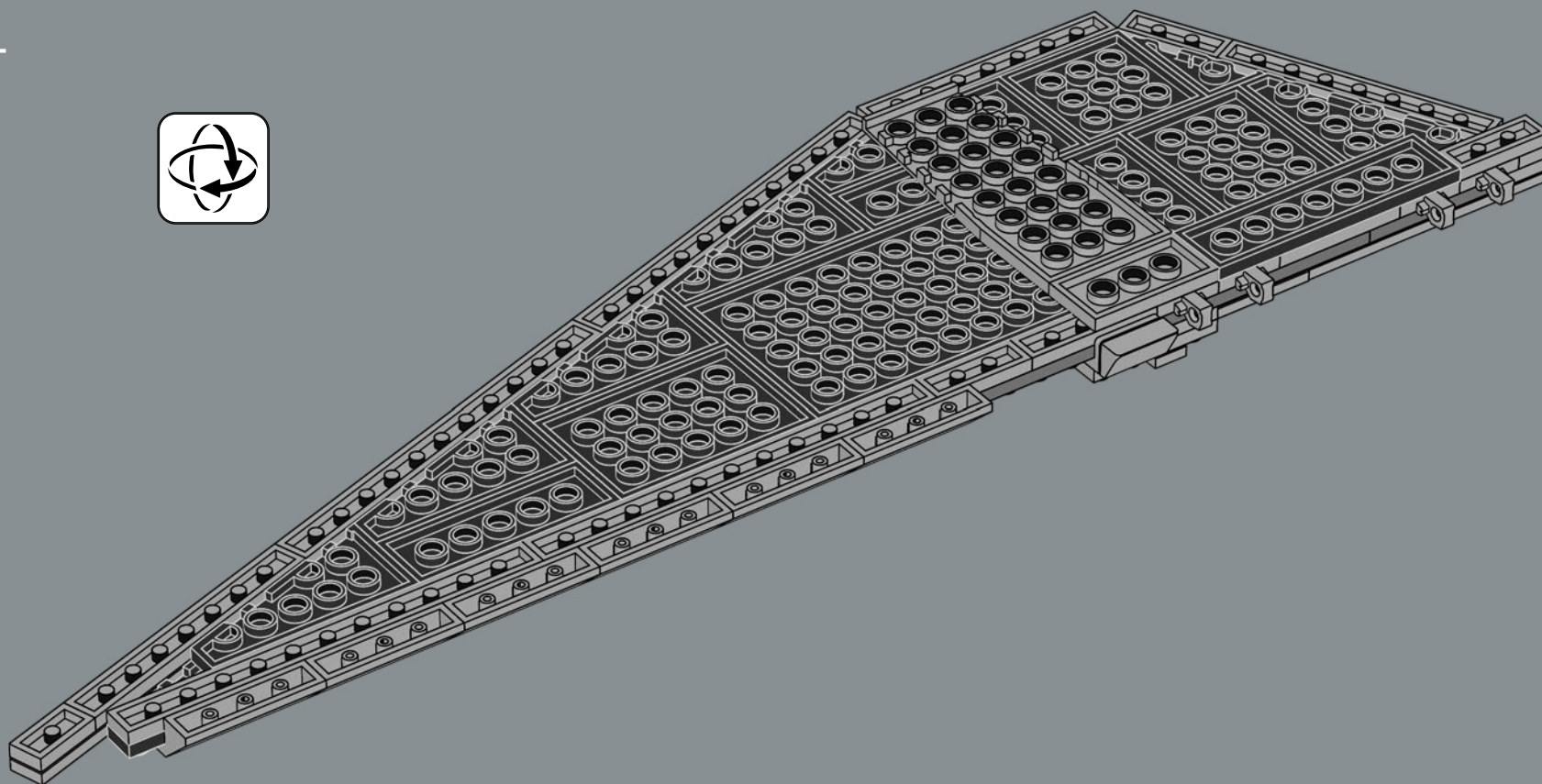

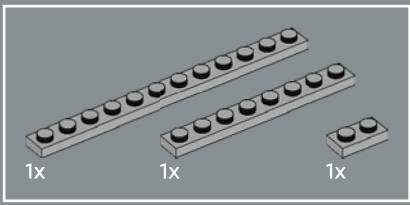

505

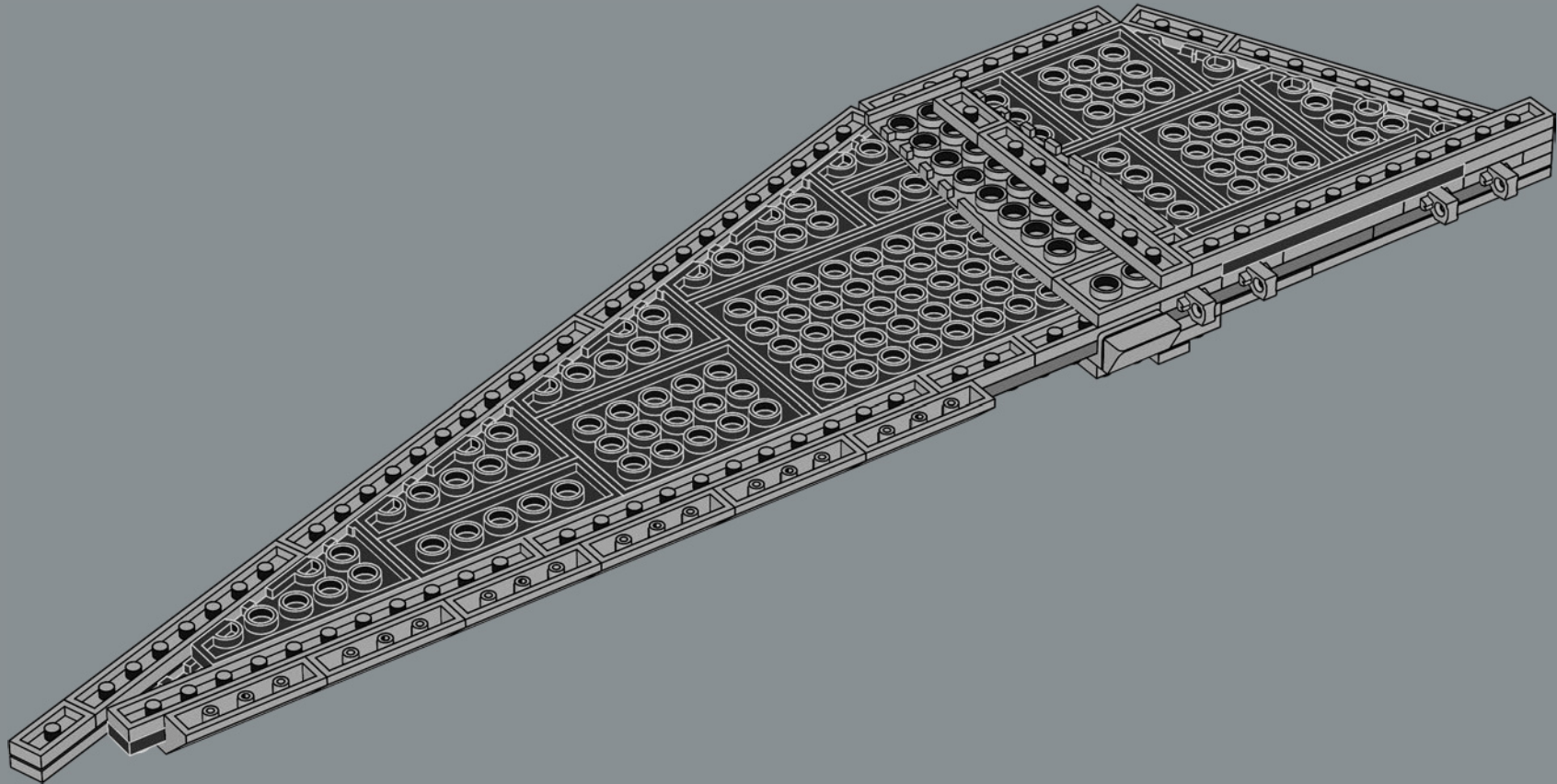

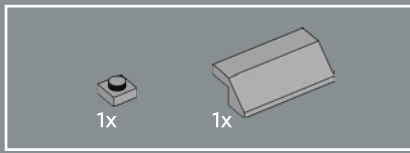

506

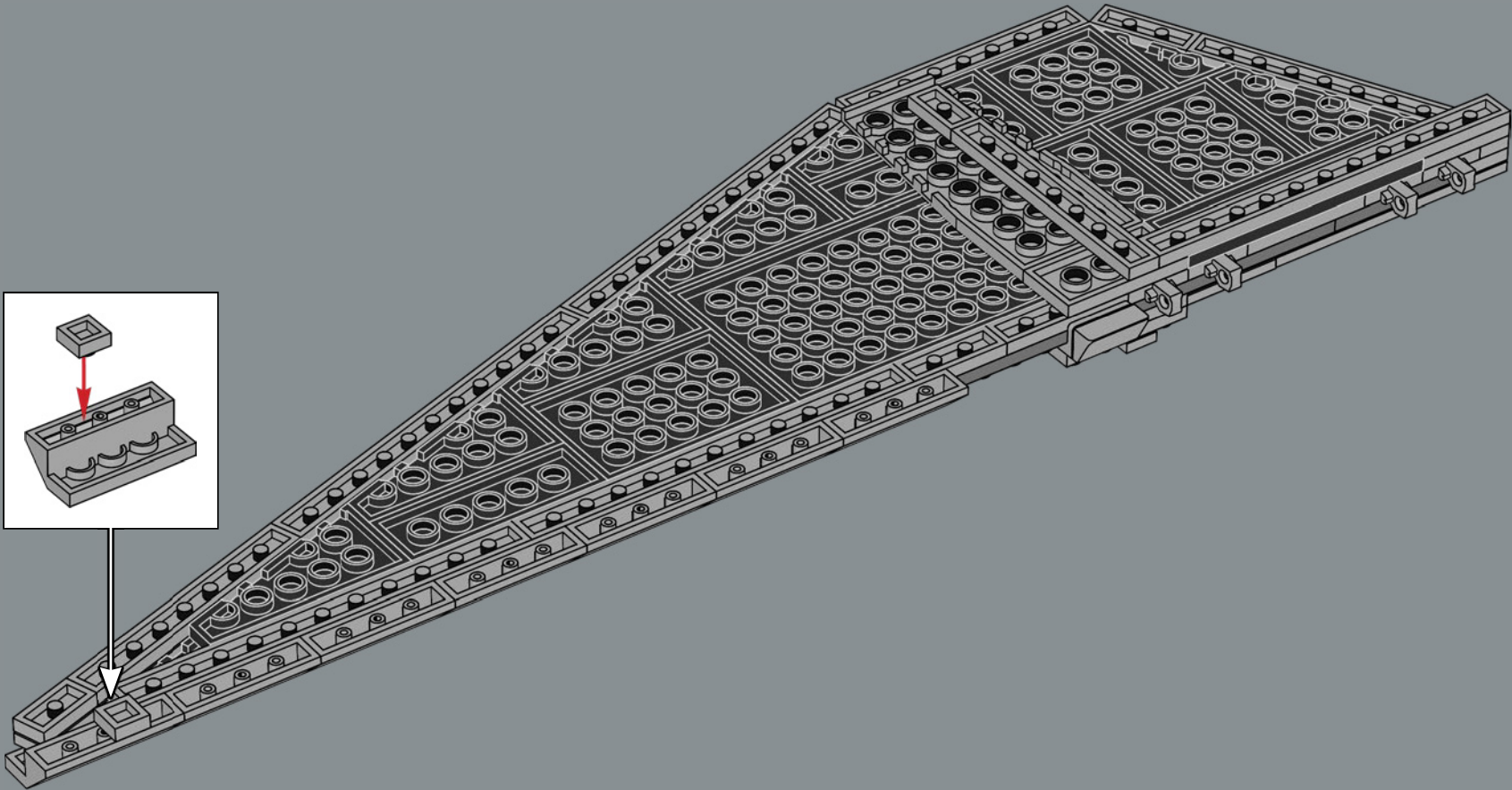



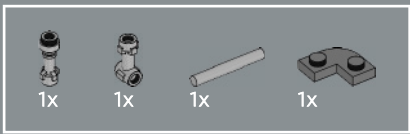

507

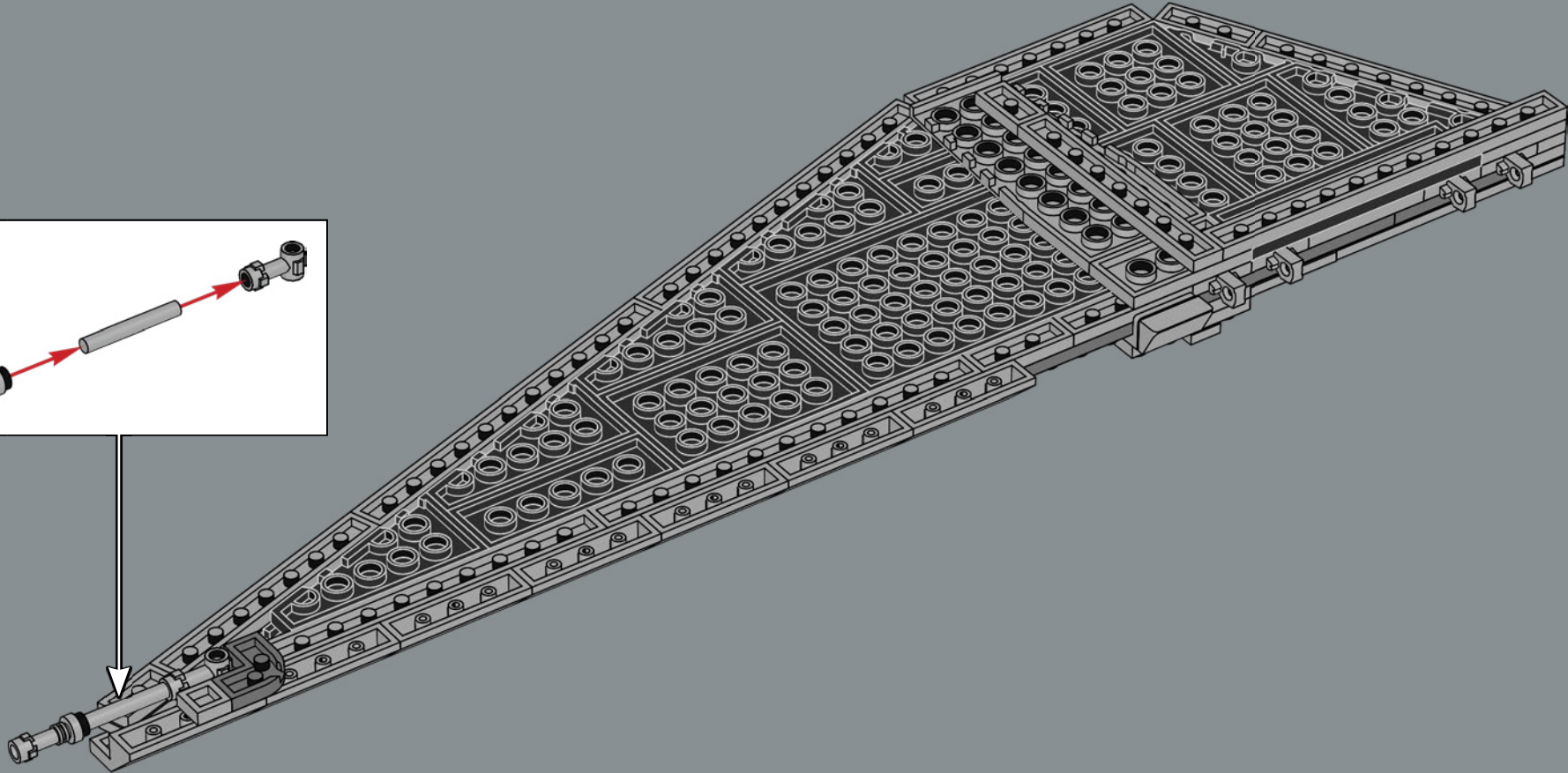
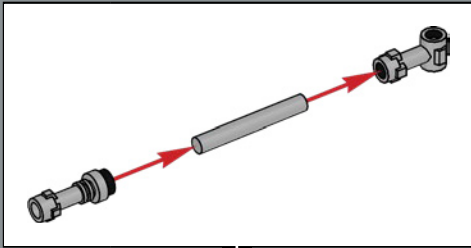



508

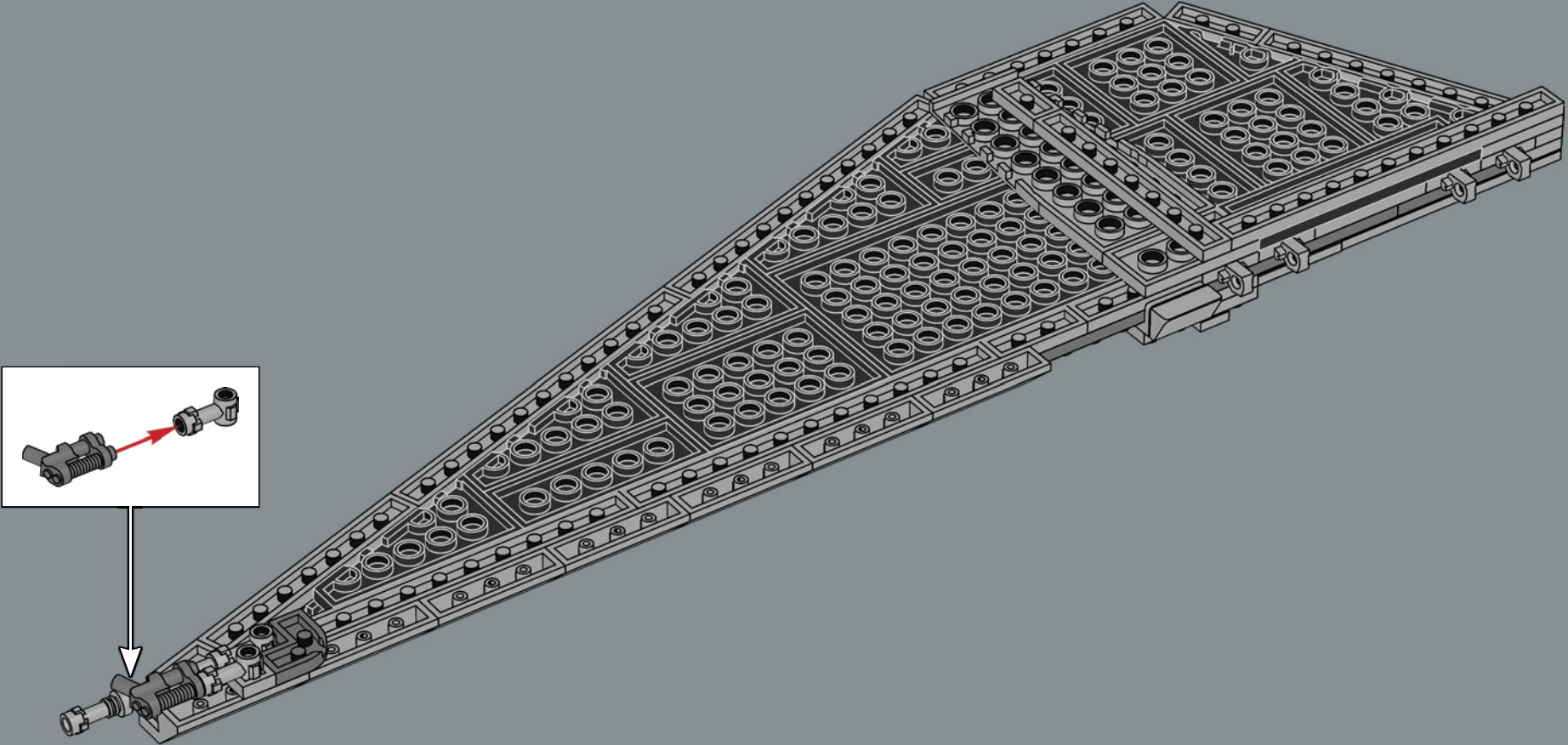



509

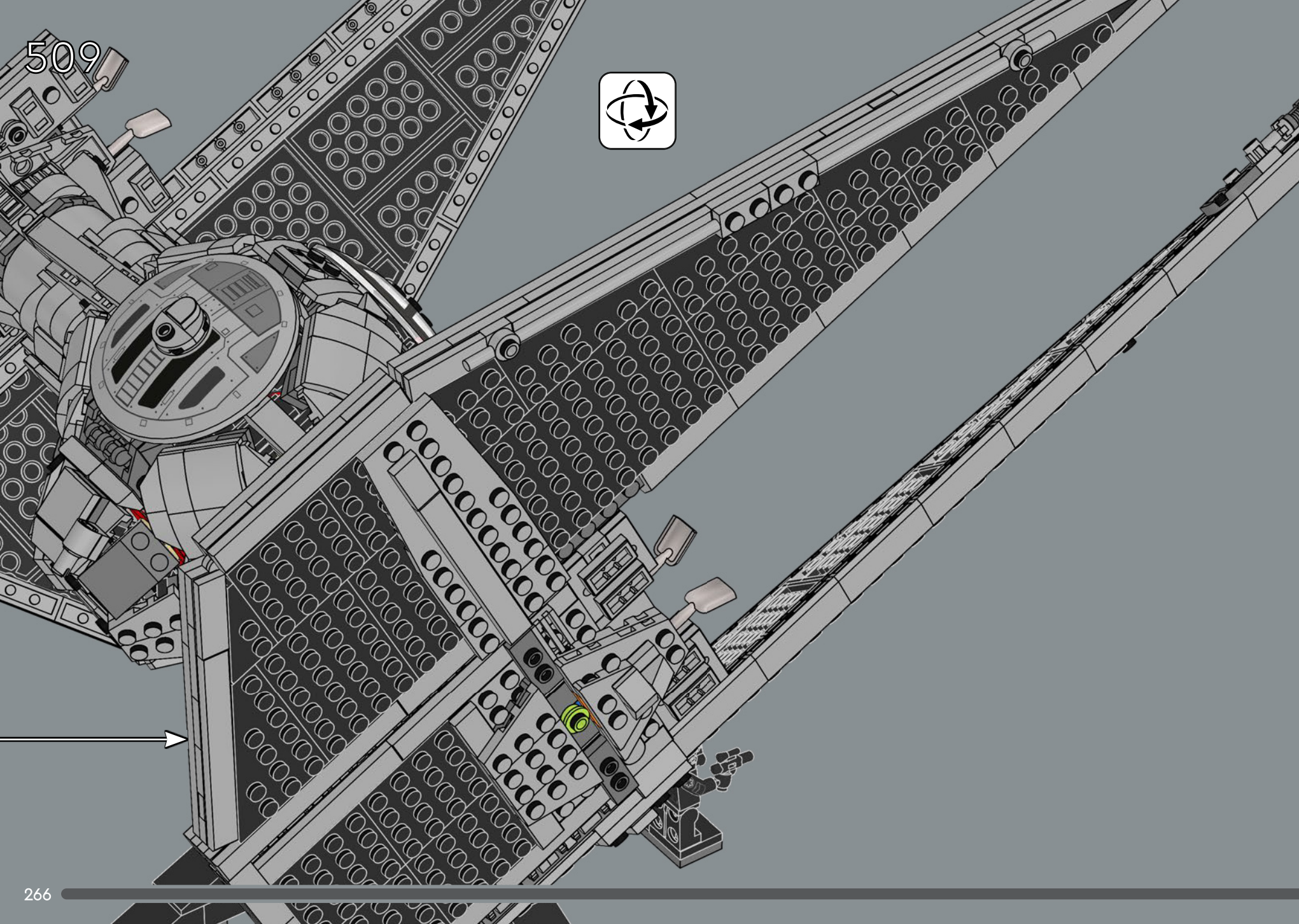



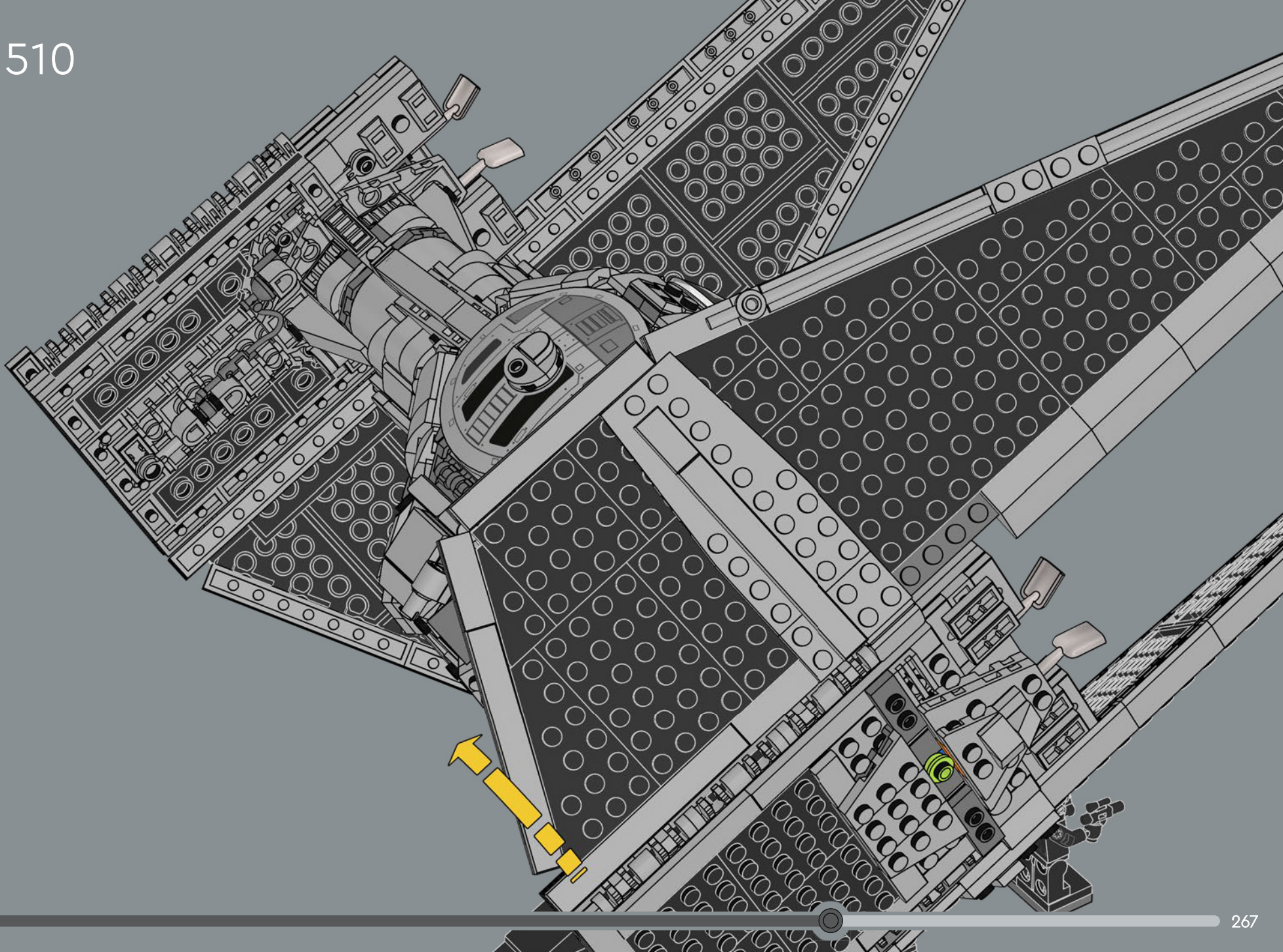



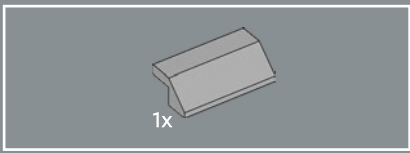

511

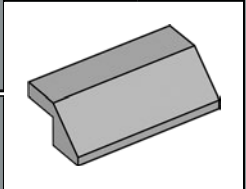
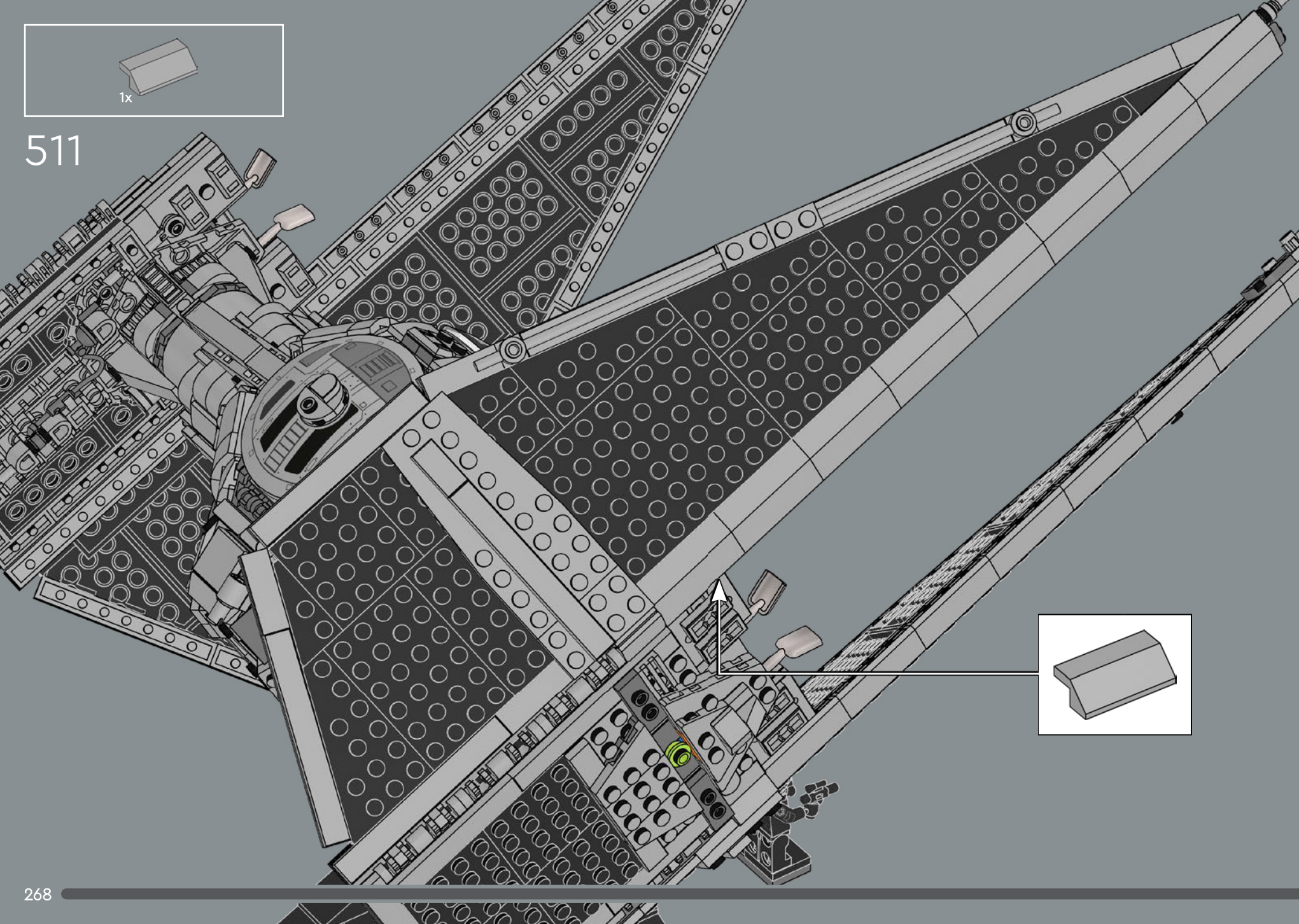

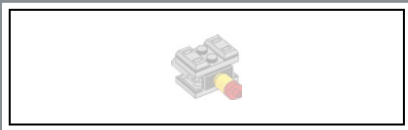

512

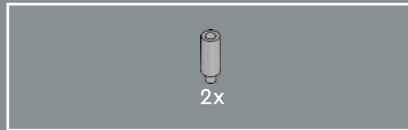
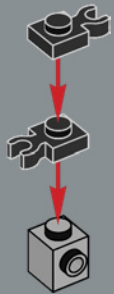

513

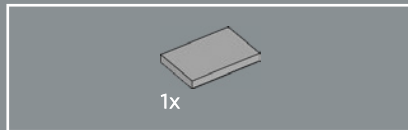
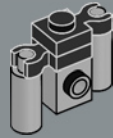

514

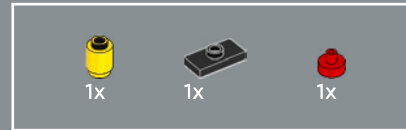
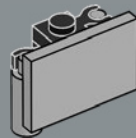

515

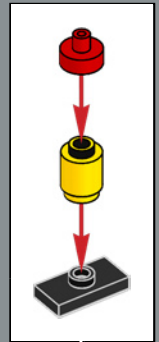
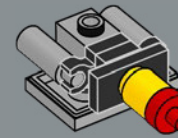

516

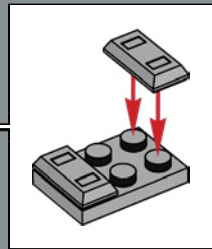



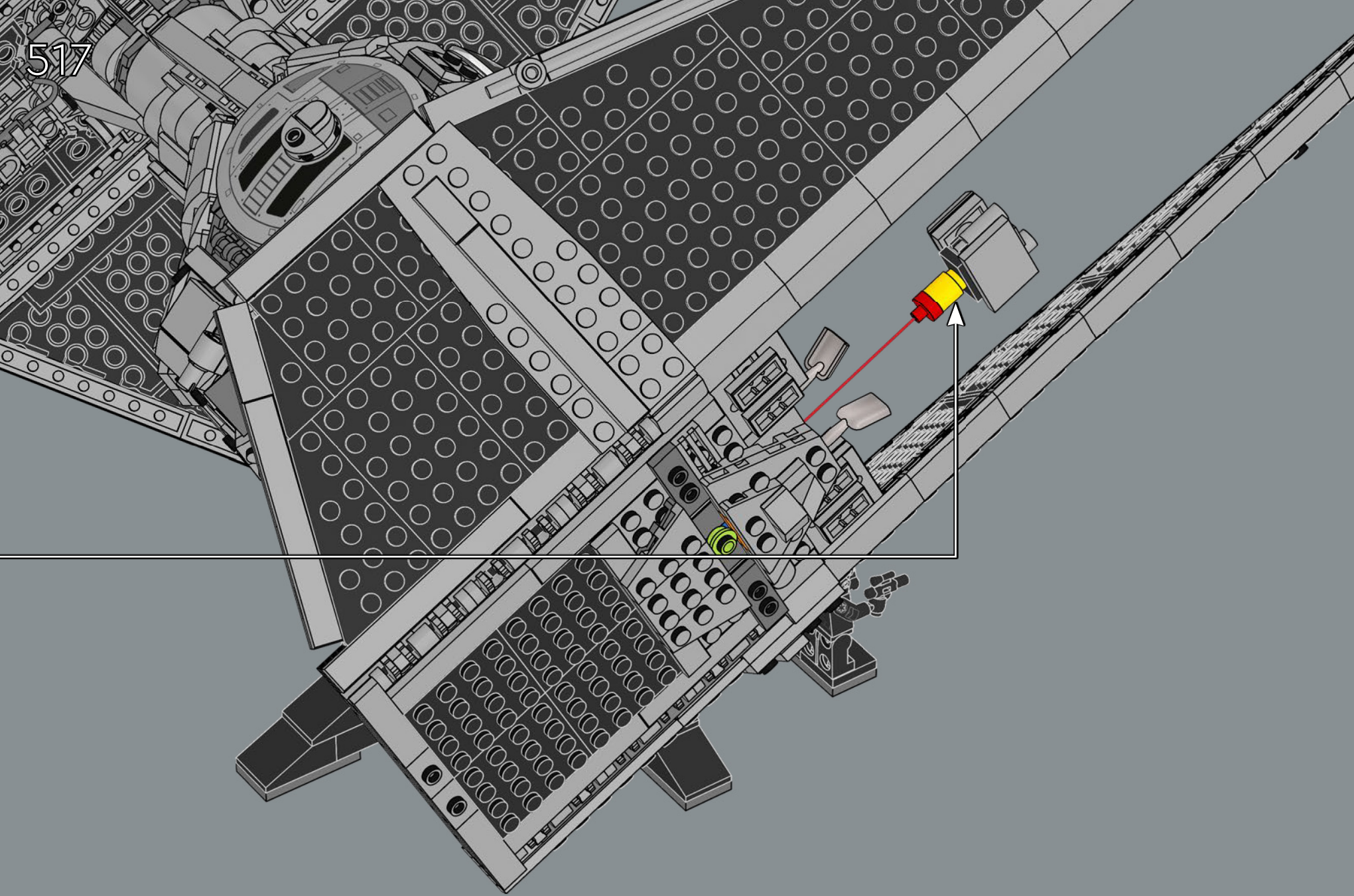



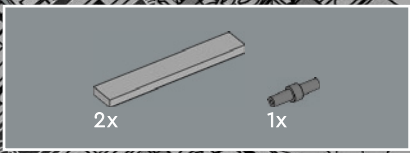

518

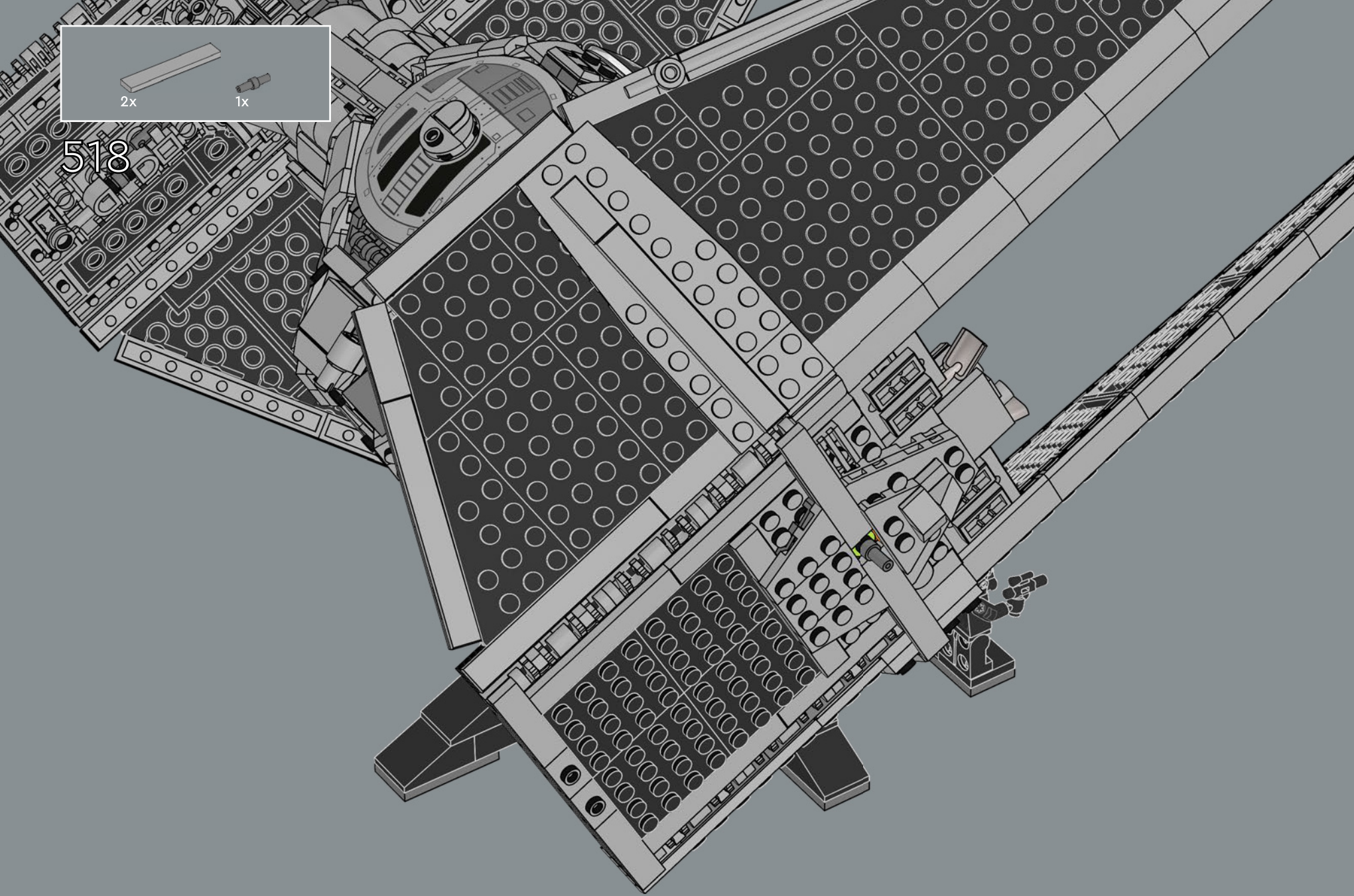



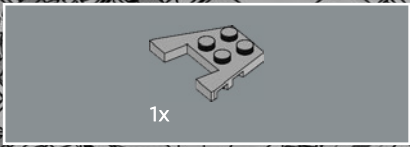

519

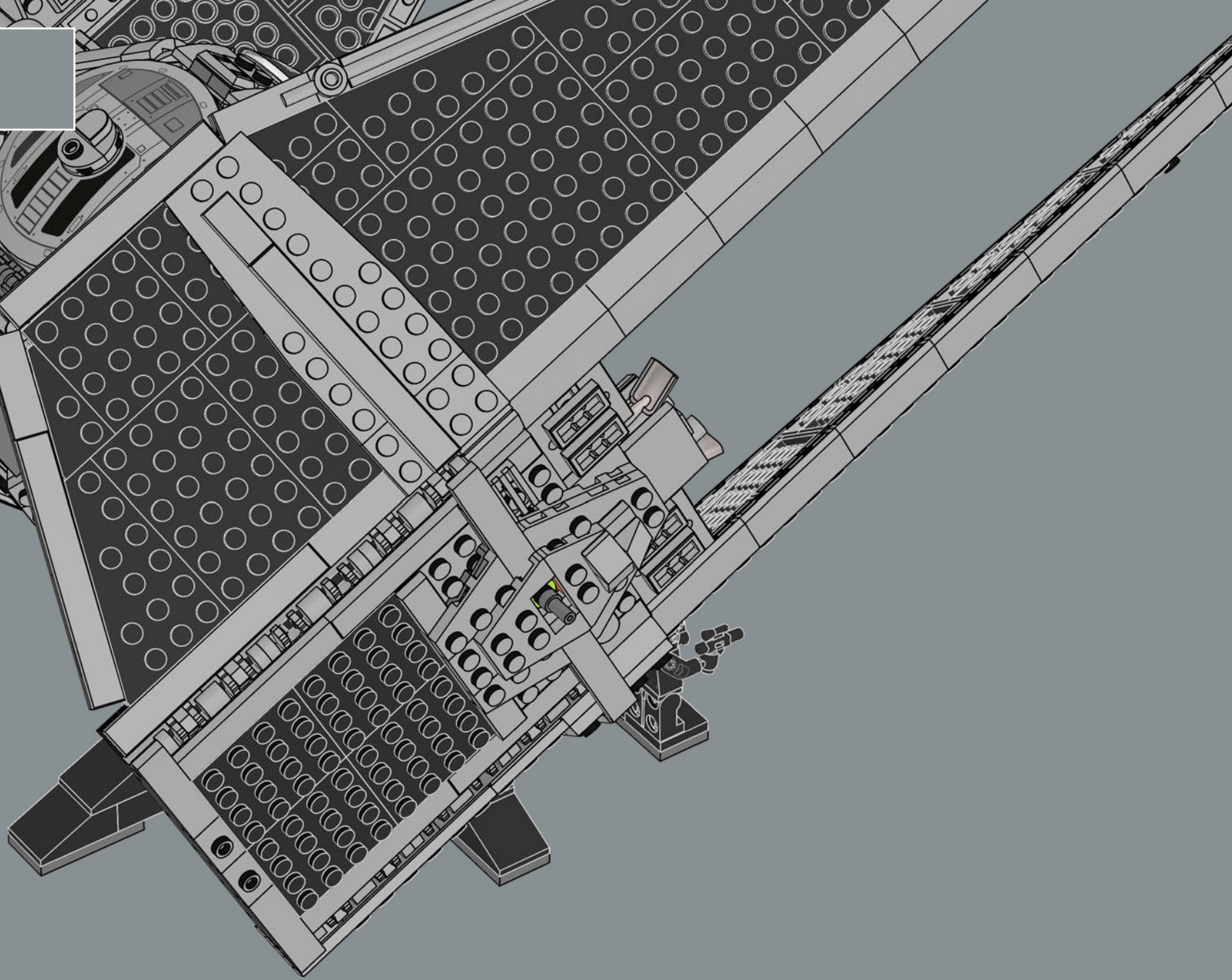





520

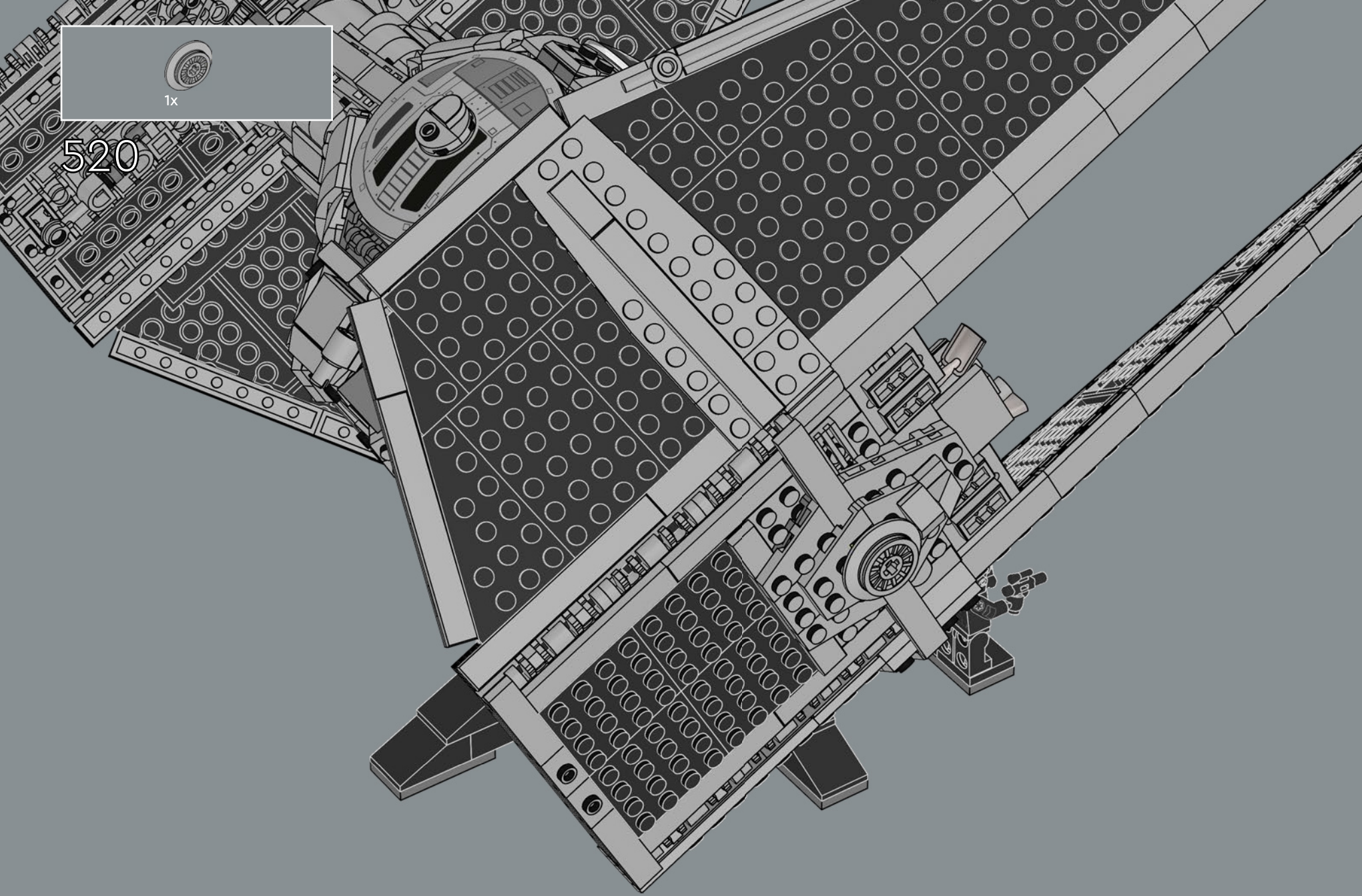

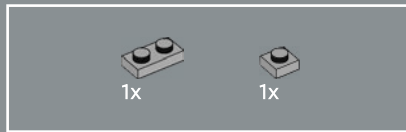
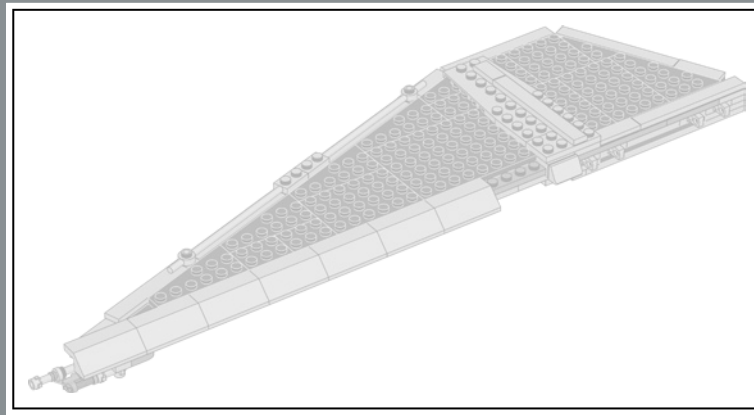

521

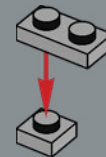

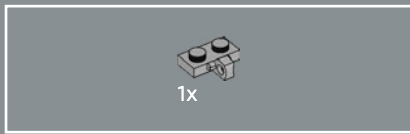

522

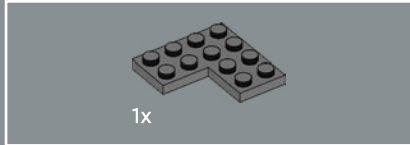
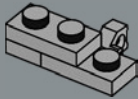

523

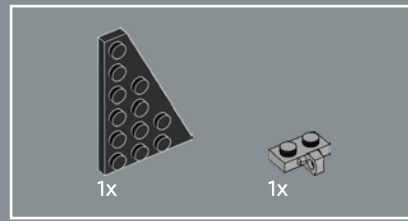
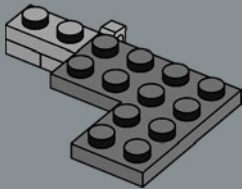

524

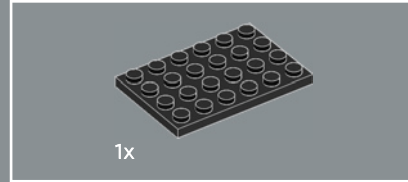
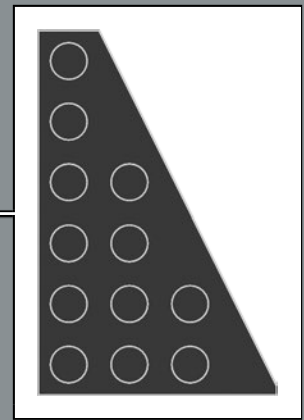
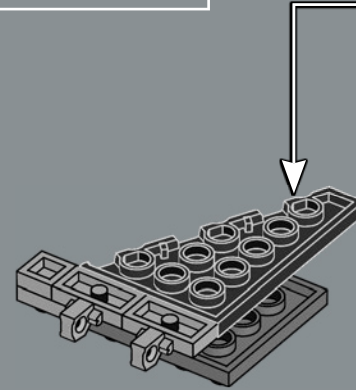

525

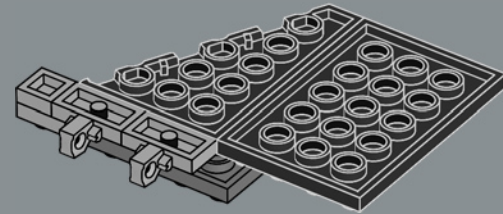



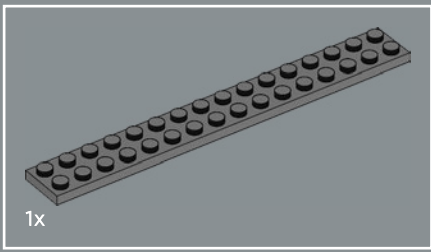

526

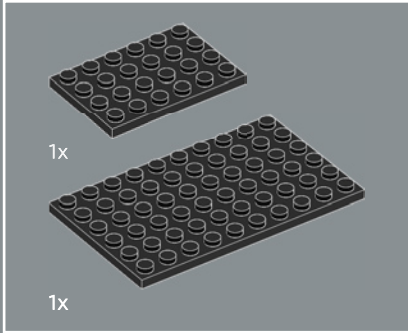
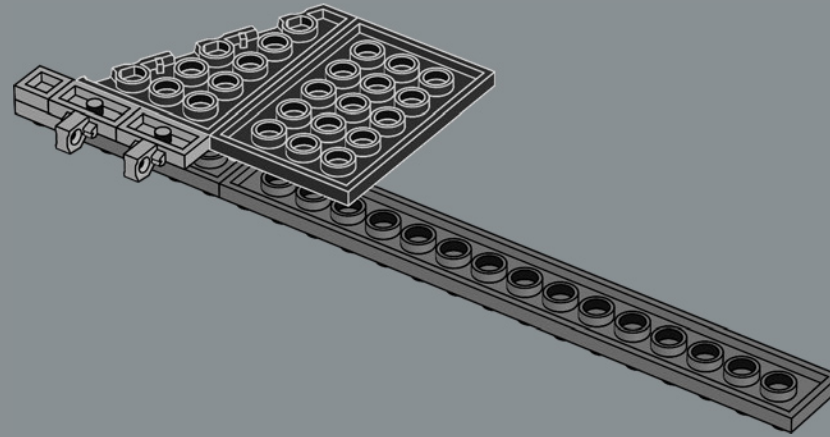

527

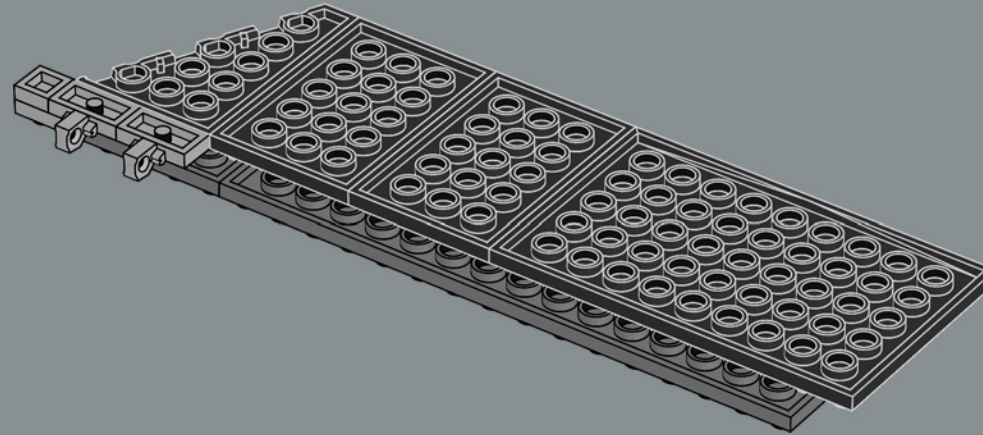

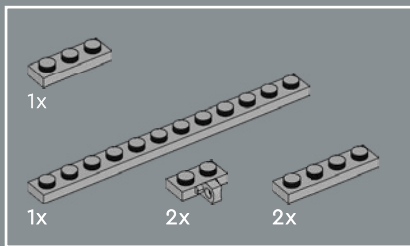

528

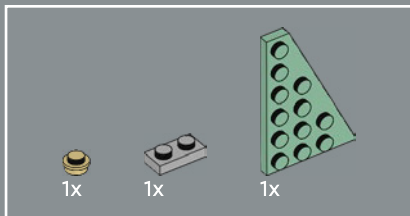
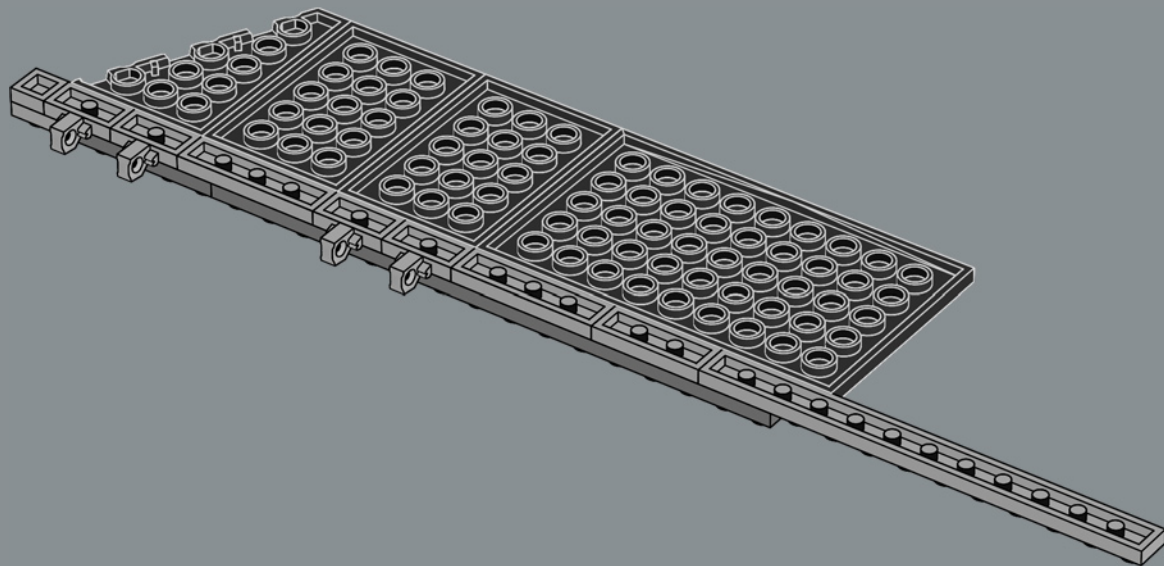

529

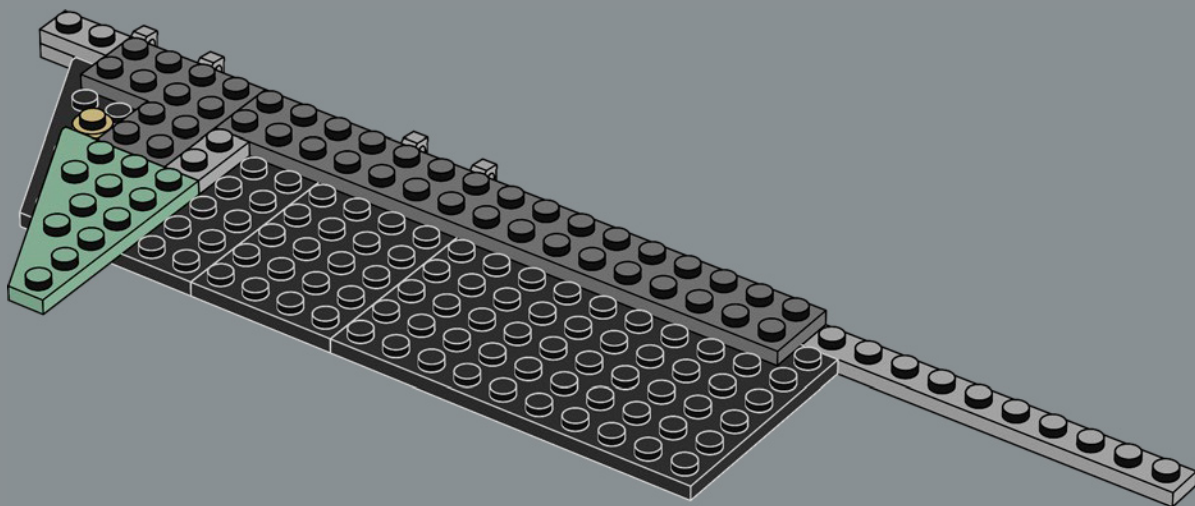

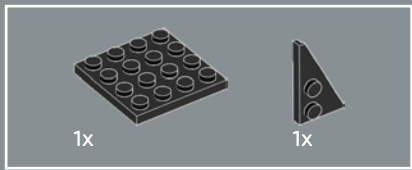

530

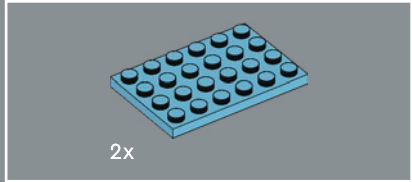
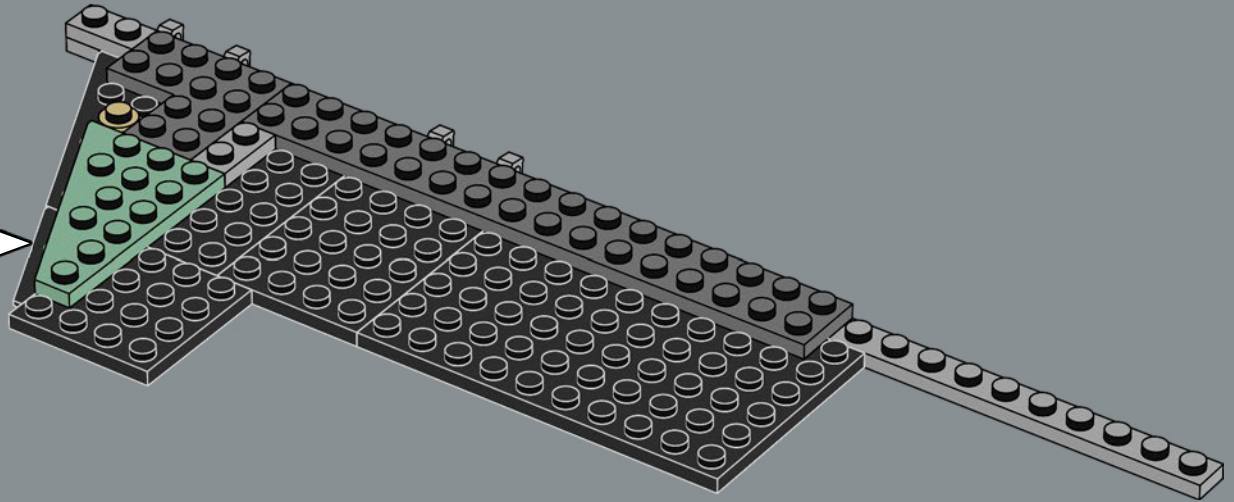
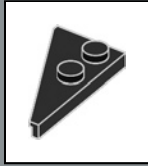

531

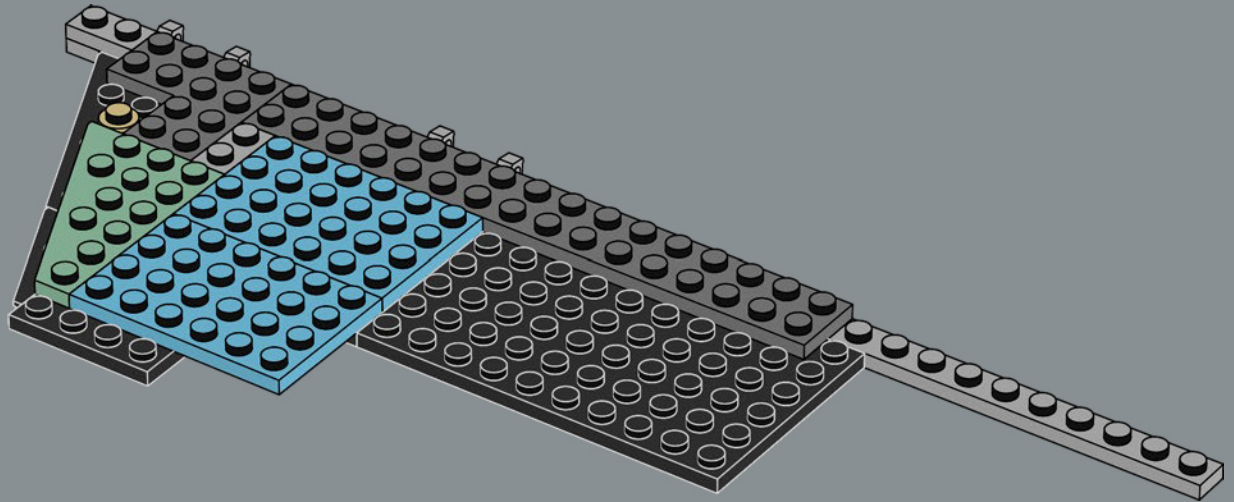

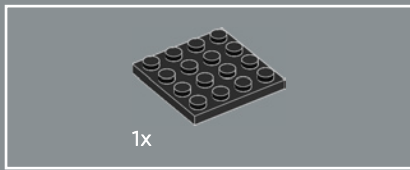

532

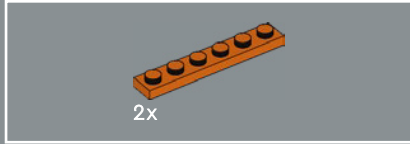
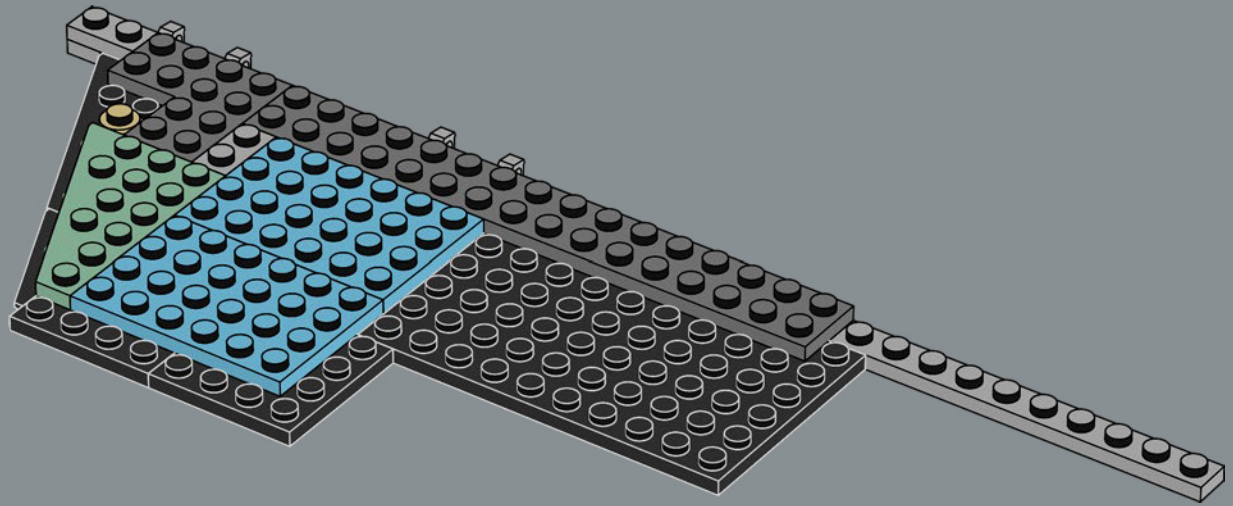

533

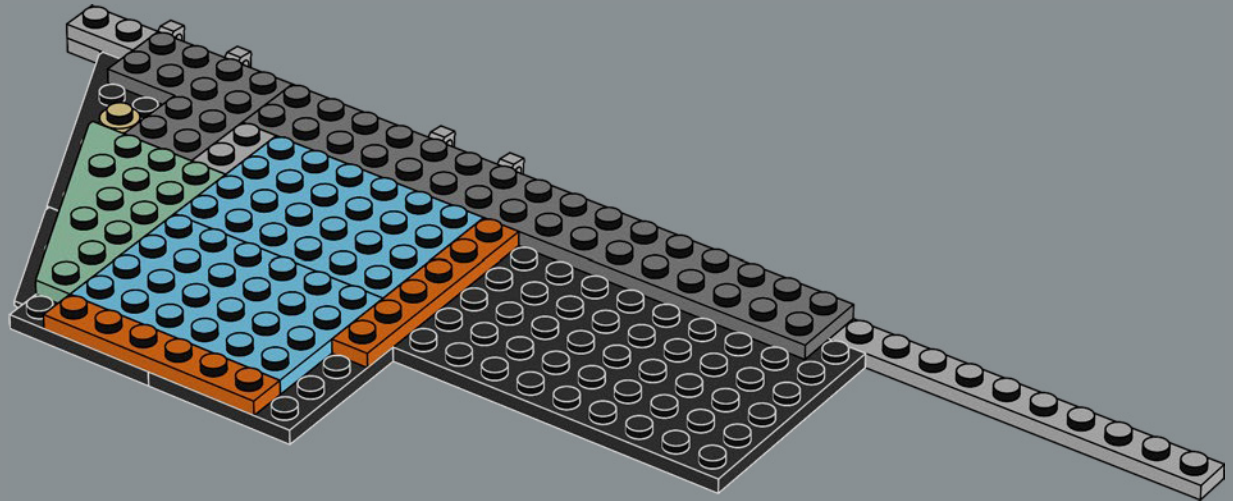



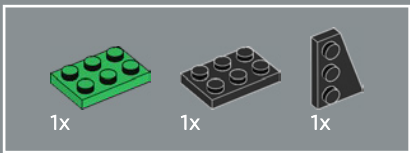

534

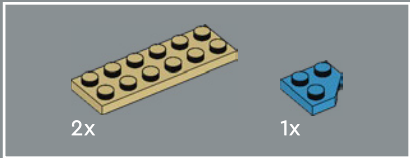
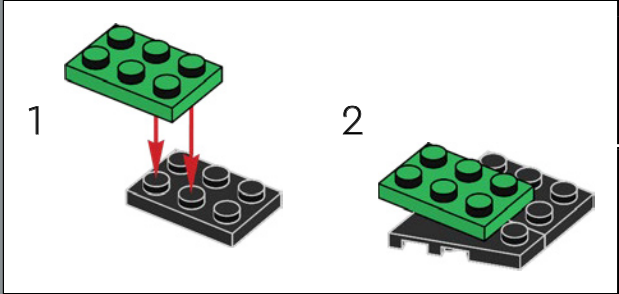
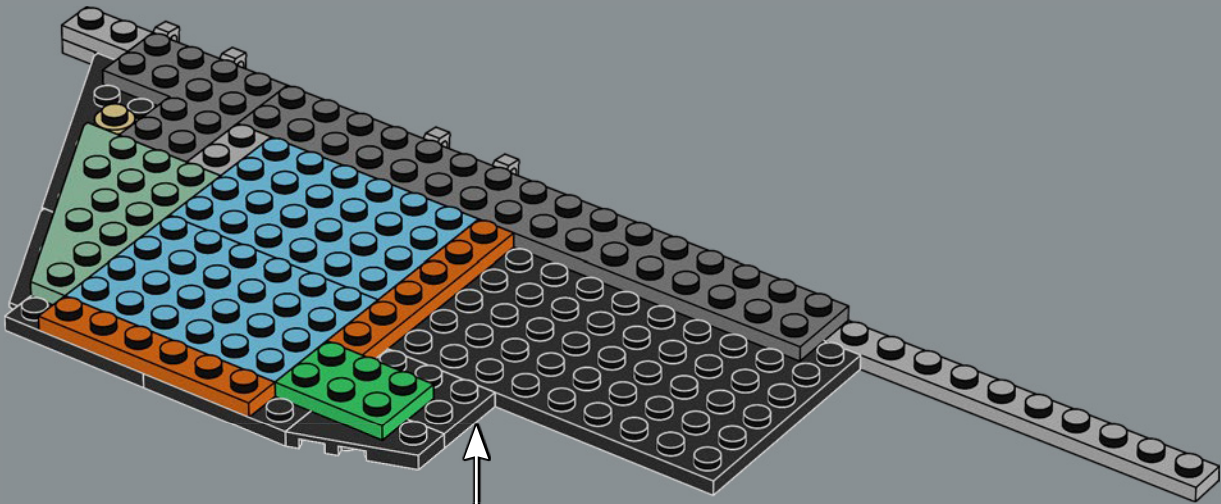

535

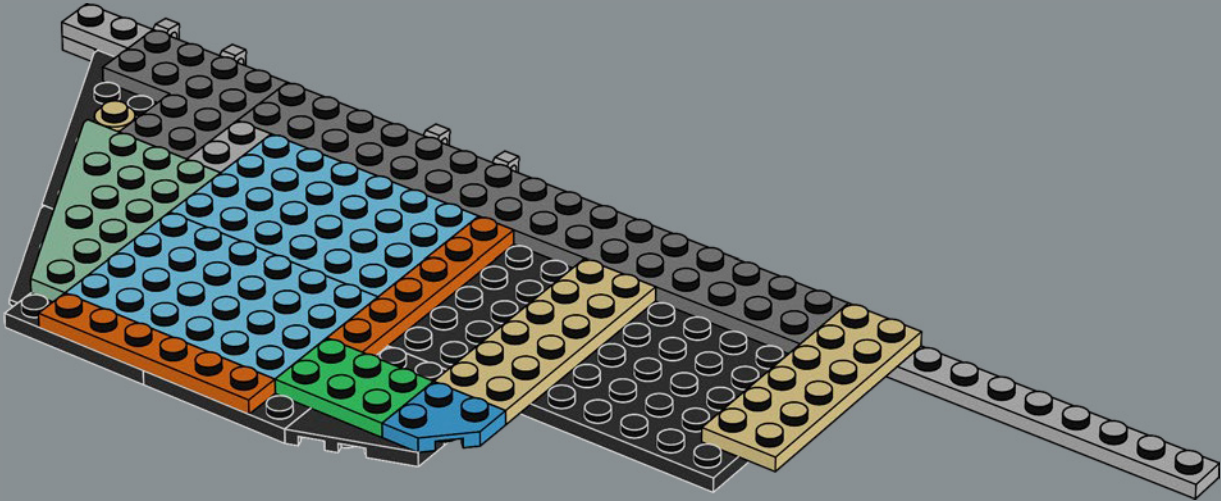

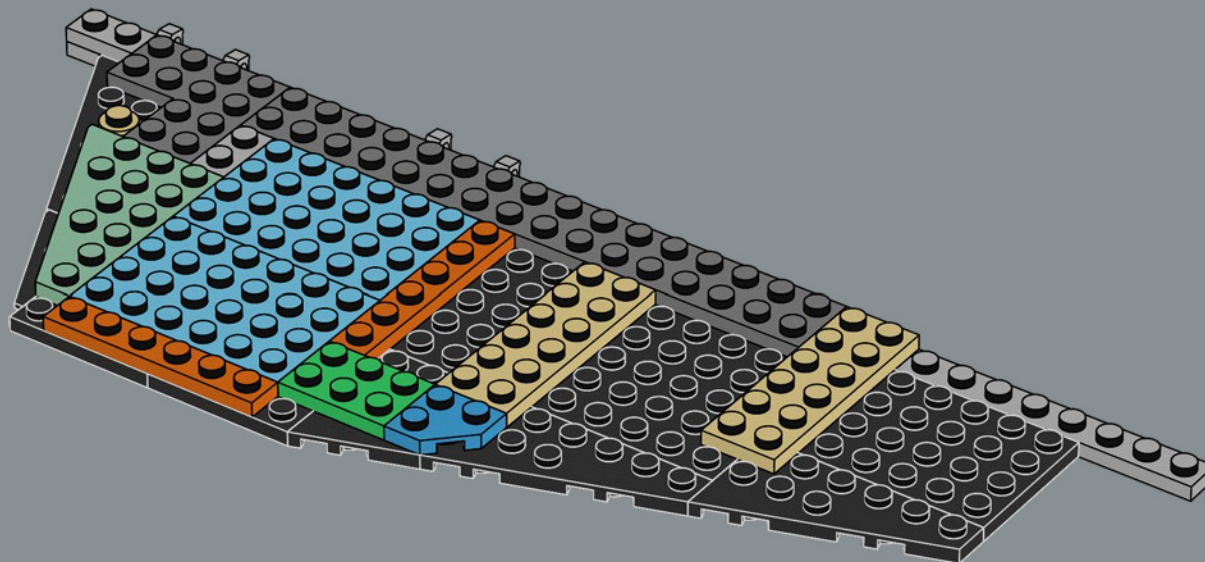
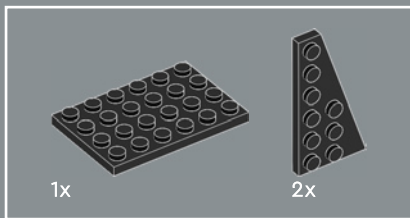

536

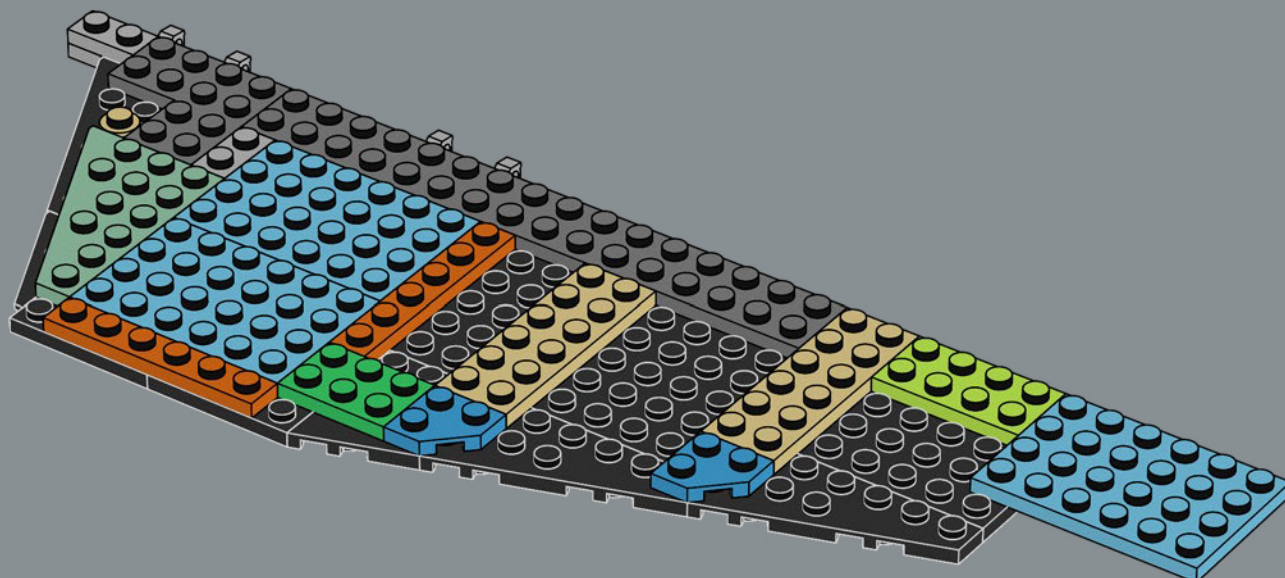
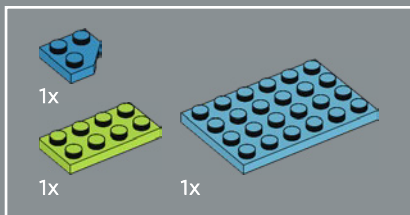

537



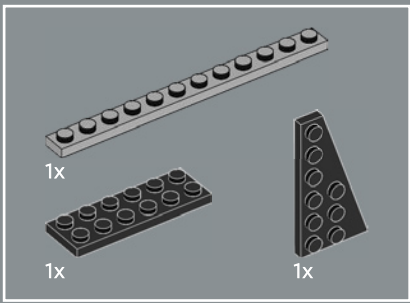

538

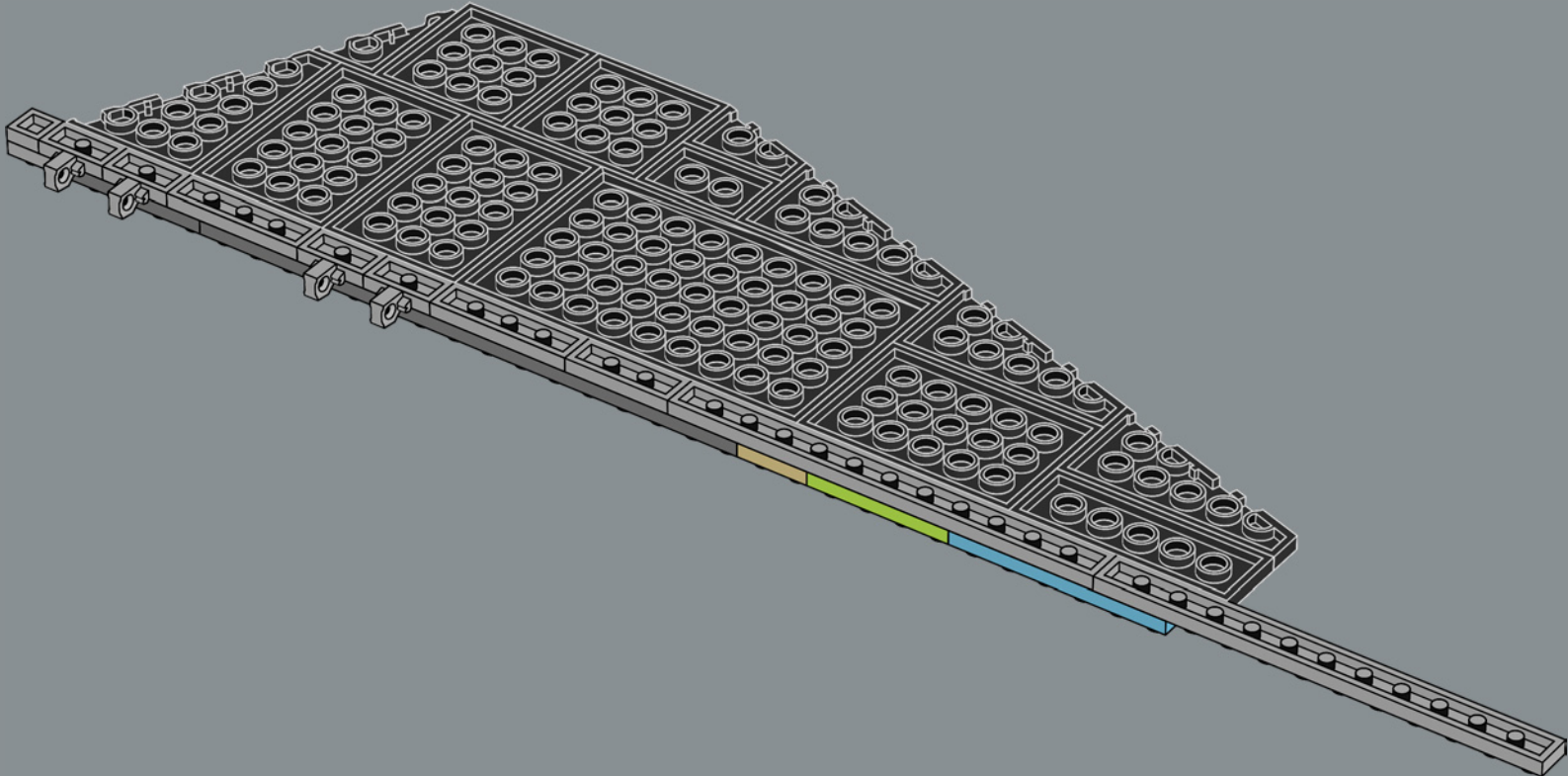



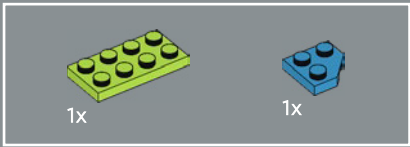

539

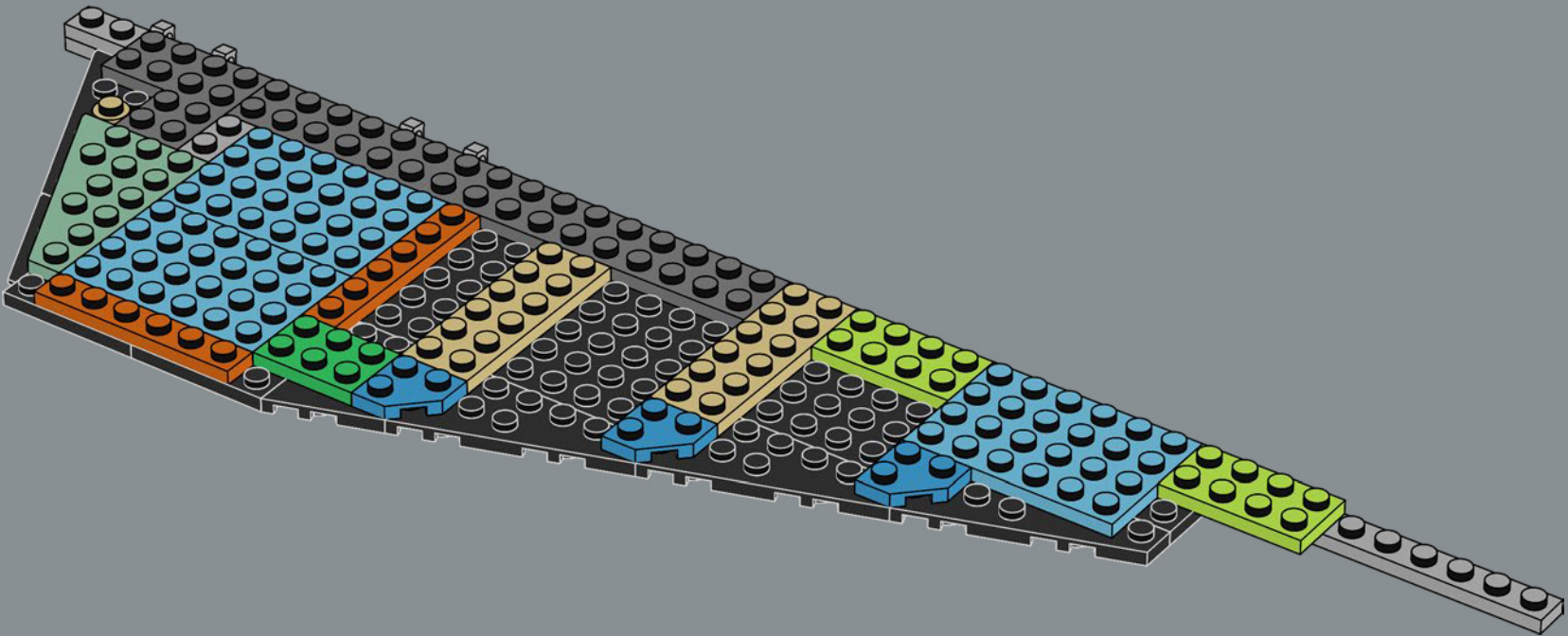



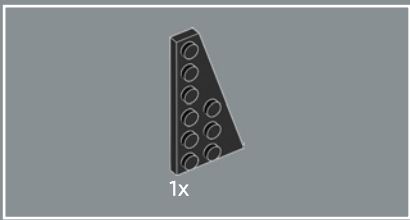

540

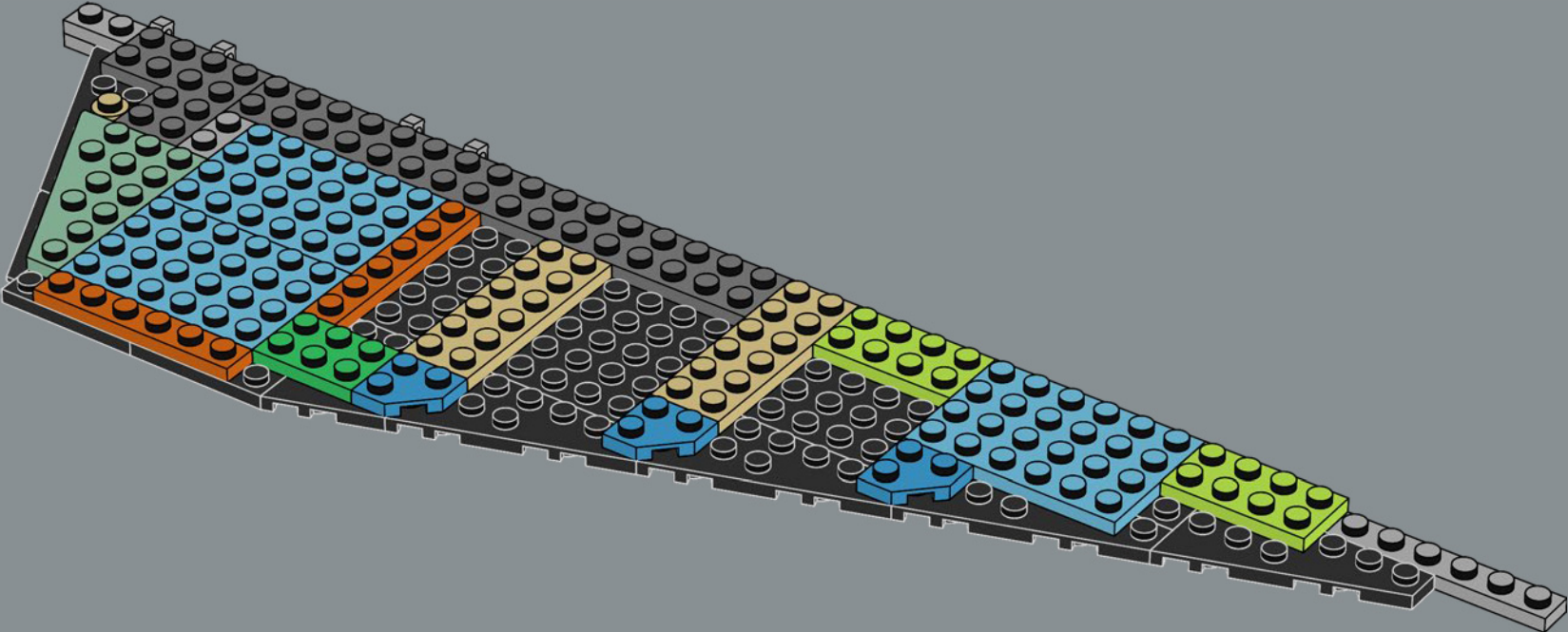

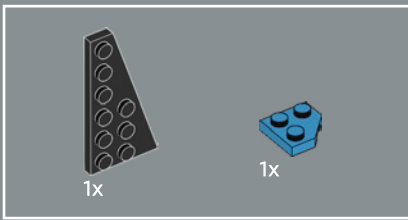

541

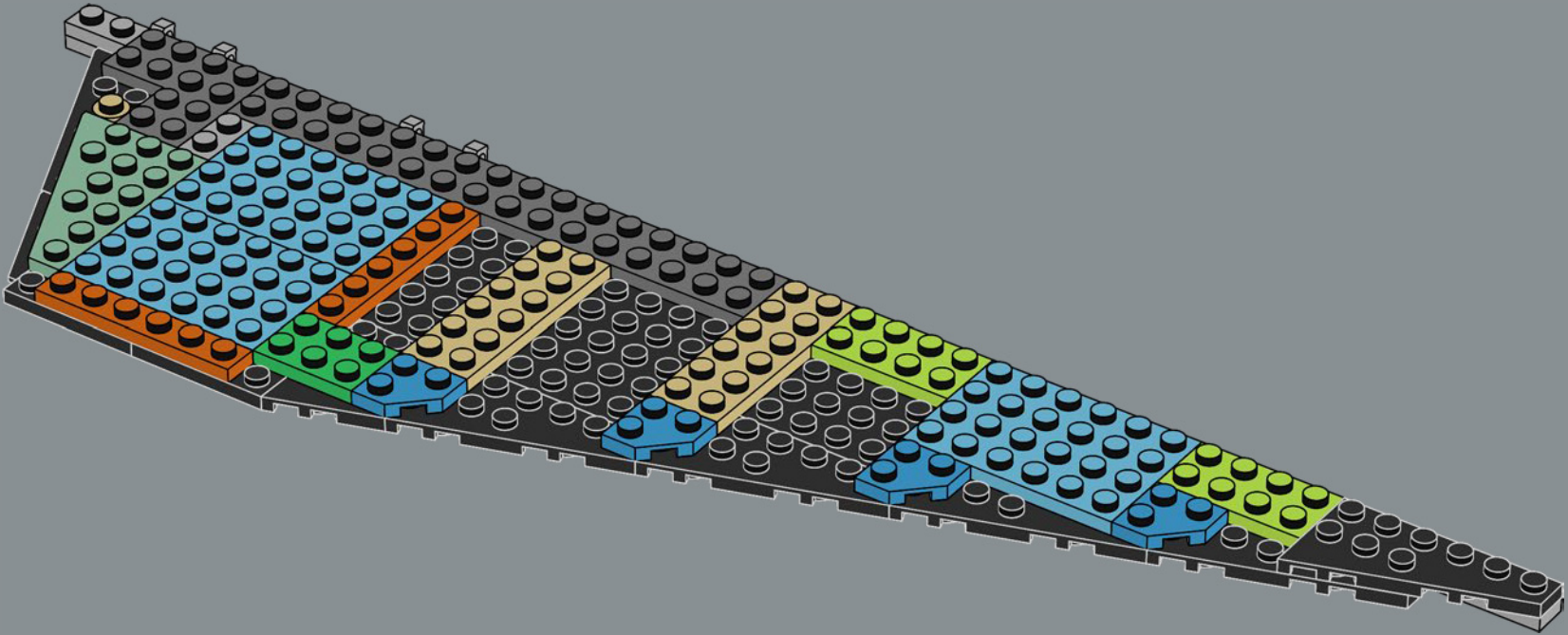

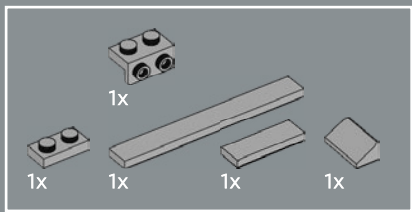

542

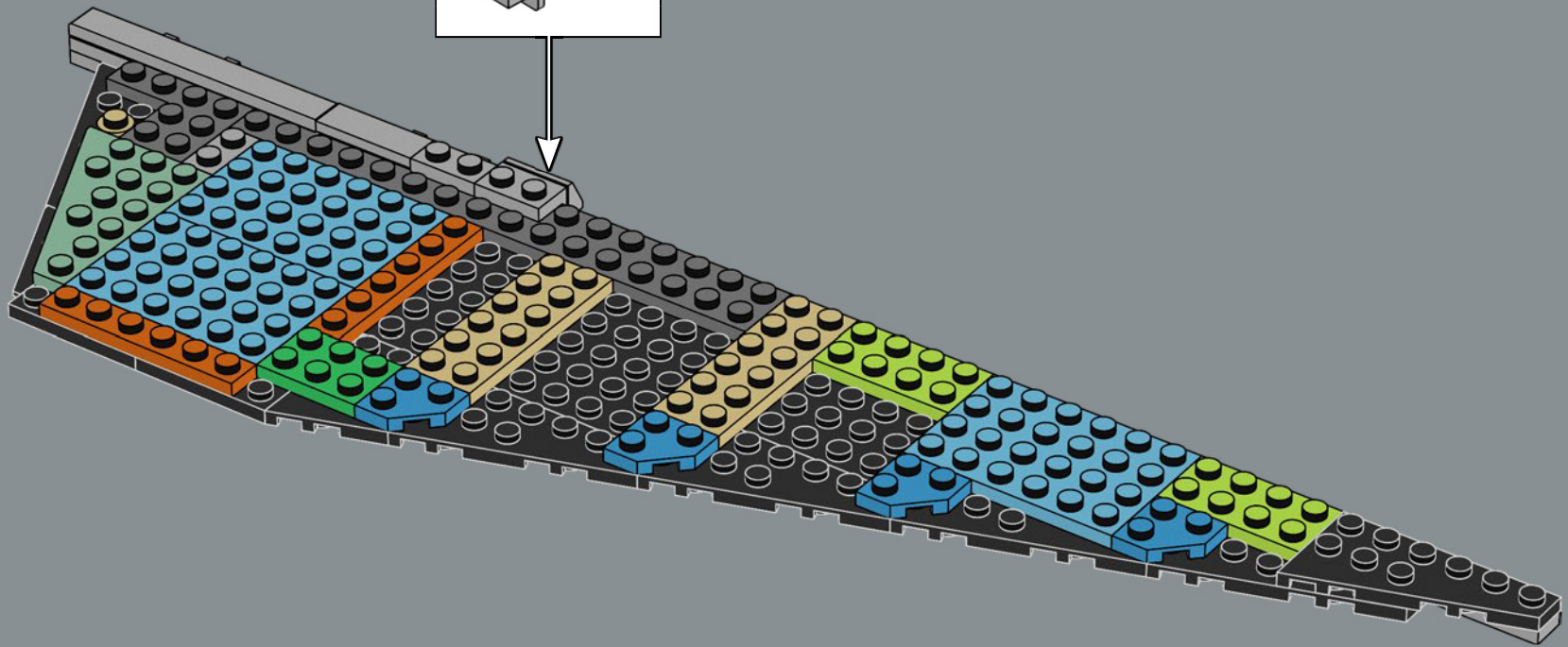
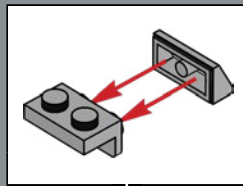

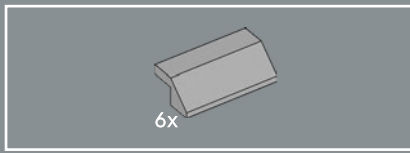

543

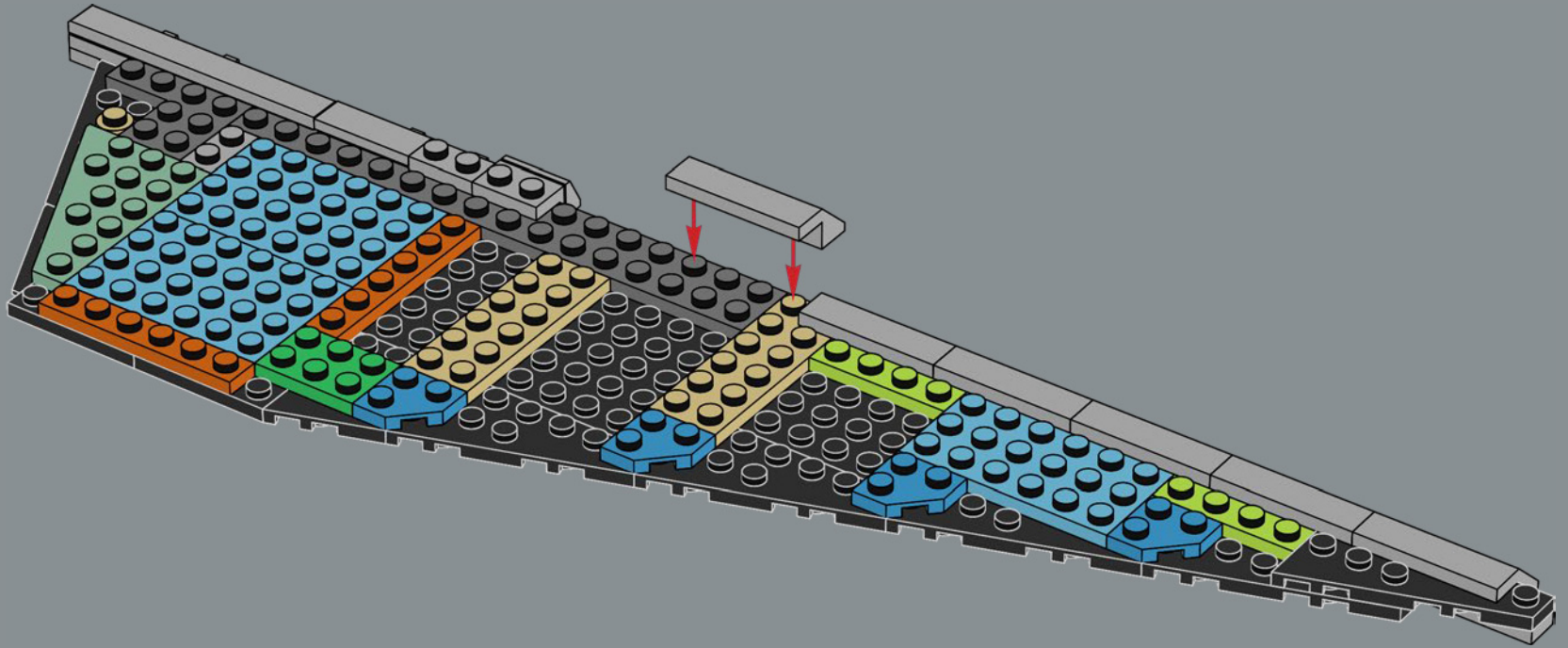



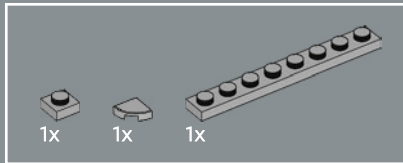
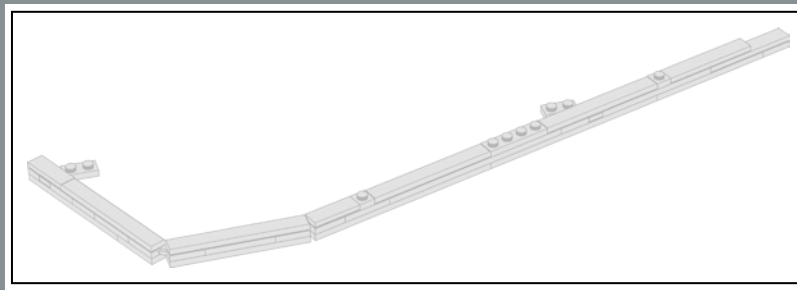

544

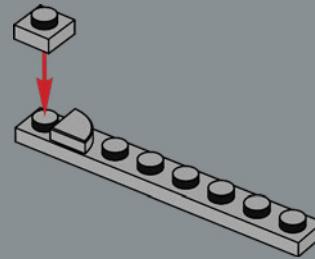

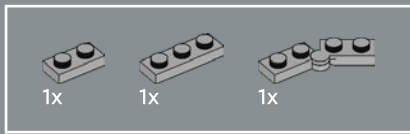

545

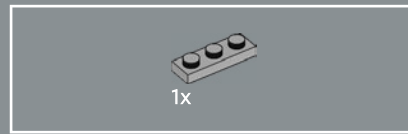
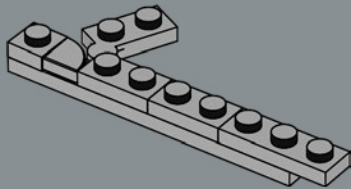

546

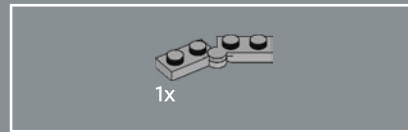
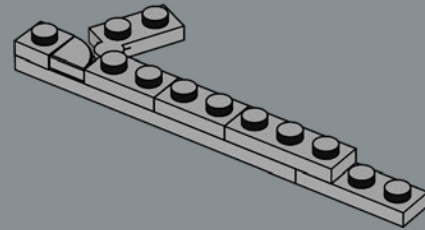

547

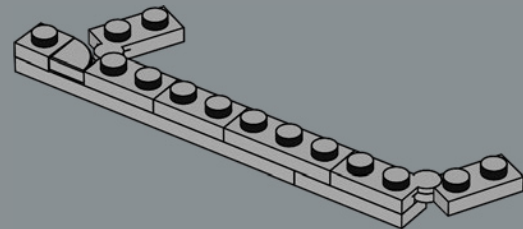

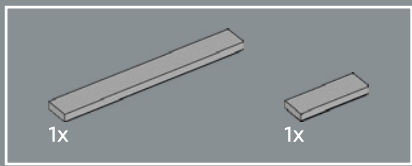

548

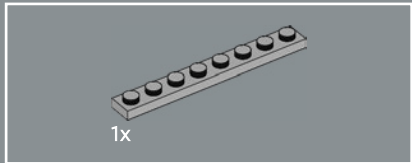
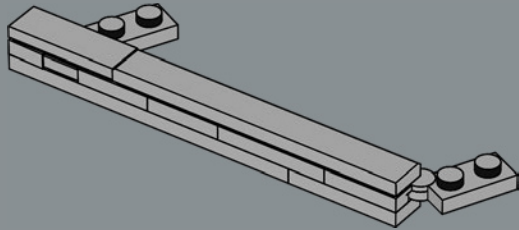

549

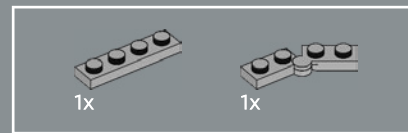
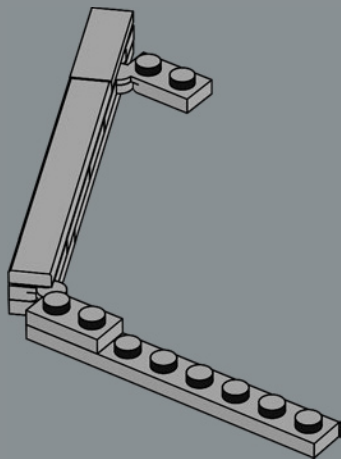

550

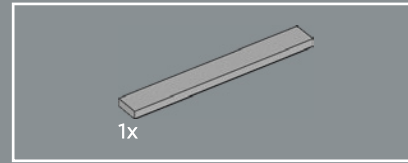
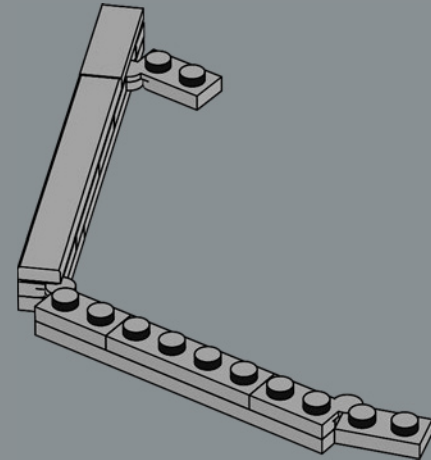

551

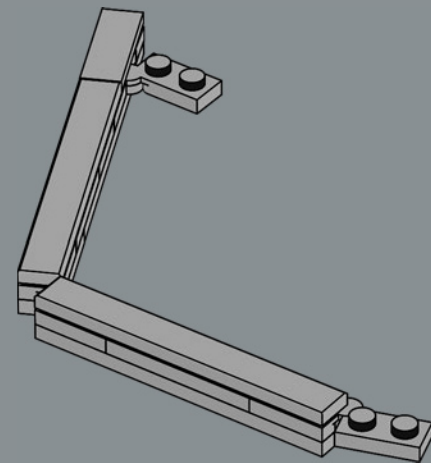

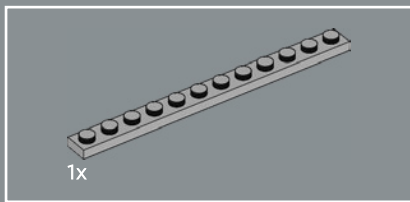

552

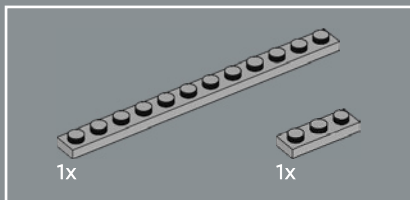
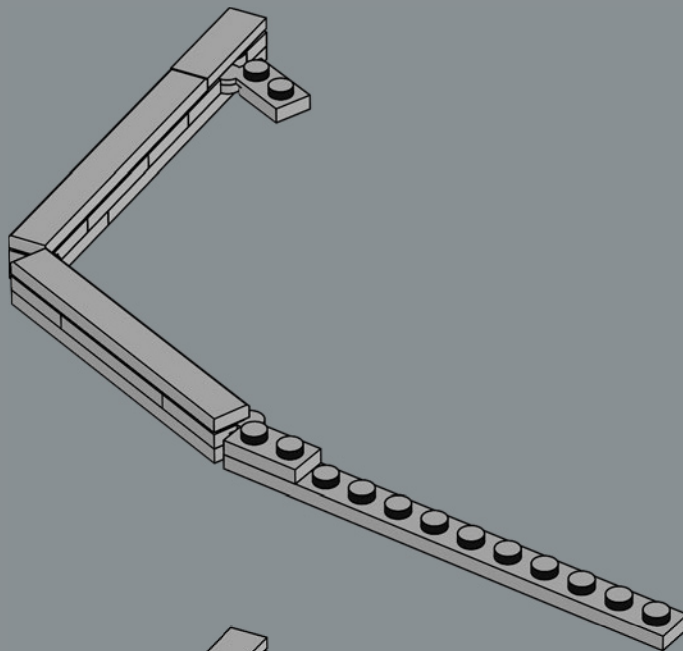

553

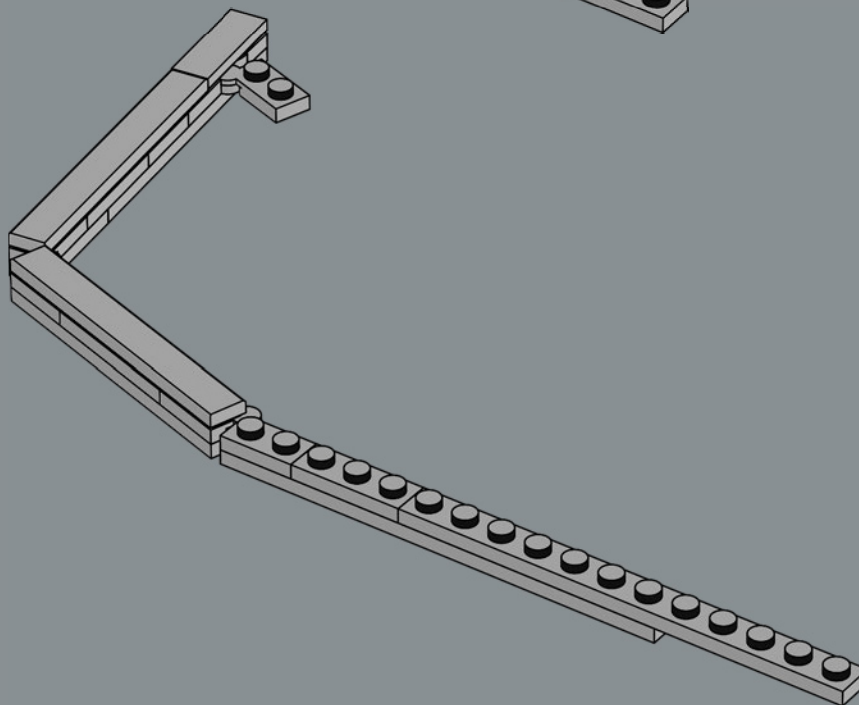



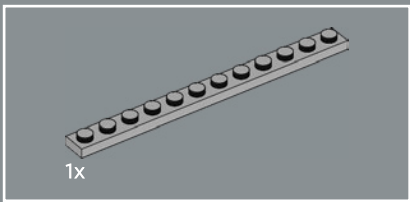

554

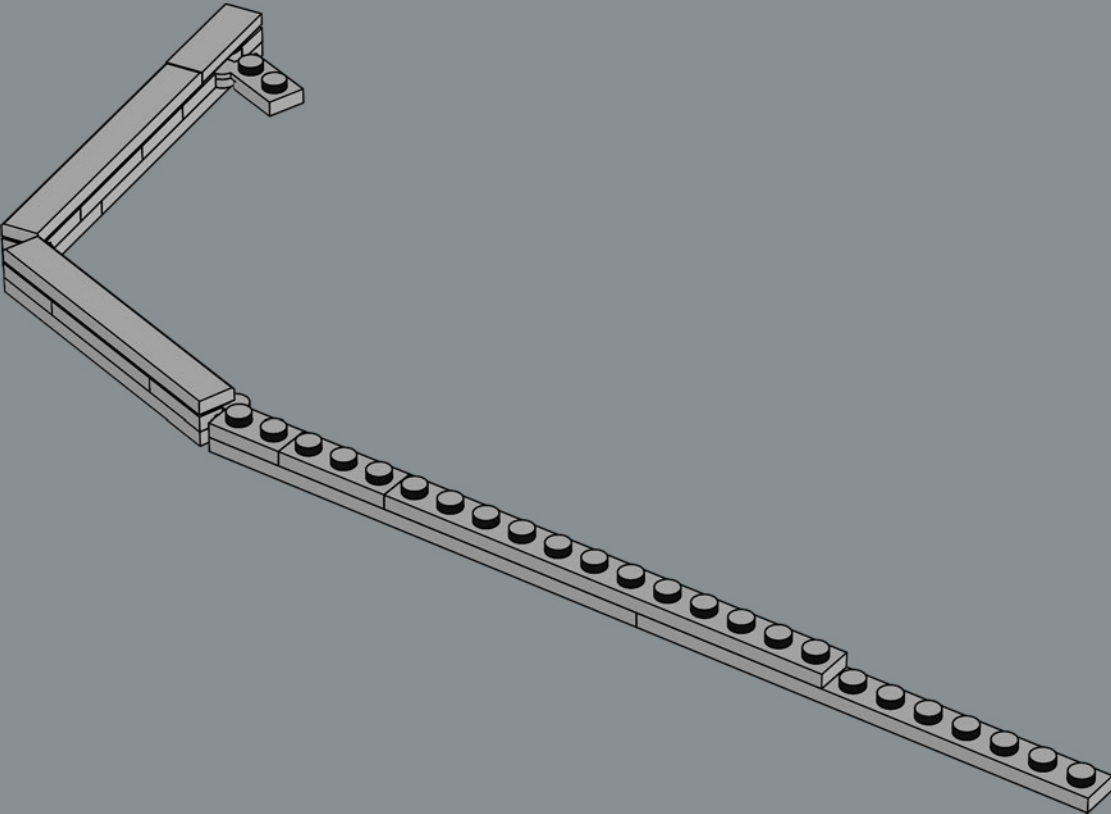

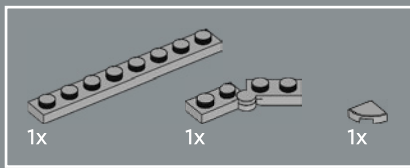

555

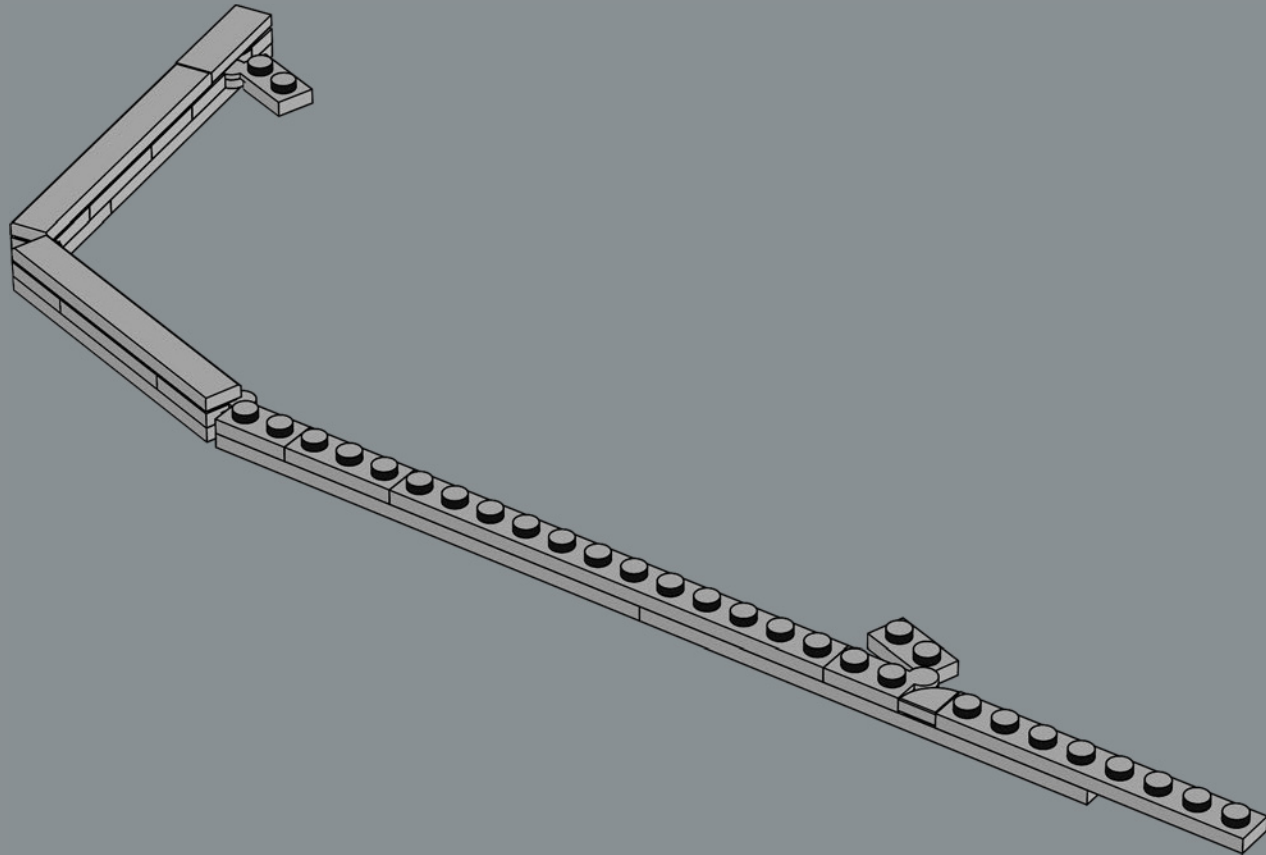

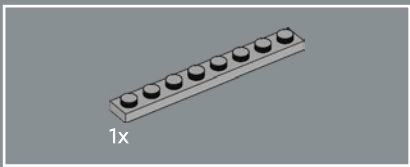

556

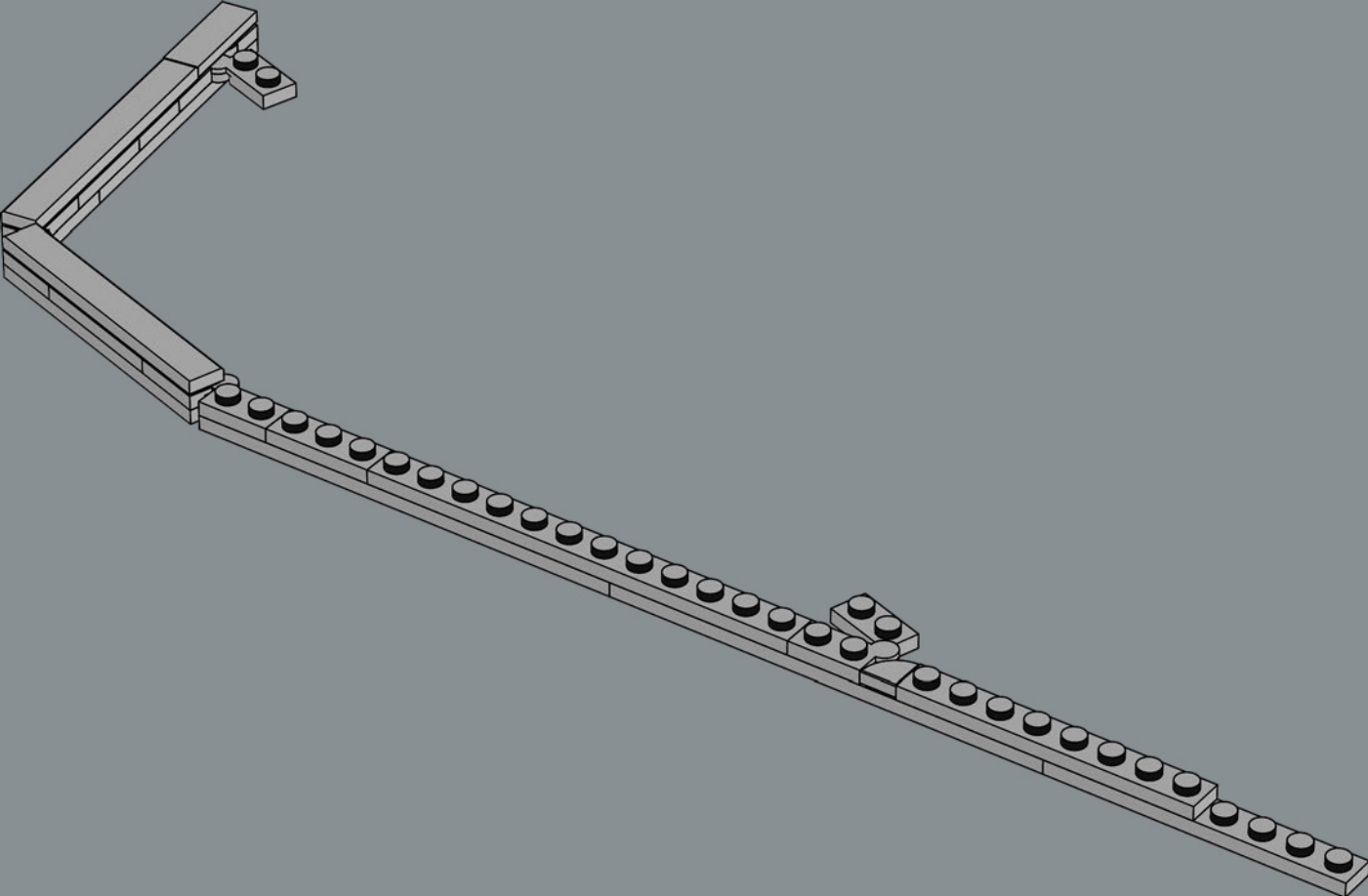

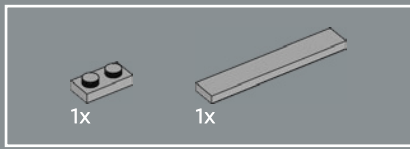

557

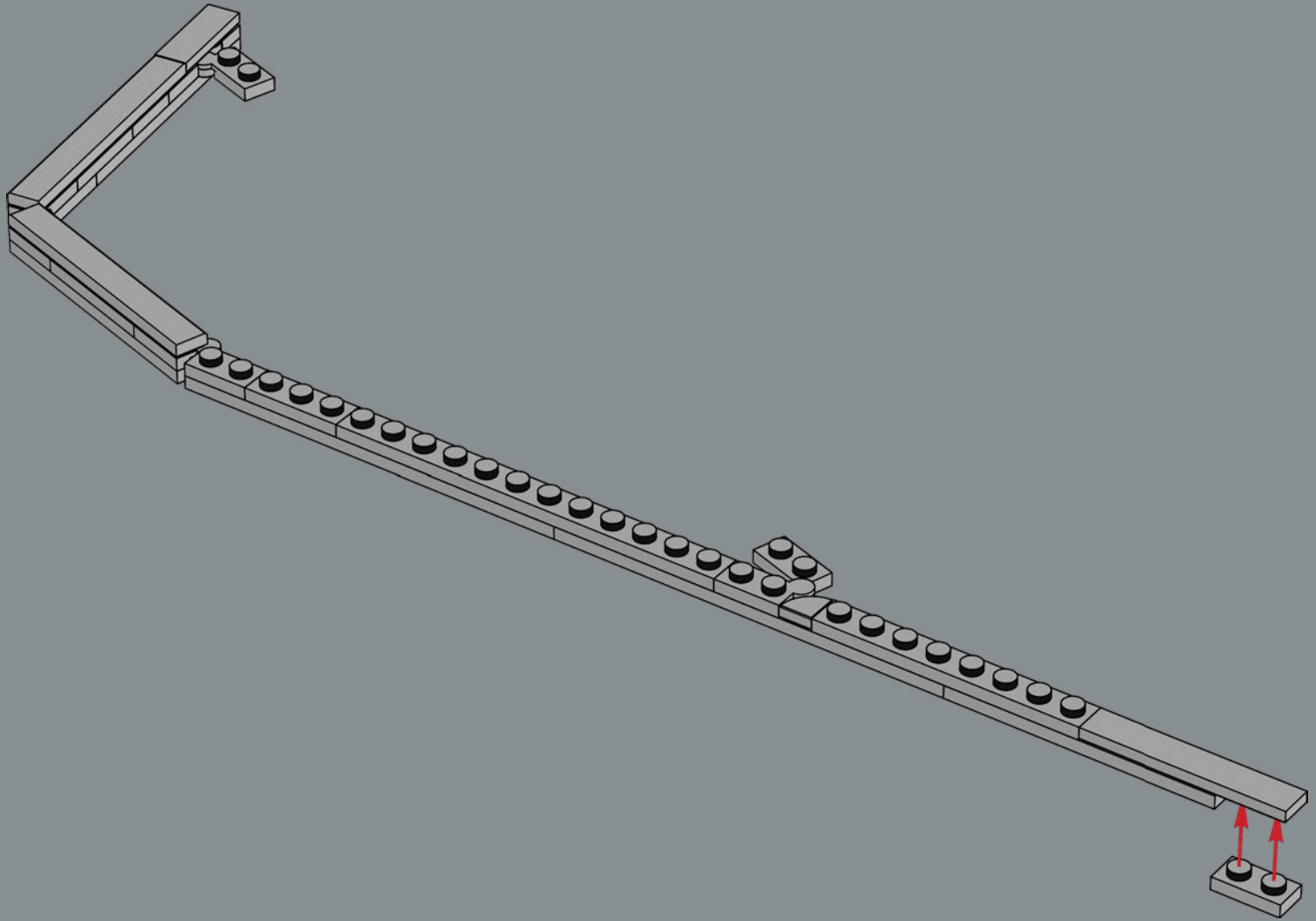



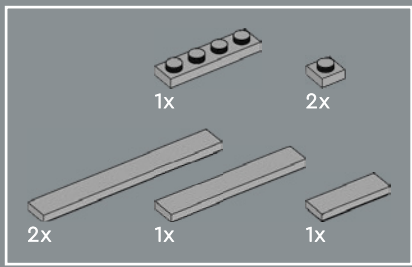

558

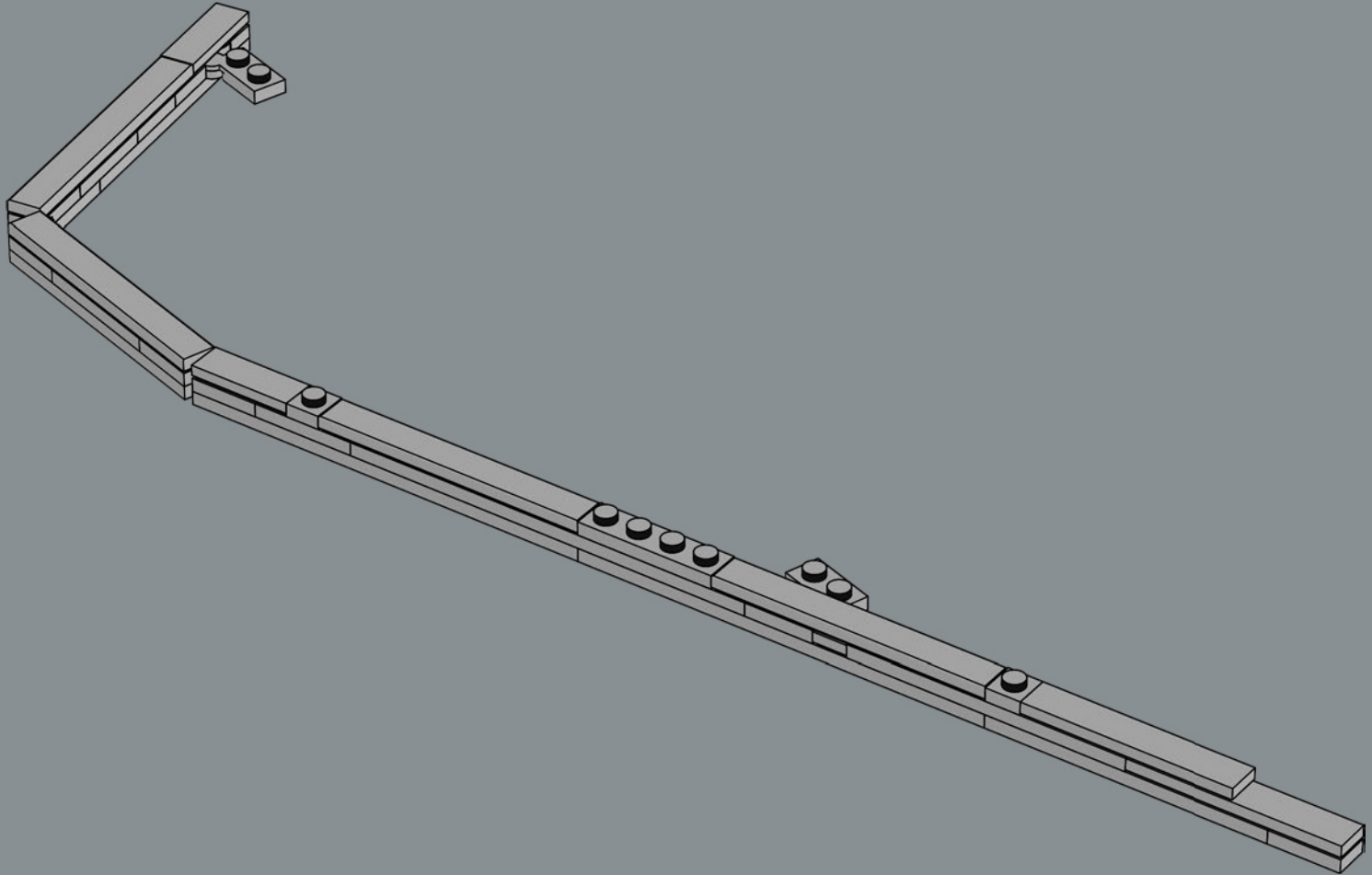

559

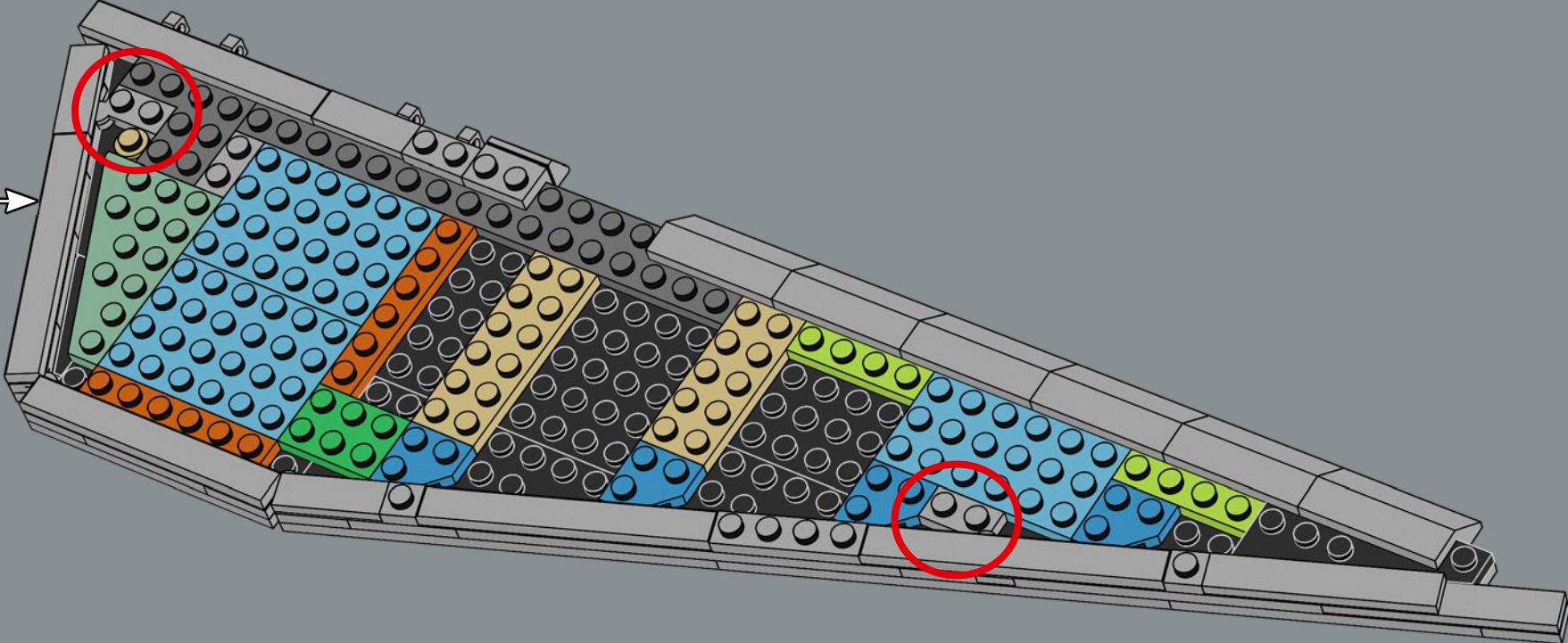

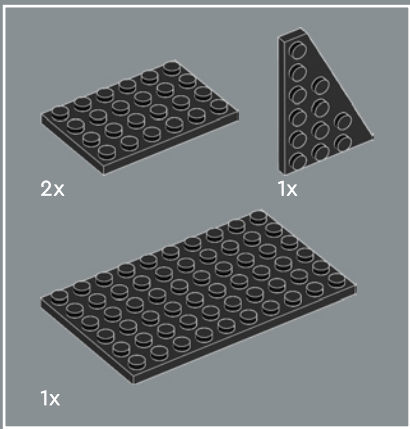

560

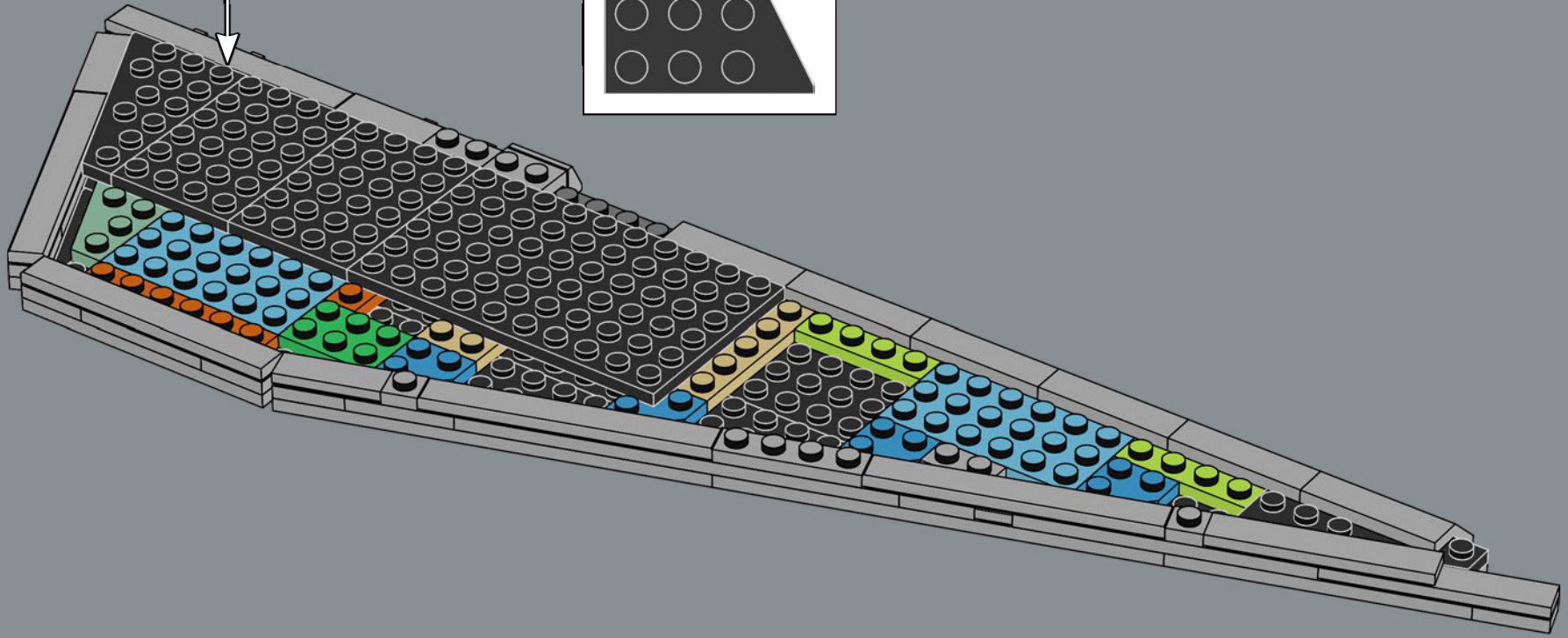
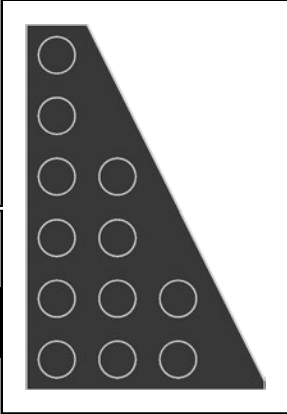

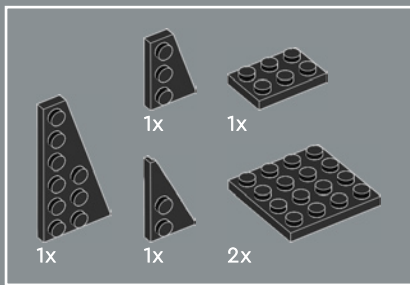

561

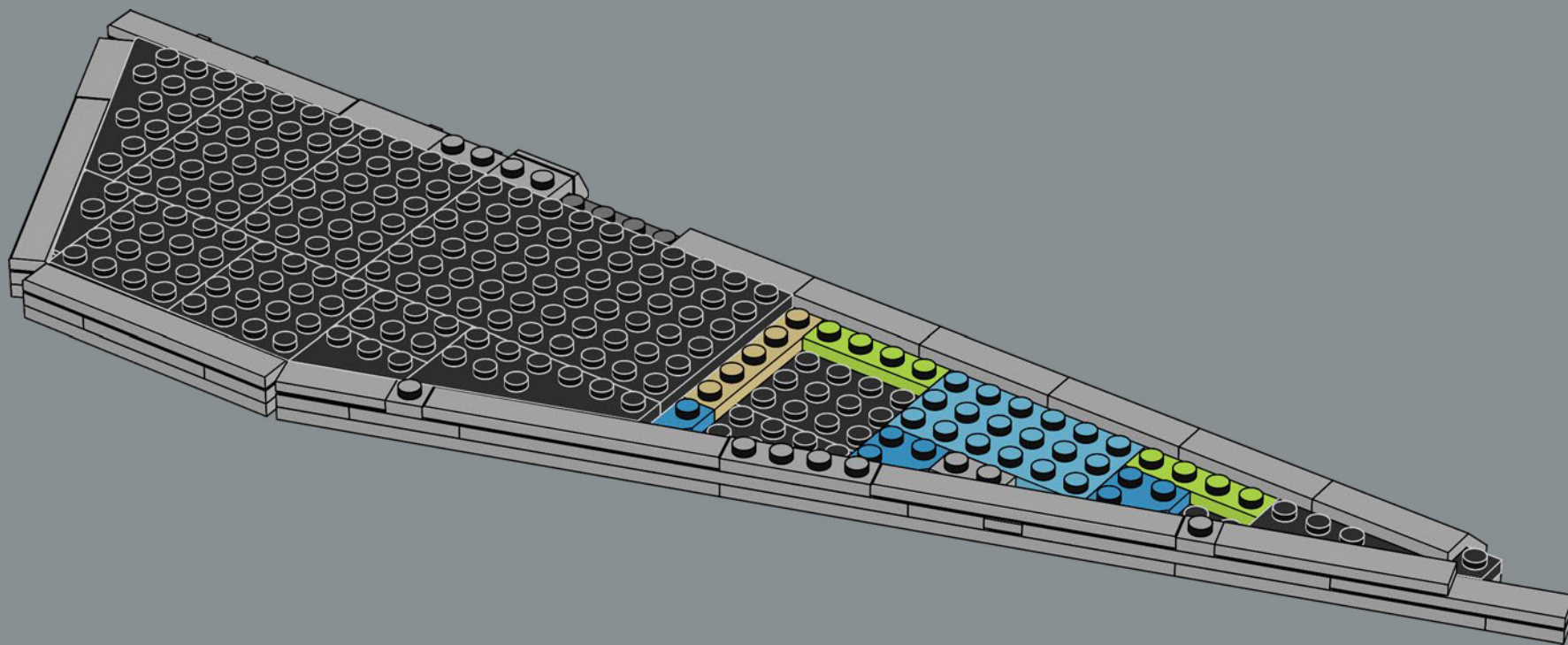



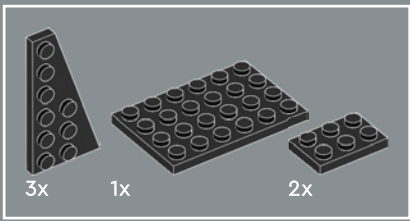

562

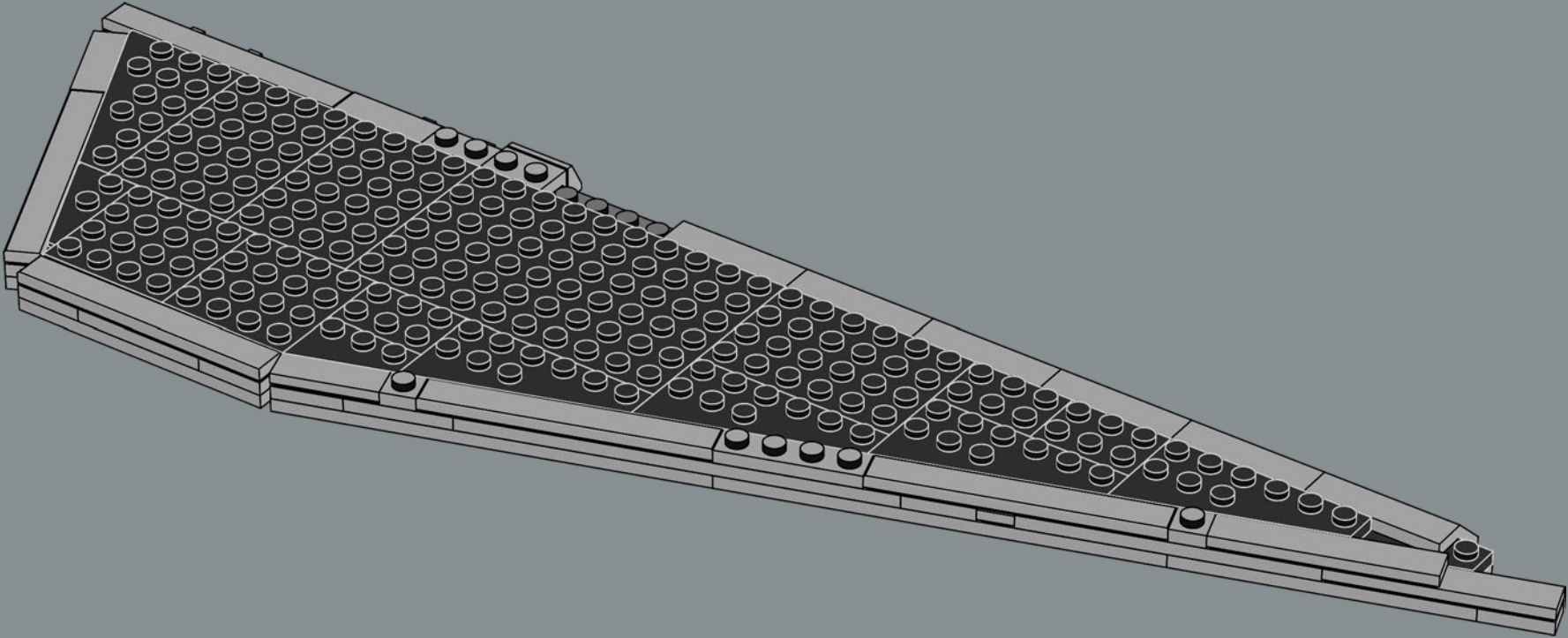

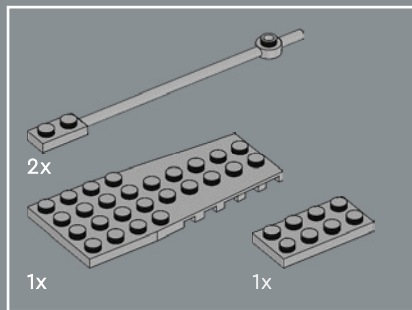

563

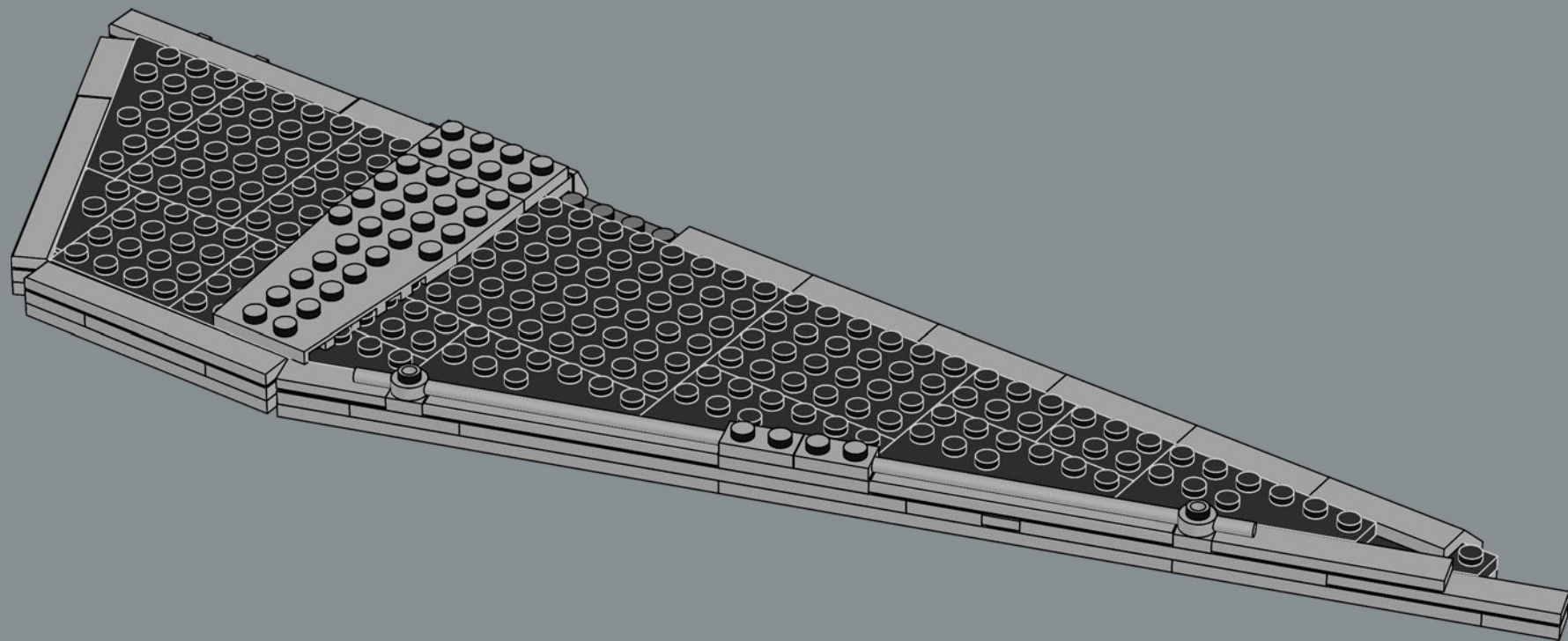

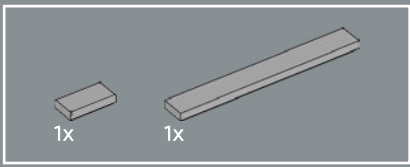

564

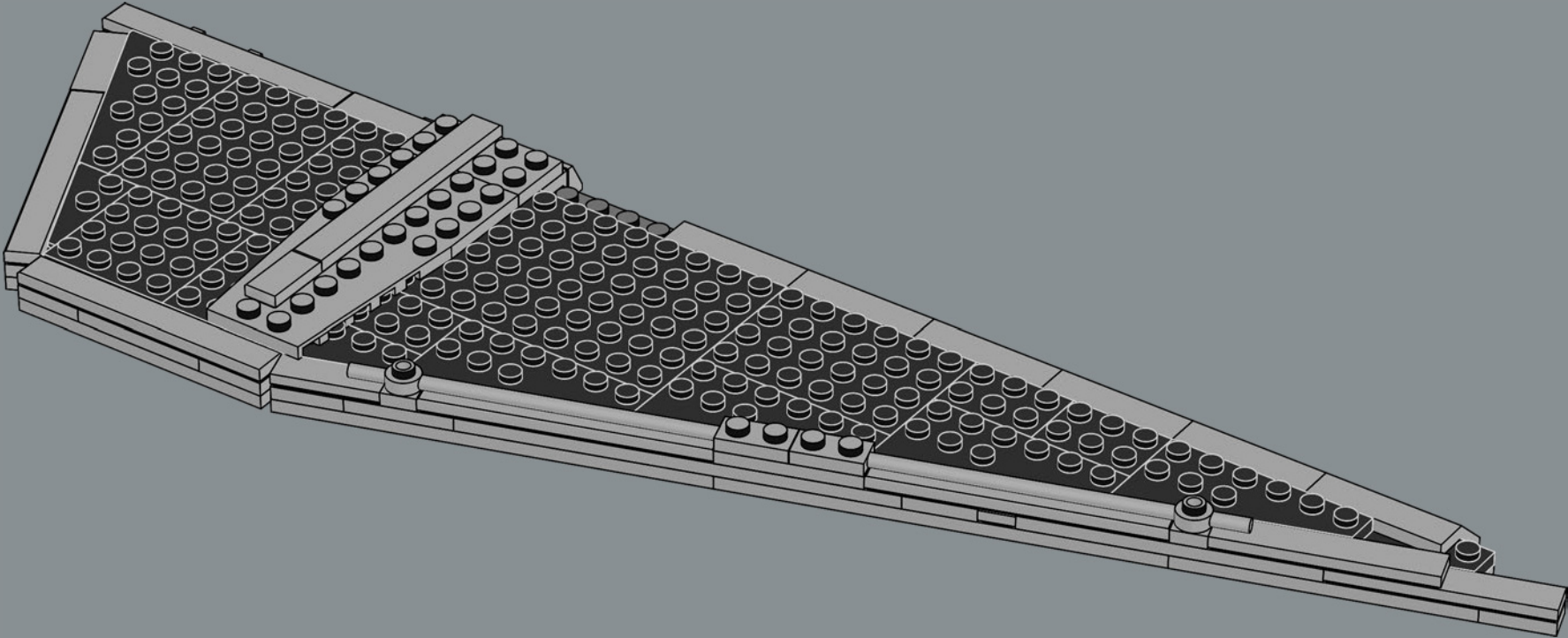

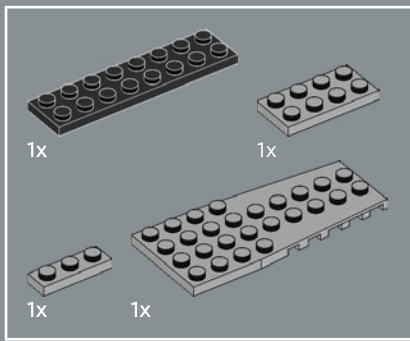

565

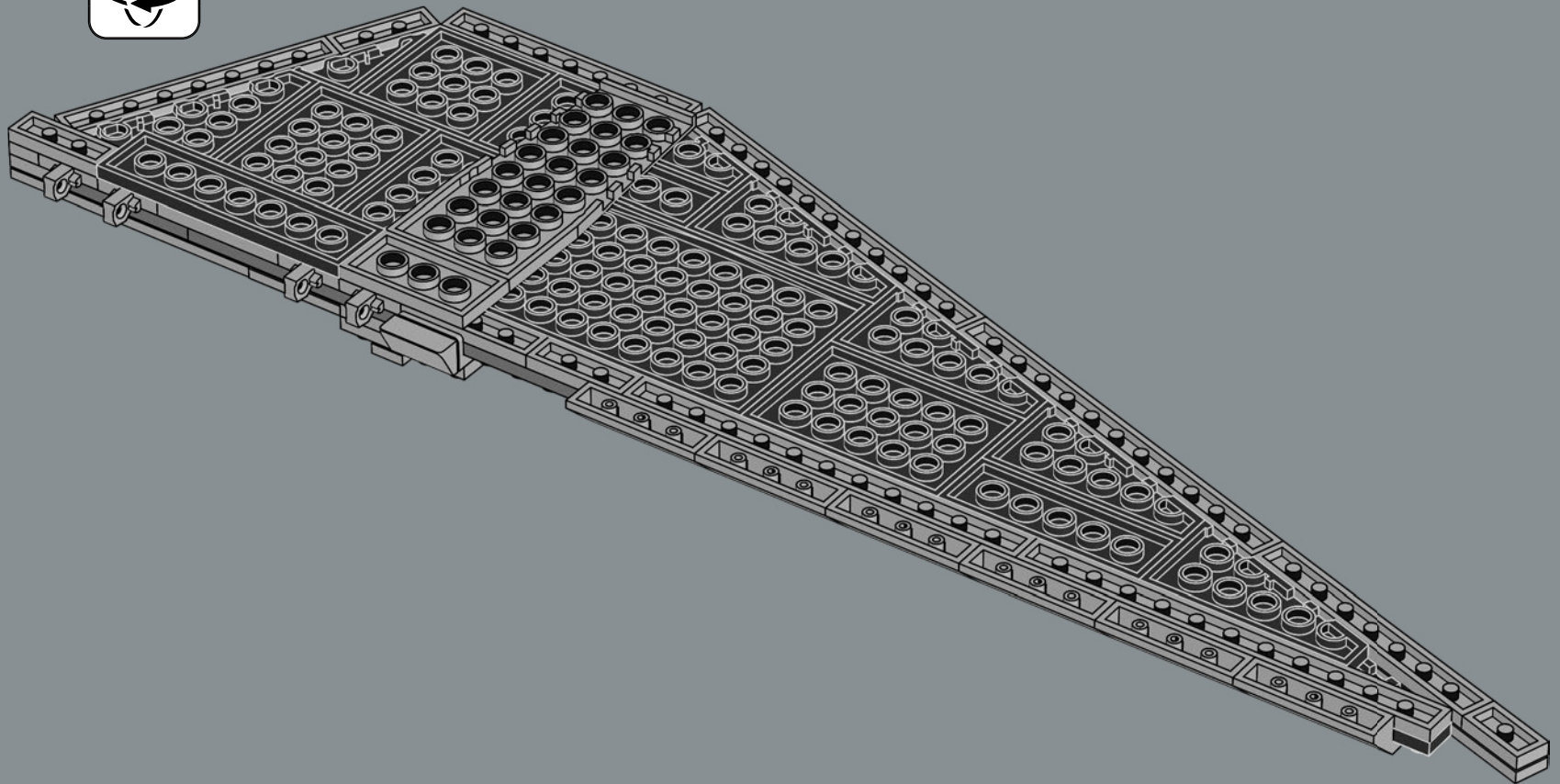



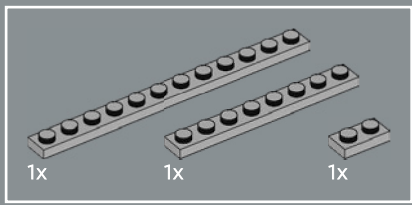

566

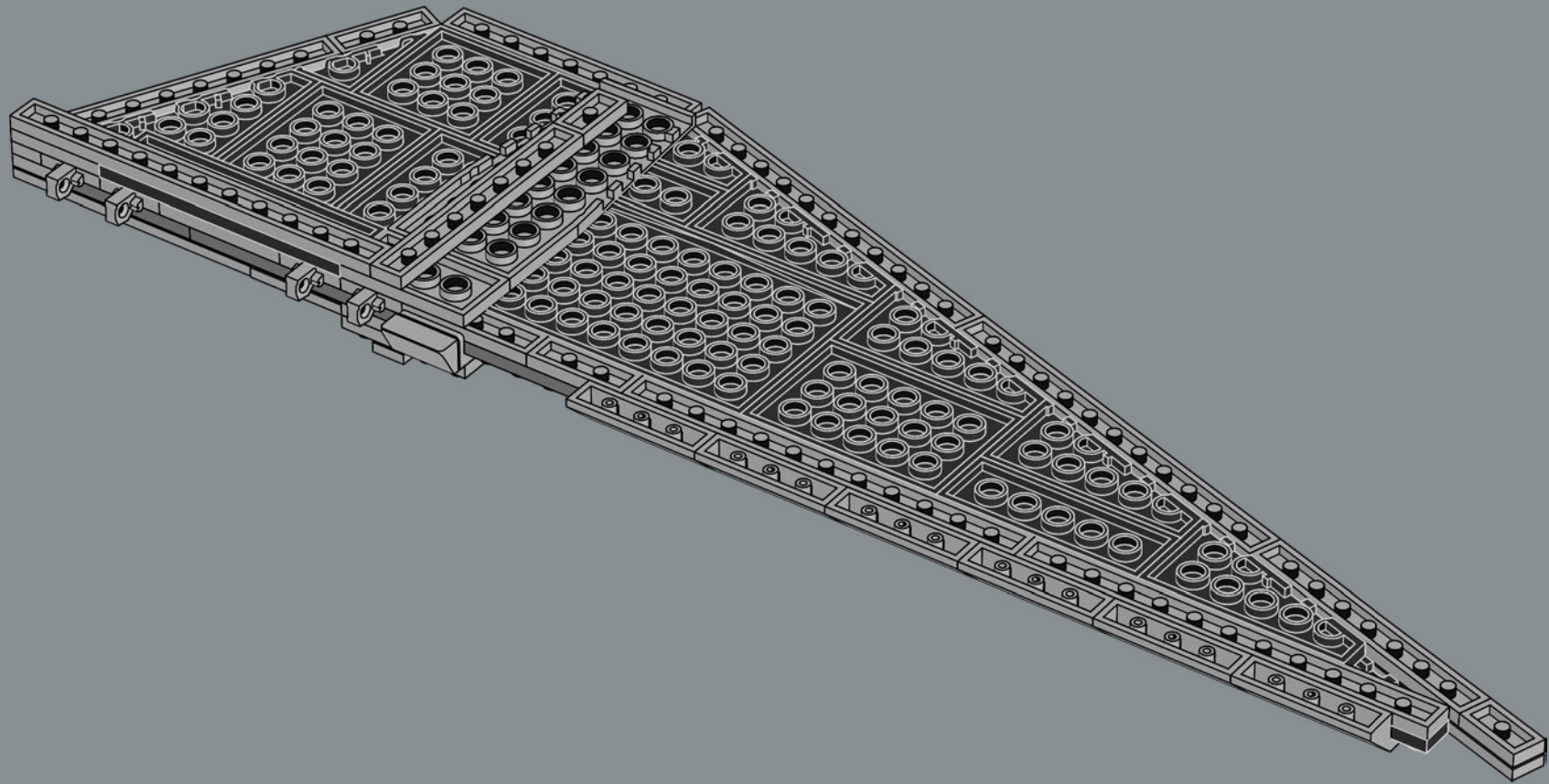

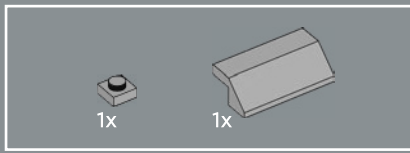

567

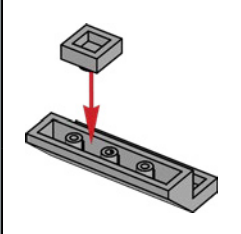
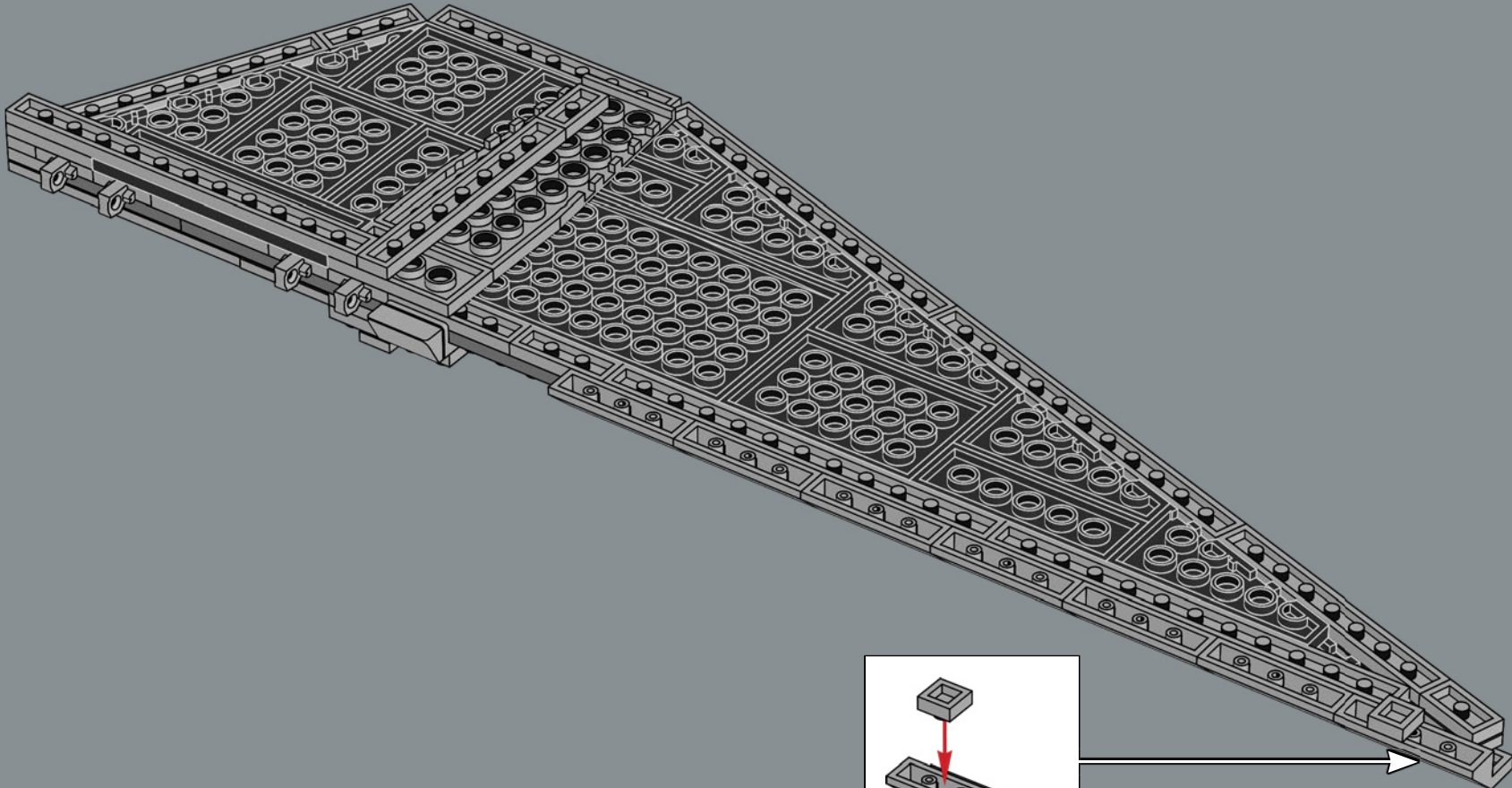

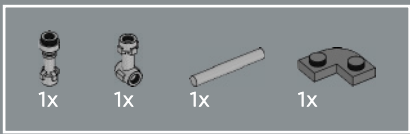

568

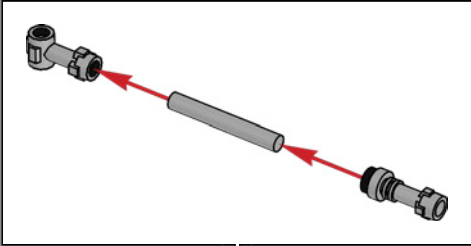
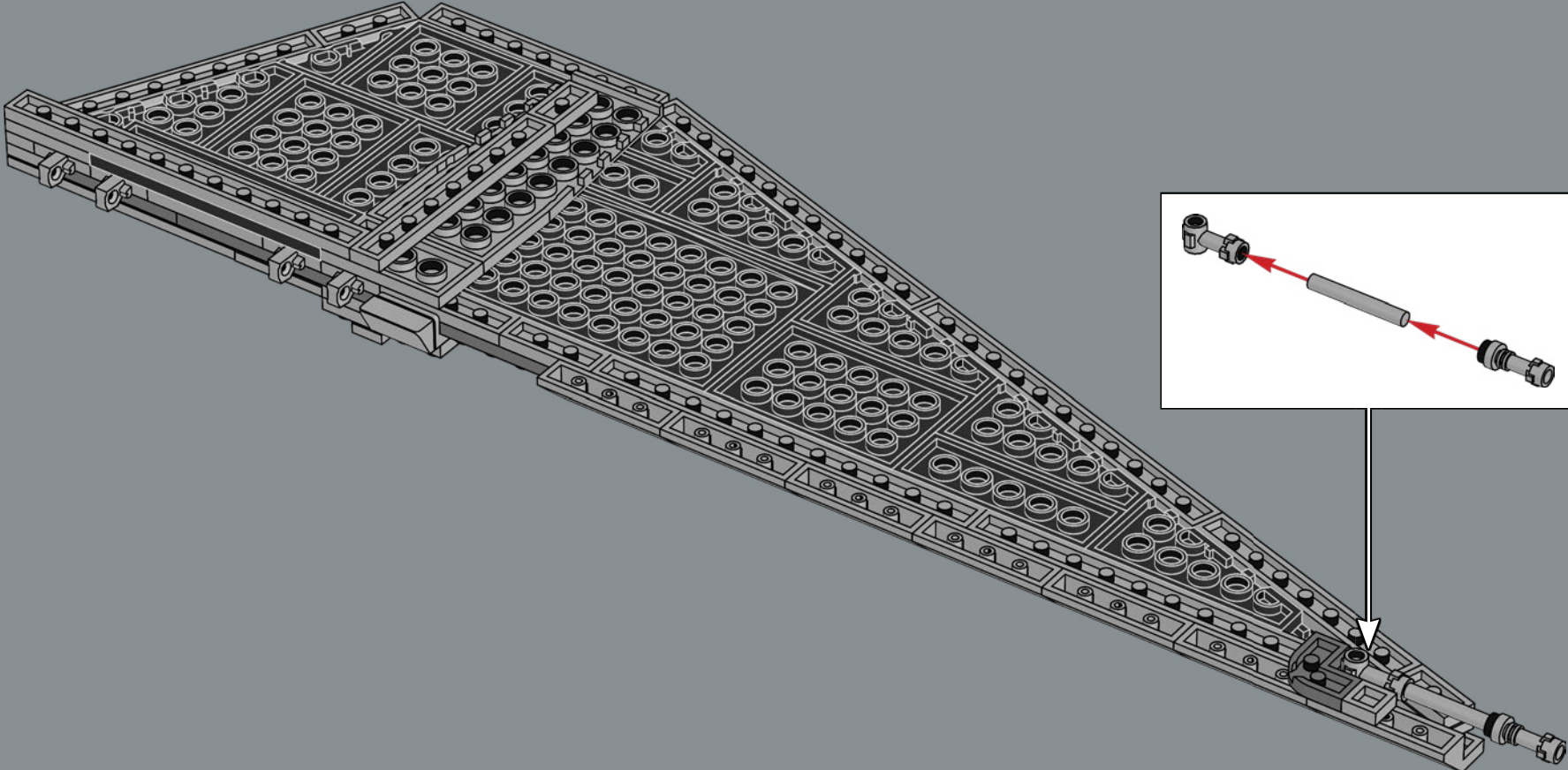



569

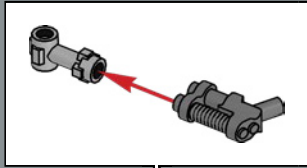
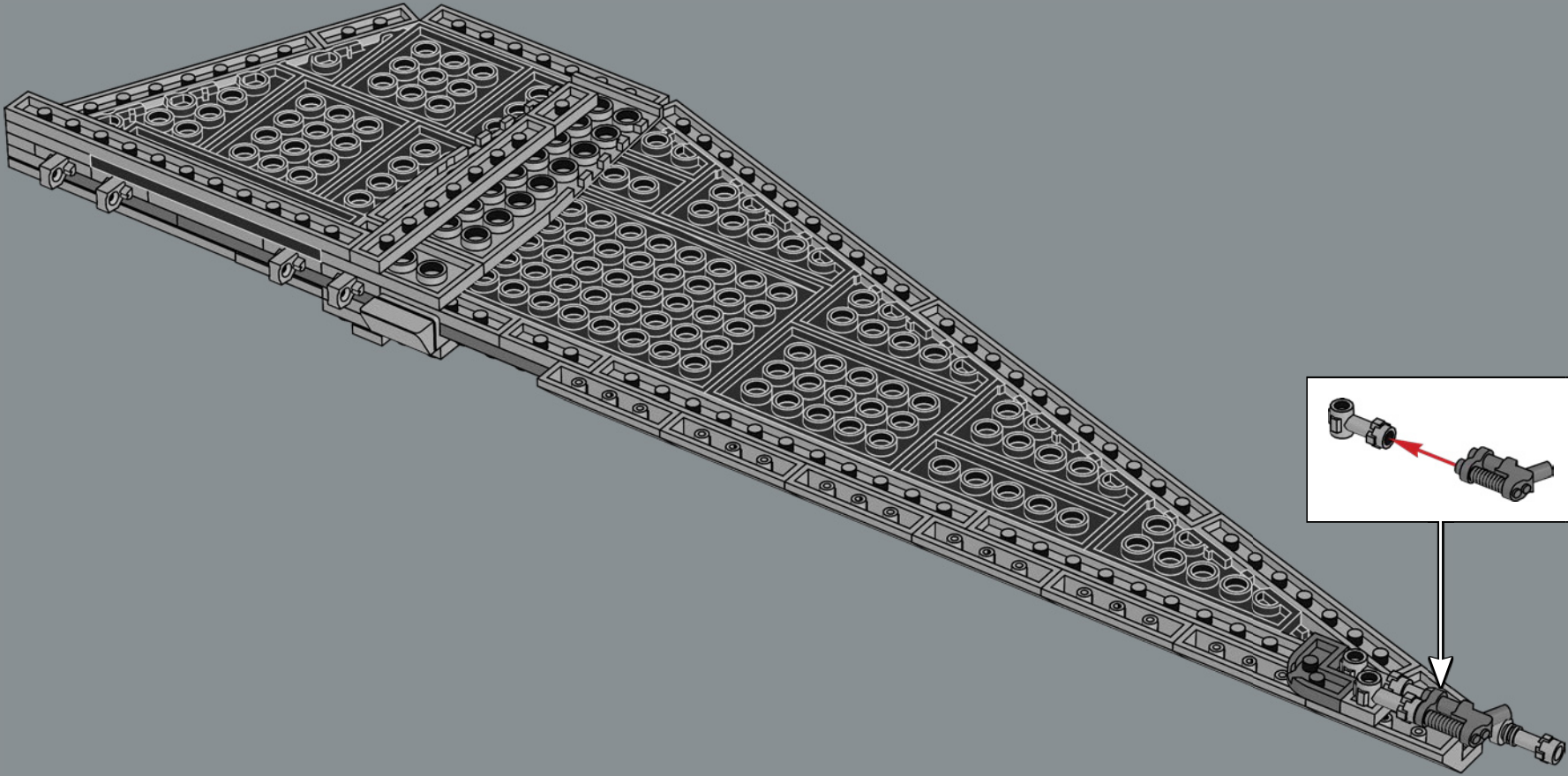



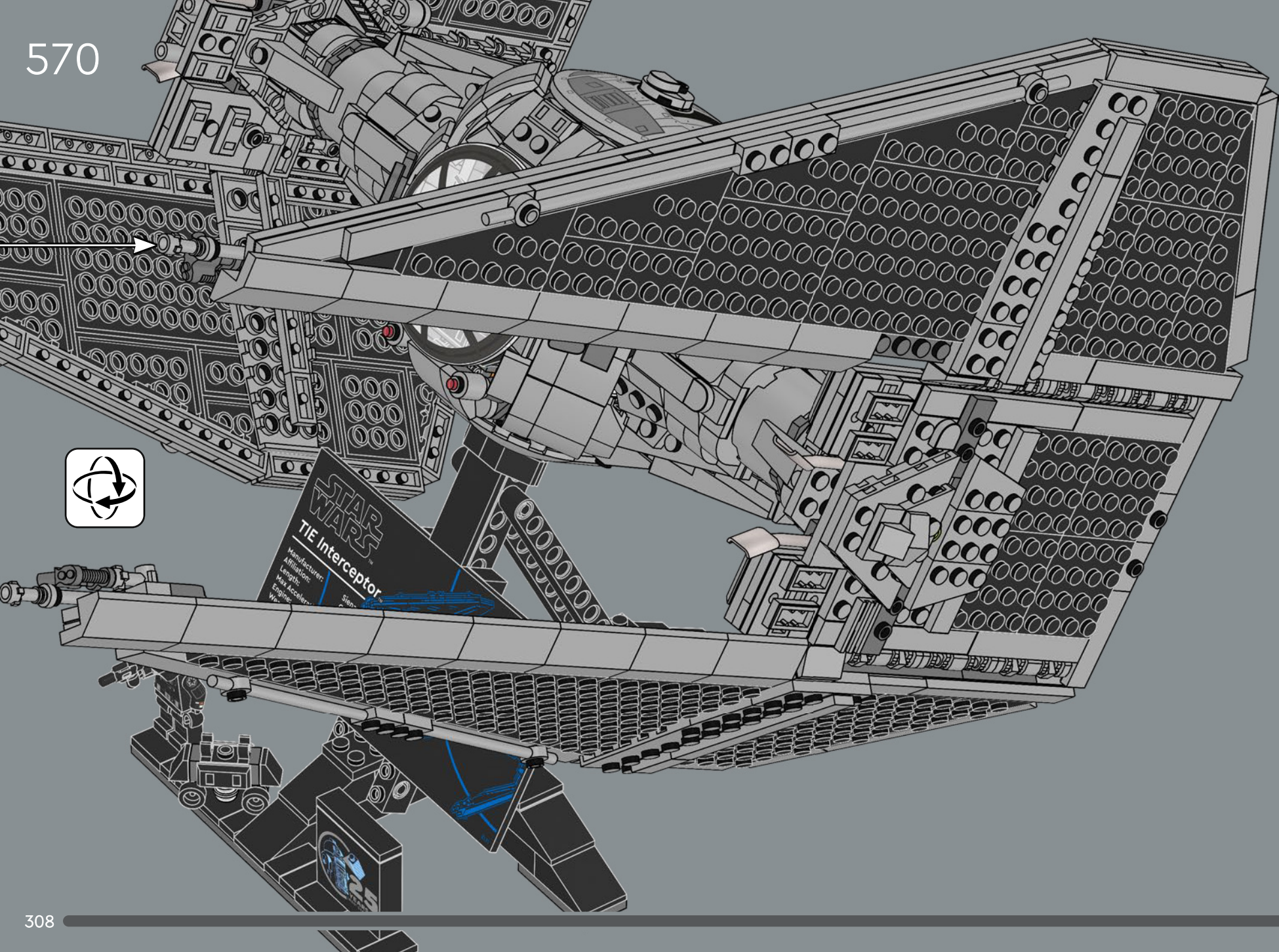



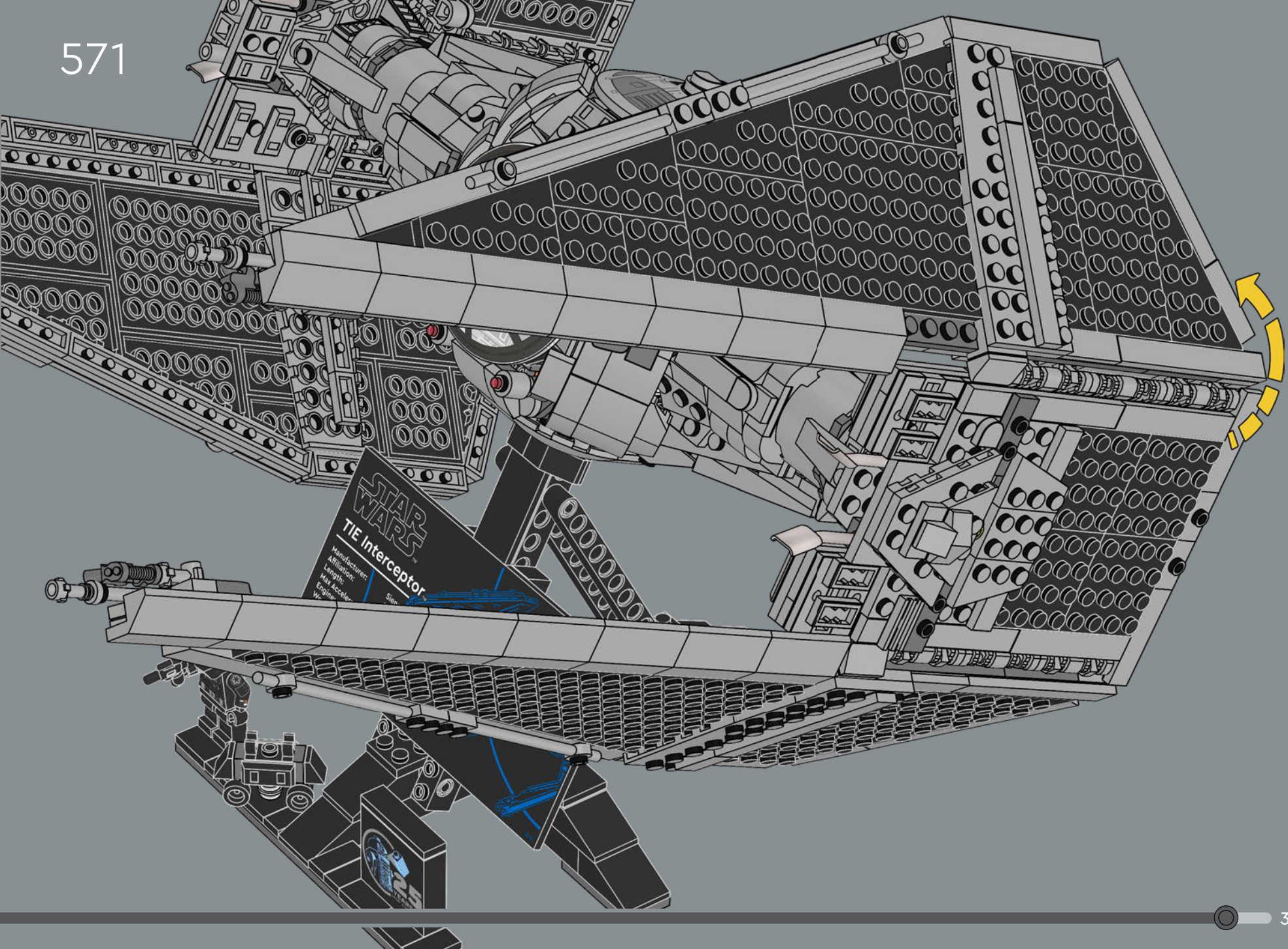



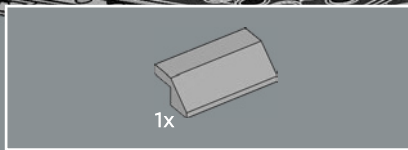

572

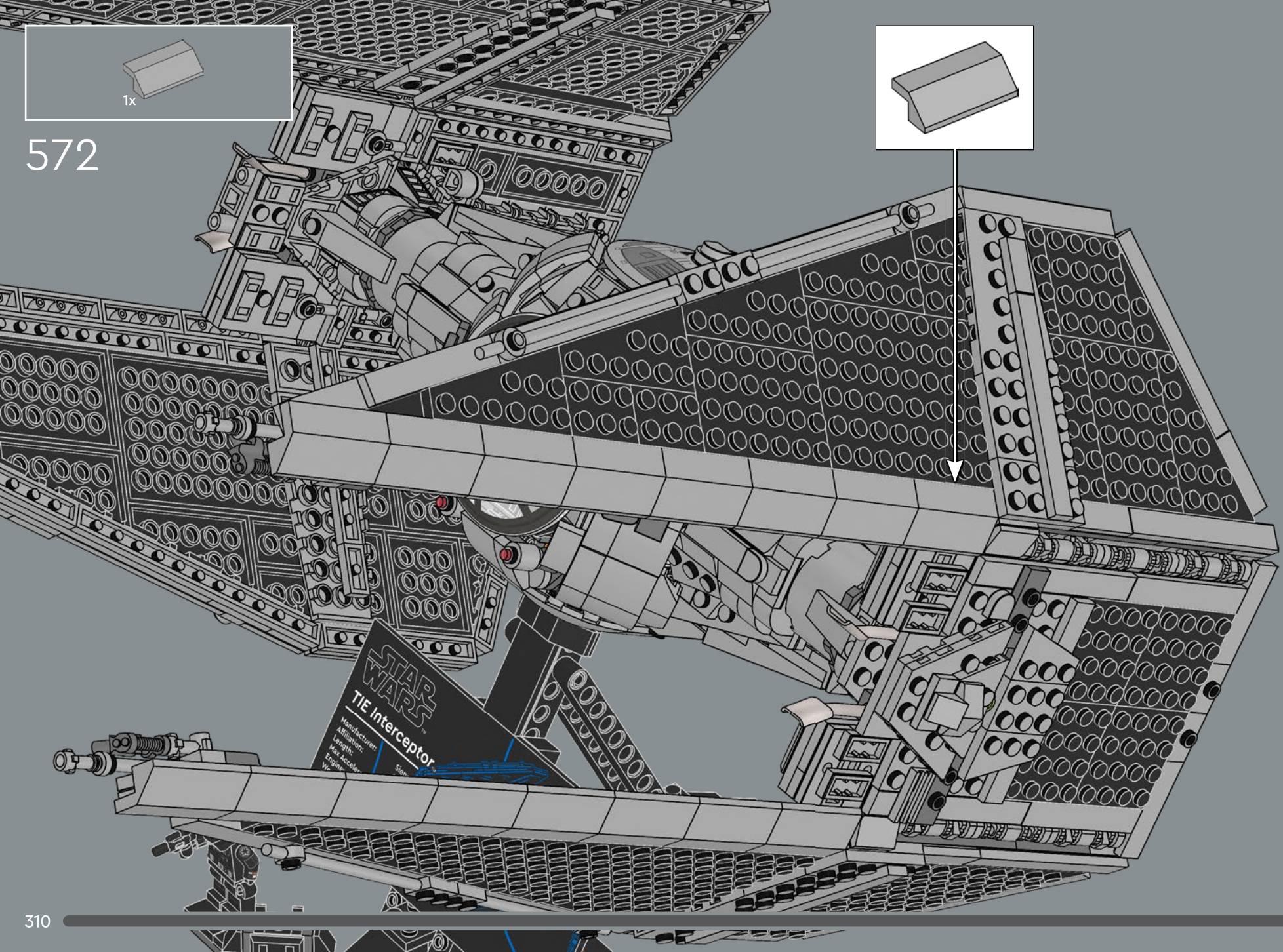
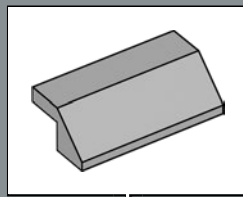

**STAR WARS**  
**TIE Interceptor™**  
Manufacturer:  
Affiliation:  
Length:  
Max. Acceleration:  
Engine:  
Wingspan:  
Sienar

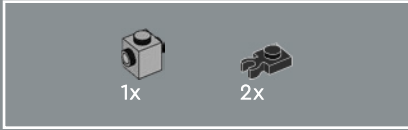
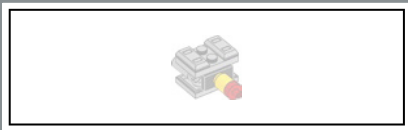

573

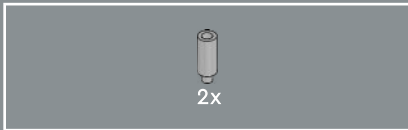
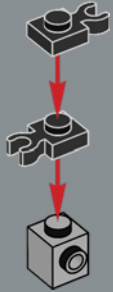

574

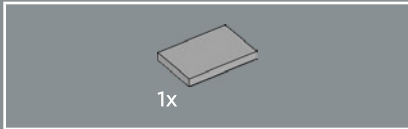
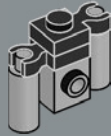

575

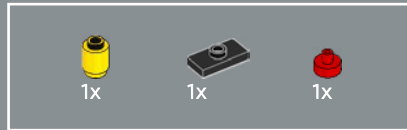
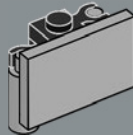

576

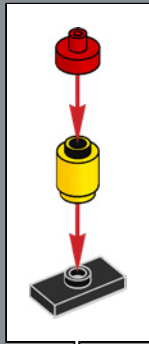
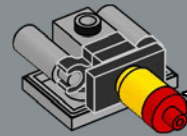

577

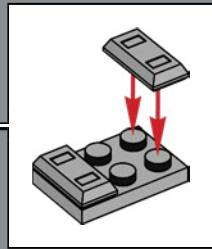
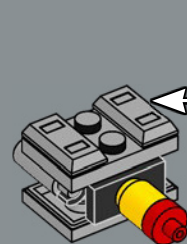



578

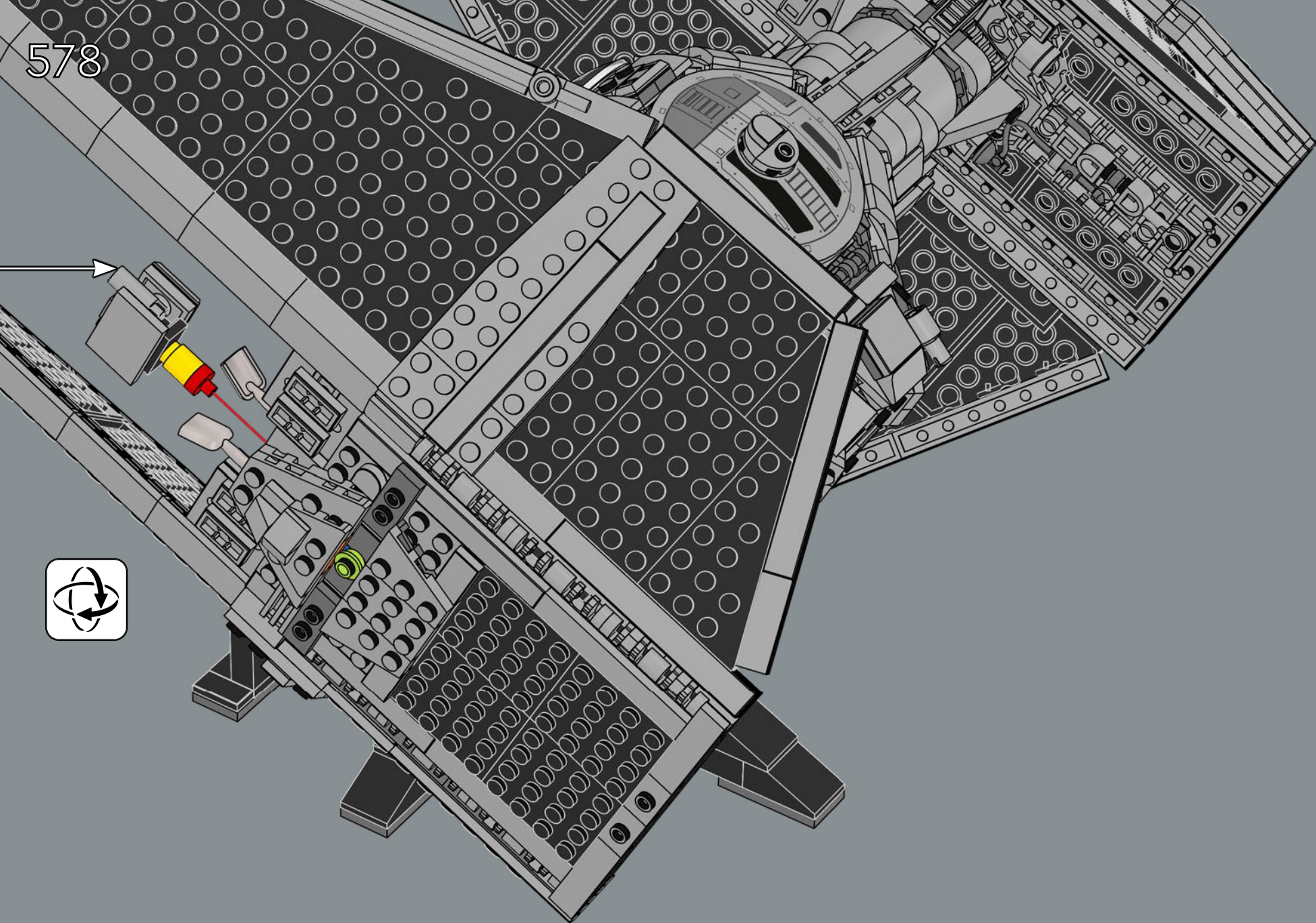



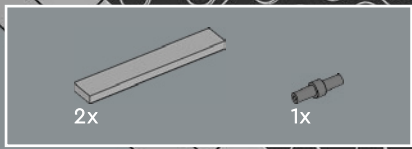

579

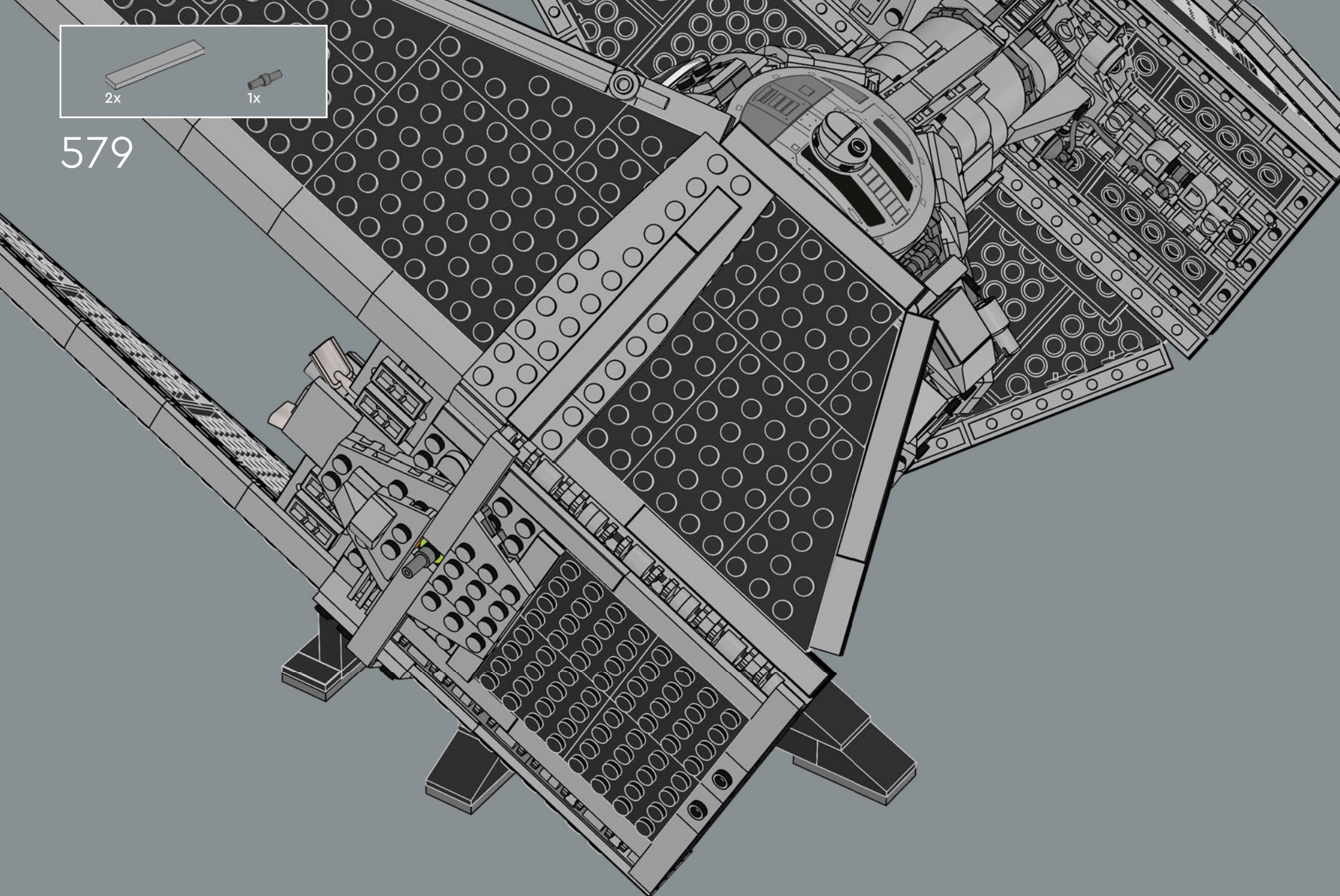



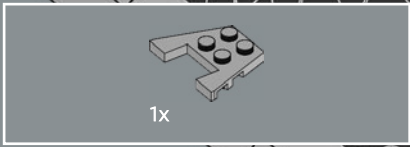

580

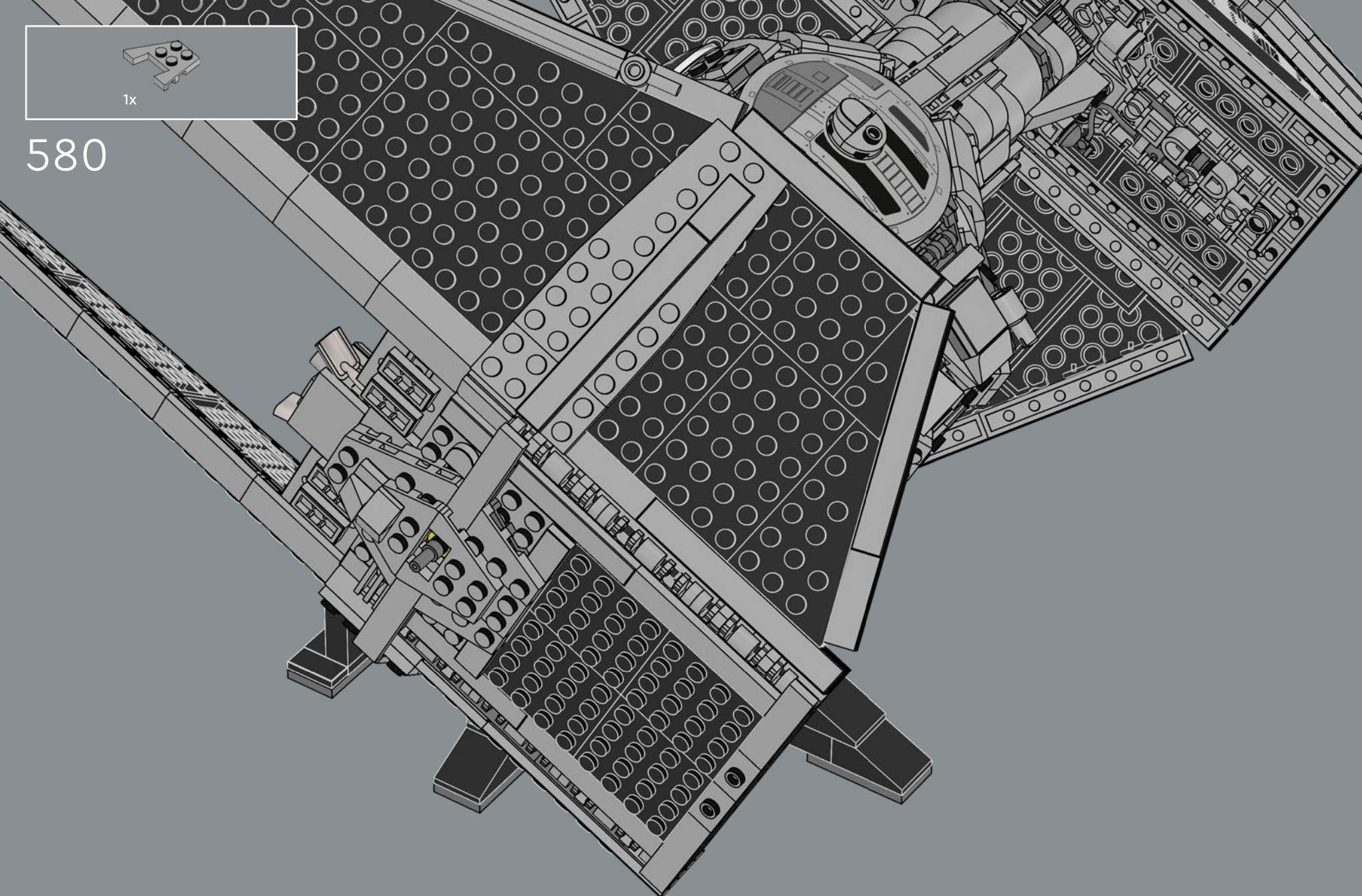





581

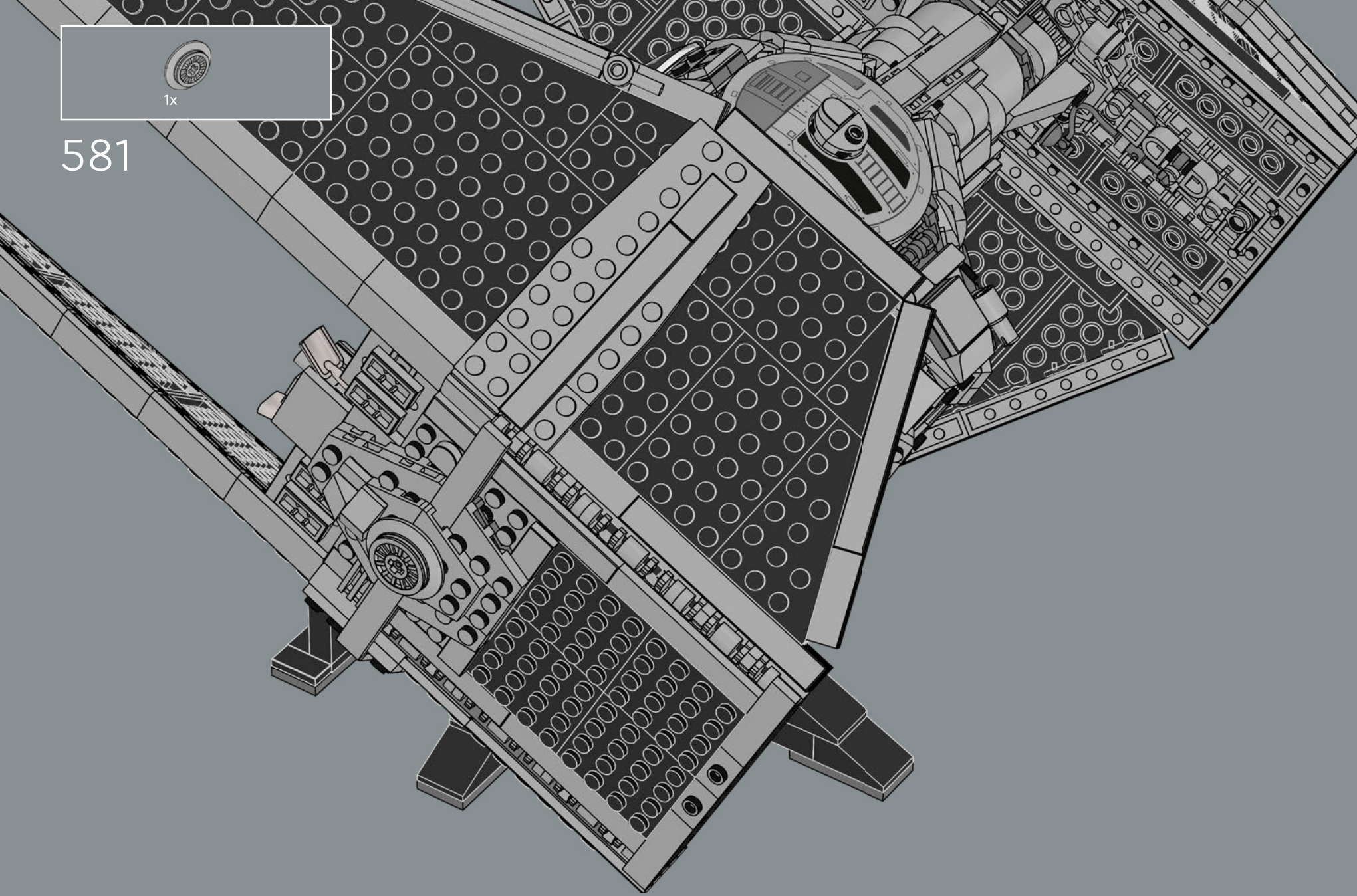



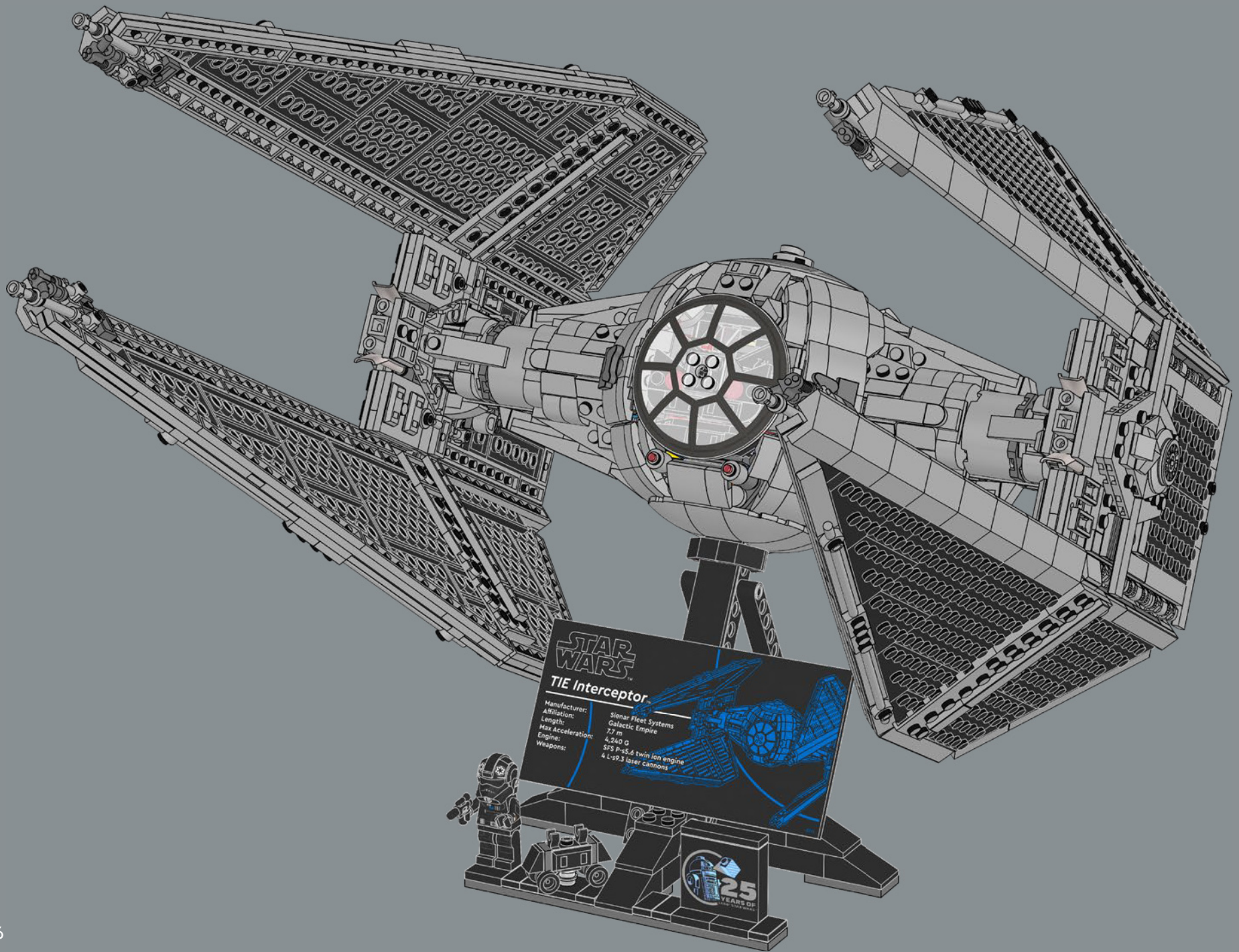

STAR  
WARS

### TIE Interceptor

Manufacturer: Sienar Fleet Systems  
Affiliation: Galactic Empire  
Length: 77 m  
Max Acceleration: 4,240 G  
Engine: SFS P-8.6 twin ion engine  
Weapons: 4 L-9P.3 laser cannons

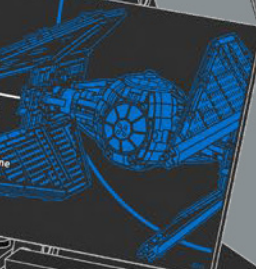



TIE INTERCEPTOR™

**STAR WARS™**

TIE Interceptor™

TIE-Abfangjäger™

L'Intercepteur TIE

Interceptor TIE

Intercetor TIE™

Stíhačka TIE

TIE elfogóvadász™

ТАЙ прехващач

TIE naikintuvas







# YOU COULD WIN



## YOU COULD WIN

Your feedback will help shape the future development of this product series.

Visit:

## DU KÖNNTEST GEWINNEN

Dein Feedback trägt zur Weiterentwicklung dieser Produktreihe bei.

Geh auf:

## VOUS POURRIEZ GAGNER

Vos commentaires nous aideront à concevoir les futurs produits de cette gamme.

Visitez :

## POTRESTI VINCERE TU

La tua opinione ci aiuterà a migliorare la creazione futura di questa linea di prodotti.

Visita:

## PUEDES GANAR

Tu opinión contribuirá al futuro de esta serie de productos.

Visita:

## 轻松获奖

您的反馈将有助于我们在今后改进本产品系列。

请访问:

---

[LEGO.com/productfeedback](https://LEGO.com/productfeedback)

---

You also have the chance to win a LEGO® set.

Terms and conditions apply.\*

Außerdem hast du die Chance, ein LEGO® Set zu gewinnen.

Es gelten die Teilnahmebedingungen.\*

Vous pourriez également gagner un ensemble LEGO®.

Des conditions s'appliquent.\*

Hai anche la possibilità di vincere un set LEGO®.

Termini e condizioni sono applicabili.\*

También tienes la oportunidad de ganar un set LEGO®.

Aplican términos y condiciones.\*

您还有机会赢取乐高®套装。

条款和条件适用。\*

\*[LEGO.com/productfeedback-terms](https://LEGO.com/productfeedback-terms)



2x  
6320310

4x  
6435932

2x  
6034044

4x  
6070698

4x  
6266219

2x  
403201

21x  
4113917

3x  
6223291

8x  
4113993

2x  
4509897

16x  
4161734

1x  
6115248

4x  
300421

1x  
300121

**320**

2x  
6170390

12x  
6173961

1x  
6480856

12x  
6378120

4x  
6473603

1x  
4157223

4x  
6385920

4x  
6371957

4x  
242021

2x  
302121

6x  
6215539

4x  
6266205

4x  
6001806

4x  
6346804

2x  
6118830

2x  
6482573

6x  
6313131

8x  
6299413

2x  
6280384

4x  
370123

10x  
306224

2x  
389424

1x  
6130007

4x  
4504382

2x  
6267487

4x  
6069000

1x  
6181720

1x  
6181713

8x  
329826

1x  
6267482

4x  
614126

1x  
6284070

2x  
6172383

4x  
6186675

2x  
6335388

4x  
6299338

4x  
6308000

2x  
6157554

10x  
6330189

1x  
6266207

11x  
6000650

4x  
6310268

1x  
4140588

2x  
6336989

2x  
6013867

1x  
6265730

8x  
6469445

1x  
6141554

4x  
6295295

4x  
6295293

1x  
6141556

2x  
6210270

4x  
4180508

4x  
4180536

4x  
6174243

18x  
4283046

18x  
4283047

4x  
6258209

4x  
6258214

4x  
4160025

6x  
6325190

1x  
6487885

1x  
6405216

8x  
6491608

1x  
6405194

1x  
6508152

1x  
6360207

2x  
6253695

1x  
6325254

12x  
6279875

1x  
393826



1x  
473326



2x  
6436425



4x  
370026



8x  
4584274



4x  
654126



1x  
300326



1x  
6483080



3x  
4181144



1x  
4617860



2x  
273026



2x  
246526



2x  
370326



2x  
6039869



6x  
306926



14x  
6214807



1x  
4565323



7x  
6192346



16x  
302126



4x  
6254045



1x  
243126



4x  
6174917



4x  
4560182



5x  
366626



4x  
370526



24x  
4243819



8x  
379526



8x  
379526



19x  
6092585



17x  
6156991



1x  
6105963



2x  
6318582



24x  
303226



4x  
303426



1x  
383226



4x  
303026



8x  
303326



2x  
4522933



1x  
6001494



1x  
6472397



12x  
302128



4x  
6424859



2x  
6382577



2x  
6240030



6x  
4528604



6x  
6258607



2x  
6507880



14x  
4159007



4x  
6477975



1x  
6240515



4x  
4187743



8x  
4537936



8x  
4537936



8x  
4537936



8x  
4537936



2x  
6190251



8x  
6310279



4x  
6327442



1x  
6223219



2x  
6449566



2x  
6449566



2x  
6449565



2x  
4213567



6x  
6383177



2x  
4211412



20x  
4521921



4x  
6407412



1x  
4211640



1x  
4211640



1x  
4211640



16x  
4568637



2x  
4211488



3x  
4211421



6x  
6013497



32x  
6475652



2x  
6485155



13x  
6225139



13x  
6225142



31x  
6028813



2x  
6144138



32x  
6285778



4x  
6227184



27x  
6102357



3x  
6132207



1x  
4622803



13

4



4x  
6276969



8x  
4211415



2x  
6401023



24x  
4211399



7x  
4211350



26x  
6066097



45x  
4211398



23x  
4211414



4x  
4211353



1x  
4211413



2x  
6177078



20x  
4558169



6x  
6211969



46x  
4211429



30x  
4211396



2x  
6171894



2x  
6171894



16x  
6251044



4x  
4211356



18x  
4211445



8x  
4211395



16x  
6372029



4x  
6079461



16x  
4211549

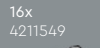

2x  
4211837



4x  
4211452



28x  
4211481



20x  
4211425



2x  
4211406

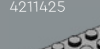

10x  
4251149



10x  
4251149

10x  
4251149

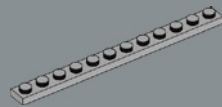

24x  
4514846



8x  
6277023



8x  
6448793



2x  
6420741



2x  
6507791



4x  
6043656



1x  
6225230



16x  
6266251



10x  
6004990



5x  
4654582



8x  
4211568



4x  
6319336



18x  
4515369



2x  
6421522



12x  
6266279



12x  
6266279



6x  
6335328



2x  
6335378



9x  
6250597



6x  
6227897



16x  
6176433



14x  
4211791



14x  
4211794



4x  
4282789



4x  
4282786



8x  
6163990



4x  
6491606



2x  
4507056



4x  
6508016



4x  
6508016



4x  
6508016



4x  
6508016



4x  
6508016



2x  
6170521



1x  
6472395



8x  
6048848



4x  
6249550



4x  
6093527



4x  
6436421



6x  
6217791



4x  
4539481



10x  
4640844



6x  
6326748



8x  
6491606



16x  
6092111



1x  
4211807



12x  
4211470



10x  
4211881



16x  
6416524



15x  
6134378



24x  
6473925



12x  
4558955



1x  
4210725



2x  
4529240



2x  
4504378



1x  
4211106

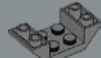

1x  
4211076



8x  
6215212



1x  
6071261



2x  
6100030



4x  
4211052



15x  
4210635



6x  
4211094



1x  
4211133



8x  
4568734



12x  
6343852



2x  
4211001



2x  
6039176



12x  
4211065



4x  
4539429



1x  
4210998



4x  
4211137



5x  
4210796



1x  
4528323



4x  
6350724



4x  
6336390



2x  
6214341



5x  
6117972



2x  
6336990



4x  
6123814



1x  
6457961



2x  
4521187



6x  
6231765



2x  
6143423



2x  
6143417



16x  
6221607



14x  
6164073



4x  
6411395



1x  
4528323



4x  
6350724



8x  
4567887



1x  
4210719



20x  
4210631



2x  
6116470



4x  
6439170



4x  
6359933



4x  
4623236



4x  
6258991



1x  
4211066



11x  
6281996



2x  
6281996



8x  
6353192



1x  
6118815



4x  
6210601



9x  
6322830



12x  
4619515



12x  
6469087

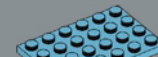

1x  
6472396



1x  
6472396



1x  
6472396



1x  
6472396



1x  
6472396



1x  
6472396



1x  
6472396



1x  
6472396



1x  
6472396

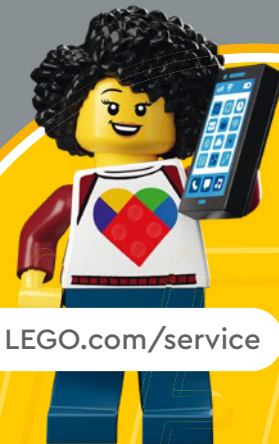

[LEGO.com/service](https://www.lego.com/service)



**STAR  
WARS™**

LEGO and the LEGO logo are trademarks of the LEGO Group.  
©2024 The LEGO Group. 6515728  
© & ™ Lucasfilm Ltd.