

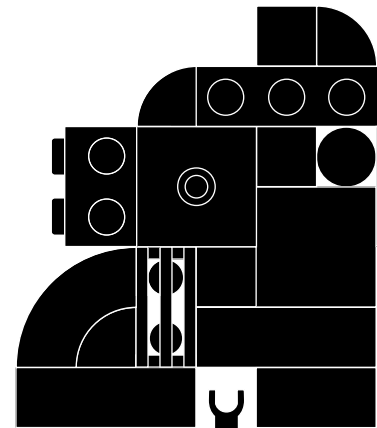

1

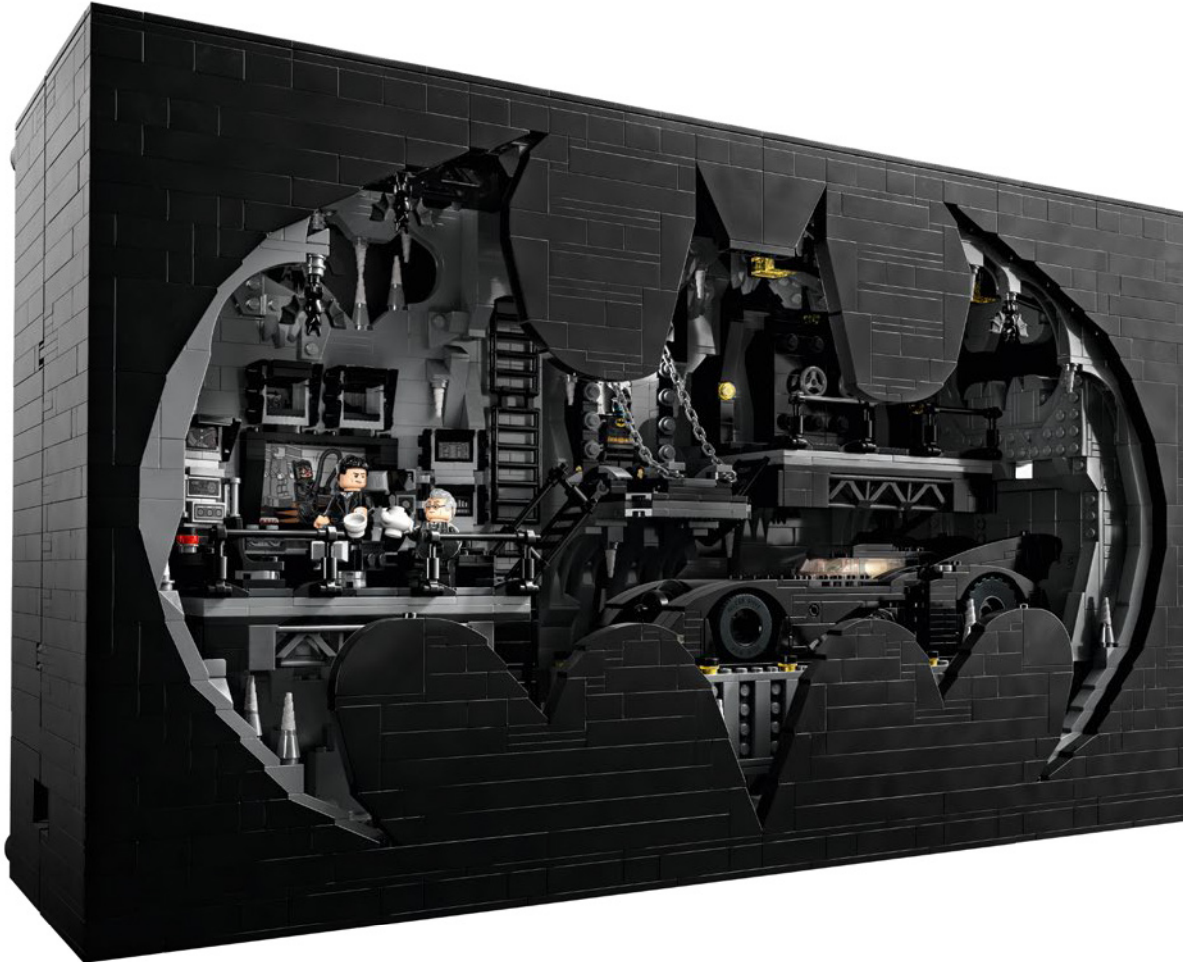



[LEGO.com/sustainable-packaging](https://LEGO.com/sustainable-packaging)

# LEGO® VIP

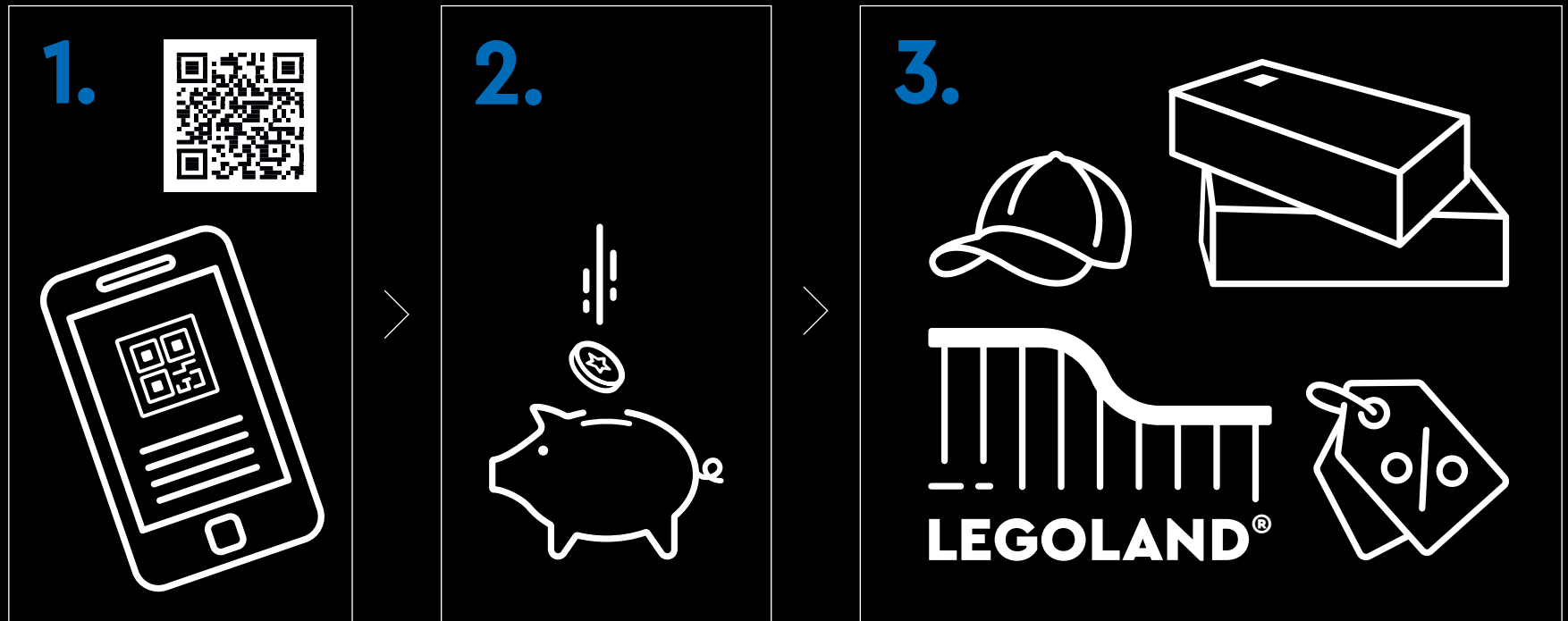

**1.** Sign up **2.** Earn points for purchases **3.** Redeem points for rewards, experiences, discounts & more | **1.** Melde dich an **2.** Sammle Punkte bei jedem Kauf **3.** Löse die Punkte für Belohnungen, Erlebnisse, Rabatte und Ähnliches ein | **1.** Inscrivez-vous **2.** Gagnez des points lors de vos achats **3.** Échangez vos points contre des récompenses, des expériences, des remises et bien plus encore | **1.** Iscriviti **2.** Guadagna punti con i tuoi acquisti **3.** Riscatta punti per premi, esperienze, sconti e altro ancora | **1.** Regístrate **2.** Gana puntos por tus compras **3.** Canjea puntos por recompensas, experiencias, descuentos y mucho más | **1.** Registe-se **2.** Ganhe pontos em compras **3.** Troque os pontos para prémios, experiências, descontos e muito mais | **1.** 注册 **2.** 购物赚积分 **3.** 用积分兑换奖励、体验、折扣等 | **1.** Zarejestruj się **2.** Zdobywaj punkty za zakupy **3.** Wymieniaj punkty na rabaty, przygody i inne nagrody | **1.** Zaregistrujte se **2.** Sbírejte body za nákupy **3.** Vyměňujte body za odměny, zážitky, slevy a spoustu dalšího | **1.** Zaregistrujte se **2.** Získavajte body za nákupy **3.** Uplatnite si body a získajte odmeny, rôzne zážitky, zľavy a ešte viac | **1.** Regisztrálj **2.** Szerezz pontokat minden vásárlással **3.** Váltsd be pontjaidat jutalmakra, élményekre, kedvezményekre és egyebekre | **1.** Înscric-te **2.** Câștigă puncte pentru achiziții **3.** Valorifică puncte pentru recompense, experiențe, reduceri și multe altele | **1.** Регистрируйте се **2.** Получайте точки за покупки **3.** Используйте точки за награды, услуги, отстъпки и т.н. | **1.** Reģistrējies **2.** Pelni punktus par pirkumiem **3.** Izmanto punktus, lai saņemtu balvas, izklaides iespējas, atlaides un daudz ko citu | **1.** Registreeru **2.** Teeni ostude eest punkte **3.** Lunasta punktide eest preemiad, elamused, allahindlused ja muu | **1.** Užsiregistruokite **2.** Pelnykite taškus už pirkinius **3.** Panaudokite taškus atlygiui, funkcijoms, nuolaidoms ir ne tik





**„MÜSSEN SIE DER EINZIGE EINSAME  
TIERMENSCH DER STADT SEIN?“**

*- Alfred Pennyworth™*

# DIE GEHEIMNISSE DER BATHÖHLE

In diesem ebenso eleganten wie vielseitigen Schaukasten kannst du all deine kostbaren Souvenirs kreativ in Szene setzen. Dort werden deine Sammlerstücke in der richtigen Atmosphäre präsentiert. Und der Tiefeneffekt verwandelt sie in ein einzigartiges Kunstwerk. Unser erster LEGO® Schaukasten spiegelt nicht nur die Atmosphäre der Bathöhle perfekt wider, sondern offenbart auch ihre Geheimnisse. Sie ist das legendäre Versteck des Superhelden, der im Schatten auf Jagd geht, um GOTHAM CITY™ zu beschützen.

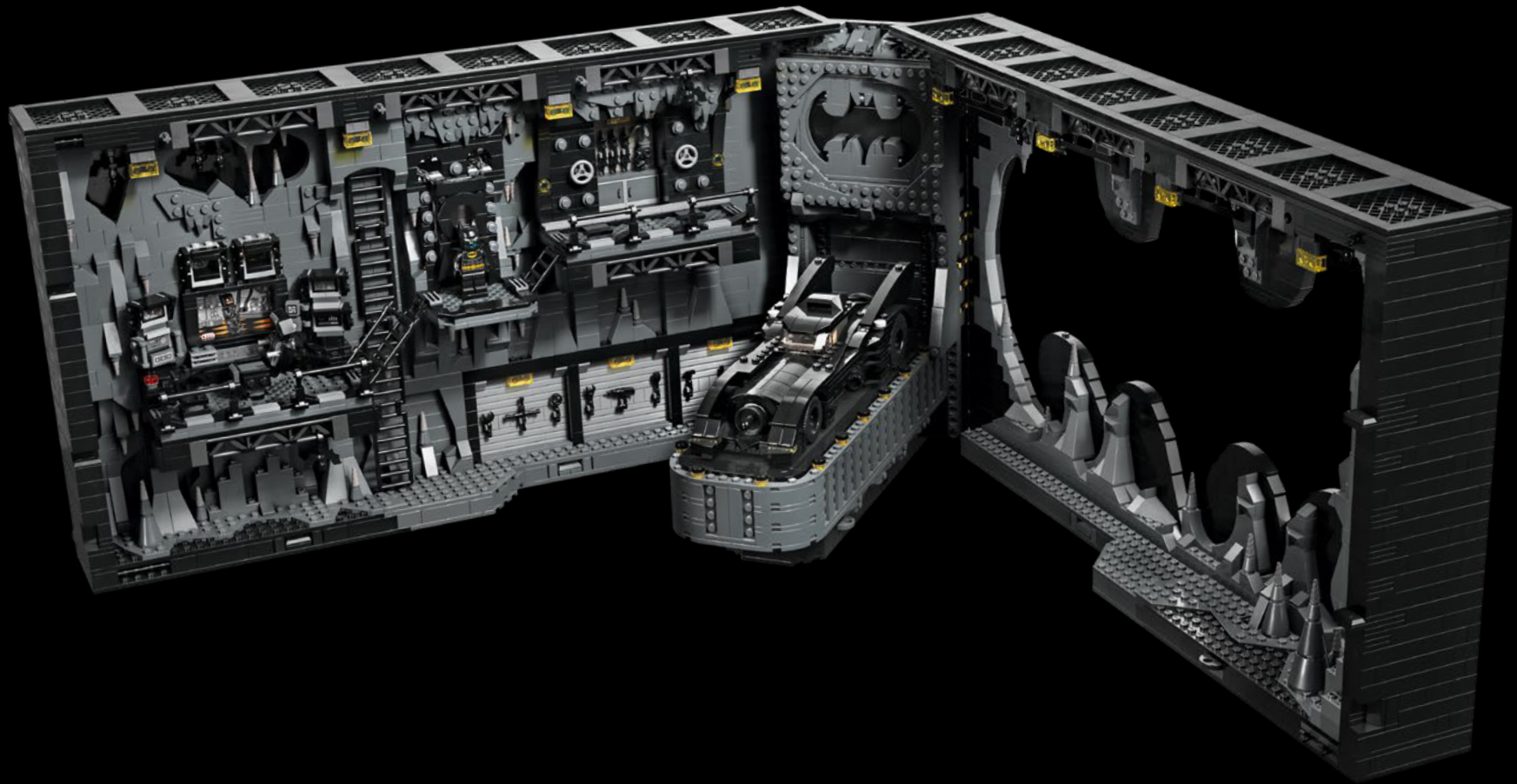



Die LEGO® DC Batman™ Designer (von links nach rechts): Connie Bork, Bjarke Lykke Madsen, Daniel Lundin, Adam Corbally, Christian Barnkob, Carter Luce Baldwin, Jesper C. Nielsen, Ashwin Visser.

## VOM KONZEPT ZUM FERTIGEN MODELL

Bei der Entwicklung eines neuen LEGO® Sets, egal, wie groß oder klein es auch sein mag, muss ein ganzes Team aus Spezialisten und Expertinnen der unterschiedlichsten Sparten und Abteilungen zusammenarbeiten, um das beste Bau- und Spielerlebnis zu erzielen. Modelldesign, Grafikdesign, das Gestalten der Bauanleitungen und viele weitere Schritte sind erforderlich. Jesper C. Nielsen, LEGO DC Batman™ Creative Lead, hat schon lange am Konzept einer vertikalen Bathöhle für erwachsene Fans getüftelt, genauer gesagt an einem komplexen Diorama, das schmal genug ist, um auf ein Regal zu passen. Senior Model Designer Bjarke Lykke Madsen hatte bereits an vier früheren LEGO Modellen der Bathöhle mitgewirkt und sollte ausloten, ob und wie aus dieser Idee tatsächlich ein Set entstehen könnte.



## IDEENSUCHE

Bjarke ließ sich von dem Format des Schaukastens und dem Film *Batmans Rückkehr* (1992) inspirieren: „In *Batmans Rückkehr* sind all die fantastischen Designdetails und Funktionen in der Bathöhle zu sehen. Mir kam die Idee, dass ein Schaukasten einer LEGO® Version der Bathöhle eine zusätzliche künstlerische Note verleihen könnte. Jesper gefiel diese Idee. Er schlug vor, die Vorderseite mit einem ausgeschnittenen Batman™ Logo zu verzieren. Wir waren uns einig, dass das Batmobil einen Ehrenplatz in der Bathöhle erhalten sollte. Deshalb gestaltete ich das ausgeschnittene Batman Logo so, dass ein Batmobil im Minifigur-Maßstab hineinpasste. Und das gab uns den Maßstab fürs ganze Modell vor. Dann baute ich den ersten Prototyp einschließlich einer Plattform fürs Batmobil, Computerarbeitsplätzen, der Geheimkammer für den Batsuit, des Gadget-Schranks usw.“



## DAS SUPERHELDEN-DESIGNERTEAM

Als ihm bewusst wurde, wie groß dieses Modell werden würde, zog Bjarke einen weiteren Modelldesigner zu dem Projekt hinzu. Carter Luce Baldwin schlug eine Funktion zum Öffnen des Schaukastens vor, um Zugang zu den Plattformen zu erhalten. Zusammen bauten die beiden Modelldesigner einen zweiten Prototyp einschließlich Öffnungsfunktion. Außerdem verbesserten sie sowohl die Funktionen im Inneren als auch die Plattformen. Carter entwarf den Haupteingang, der durch das Batman™ Logo noch imposanter wirkte. Für einen zusätzlichen dramatischen Effekt baute Bjarke einen Lichtstein in die Geheimkammer ein. Außerdem integrierte er eine Funktion zum Wechseln der Bilder auf den Computermonitoren. Um dieser Funktion die volle Wirkung zu verleihen, entwarf der Grafiker Daniel Lundin detailreiche Aufkleber für die Monitore.





## FEINSCHLIFF DER FUNKTIONEN UND FIGUREN

Während der letzten Entwicklungsphasen verstärkte Senior Model Designer Adam Grabowski das Team, um das Modell zu optimieren und das Batmobil so zu dimensionieren, dass es durch den Haupteingang passt. Senior Model Coach Christian Barnkob und Building Instruction Specialist Connie Bork berieten das Team hinsichtlich des gesamten Bauerlebnisses. Währenddessen arbeiteten Design Master Adam Corbally und Senior Graphic Designer Ashwin Visser zusammen, um die Hauptfiguren des Films als LEGO® Minifiguren nachzubilden.



## DETAILS IN HÜLLE UND FÜLLE

- Fünf der insgesamt sieben Minifiguren – Bruce Wayne™, Alfred Pennyworth™, Catwoman™, der Pinguin™ und Max Shreck™ – sind brandneu und exklusiv in diesem Set enthalten.
- Die beiden Batman™ Minifiguren tragen unterschiedliche Umhänge und Masken. Die Minifigur mit dem weichen Umhang lässt sich ins Batmobil und in die Geheimkammer stecken. Die Minifigur mit dem starren Umhang kann man dagegen auf den Plattformen ausstellen.
- Dreh die gelben Knöpfe an der Rückseite des Modells, um die Funktionen an den Plattformen und Arbeitsplätzen zu betätigen.
- Bewahre das Flammentelement fürs Batmobil im Geheimversteck auf.
- Schalte das Licht in der Geheimkammer ein, um den Batsuit besonders imposant wirken zu lassen.
- Steig die Treppe zu Wayne Manor hinauf.
- Hier findest du alle Werkzeuge, die du zur Reparatur der von den Bösewichten verursachten Schäden am Batmobil, am Batsuit oder an den Gadgets brauchst.
- Lass die Zugbrücke herunter, um in die Batsuit-Geheimkammer zu gelangen.

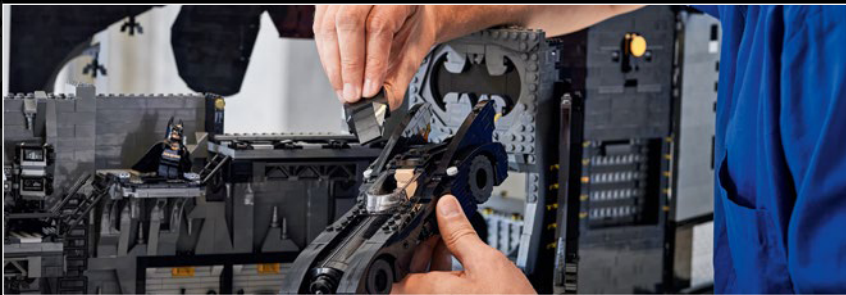

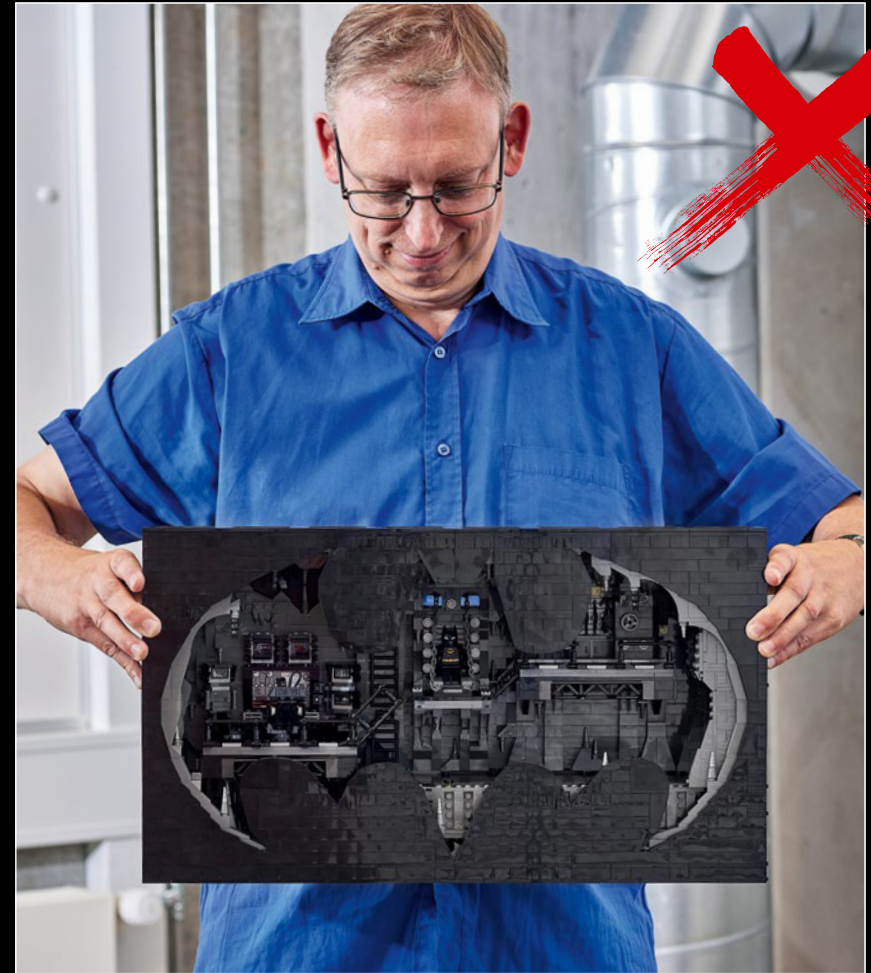
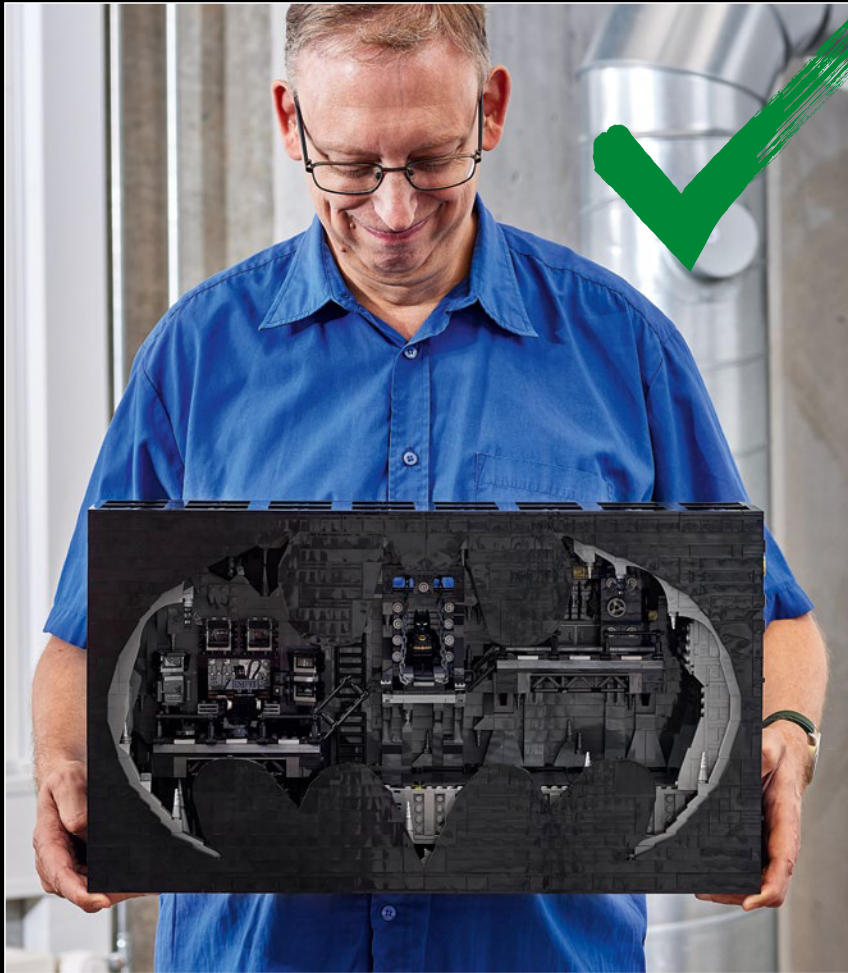

## TIPP: SO HEBST UND TRÄGST DU DEIN MODELL

ACHTUNG: Dein LEGO® Bathöhle – Schaukasten ist so konzipiert, dass man ihn NUR geschlossen anheben und tragen kann. Vergewissere dich, dass dein Modell fest verschlossen ist. Greif den Schaukasten dann an den unteren Rändern, um ihn anzuheben und zu bewegen.





## **STREIF DEINEN UMHANG UND DEINE HAUBE ÜBER UND FREU DICH AUFS BAUEN**

„So hast du die Bathöhle bestimmt noch nicht gesehen. Diese Version im Format eines LEGO® Schaukastens hat es so noch nie gegeben. Hoffentlich hast genauso große Freude am Erkunden aller Details und Funktionen wie wir. Im Namen des gesamten Teams wünsche ich dir viel Spaß beim Bauen und Spielen!“

Bjarke Lykke Madsen

**„ICH BIN BATMAN.“**

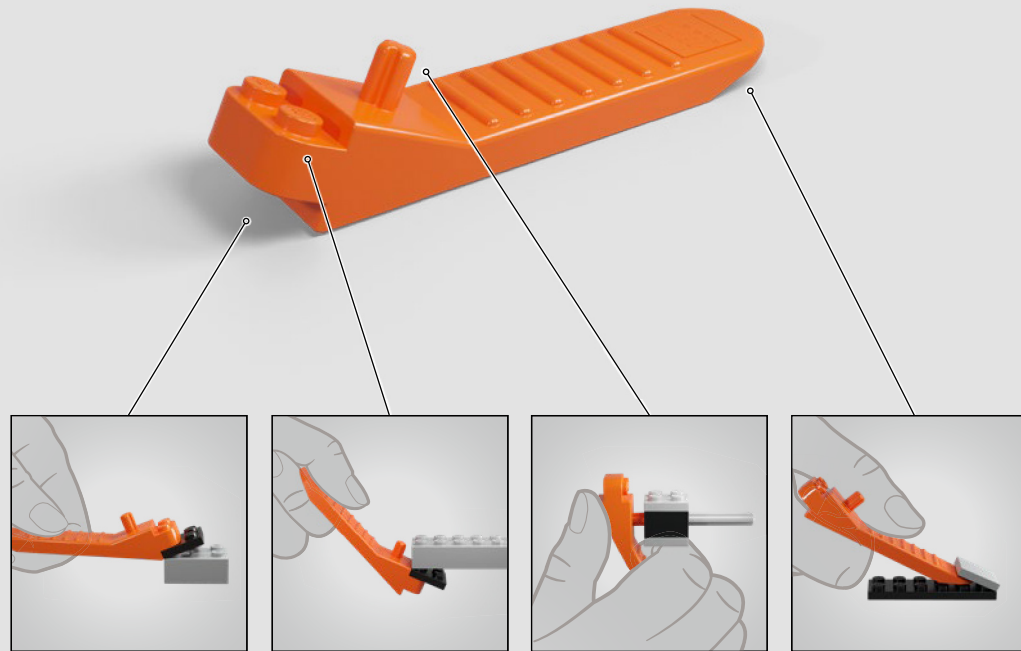

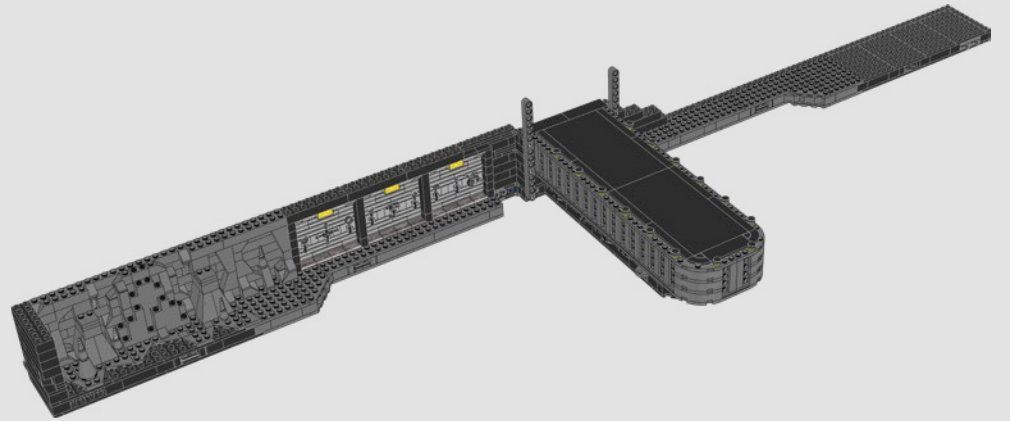
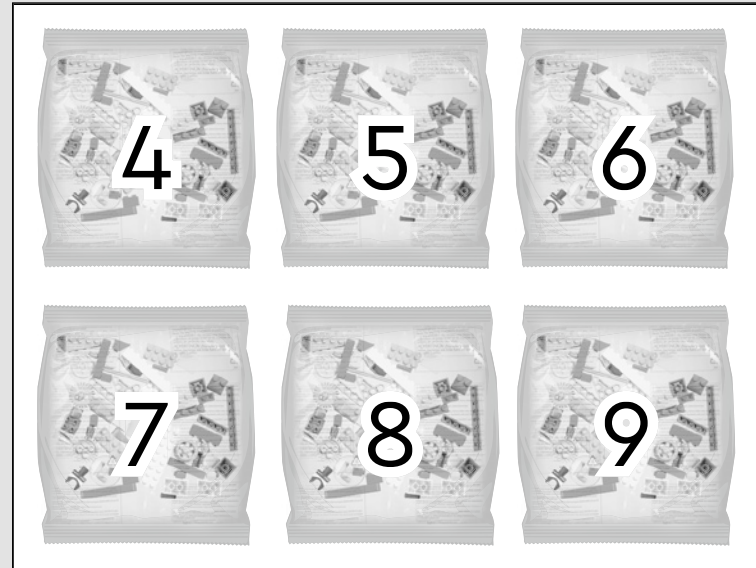
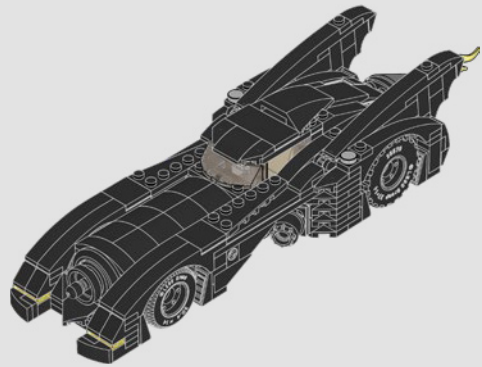
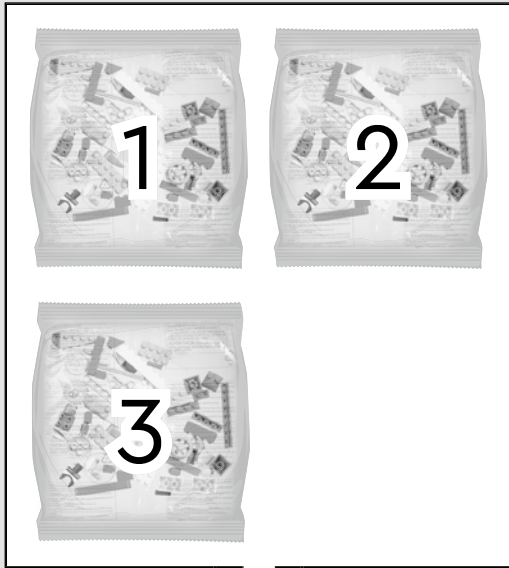

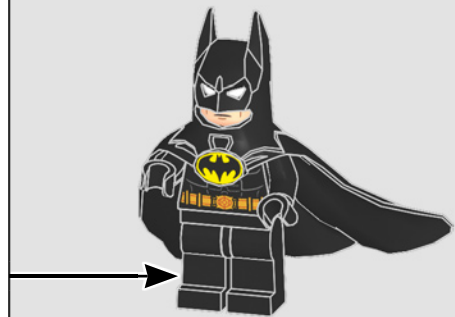
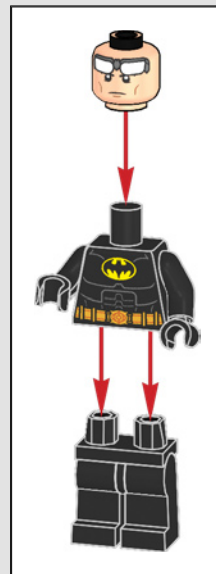





## BATMAN™

Batman™ ist ein kultivierter Held aus GOTHAM CITY™, der Fans, Autoren und Filmemacher seit Generationen inspiriert. Der gequälte Einsiedler mit dem verletzlichen Herzen sehnt sich nicht nach Ruhm. Angesichts seiner eigenen tragischen Vergangenheit fühlt er sich dazu verpflichtet, Licht in die dunklen Geheimnisse der Stadt zu bringen, nur um sich dann wieder in seinen eigenen Schatten zurückzuziehen.

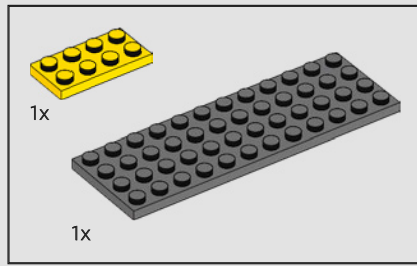
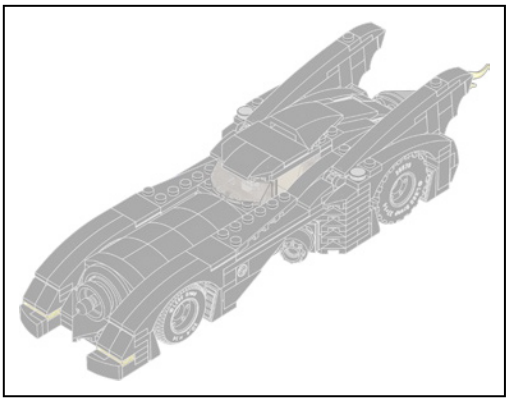

1

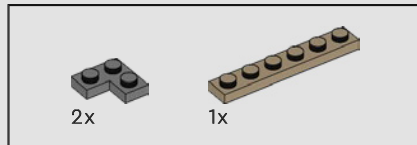
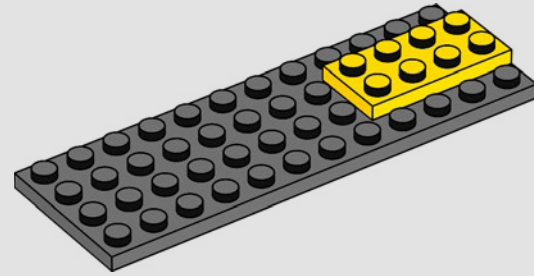

2

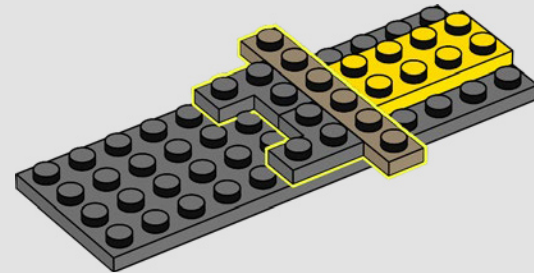

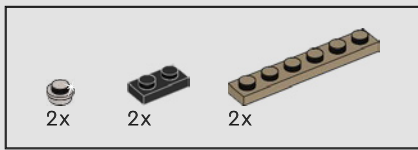

3

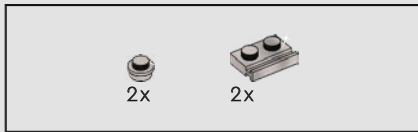
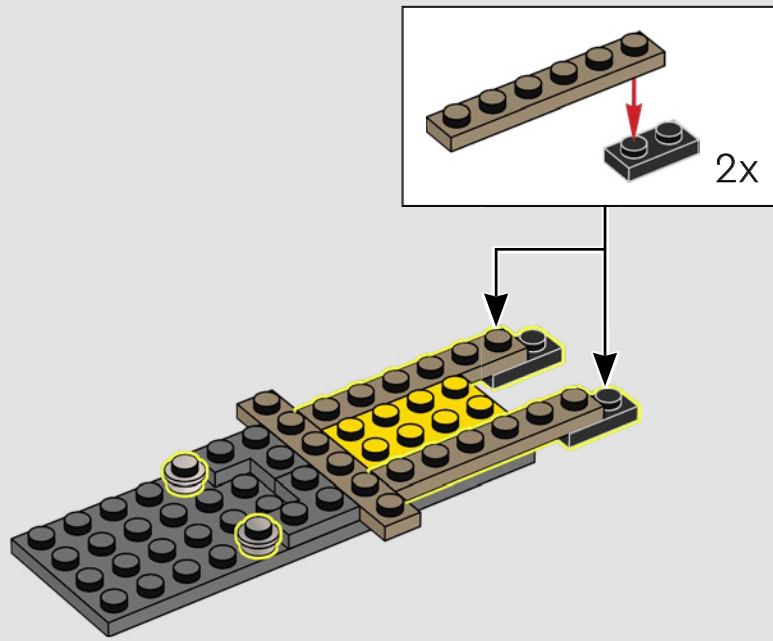

4

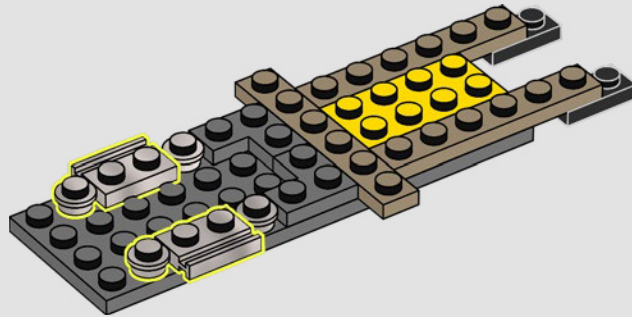

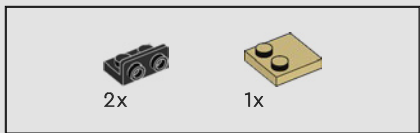

5

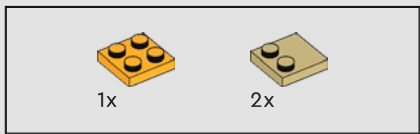
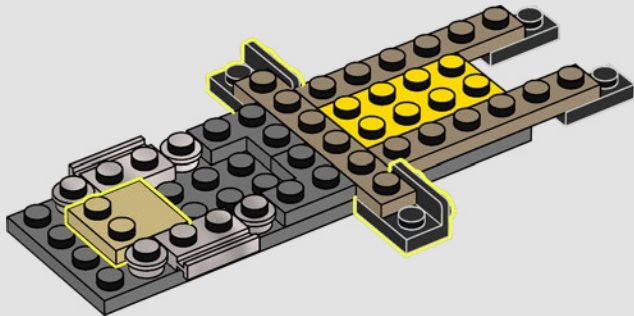

6

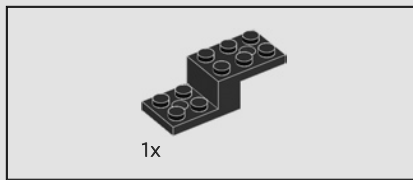
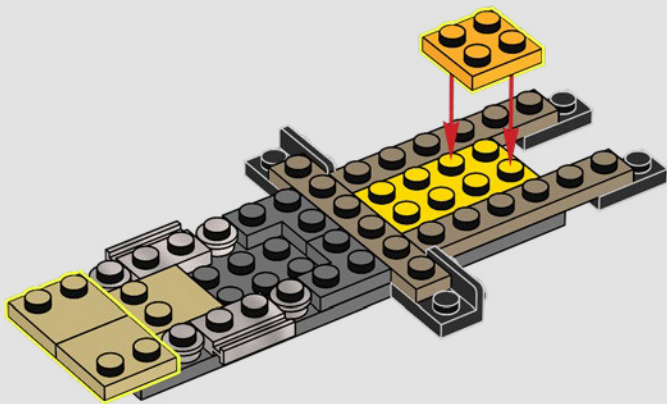

7

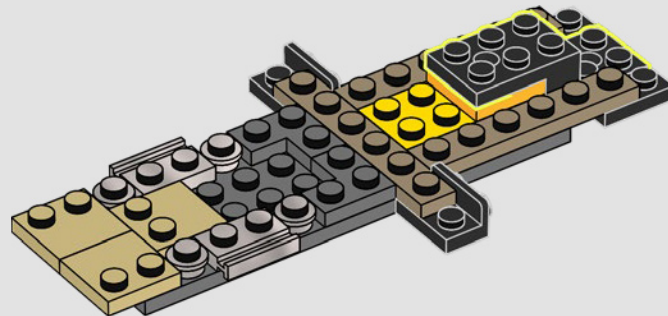

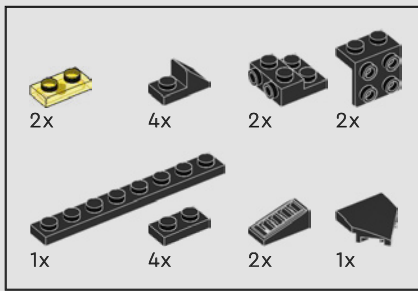

8

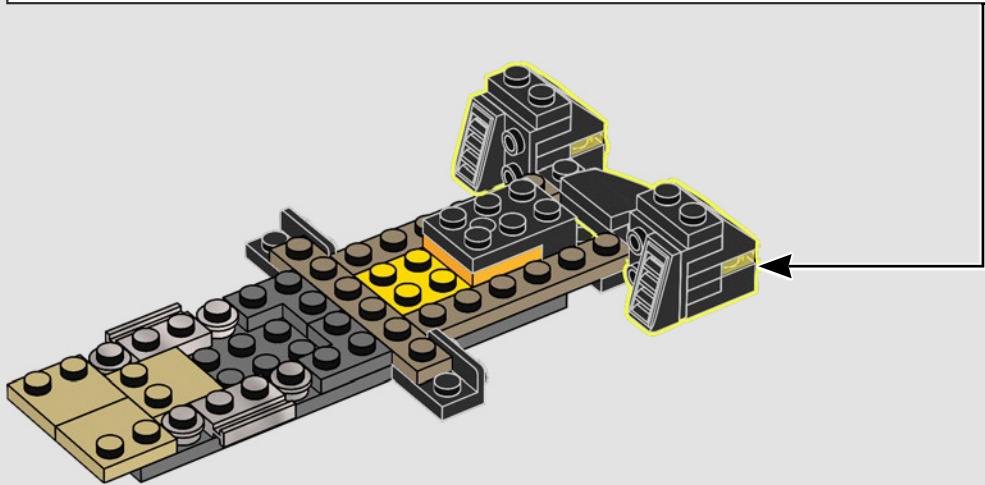
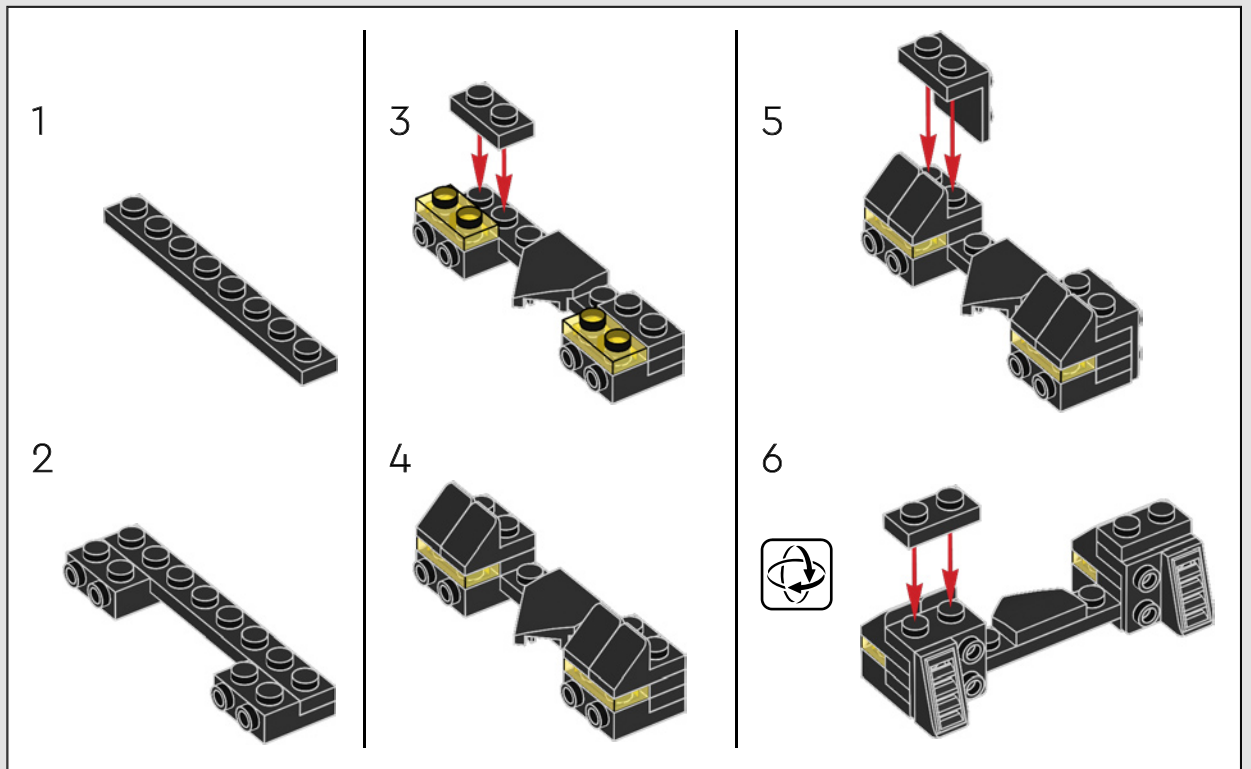



2x

9



2x

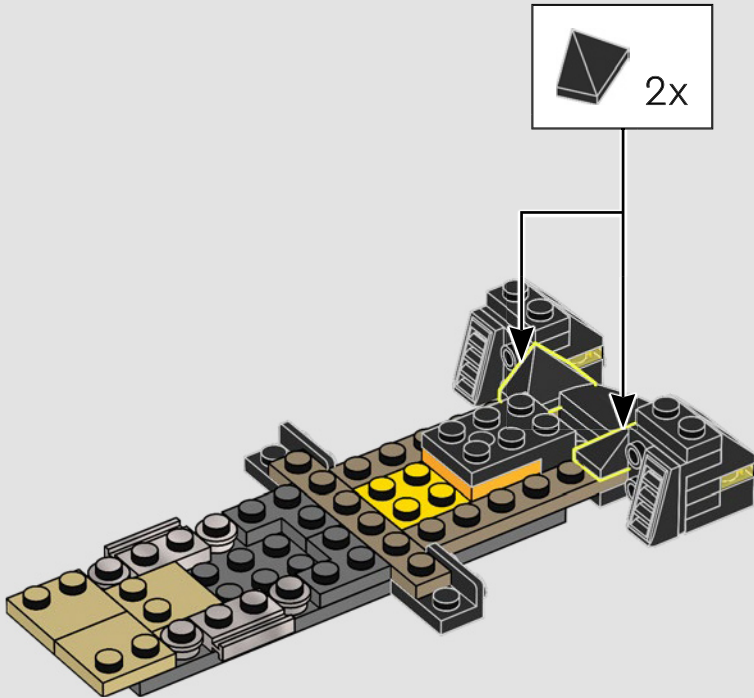

2x

10

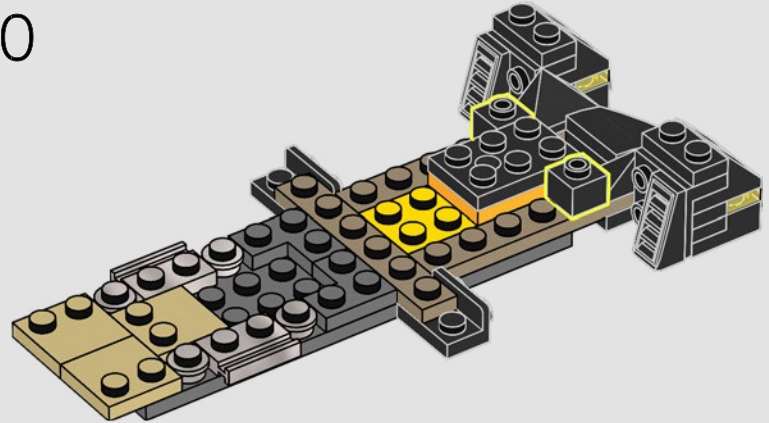

2x



2x



1x

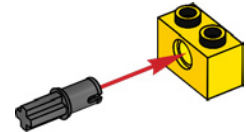

2x

11

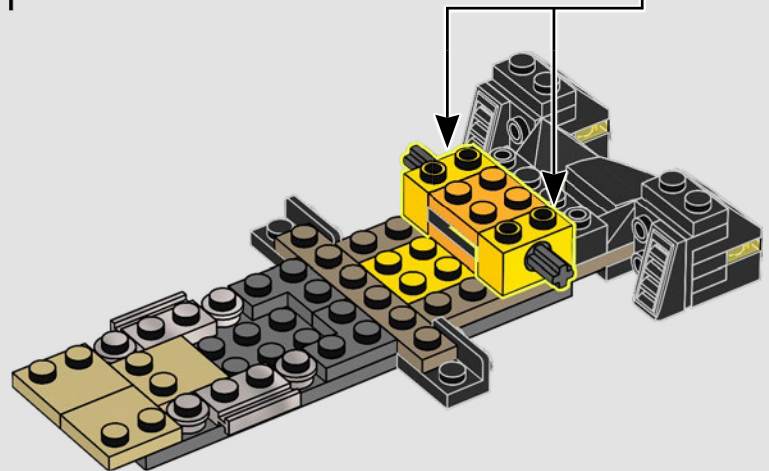

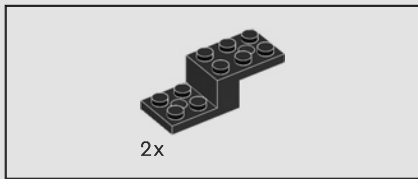

12

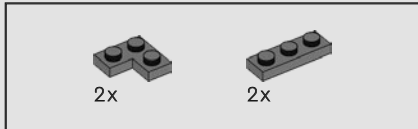
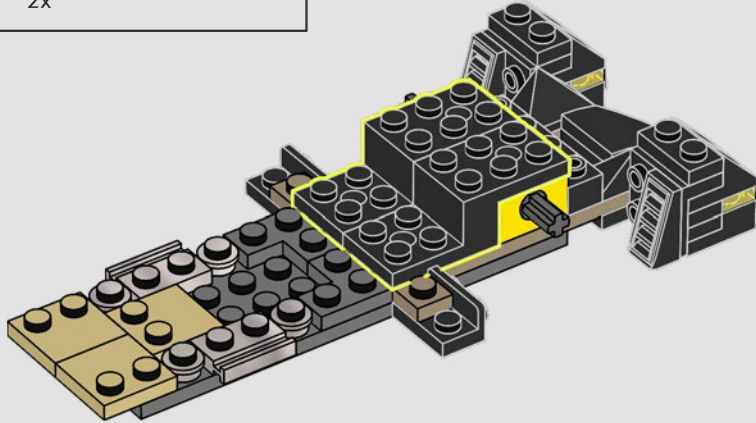

13

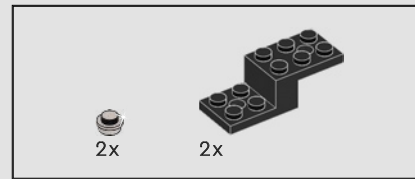
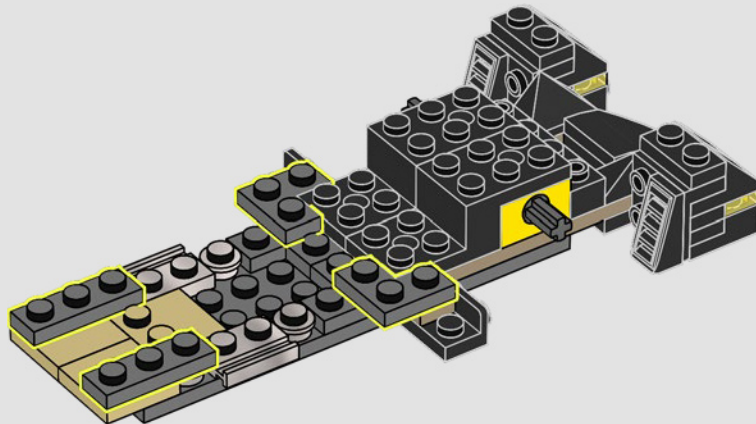

14

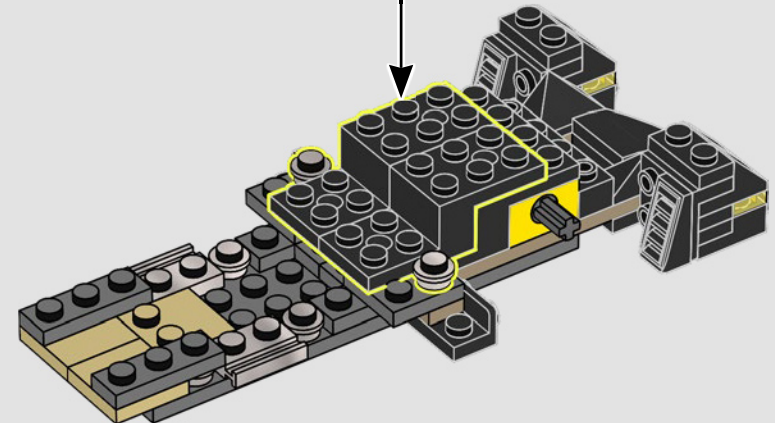
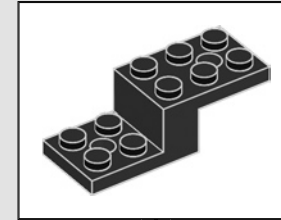

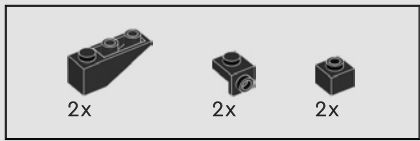

15

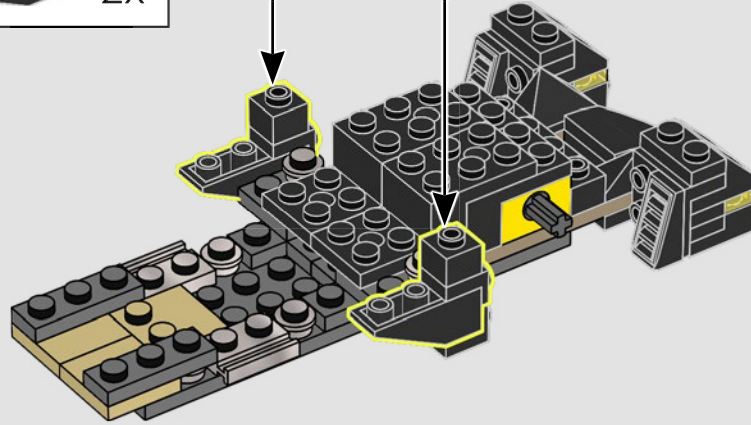
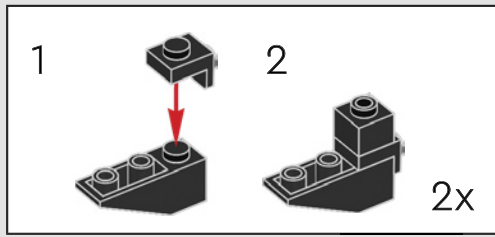

16

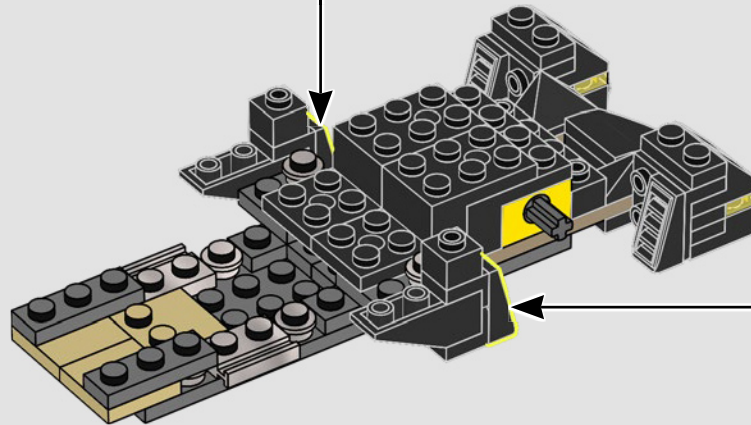



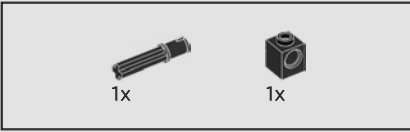
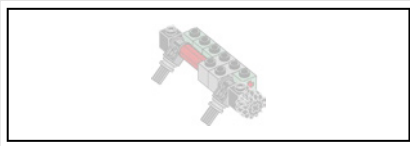

17

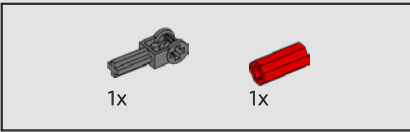
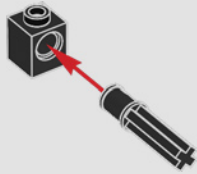

18

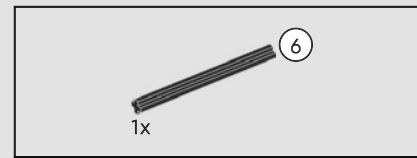
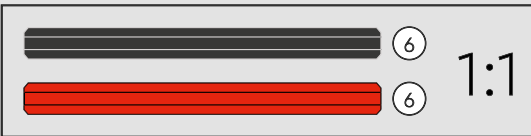
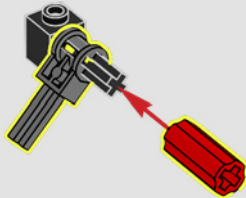

19

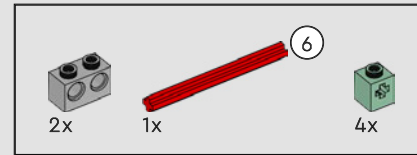
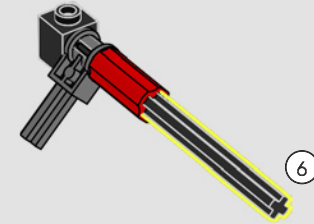

20

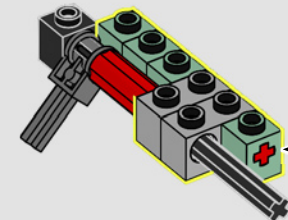
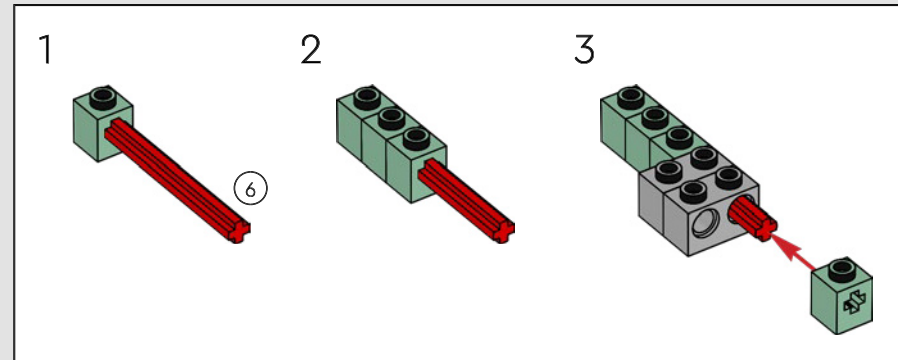



1x

21

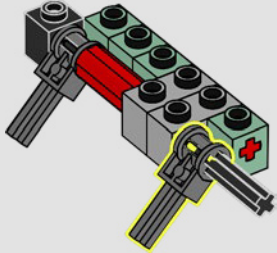

2x

22

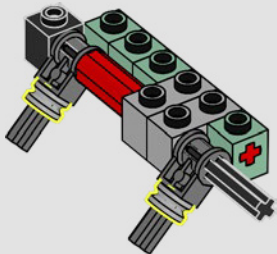

1x



1x

23

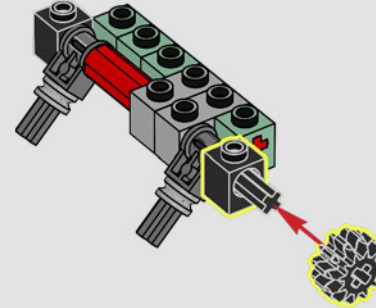

24

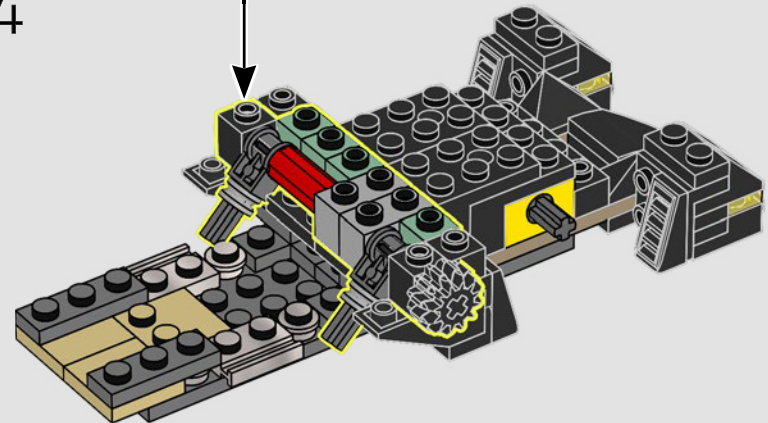

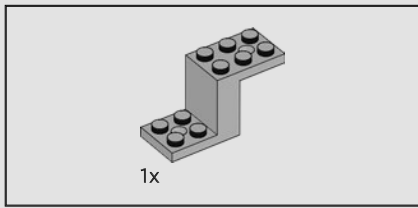

25

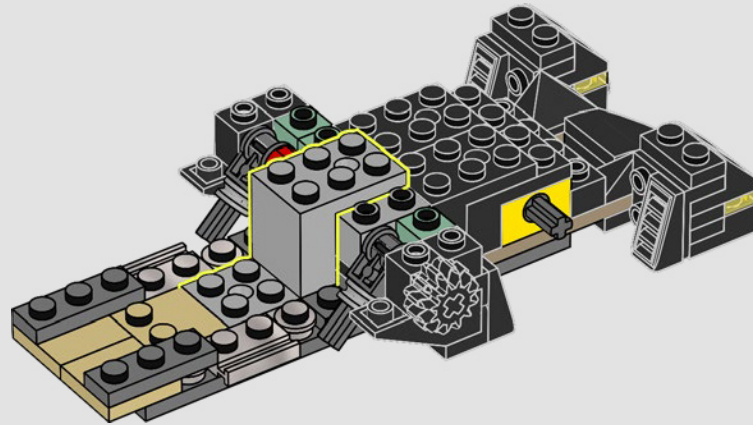

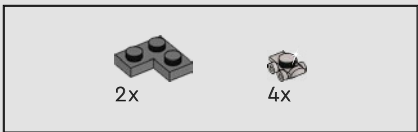

26

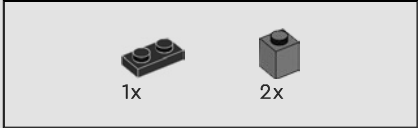
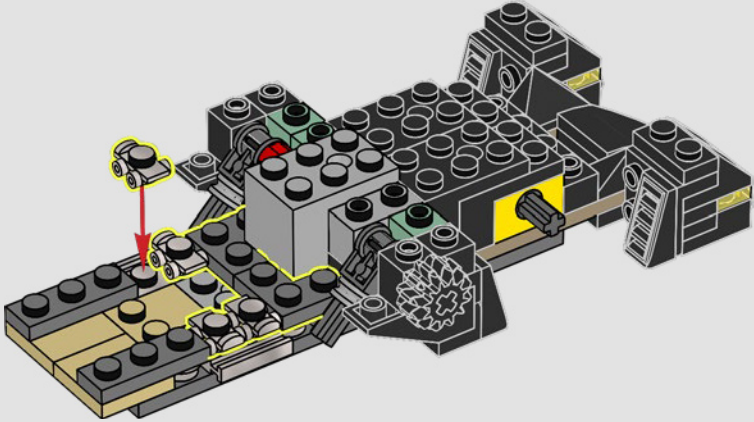

27

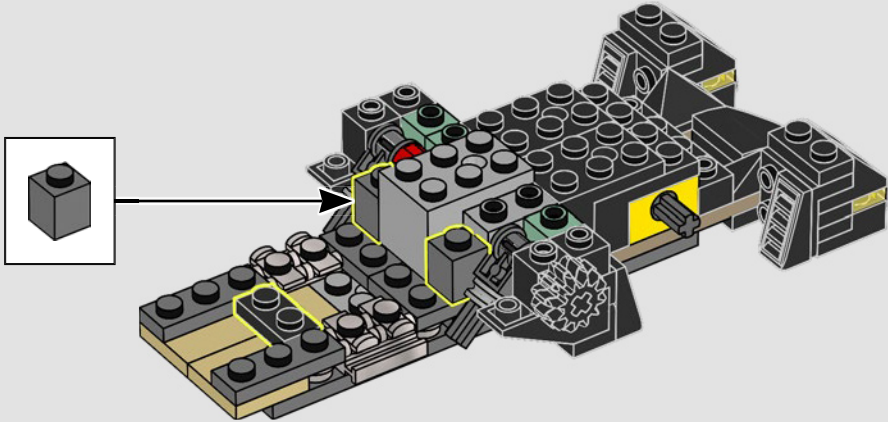

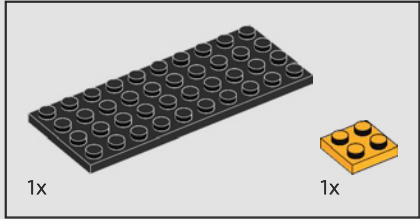
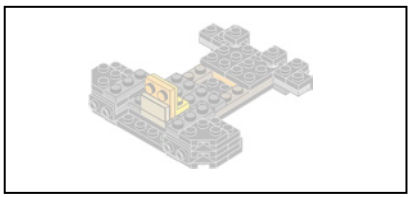

28

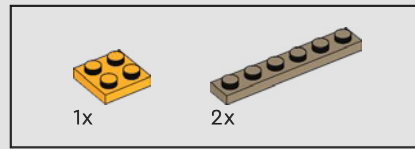
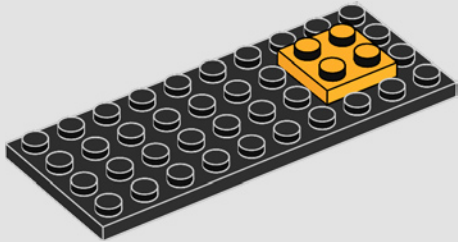

29

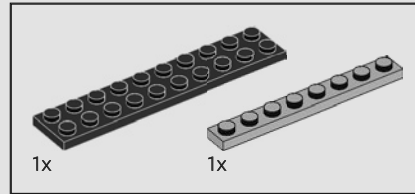
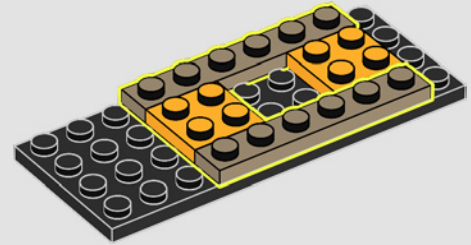

30

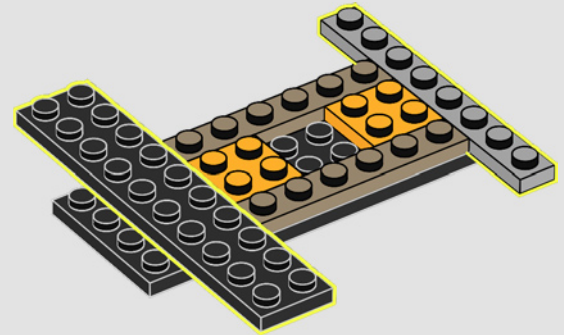

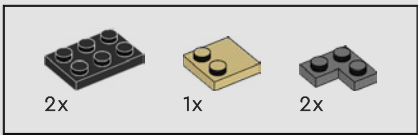

31

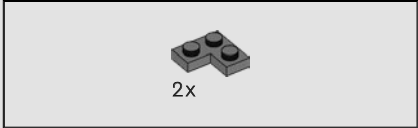
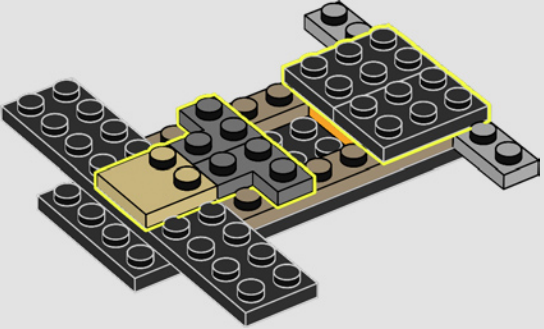

32

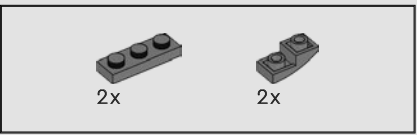
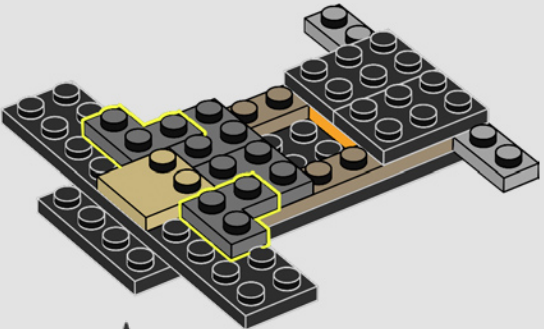

33

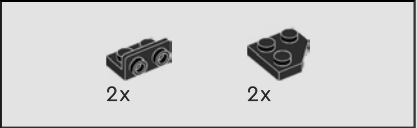
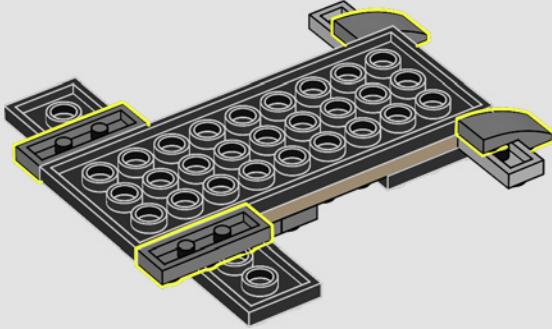

34

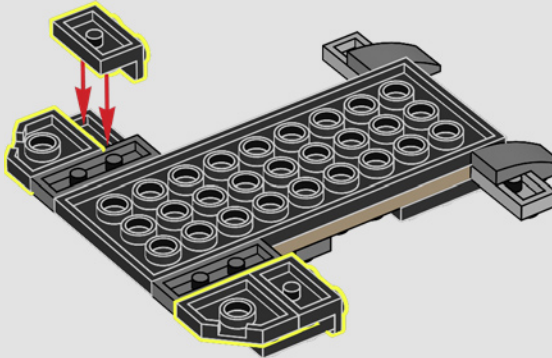

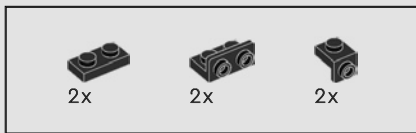

35

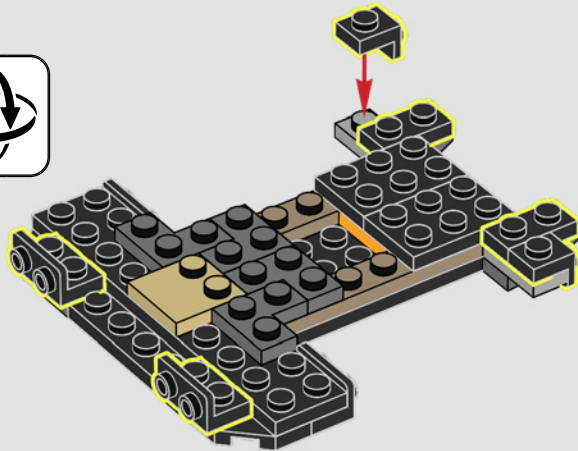

36

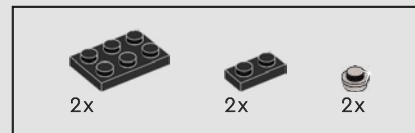
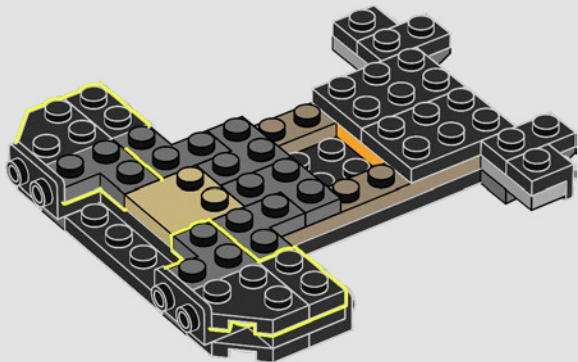

37

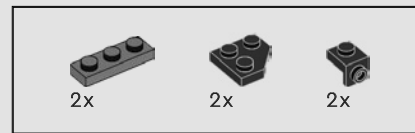
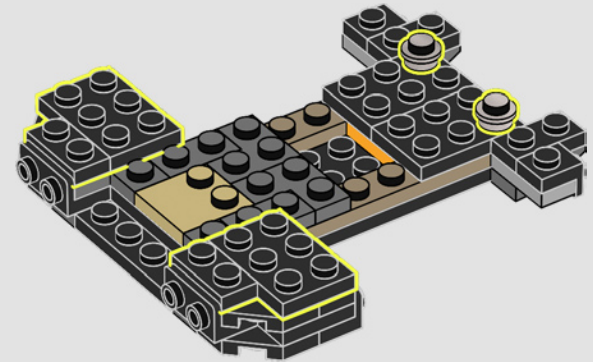

38

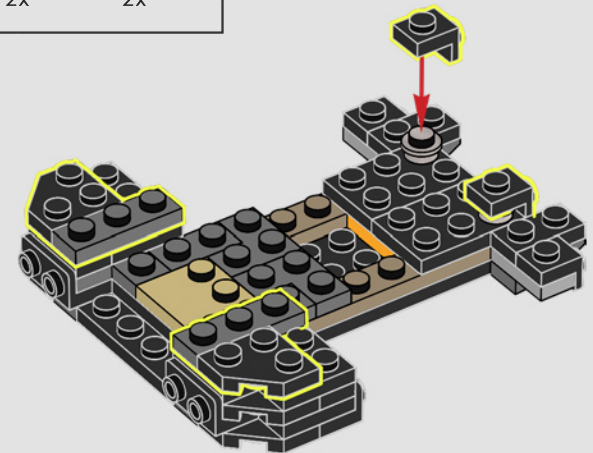



39

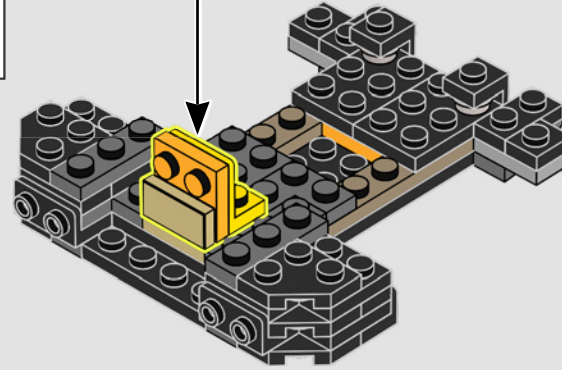
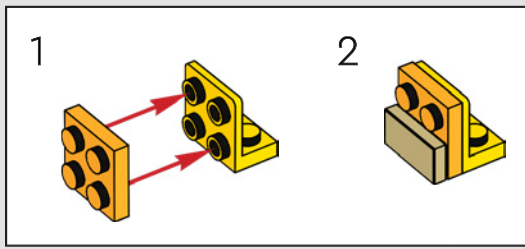

40

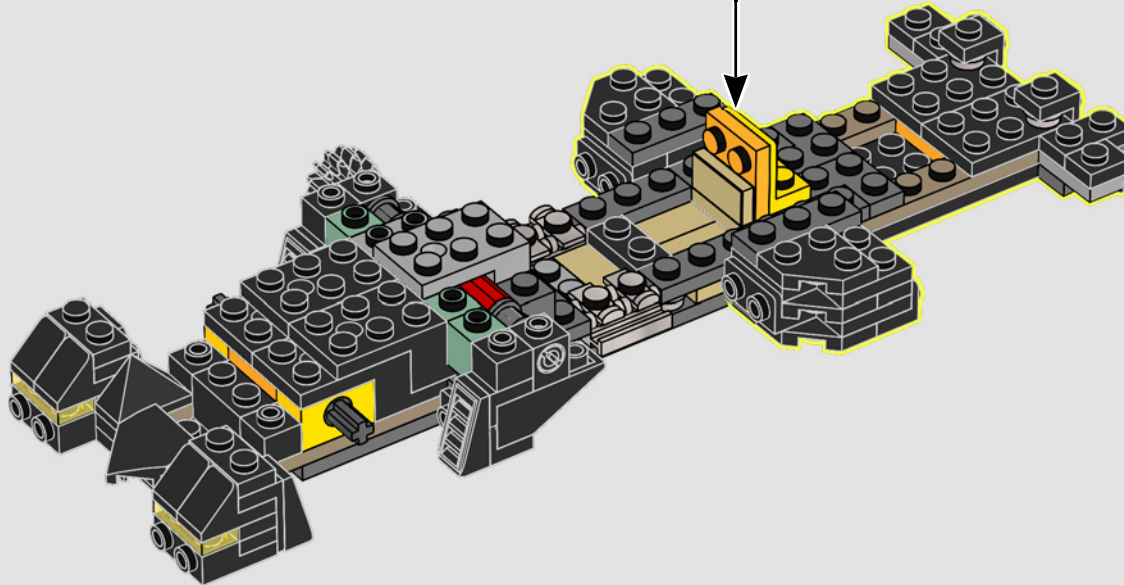



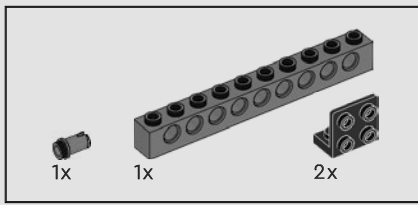

41

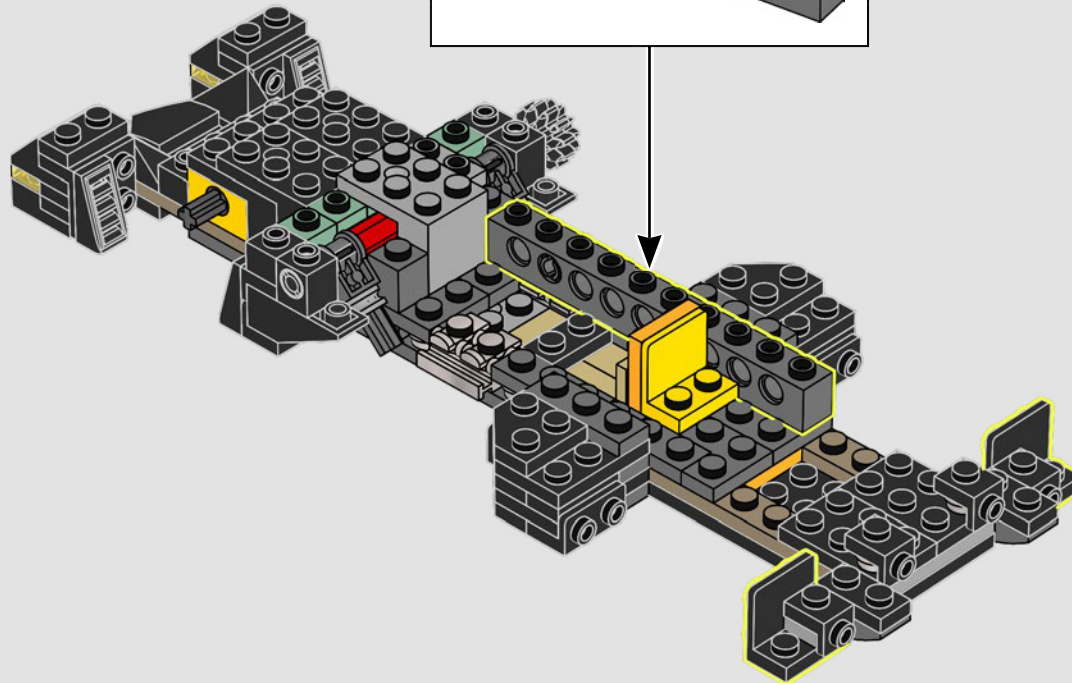
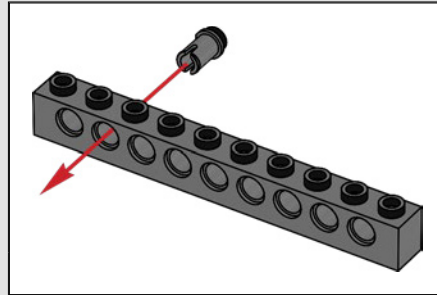



2x

42

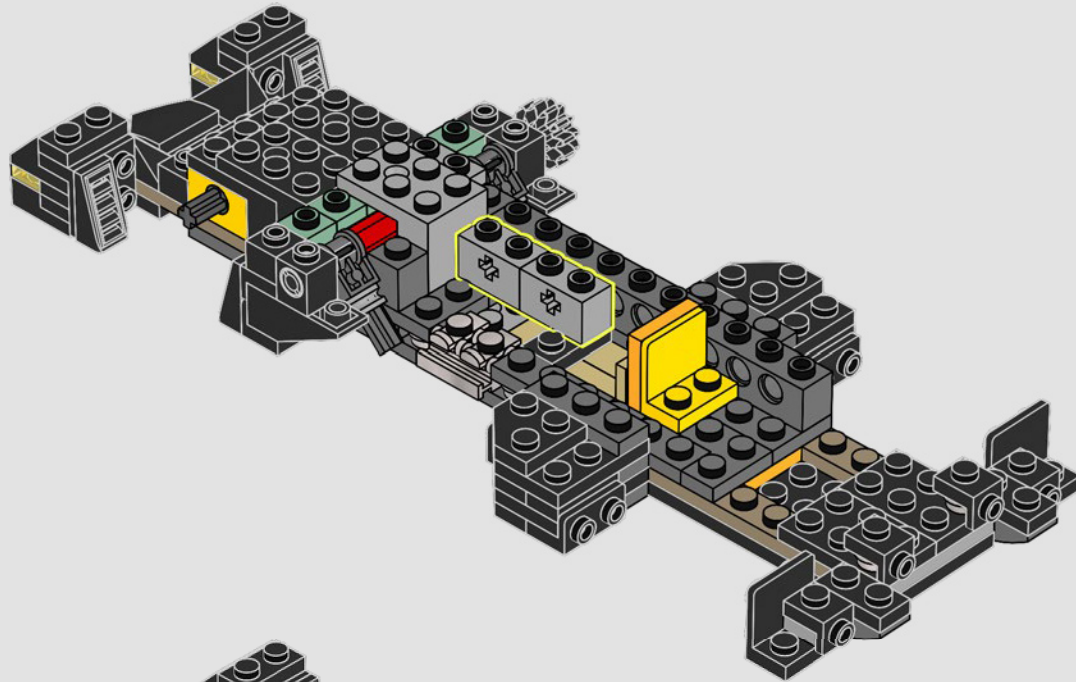

1x

43

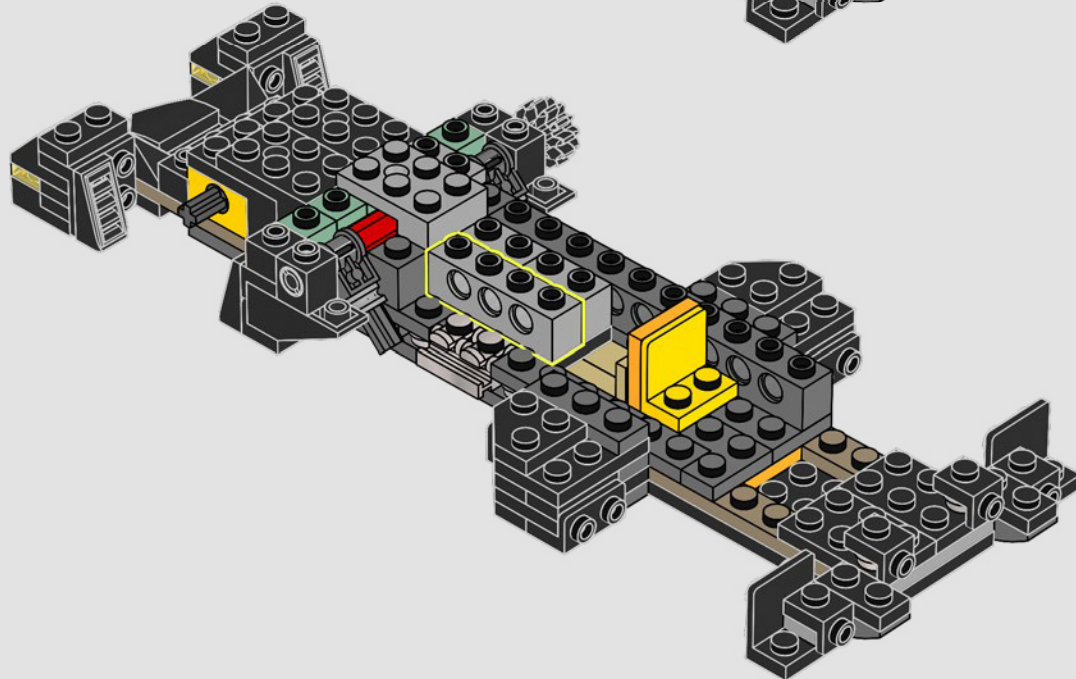

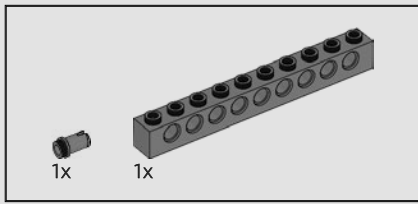

44

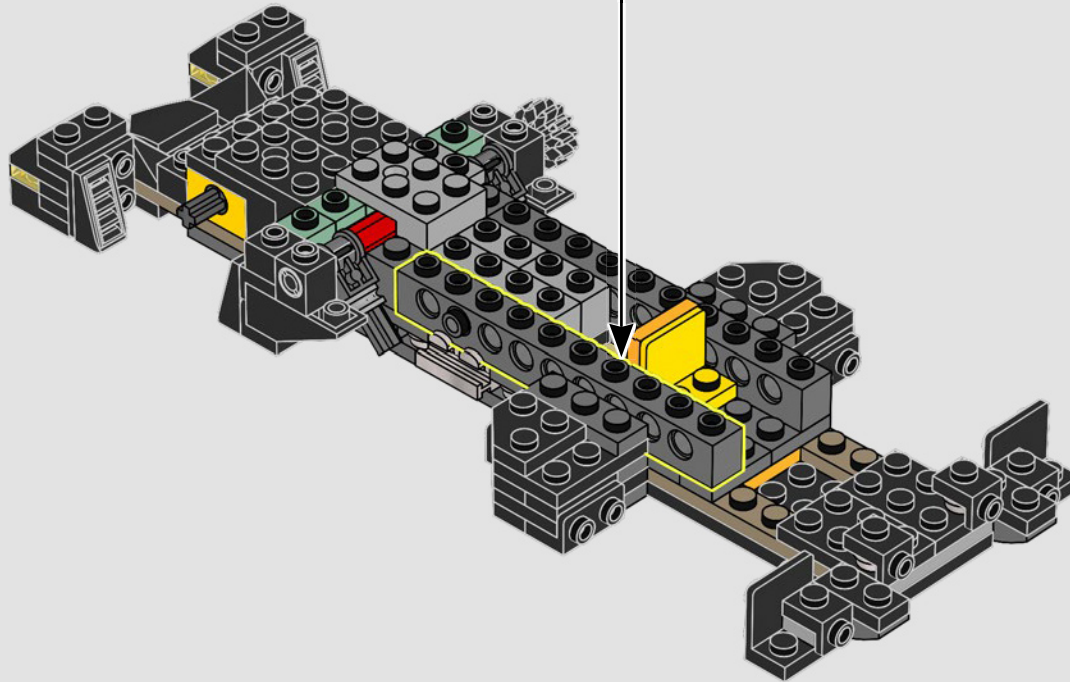
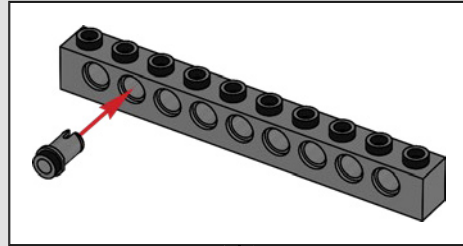

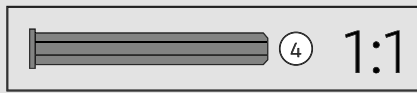
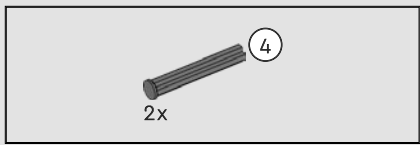

45

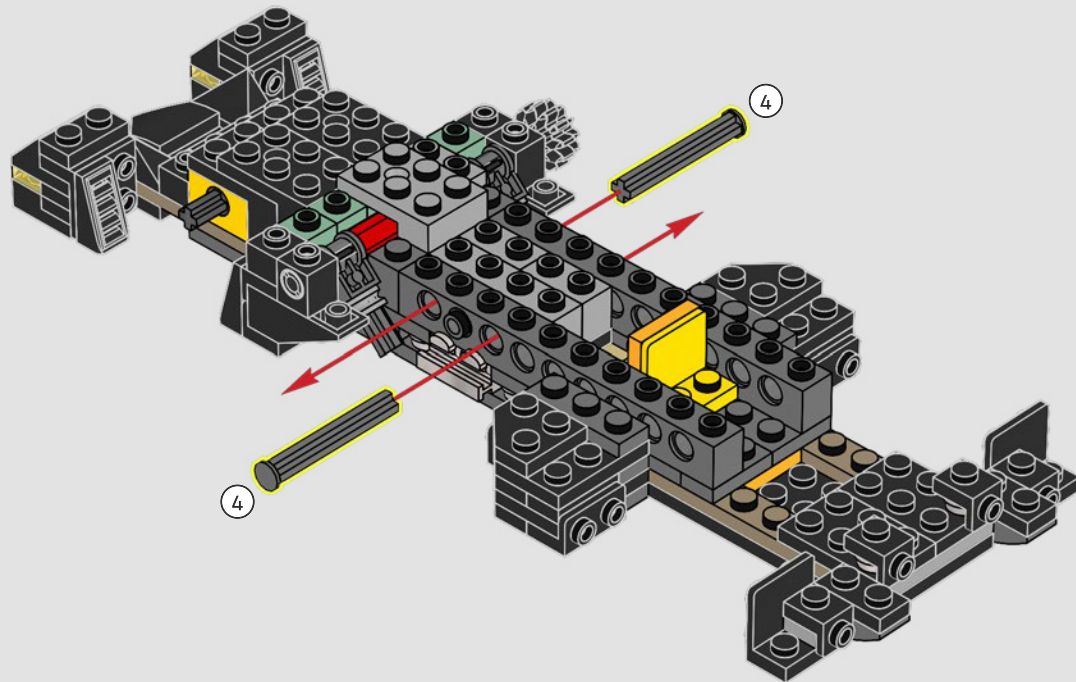

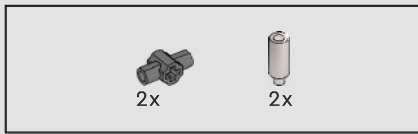

46

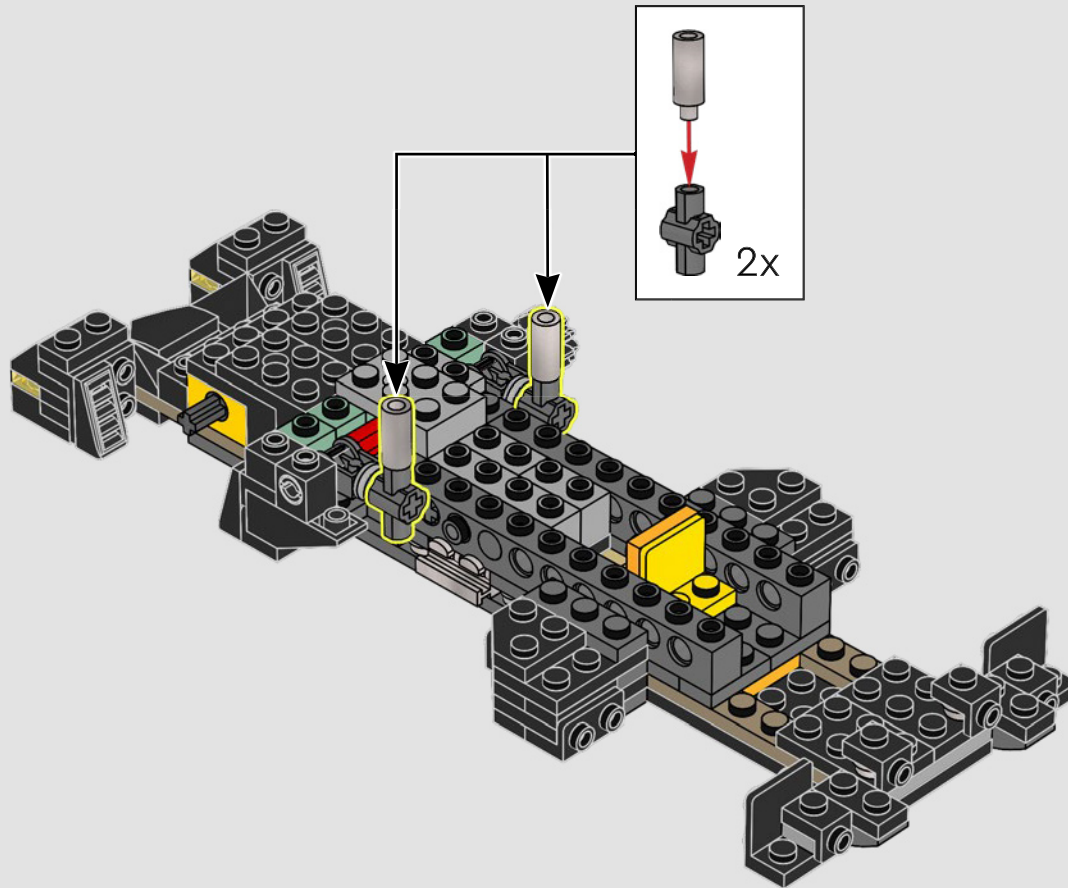



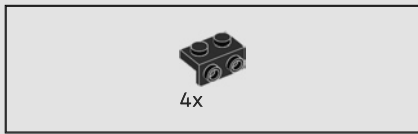

47

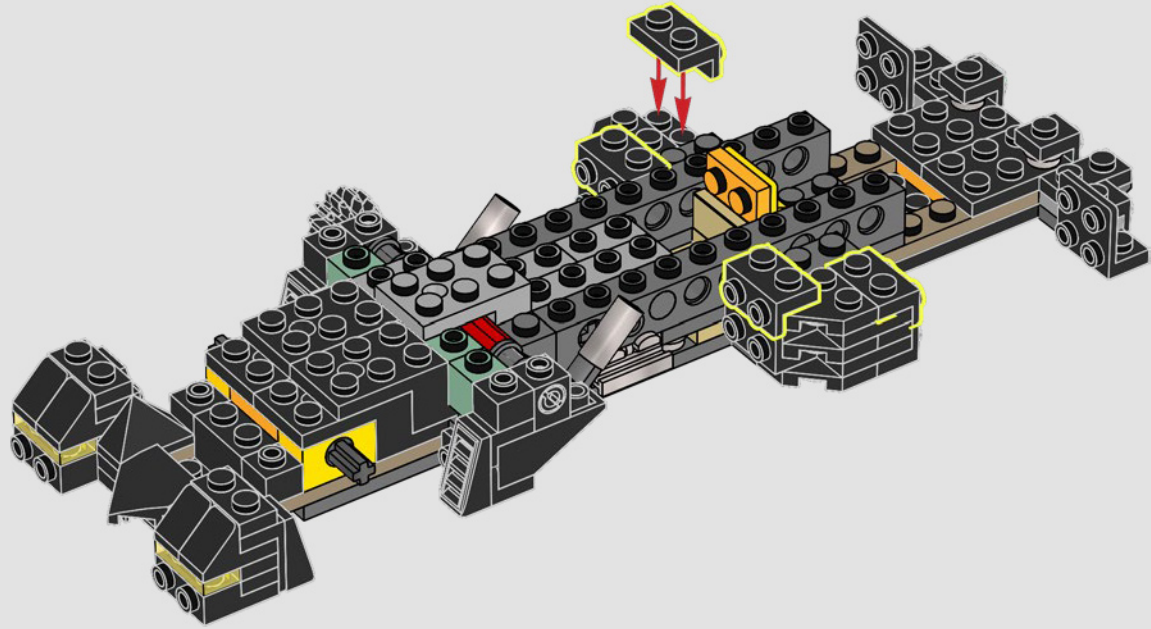

48

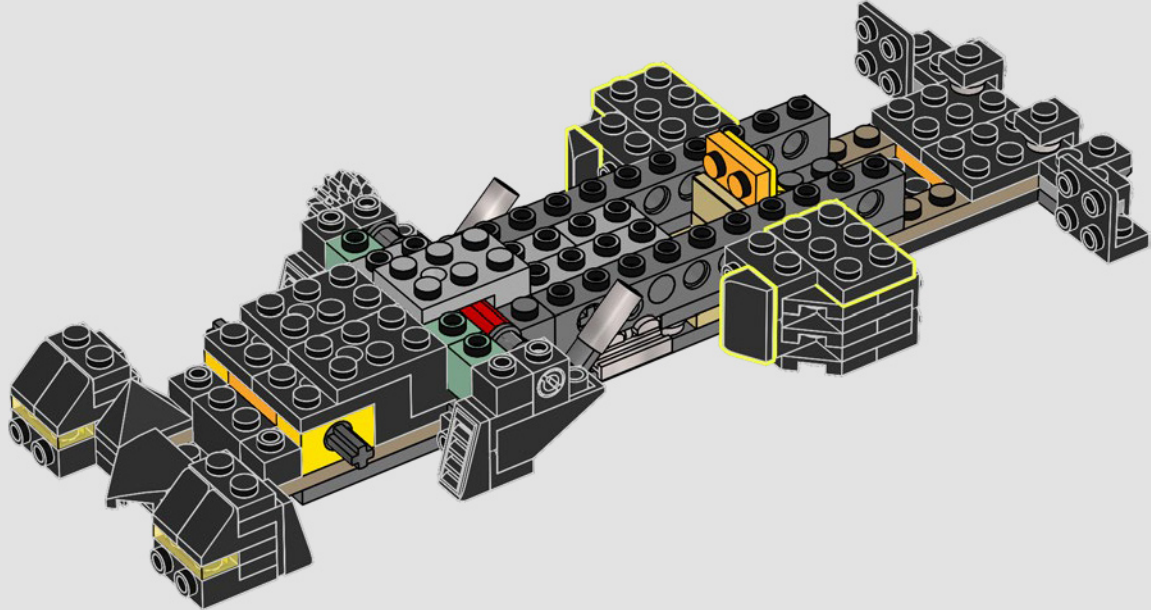

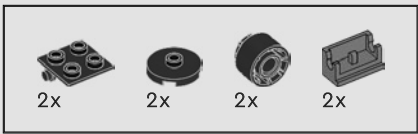

49

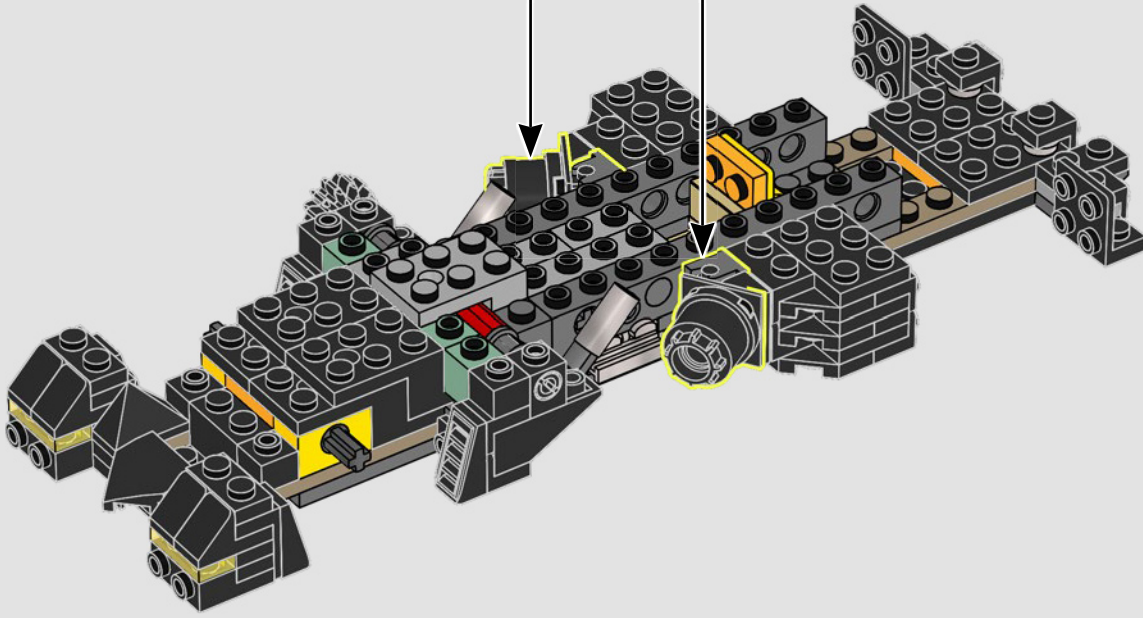
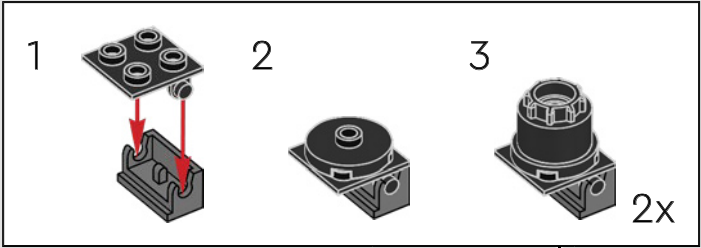



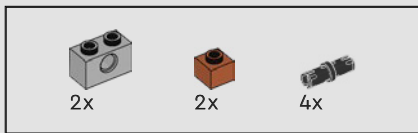

50

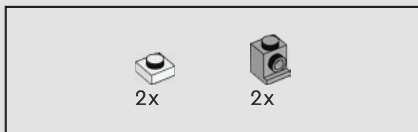
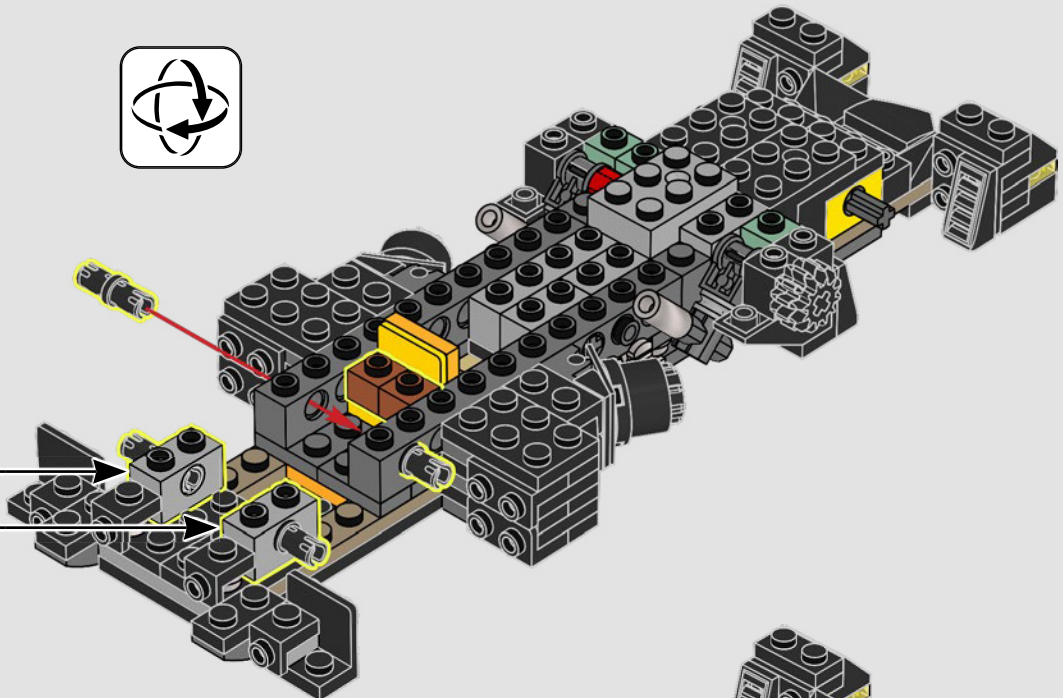
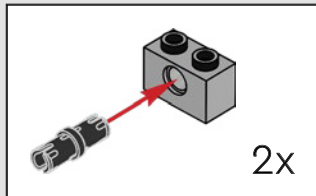
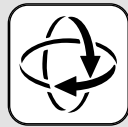

51

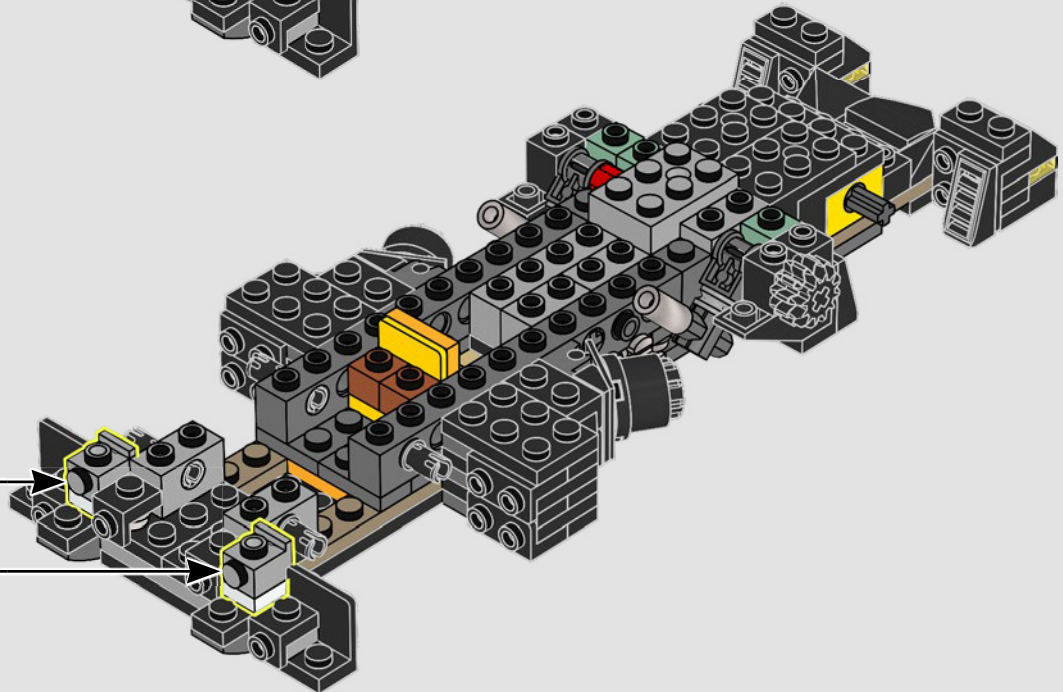
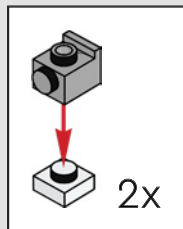

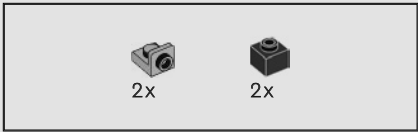

52

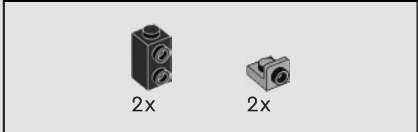
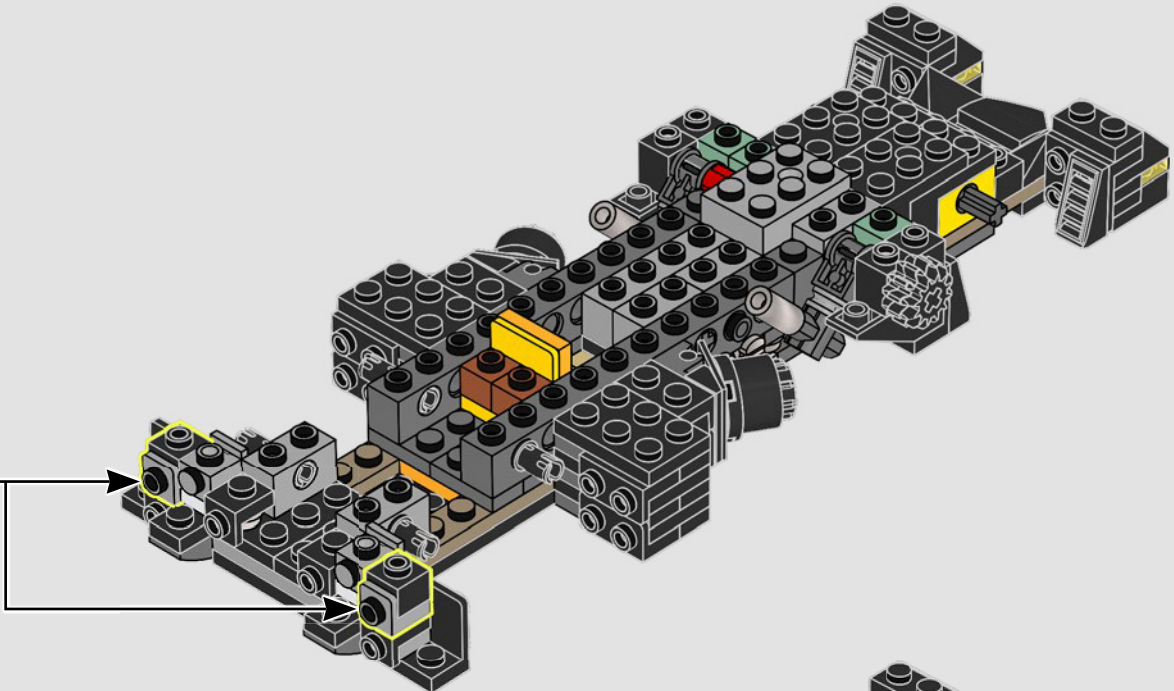
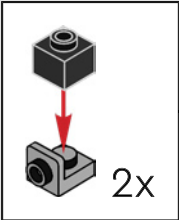

53

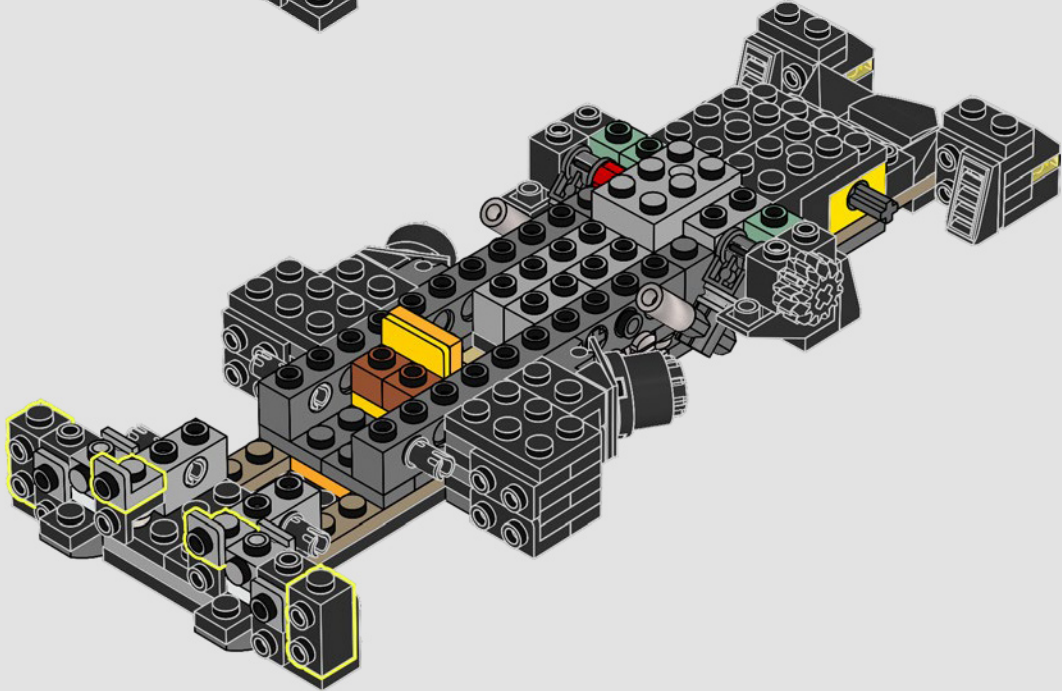

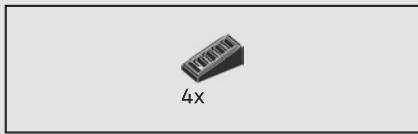

54

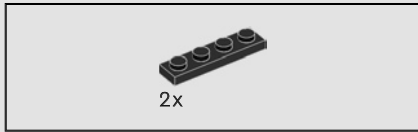
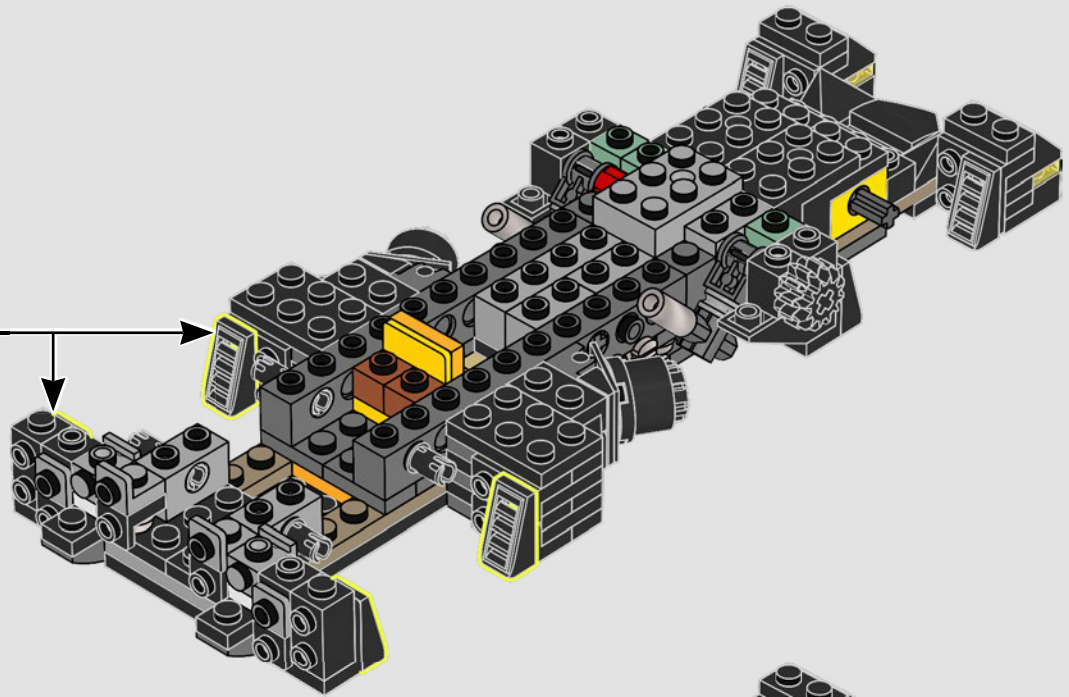
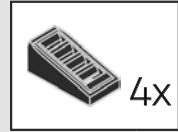

55

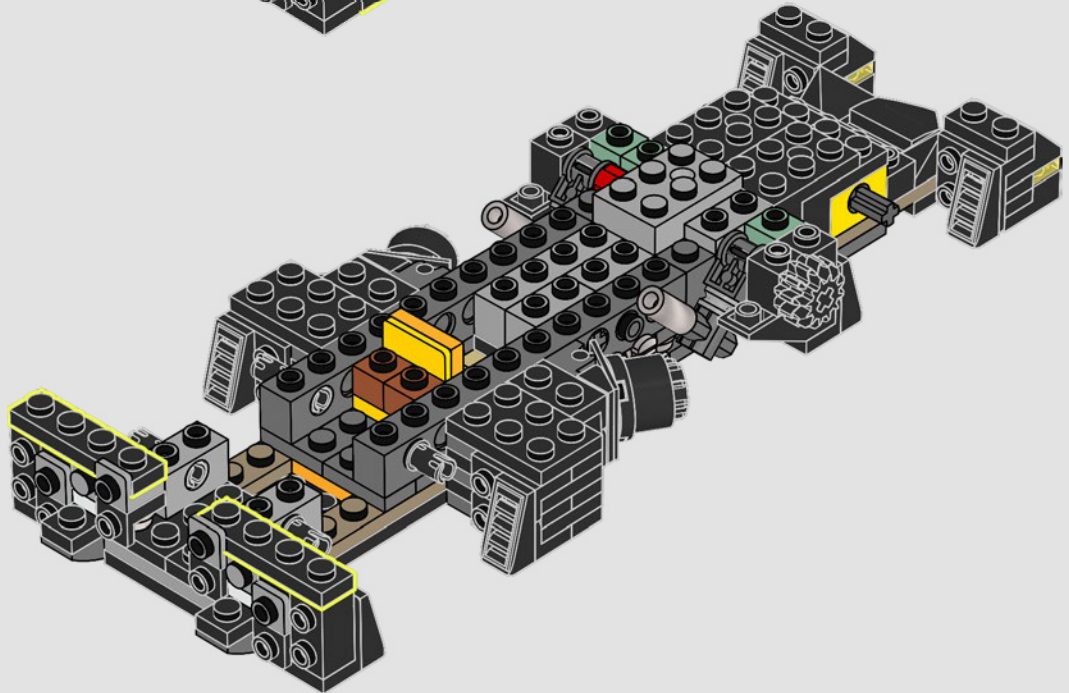

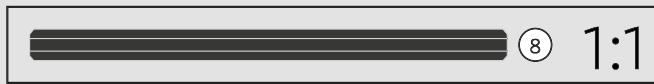
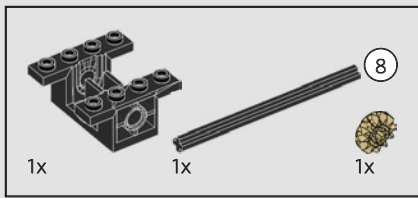

56

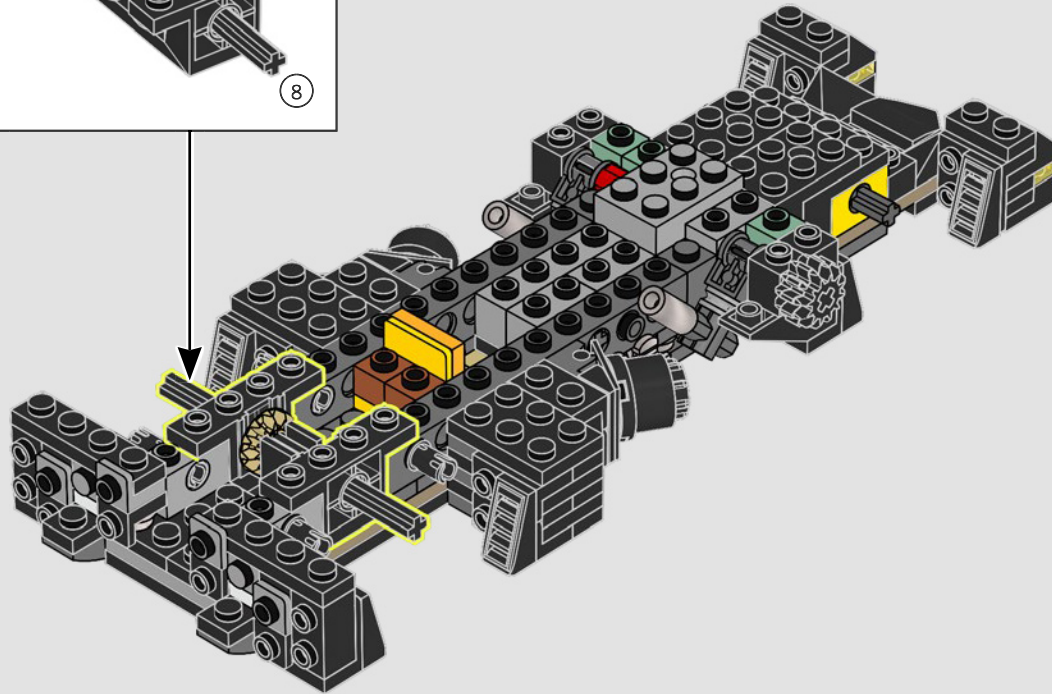
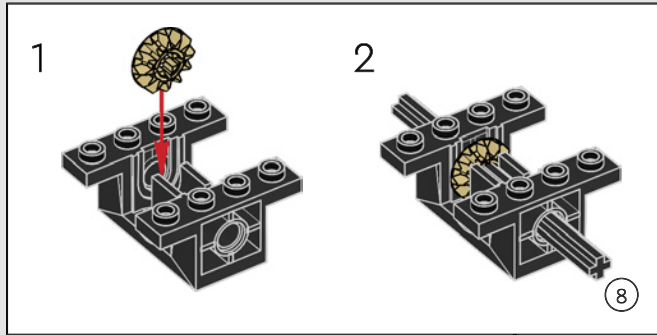

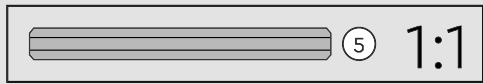
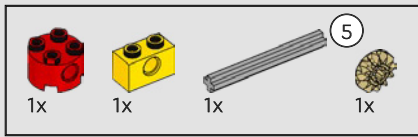

57

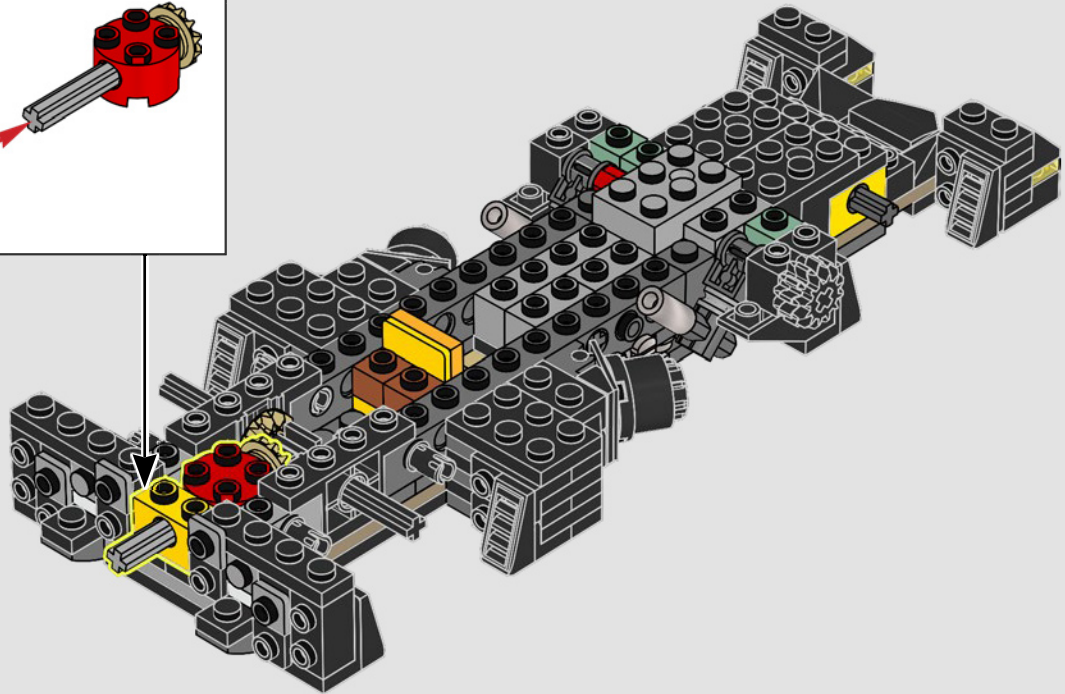
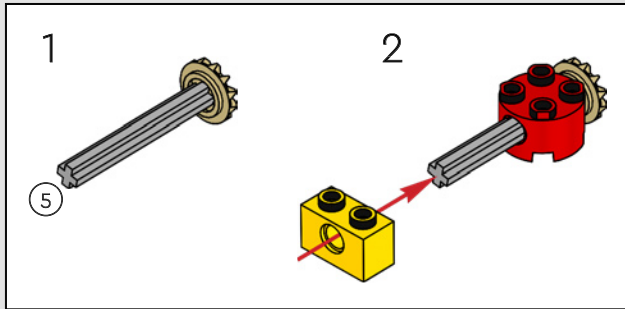

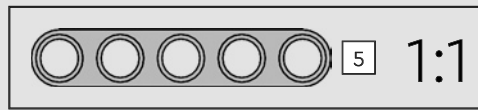
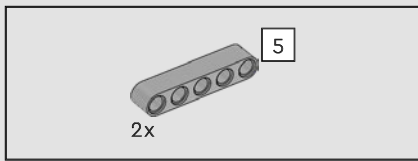

58

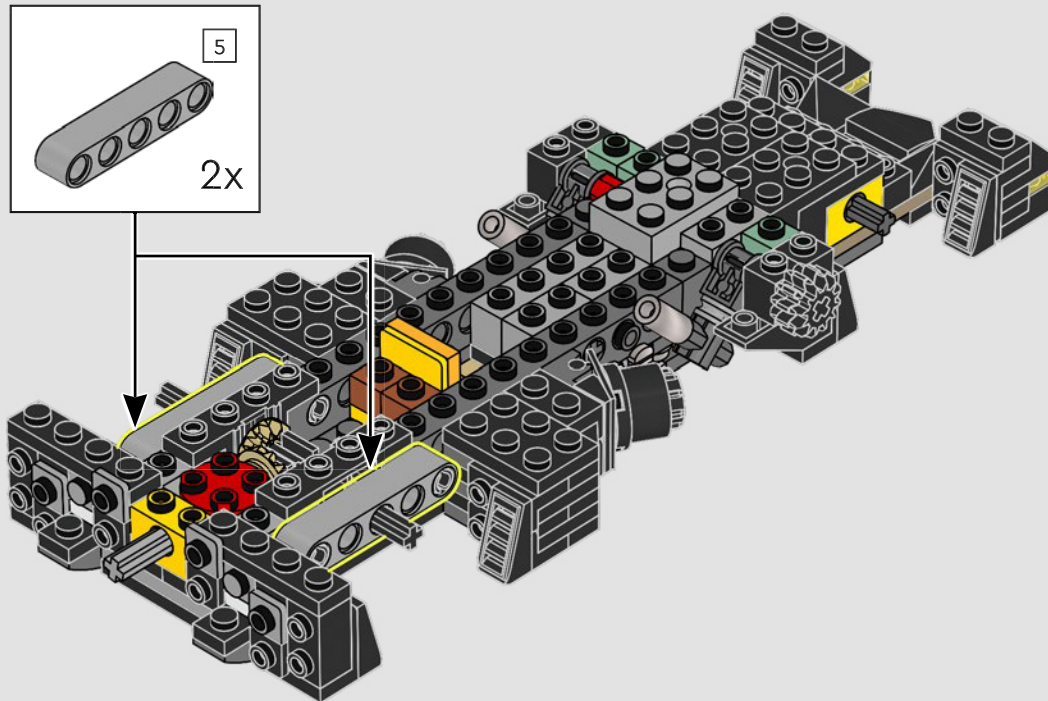

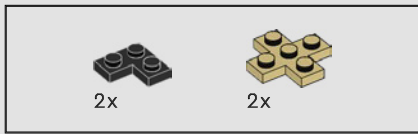

59

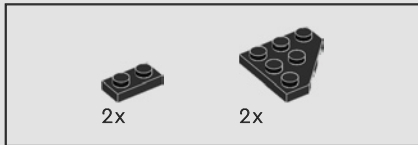
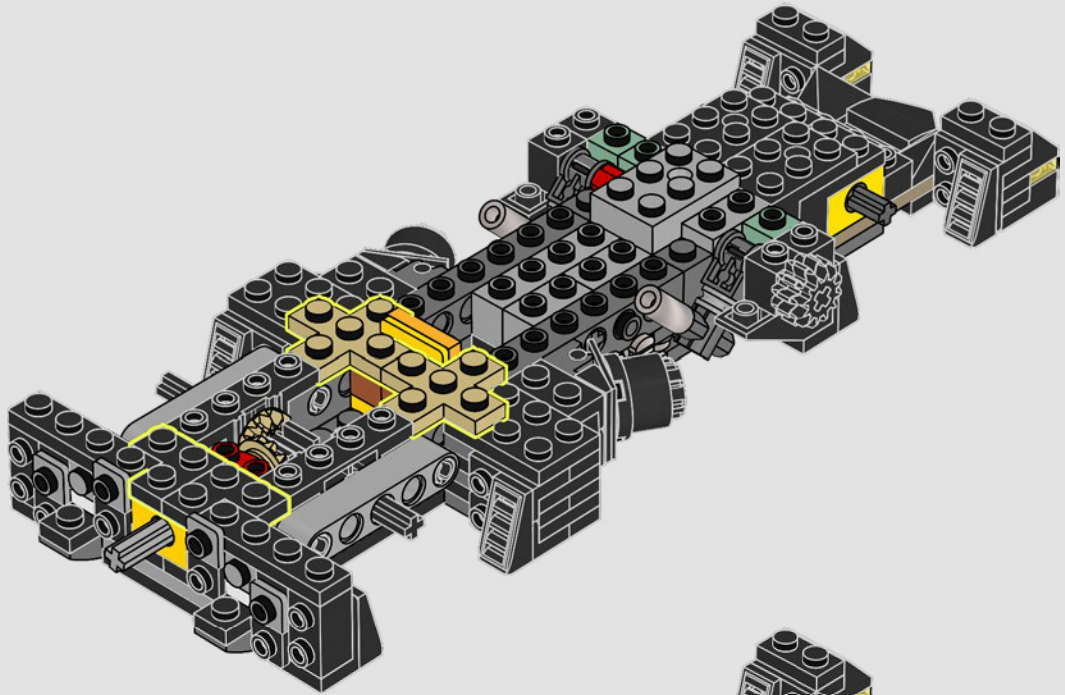

60

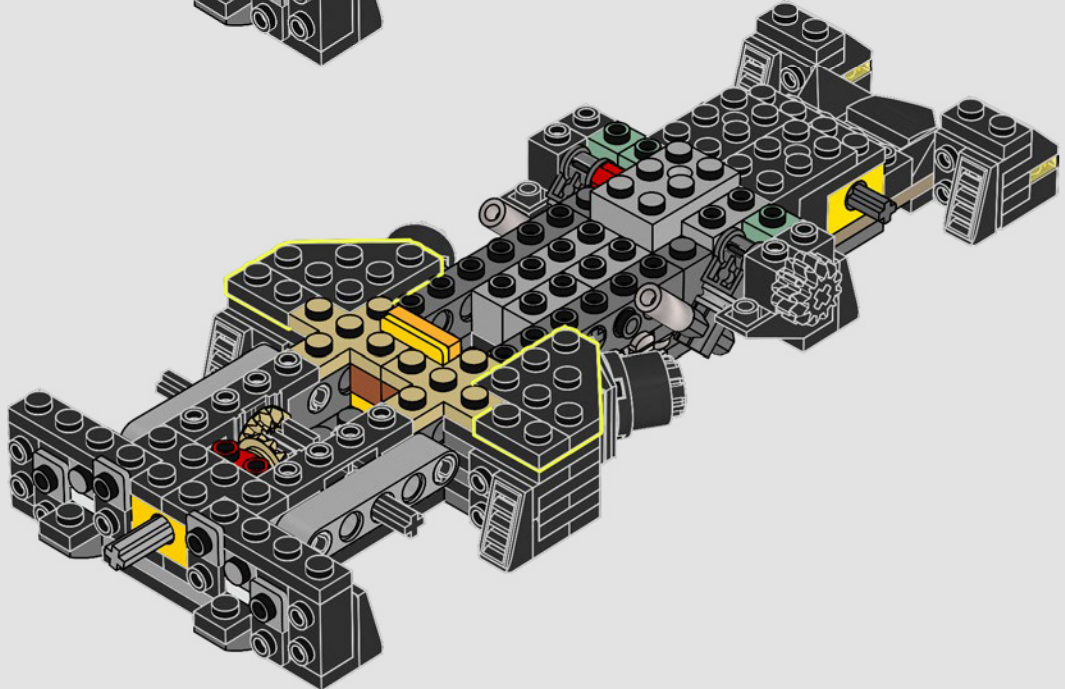

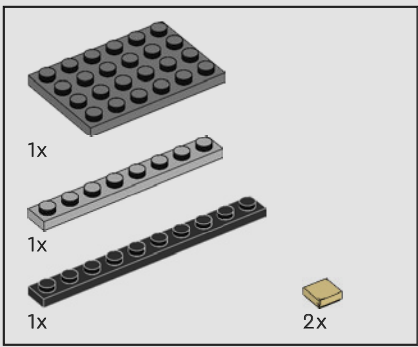

61

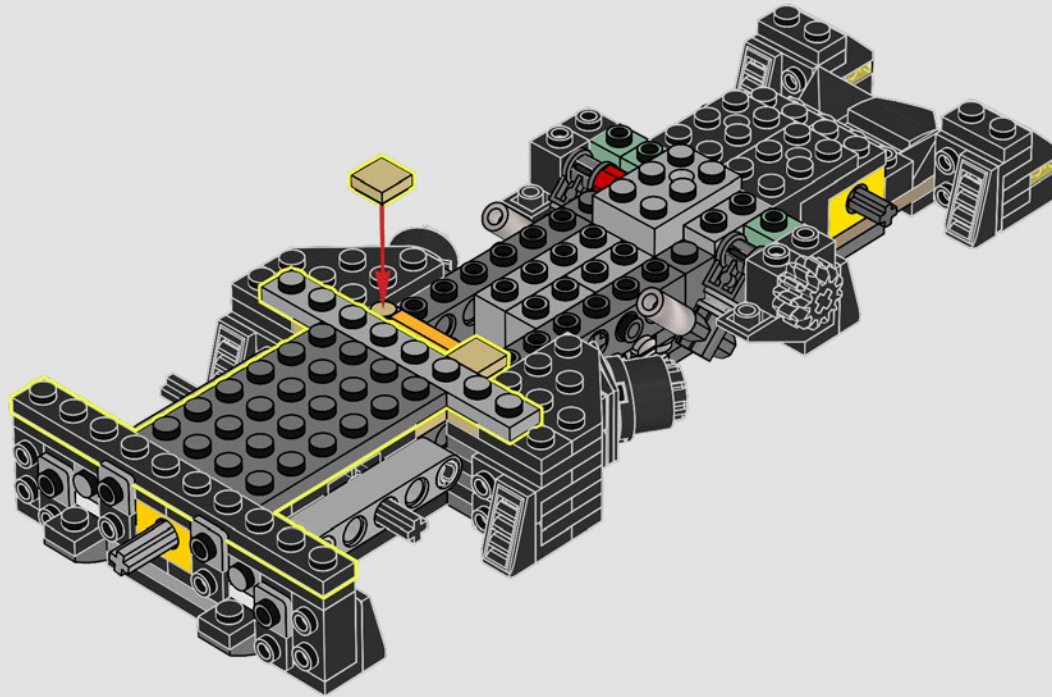



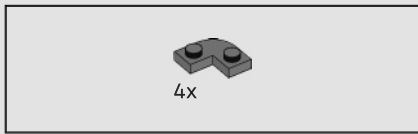

62

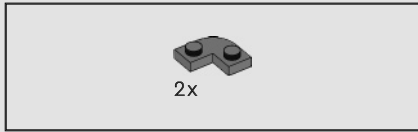
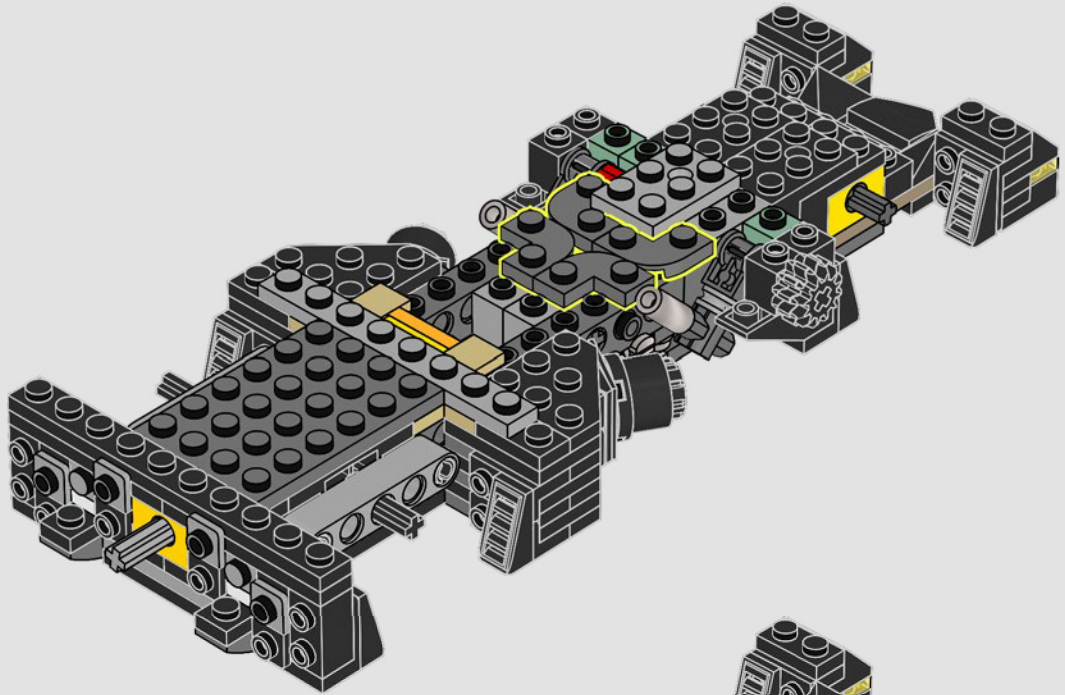

63

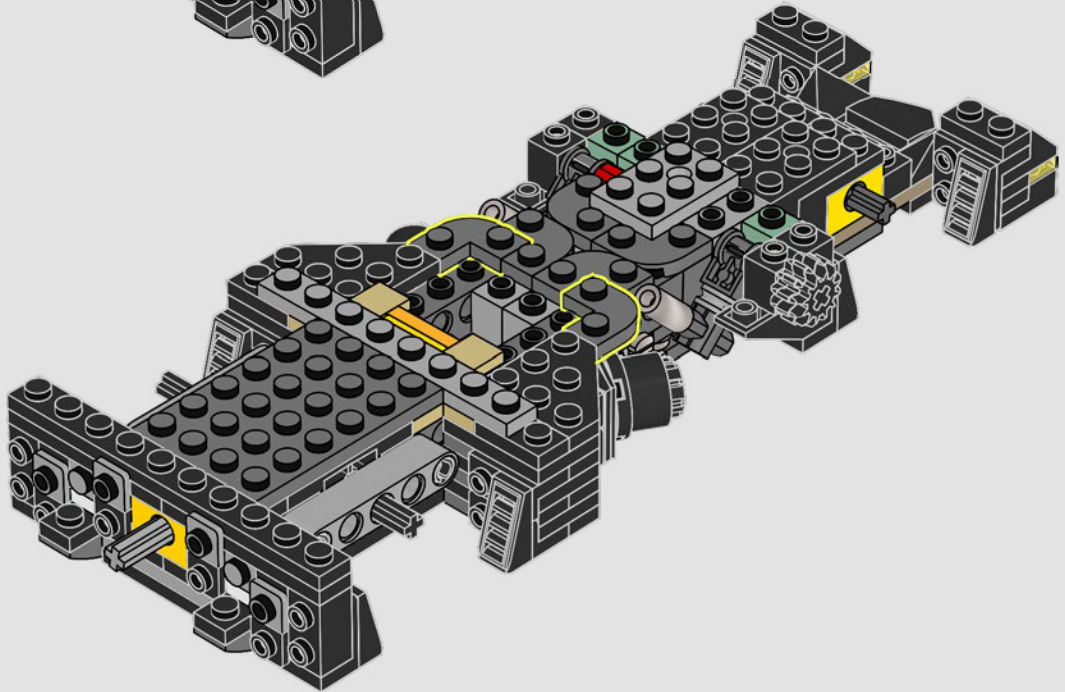

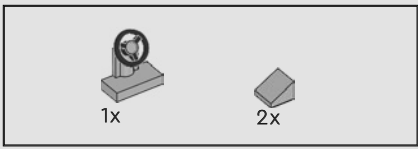

64

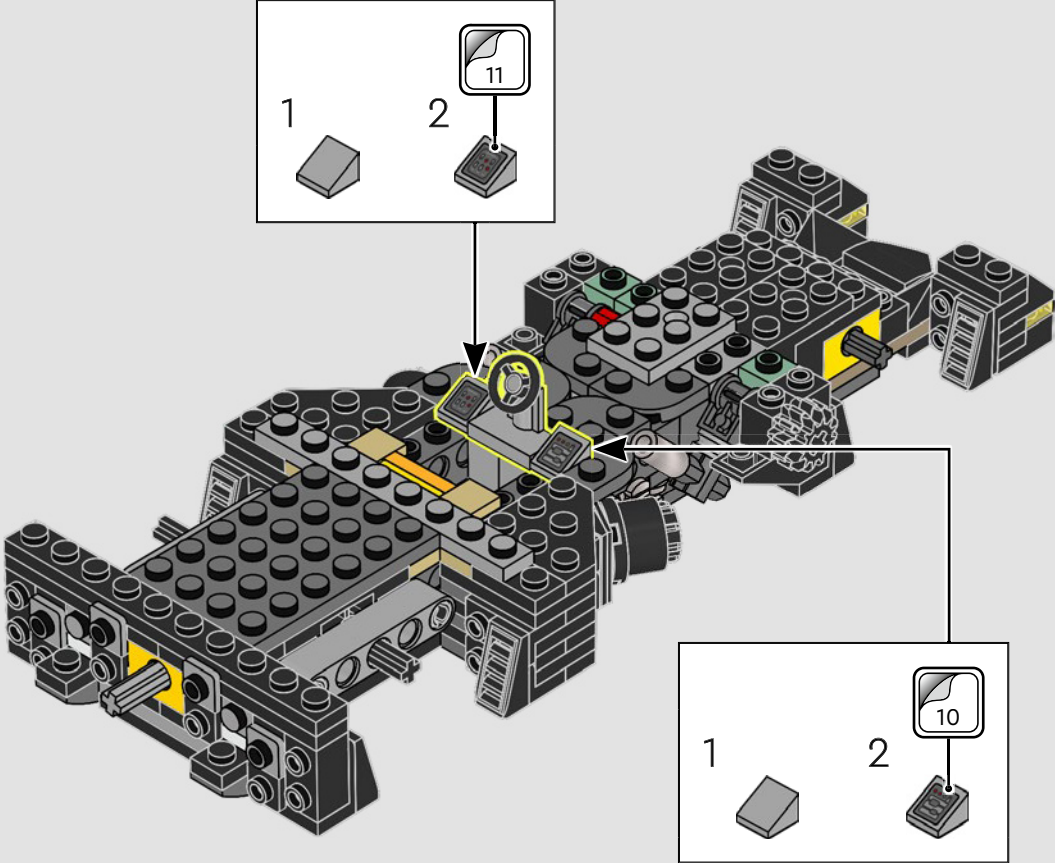

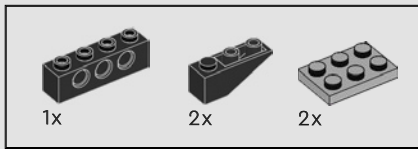

65

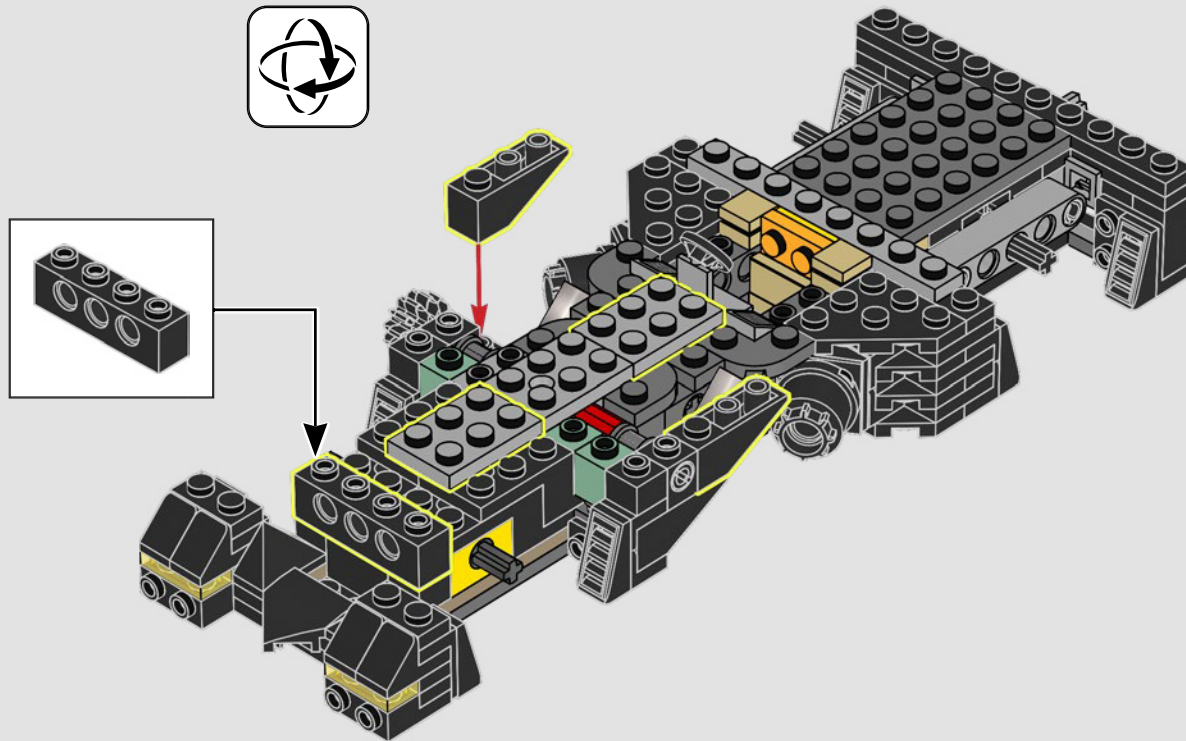

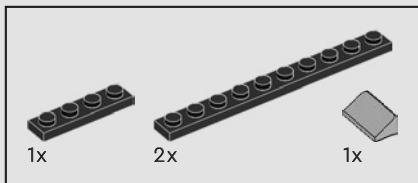

66

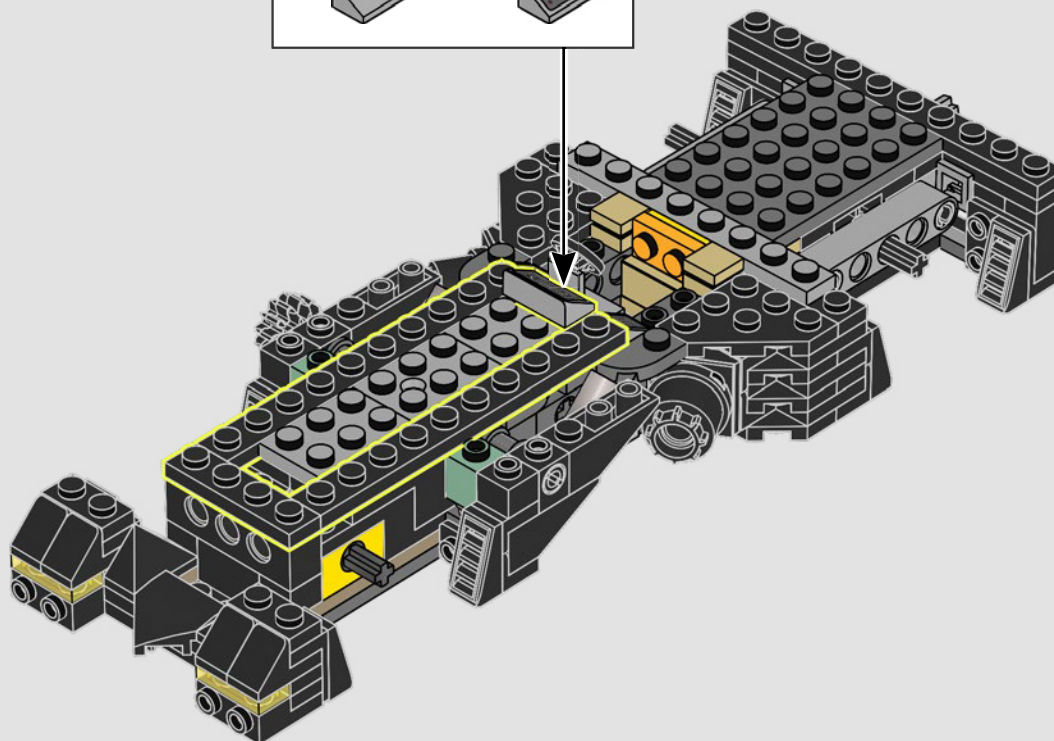
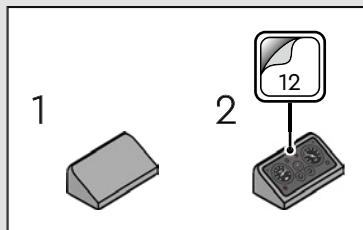

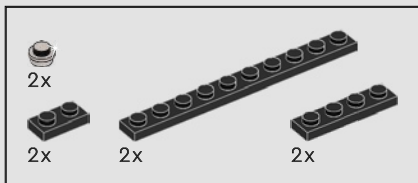

67

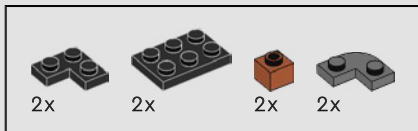
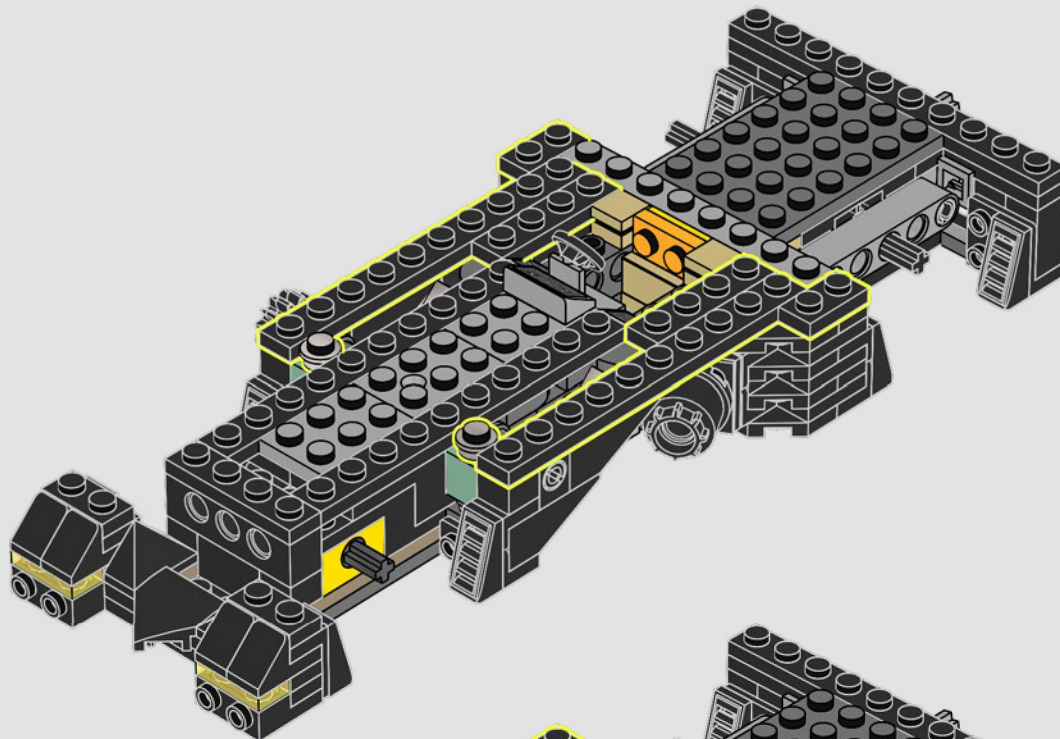

68



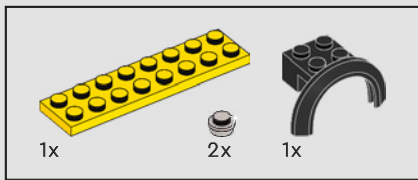

69

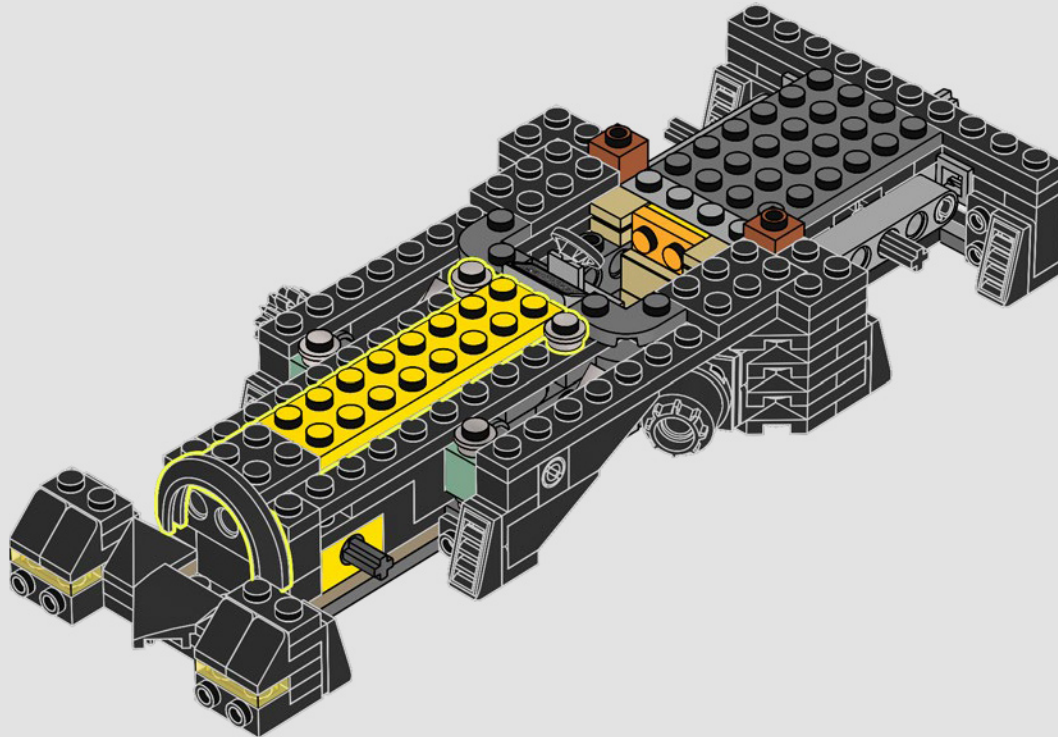

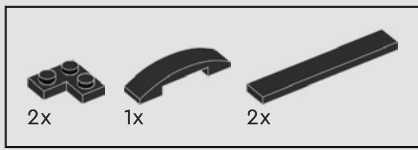

70

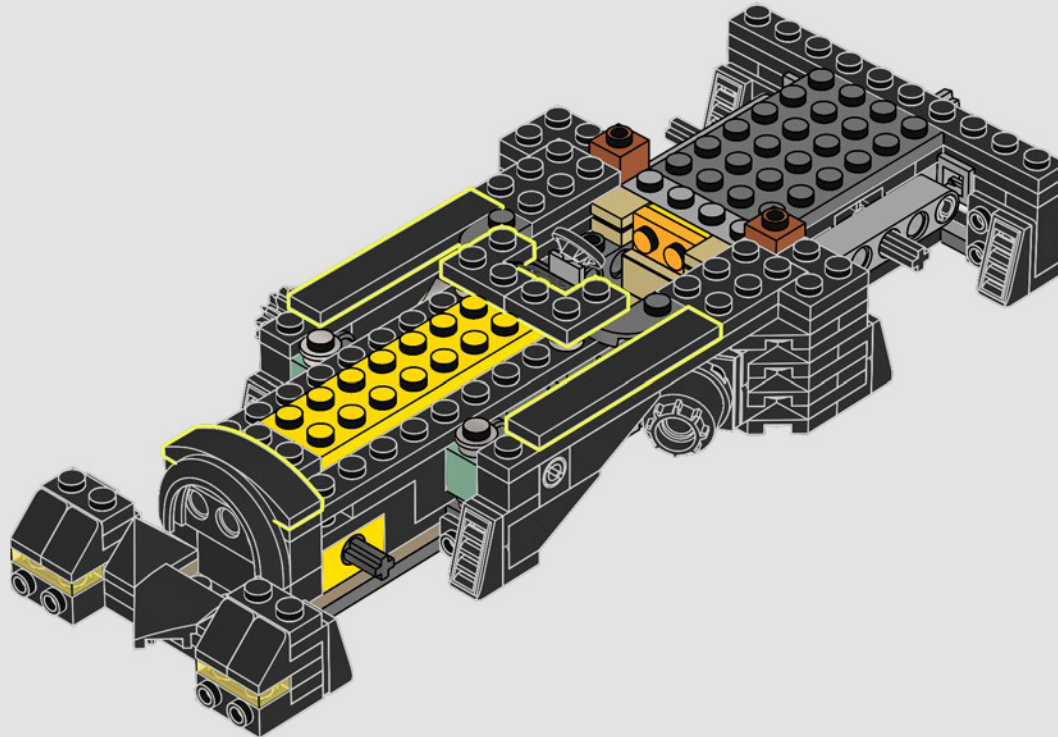

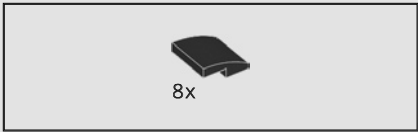

71

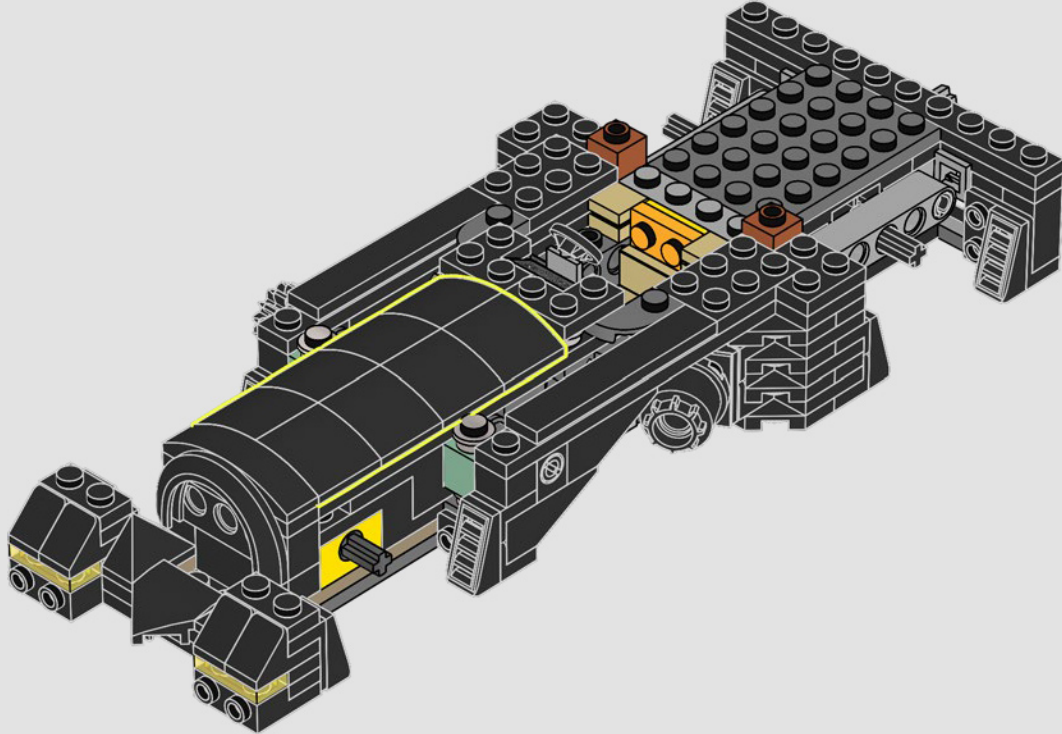



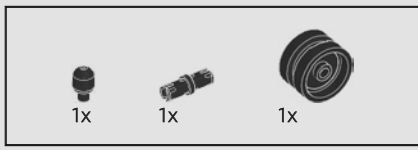

72

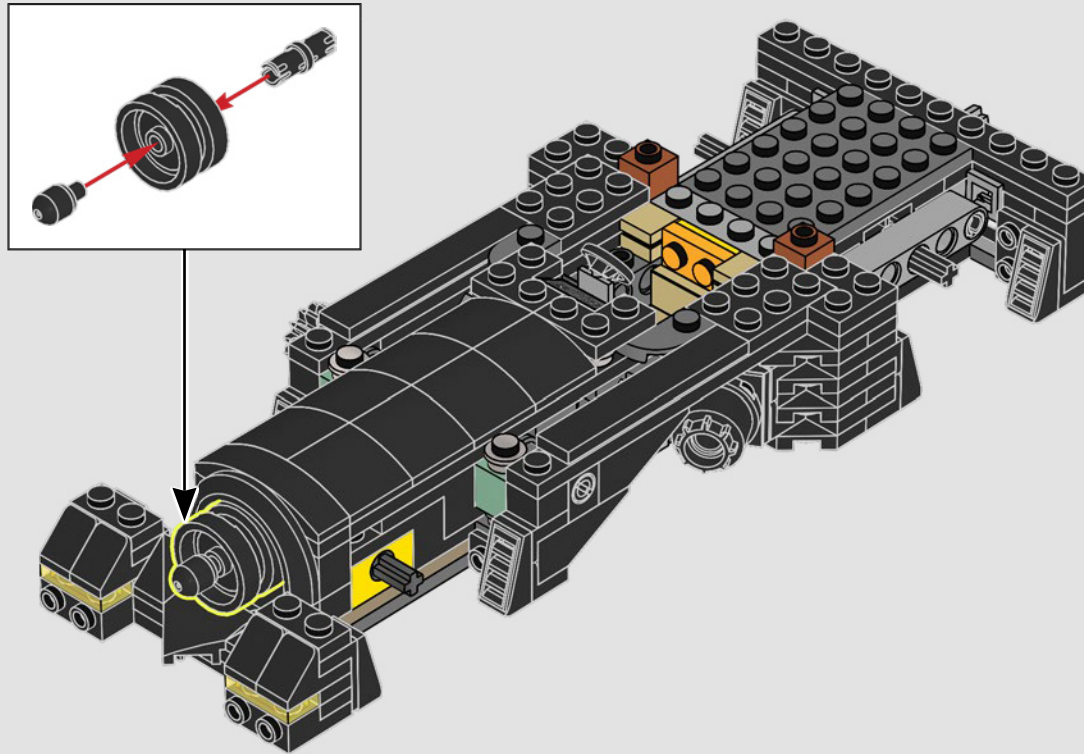



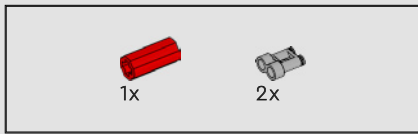

73

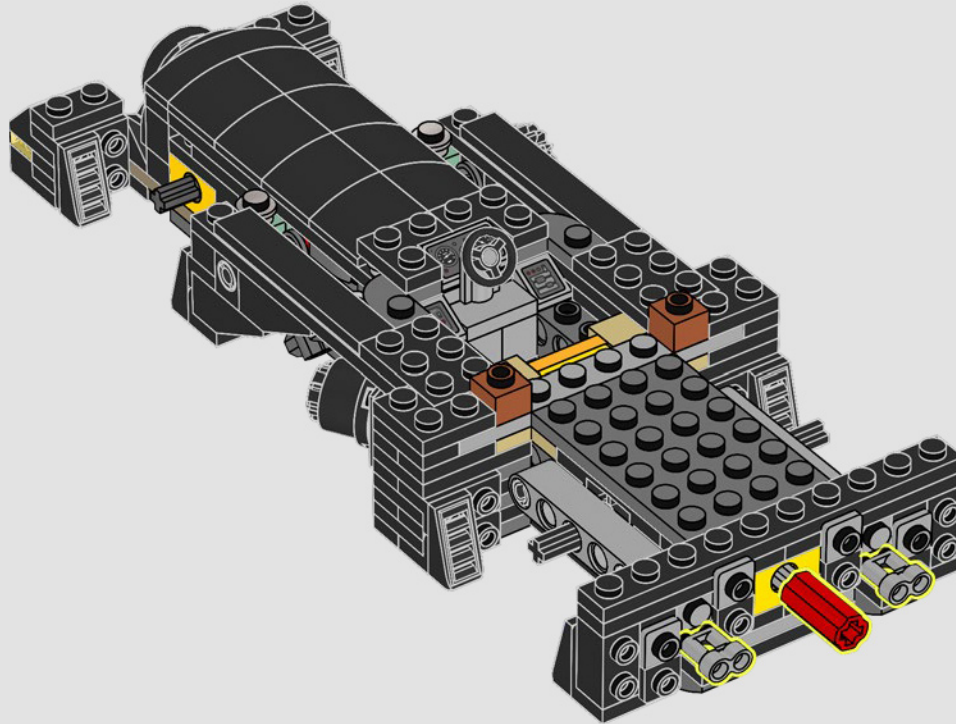

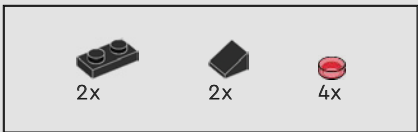

74

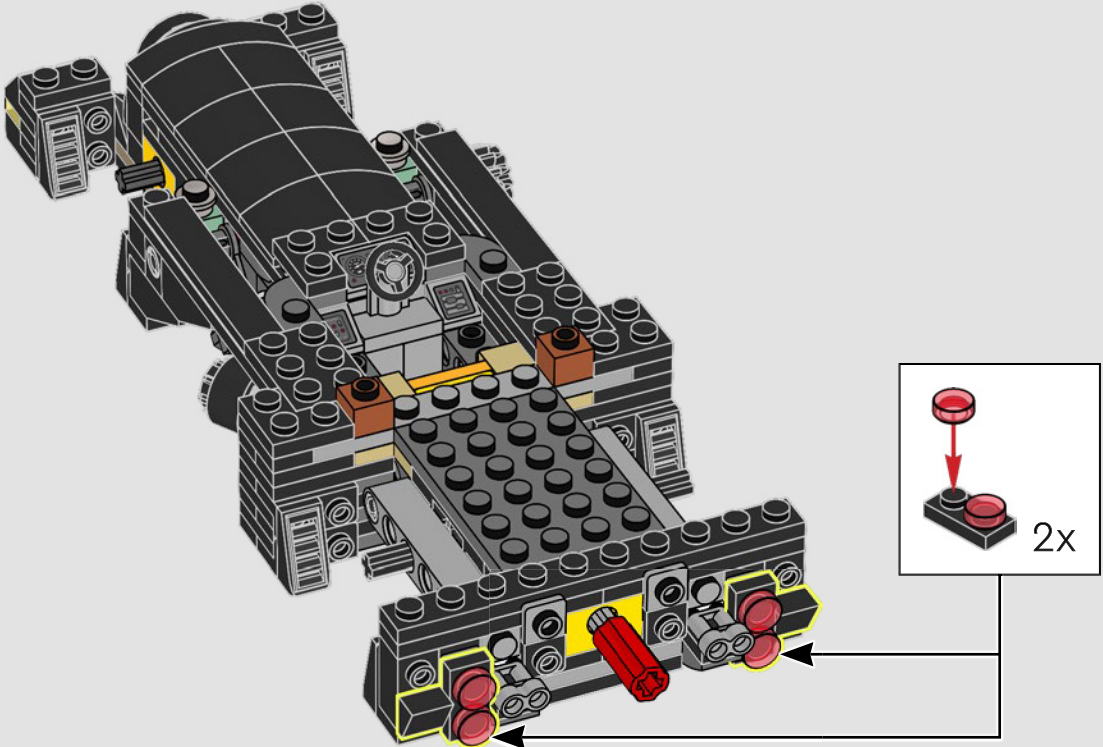

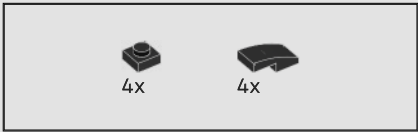

75

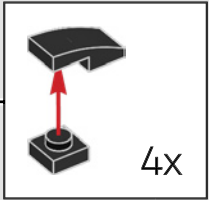
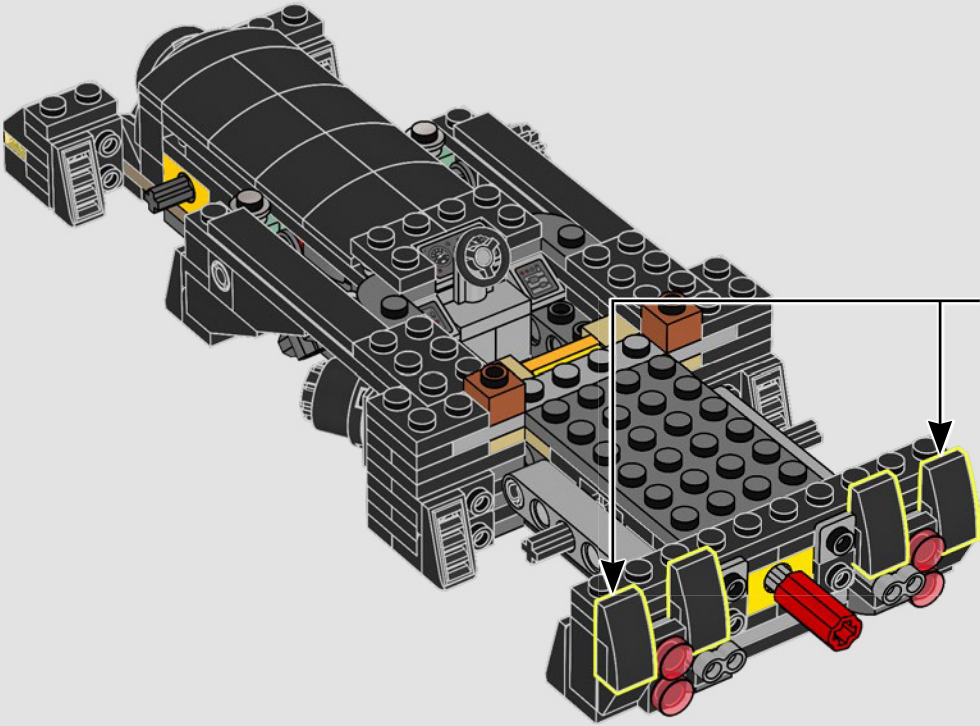

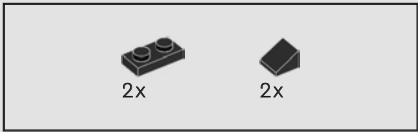

76

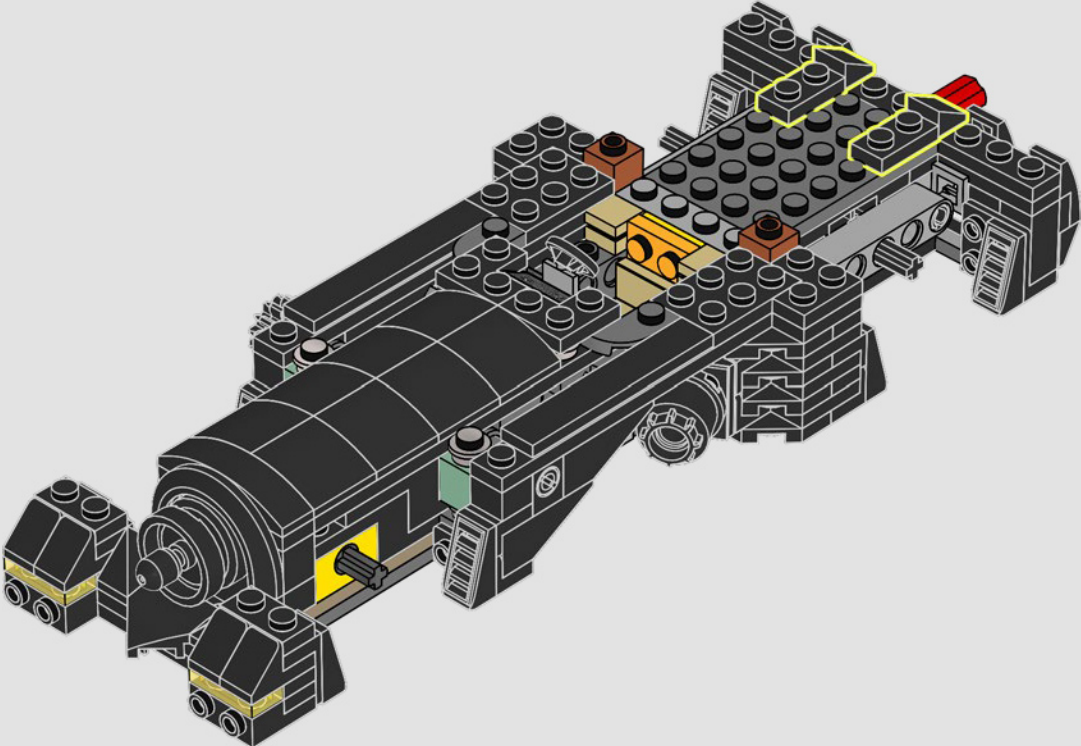

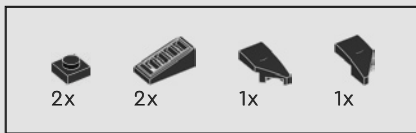

77

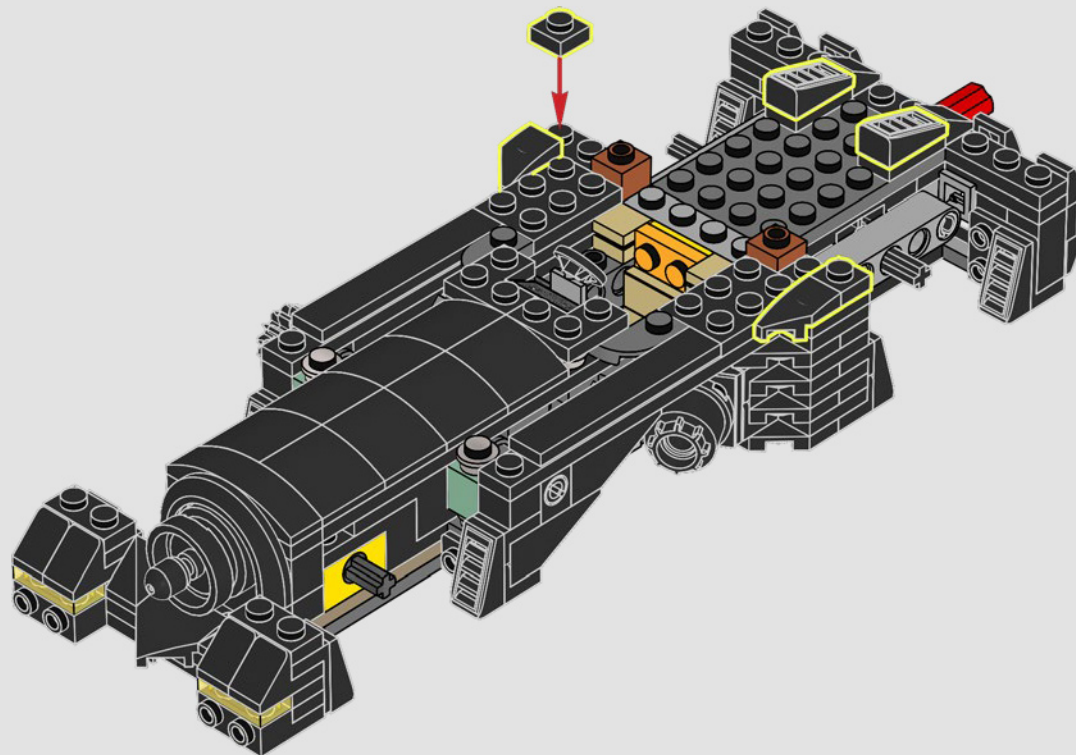

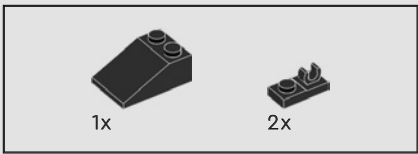

78

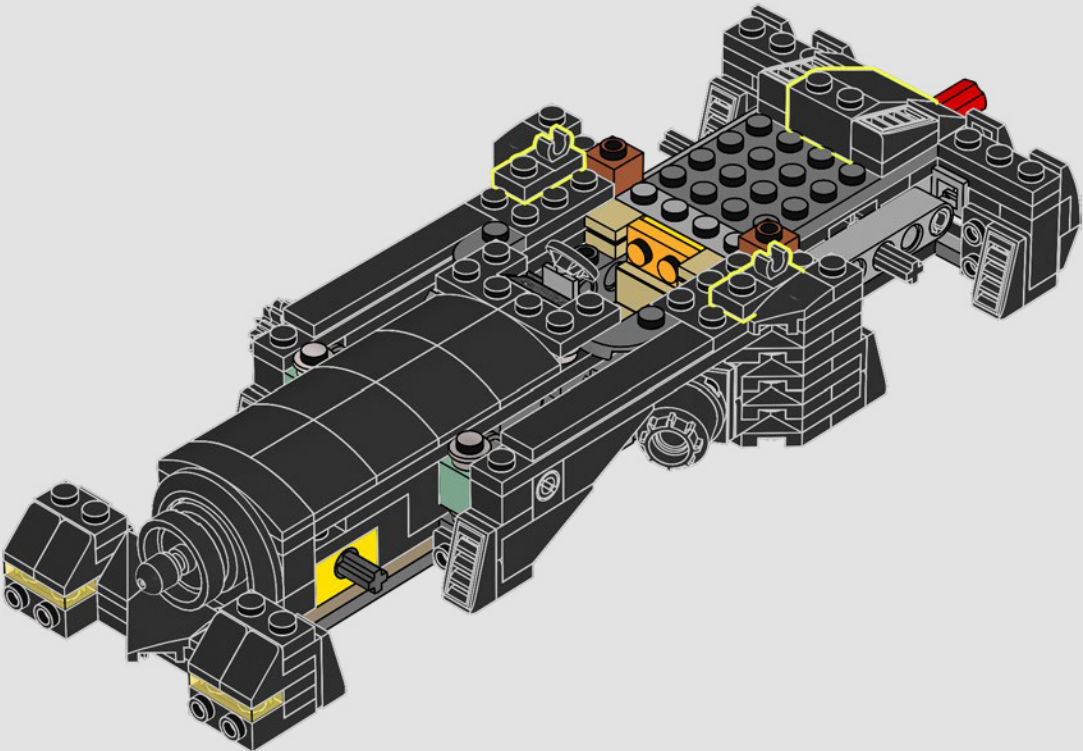



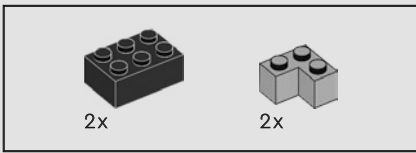

79

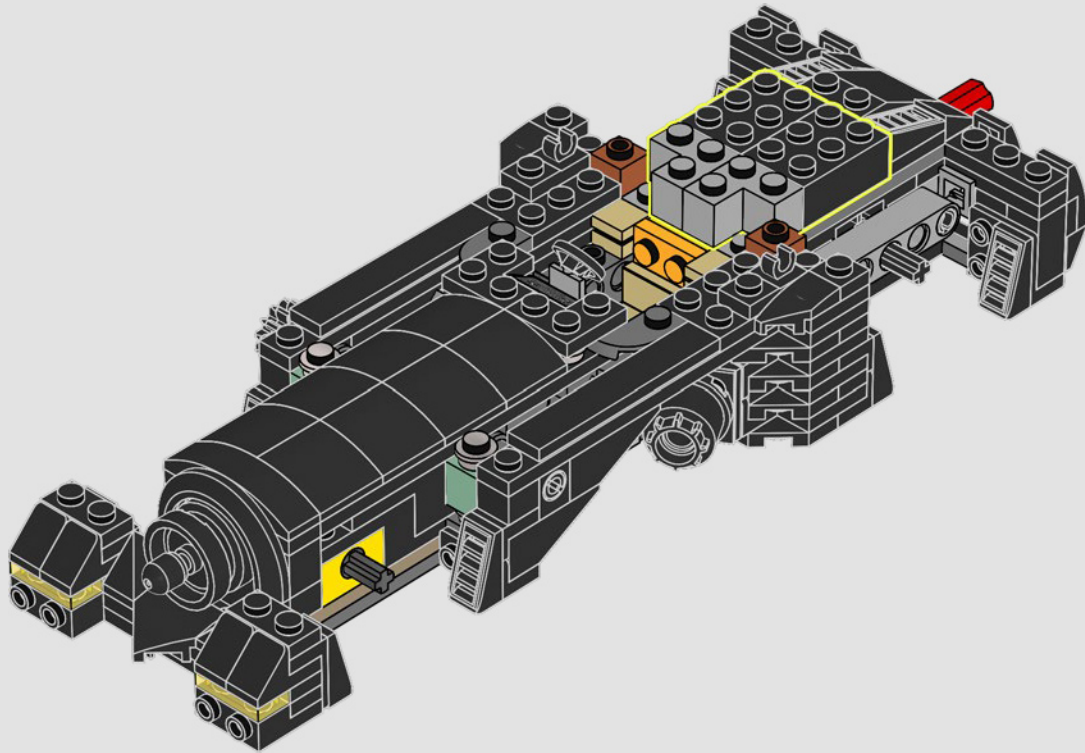

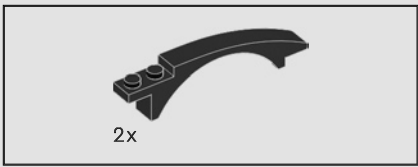

80

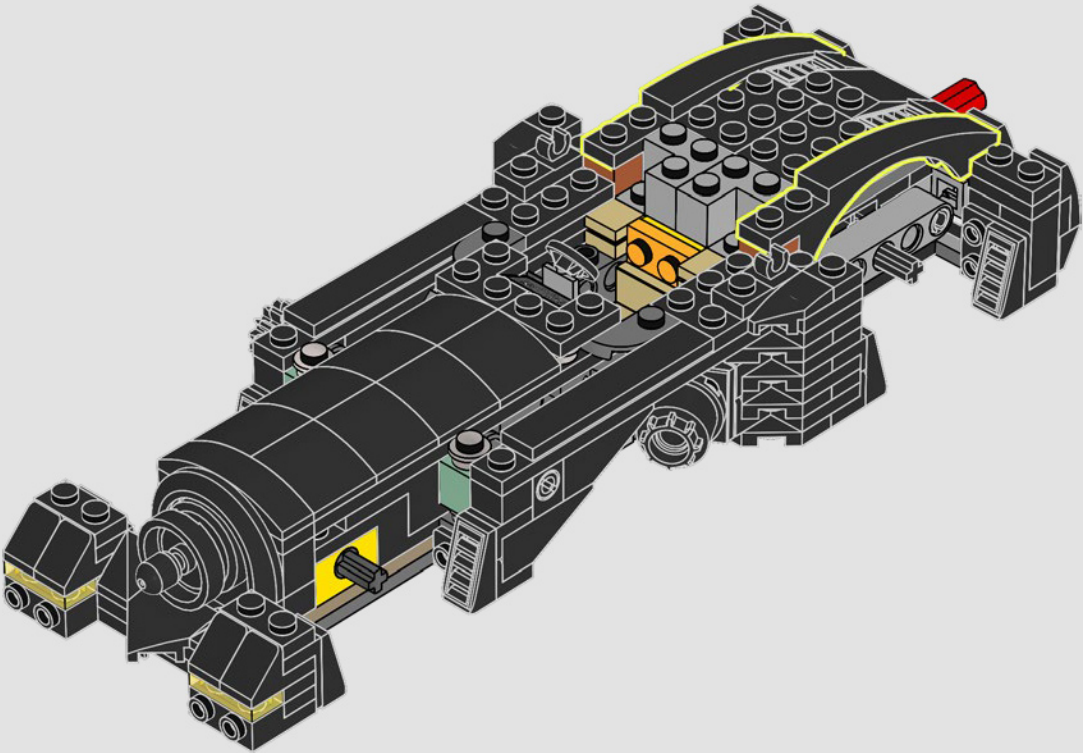



81

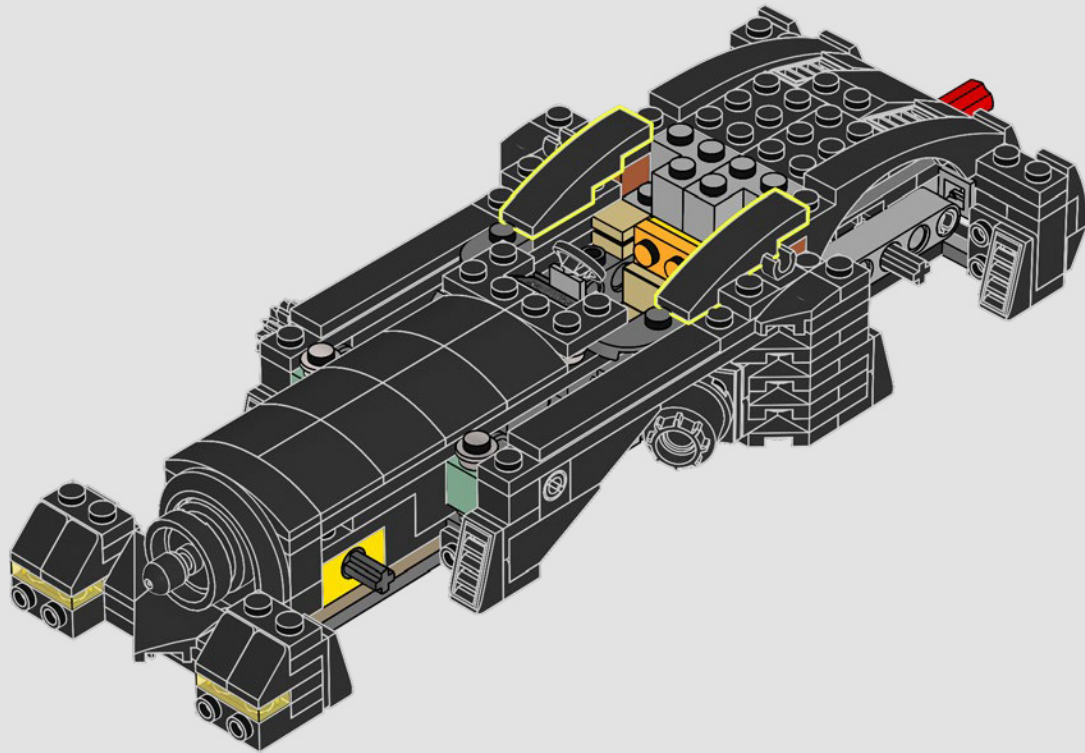

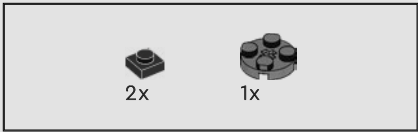

82

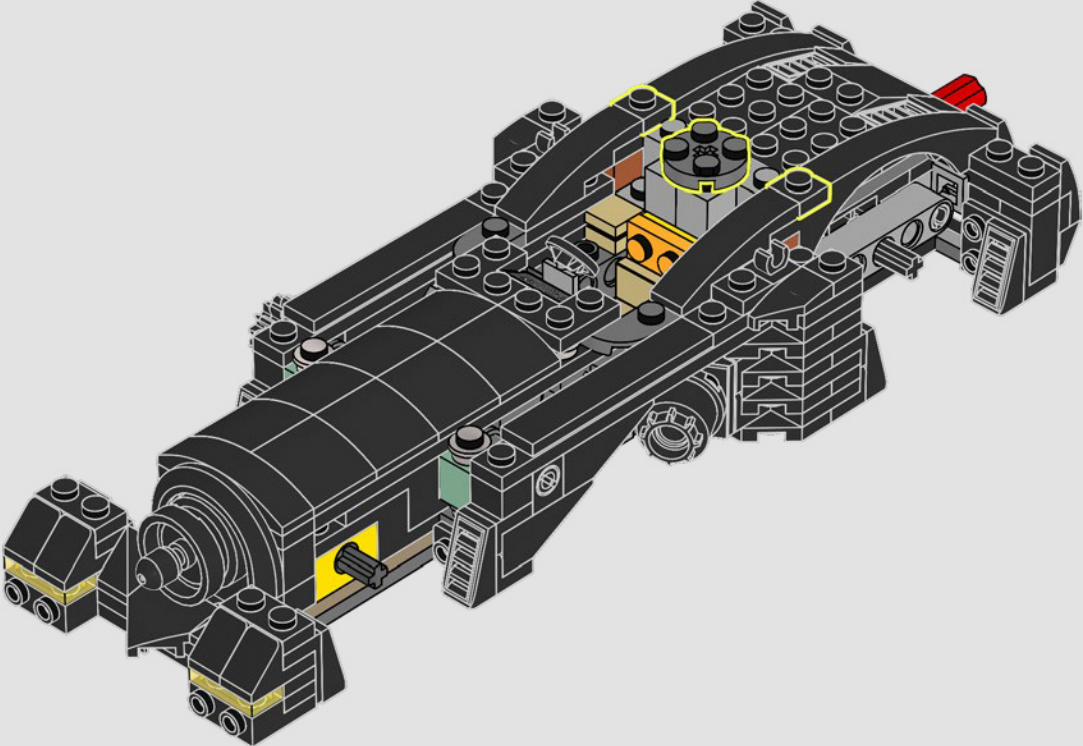

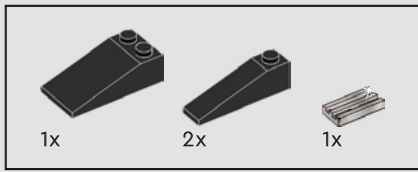

83

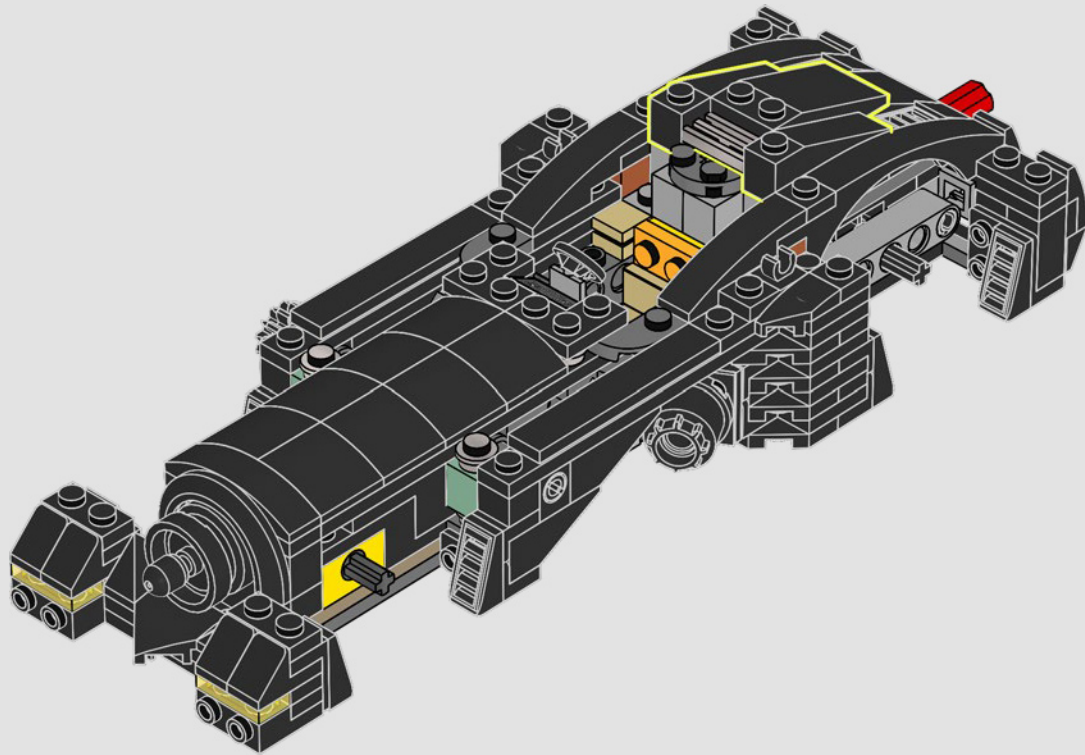

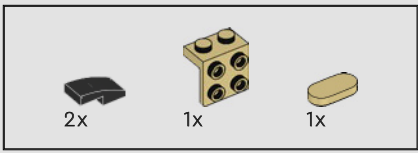

84

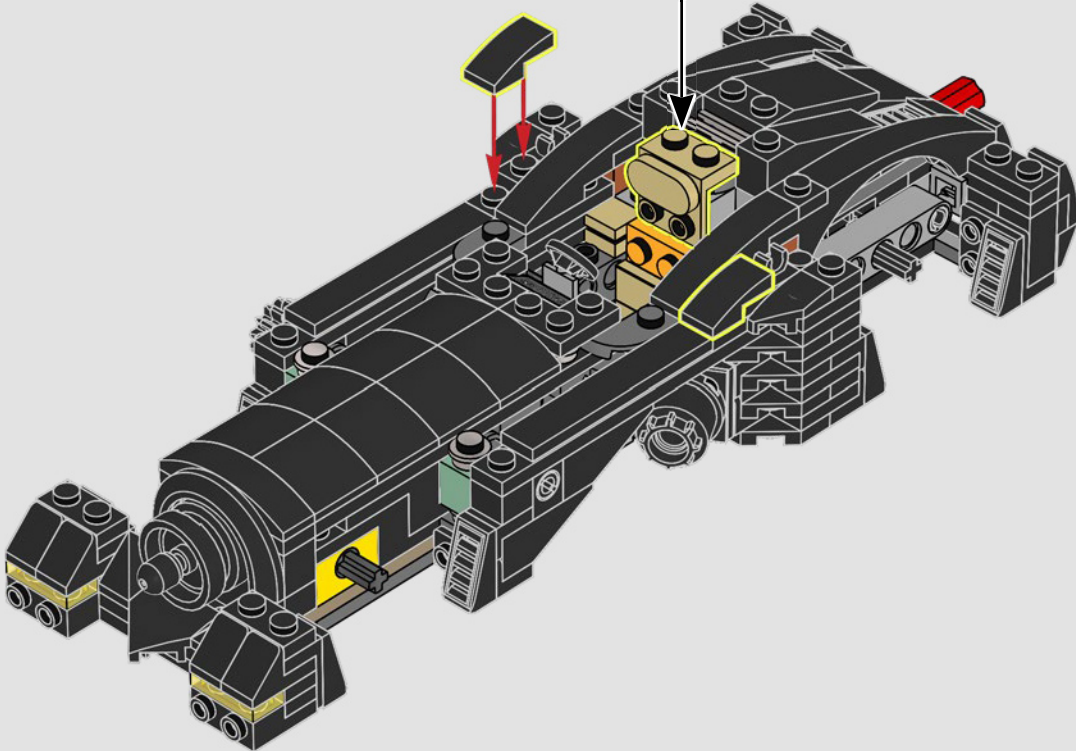
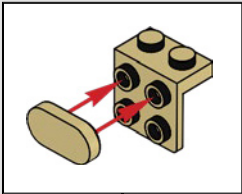

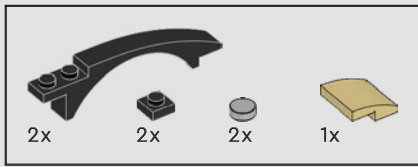

85

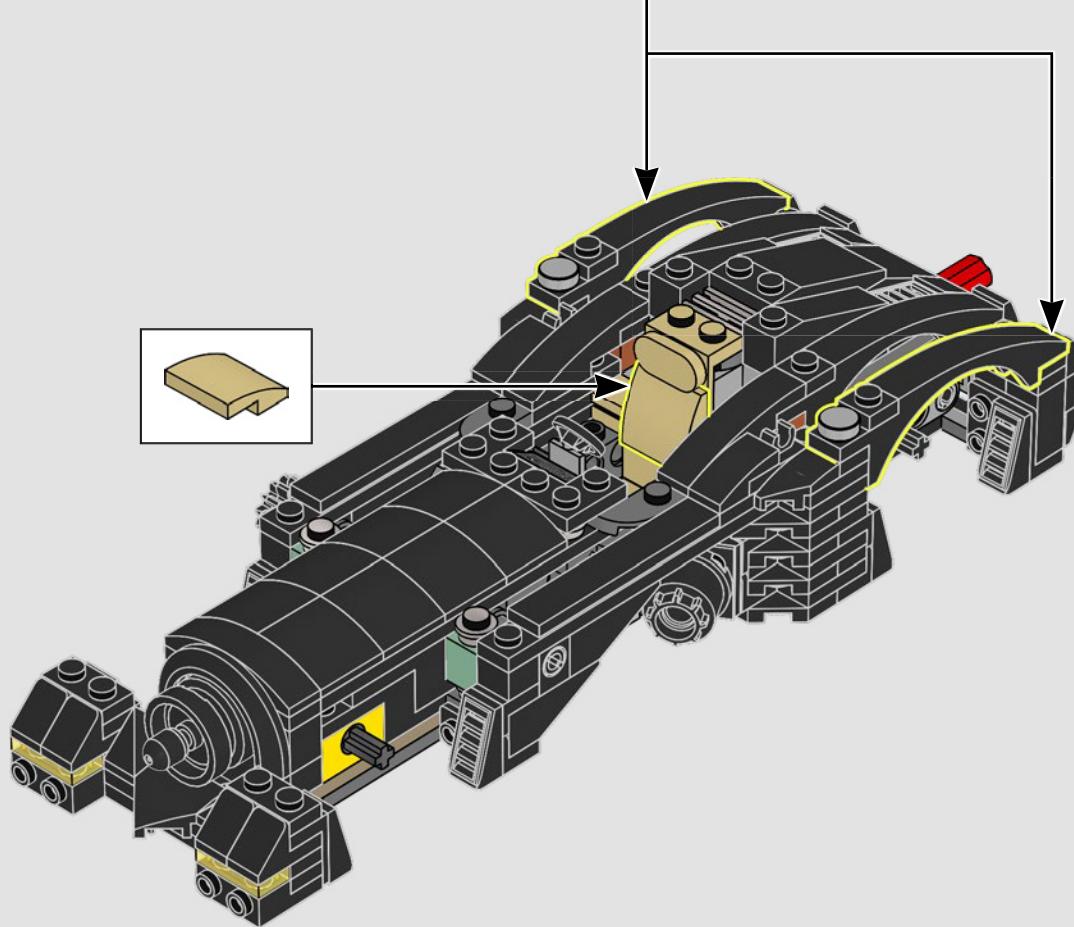
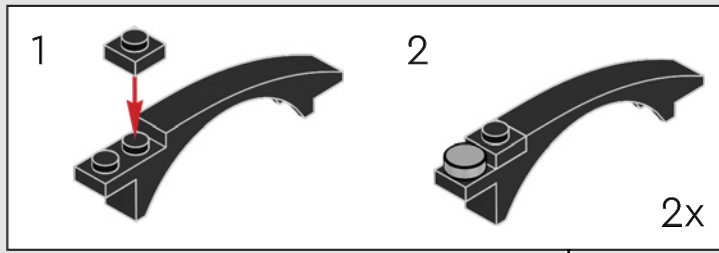

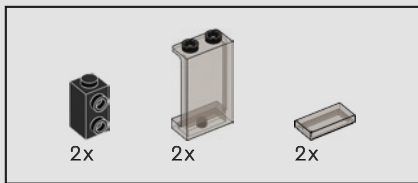

86

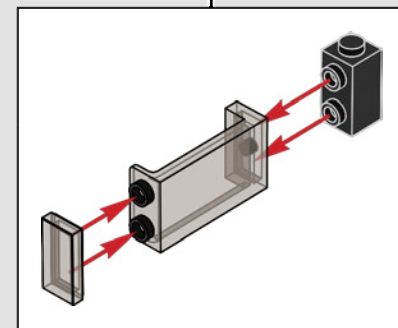
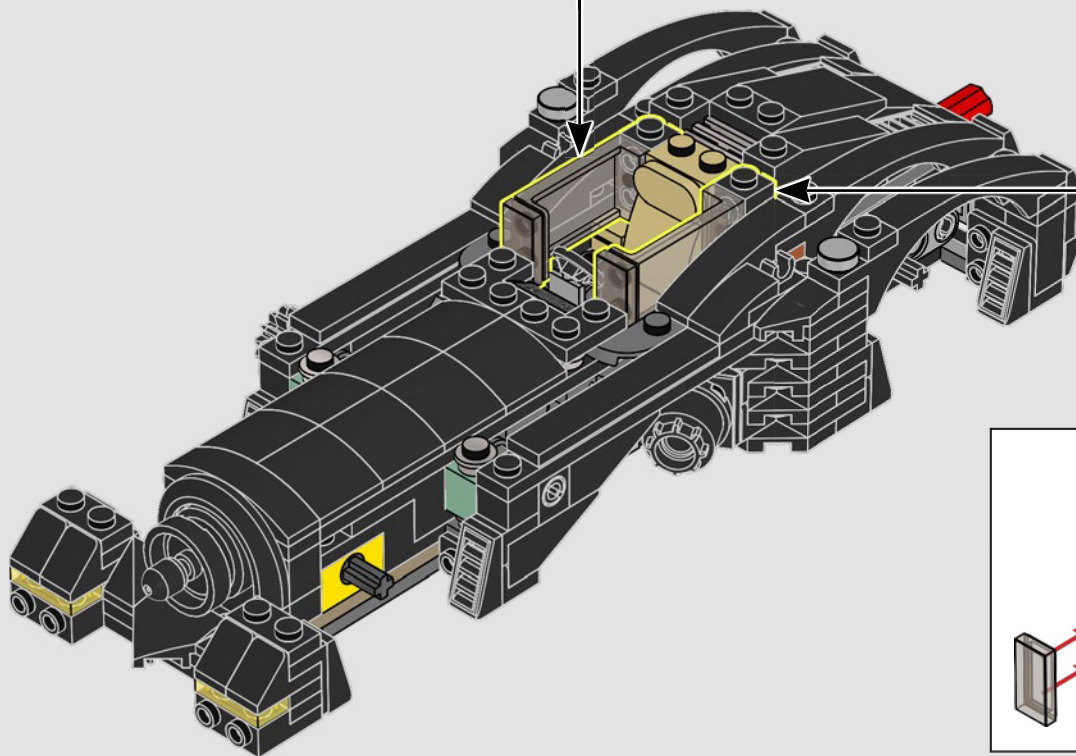
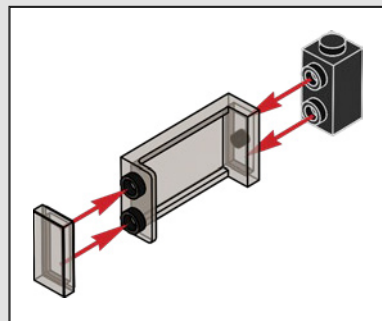



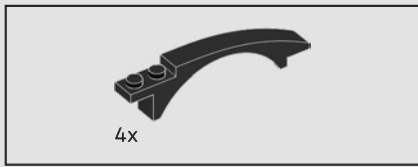

87

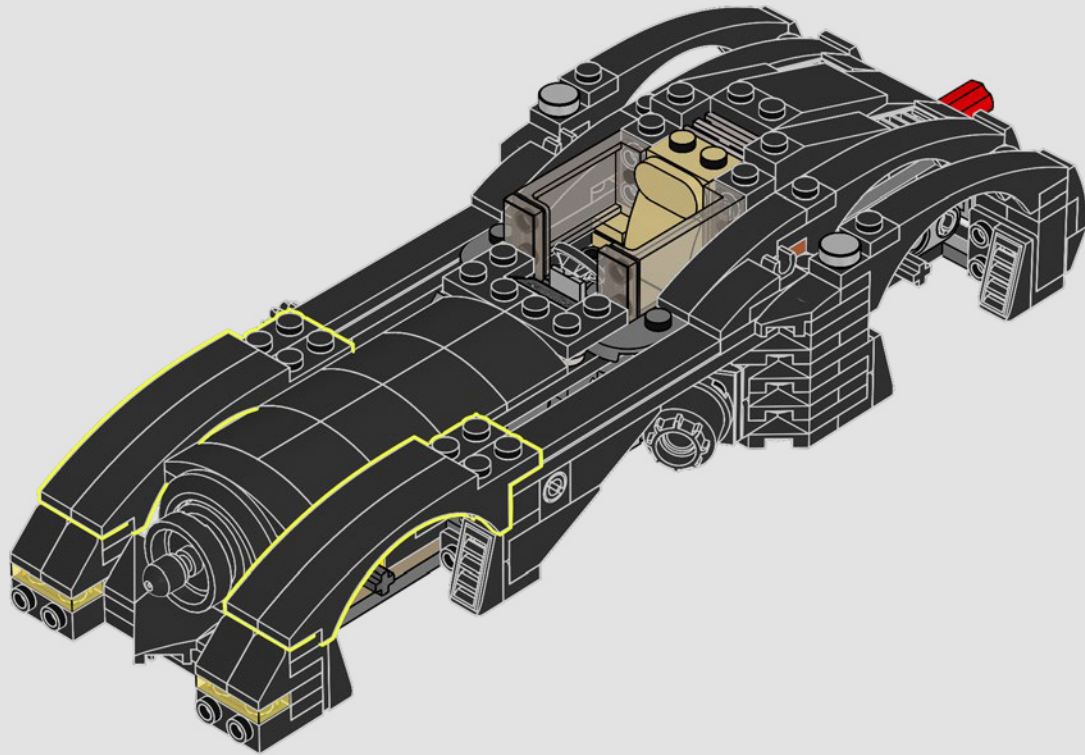

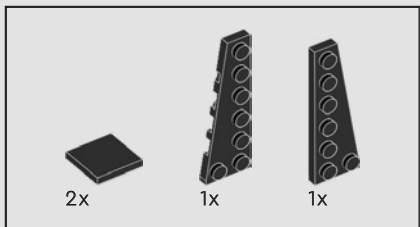

88

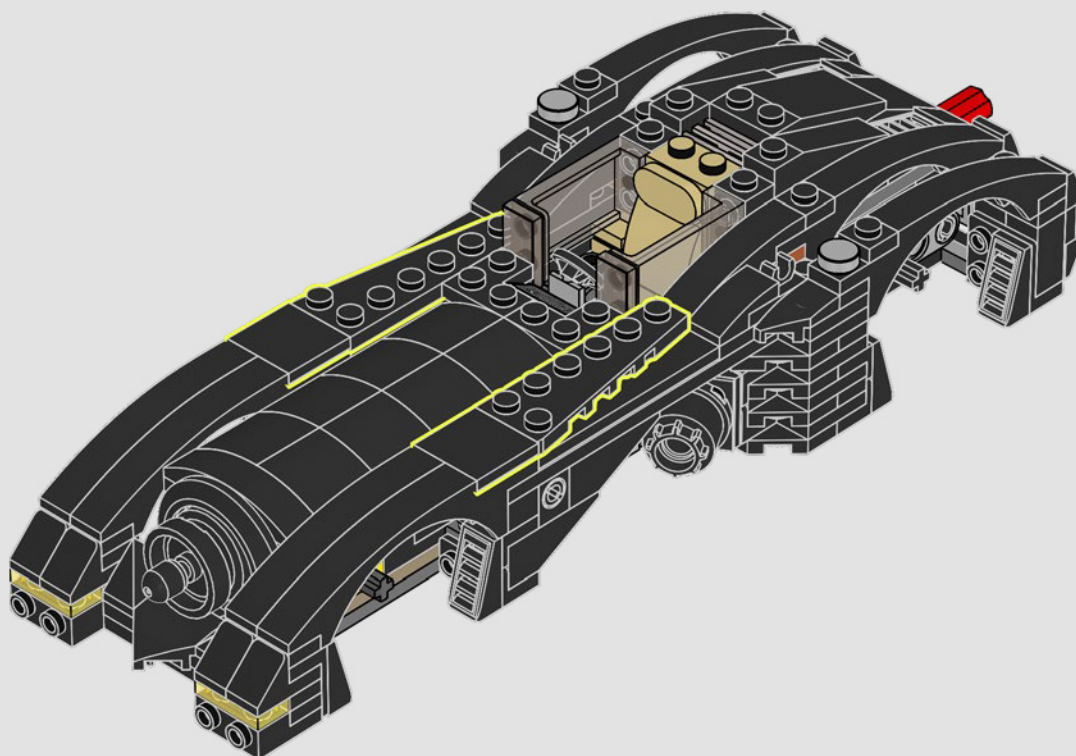

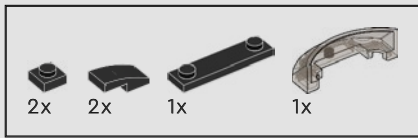

89

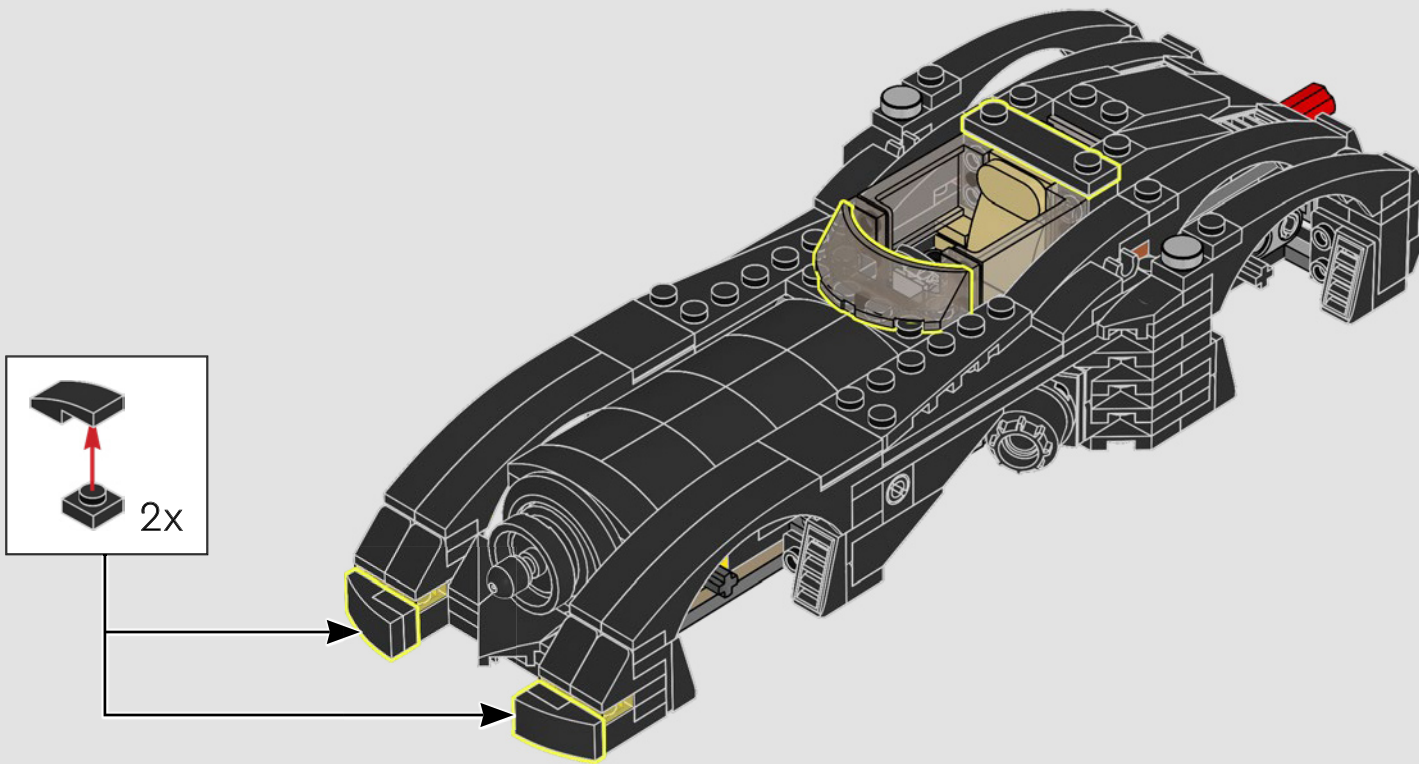

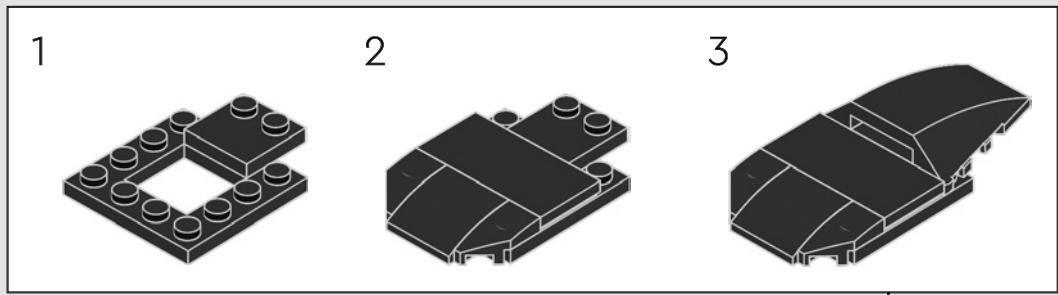
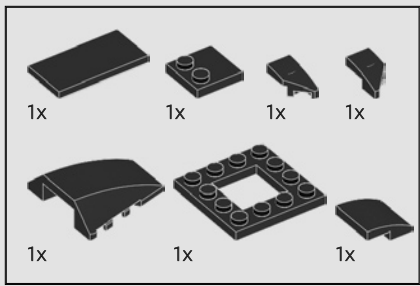

90

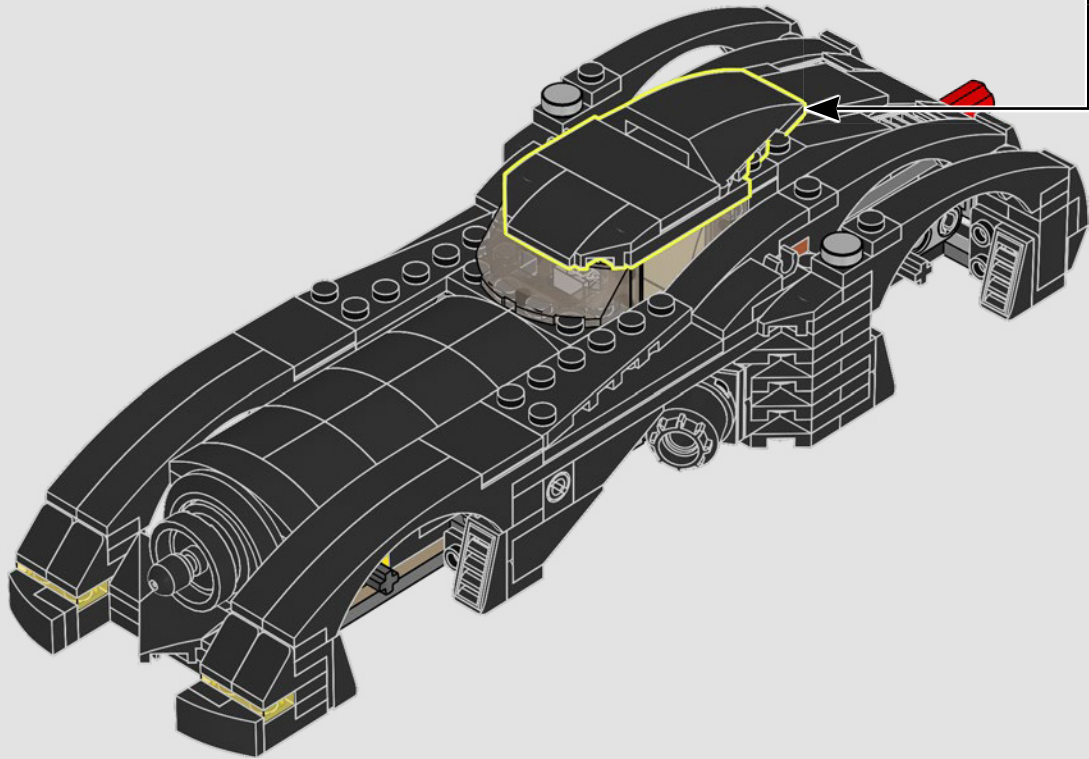

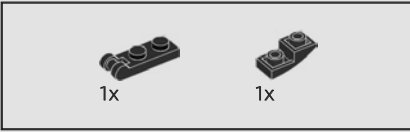
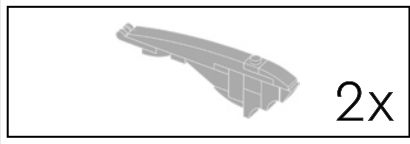

91

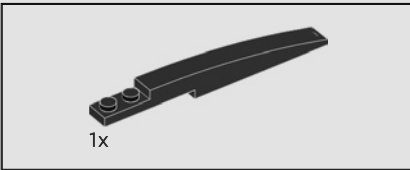
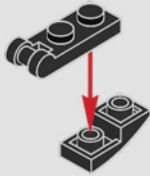

92

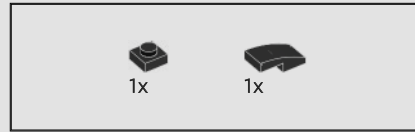
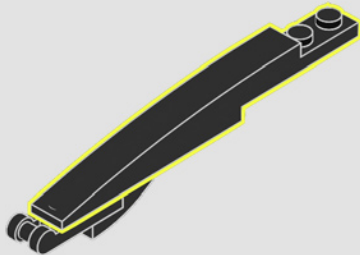

93

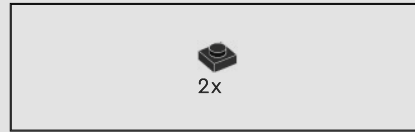
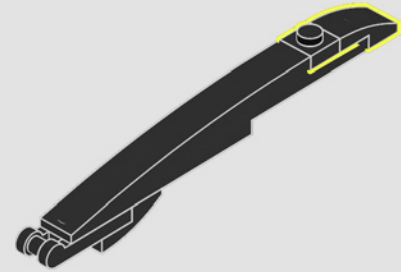

94

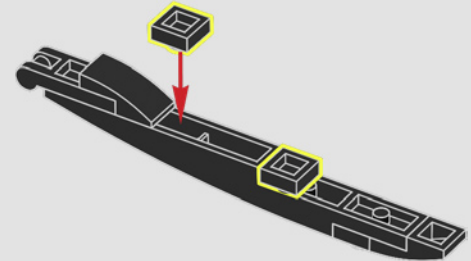
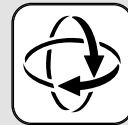

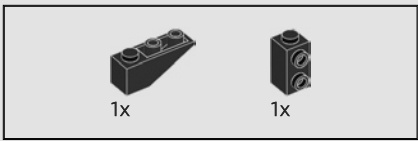

95

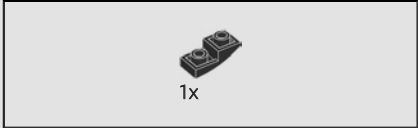
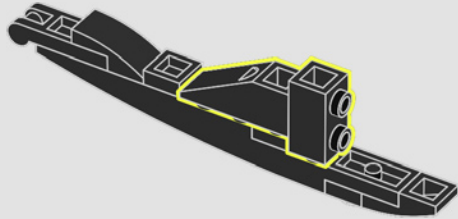

96

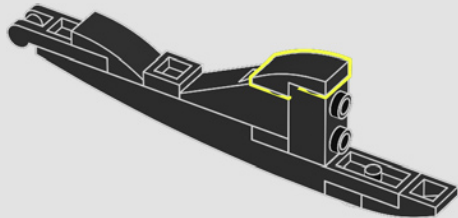

97

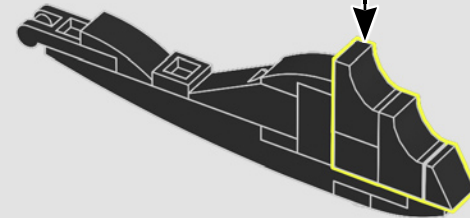
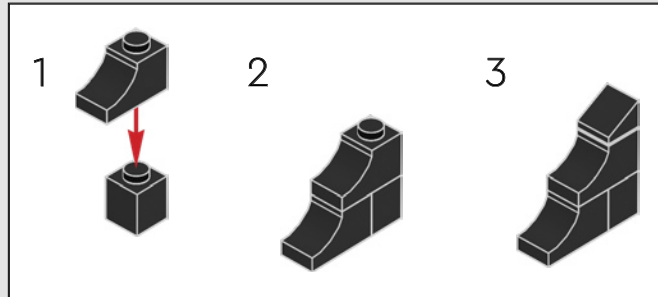

2x



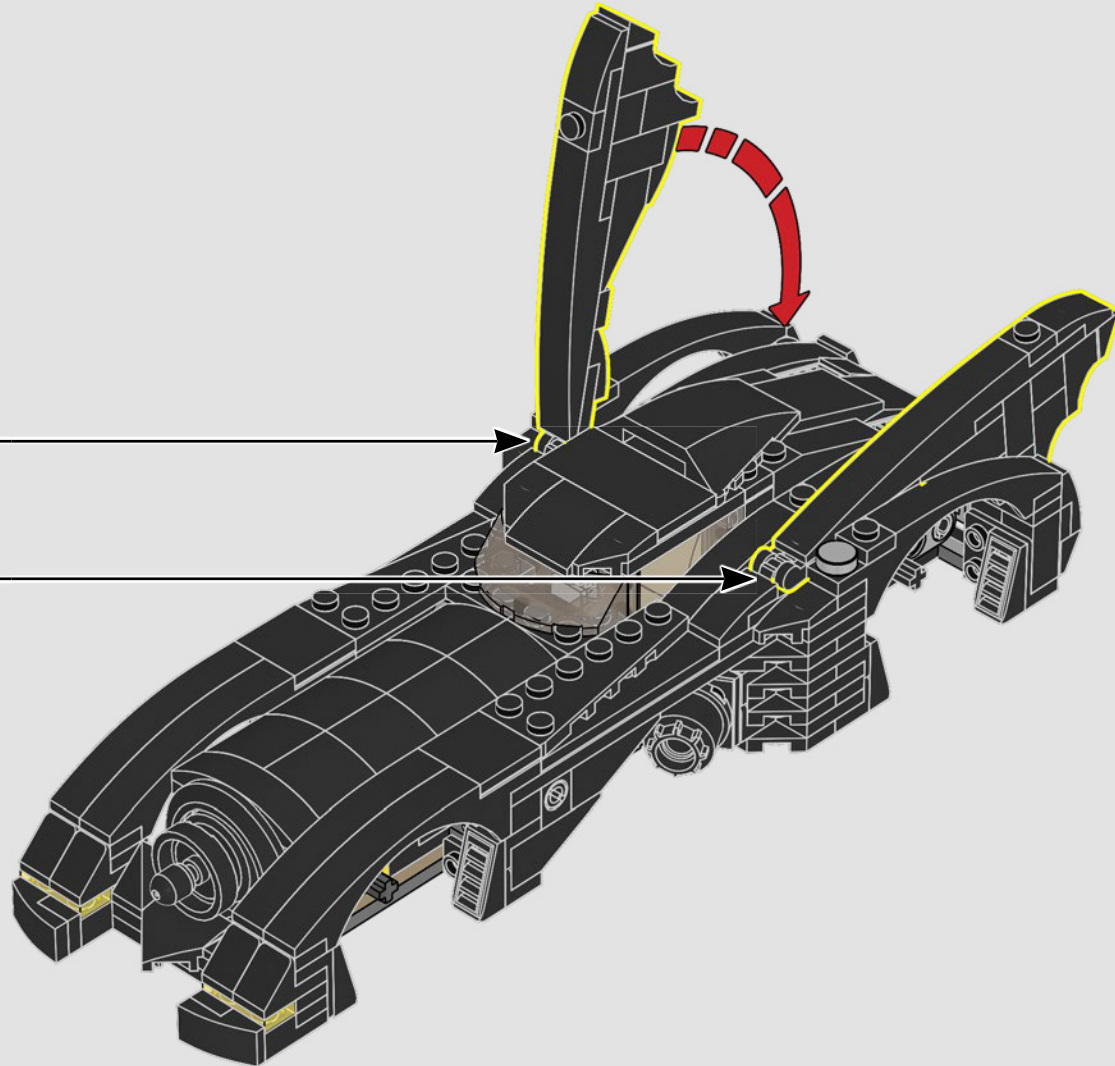

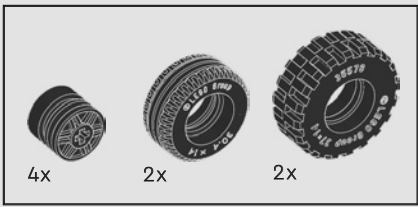

99

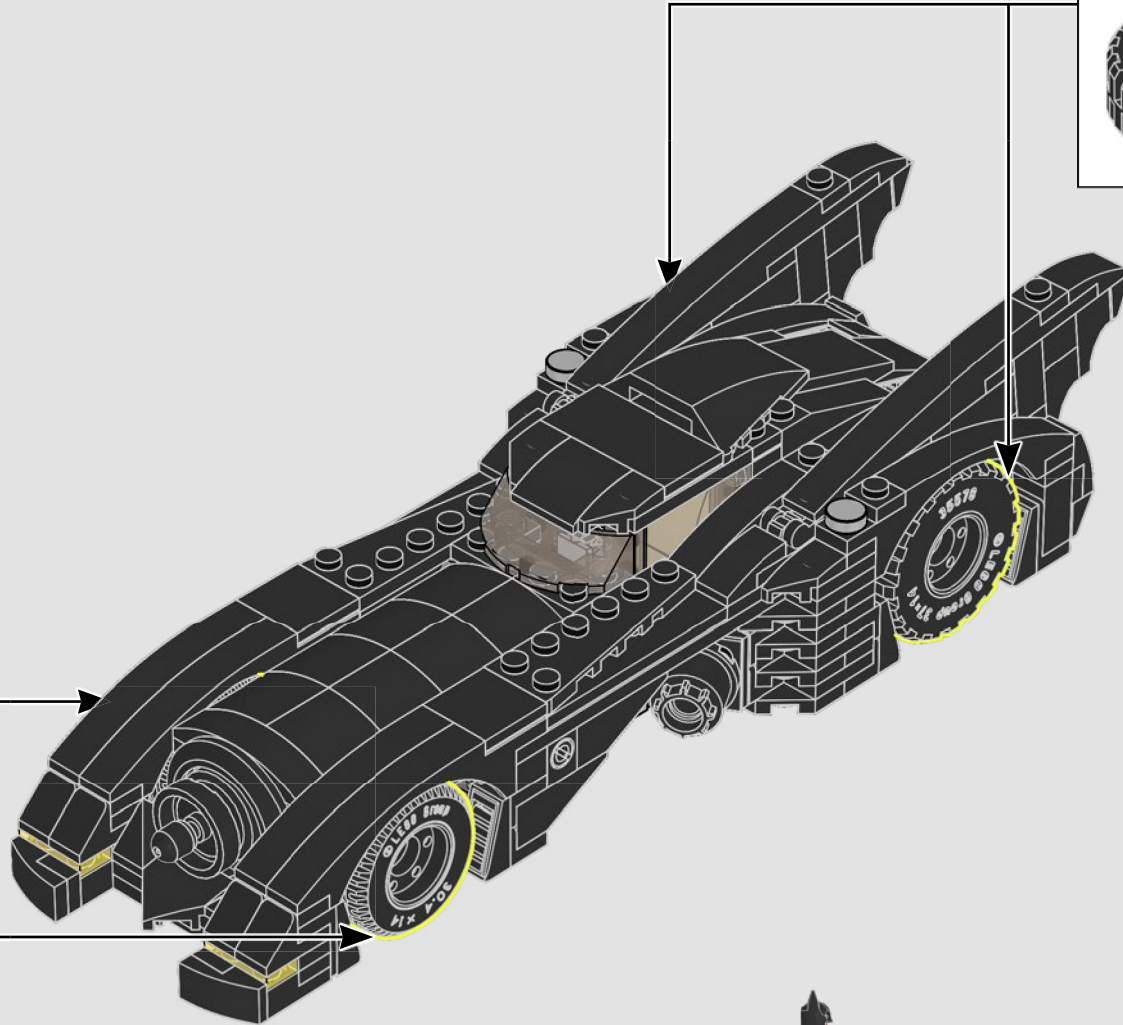
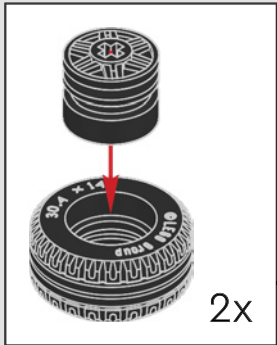
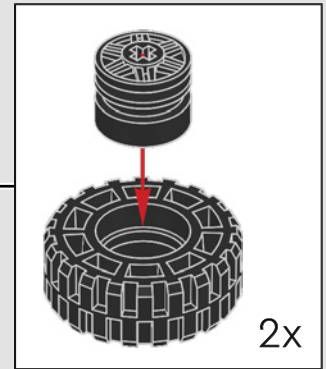



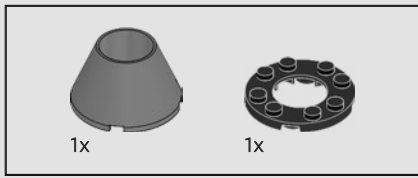

100

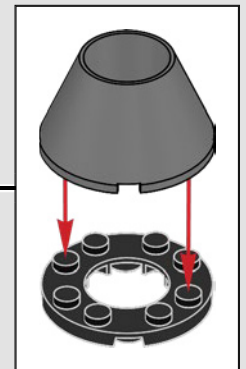
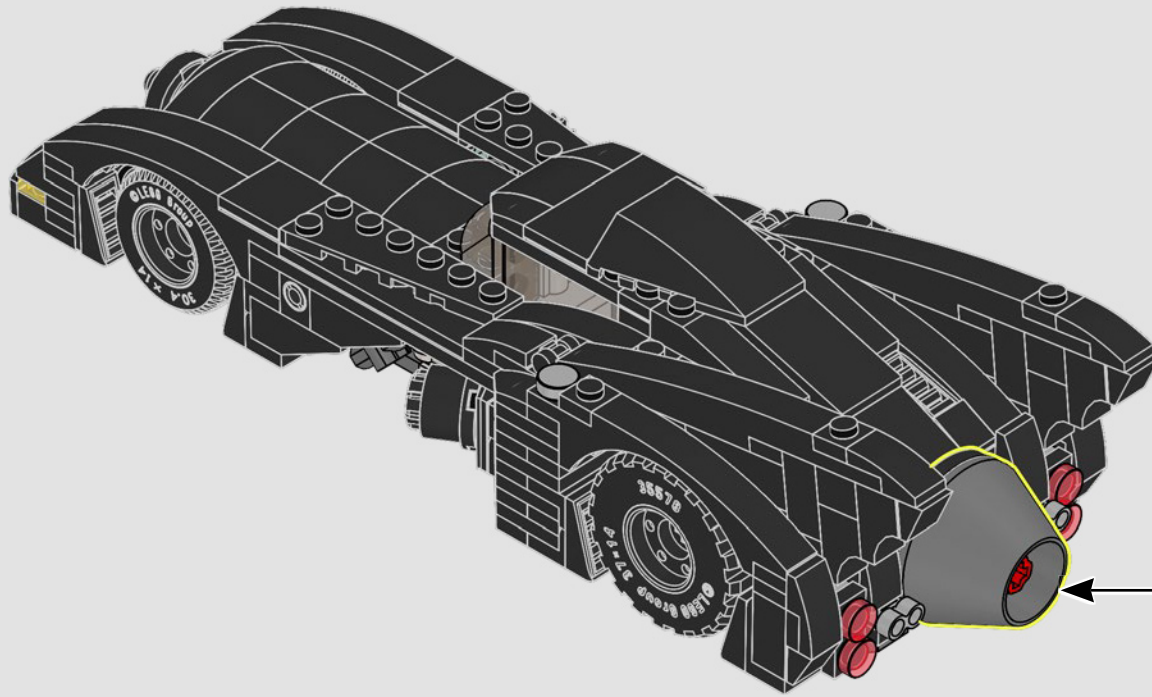



1x

101

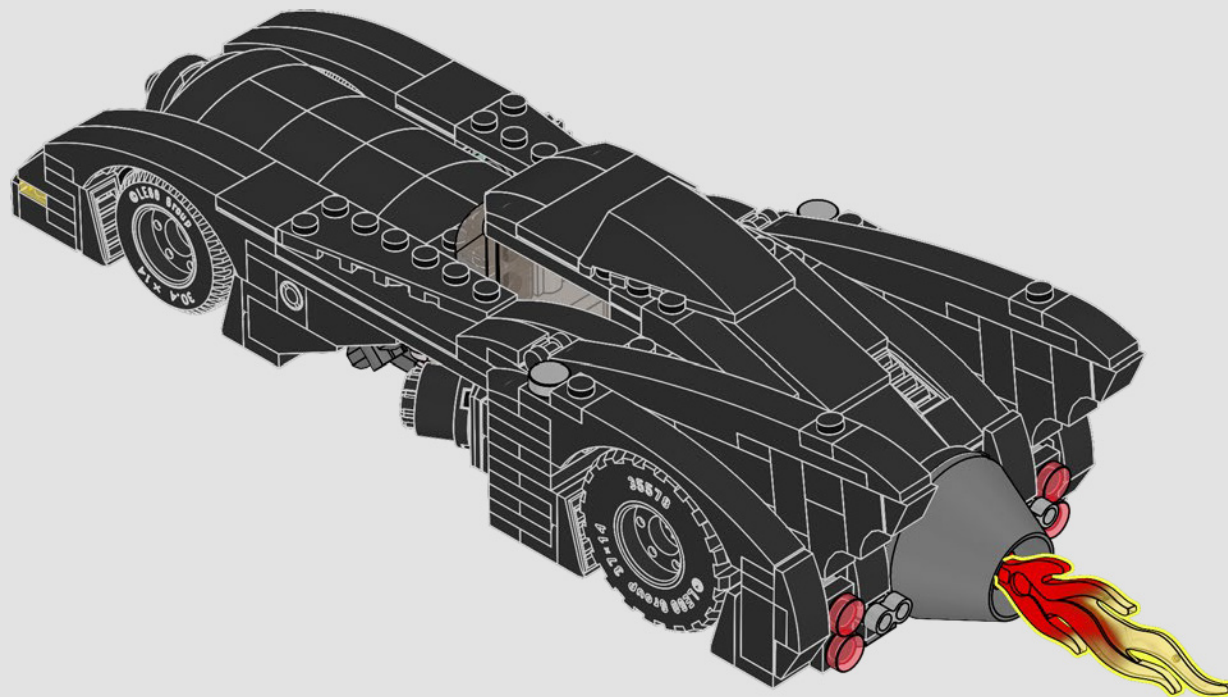

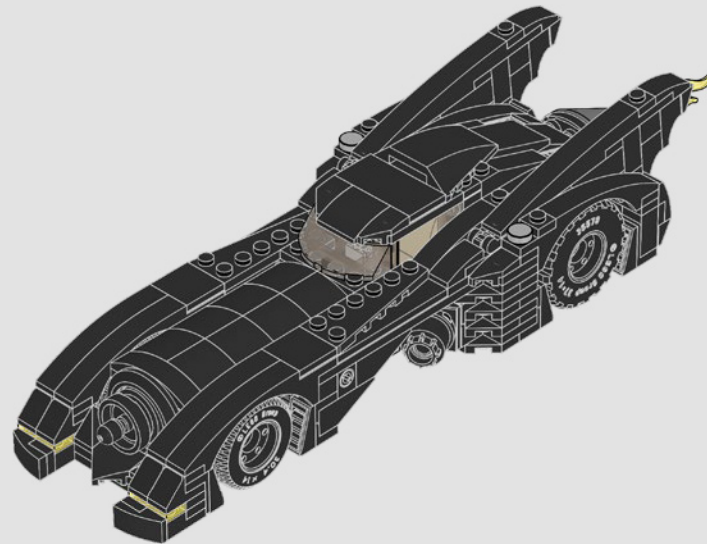

## DAS BATMOBIL

Die Bathöhle ist ohne Batmobil nicht denkbar. Dreh den Hebel auf der Beifahrerseite, um die verborgenen Kanonen herauszuschwenken und abzufeuern. Öffne das Cockpit, um die Batman™ Minifigur mit dem weichen Umhang hineinzusetzen. Befestige dann das Flammenelement, das sich dreht, wenn das Auto fährt.

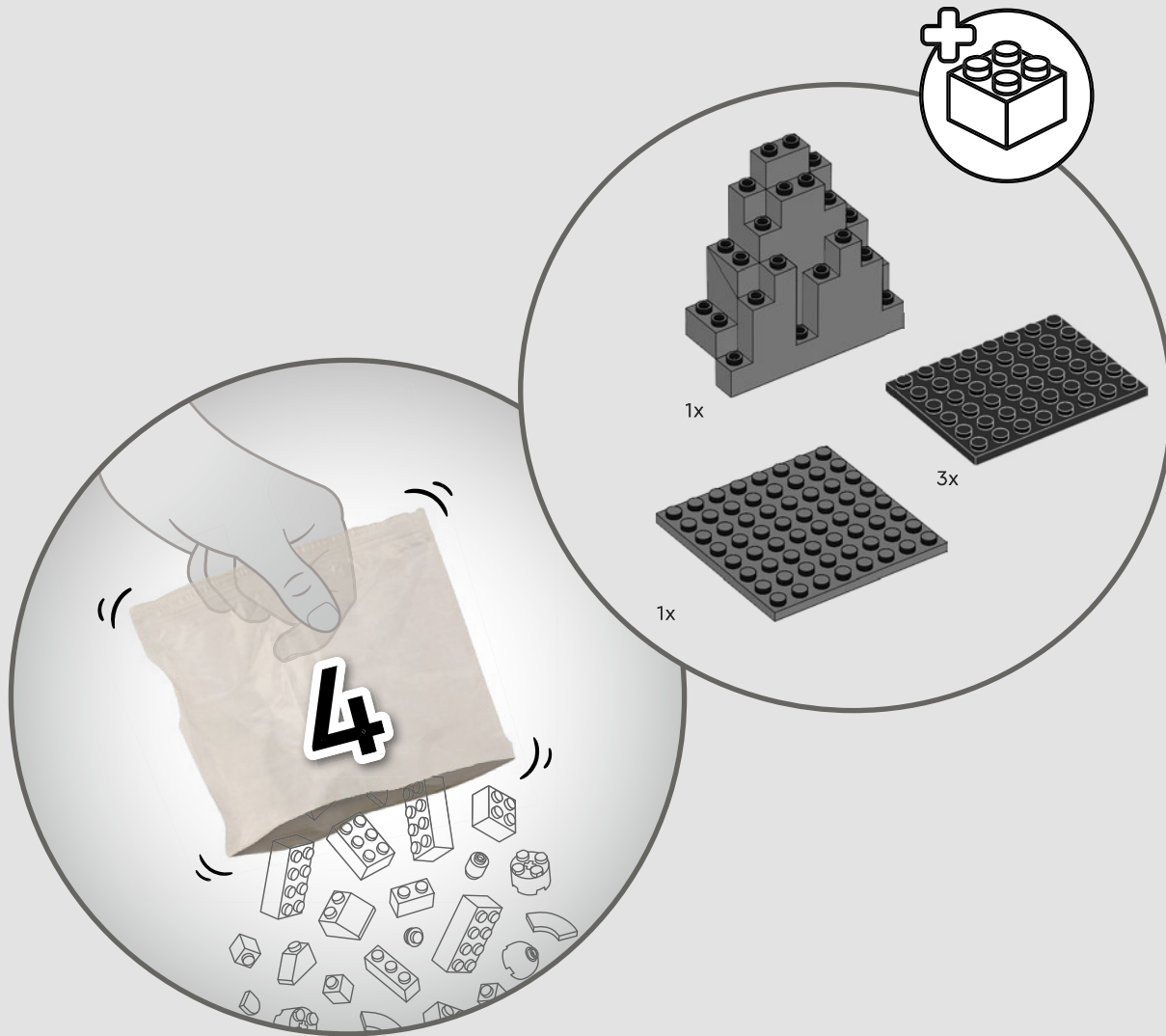

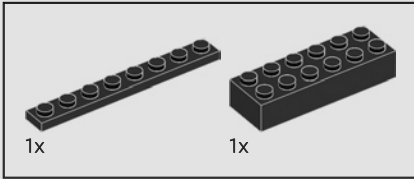
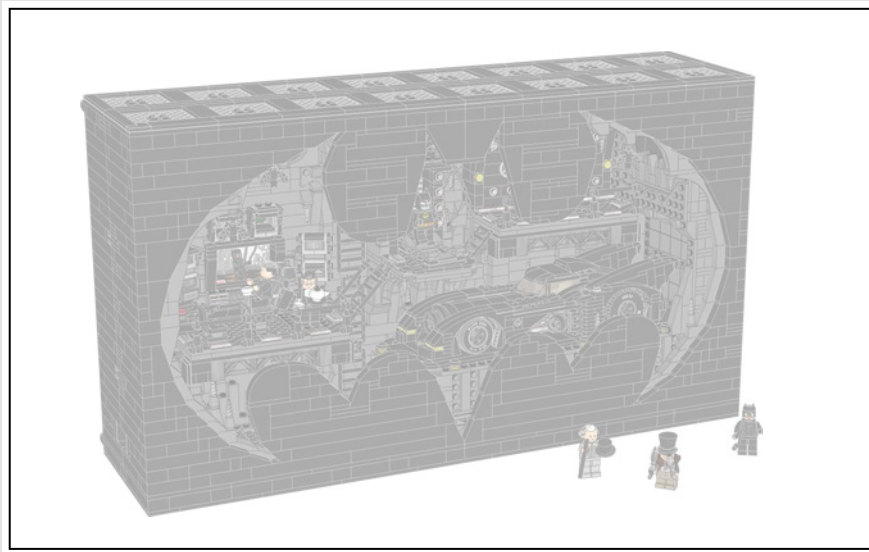

102

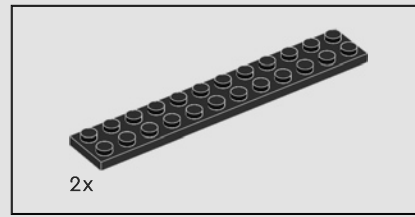
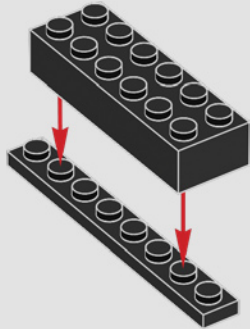

103

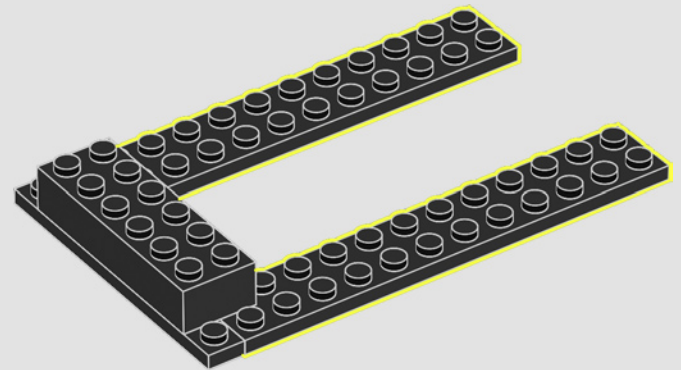

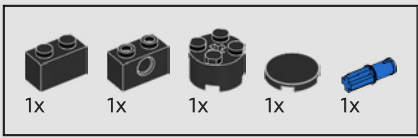

104

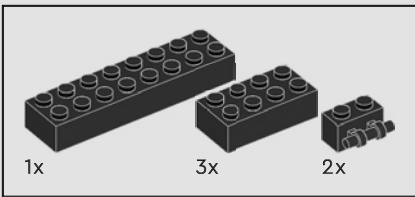
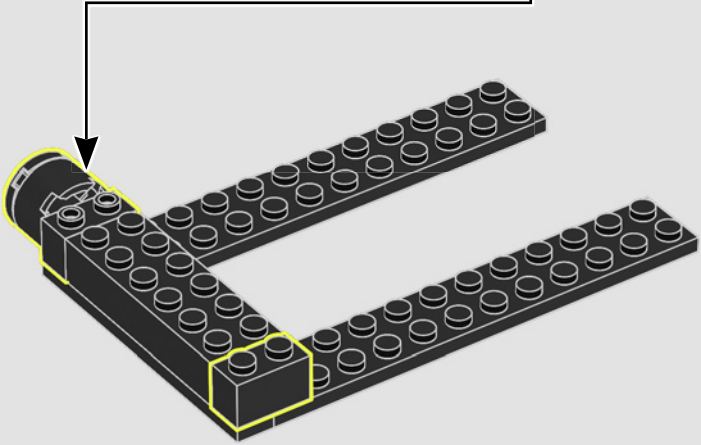
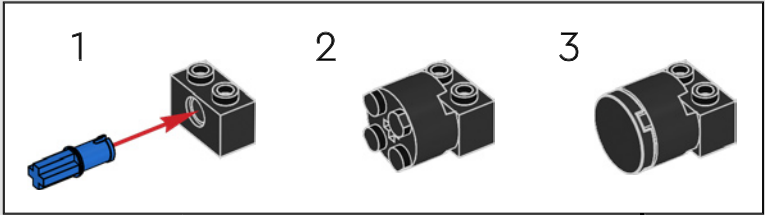

105

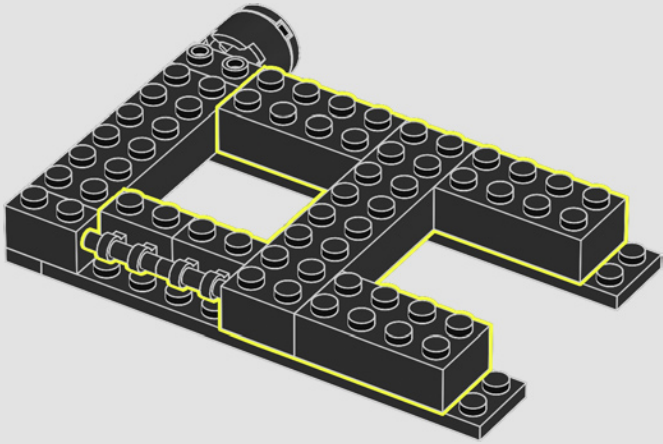

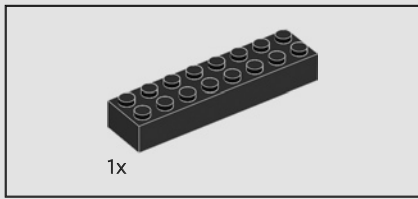

106

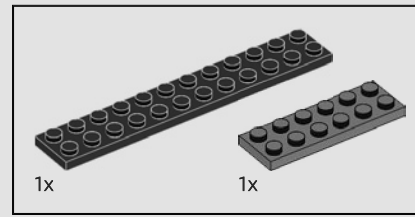
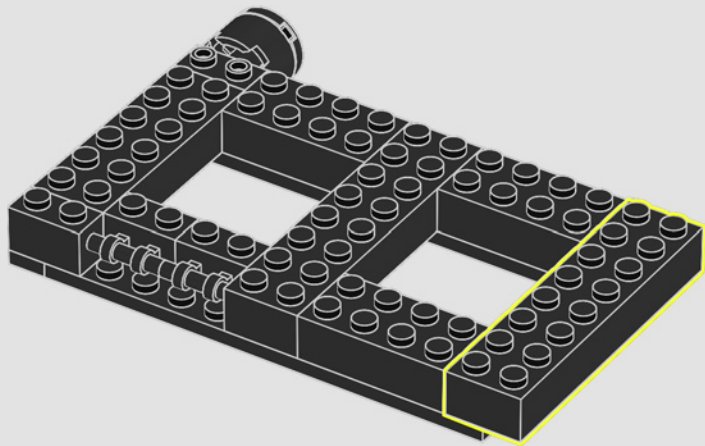

107

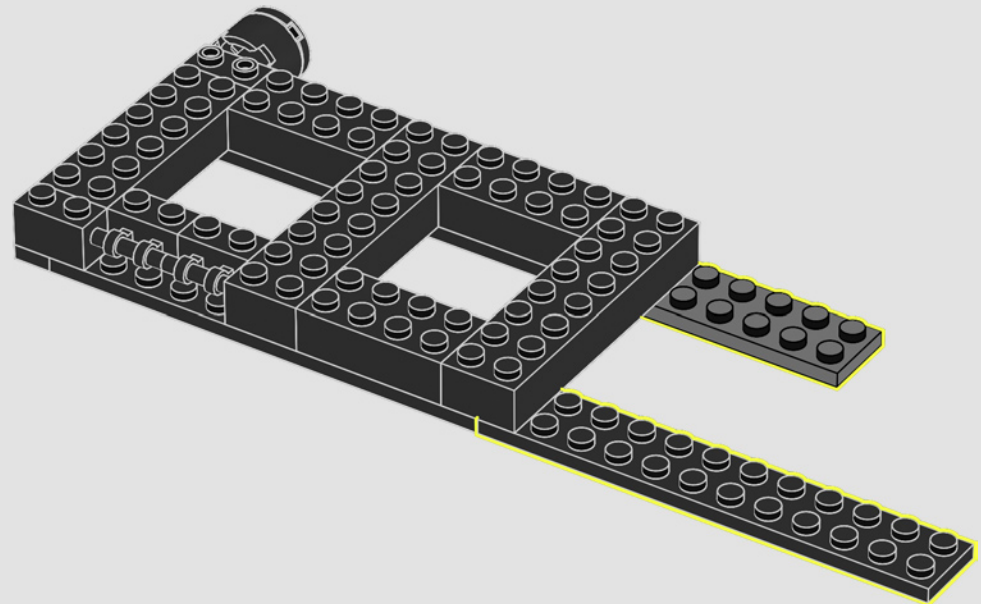

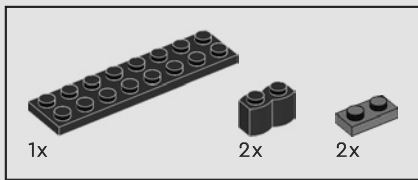

108

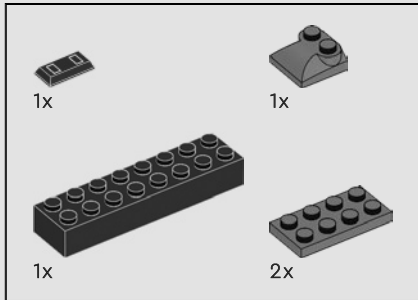
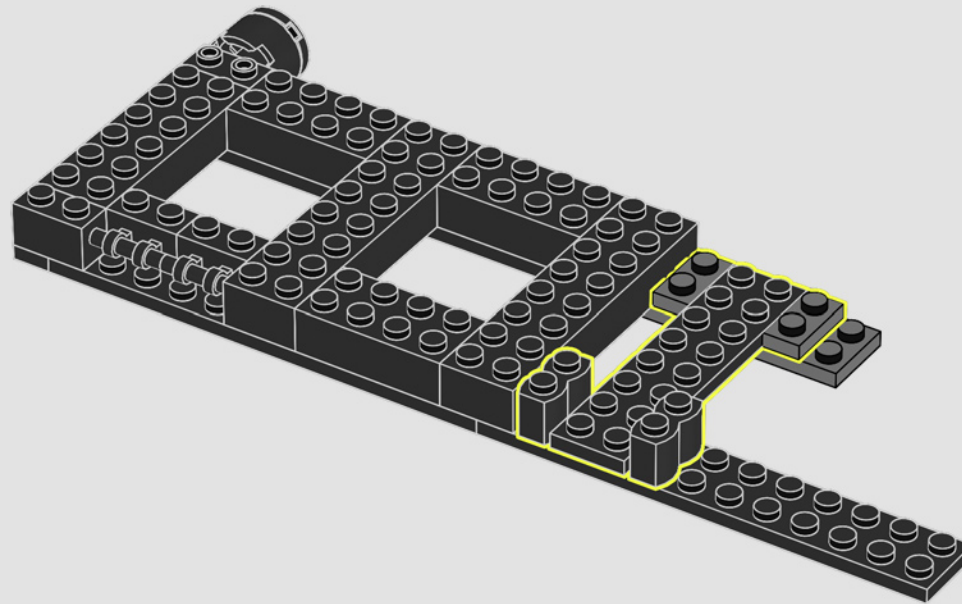

109

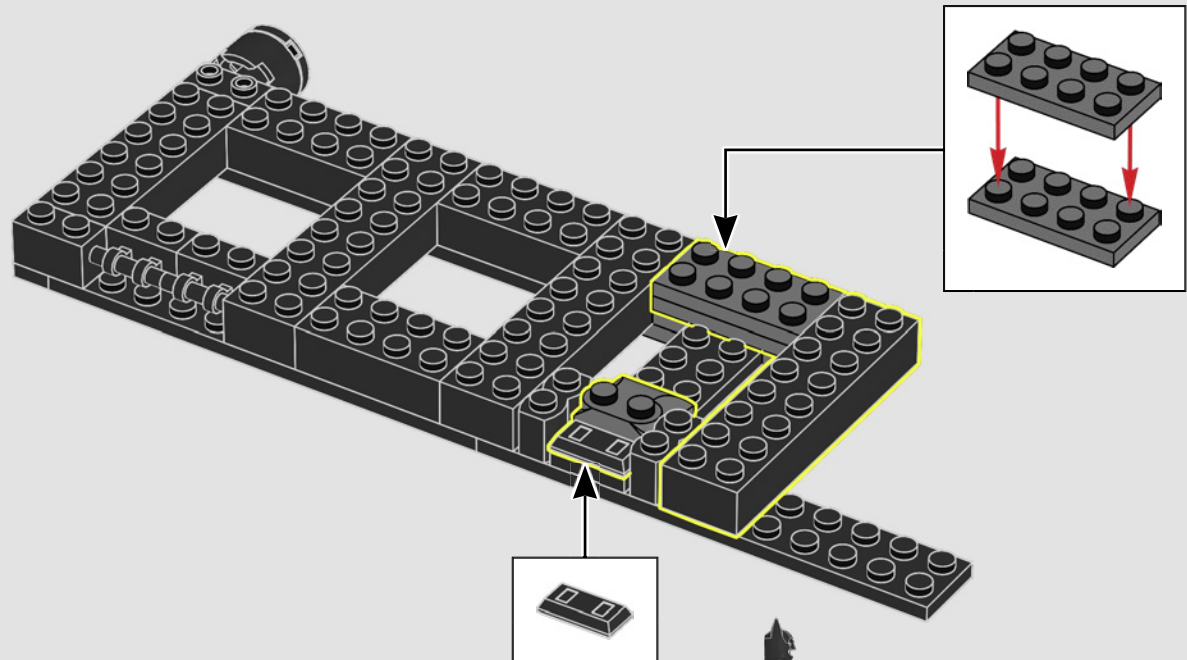



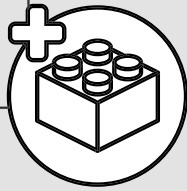
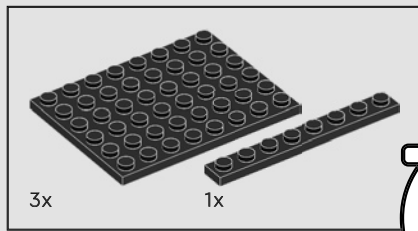

110

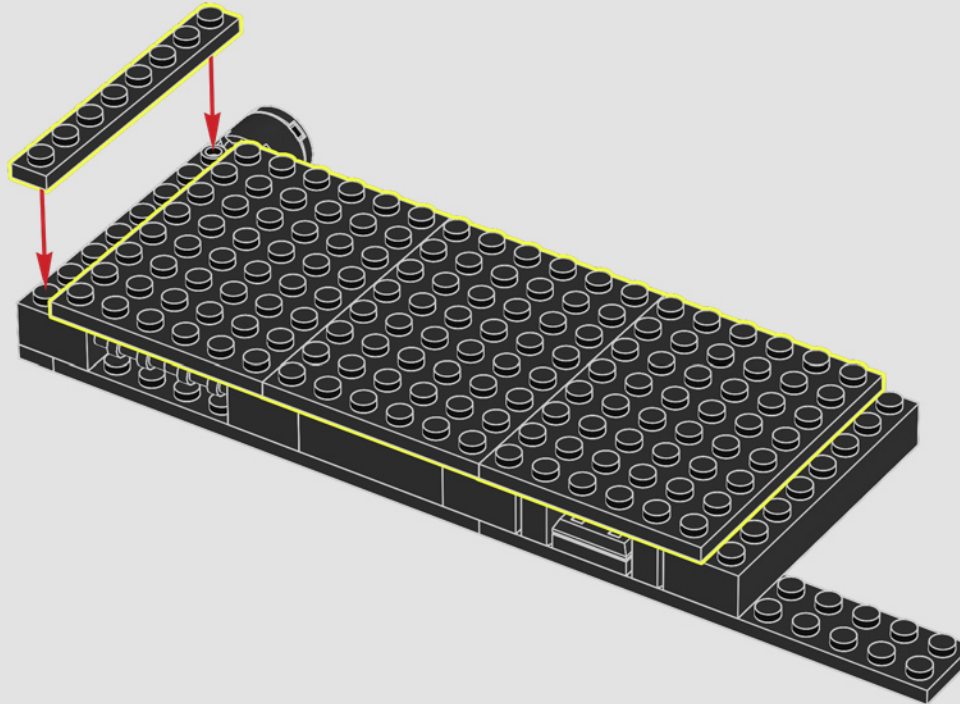

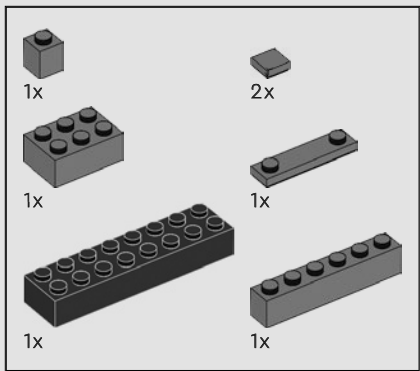

111

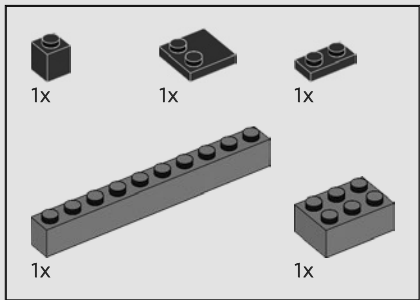
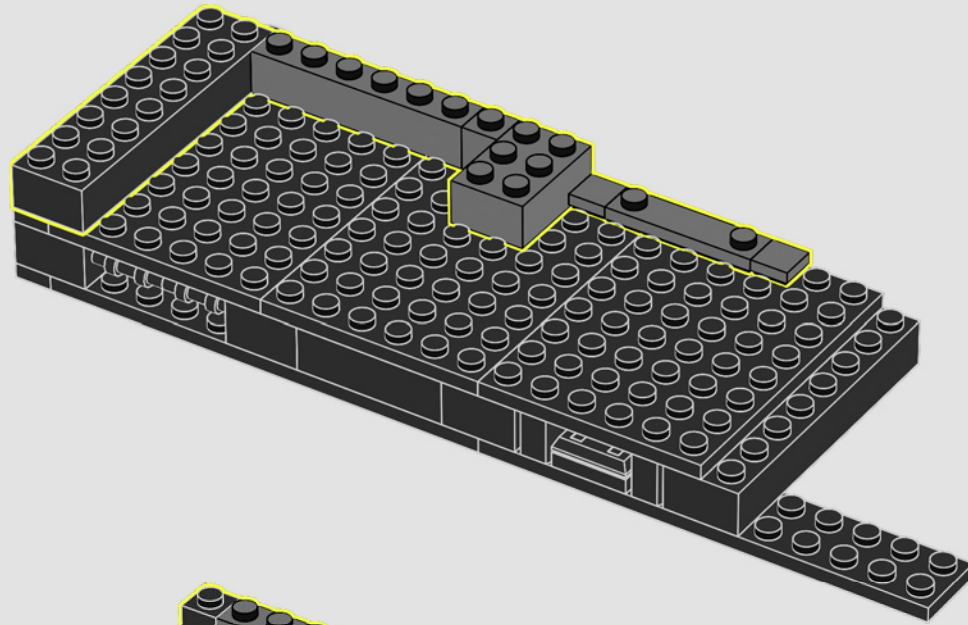

112

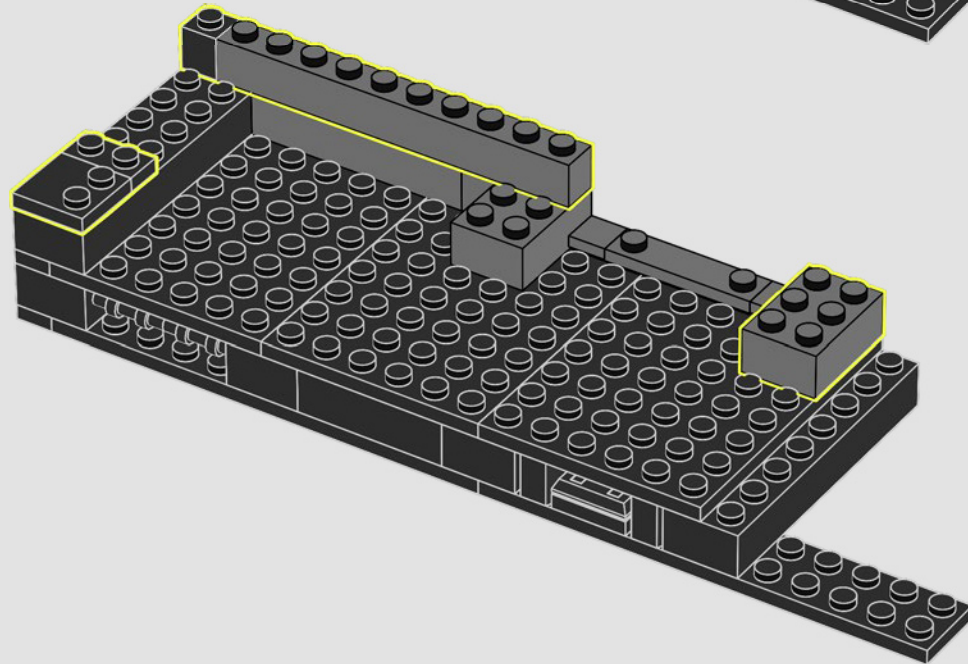

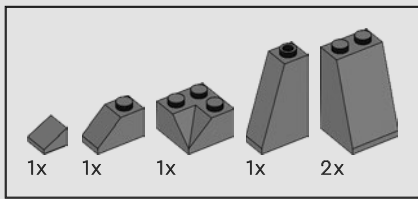

113

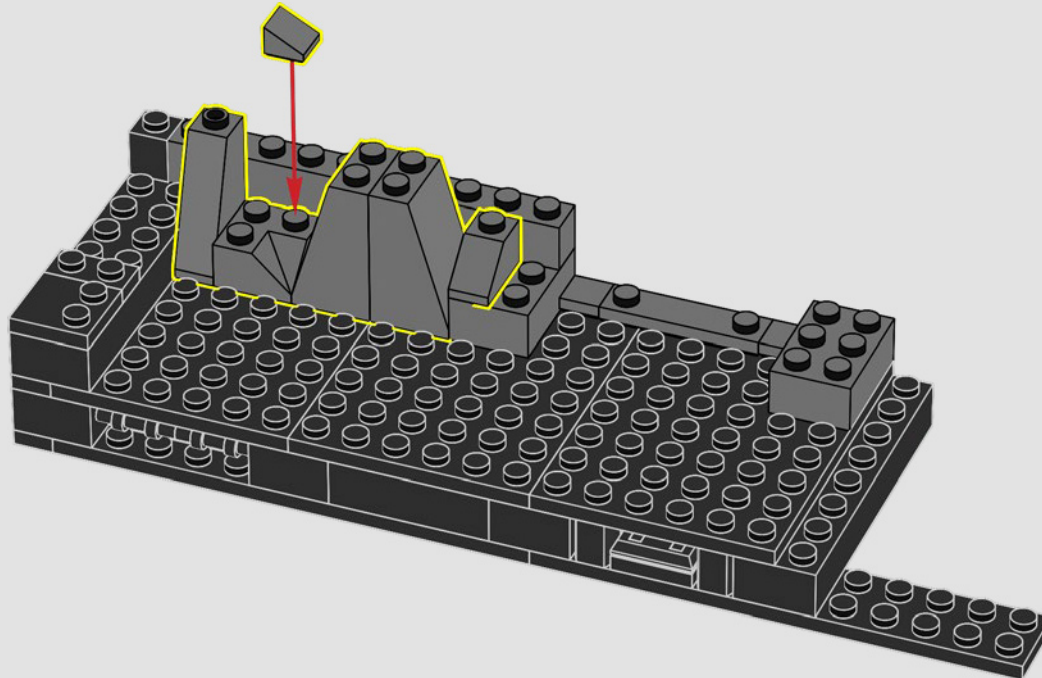

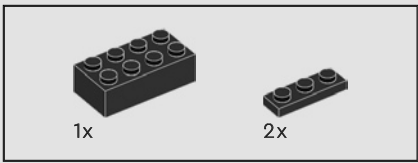

114

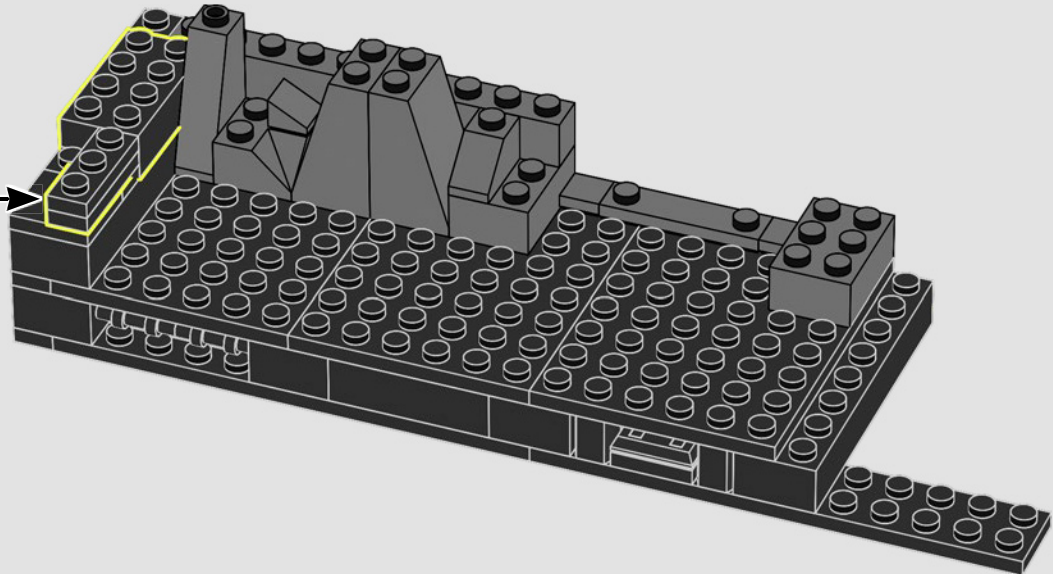
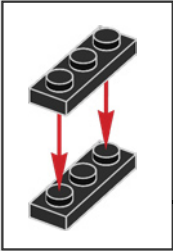

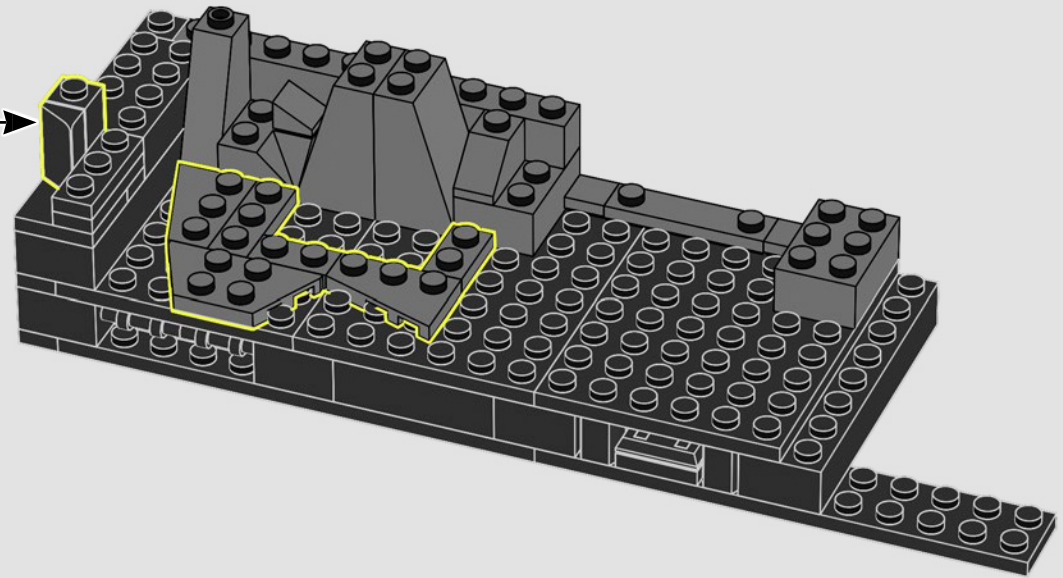
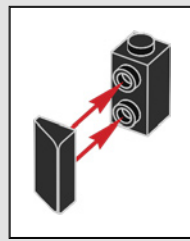
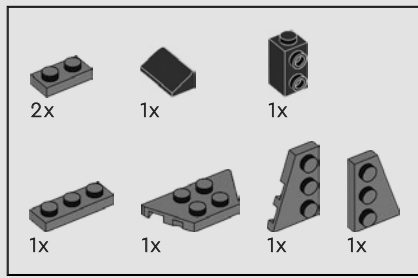

115

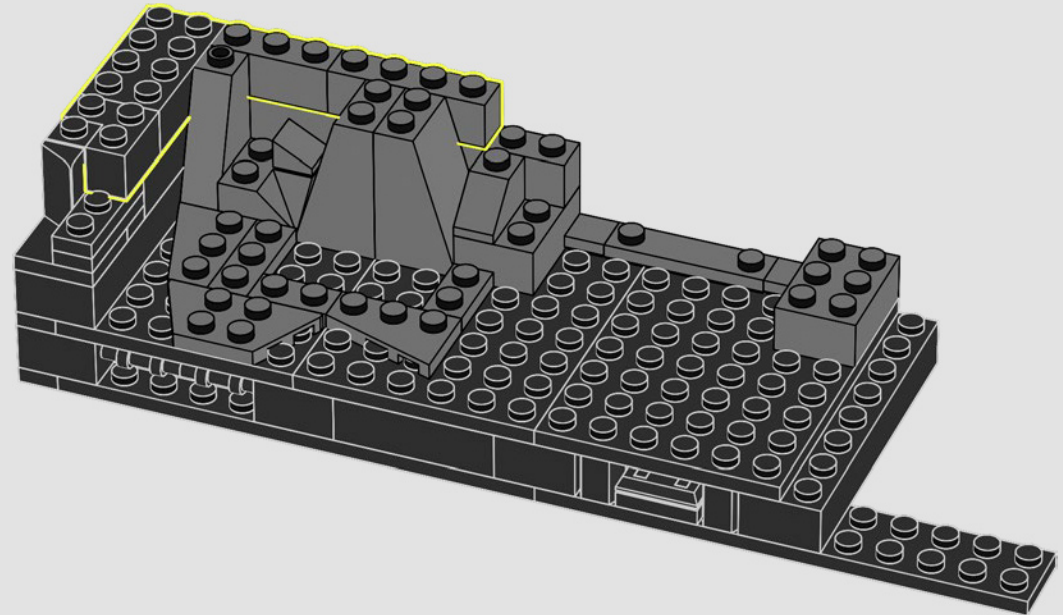
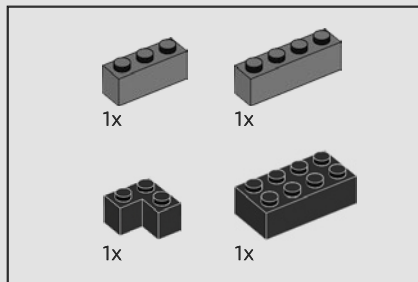

116

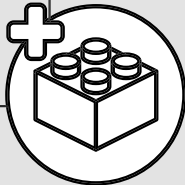
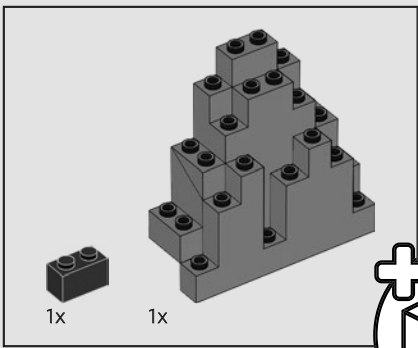

117

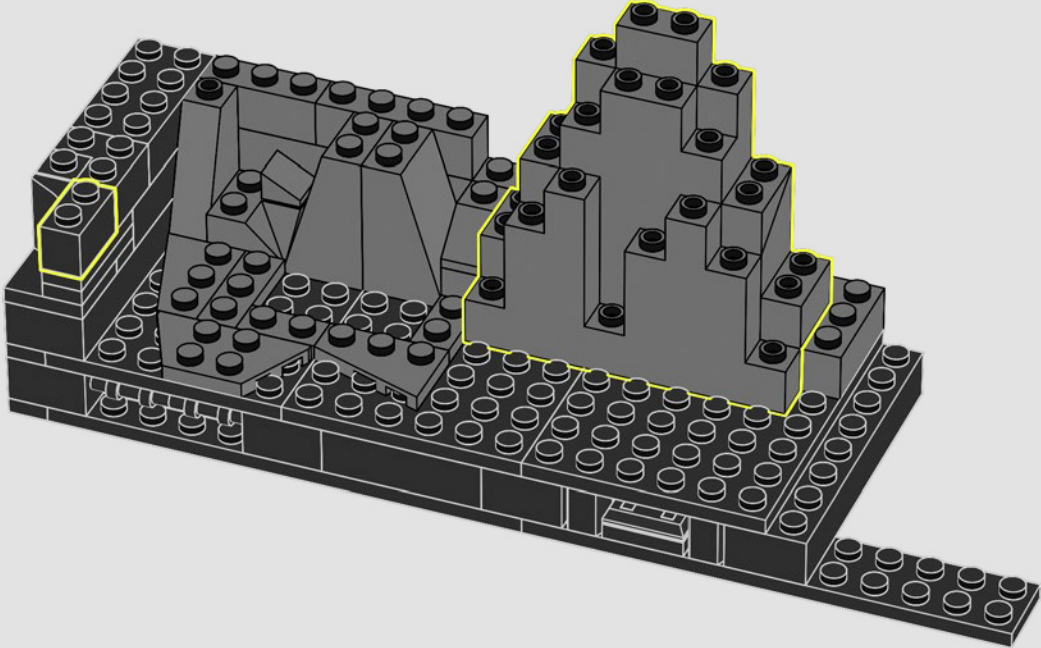

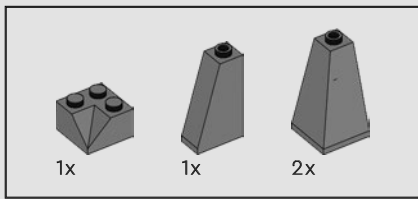

118

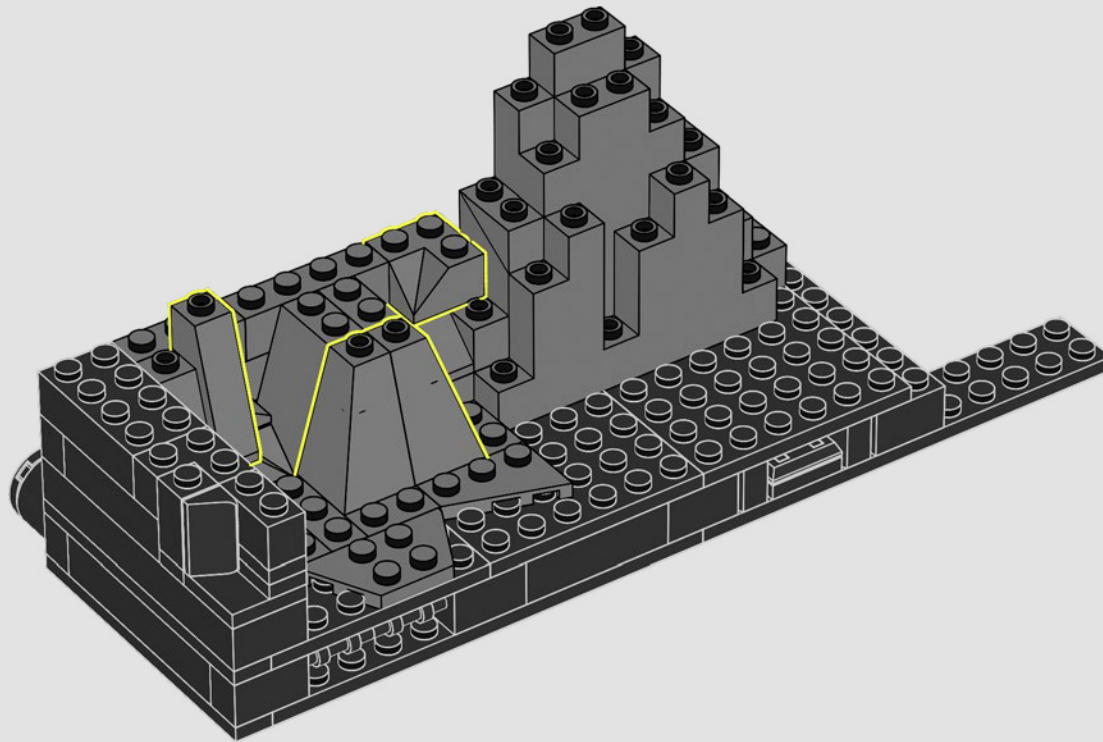

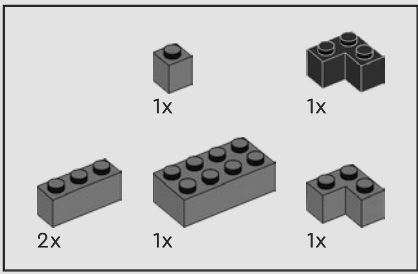

119

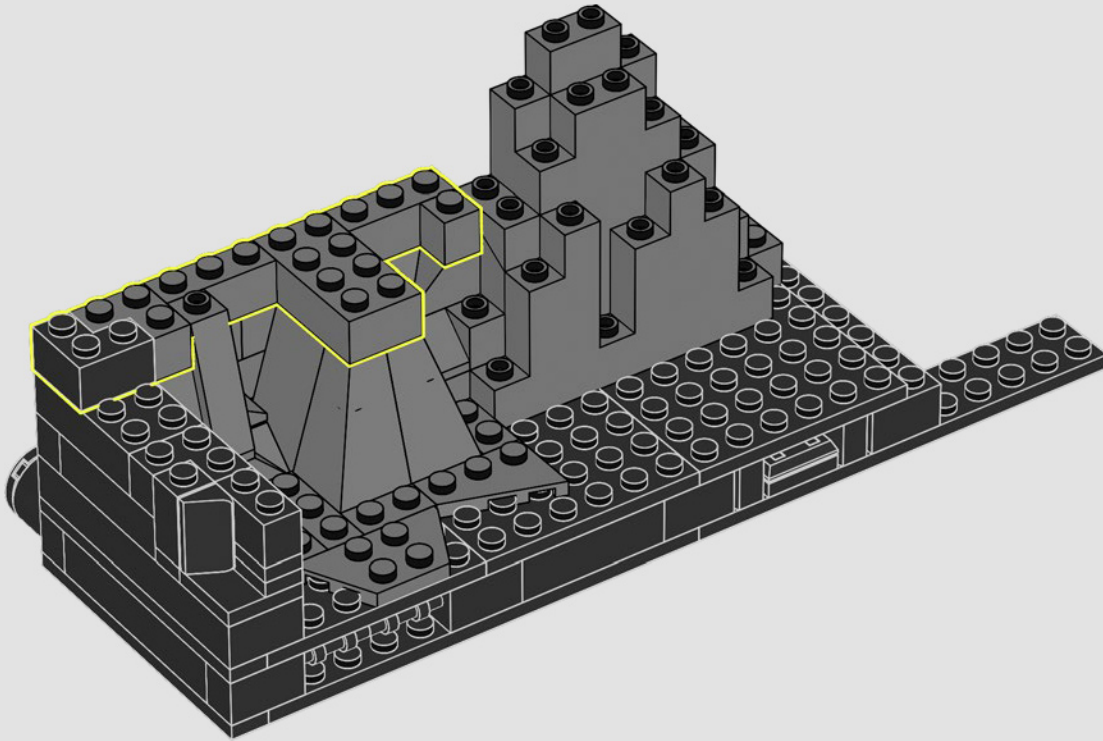



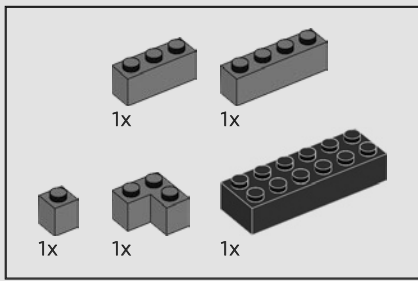

120

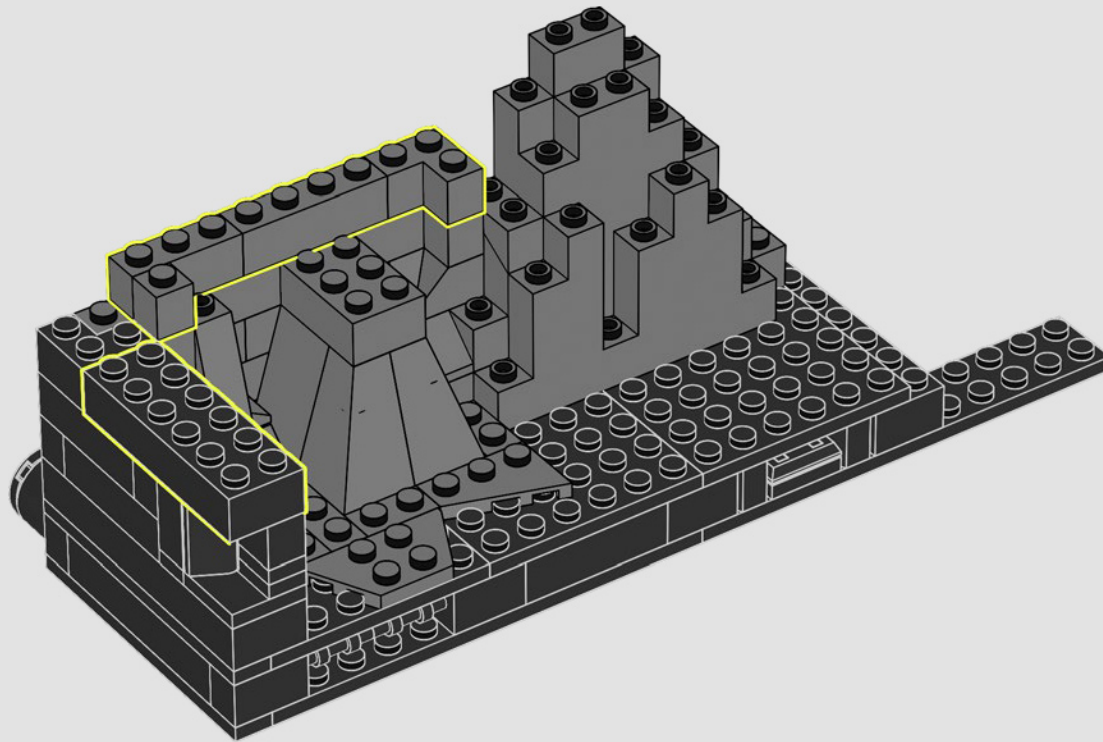

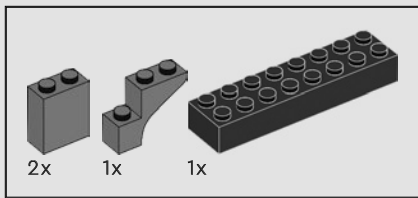

121

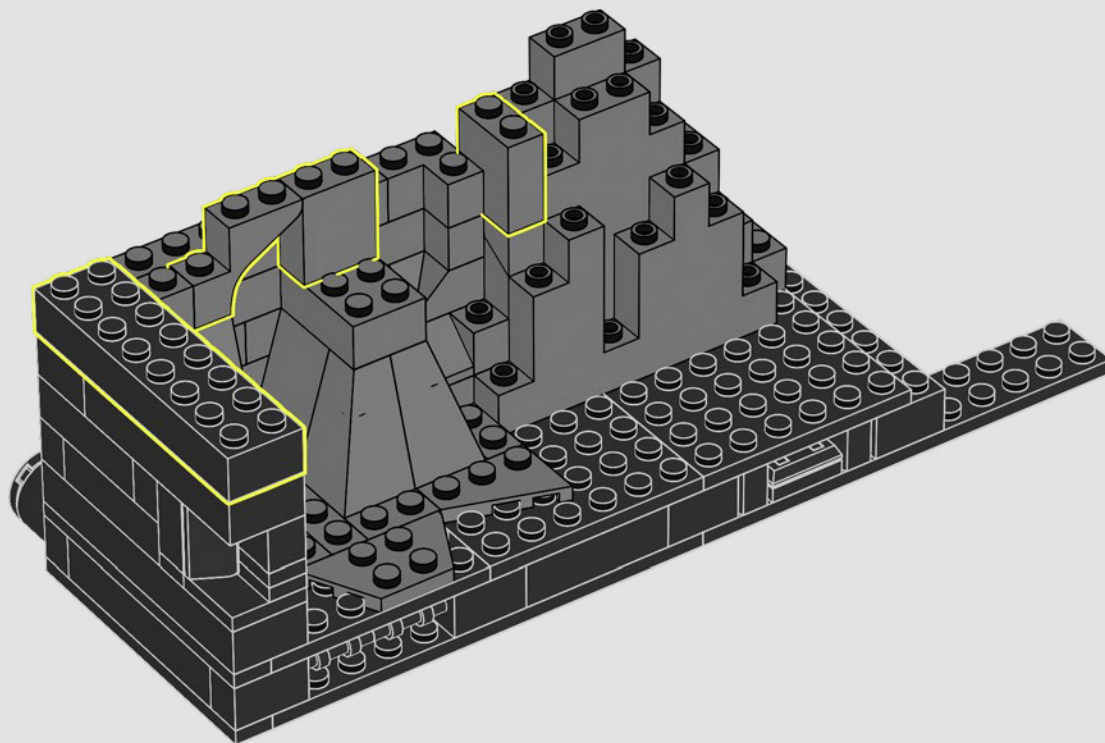

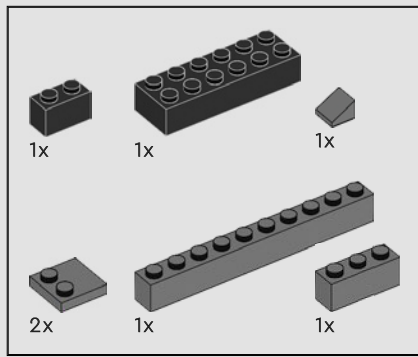

122

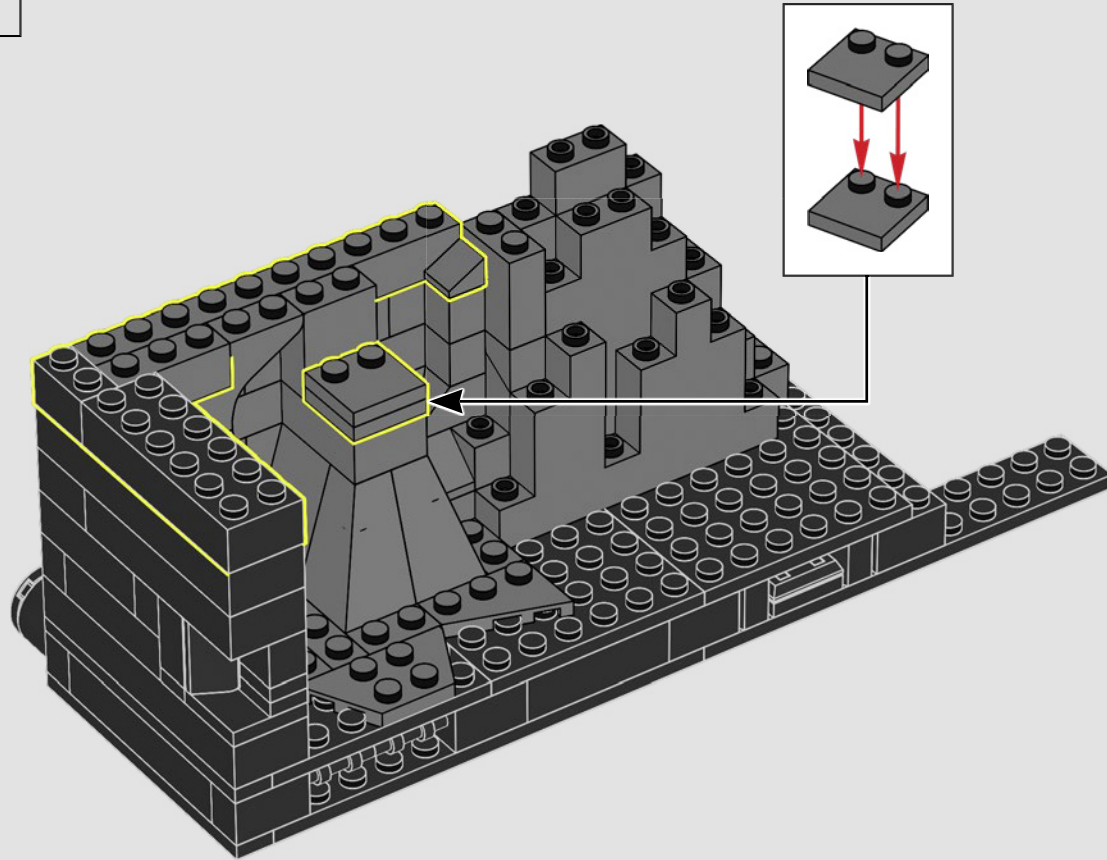

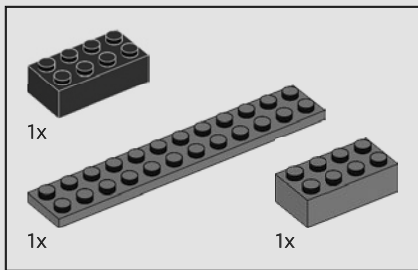

123

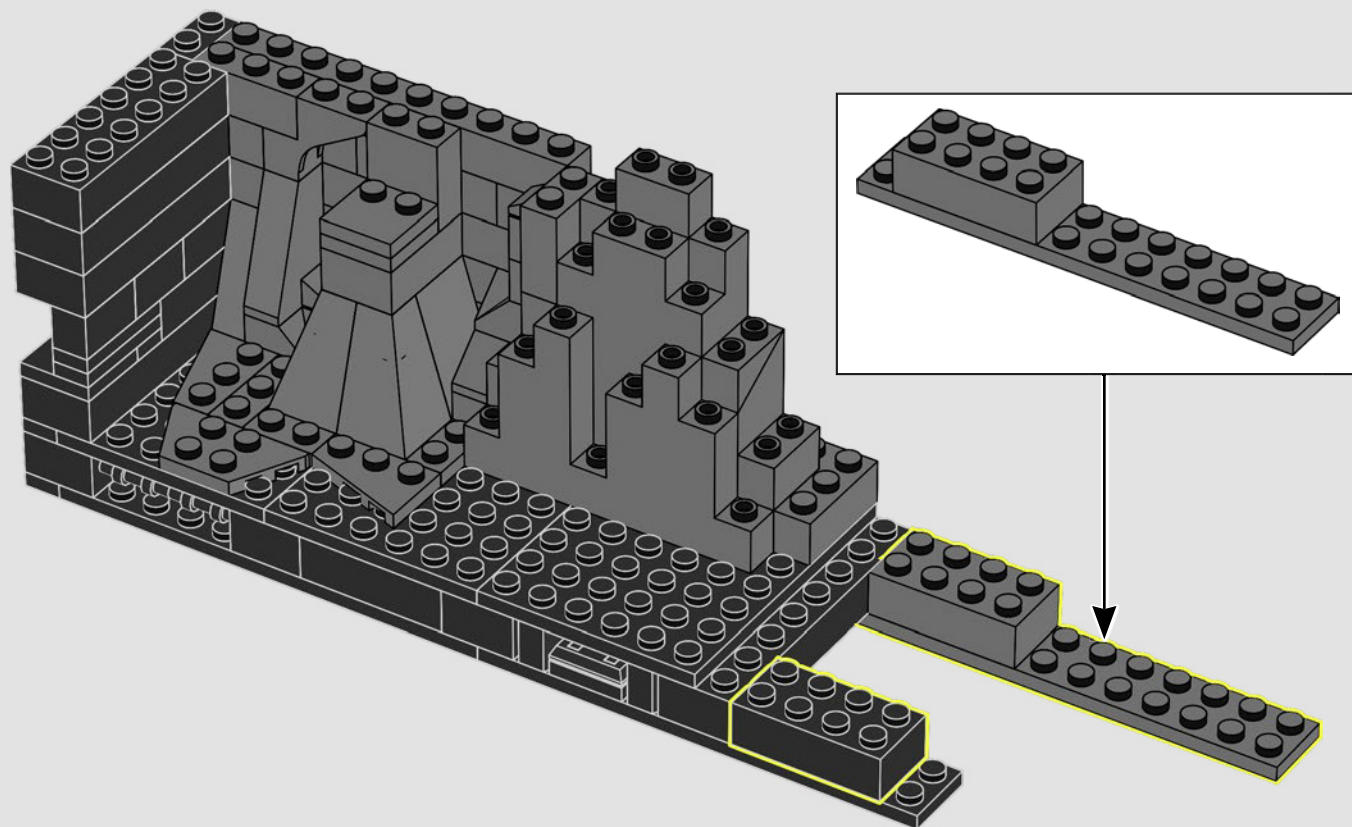

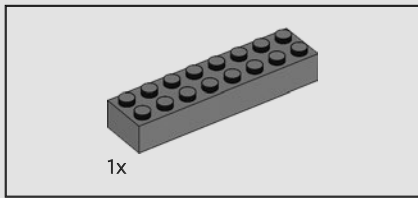

124

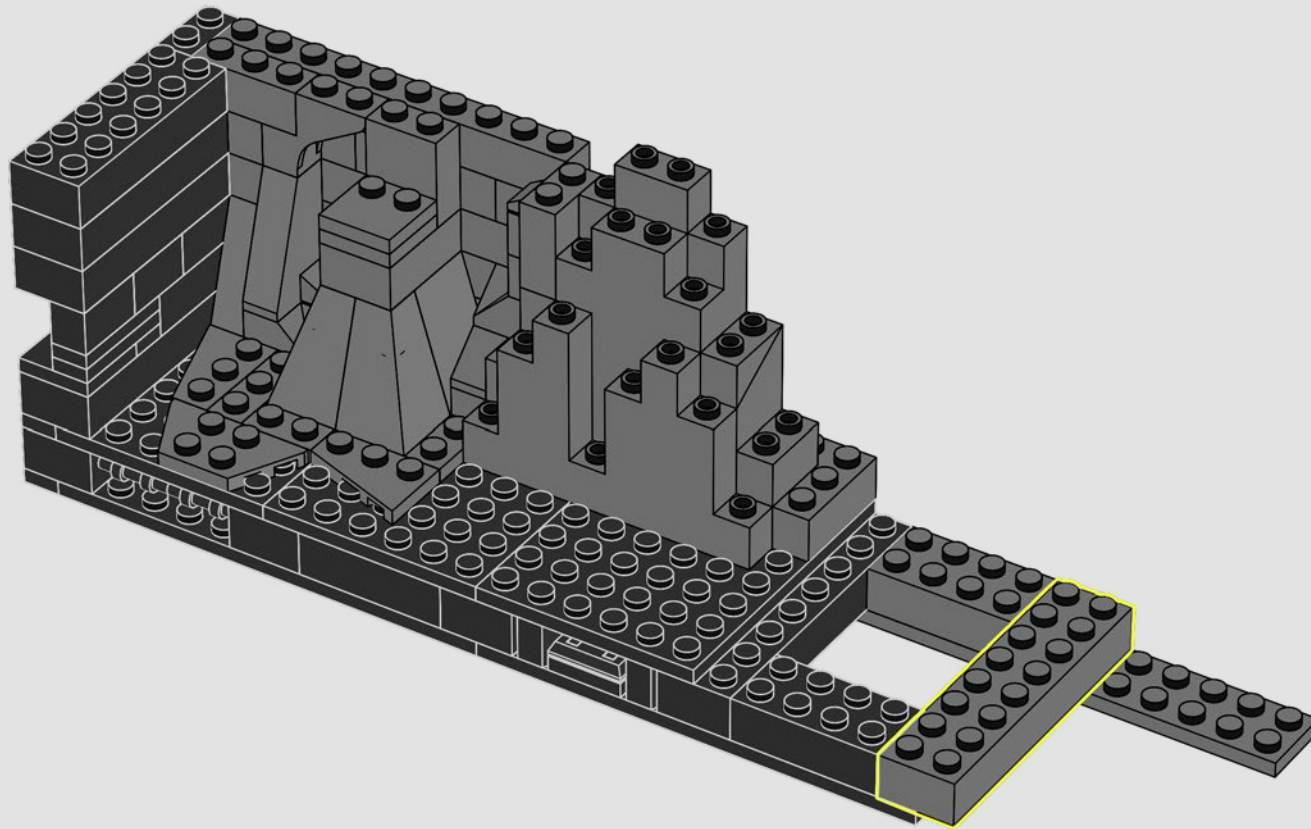

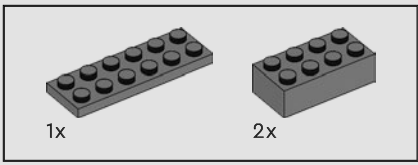

125

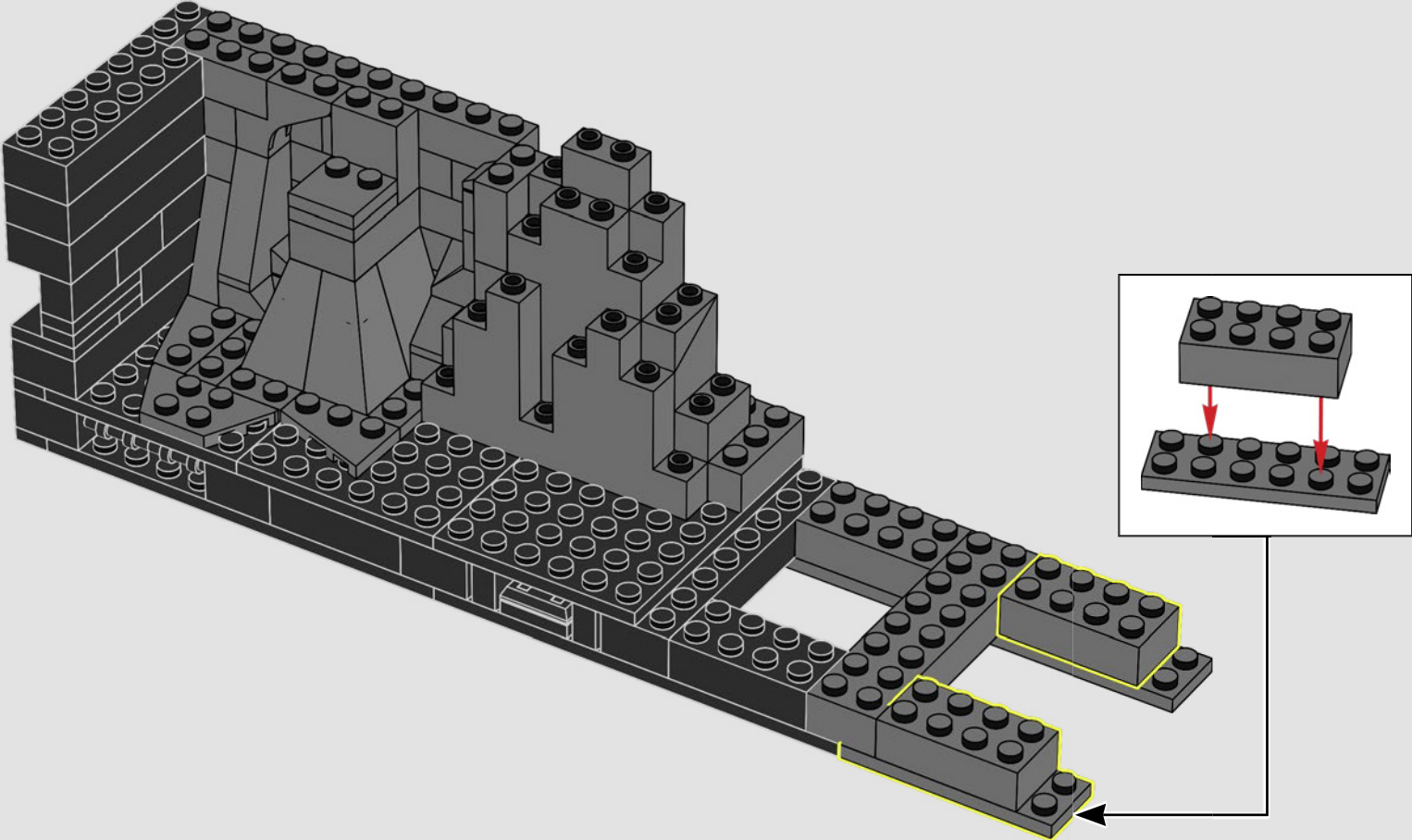

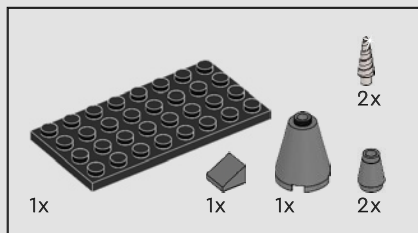

126

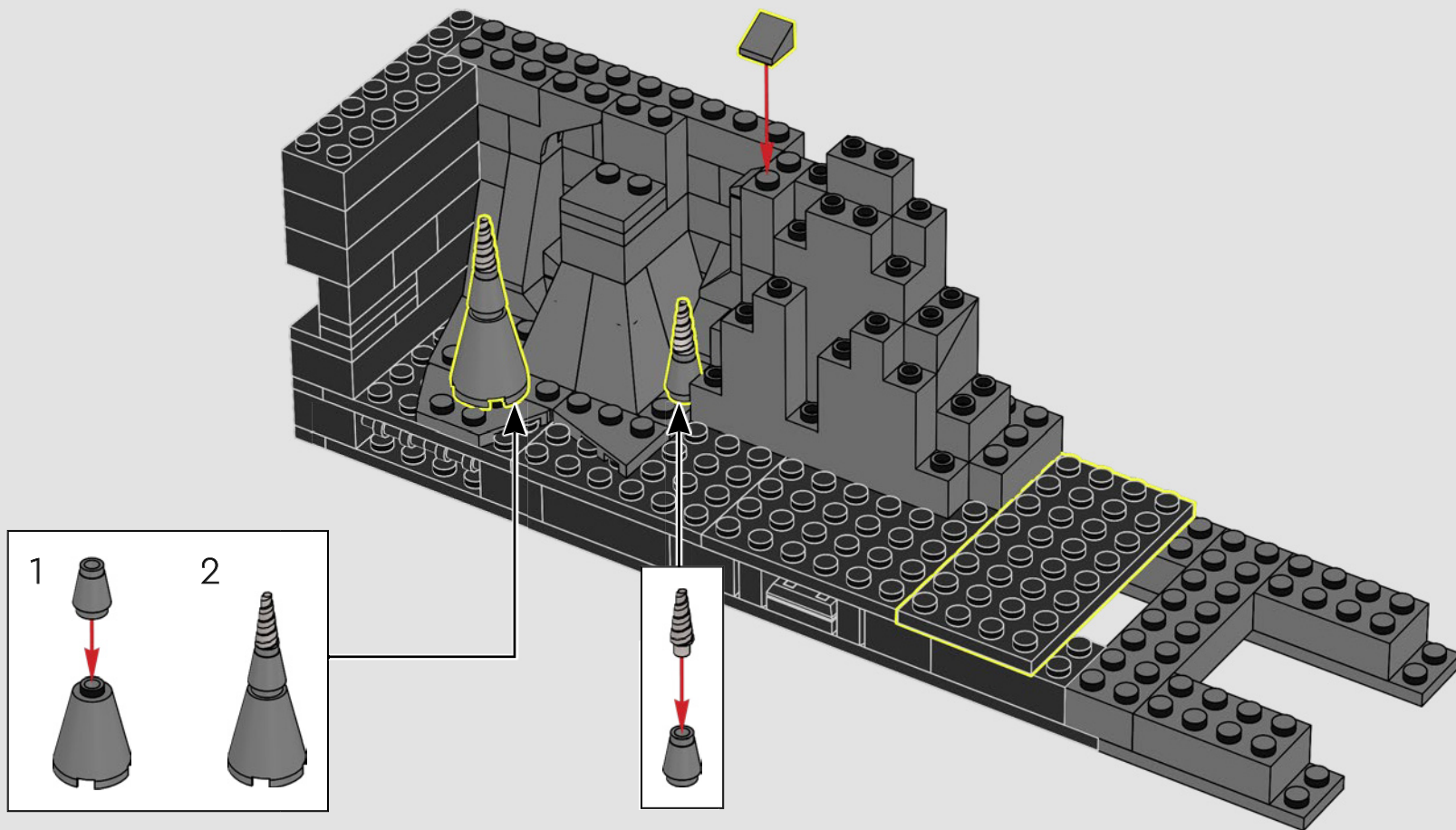

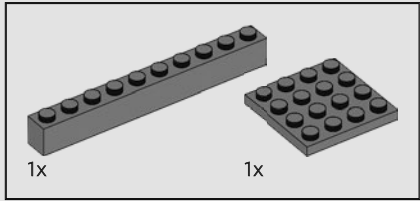
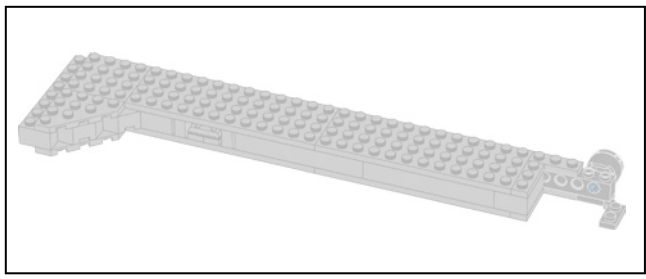

127

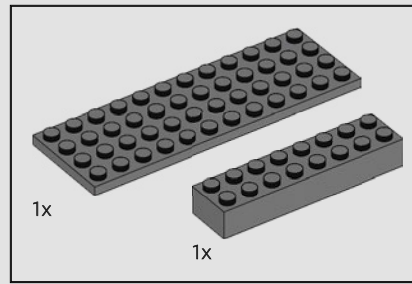
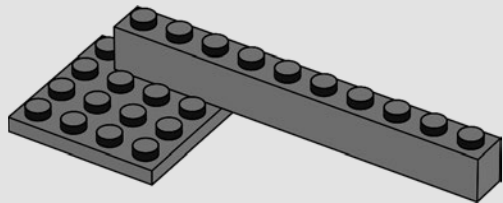

128

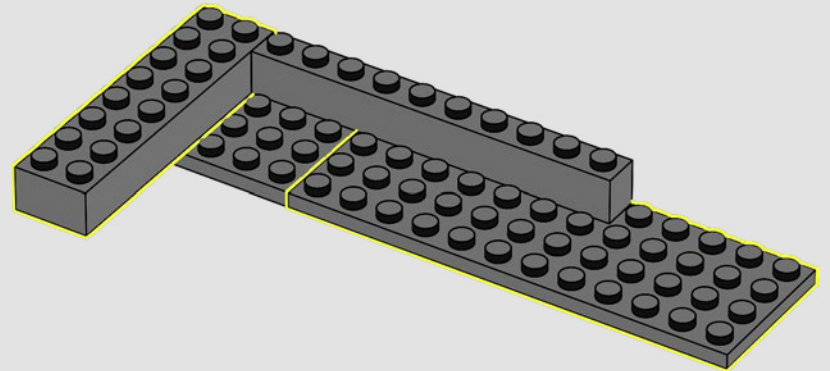



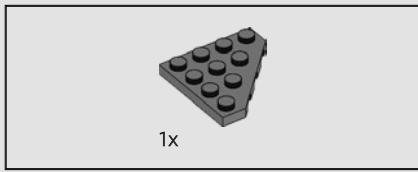

129

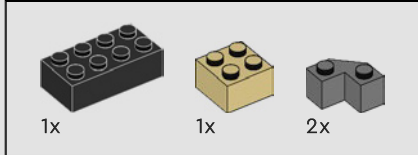
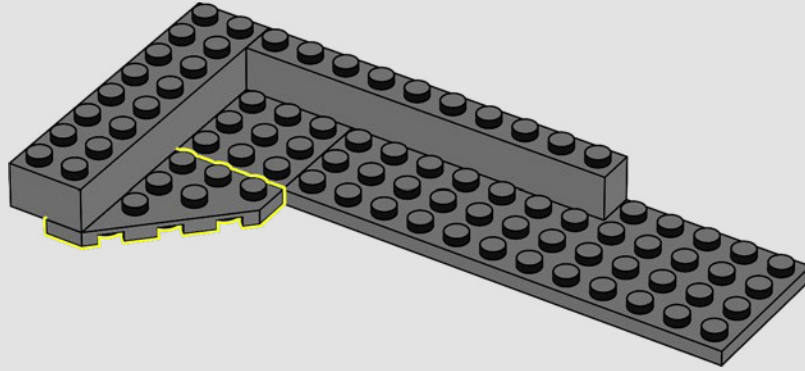

130

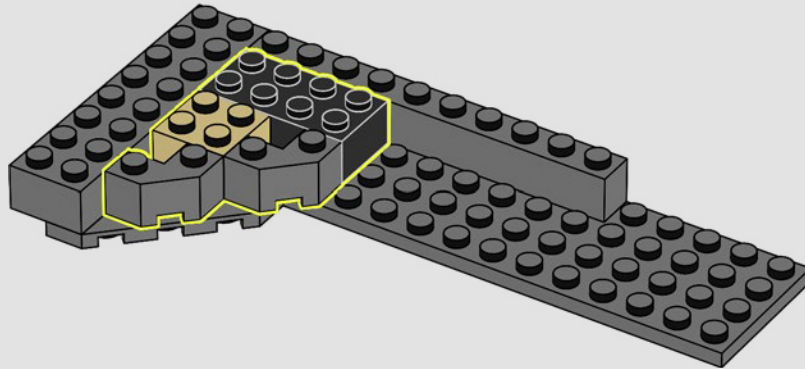

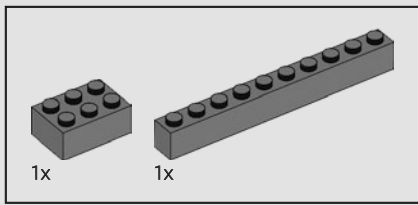

131

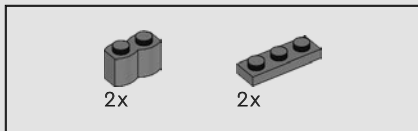
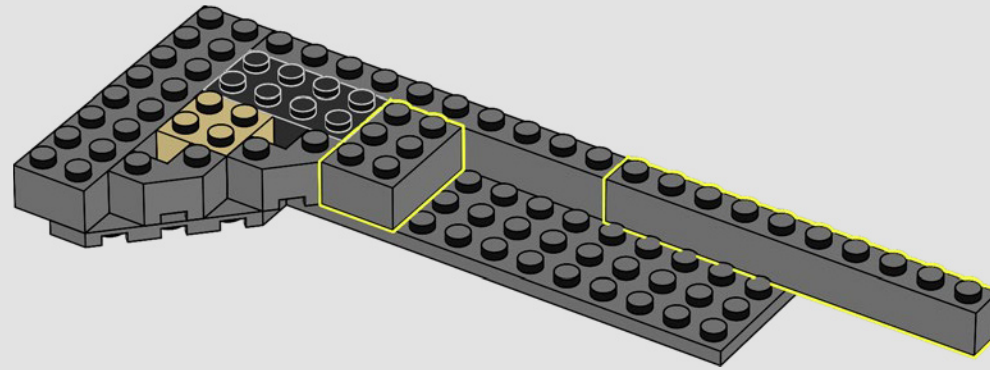

132

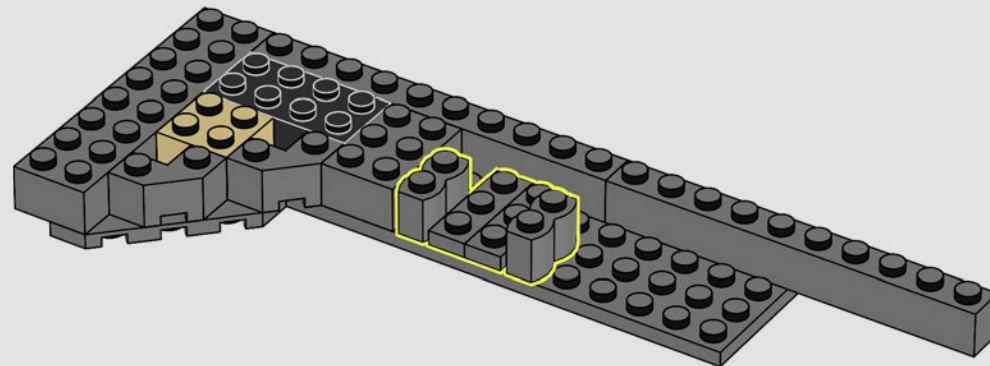

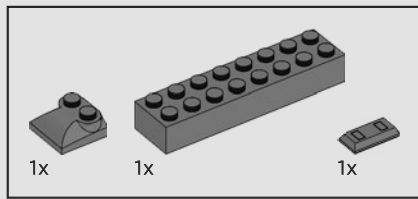

133

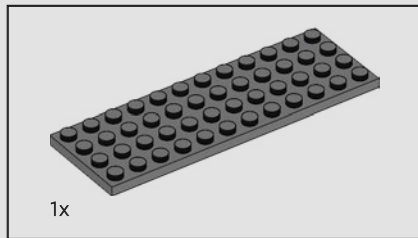
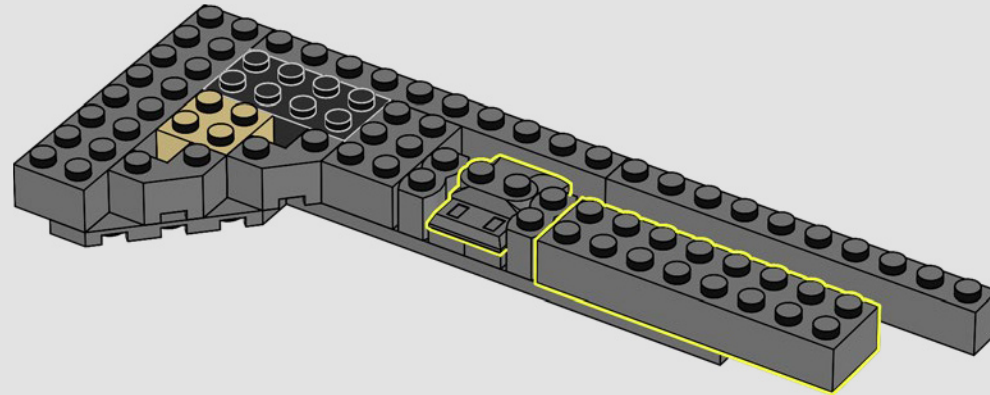

134

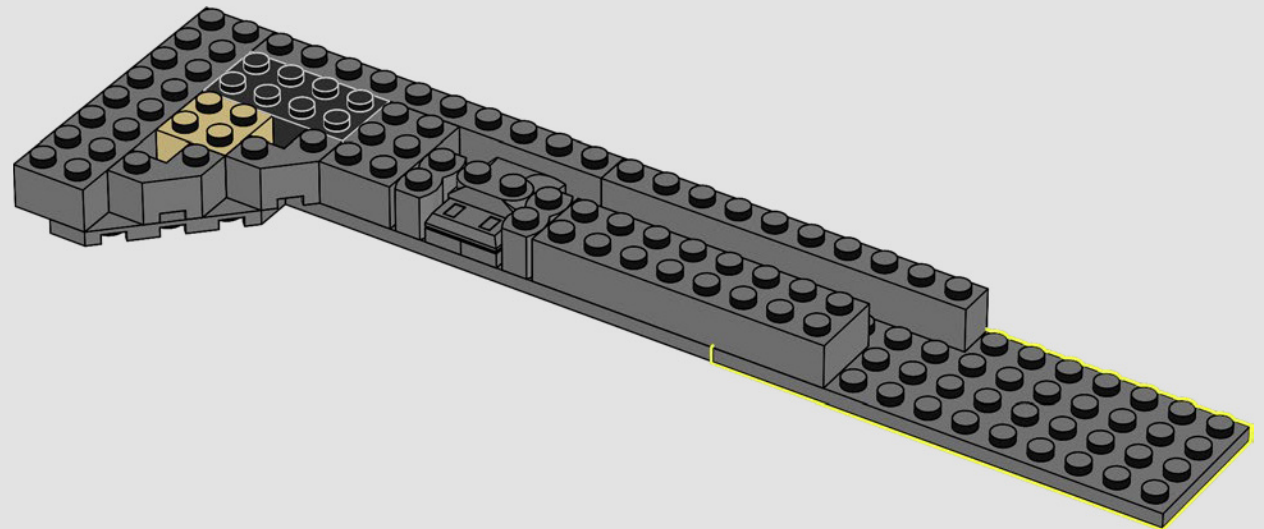

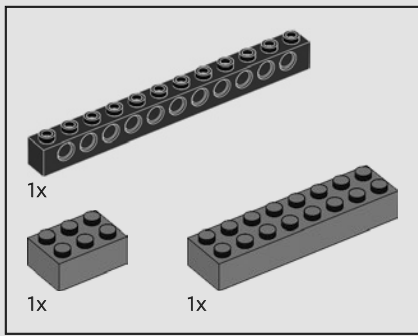

135

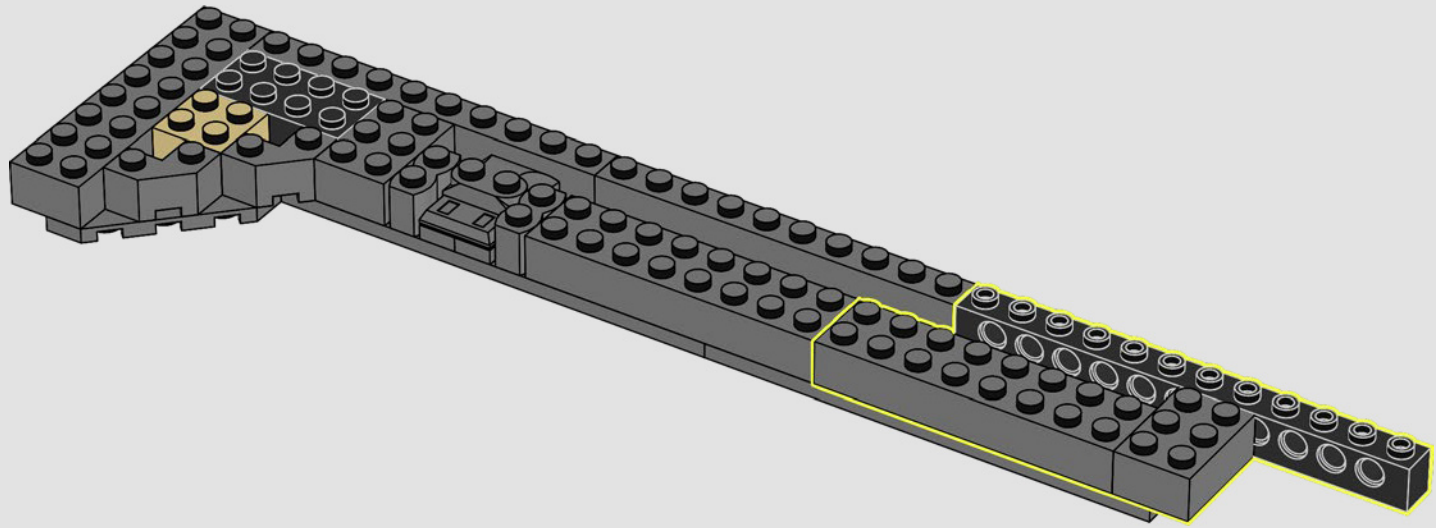

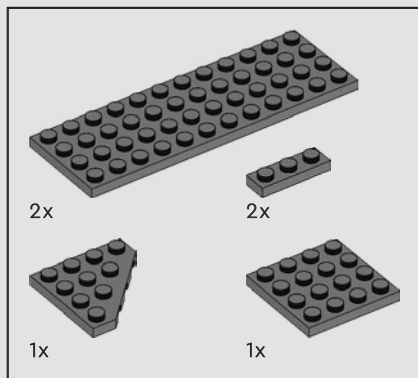

136

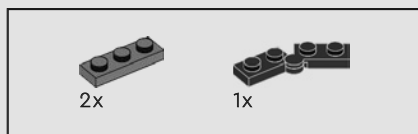
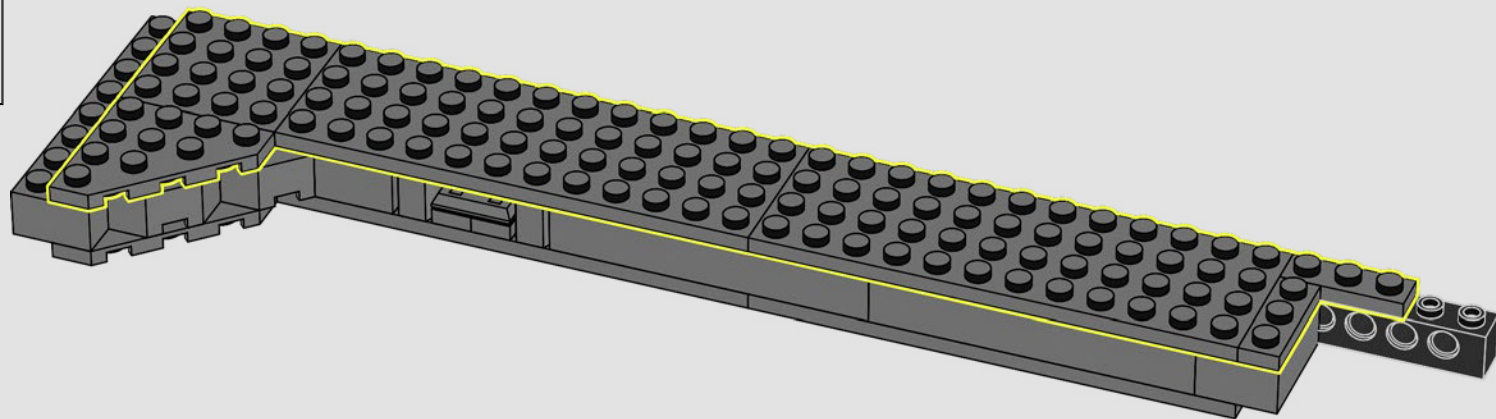

137

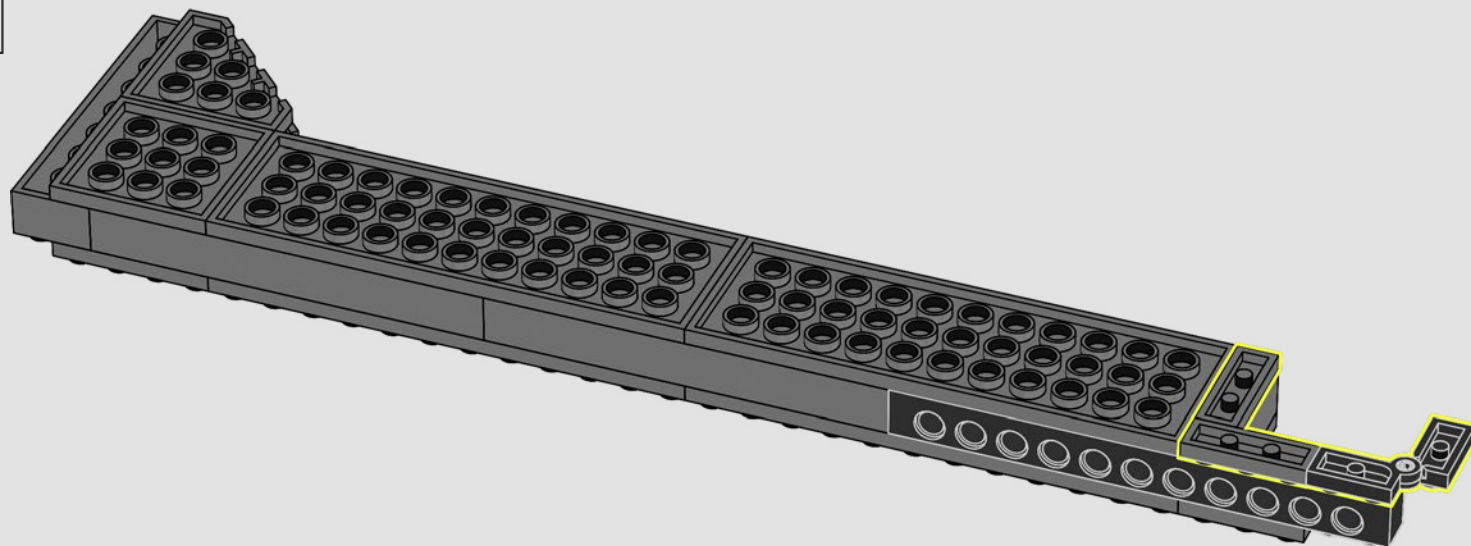

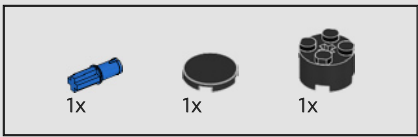

138

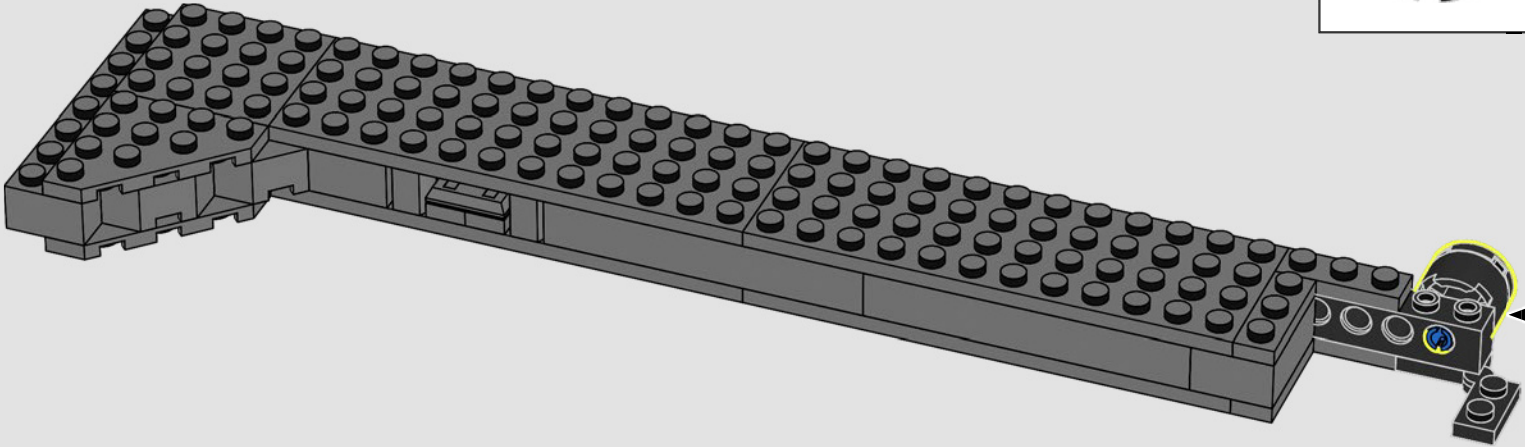
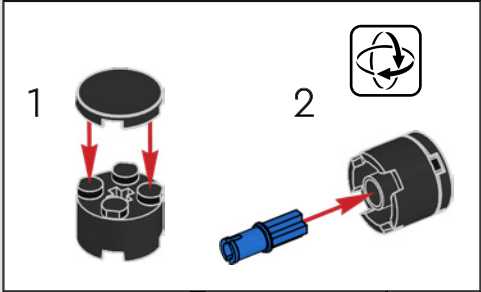

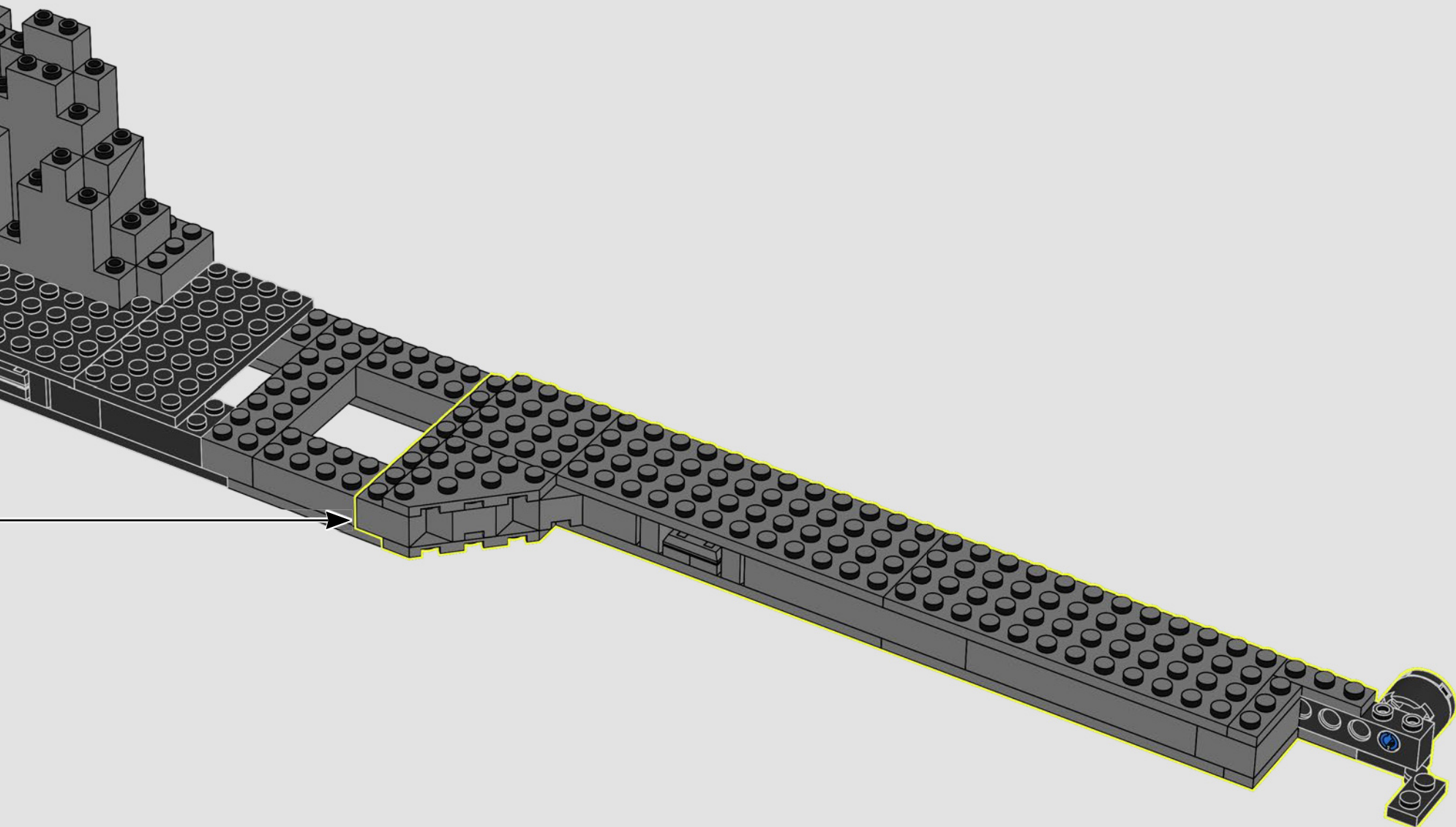

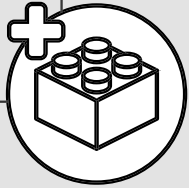
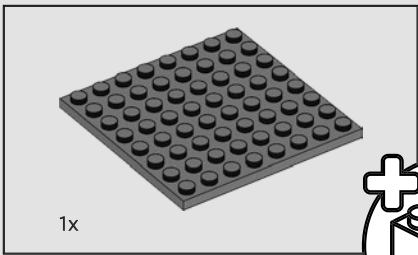

140

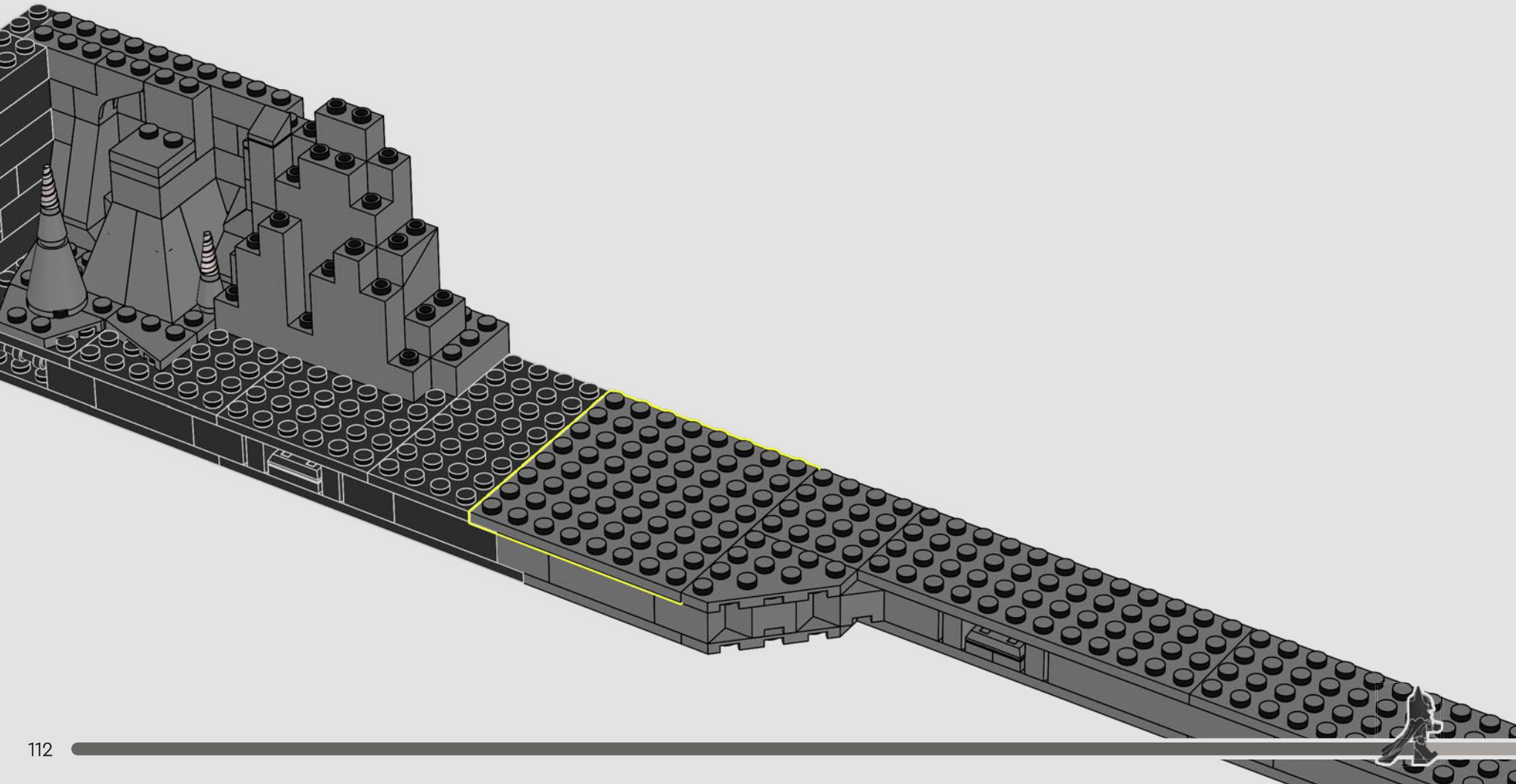





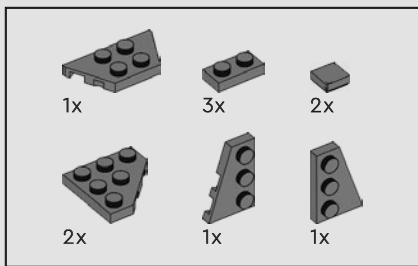

141

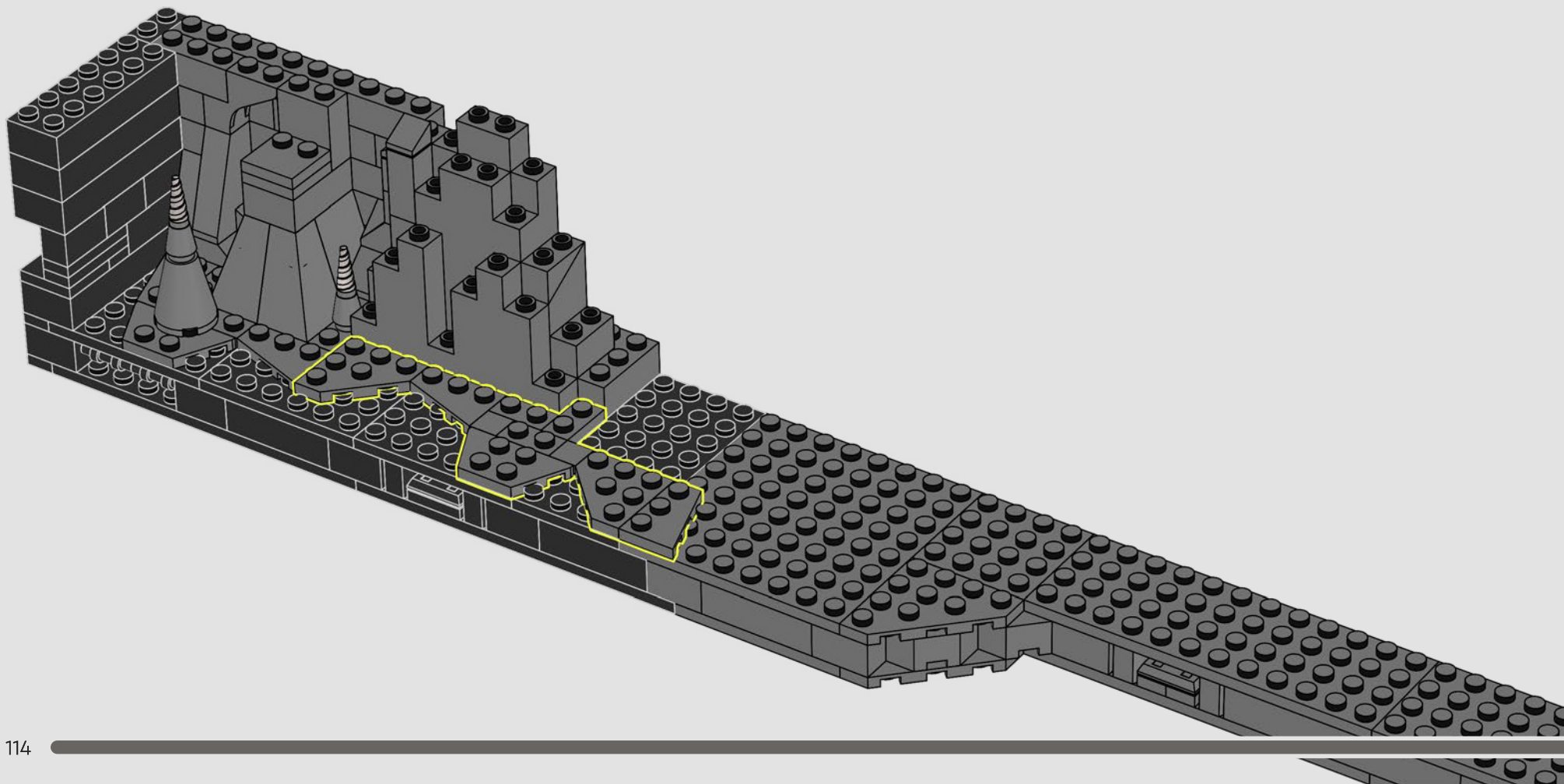

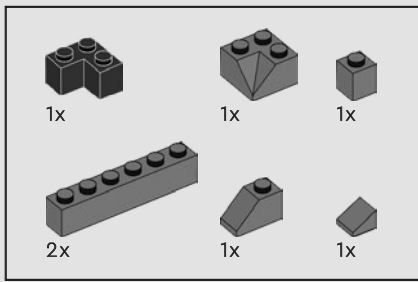

142

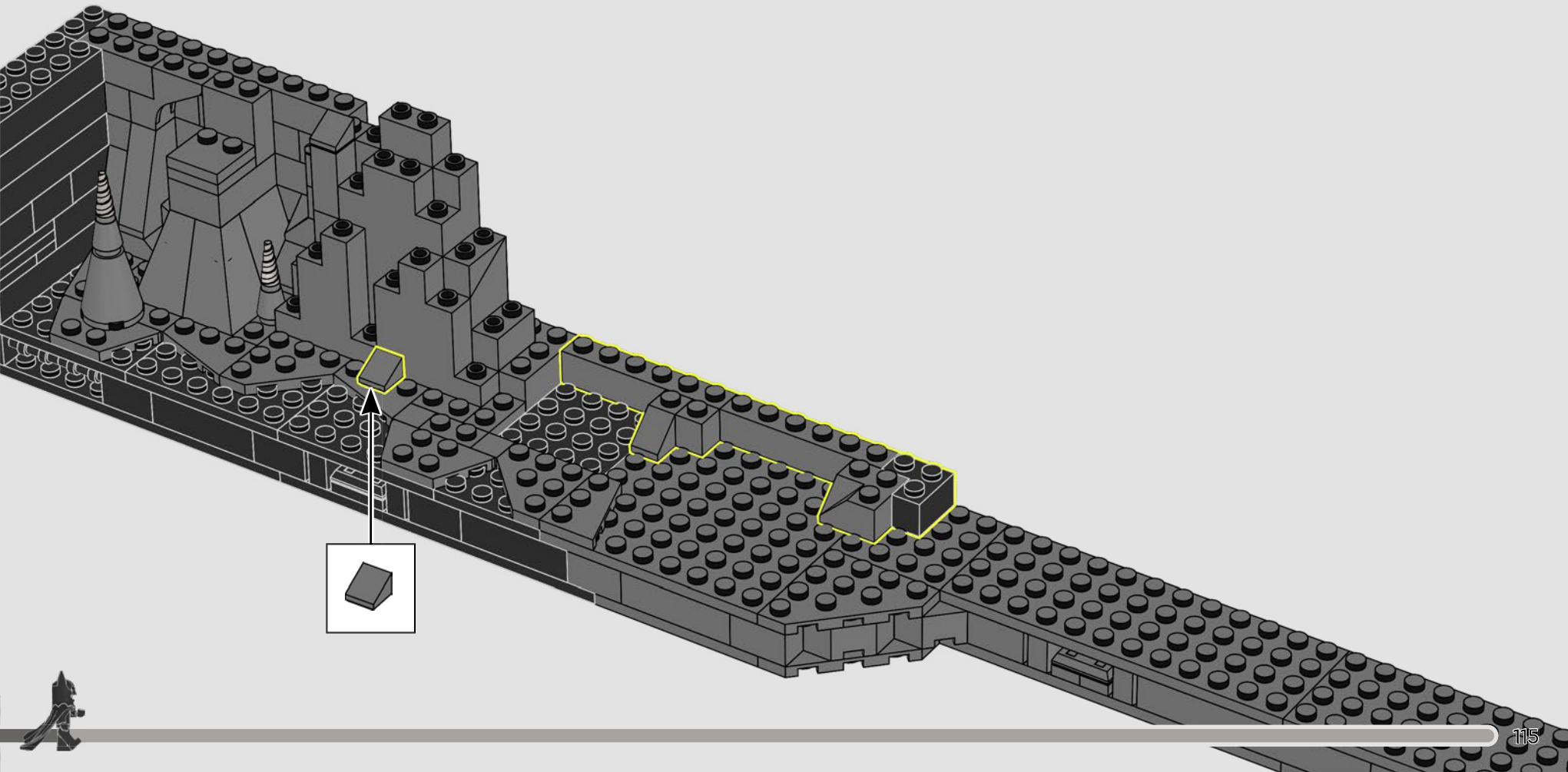

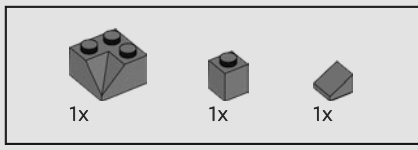

143

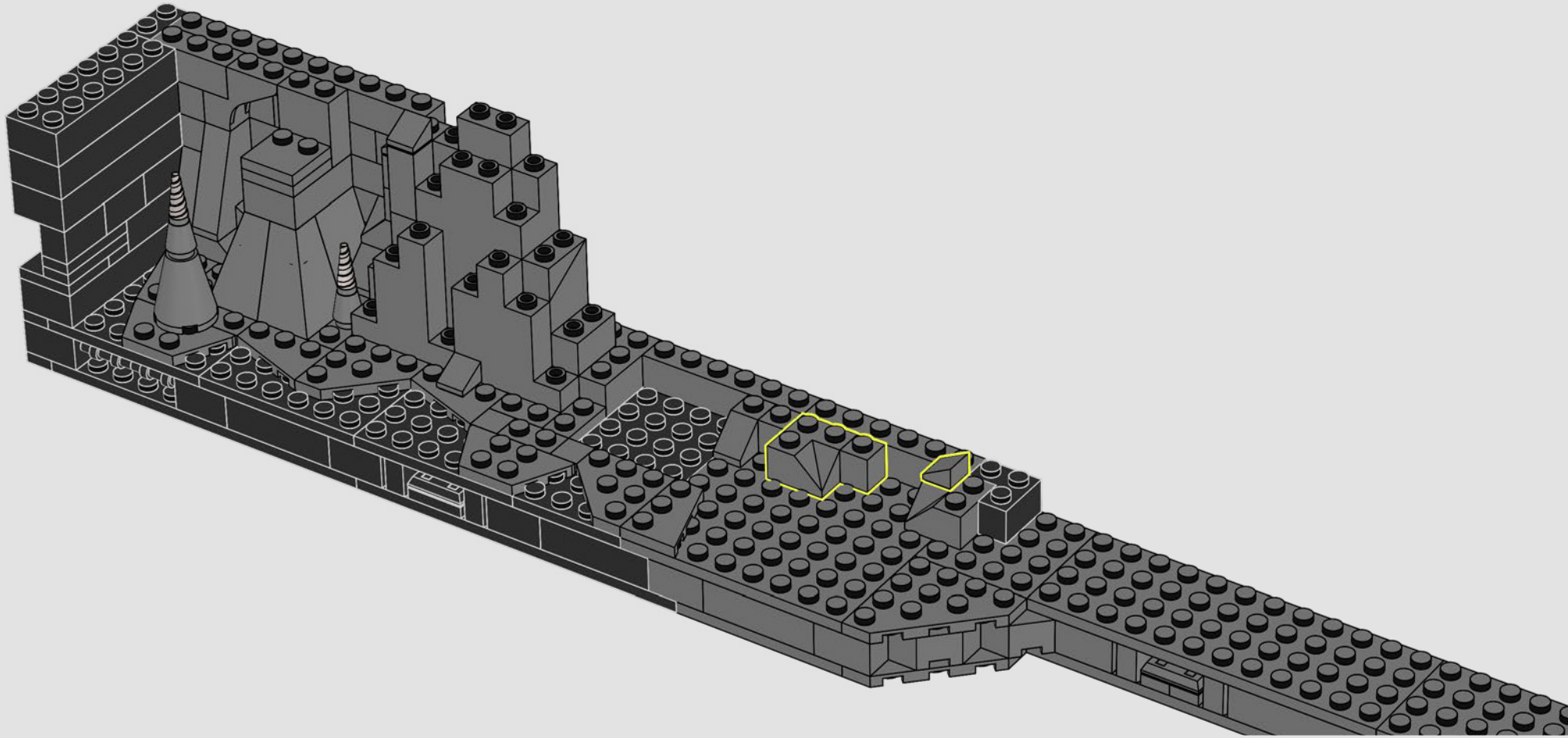

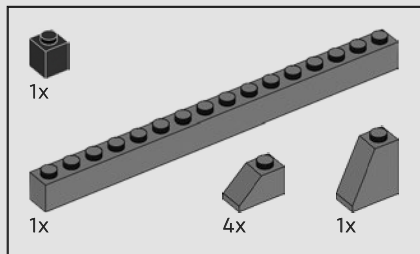

144

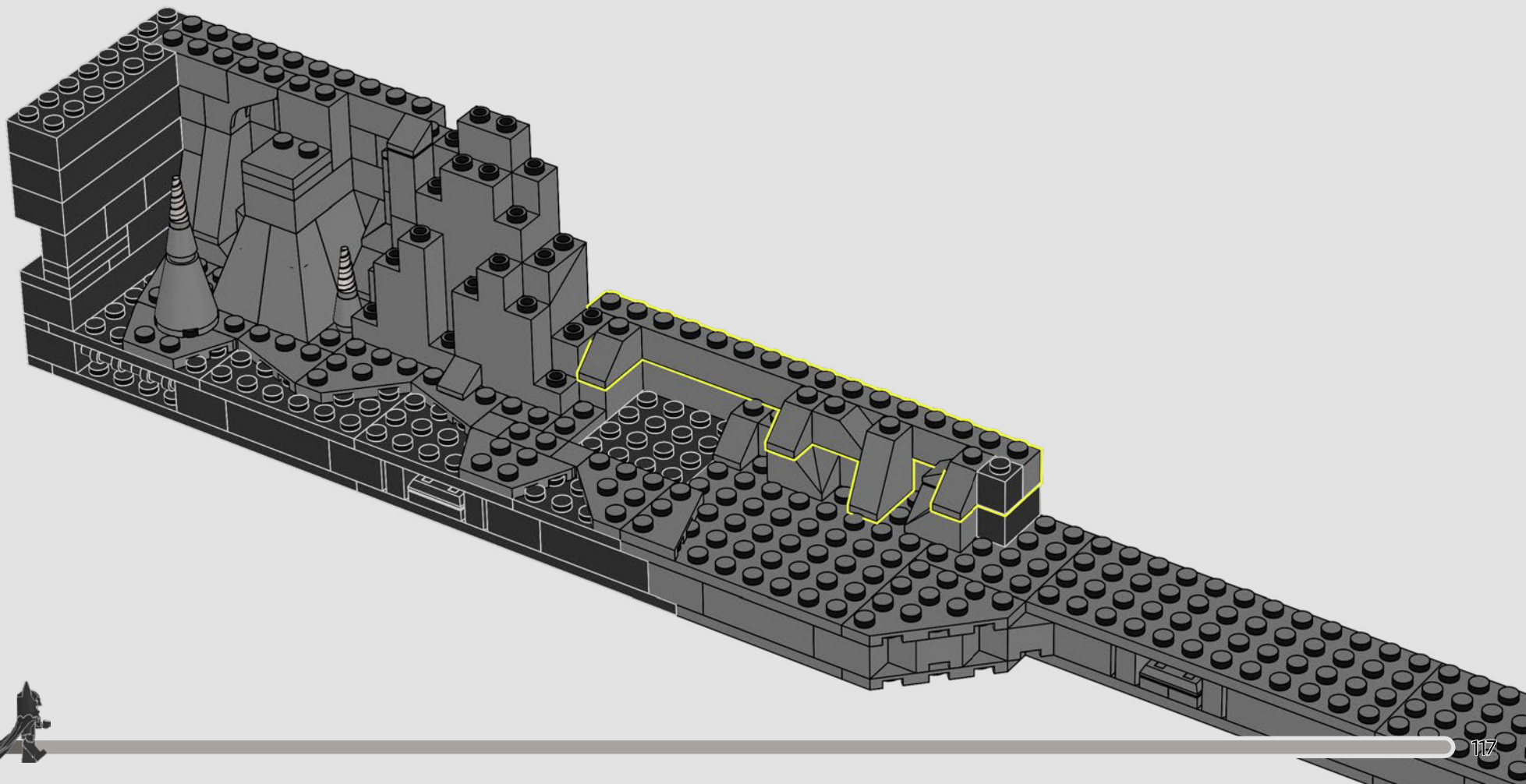

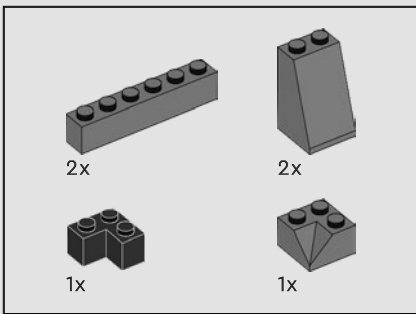

145

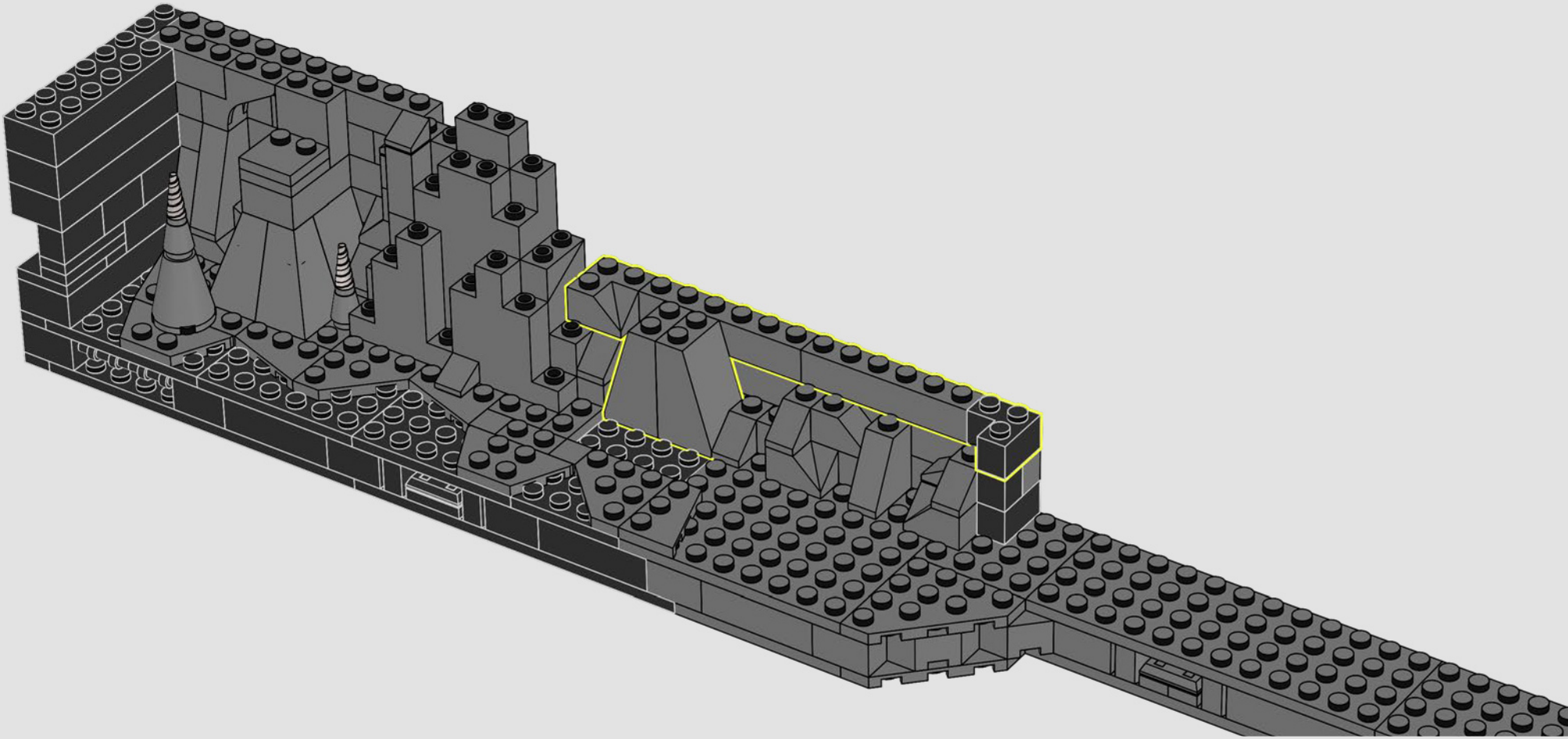

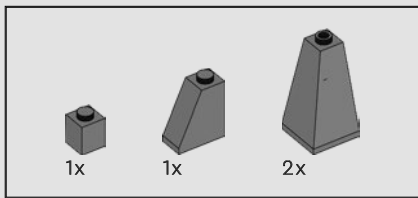

146

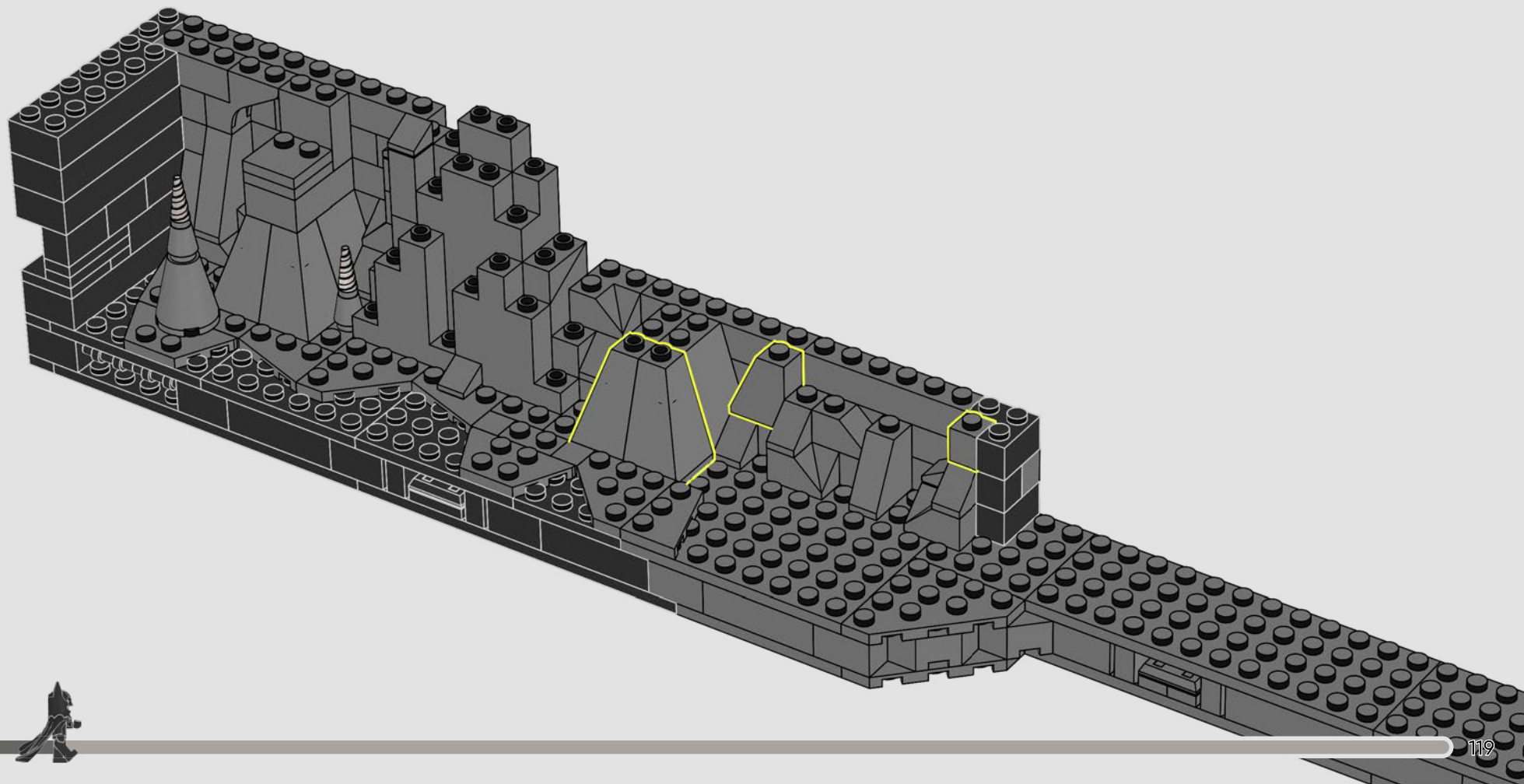

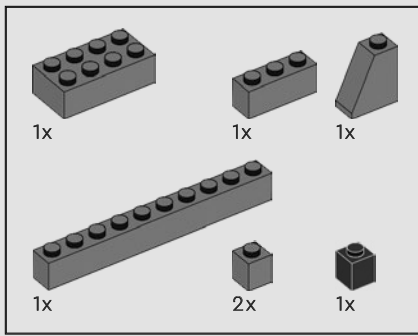

147

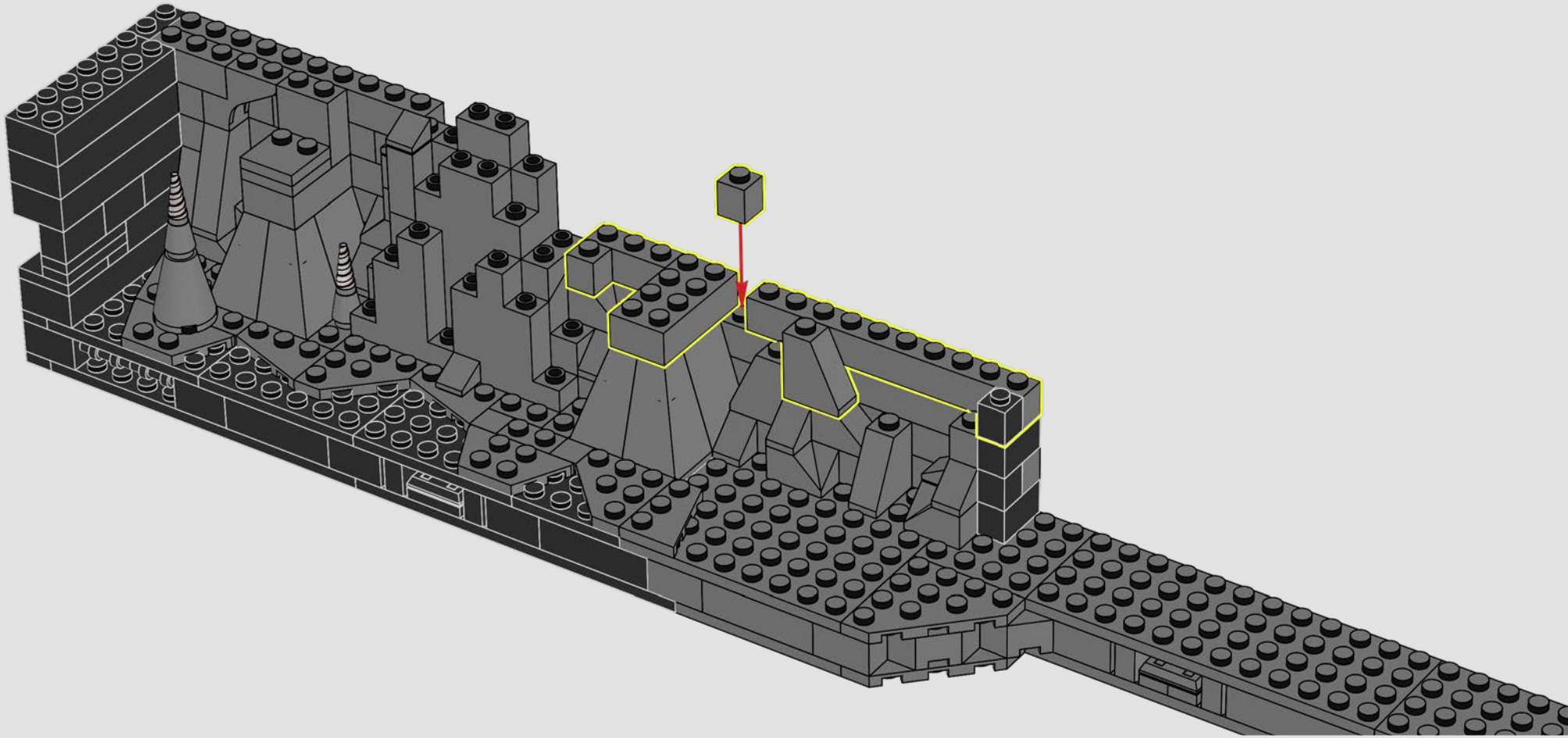



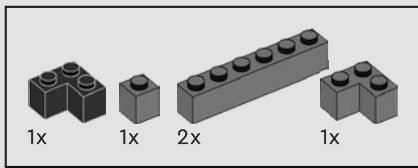

148

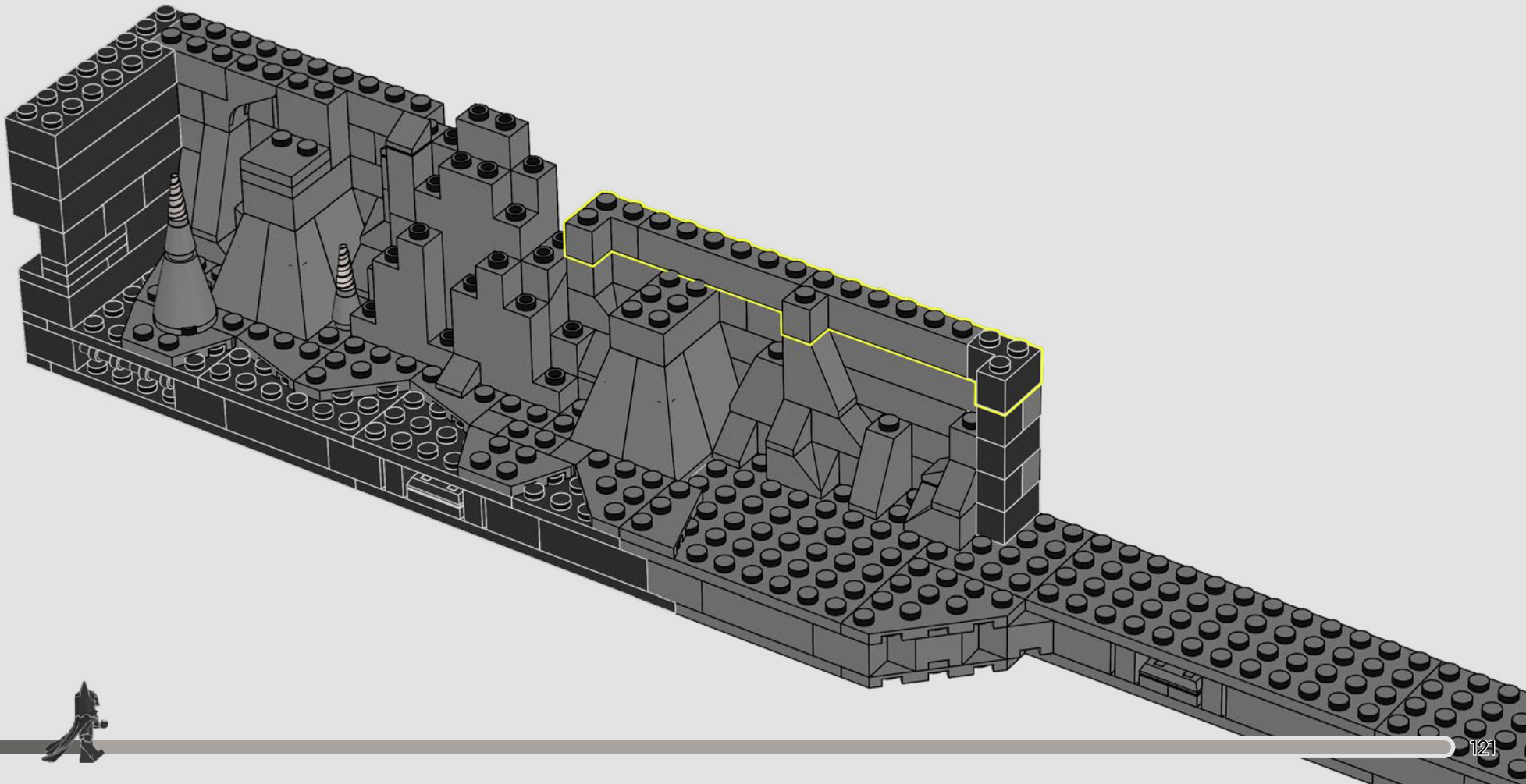

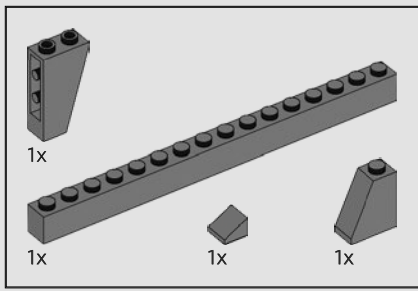

149

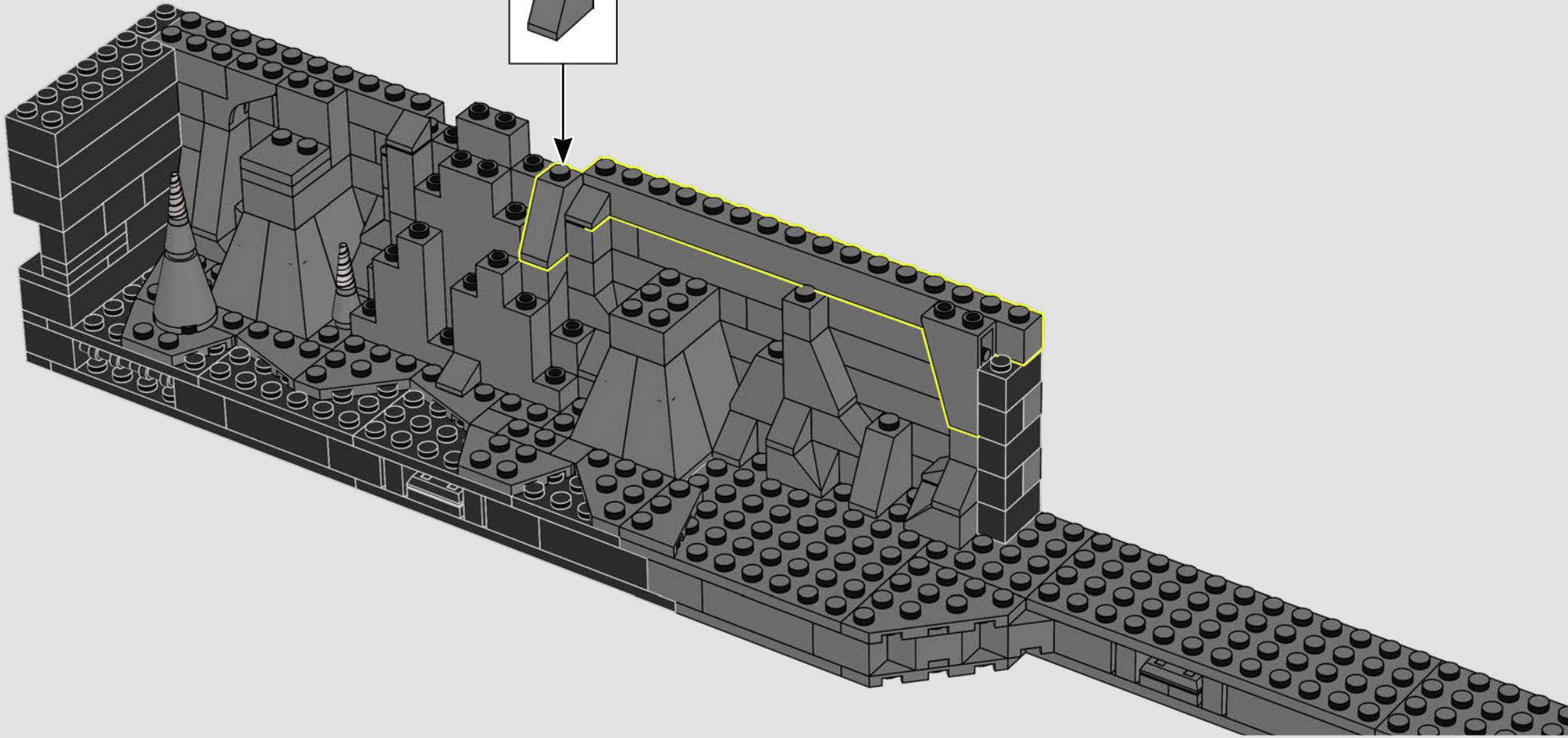
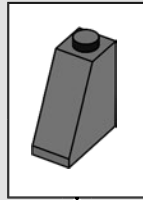

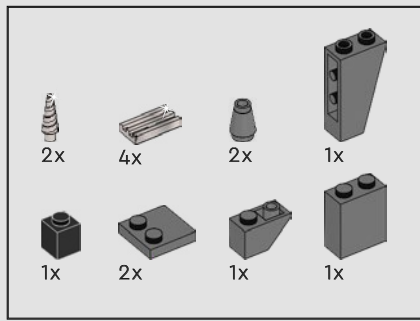

150

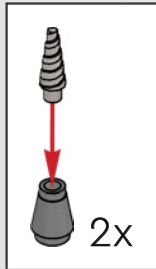
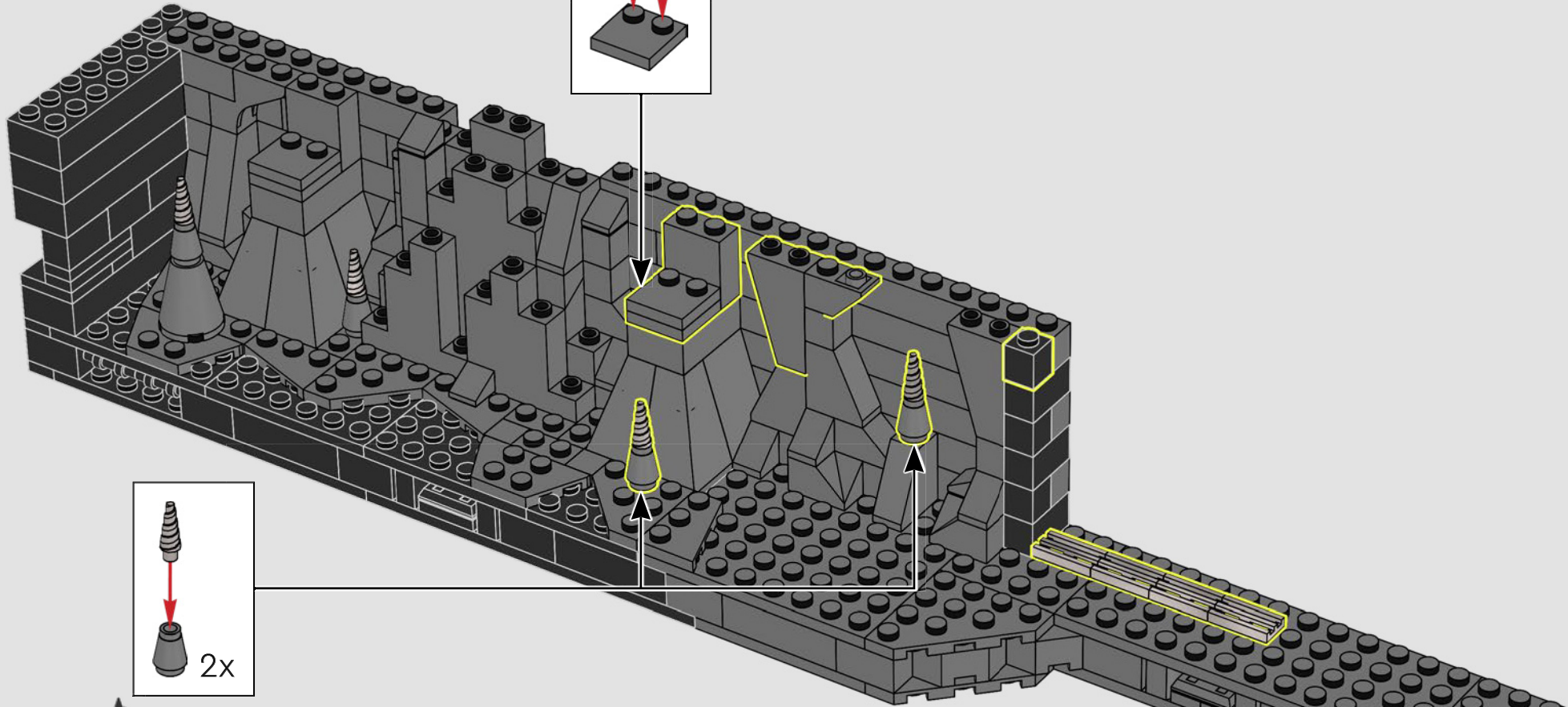
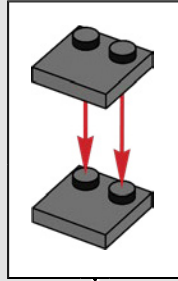

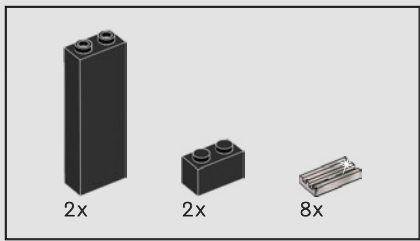

151

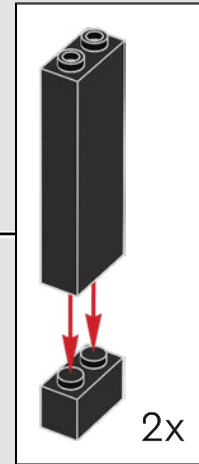
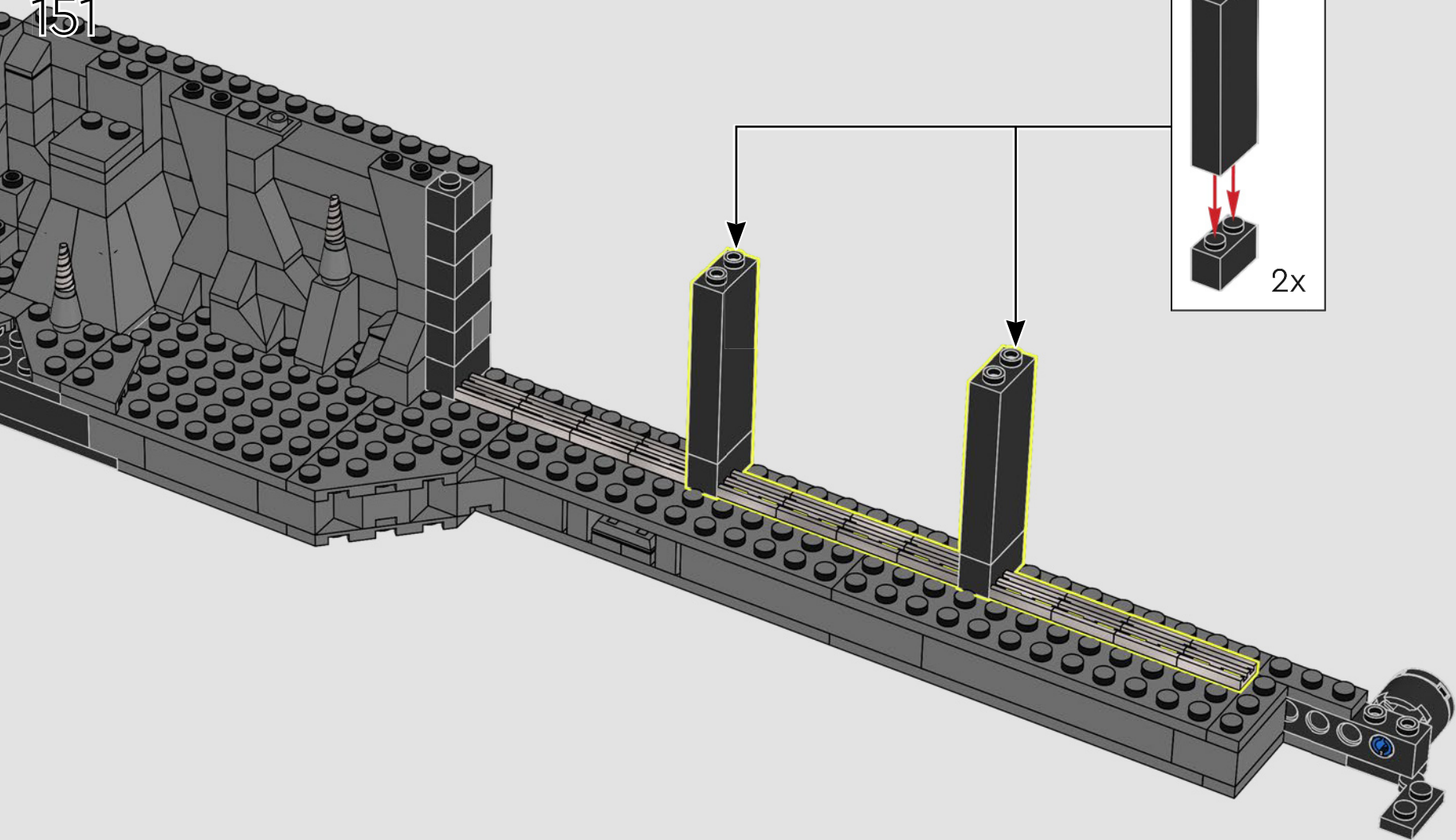

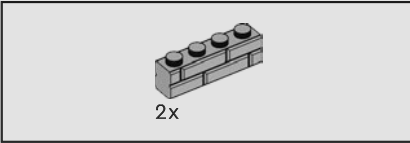
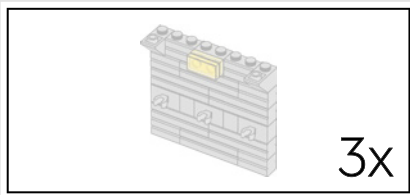

152

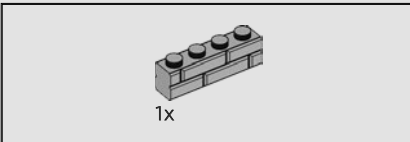
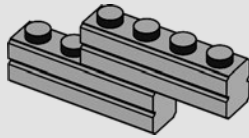

153

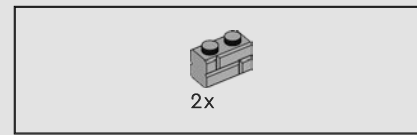
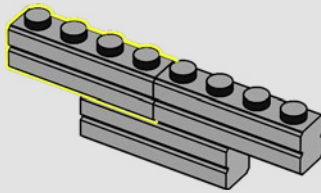

154

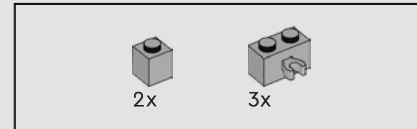
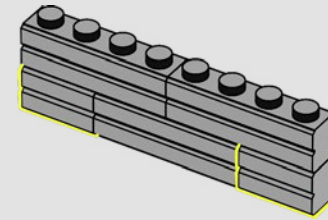

155

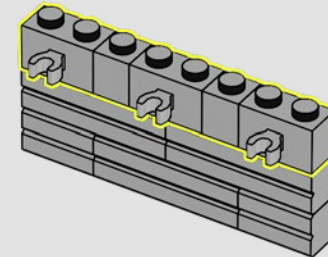

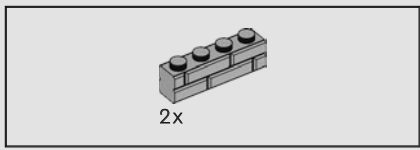

156

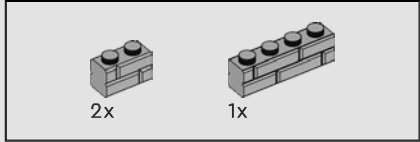
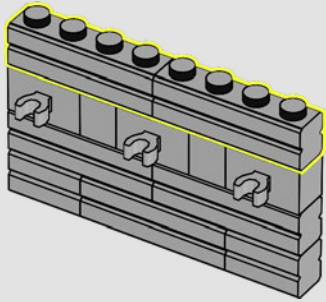

157

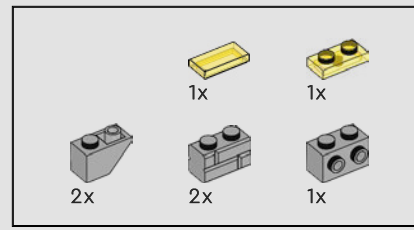
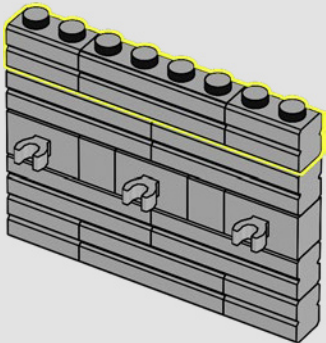

158

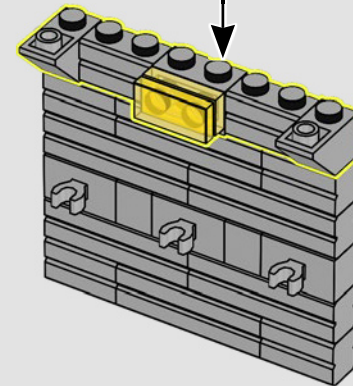
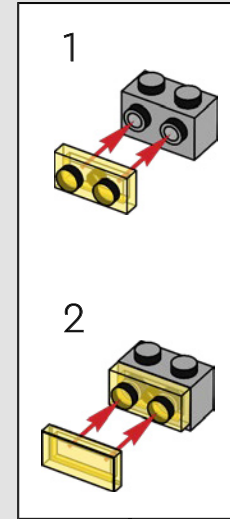

3x

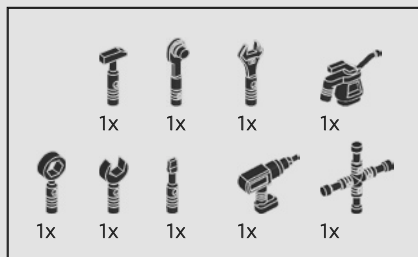

159

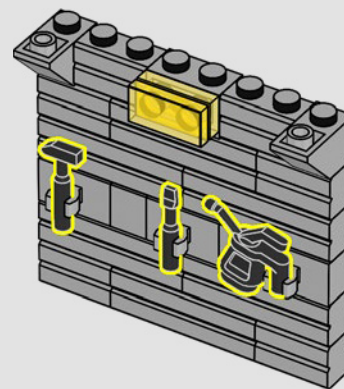
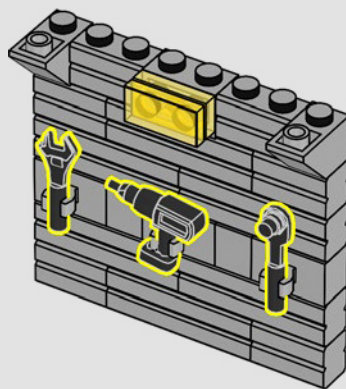
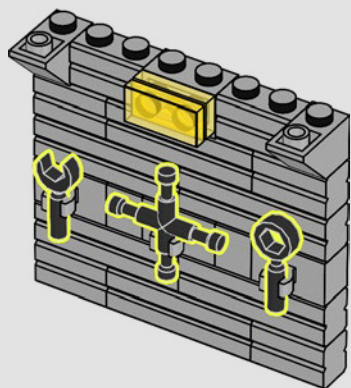

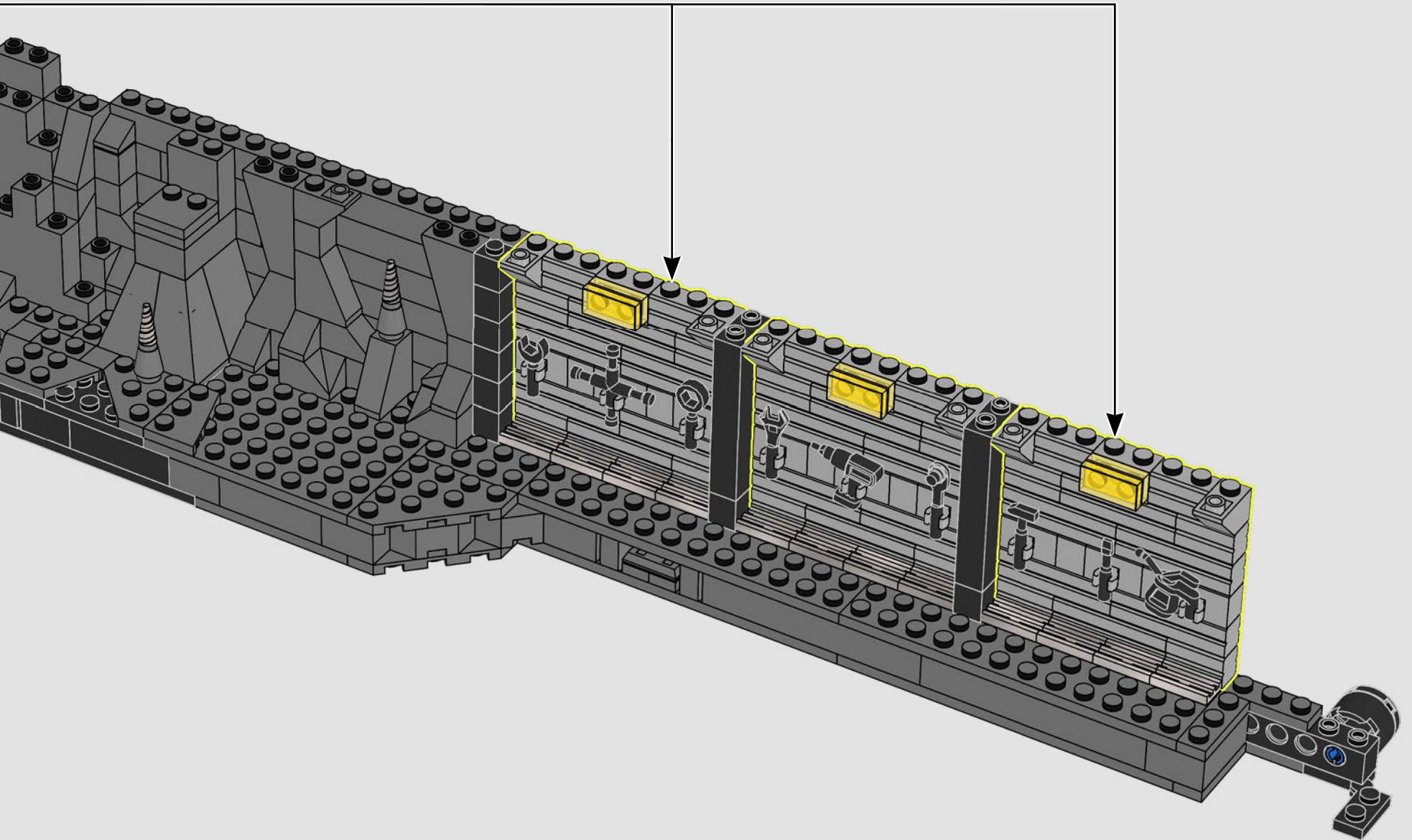



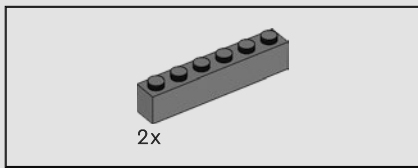

161

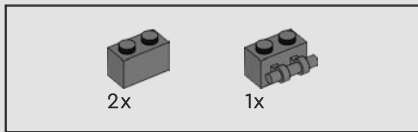
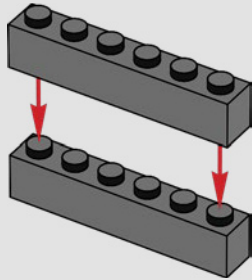

162

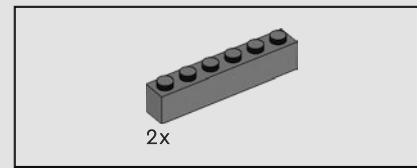
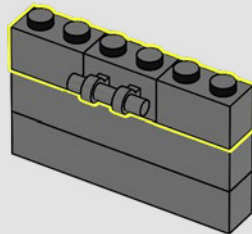

163

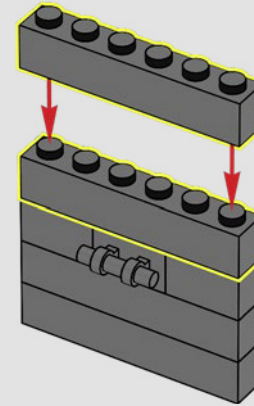

164

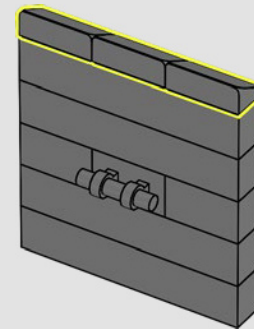

165

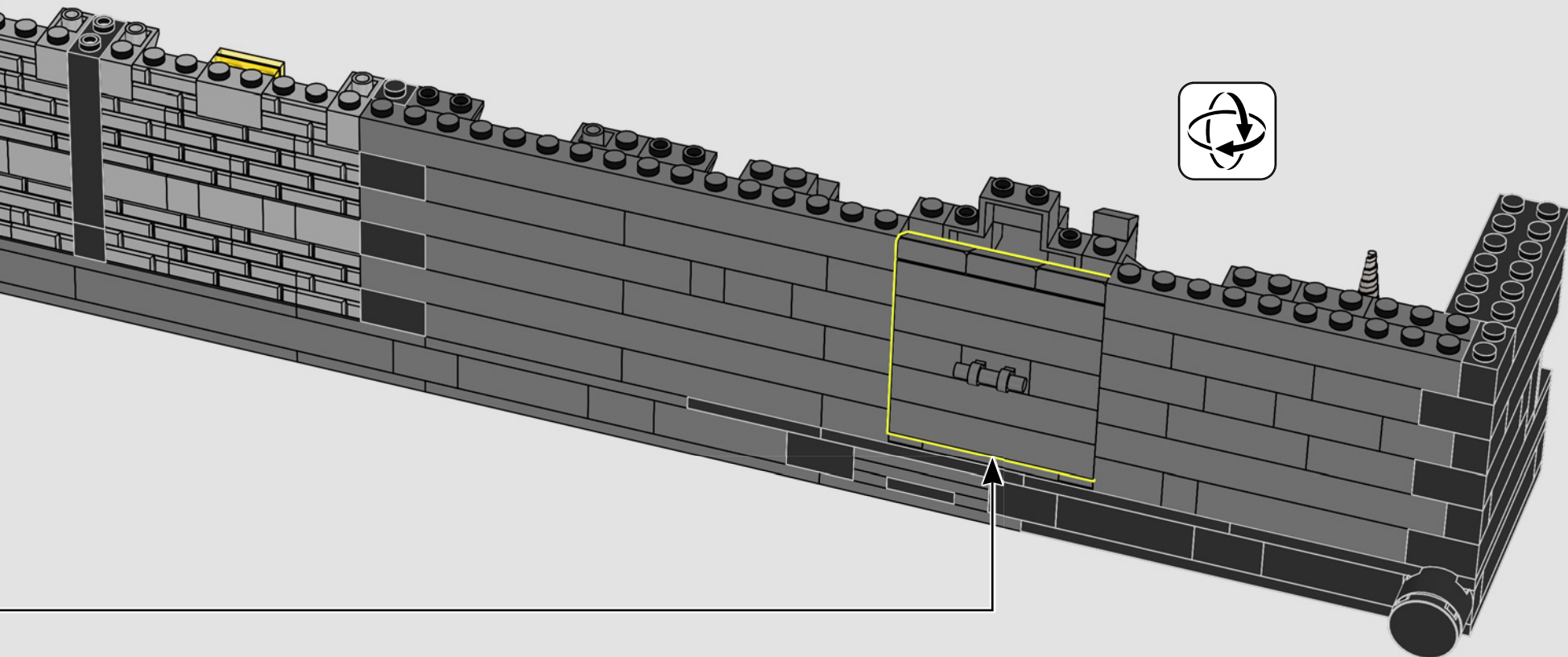

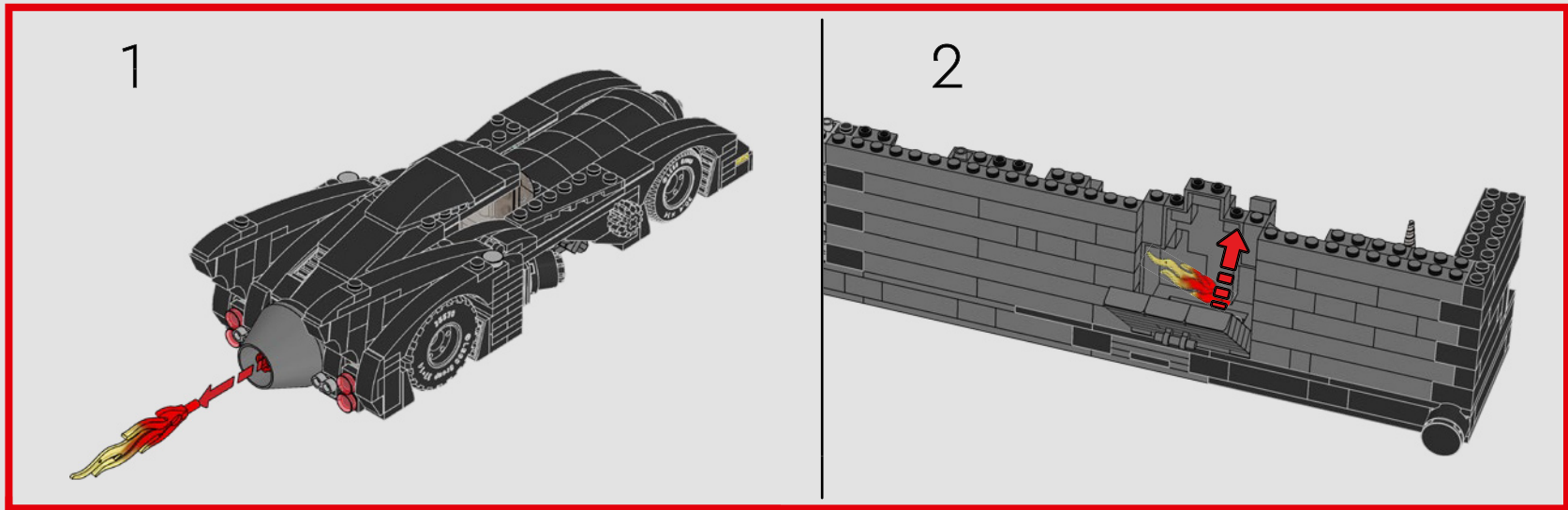

## GEHEIMFACH

Sogar außen an dem Schaukasten verbergen sich Geheimnisse. Halte nach dem Geheimfach an der Bathöhle Ausschau, in dem du das Flammenelement des Batmobils verstecken kannst.



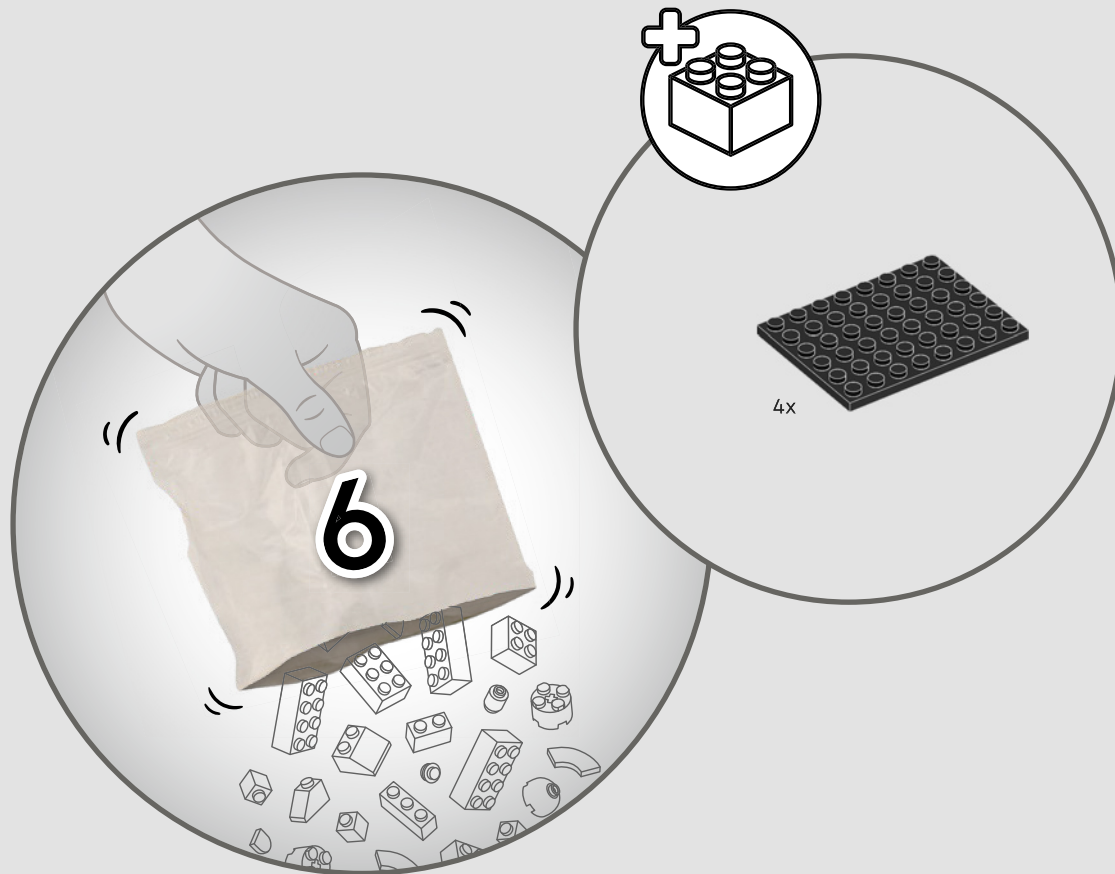

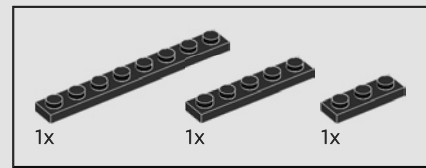
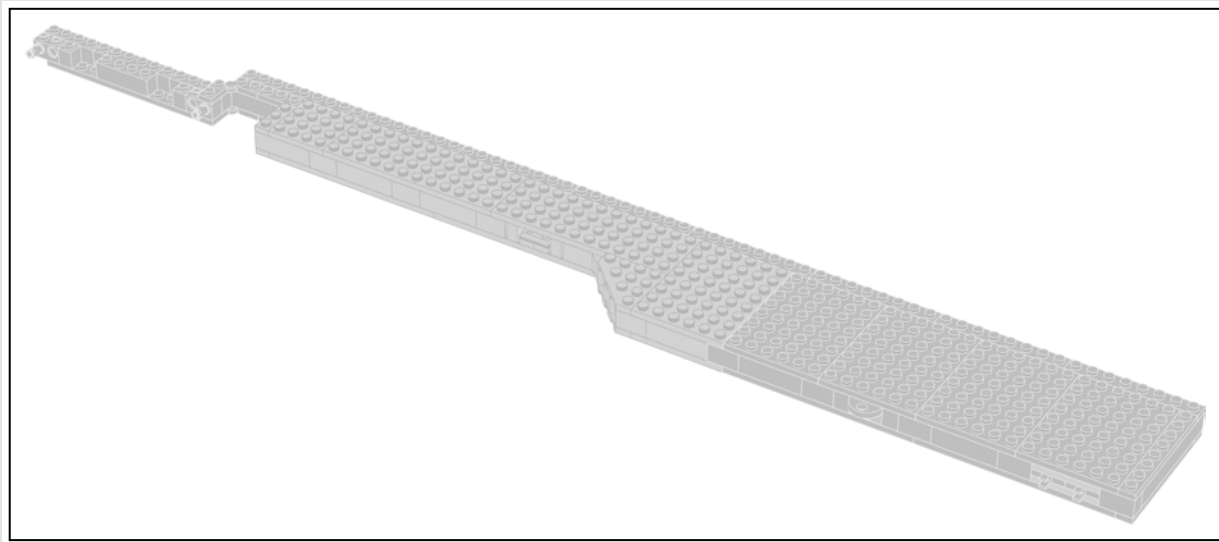

167

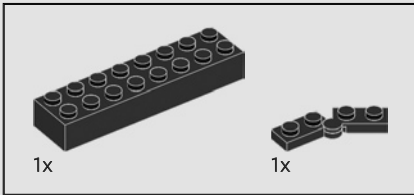

166

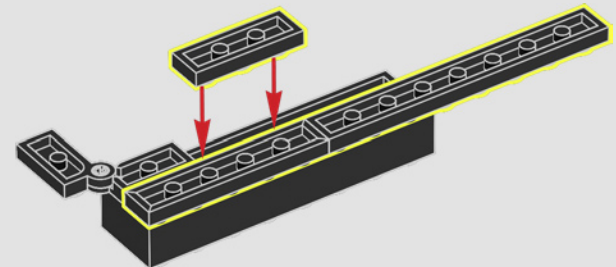
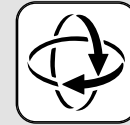
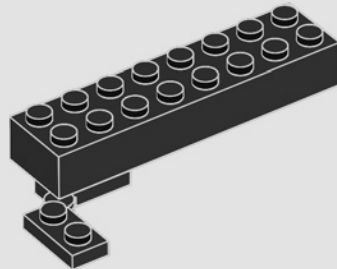

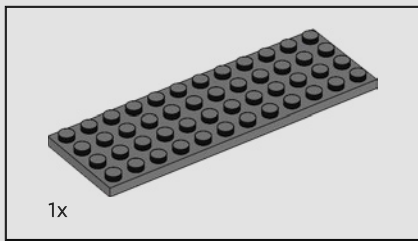

168

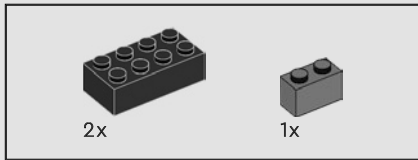
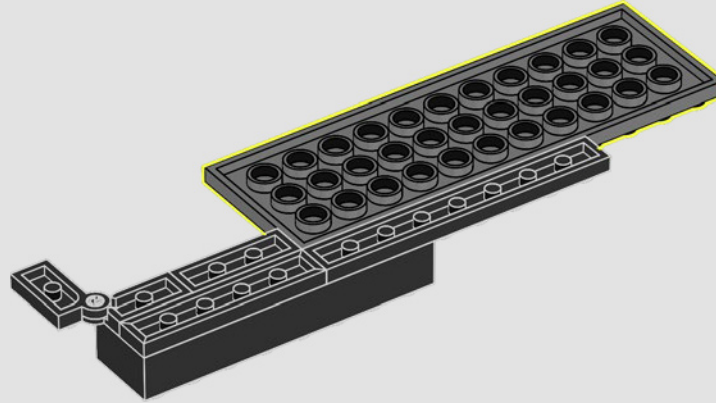

169

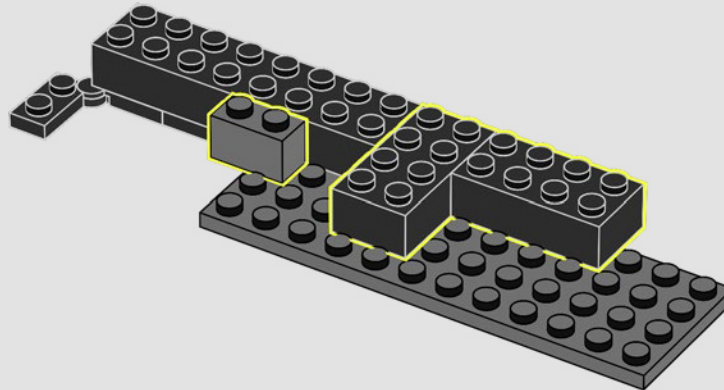

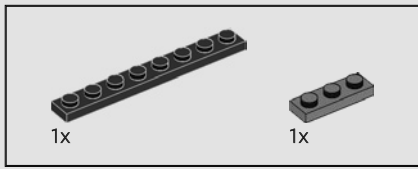

170

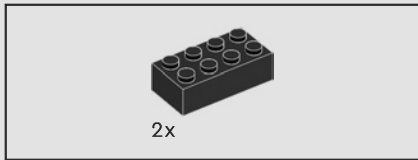
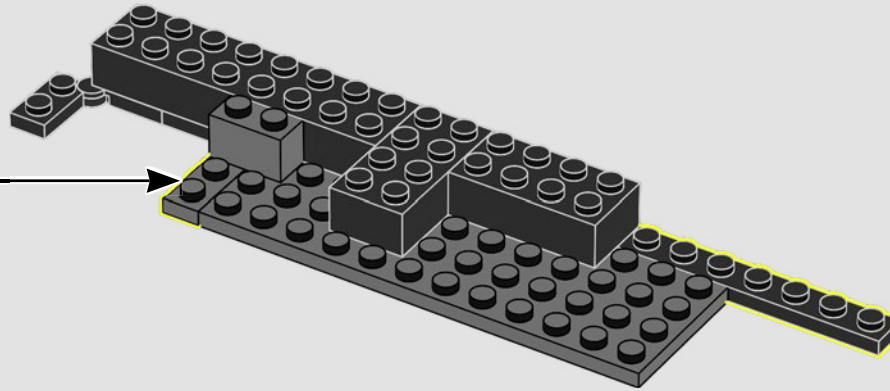
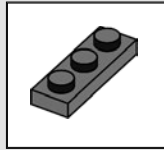

171

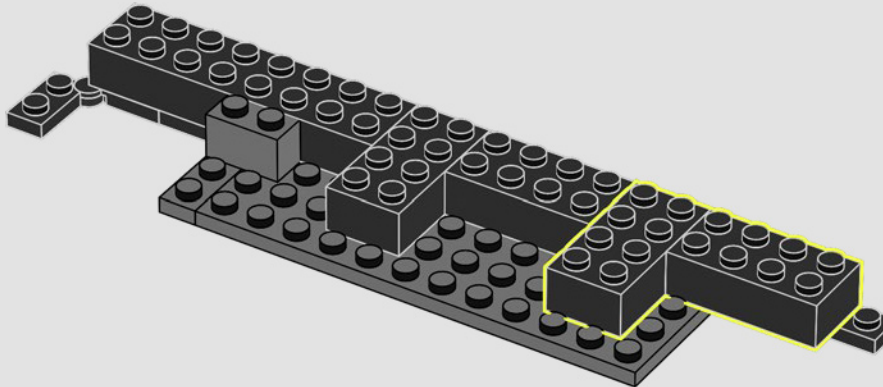

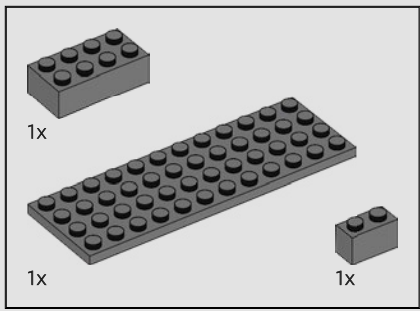

172

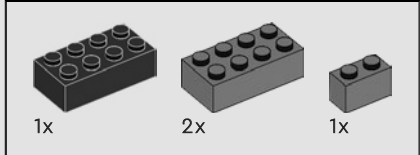
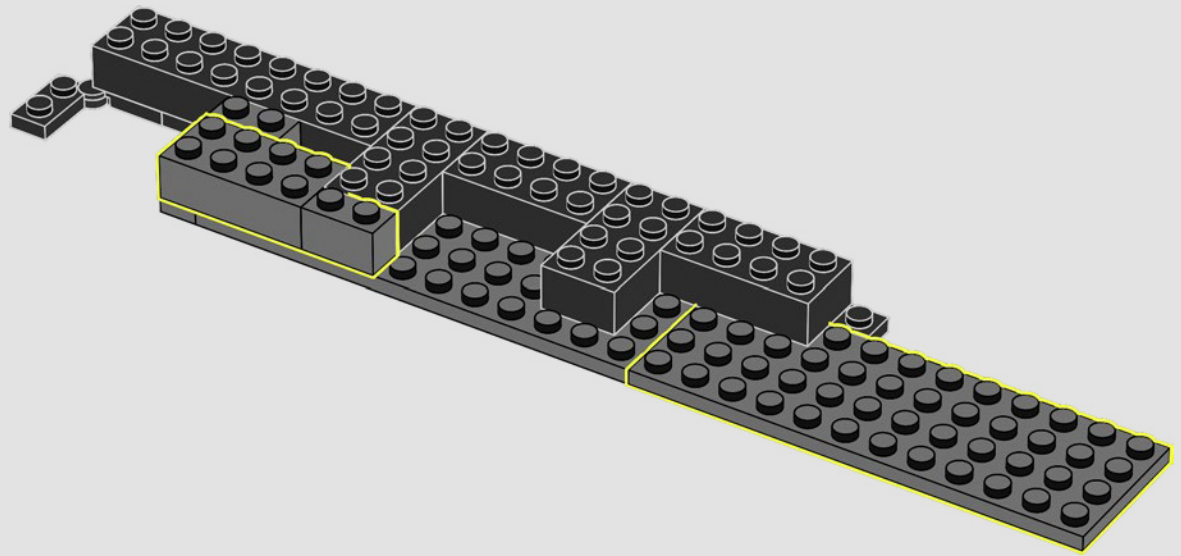

173

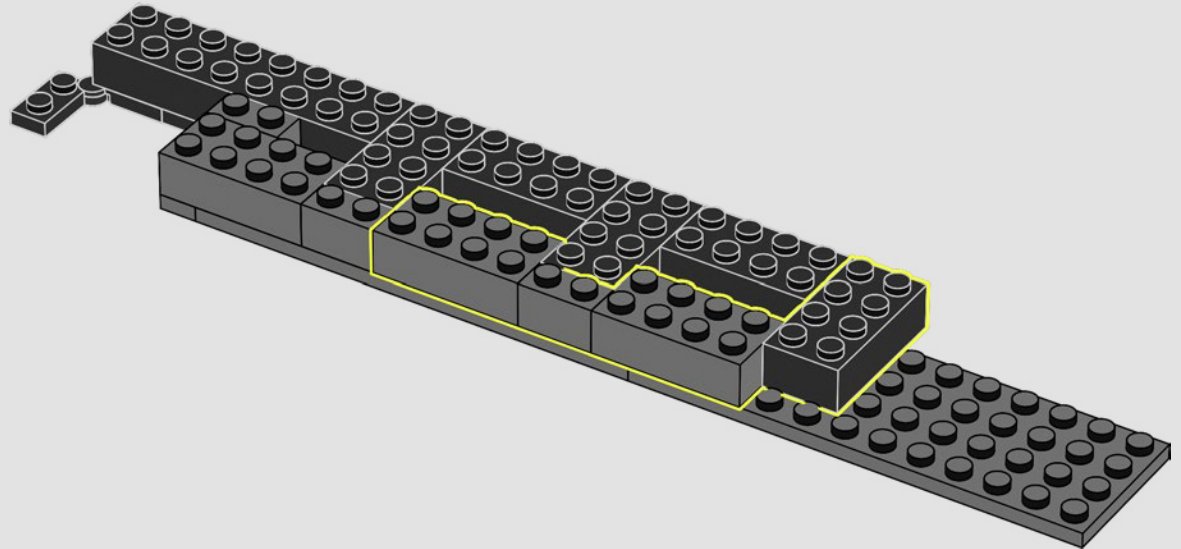



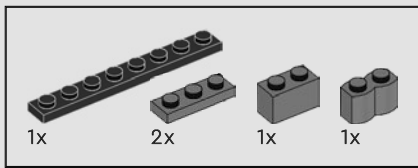

174

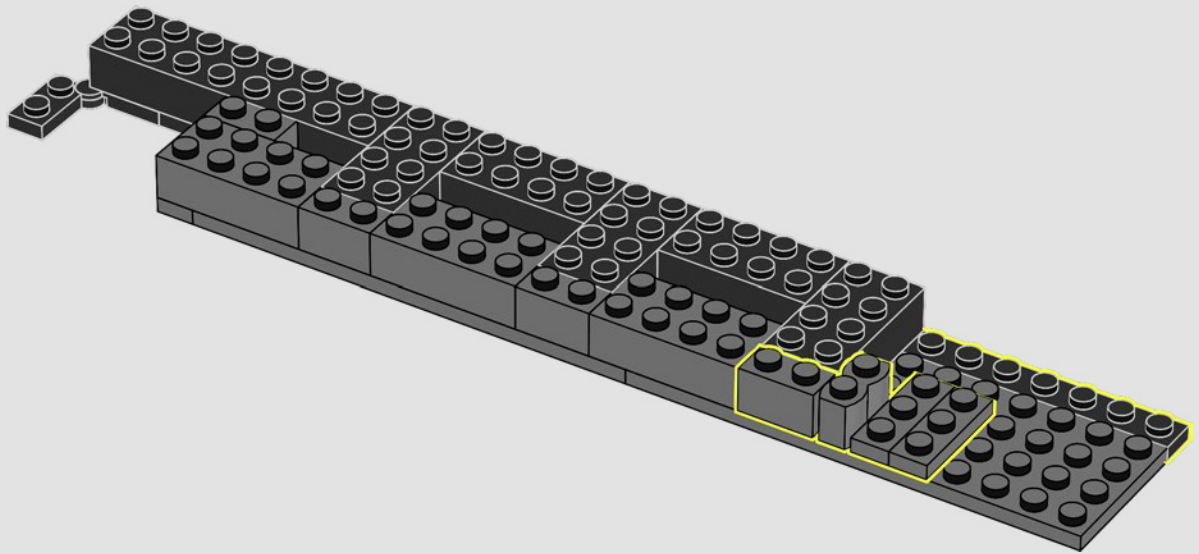

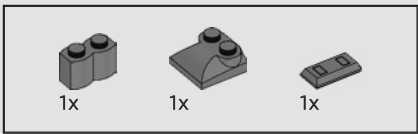

175

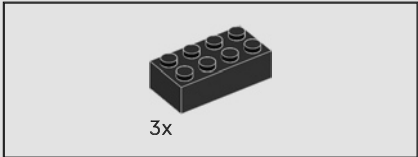
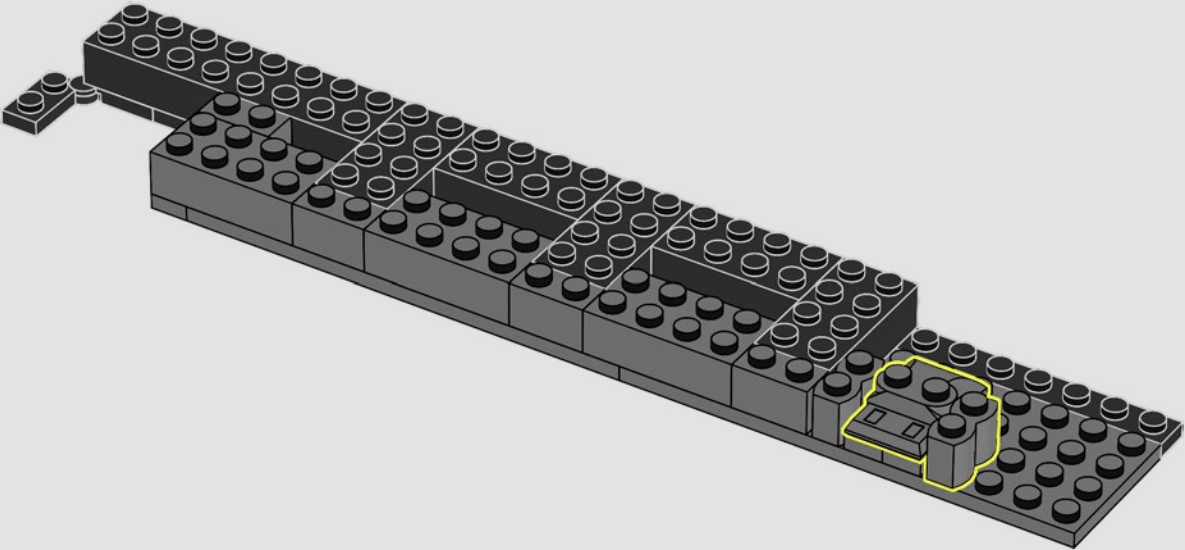

176

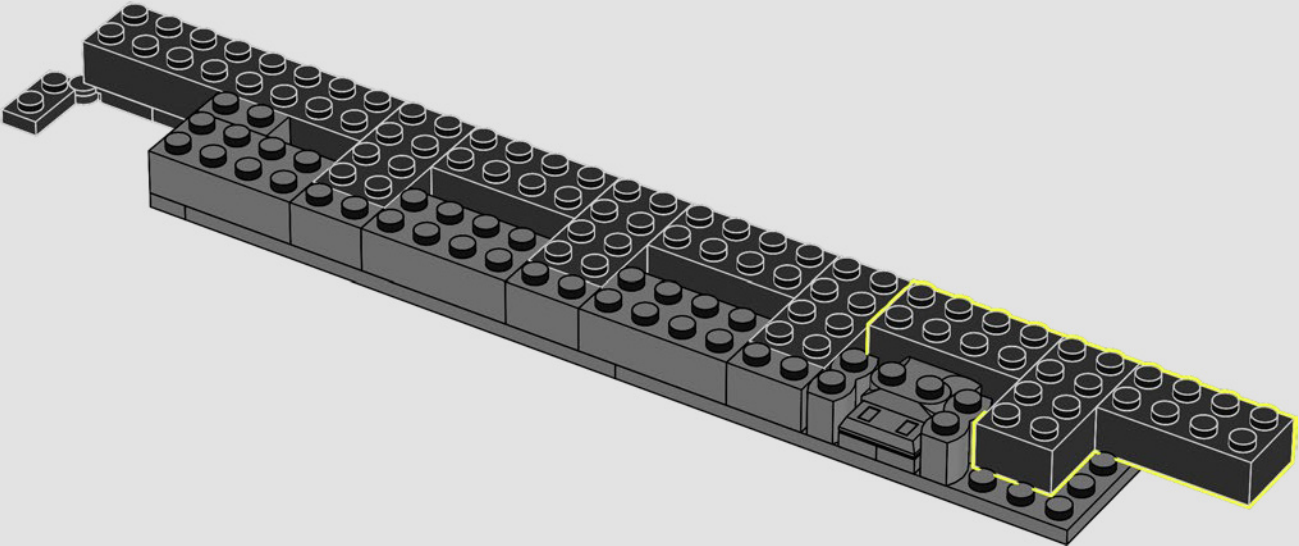

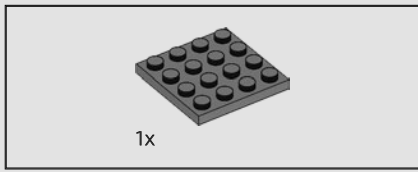

177

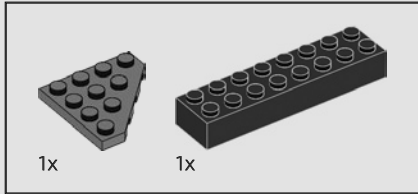
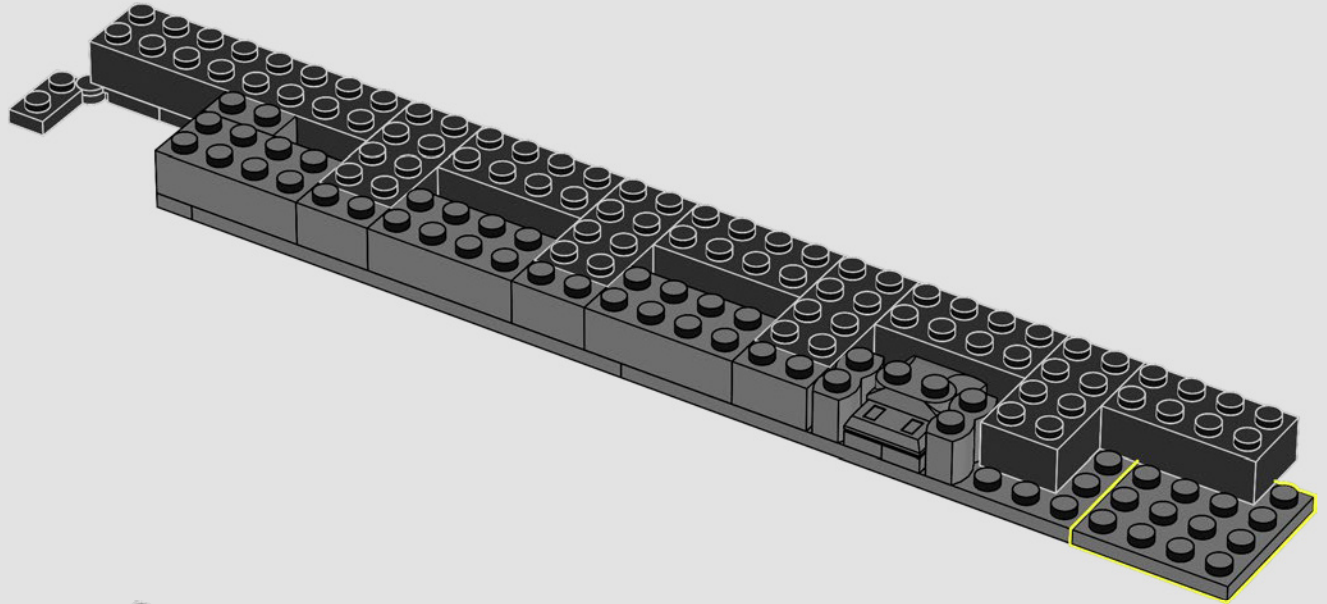

178

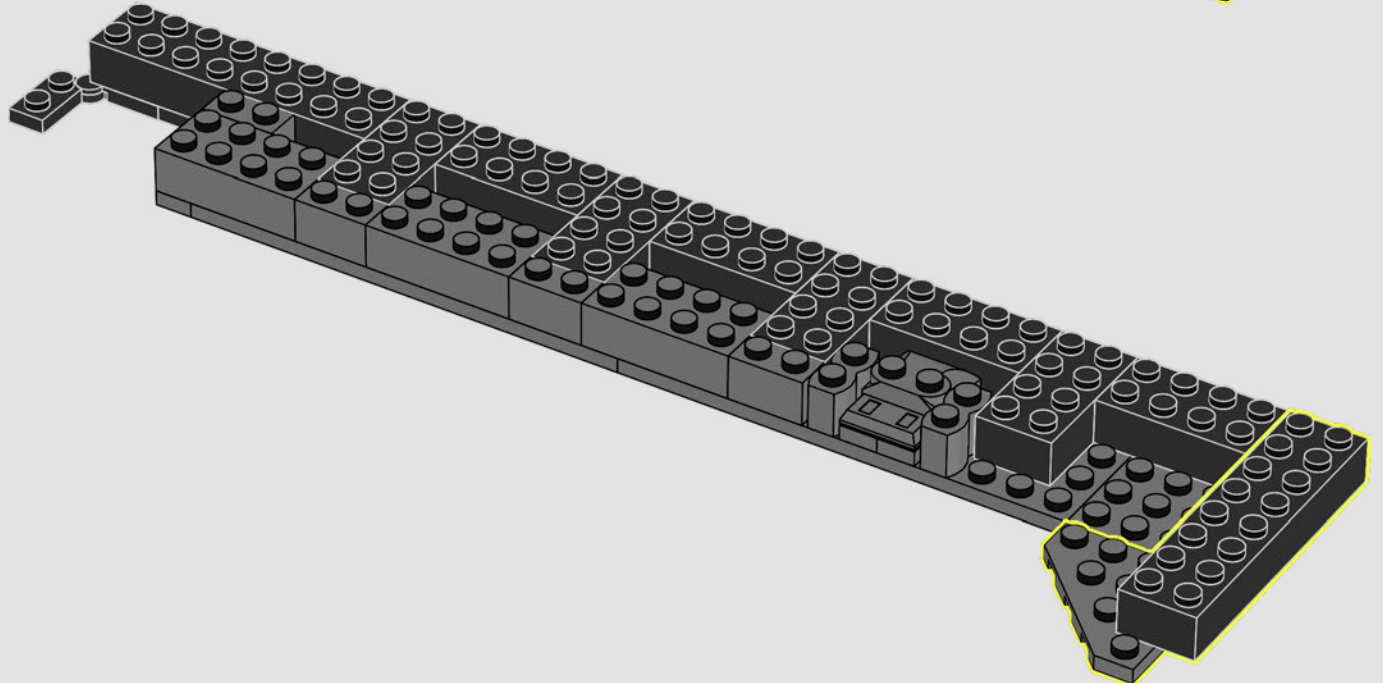



179

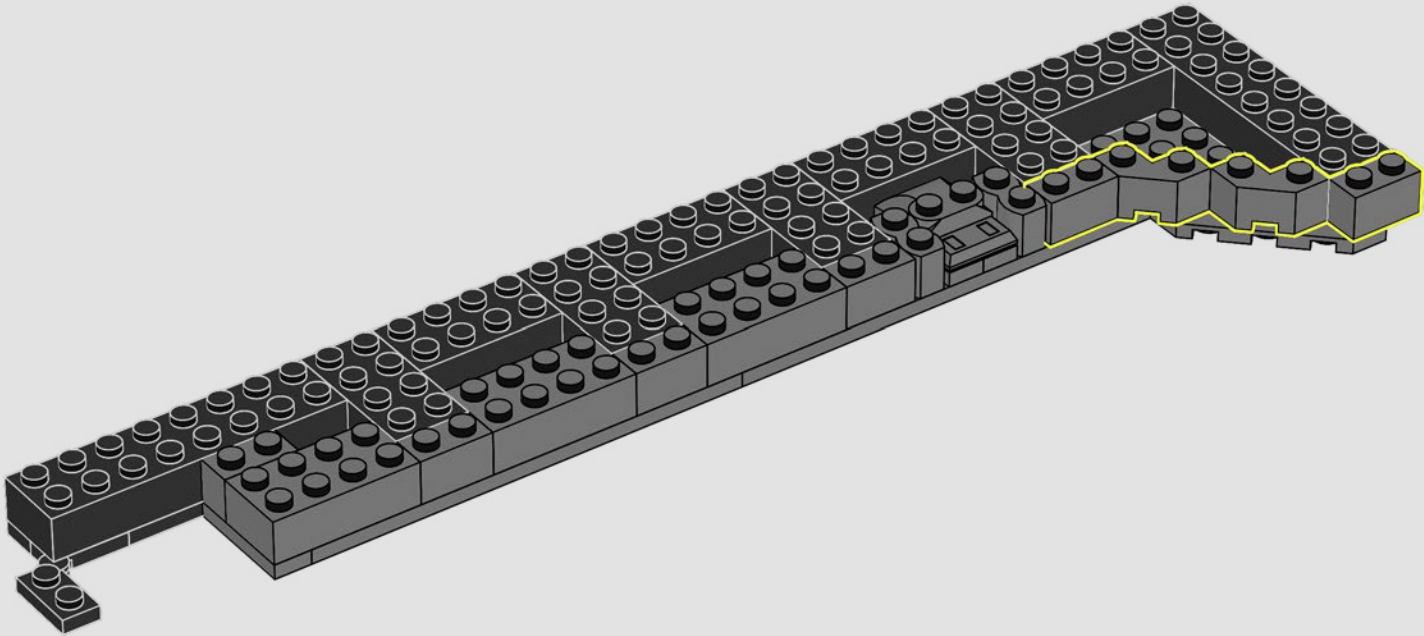

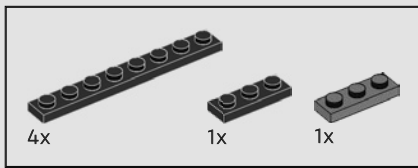

180

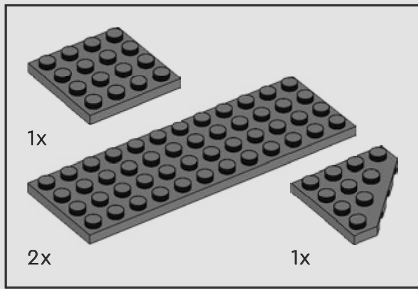
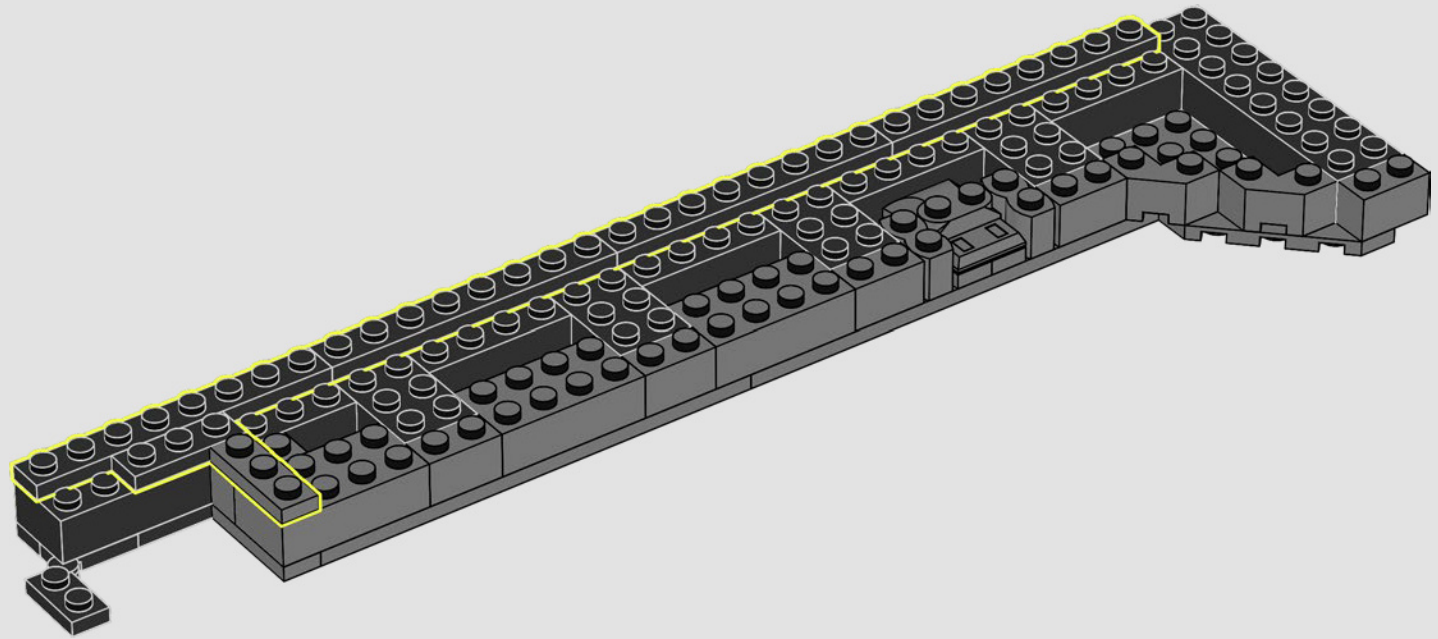

181

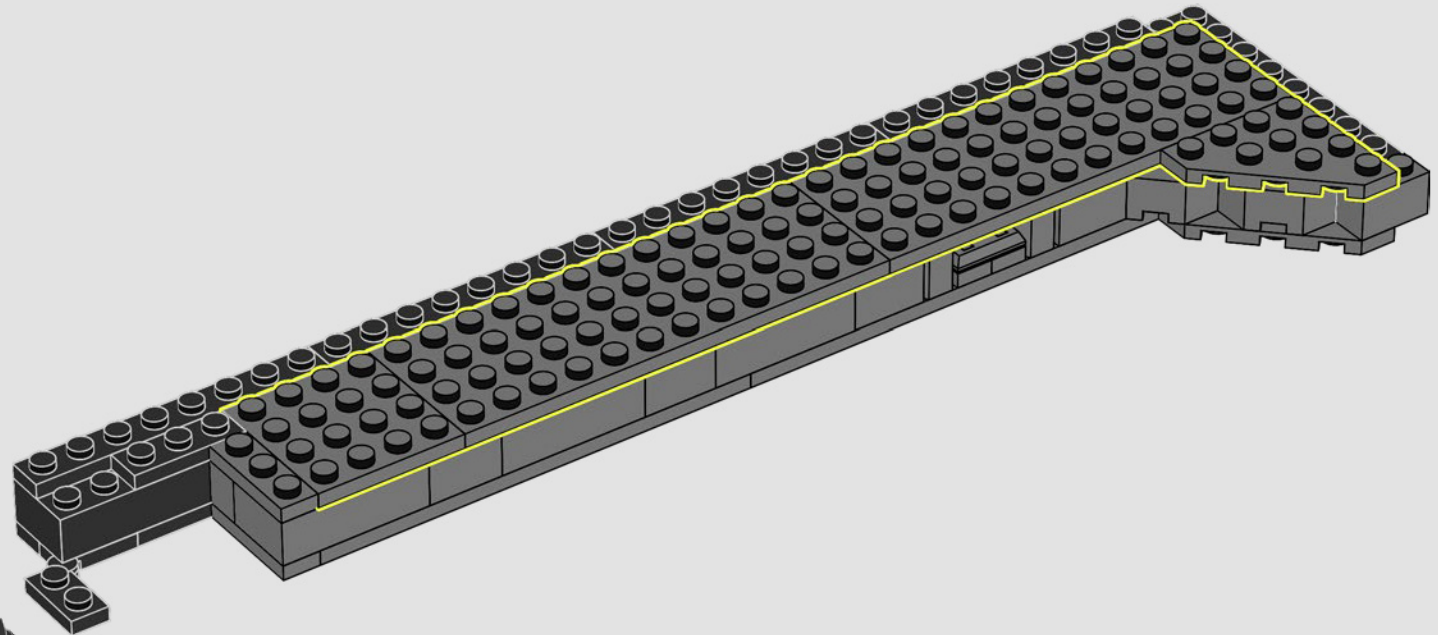

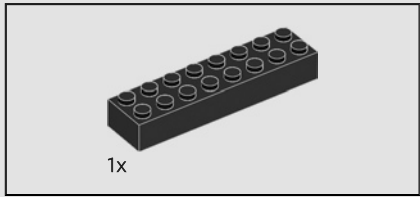
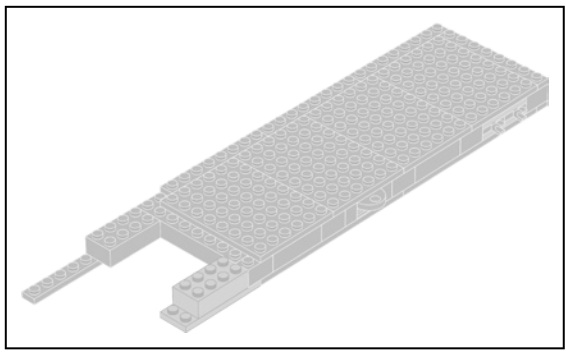

182

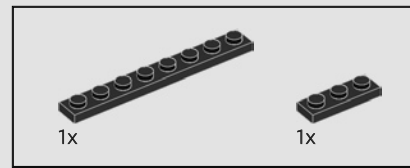
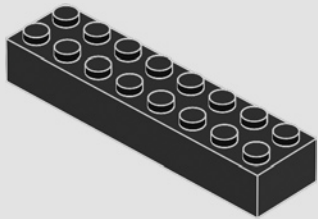

183

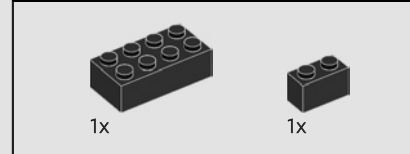
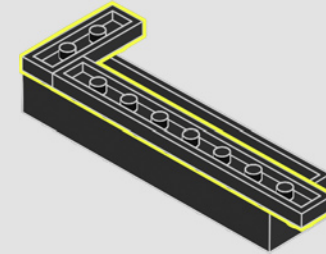
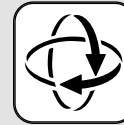

184

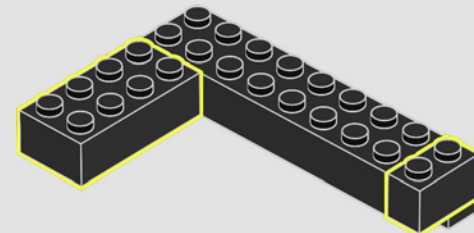
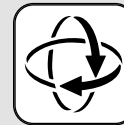

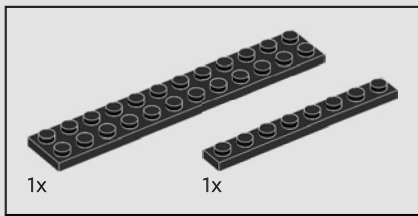

185

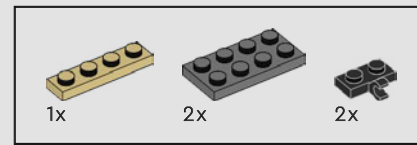
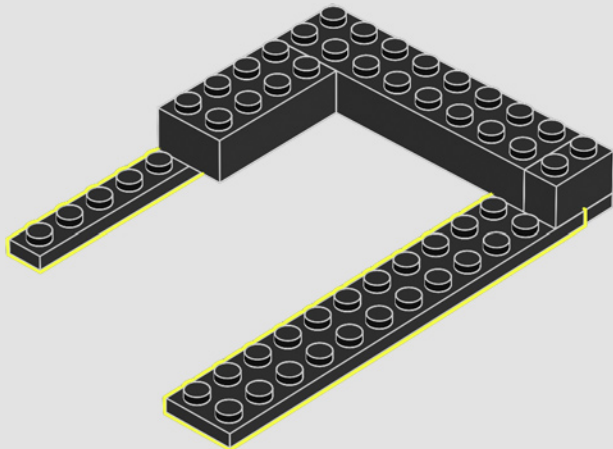

186

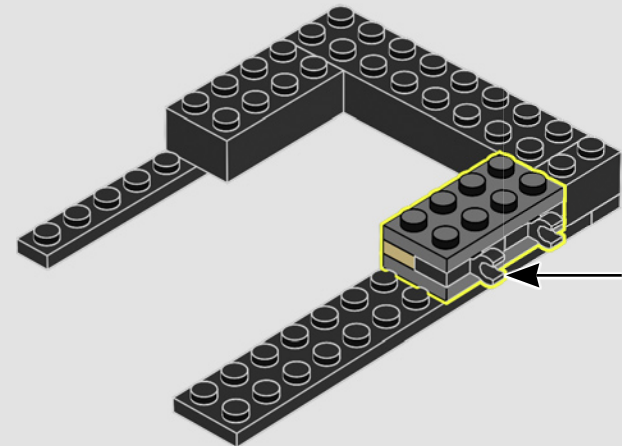
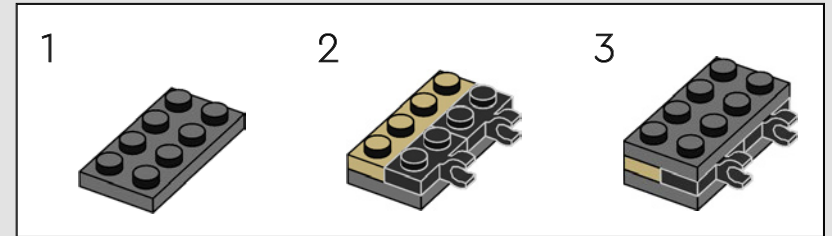

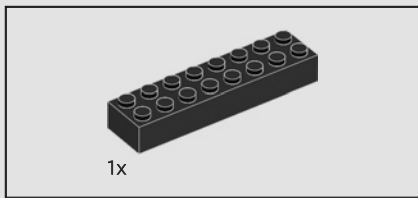

187

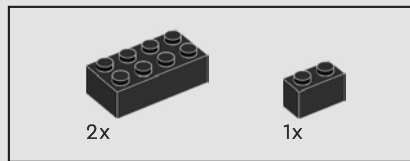
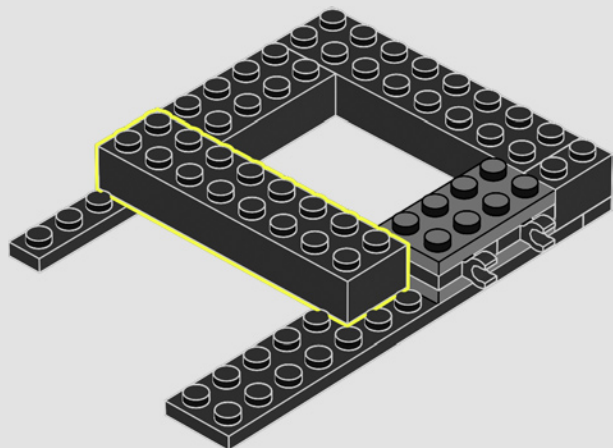

188

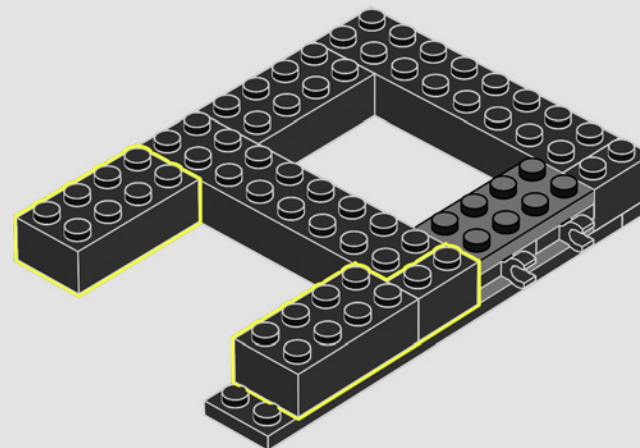



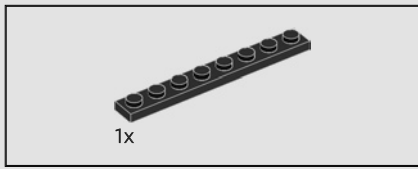

189

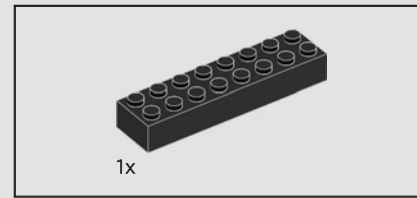
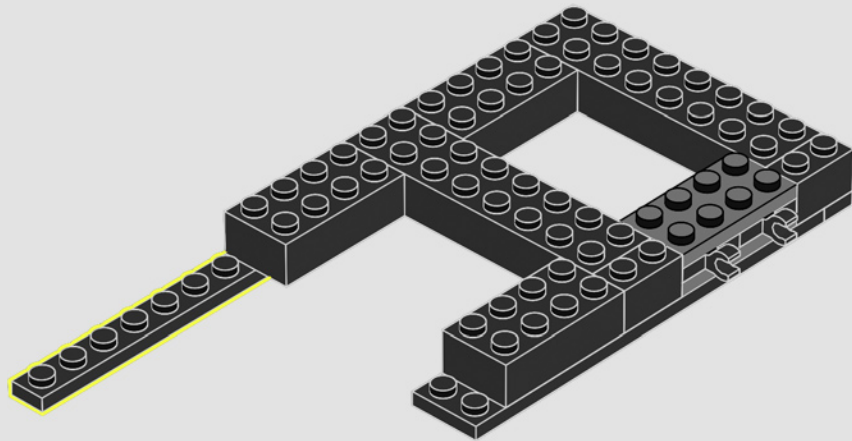

190

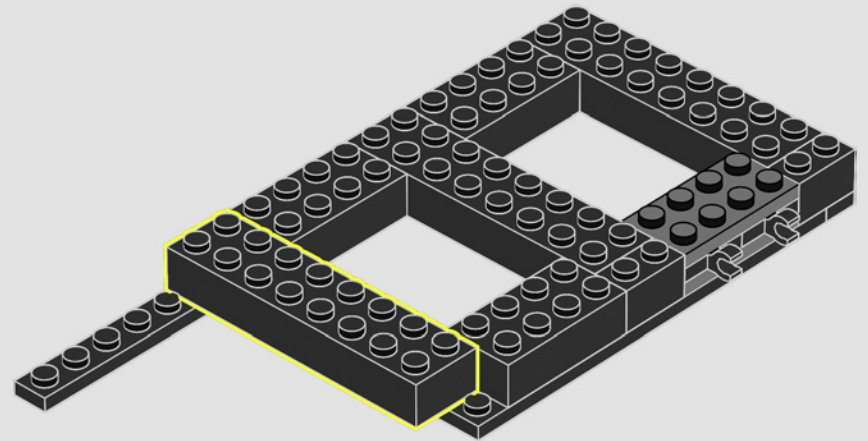

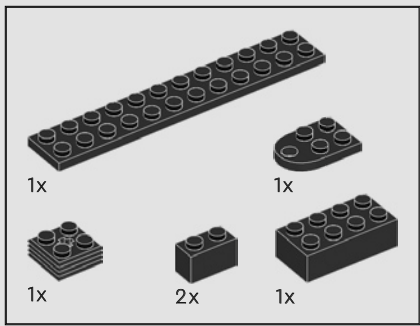

191

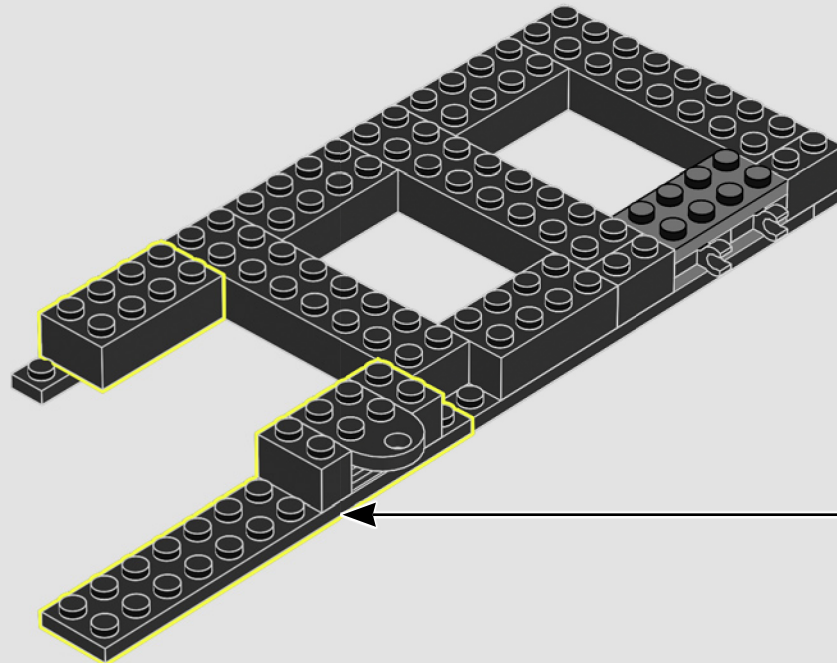
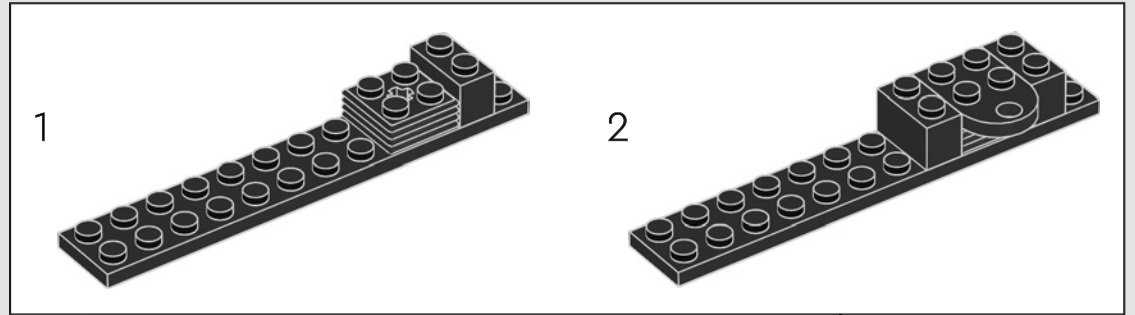

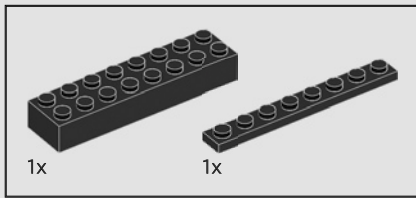

192

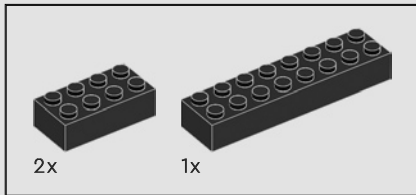
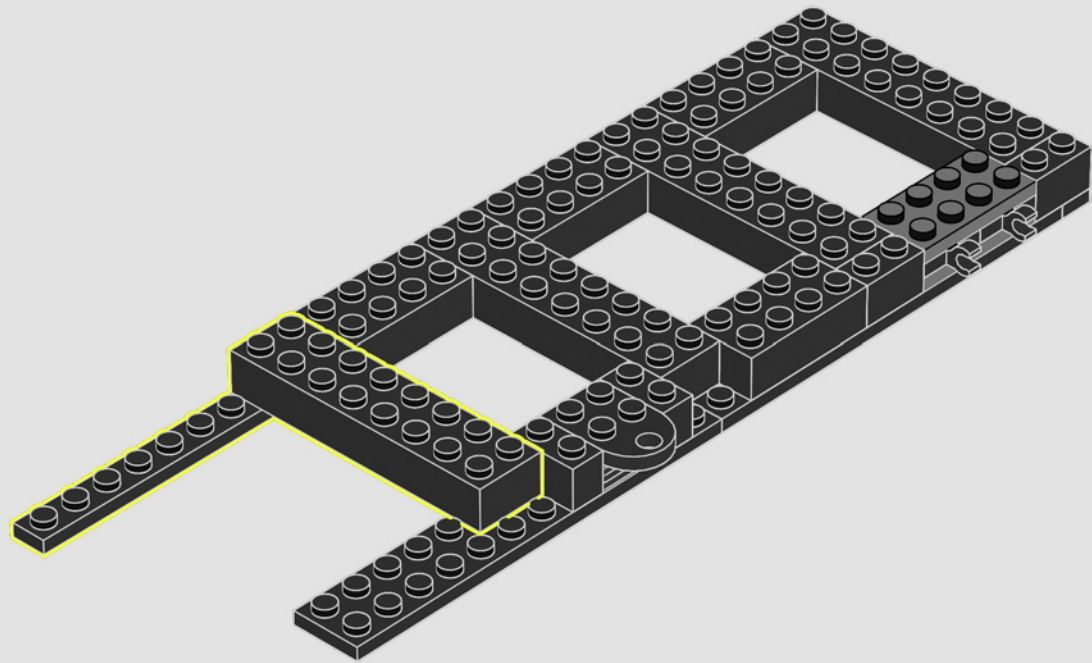

193

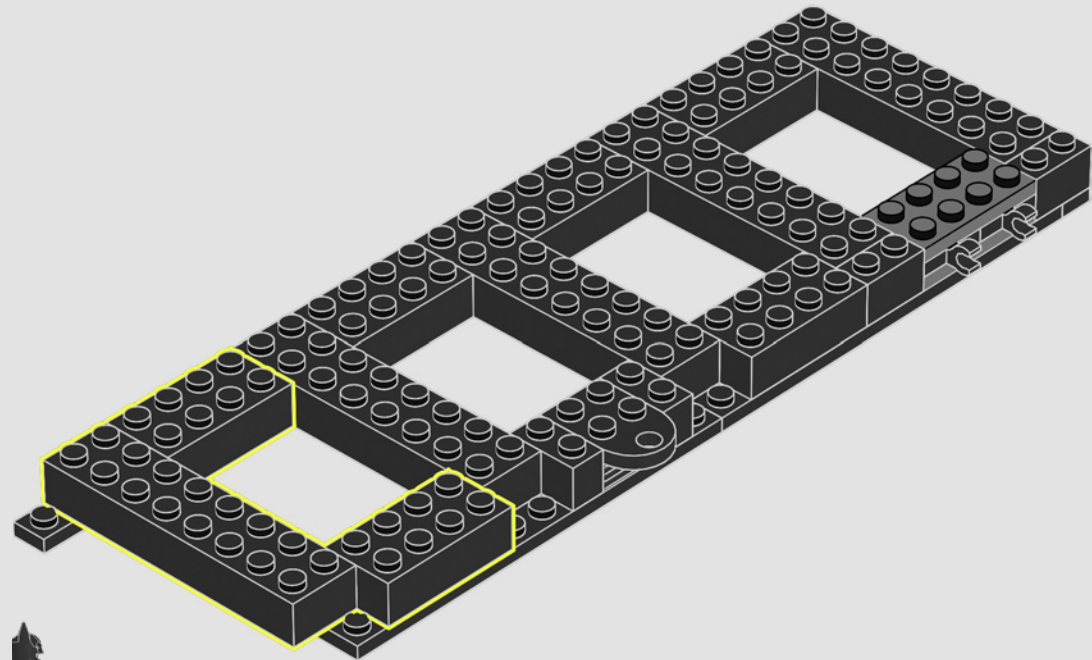

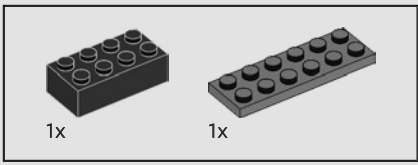

194

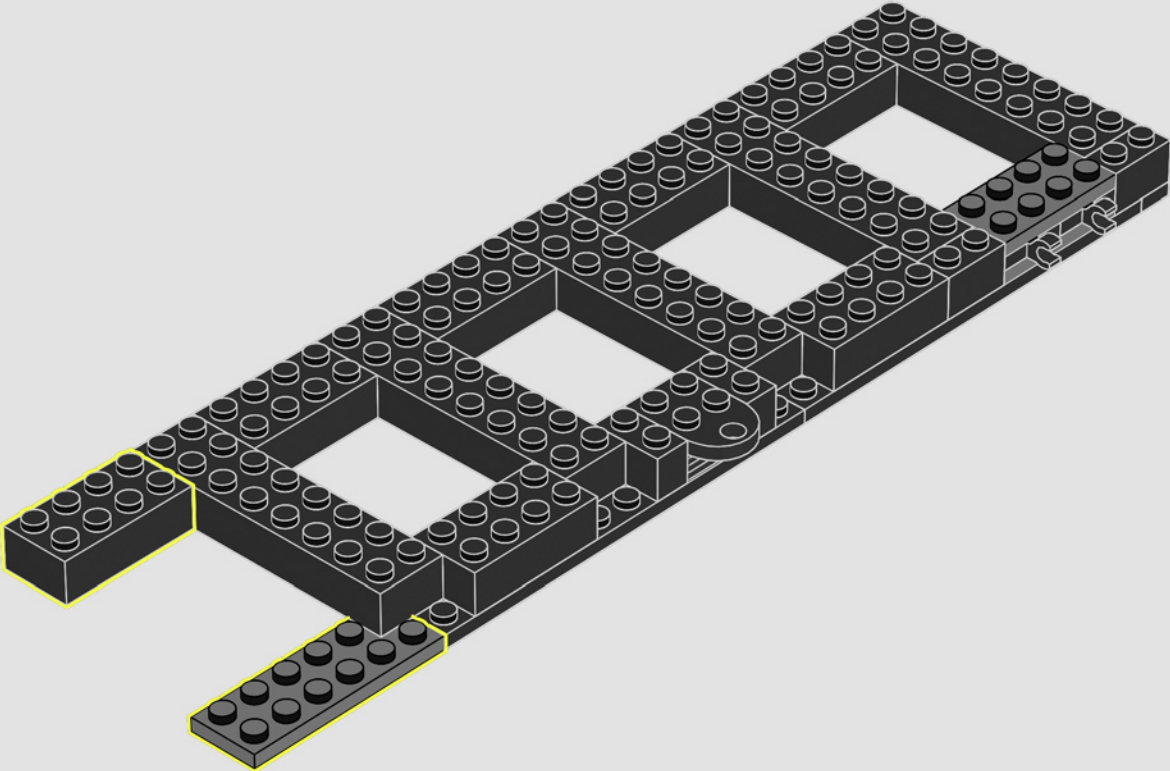

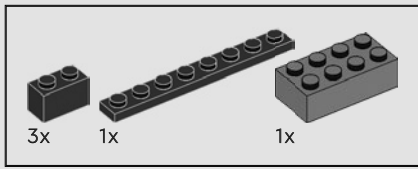

195

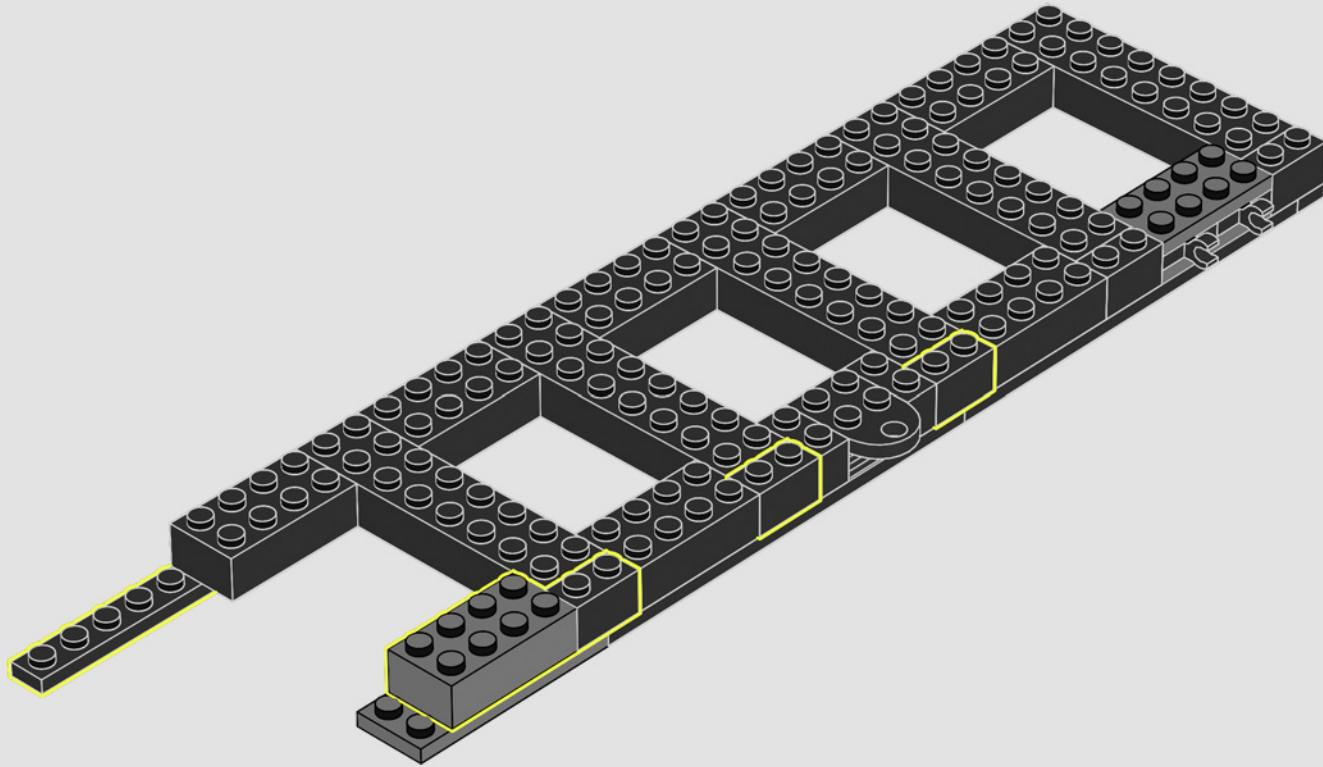

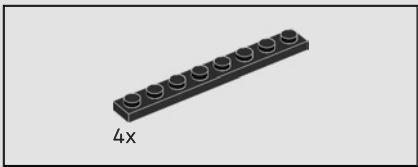

196

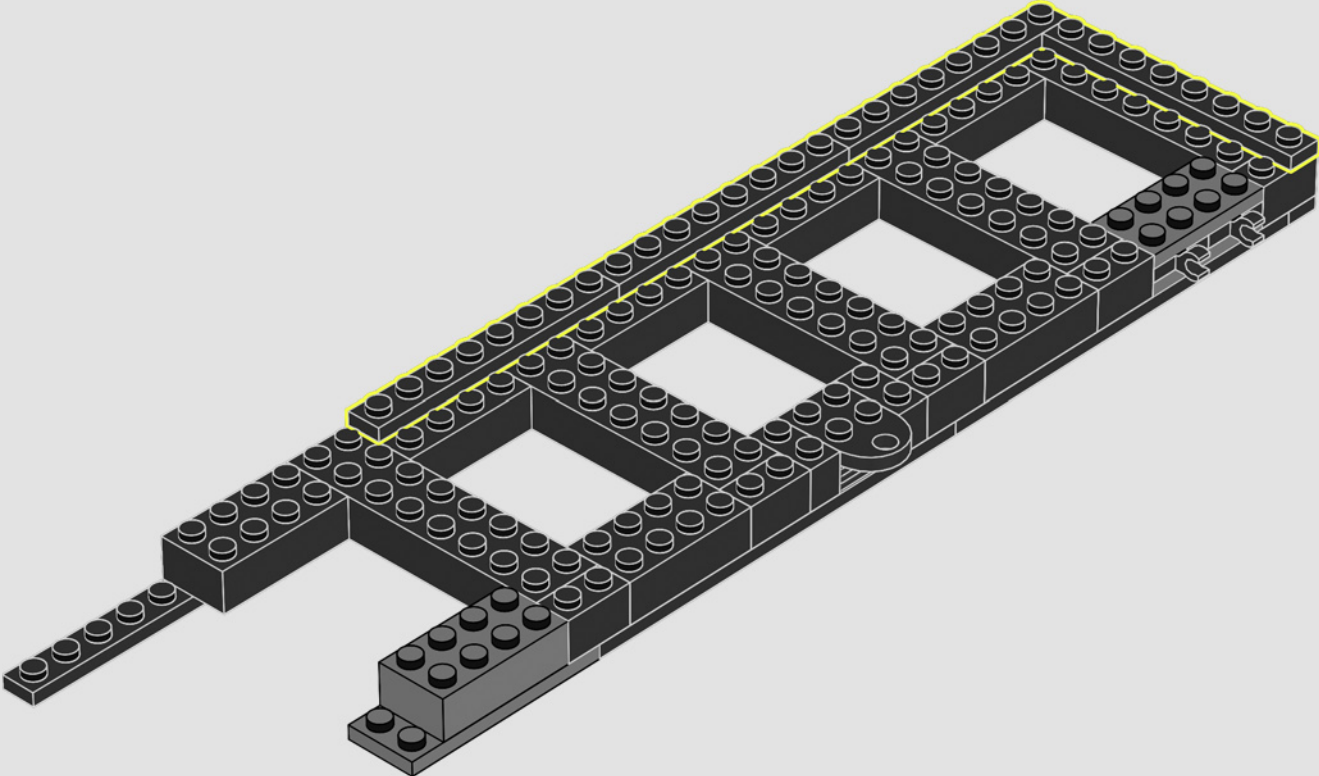

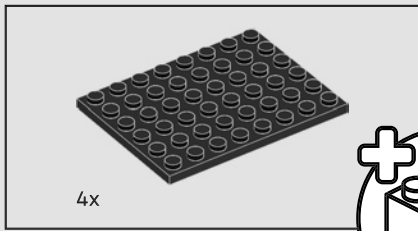

4x

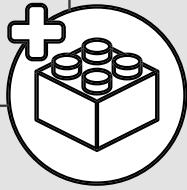

197

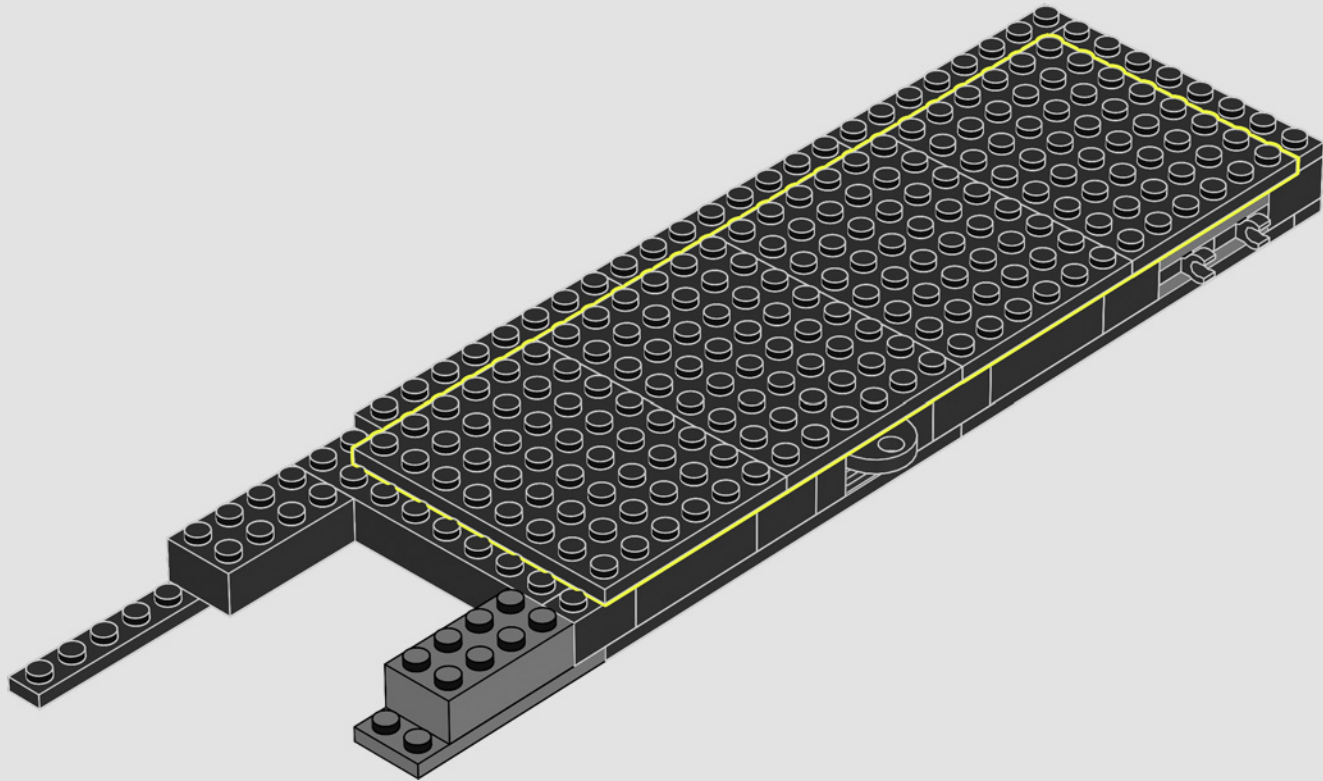

198

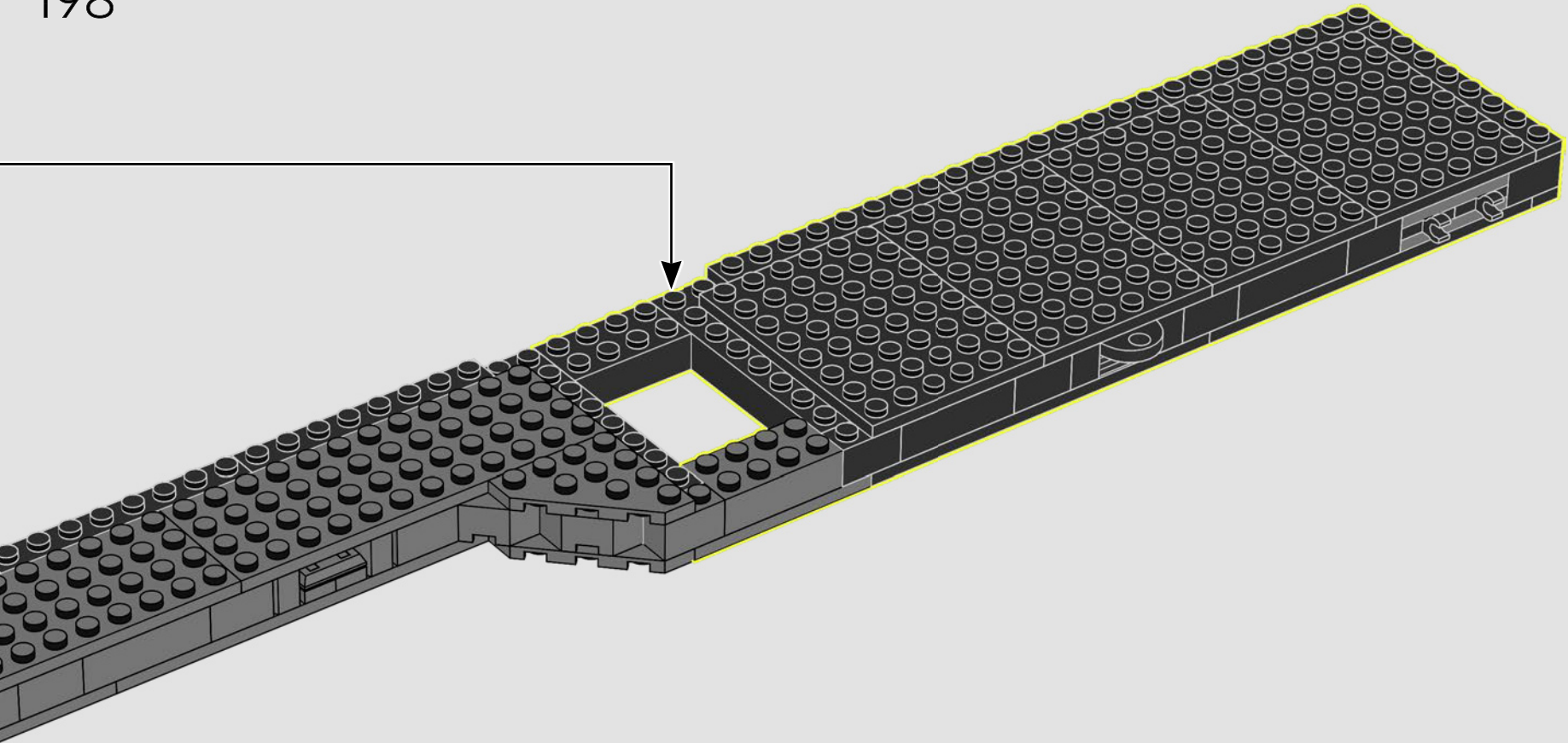



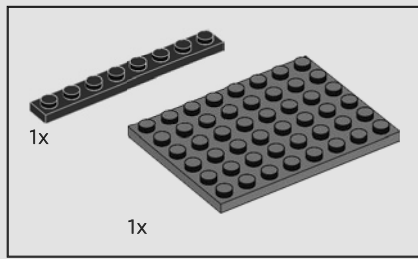

199

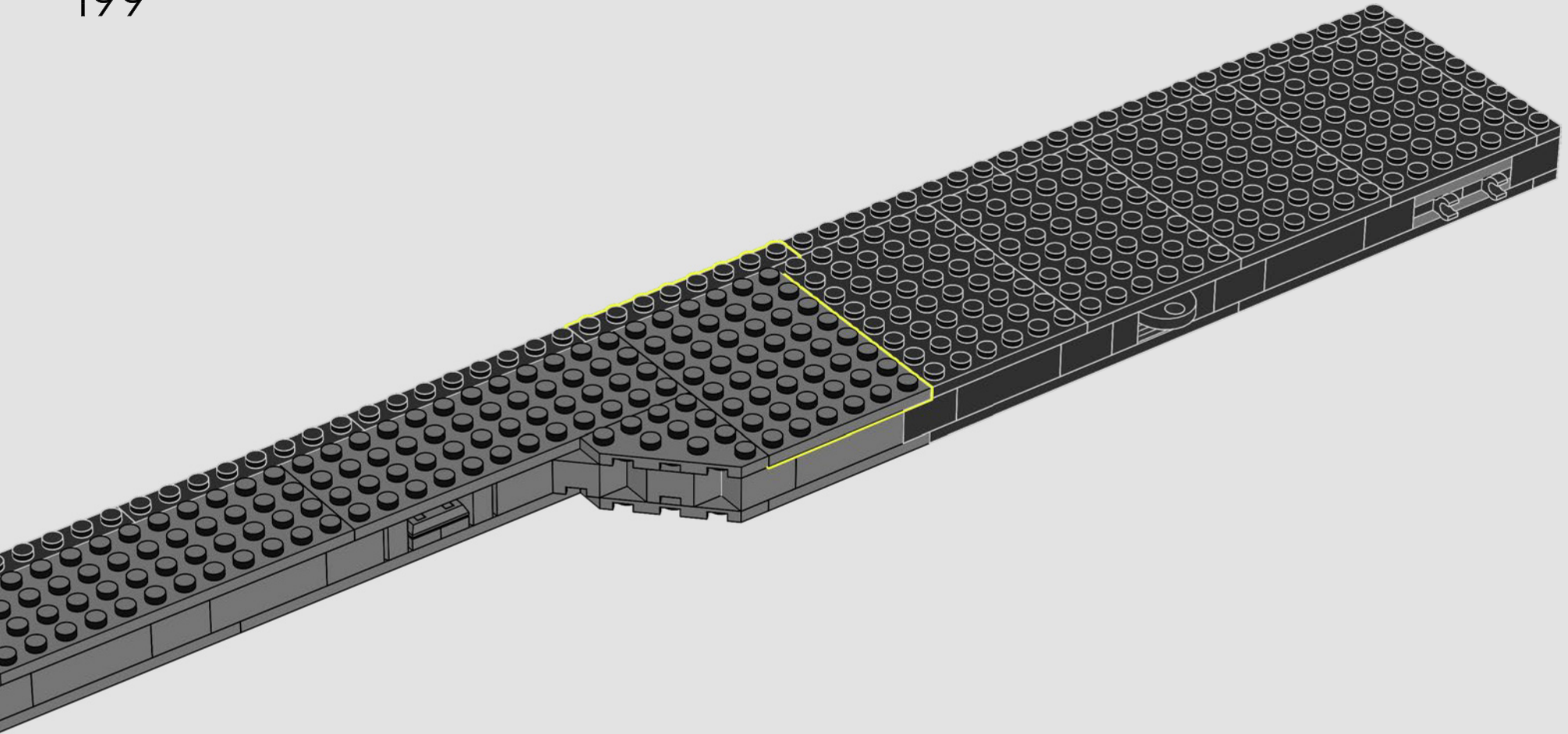

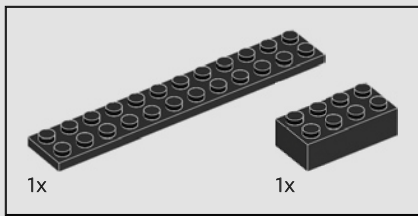

200

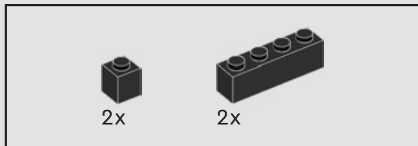
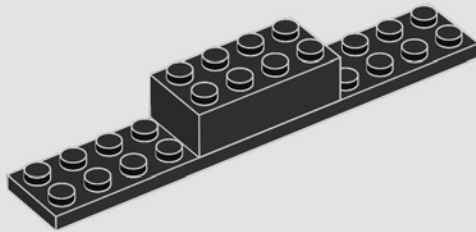

201

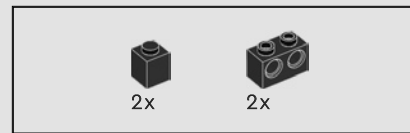
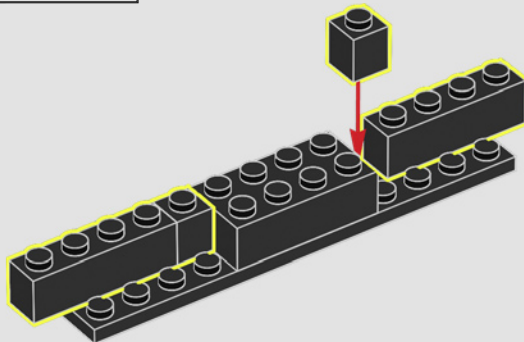

202

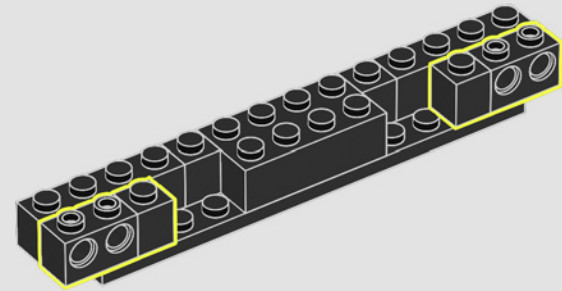

203

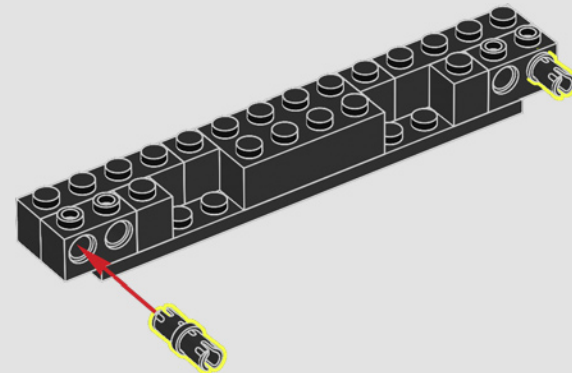

204

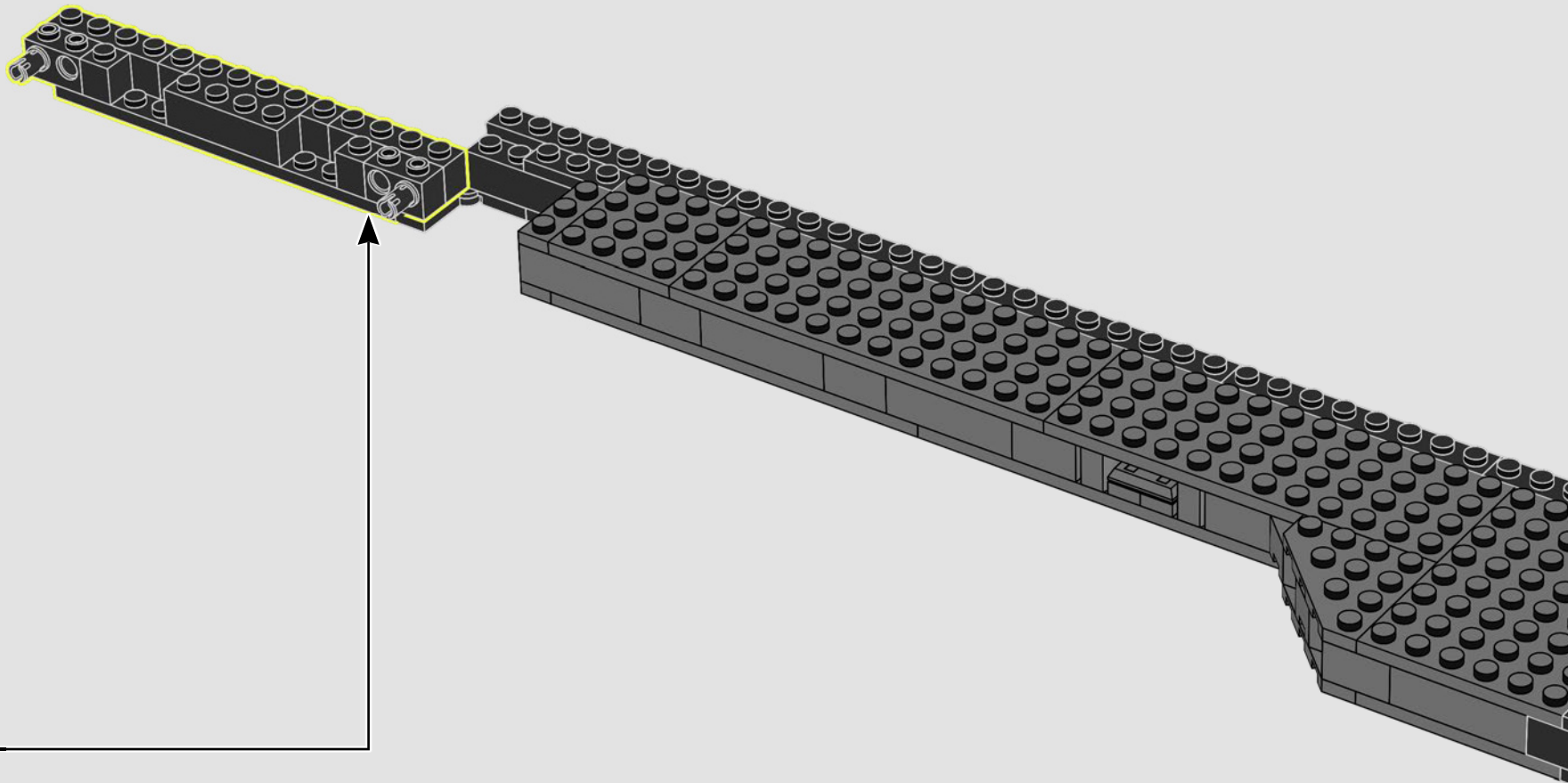

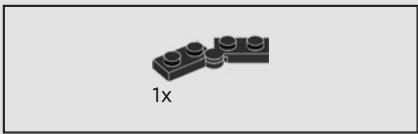

205

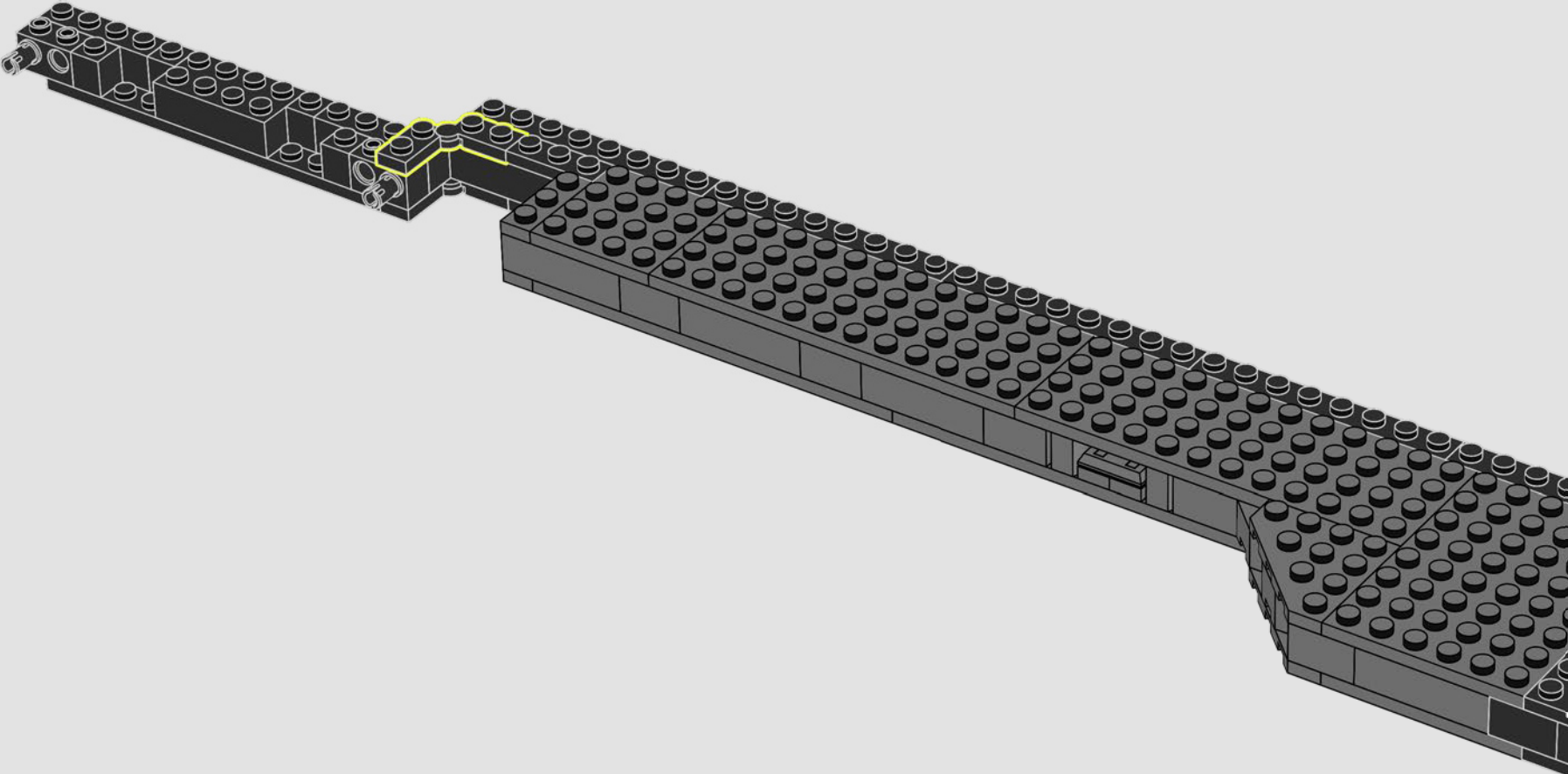

206

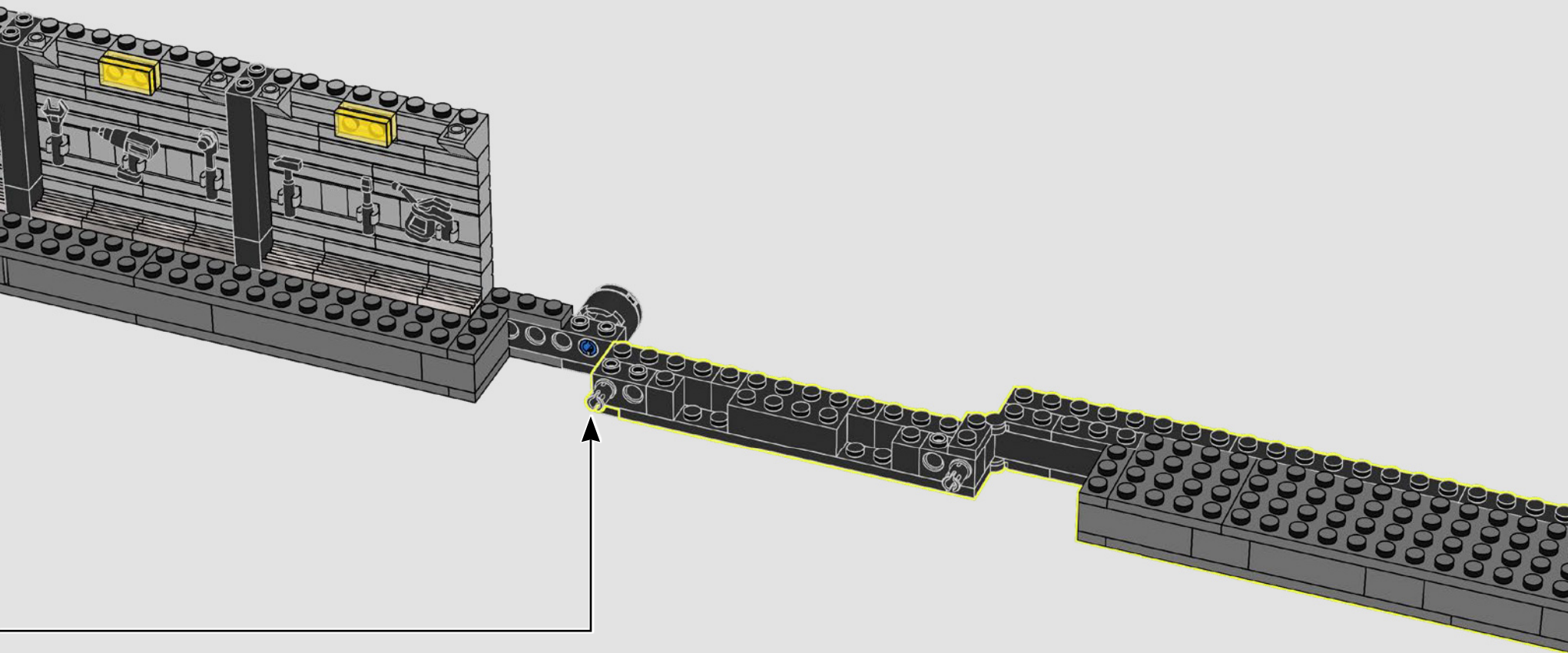

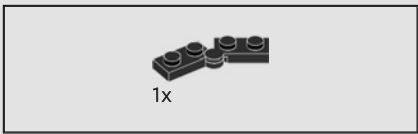

207

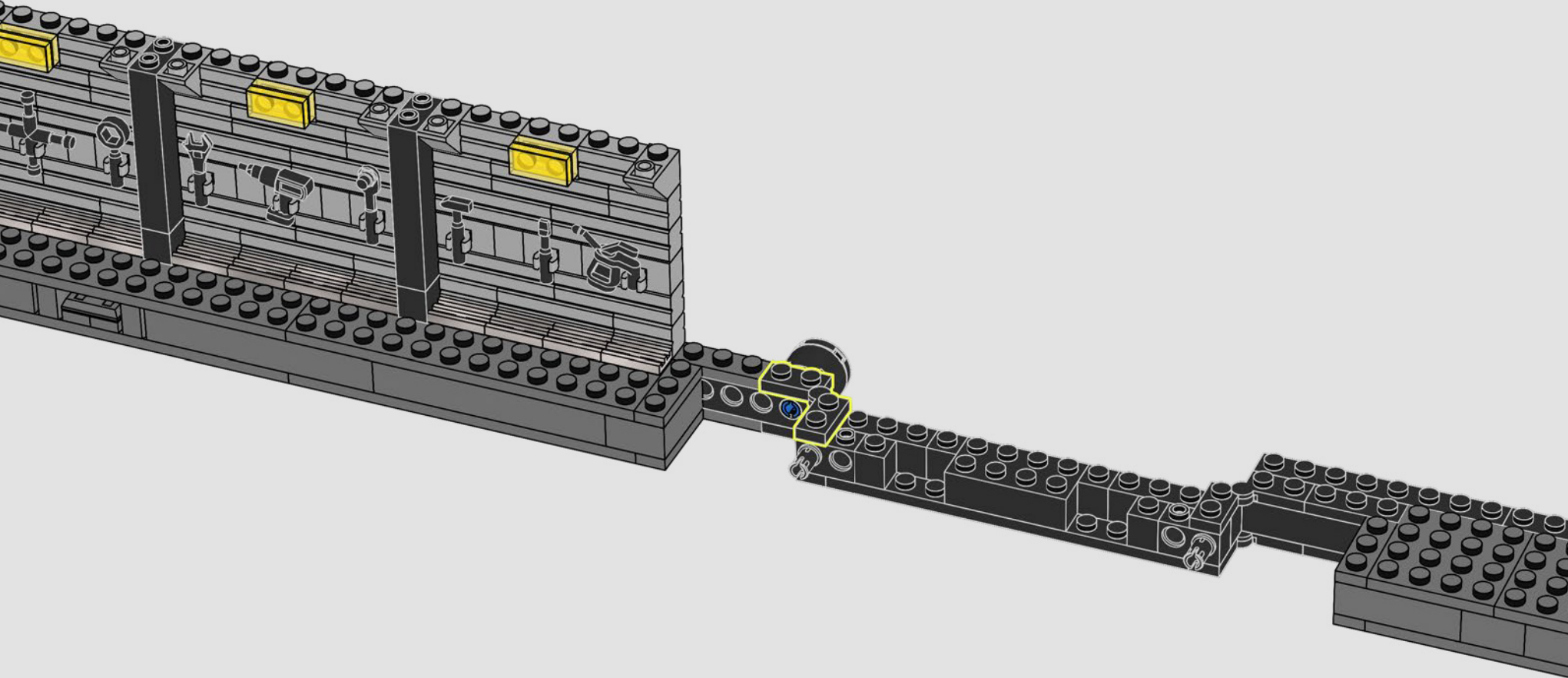



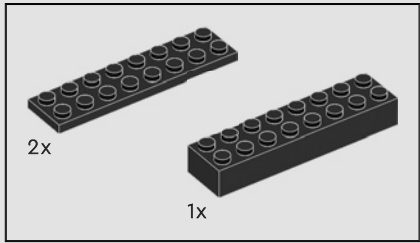
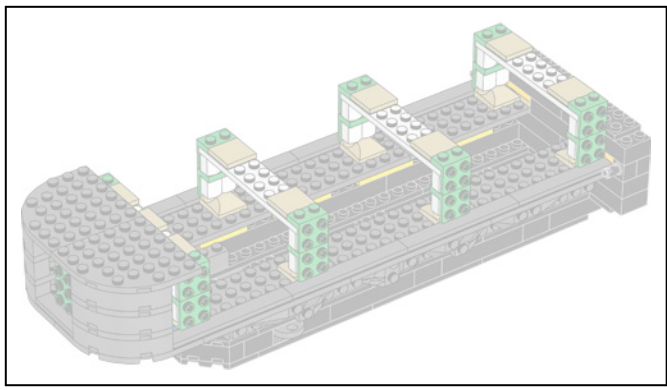

208

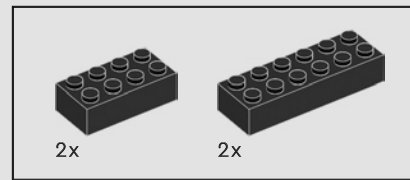
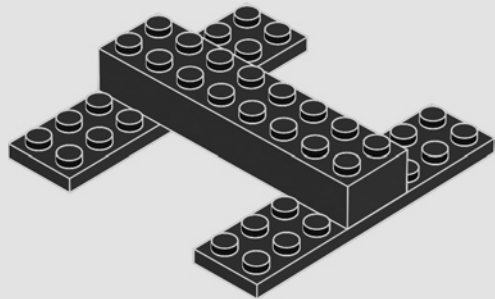

209

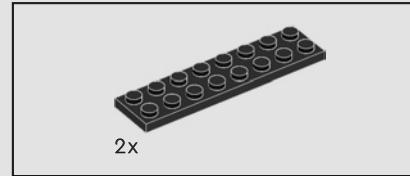
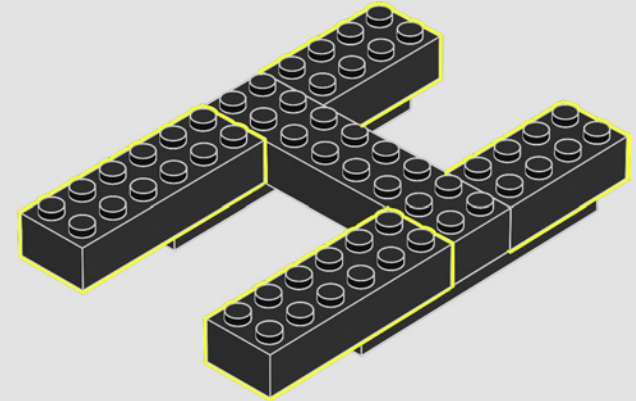

210

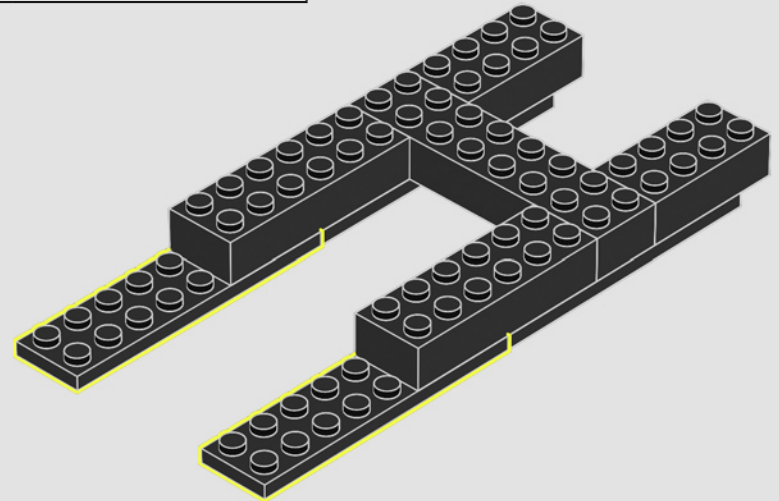



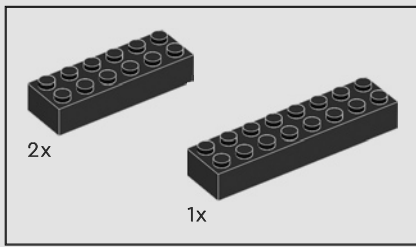

211

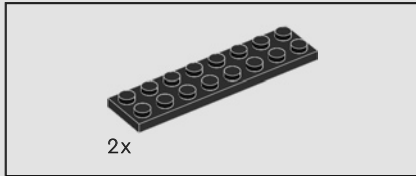
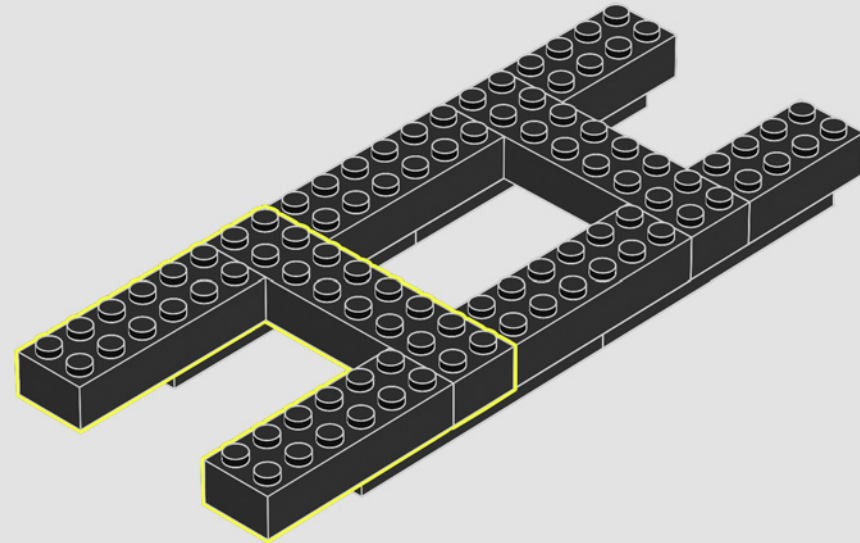

212

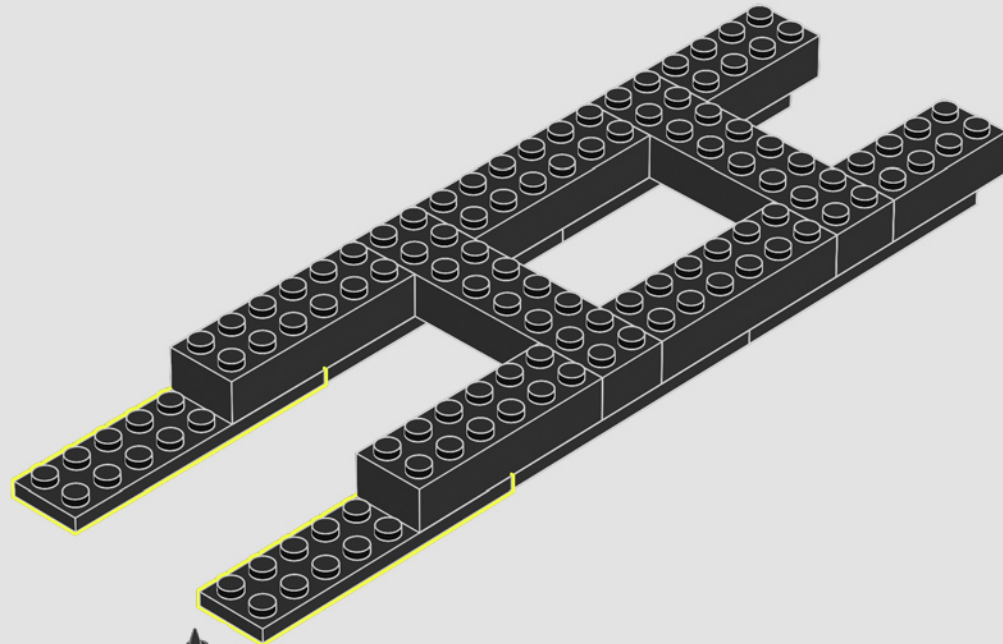

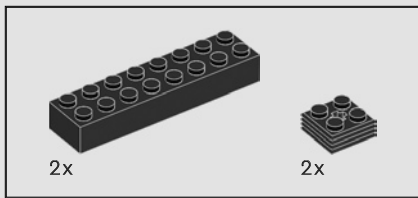

213

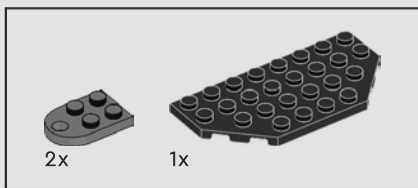
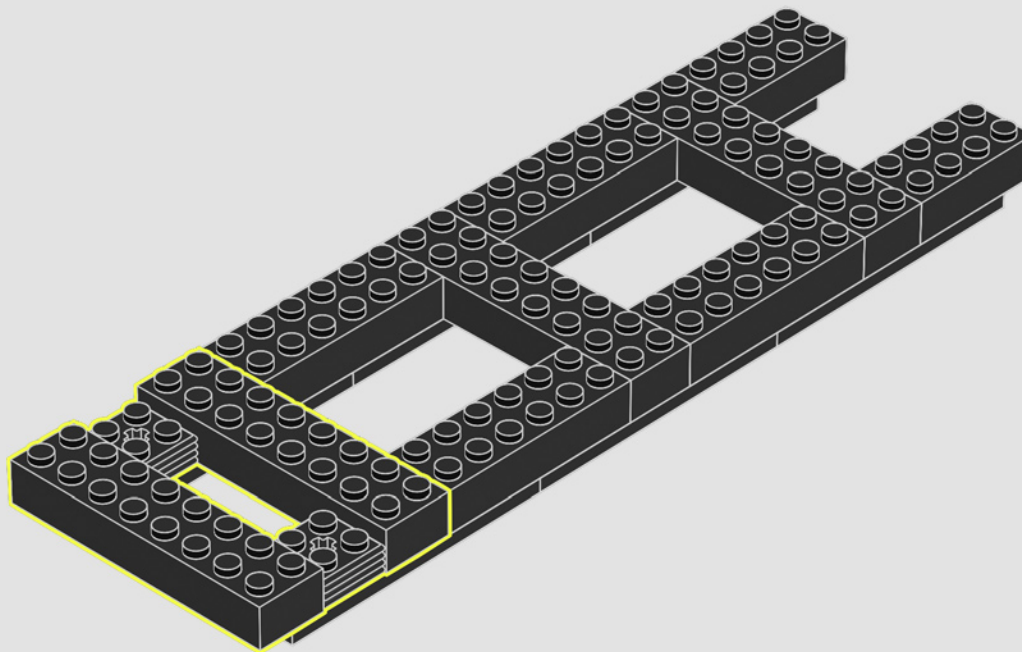

214

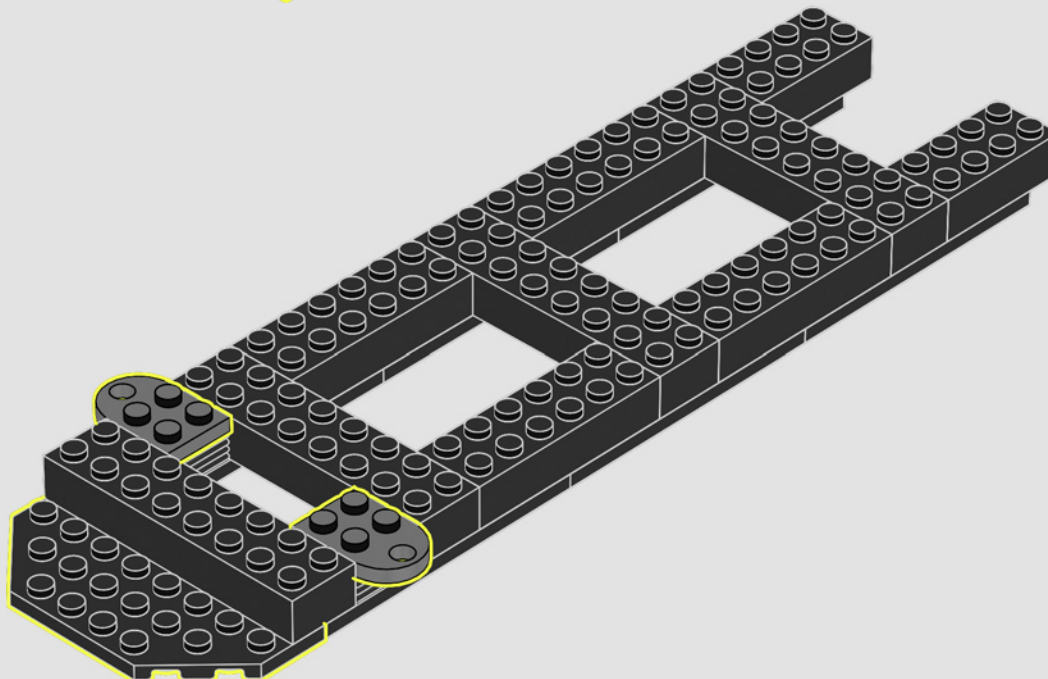

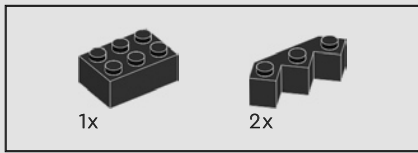

215

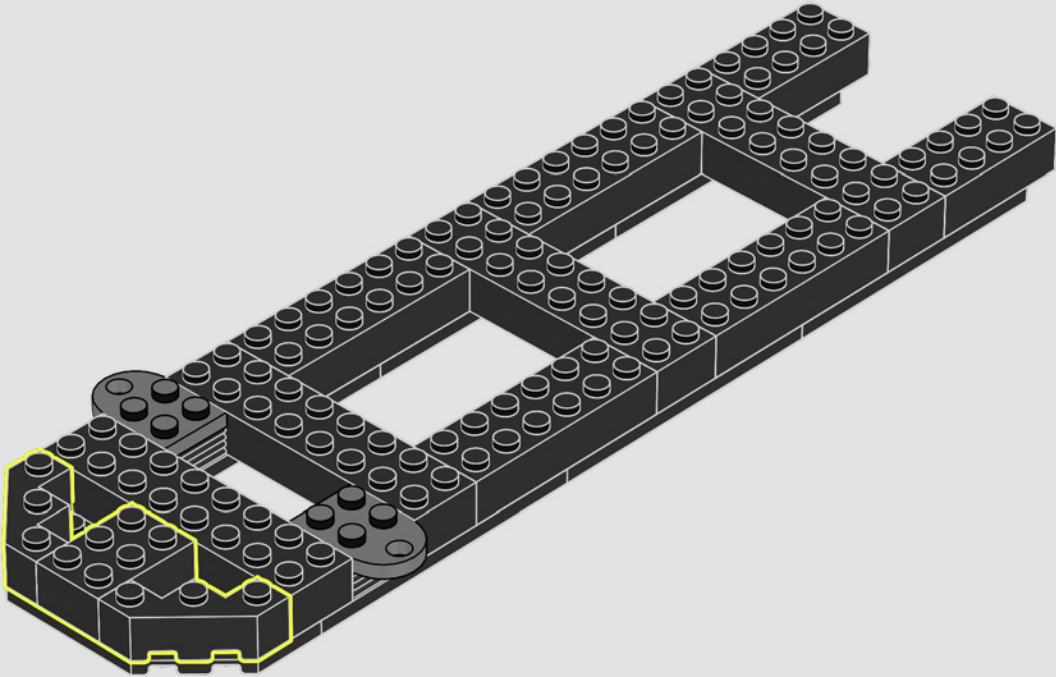

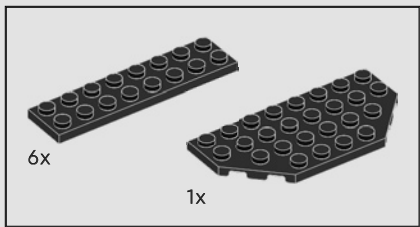

216

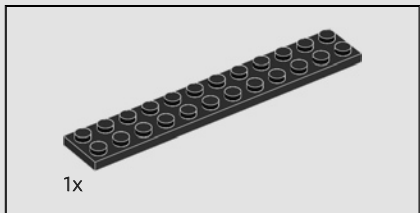
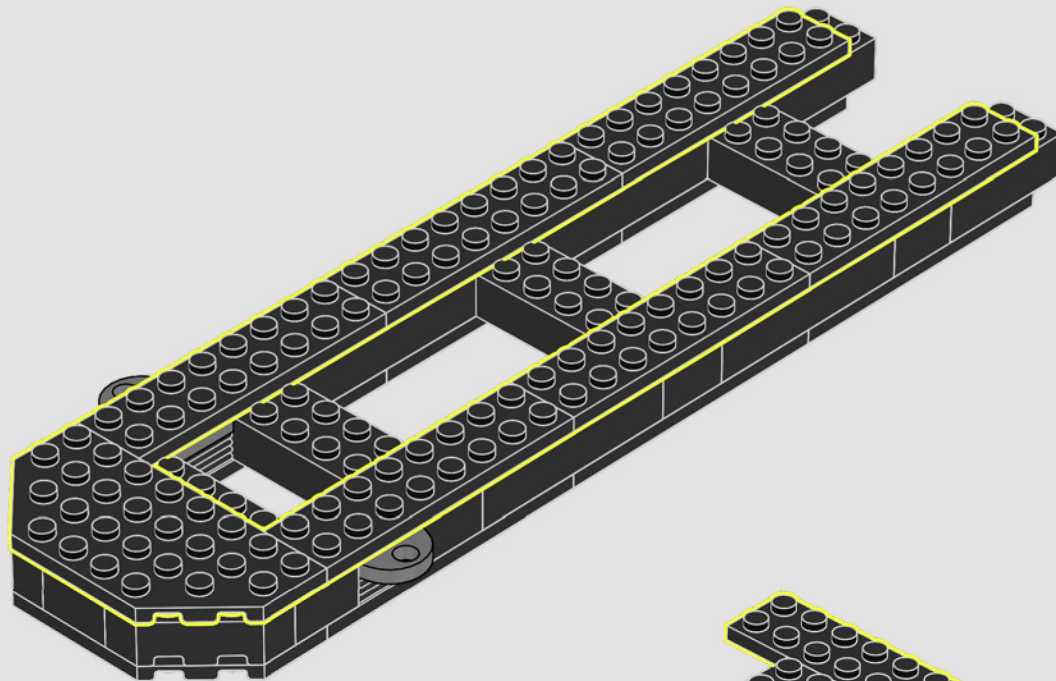

217

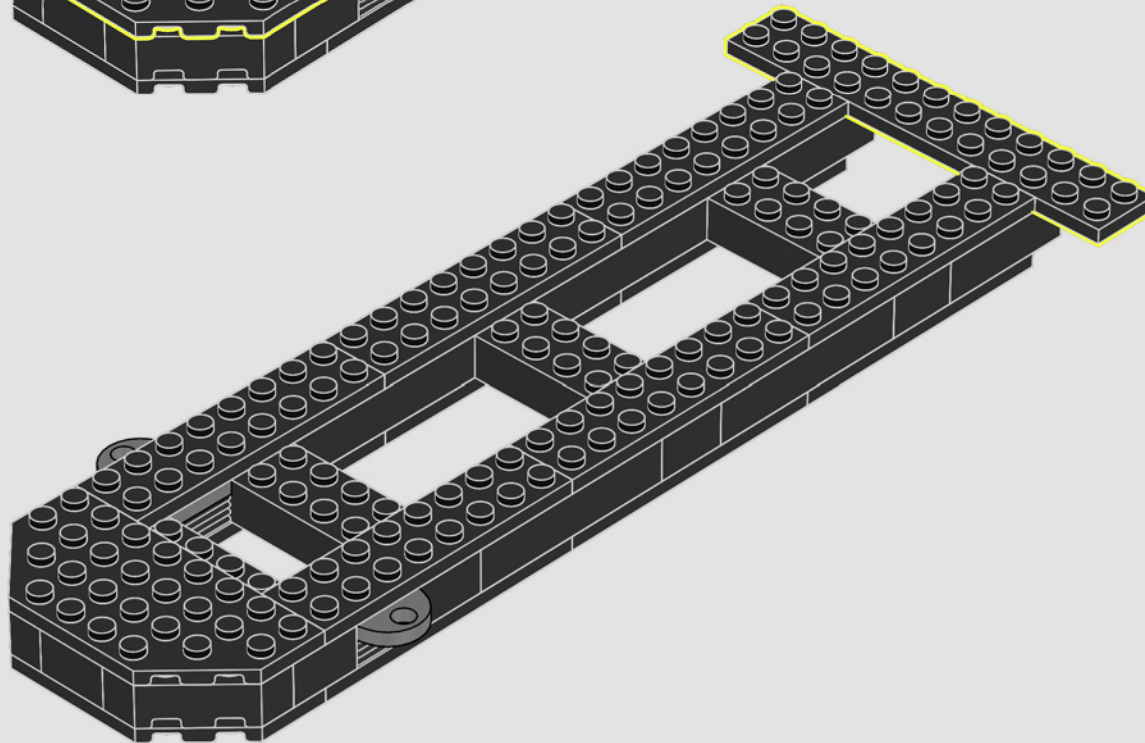

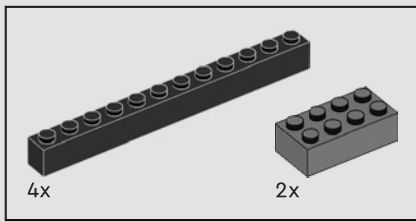

218

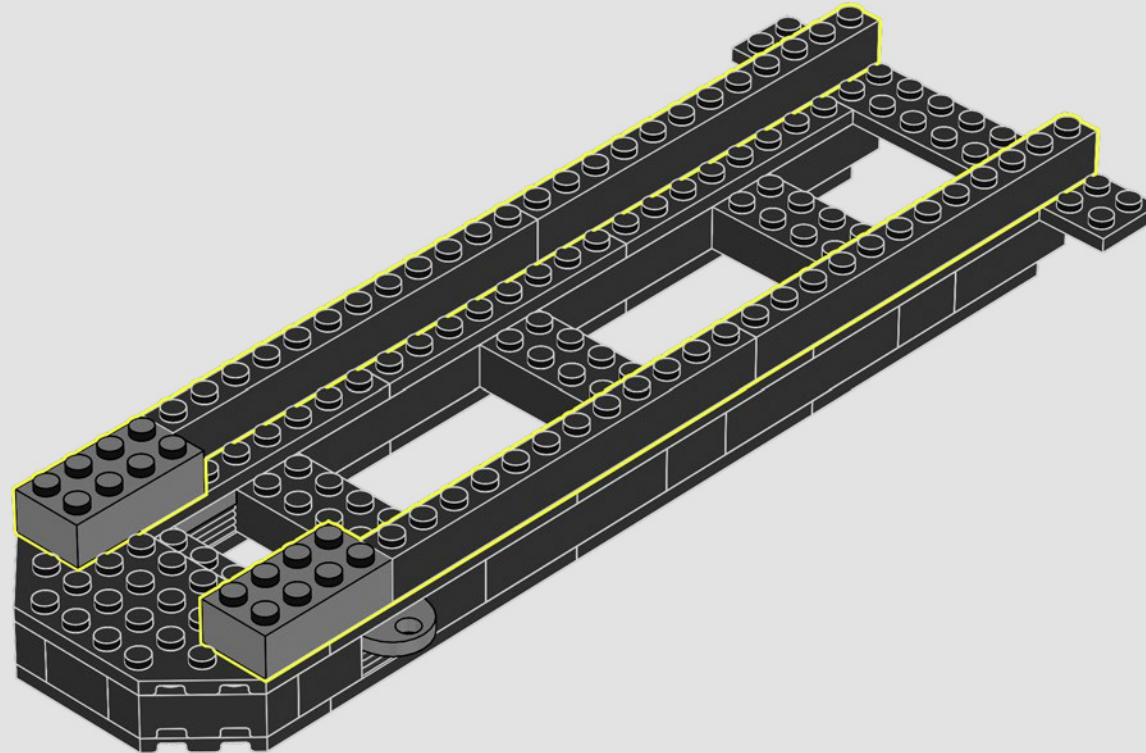

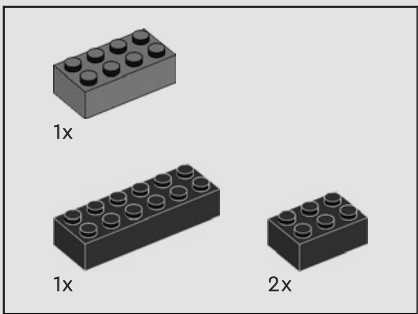

219

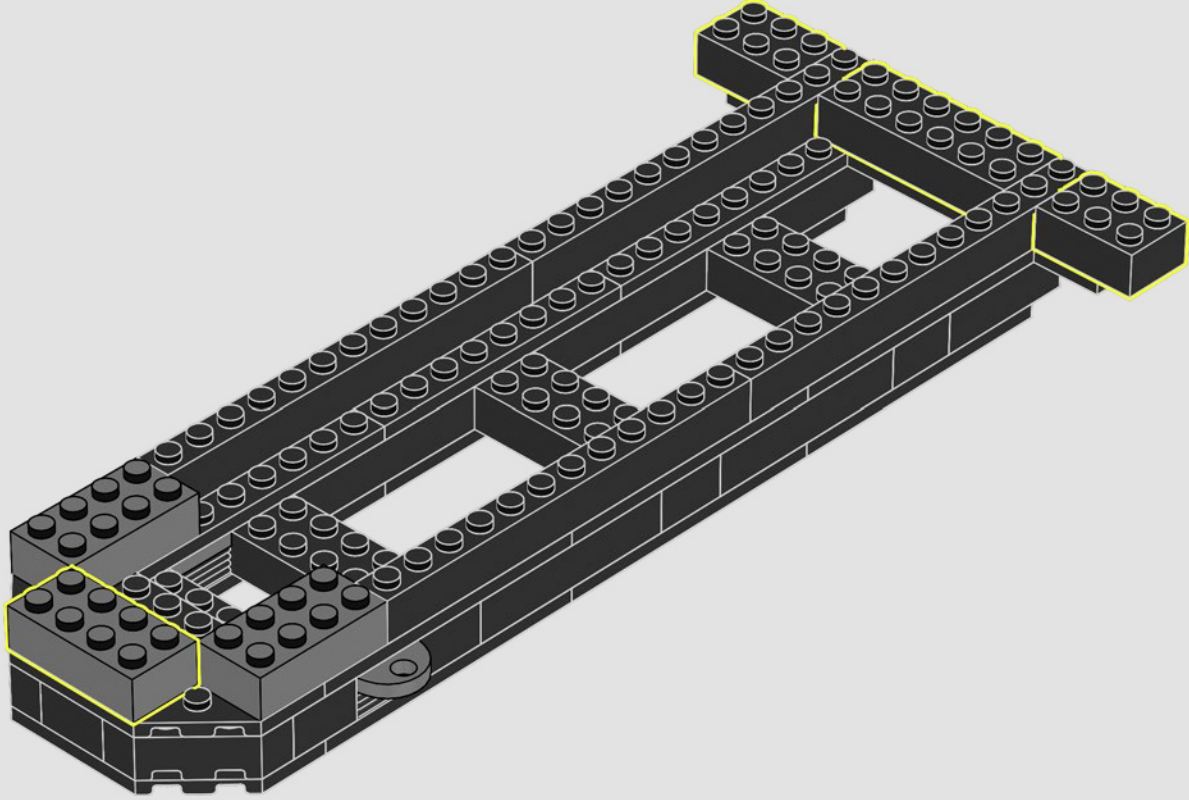

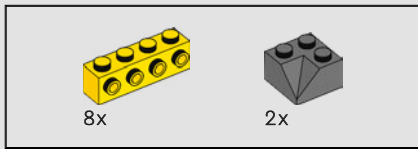

220

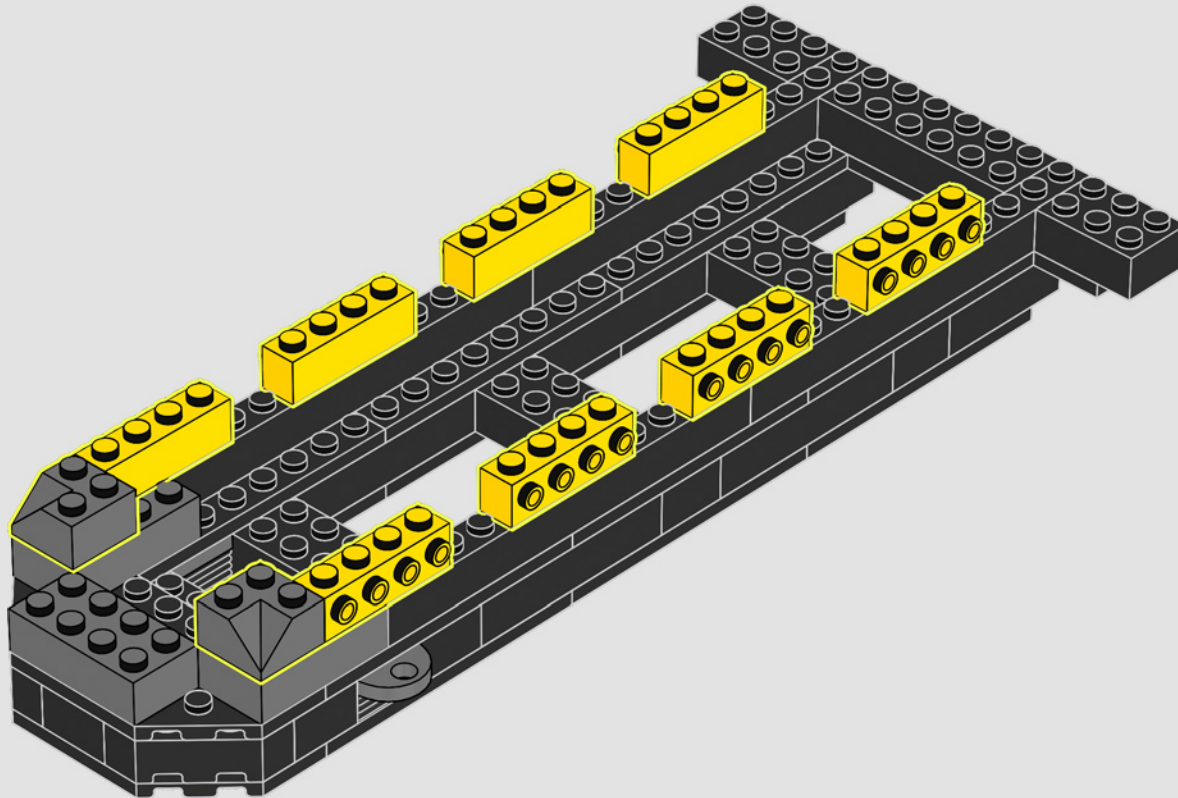

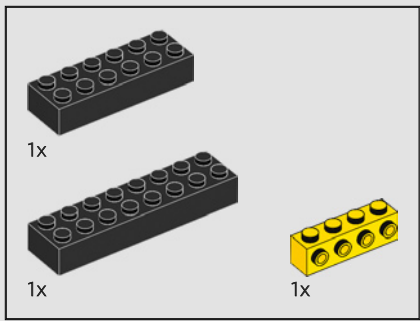

221

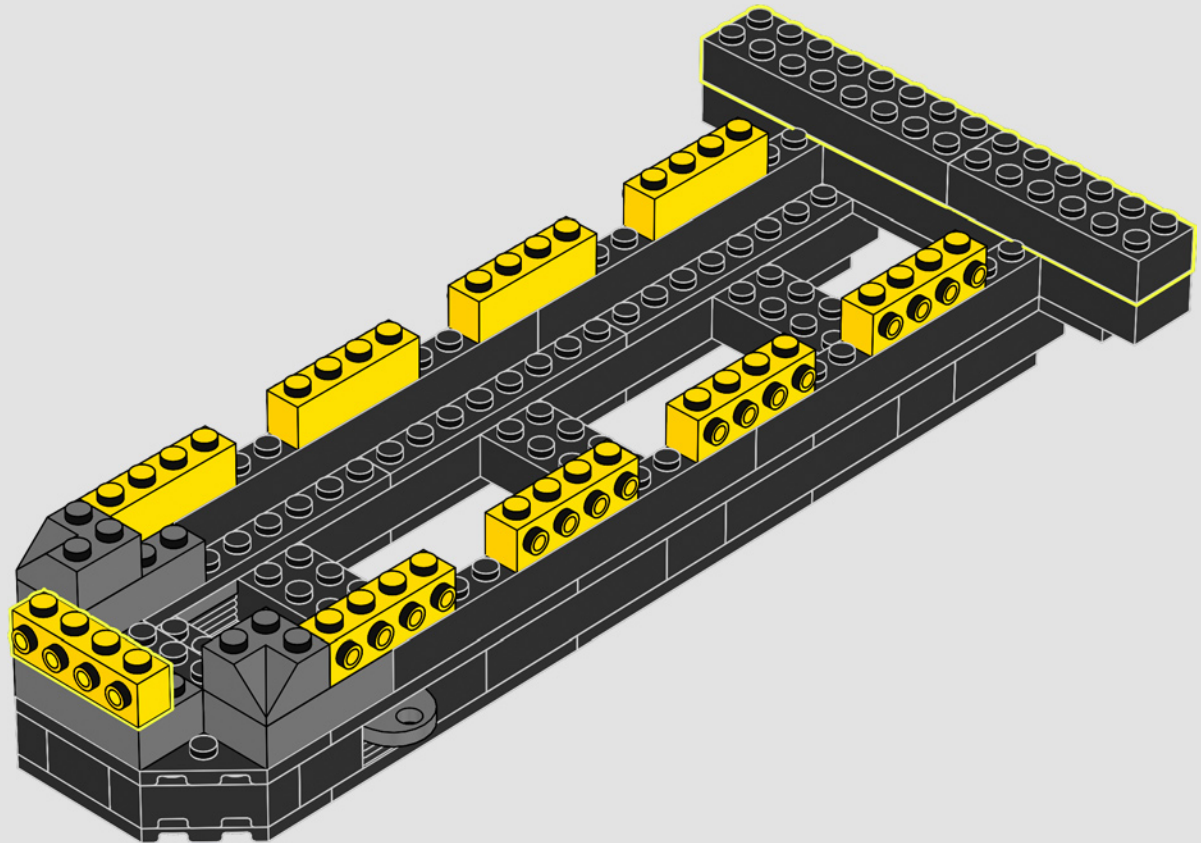



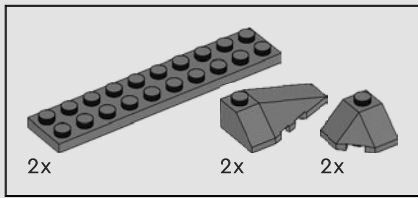

222

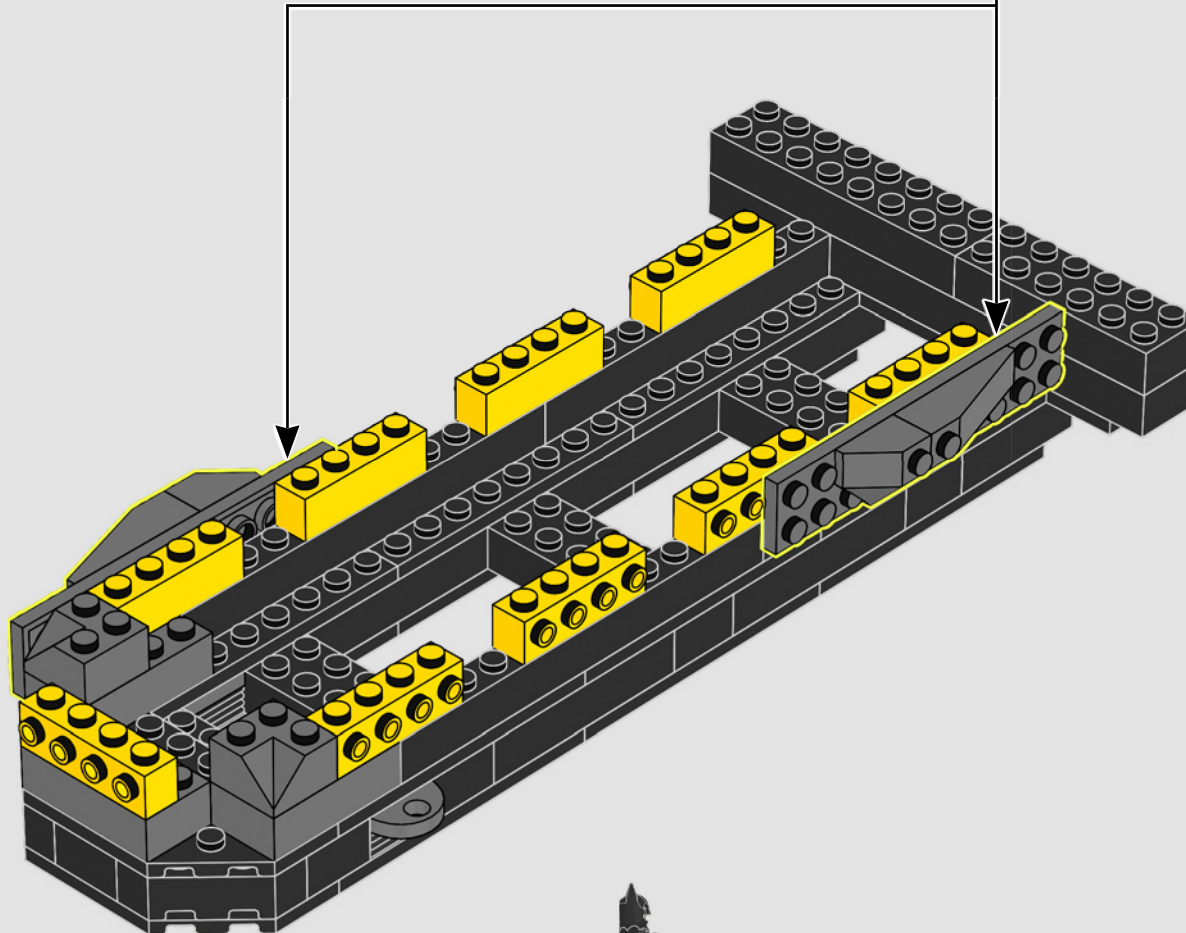
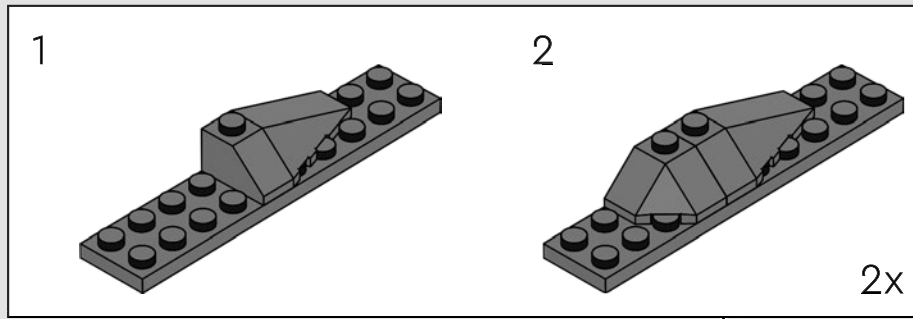

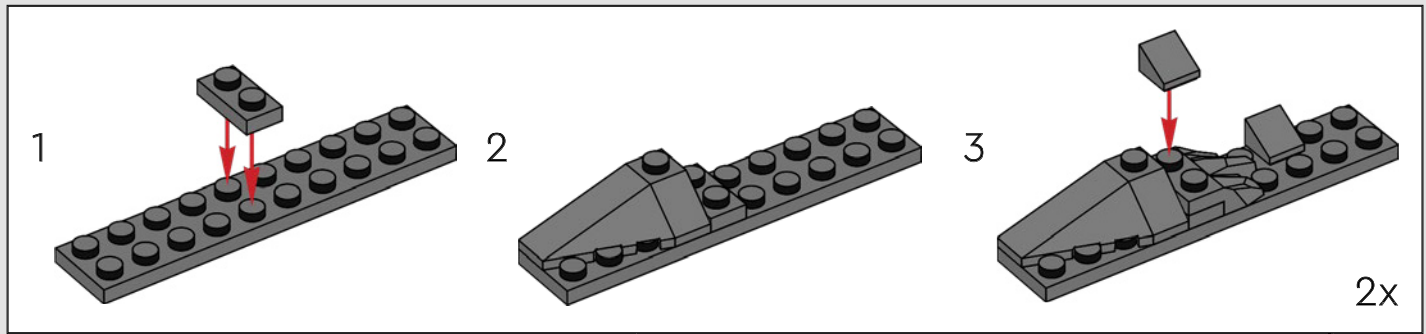
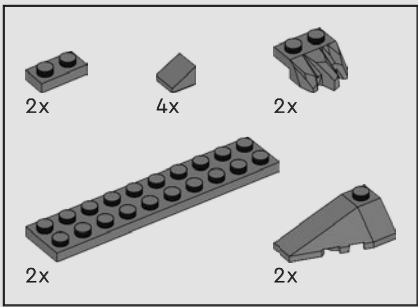

223

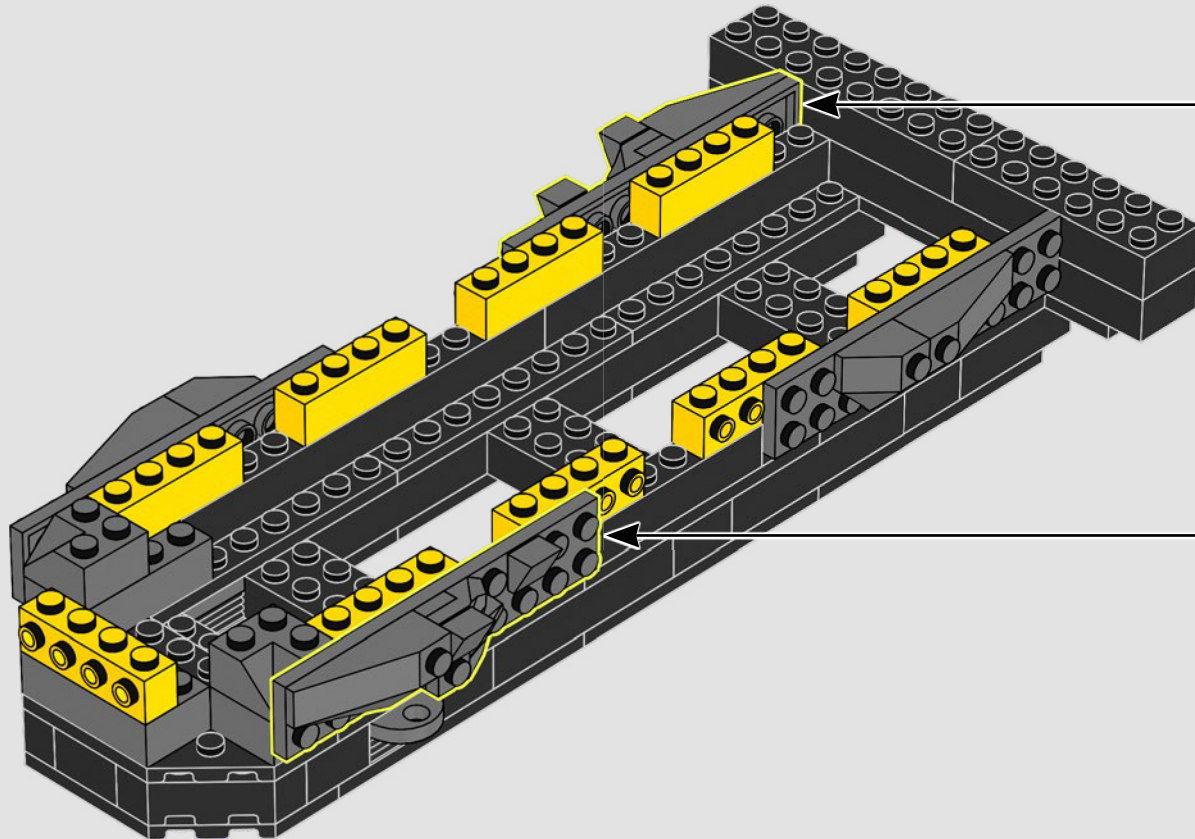

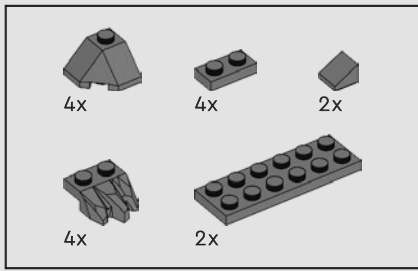

224

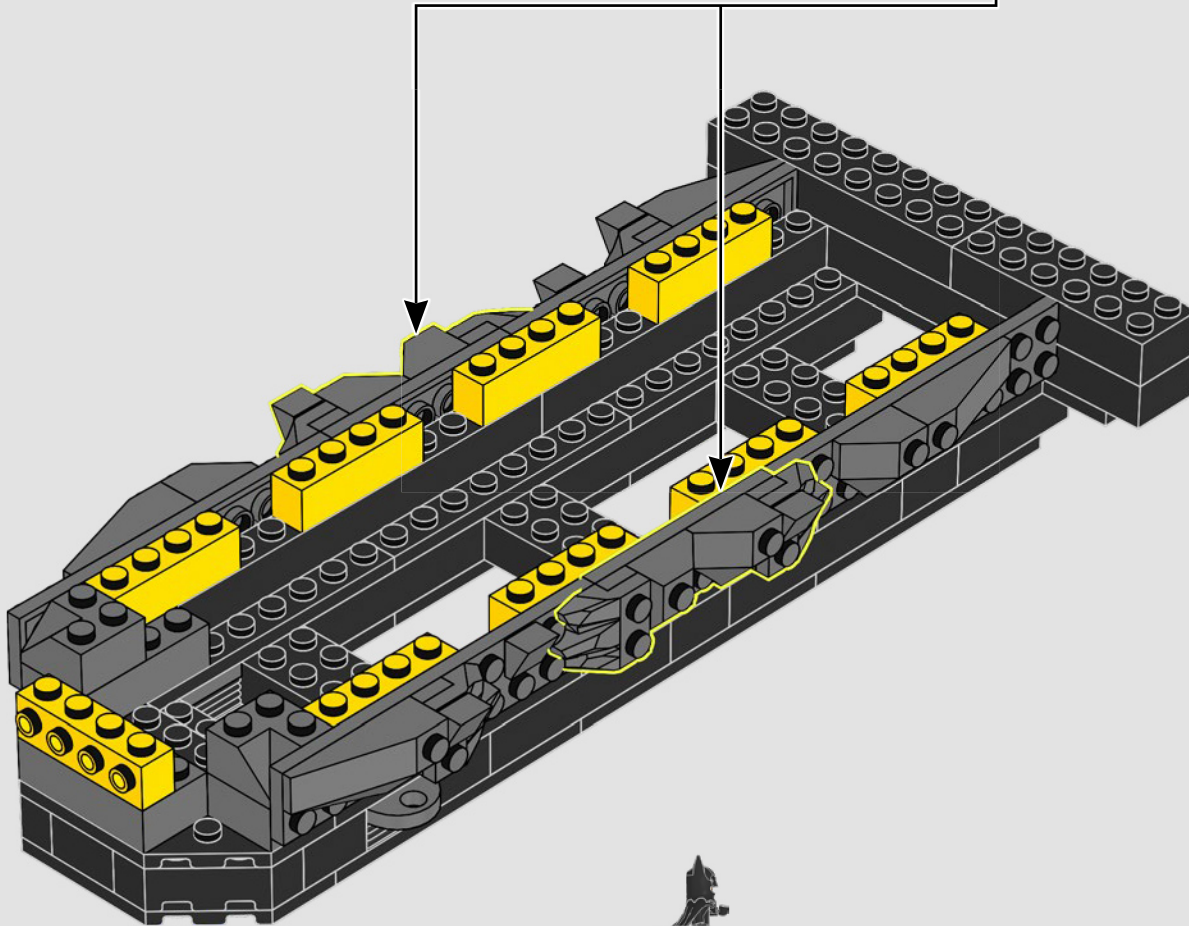
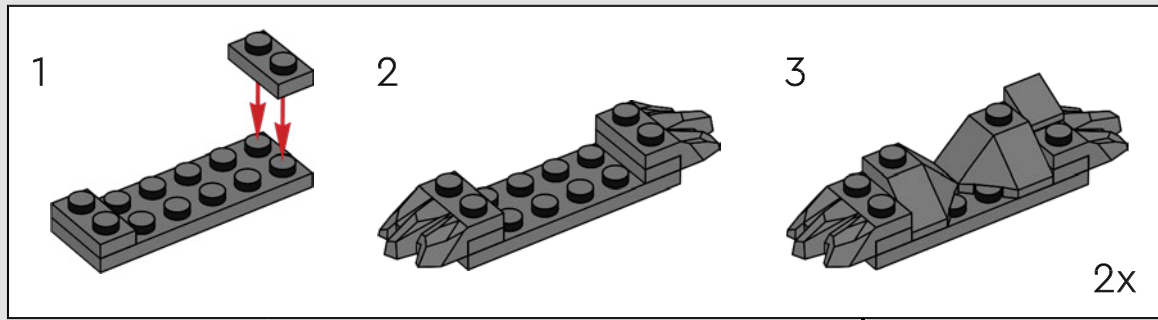



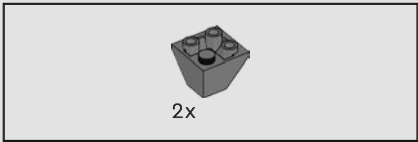

225

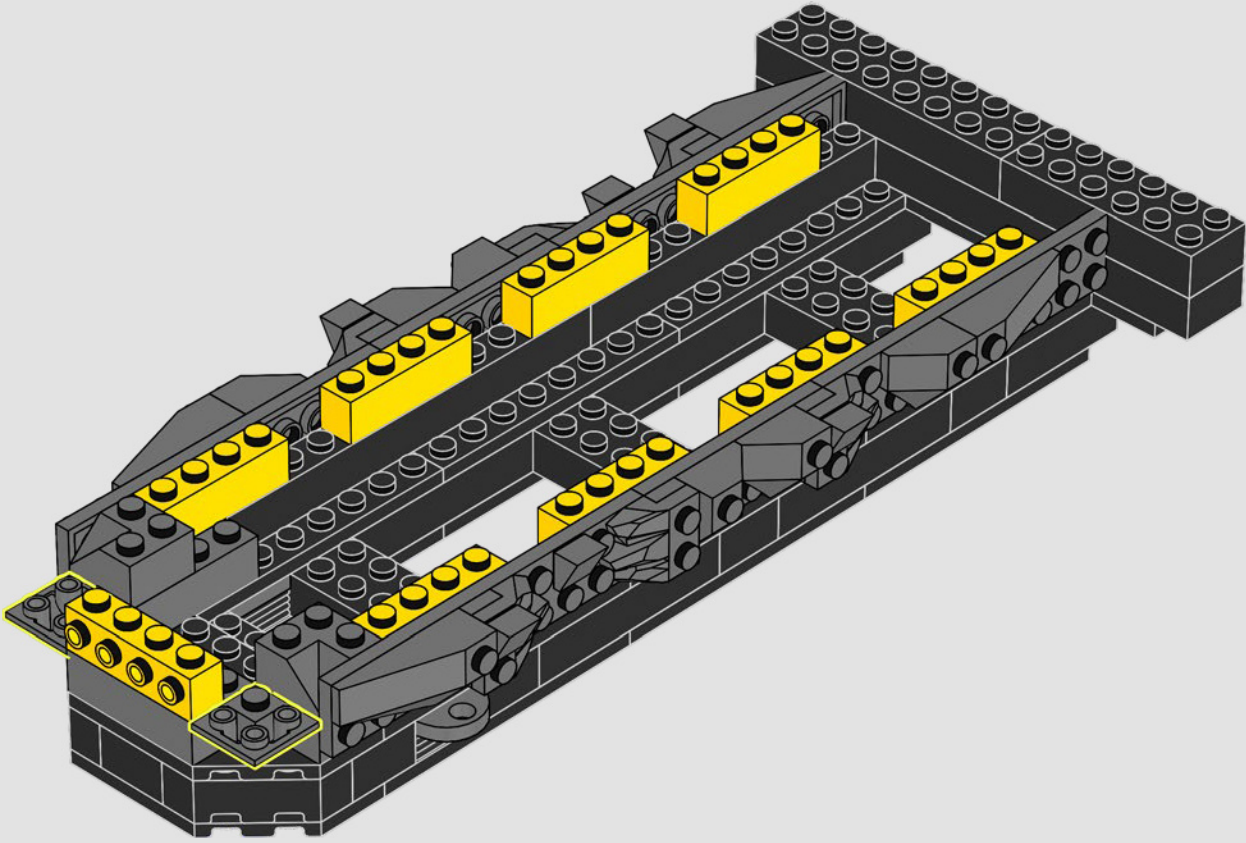

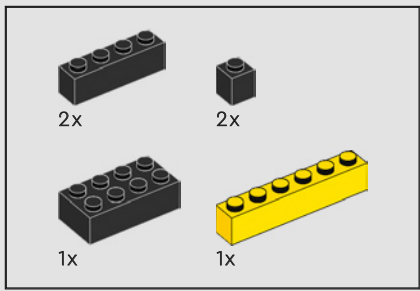

226

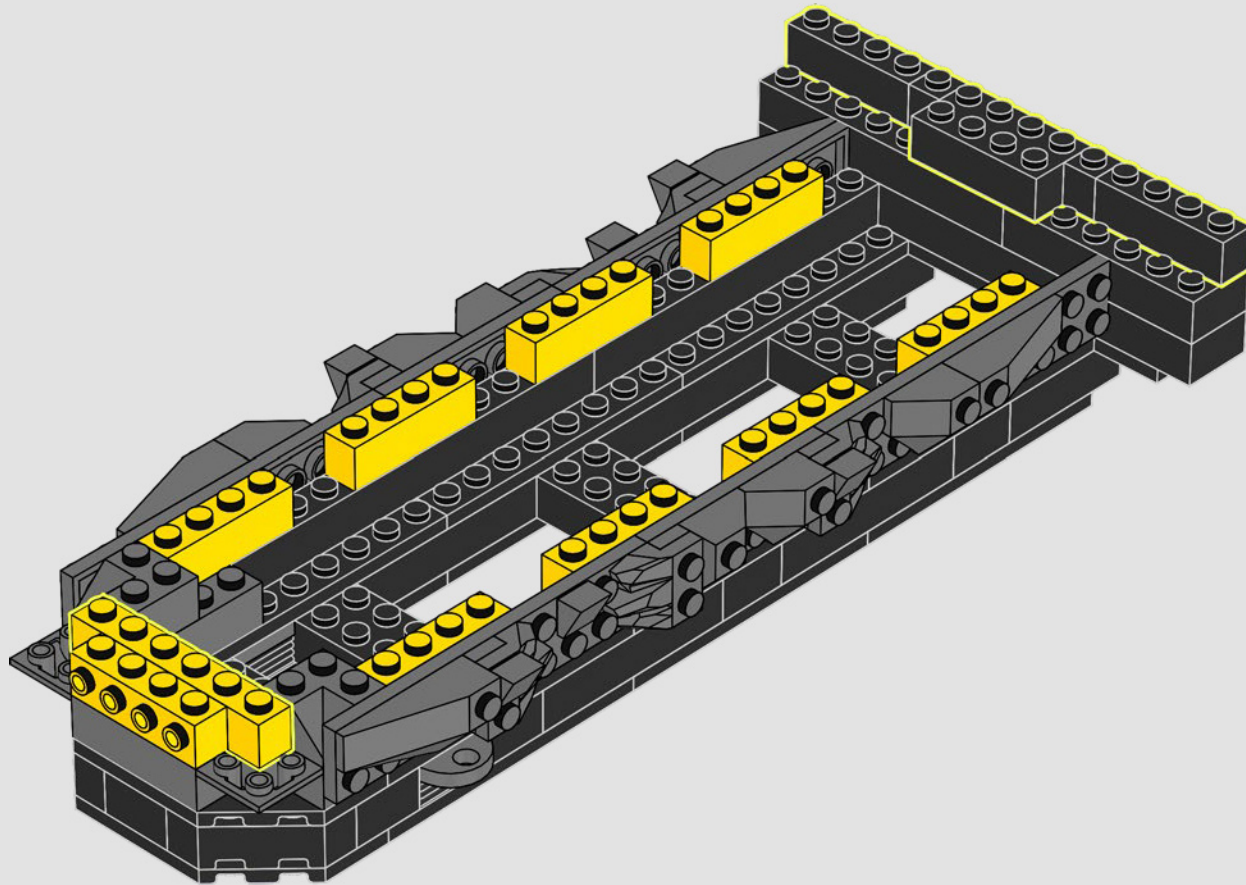



227

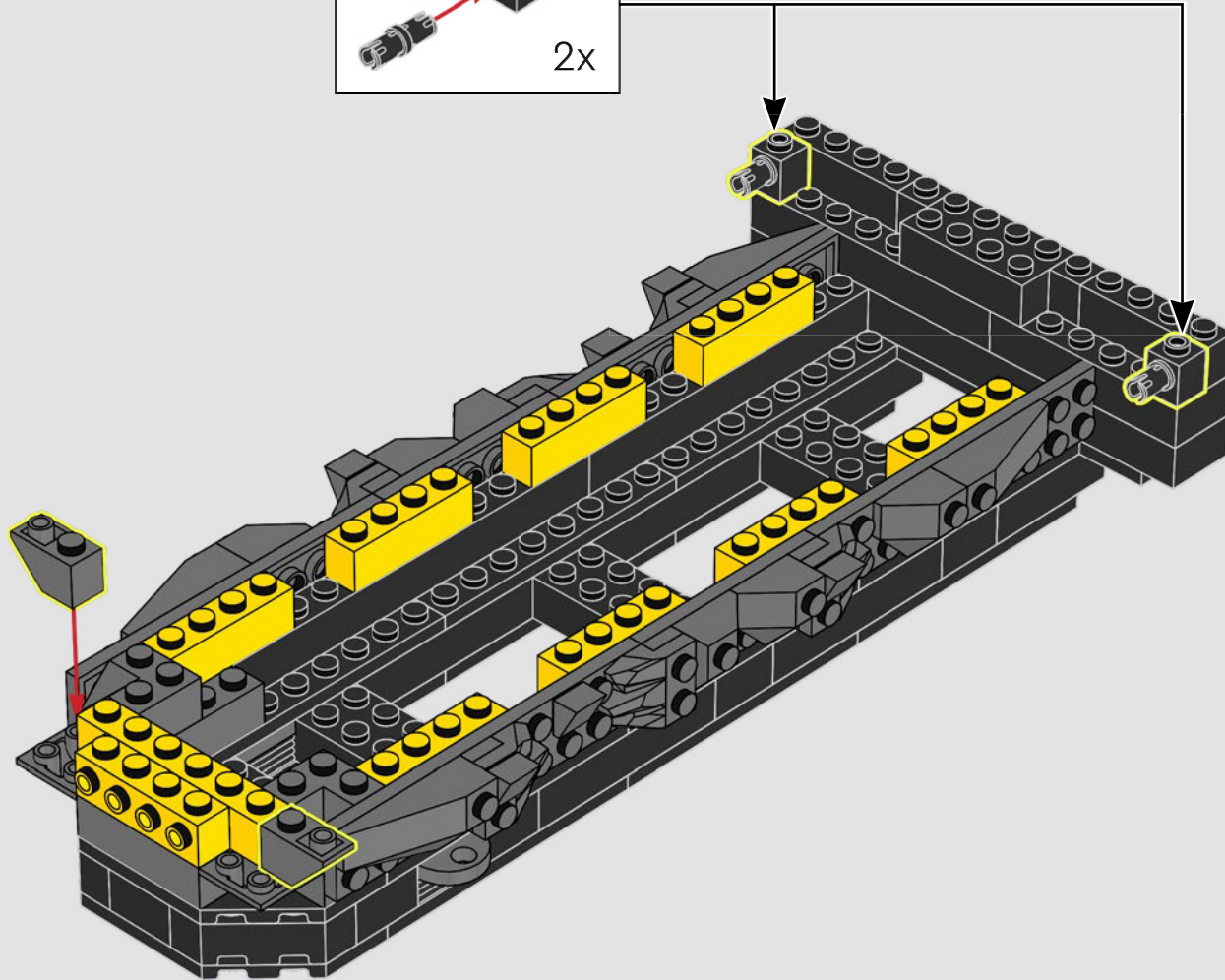
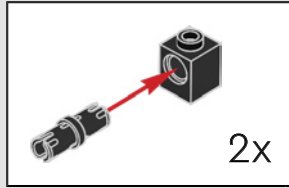

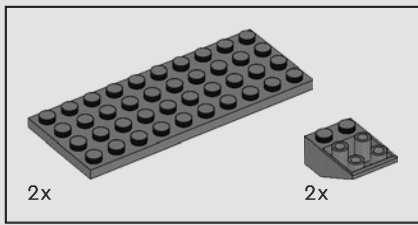

228

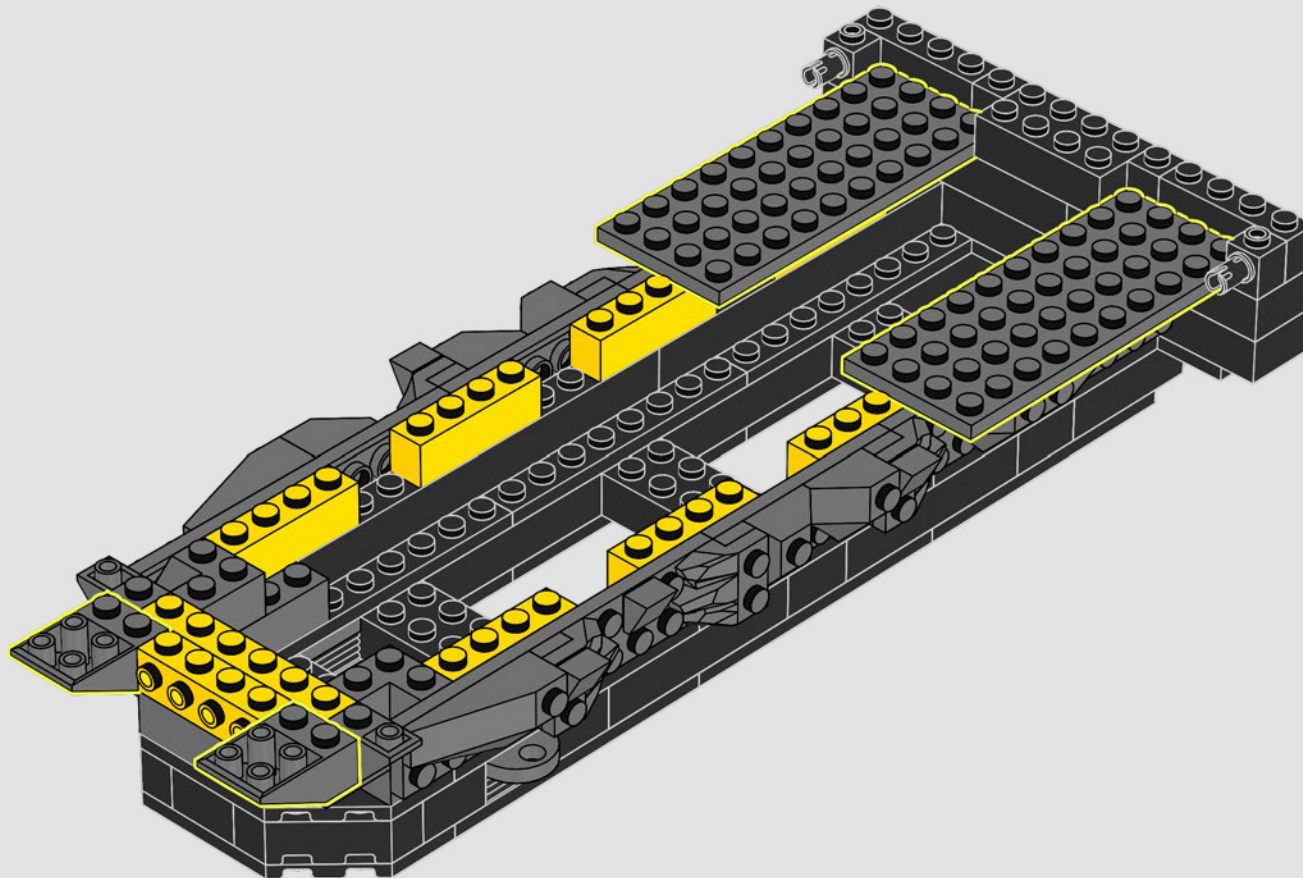



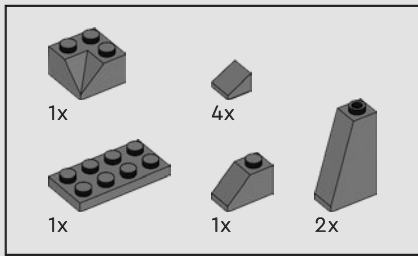

229

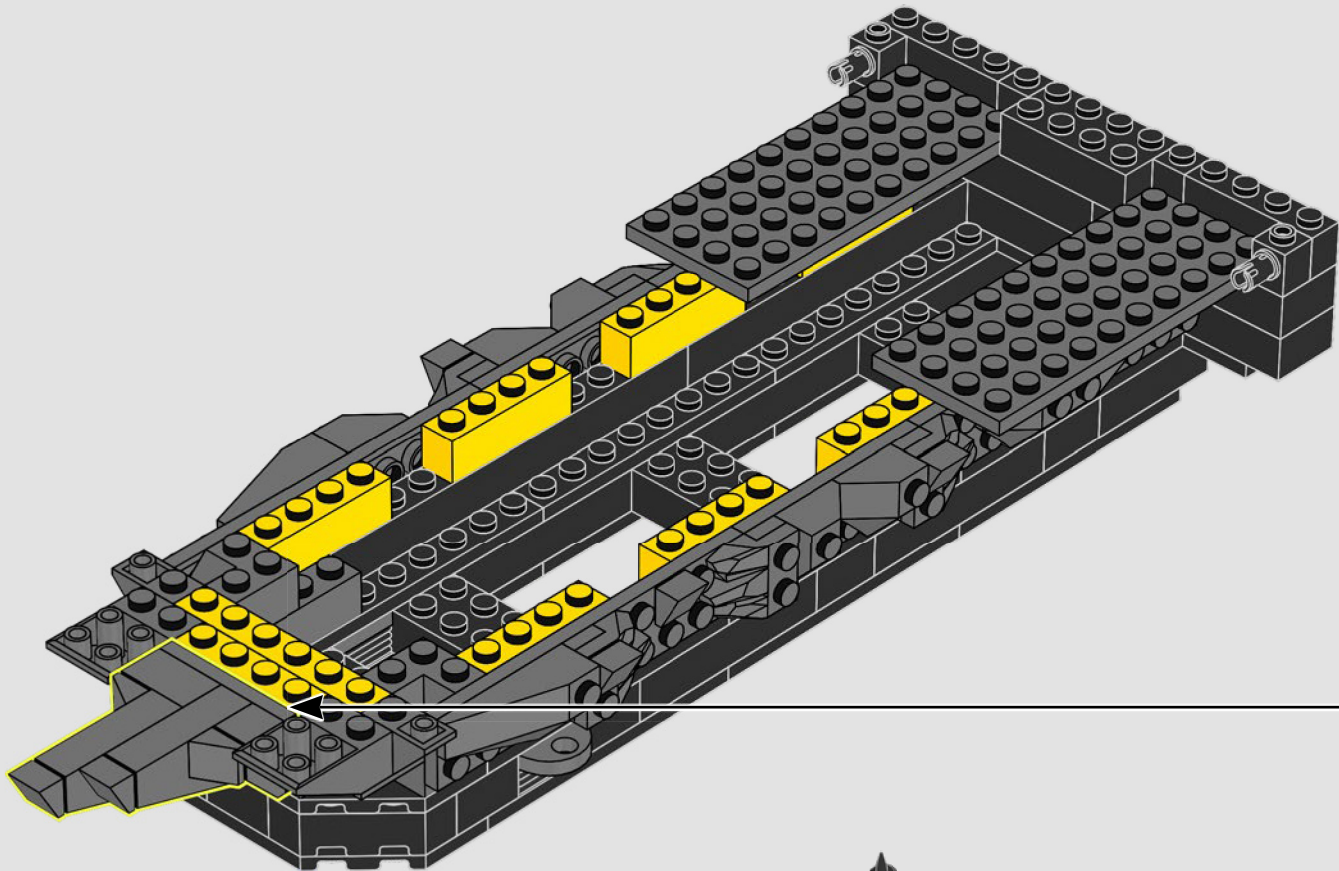
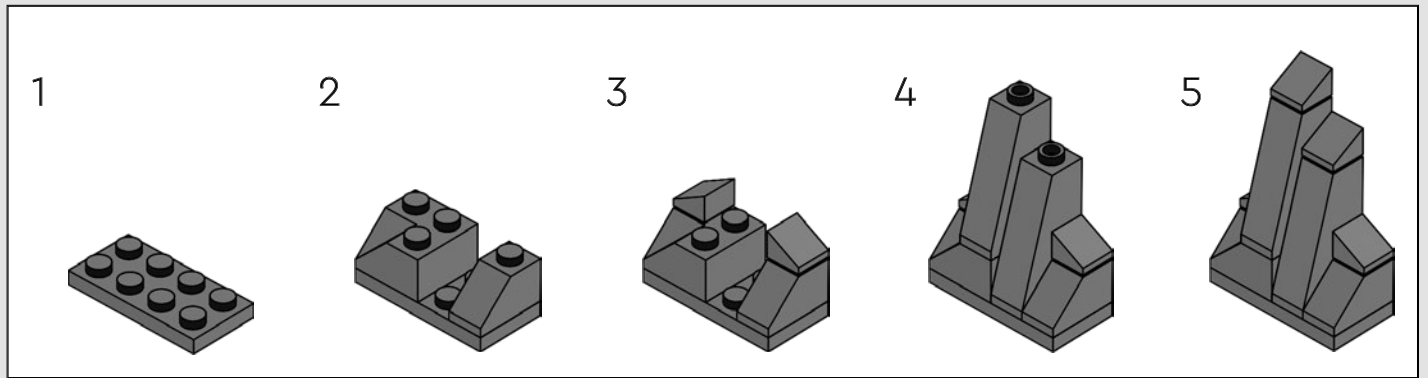

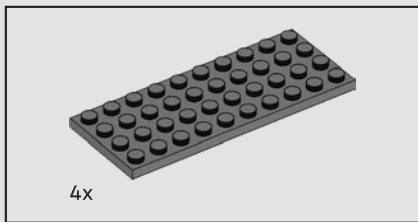

230

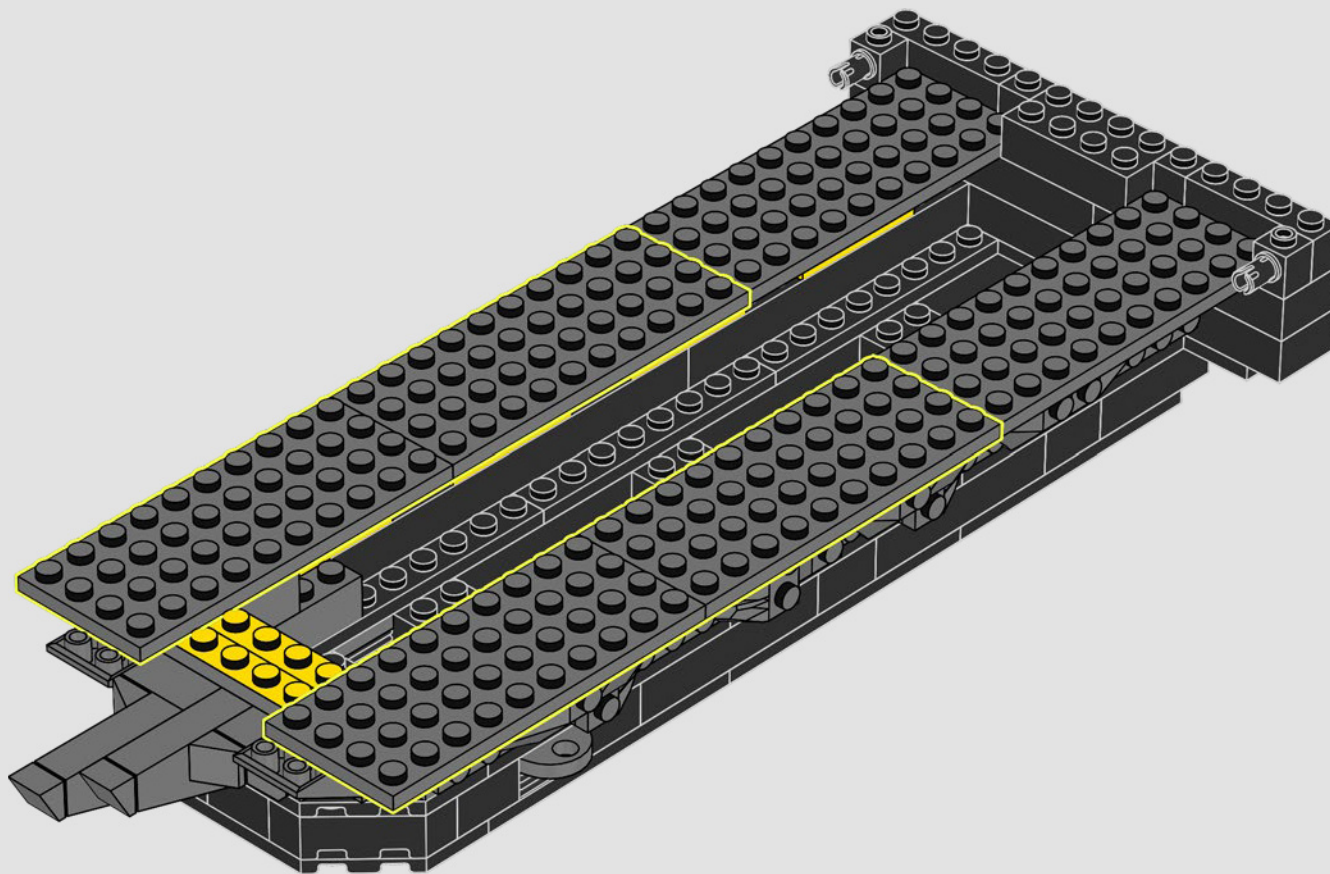

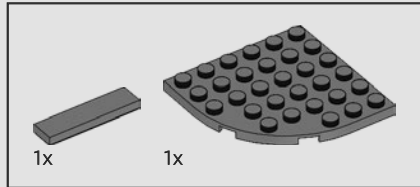
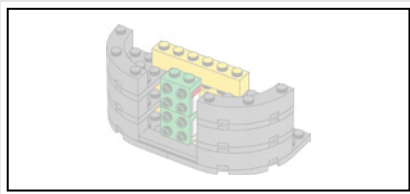

231

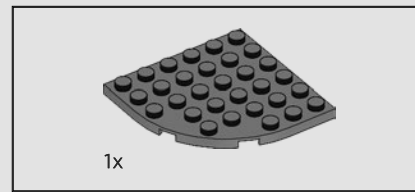
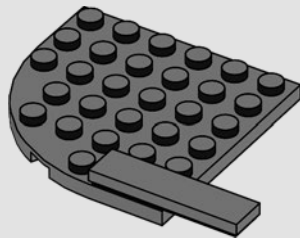

232

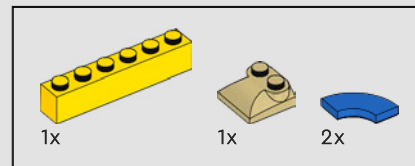
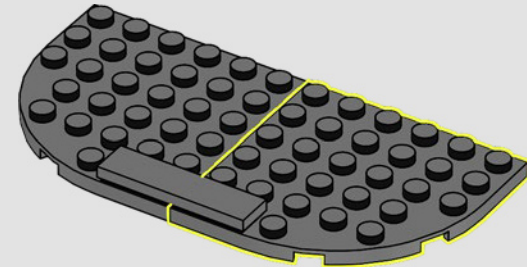

233

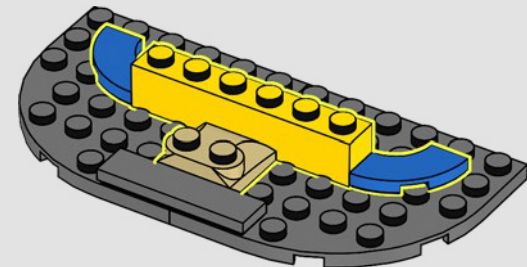

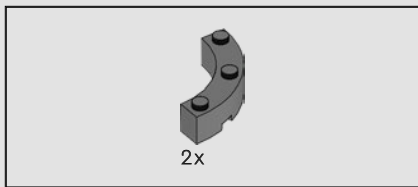

234

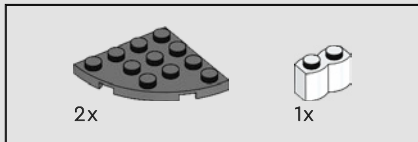
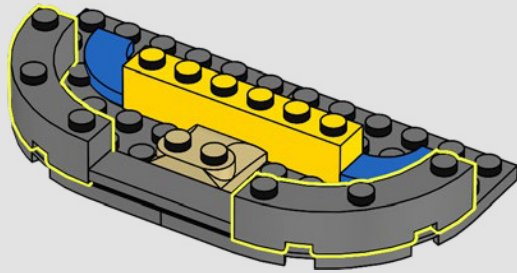

235

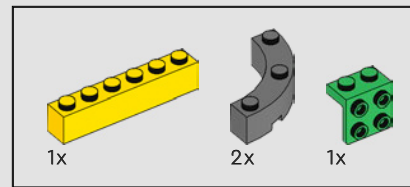
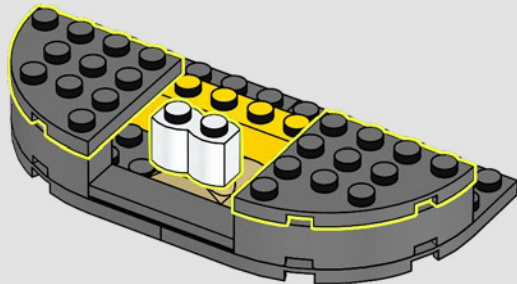

236

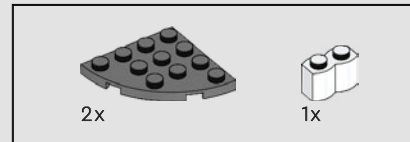
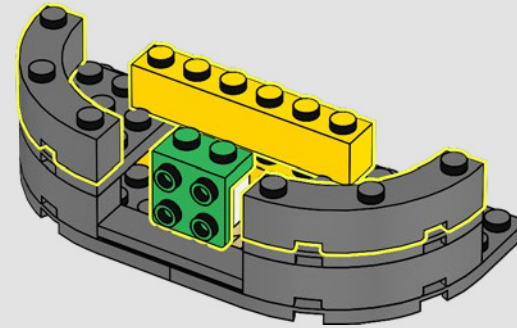

237

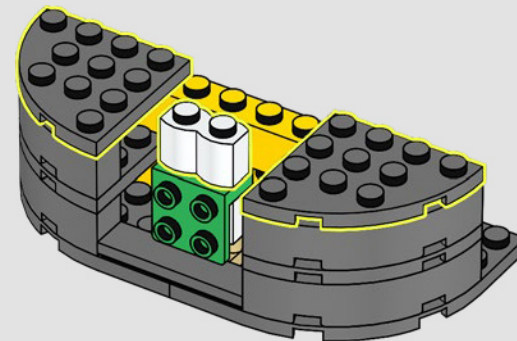

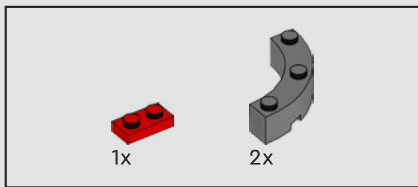

238

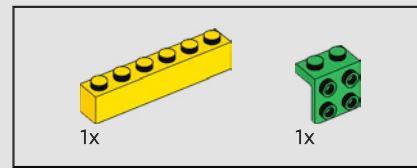
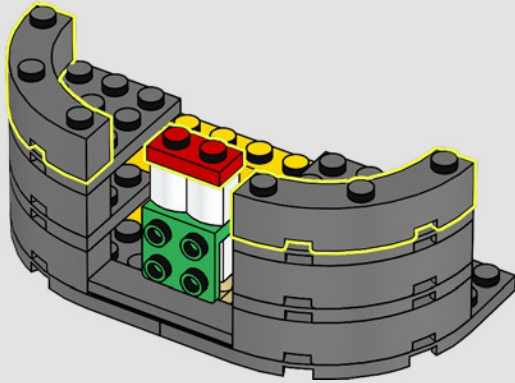

239

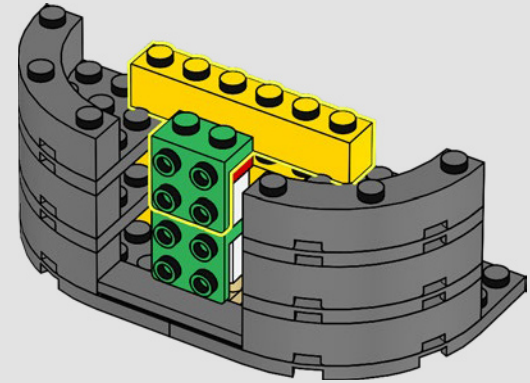

240

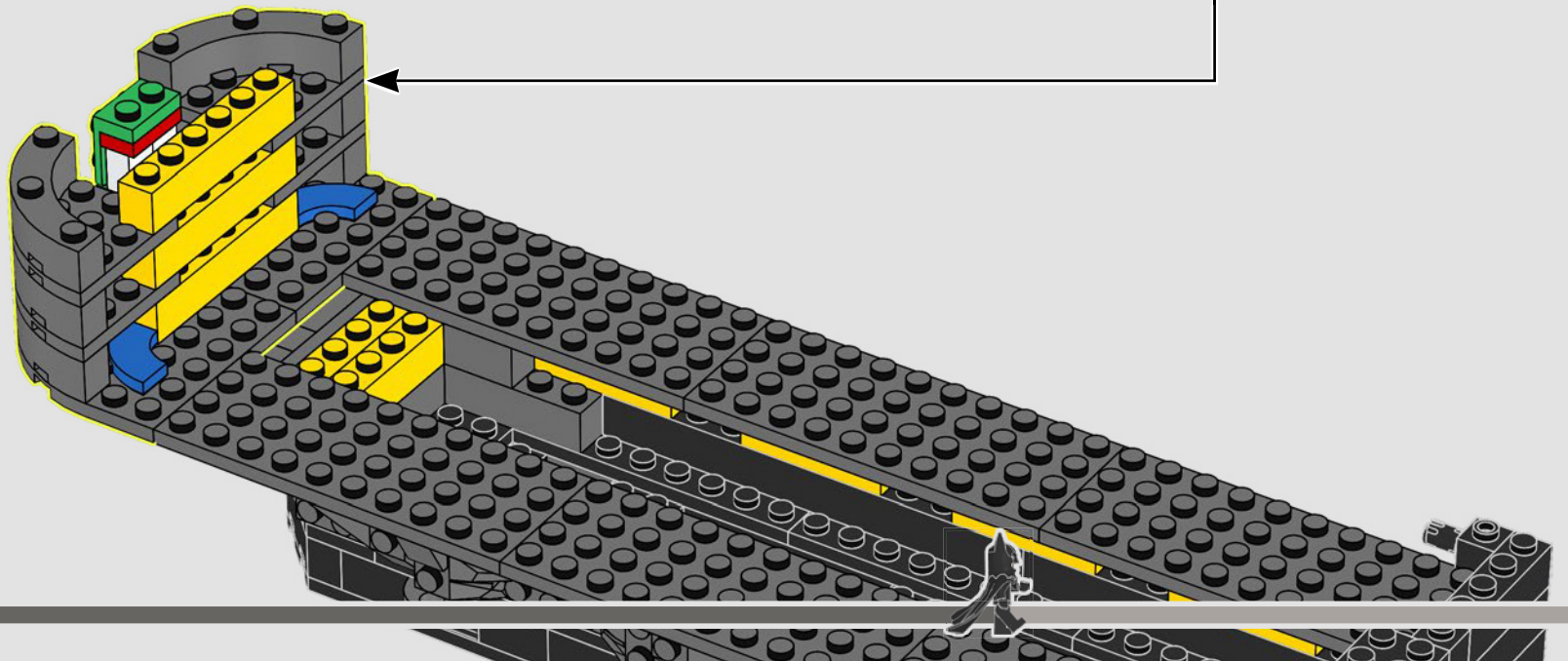

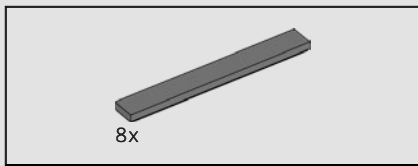

241

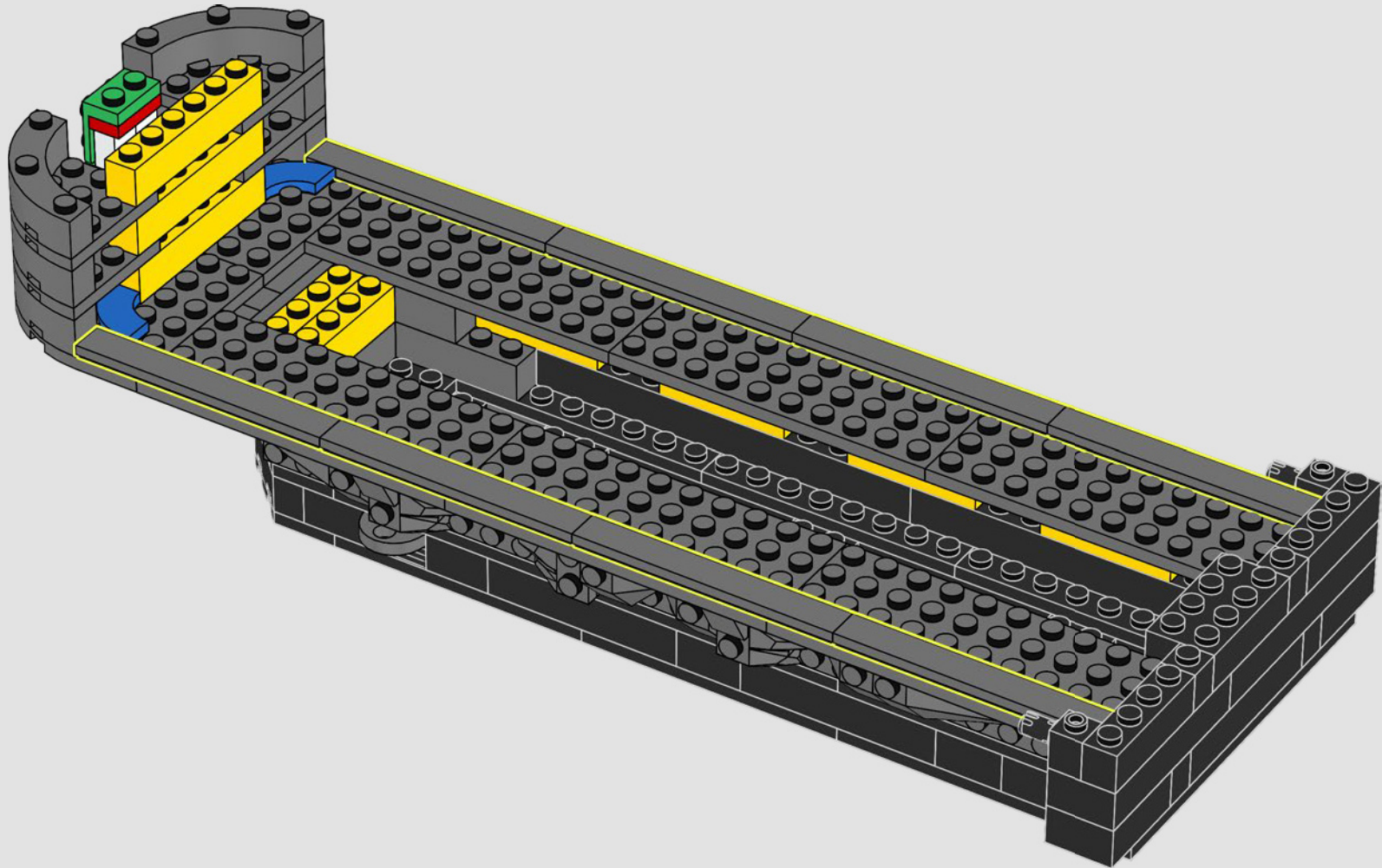

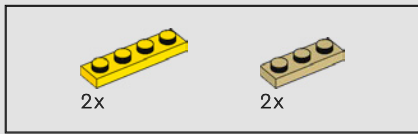

242

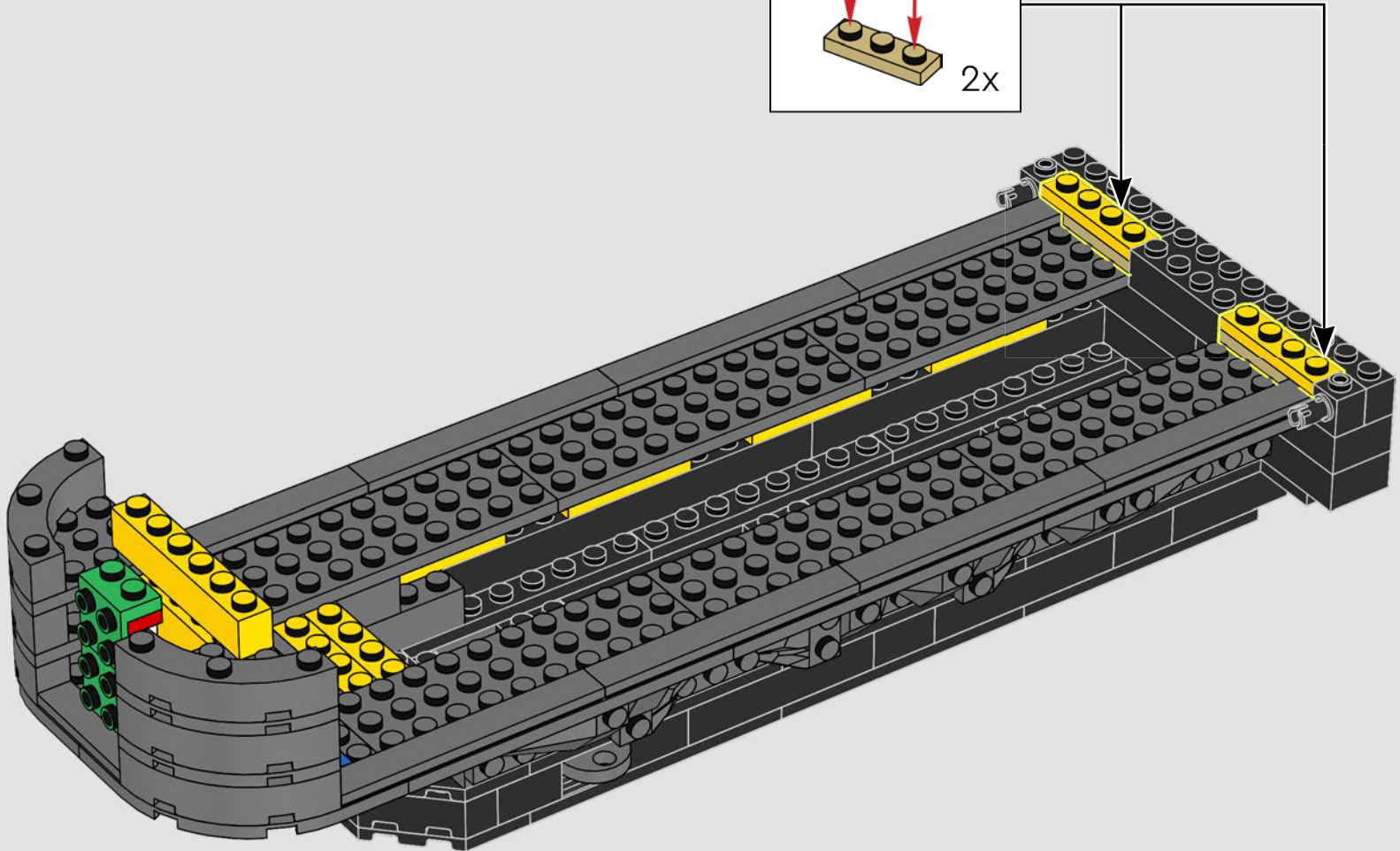
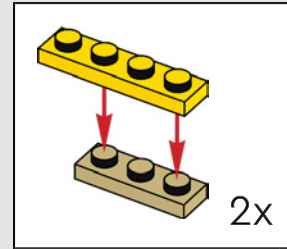

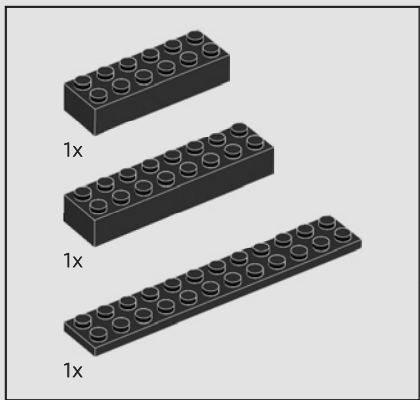

243

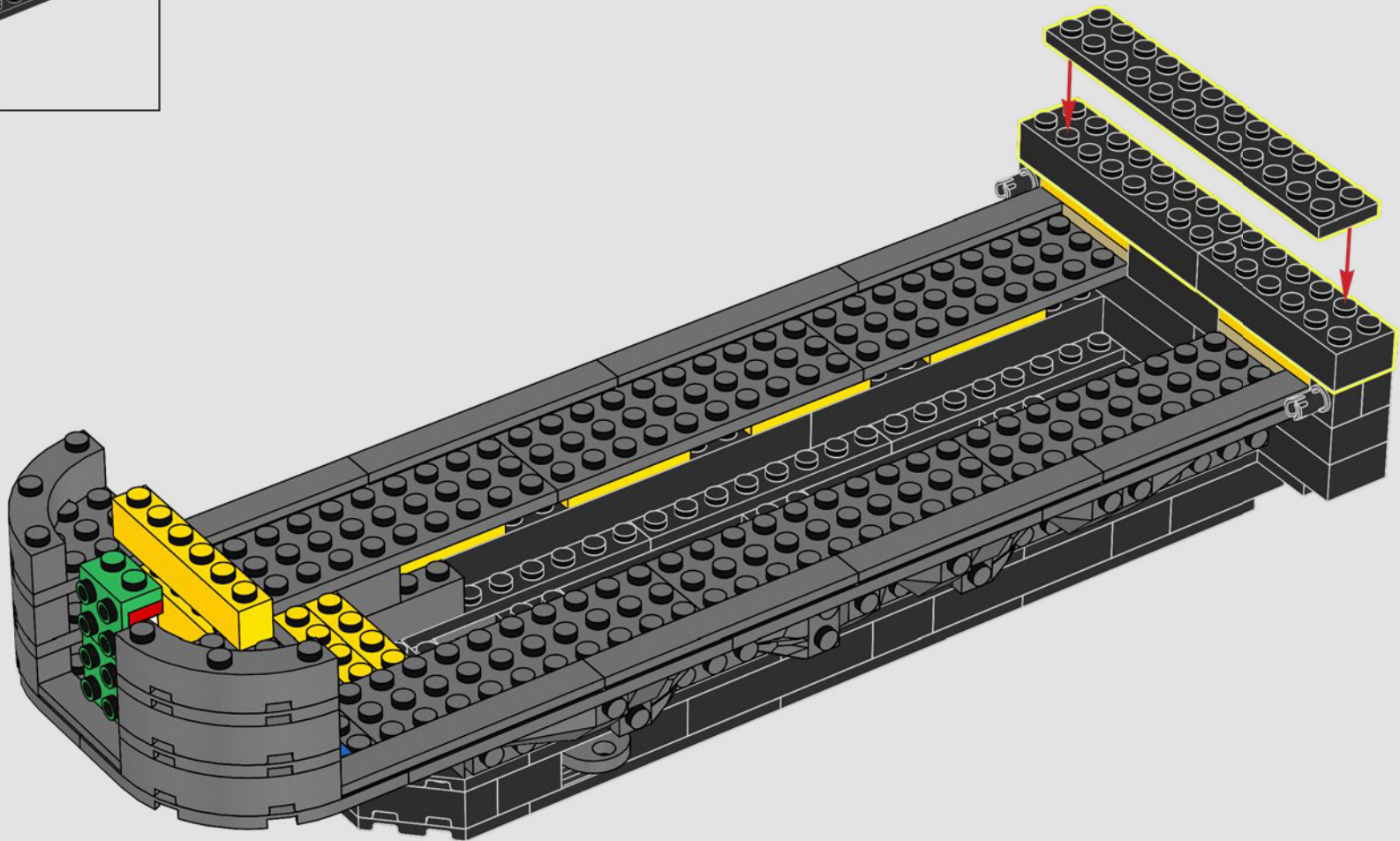



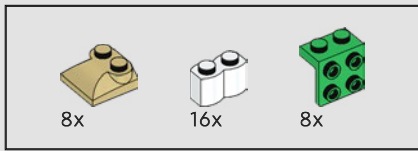

244

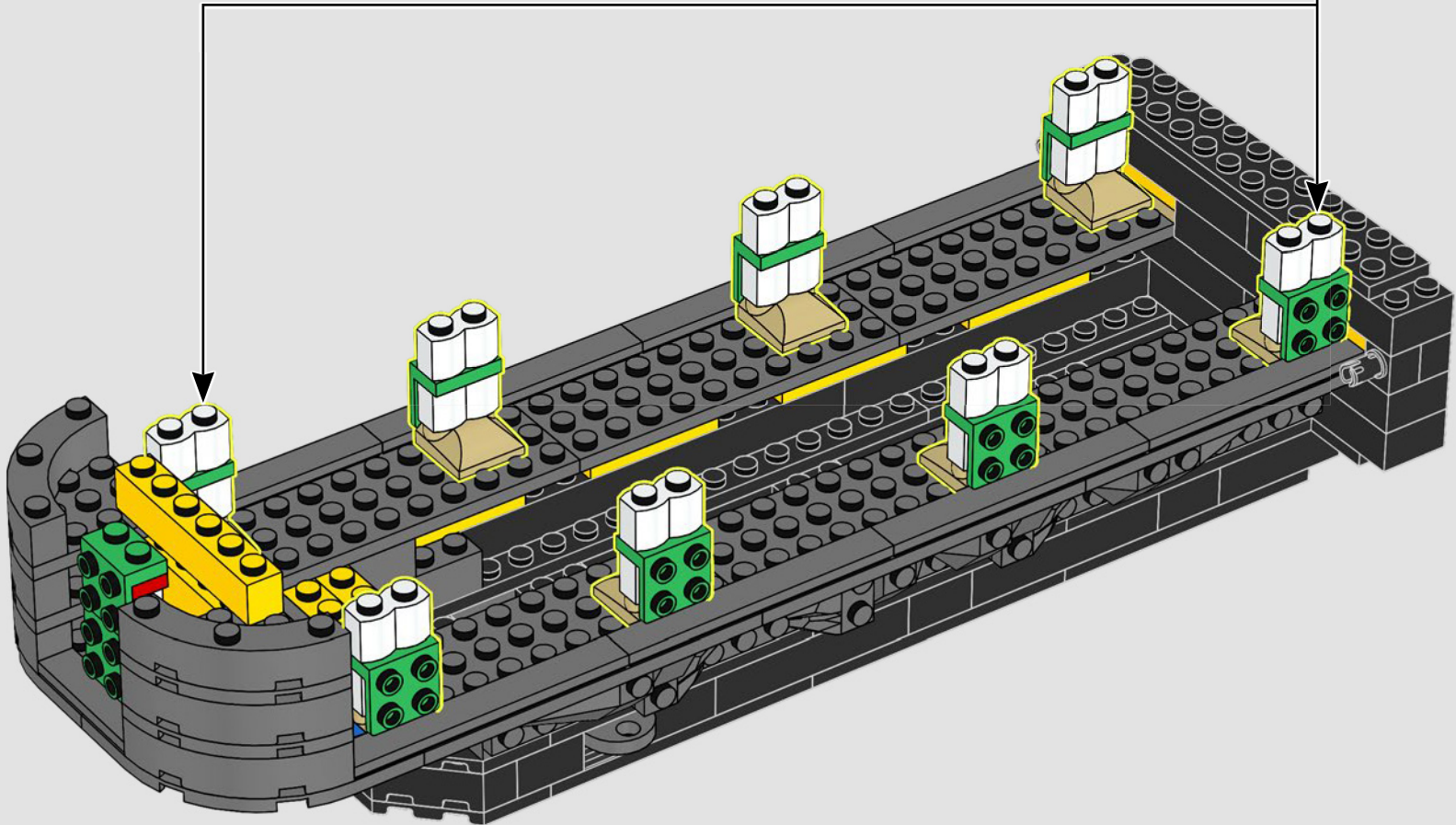
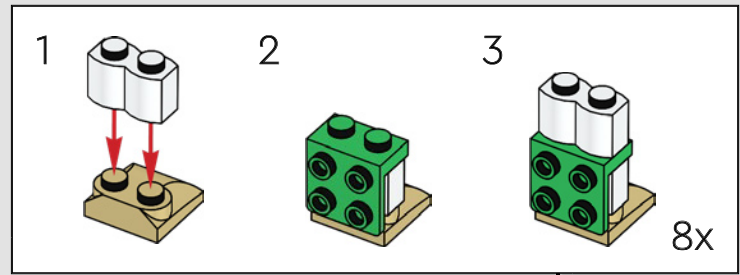

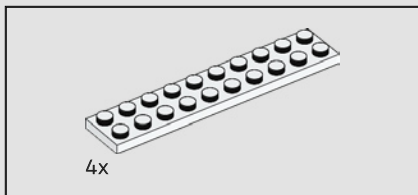

245

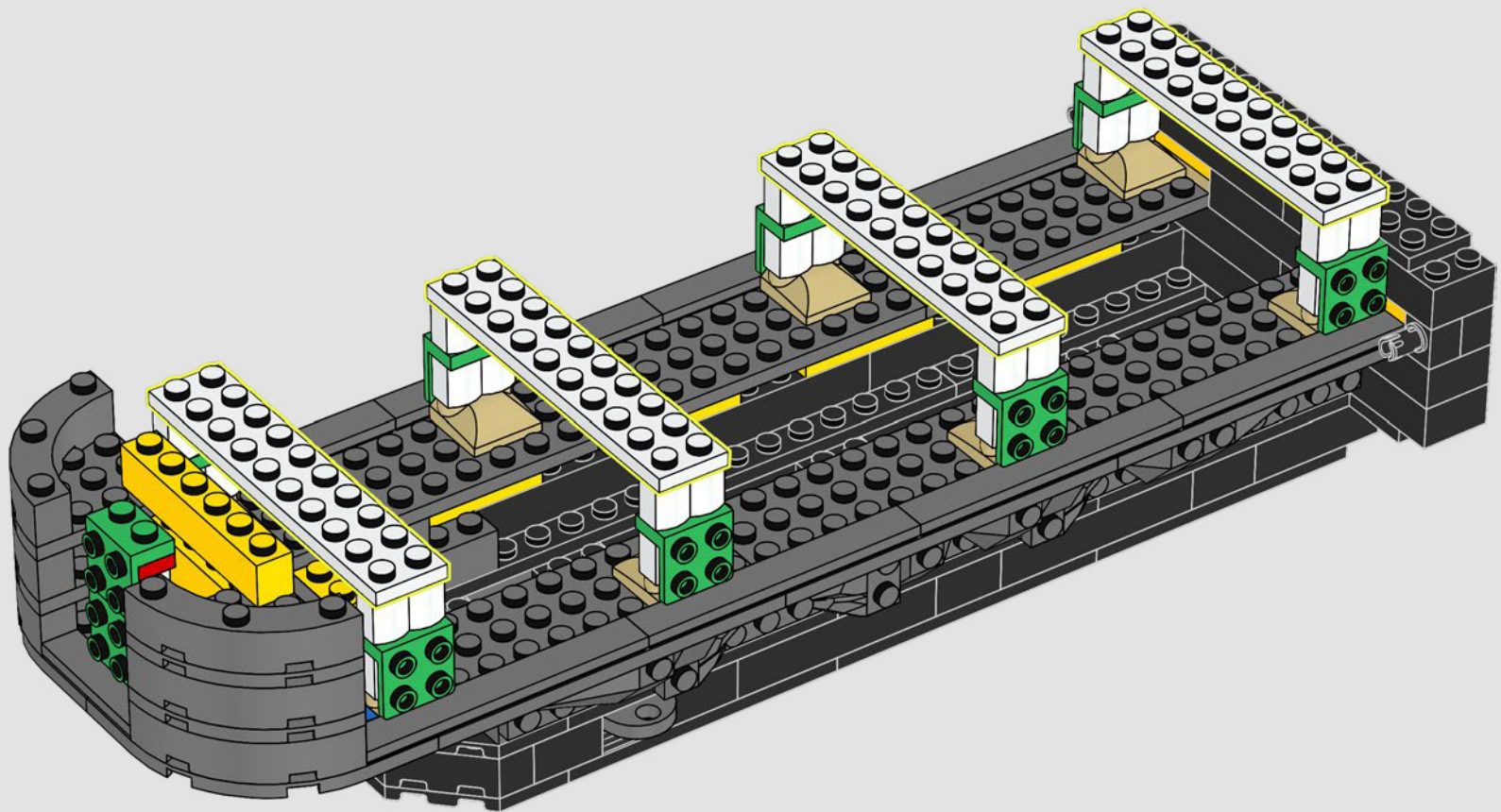

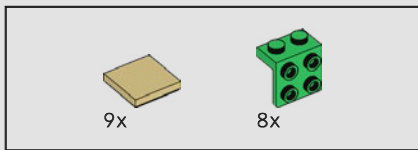

246

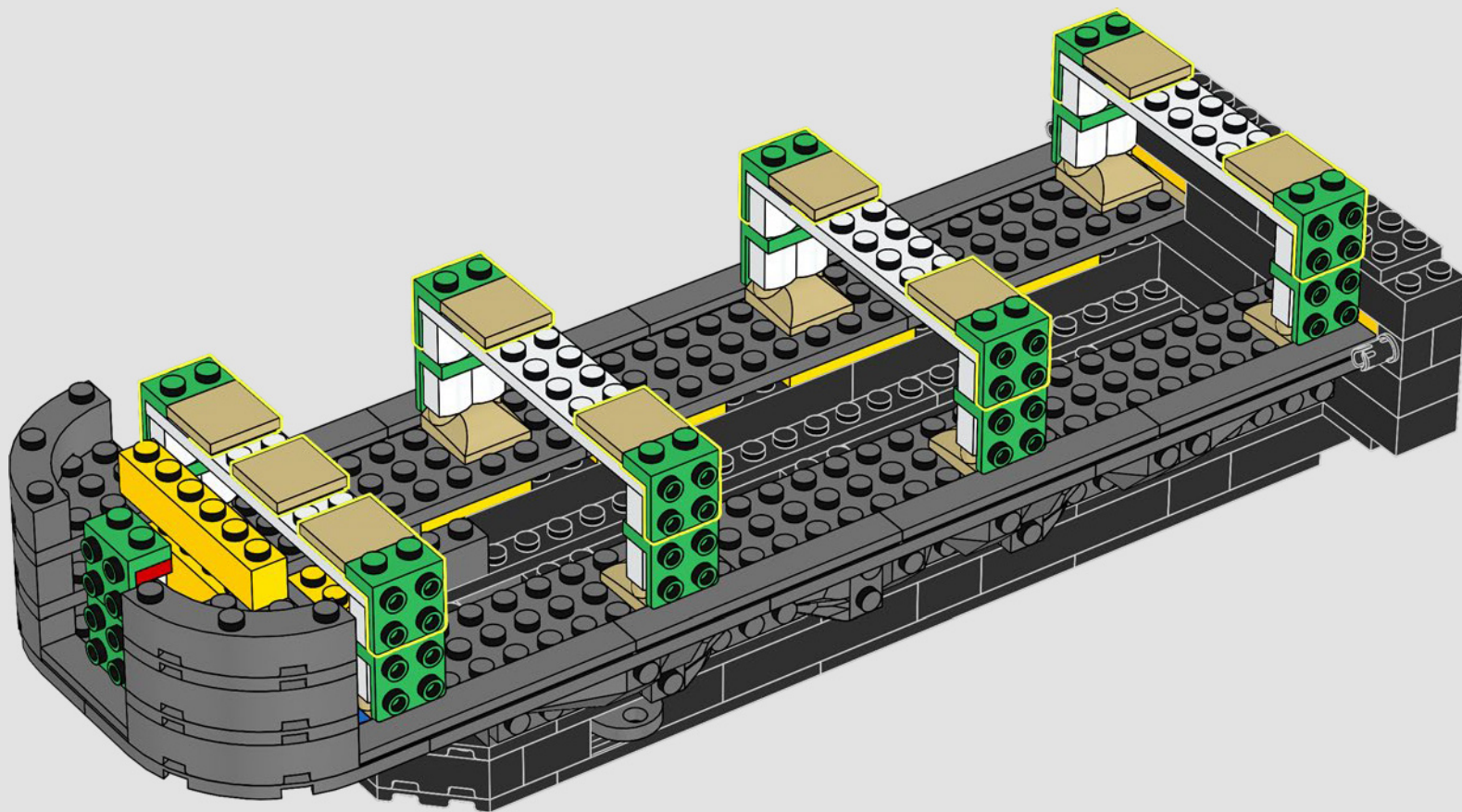

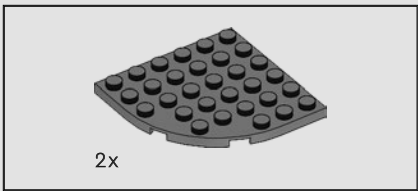

247

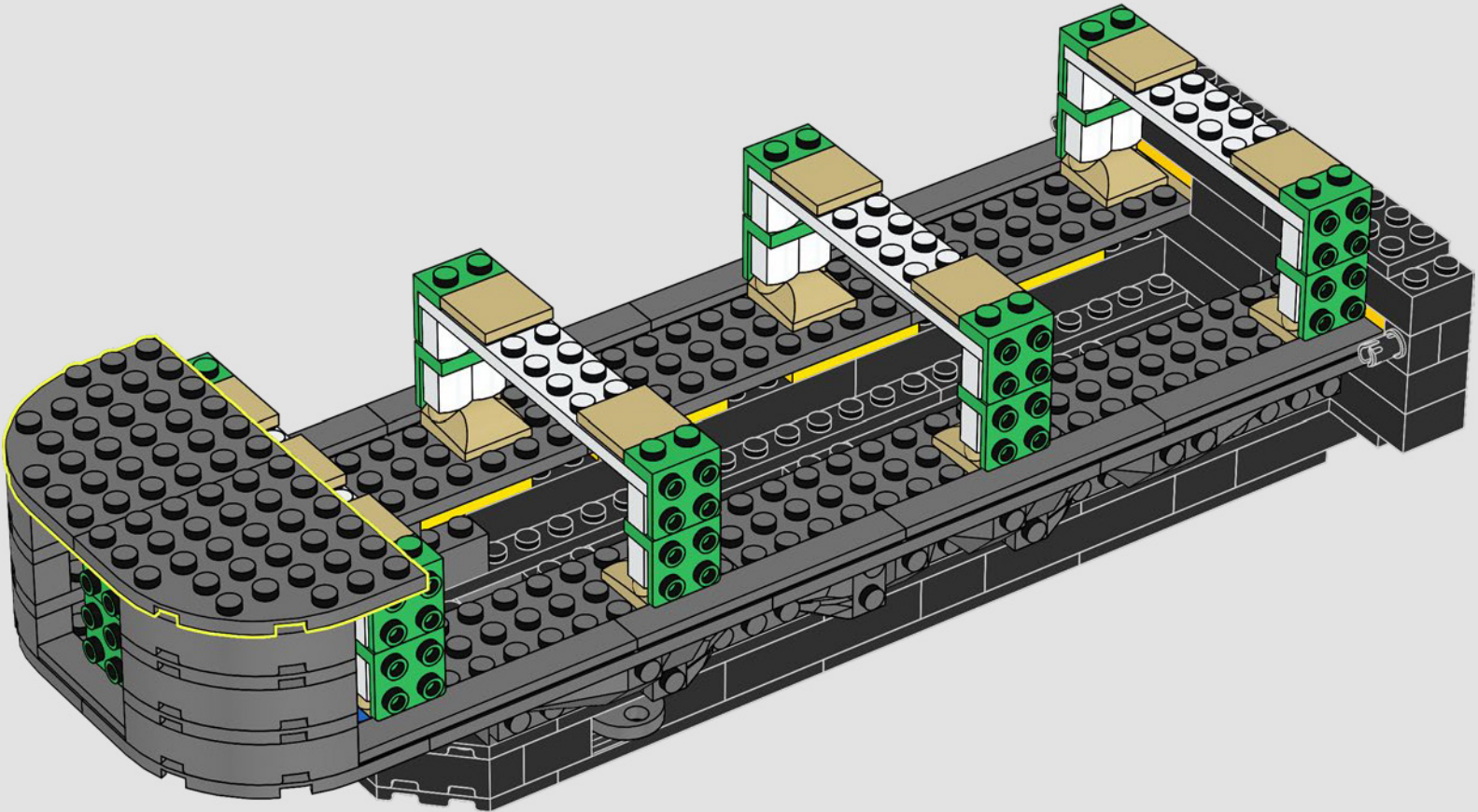

248

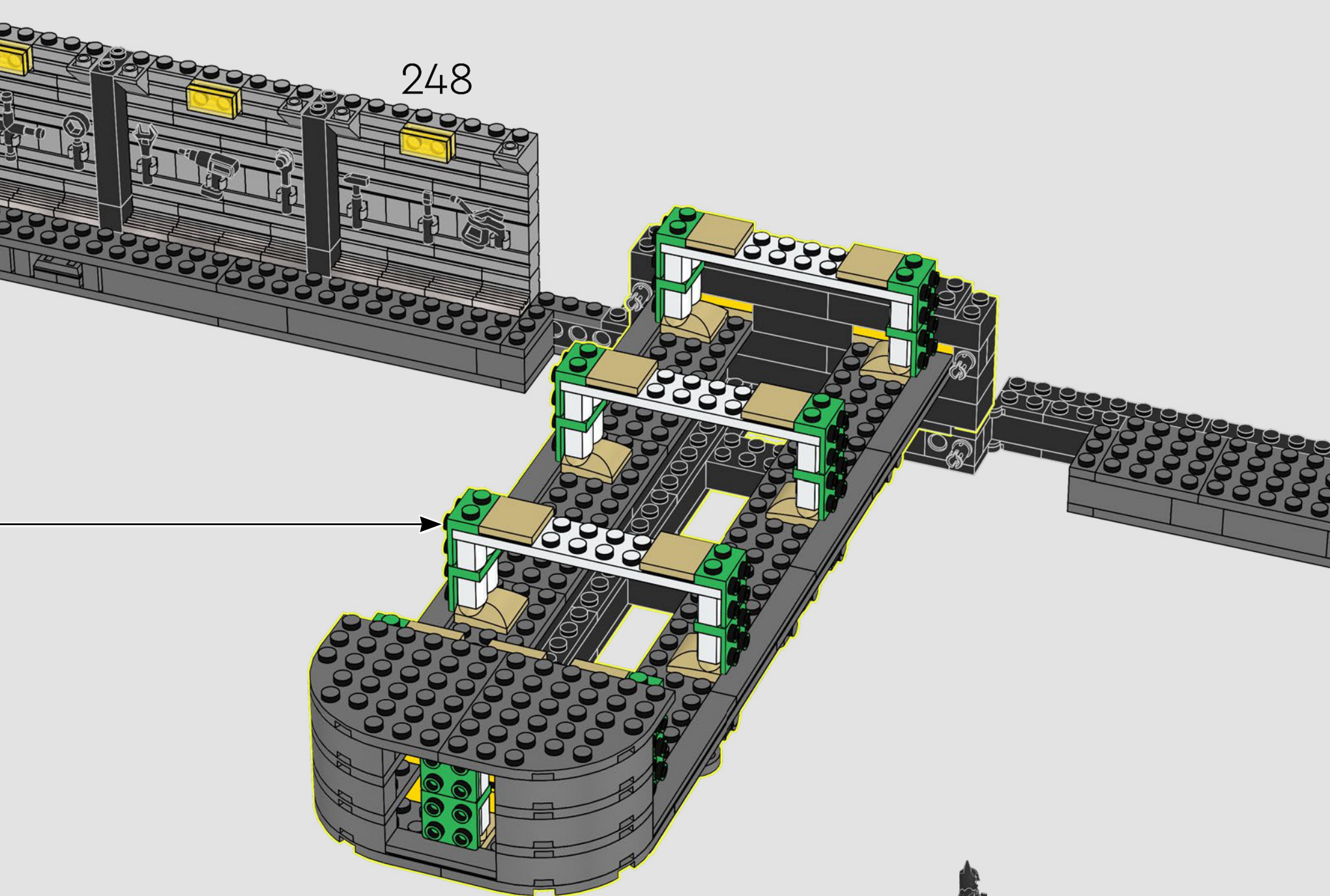

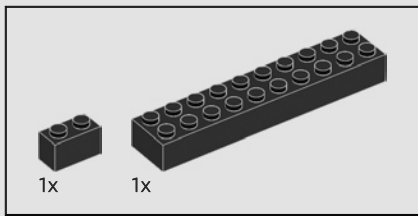

249

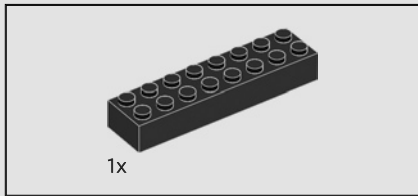
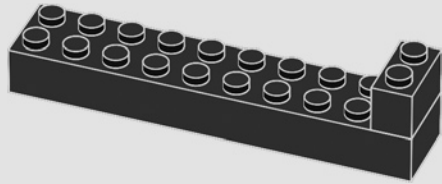

250

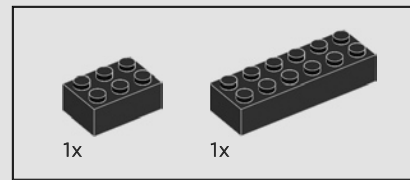
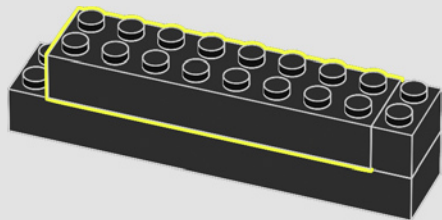

251

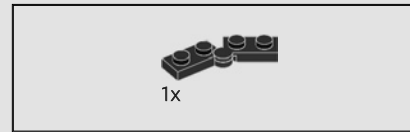
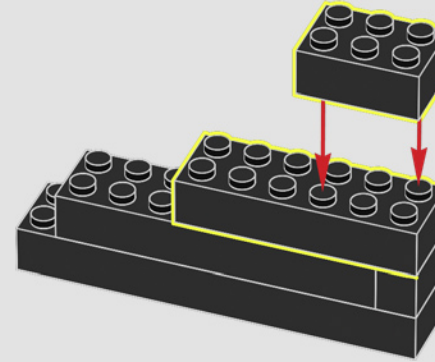

252

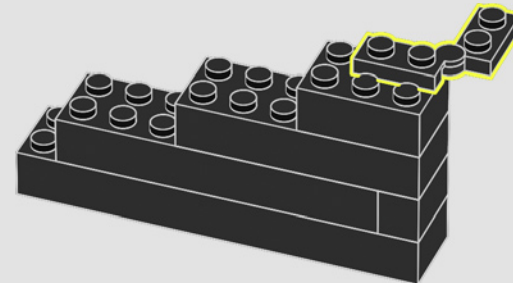

253

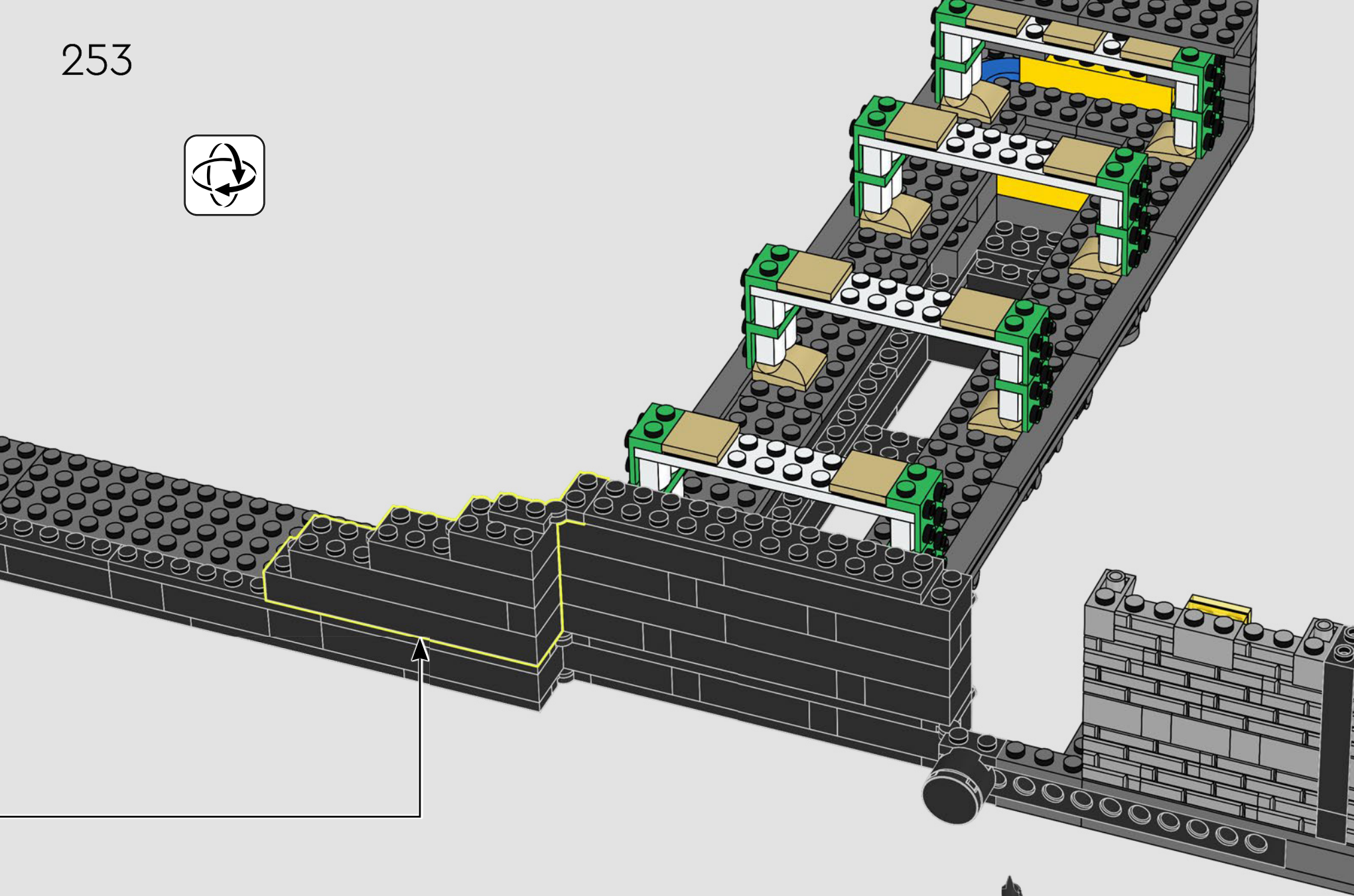

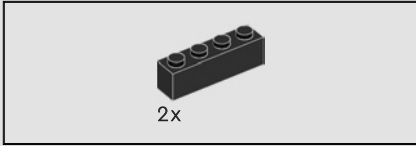
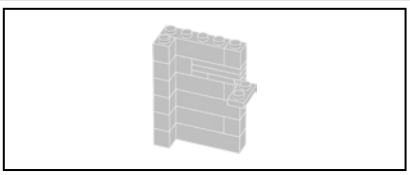

254

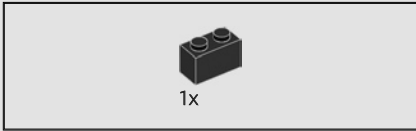
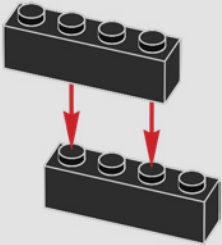

255

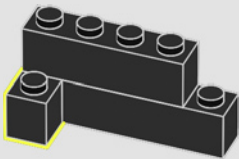

256

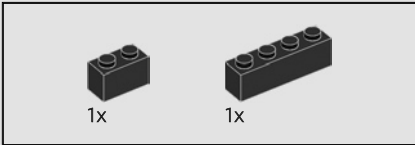
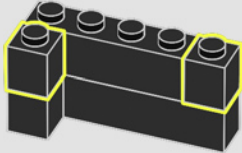

257

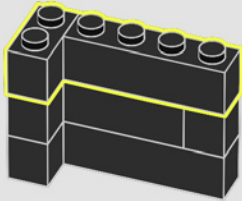



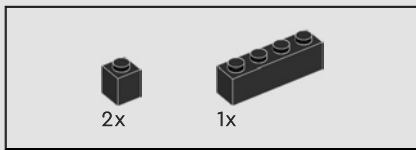

258

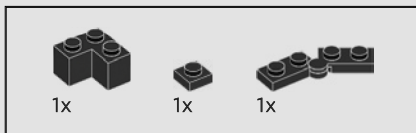
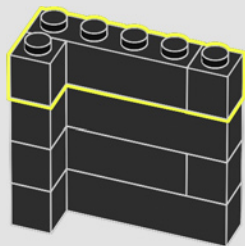

259

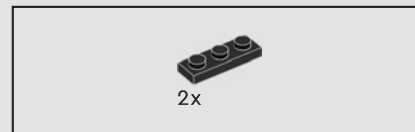
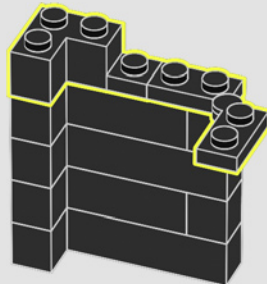

260

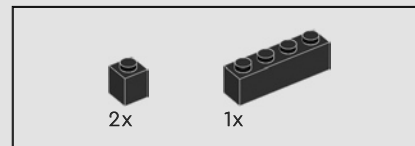
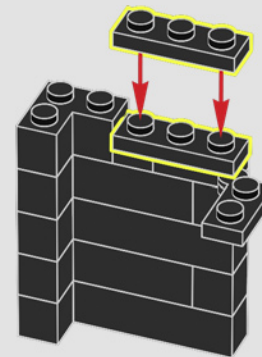

261

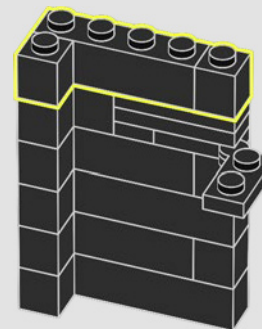

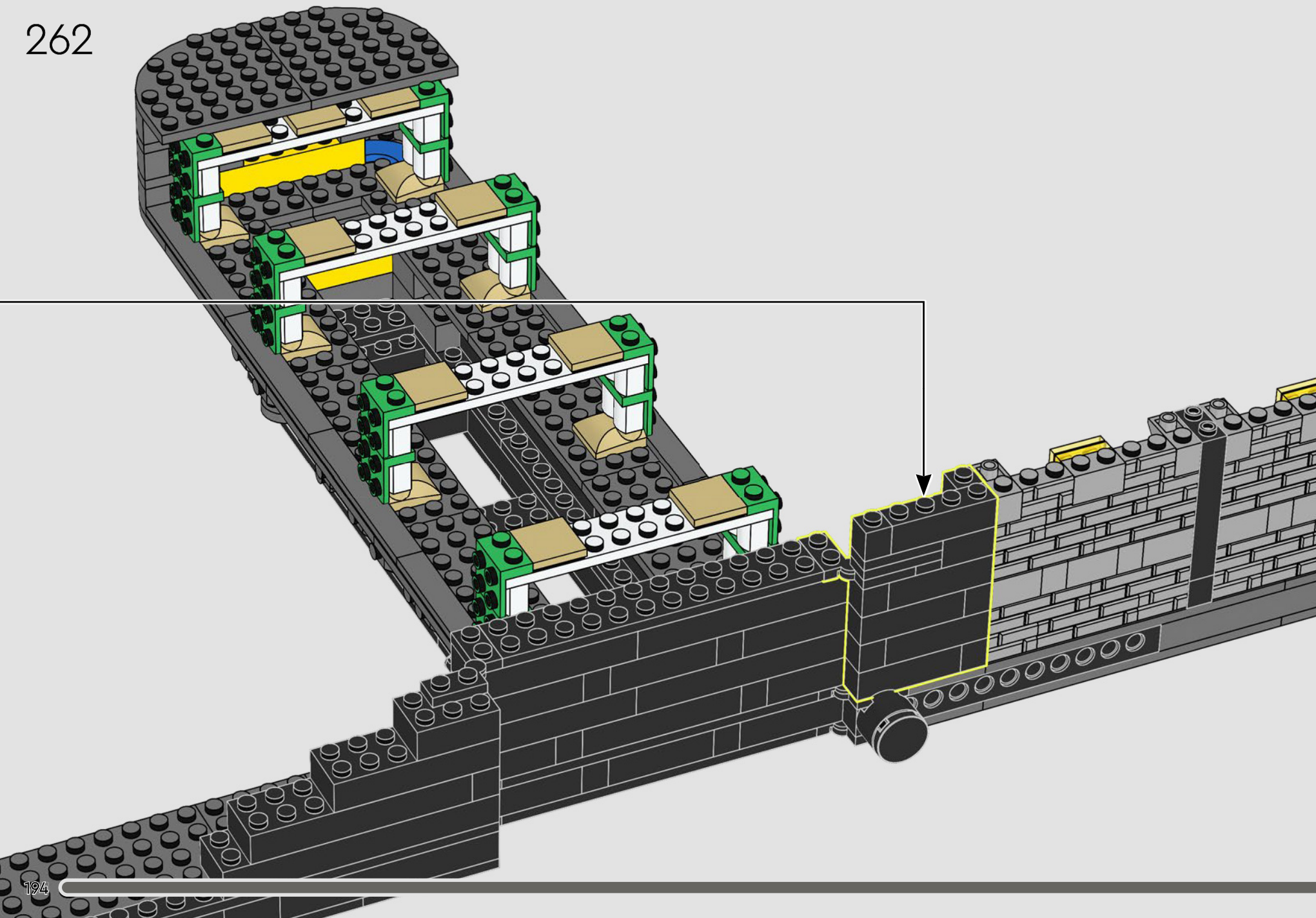

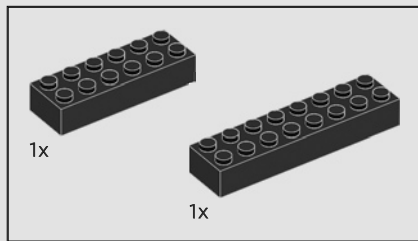

263

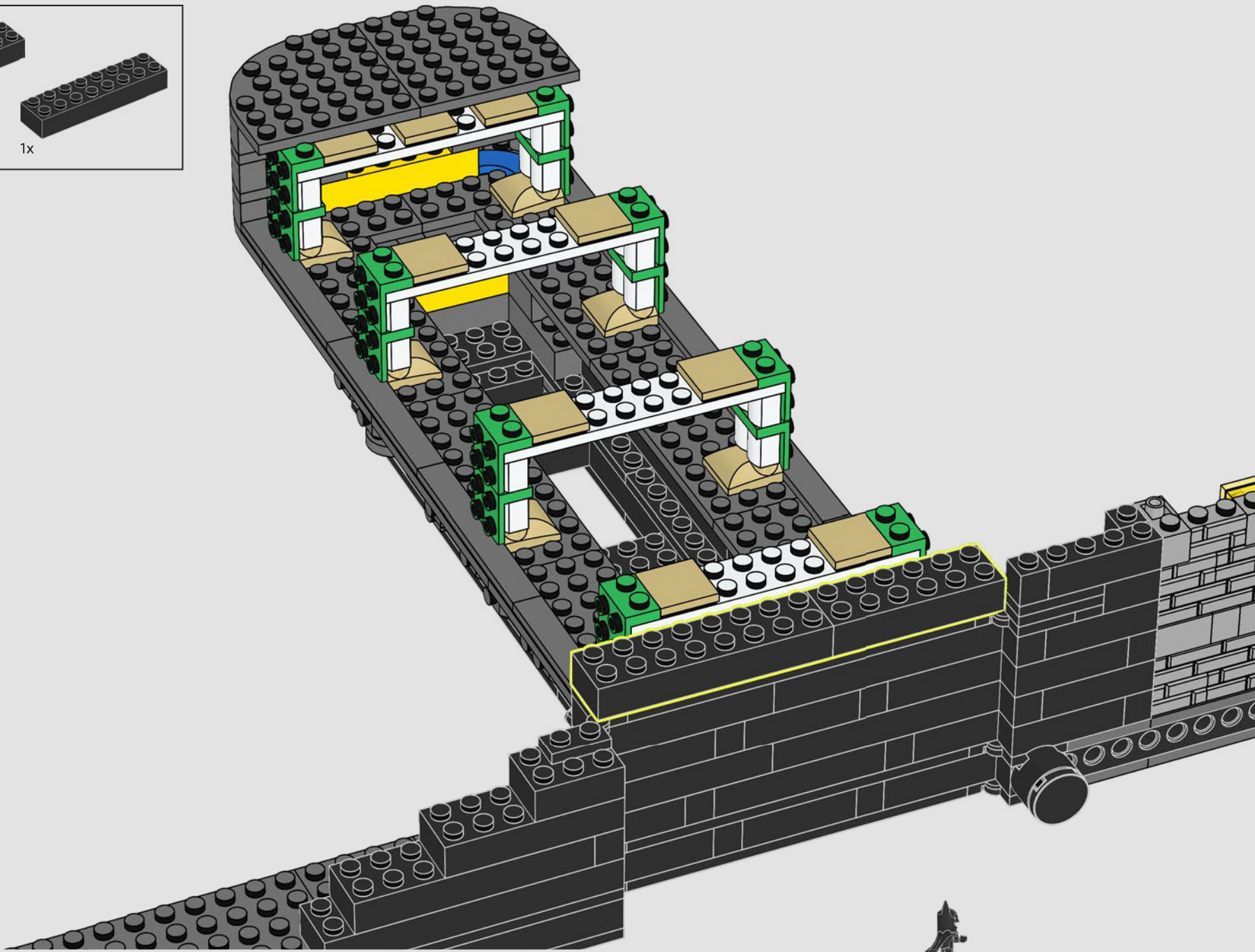

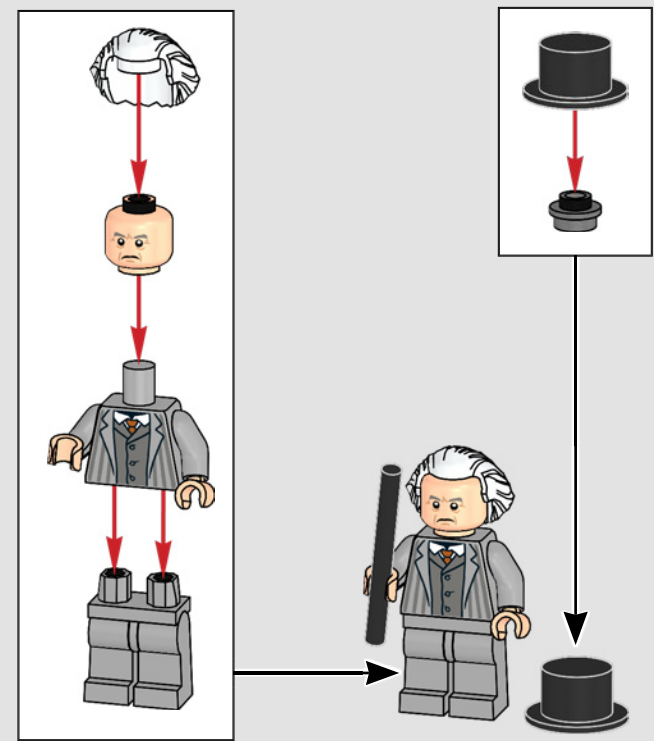
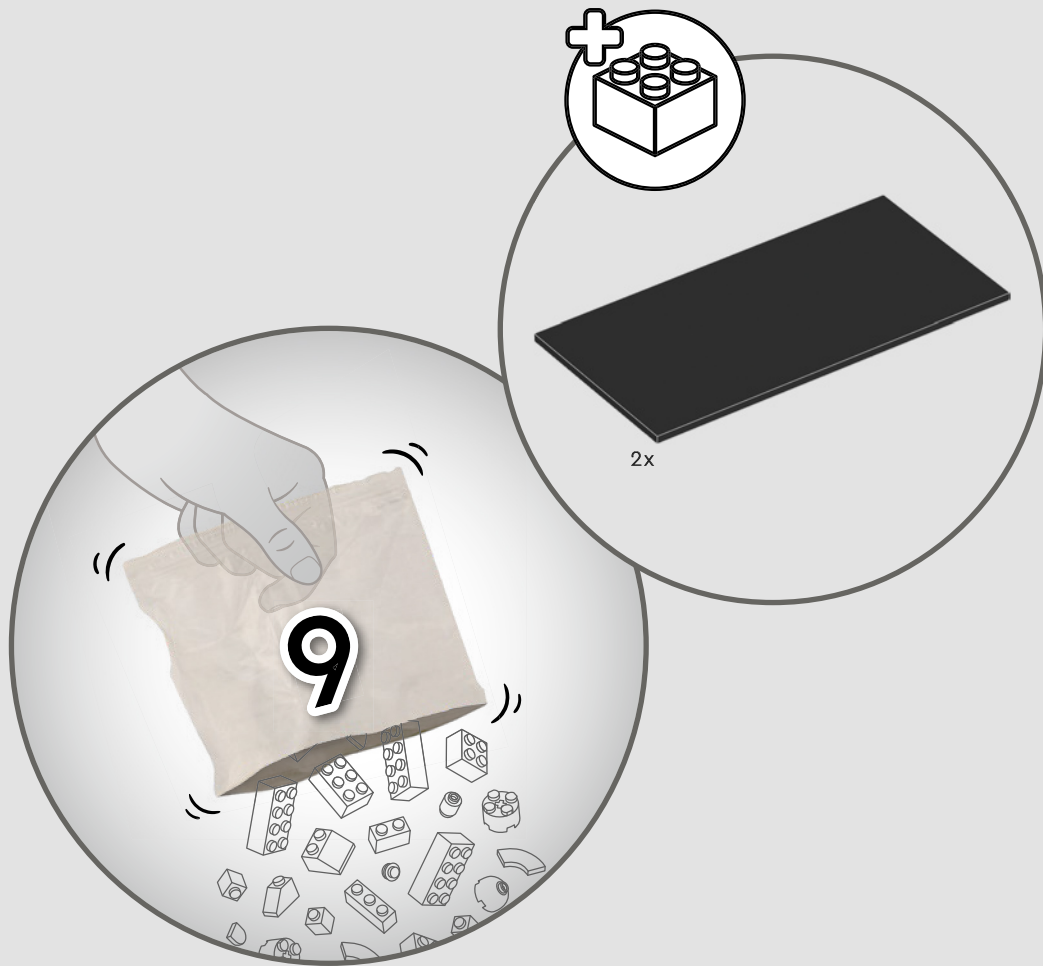



## MAX SHRECK™

Max Shreck™ ist ein durchtriebener Multimillionär mit zweifelhafter Moral und ausgeprägtem Selbsterhaltungstrieb. Er will unbedingt die Herrschaft über GOTHAM CITY™ an sich reißen. Deshalb macht er mit Oswald Cobblepot (dem Pinguin™) gemeinsame Sache, um durch korrupte Machenschaften Bürgermeister zu werden. Niemand hätte gedacht, dass ausgerechnet seine schüchterne Assistentin Selina Kyle zu seiner erbitterten Gegenspielerin wird, was sich Max aber selbst zuzuschreiben hat.



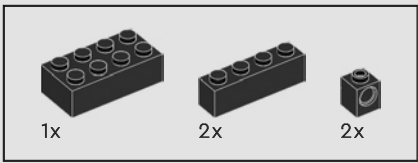

264

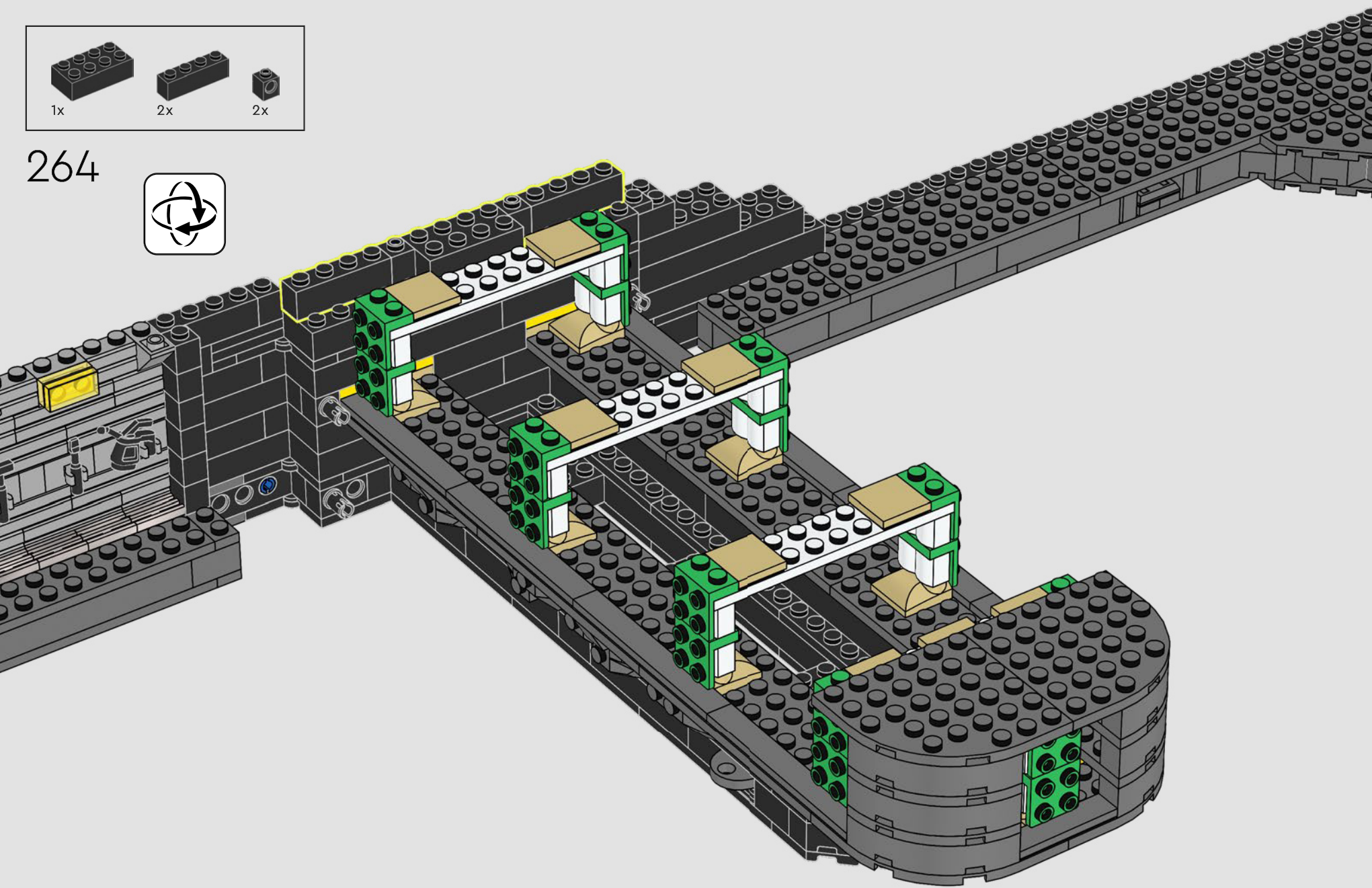

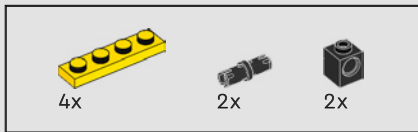

265

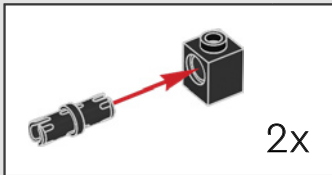
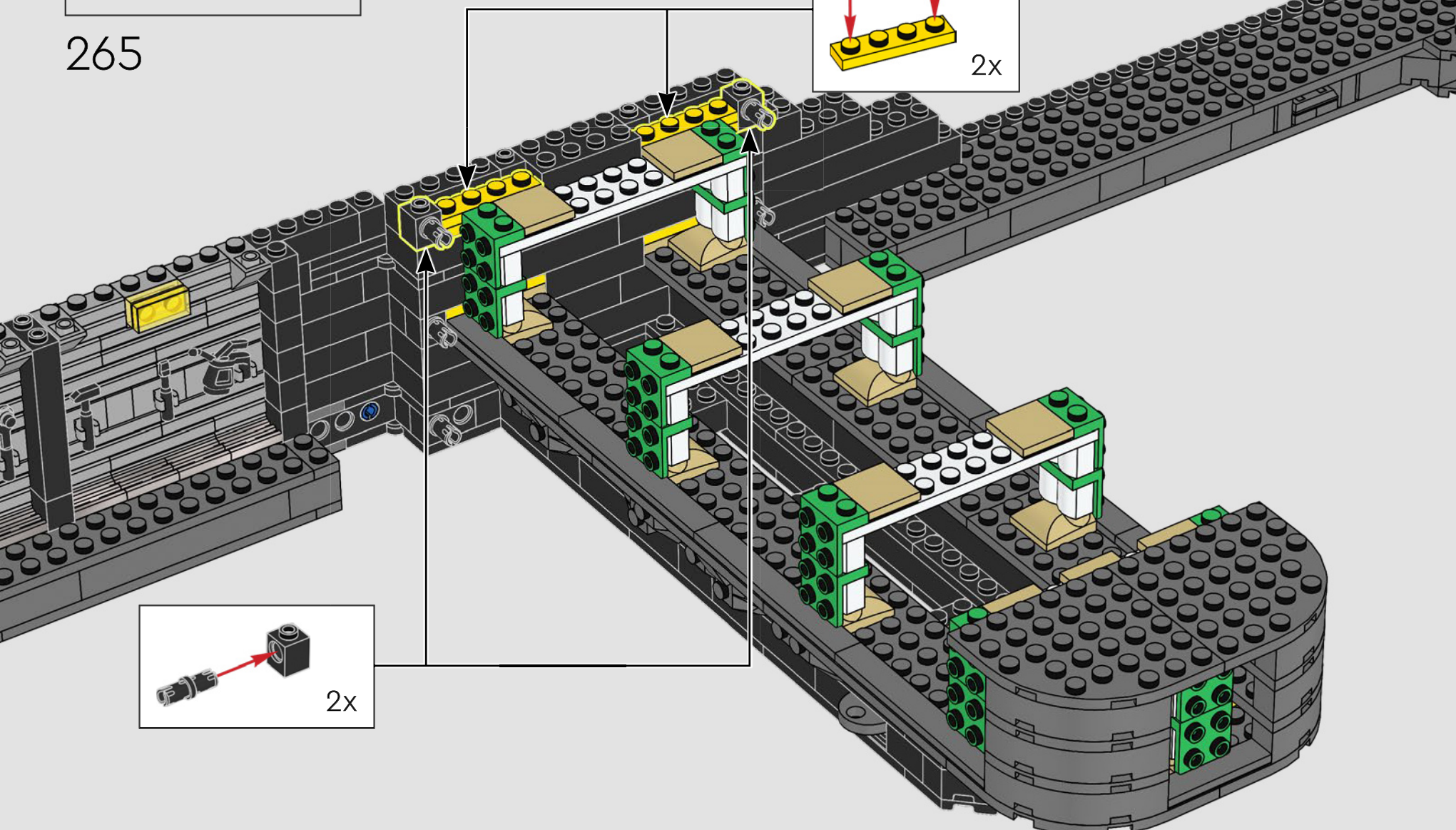
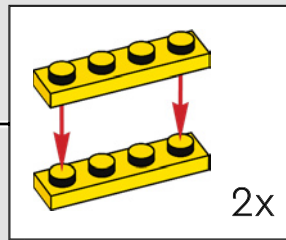

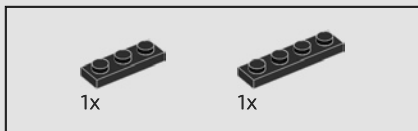

266

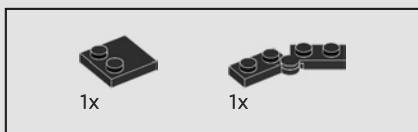
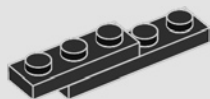

267

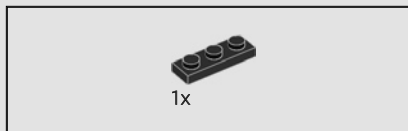
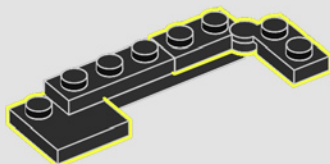

268

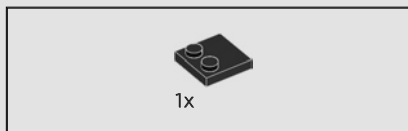
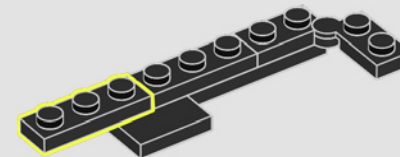

269

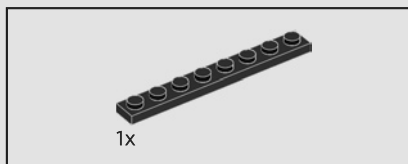
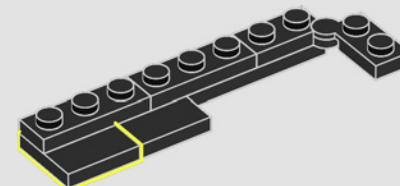

270

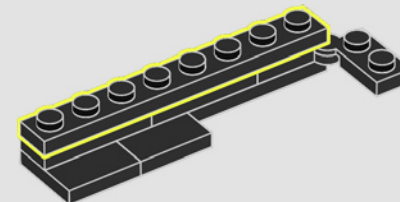



271

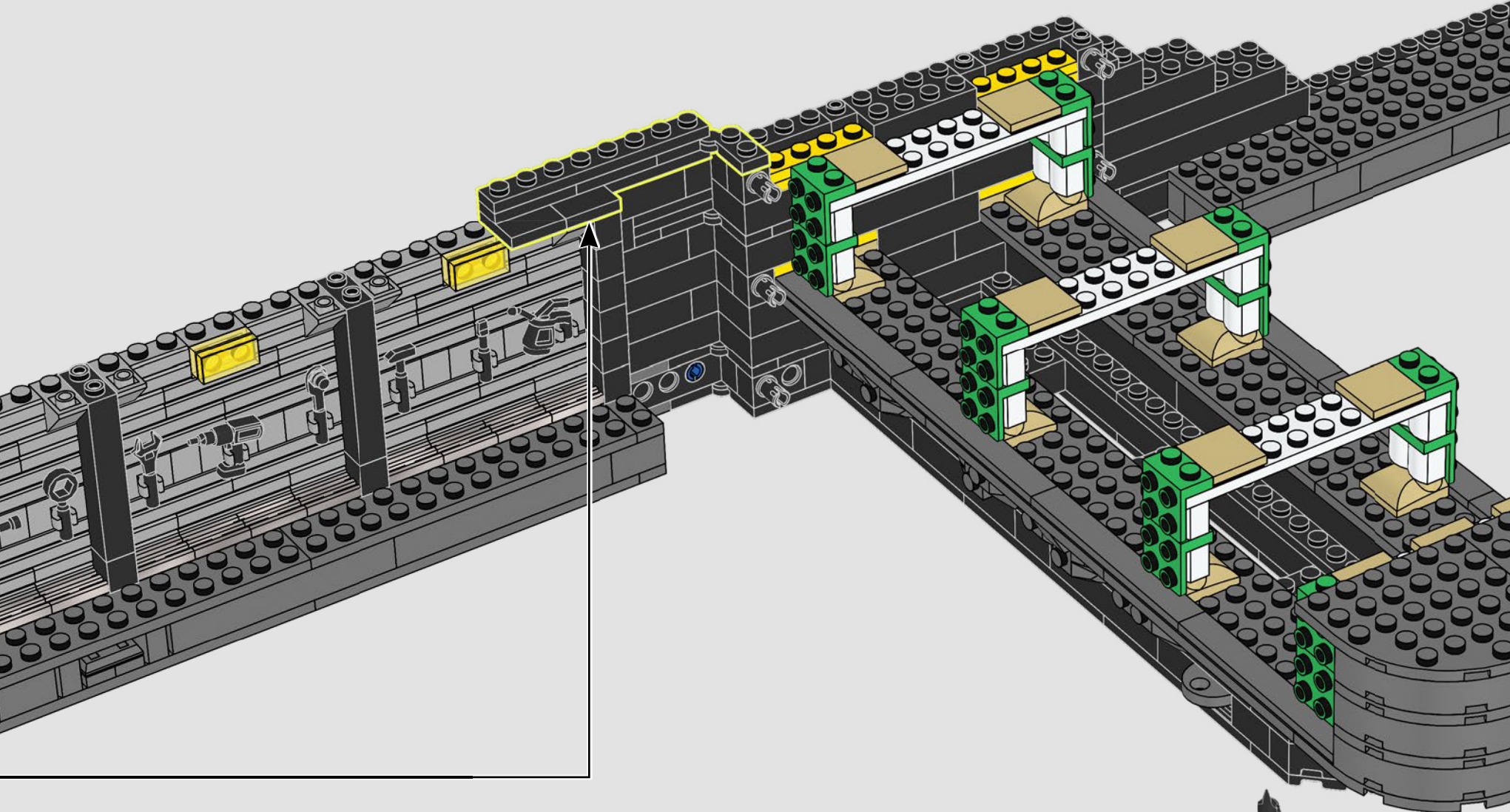

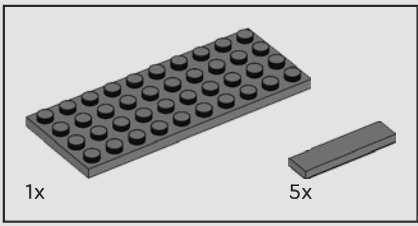

272

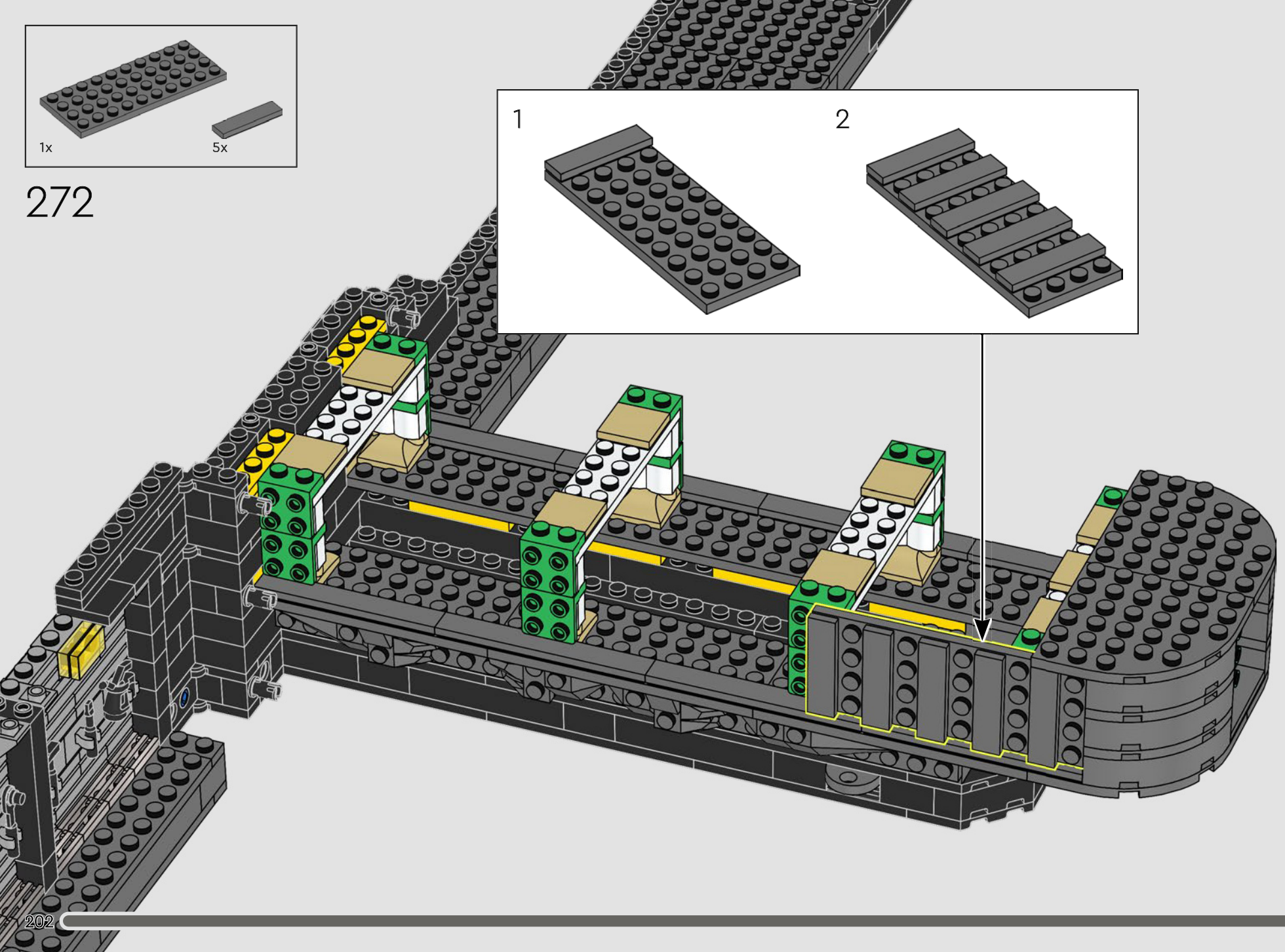
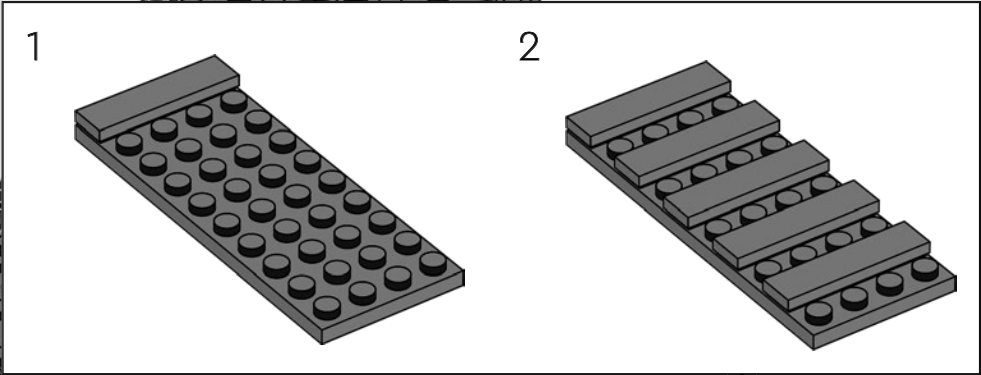

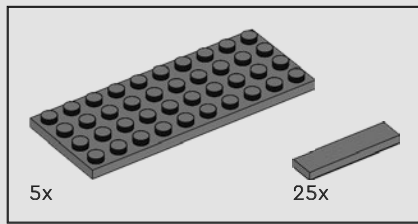

273

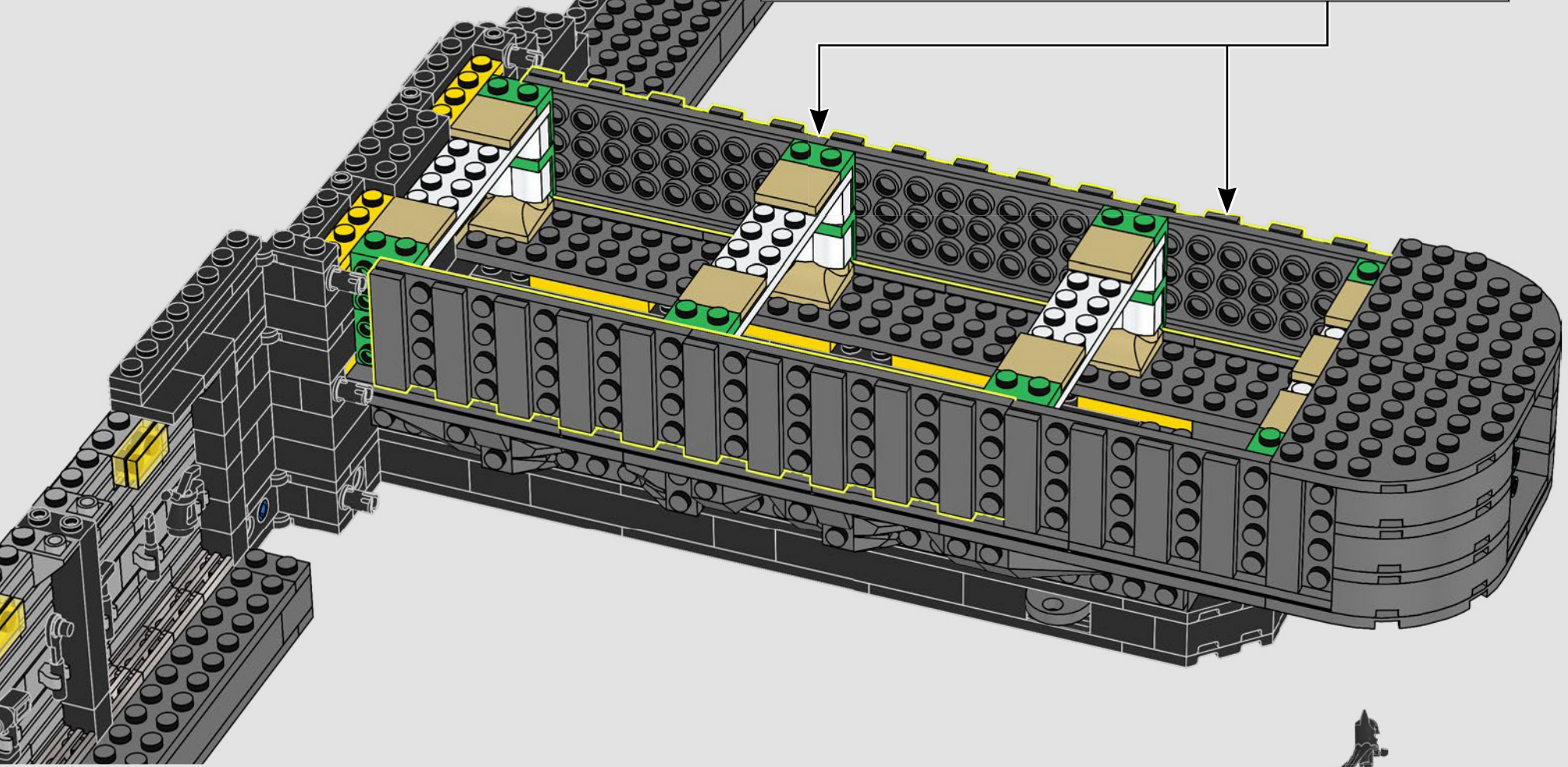
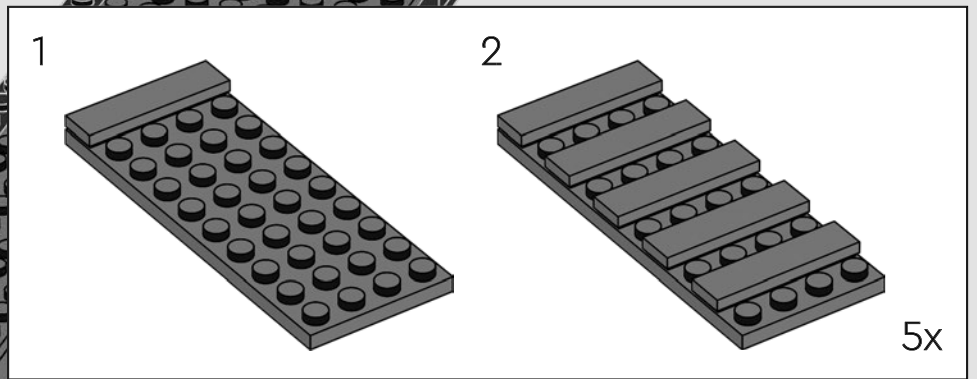

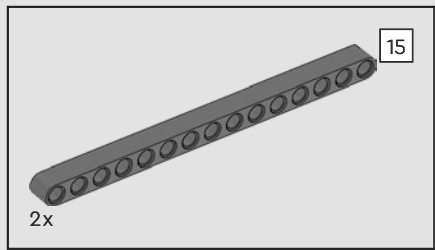

274

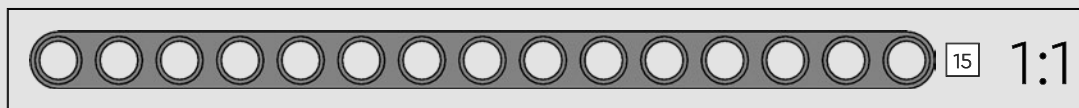
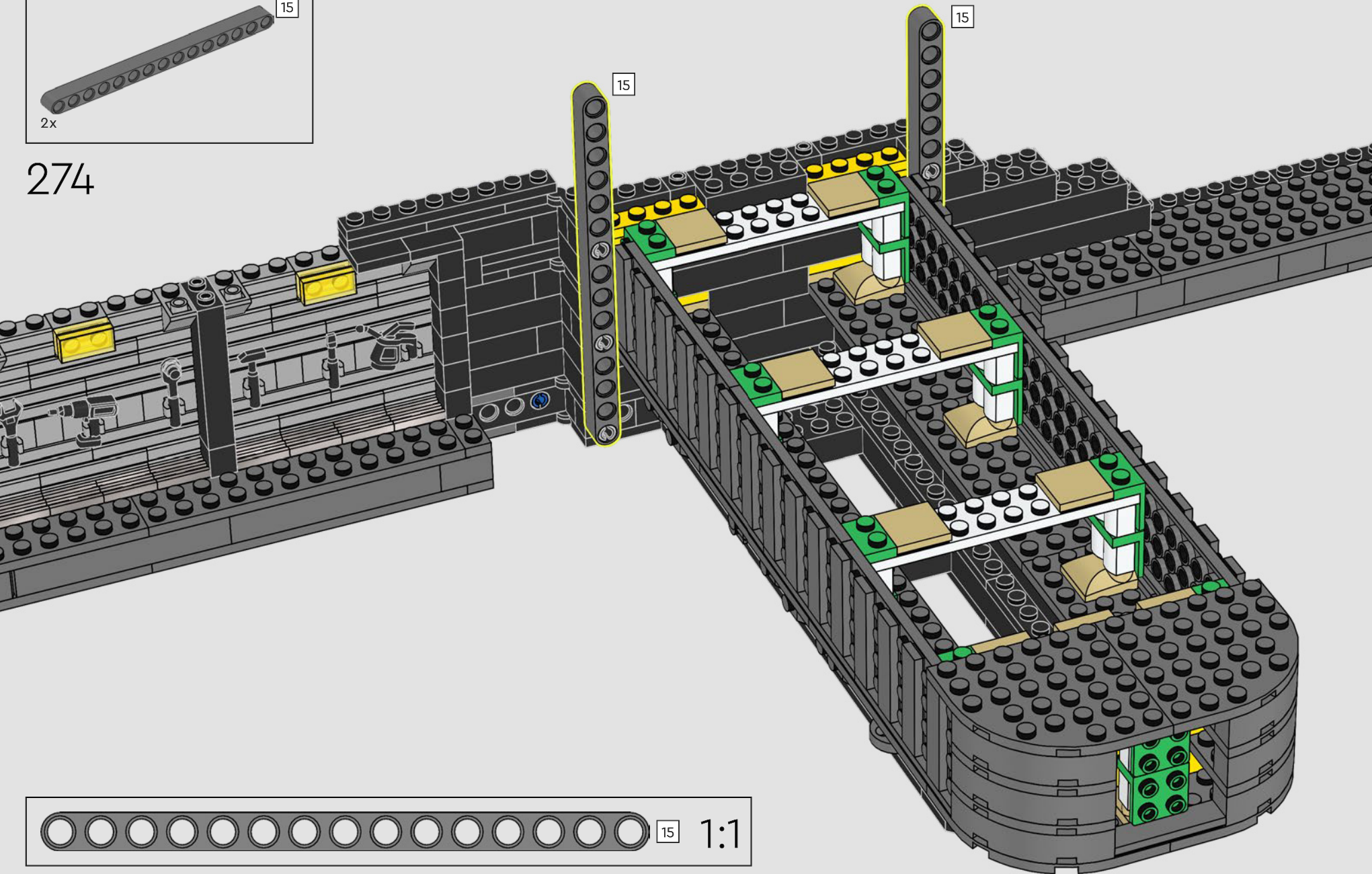

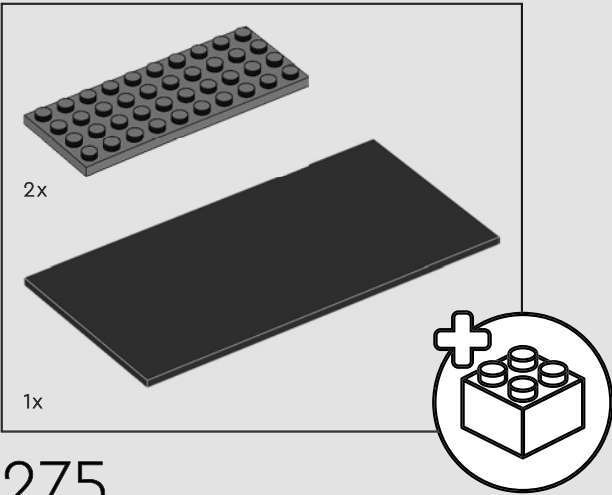
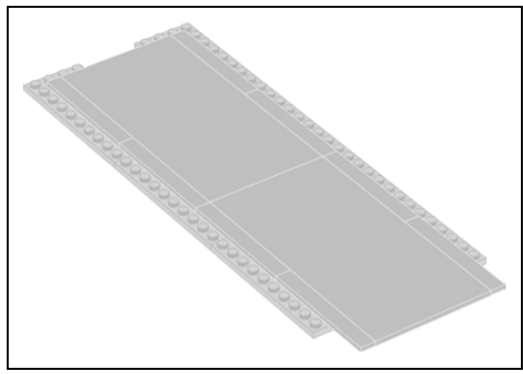

275

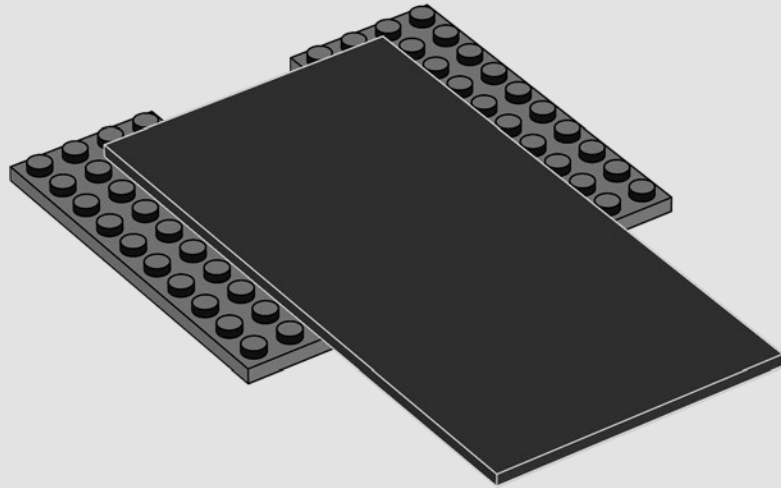

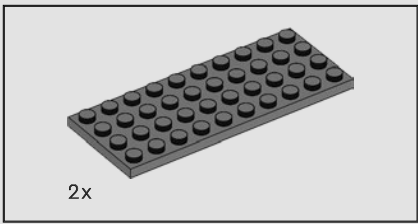

276

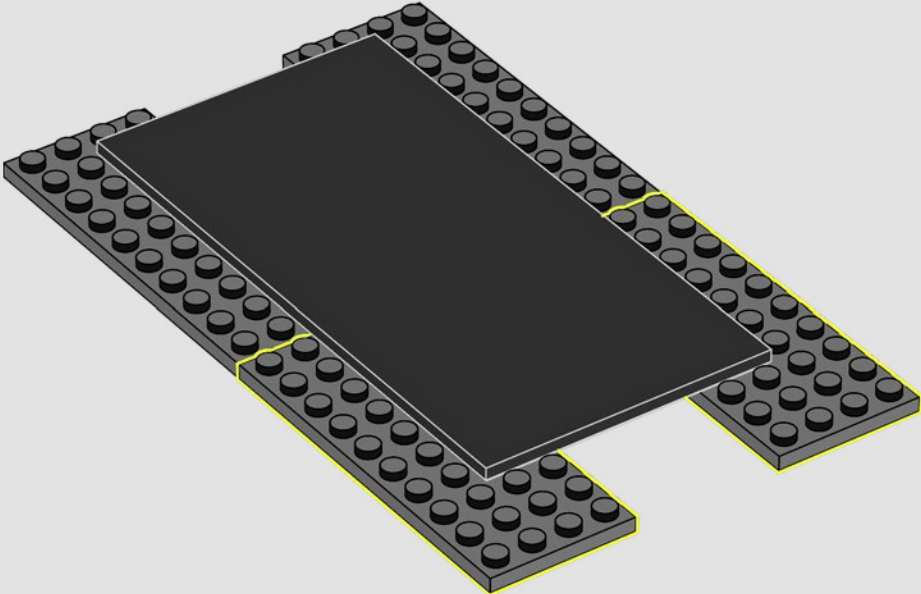

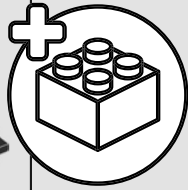
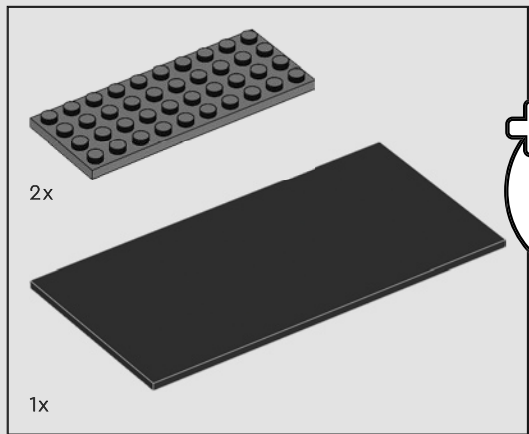

277

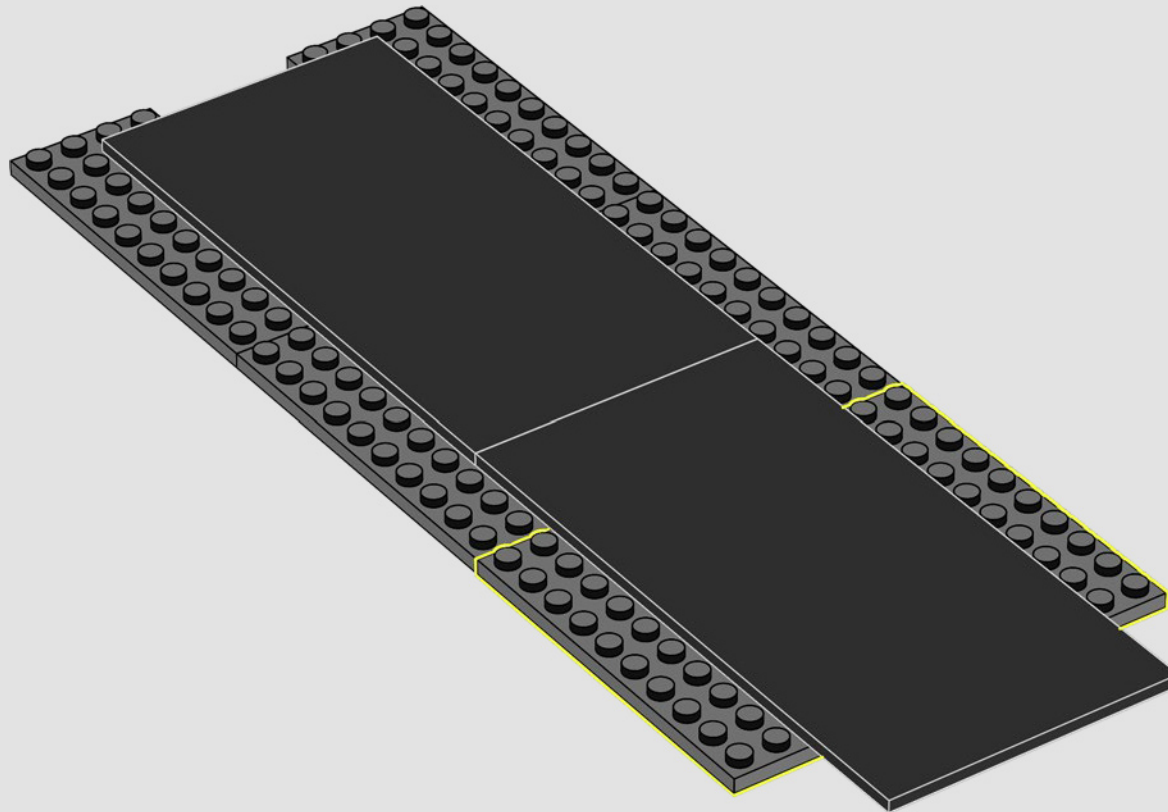

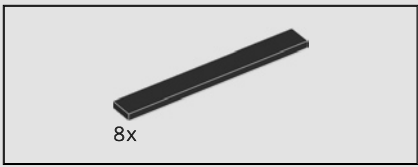

278

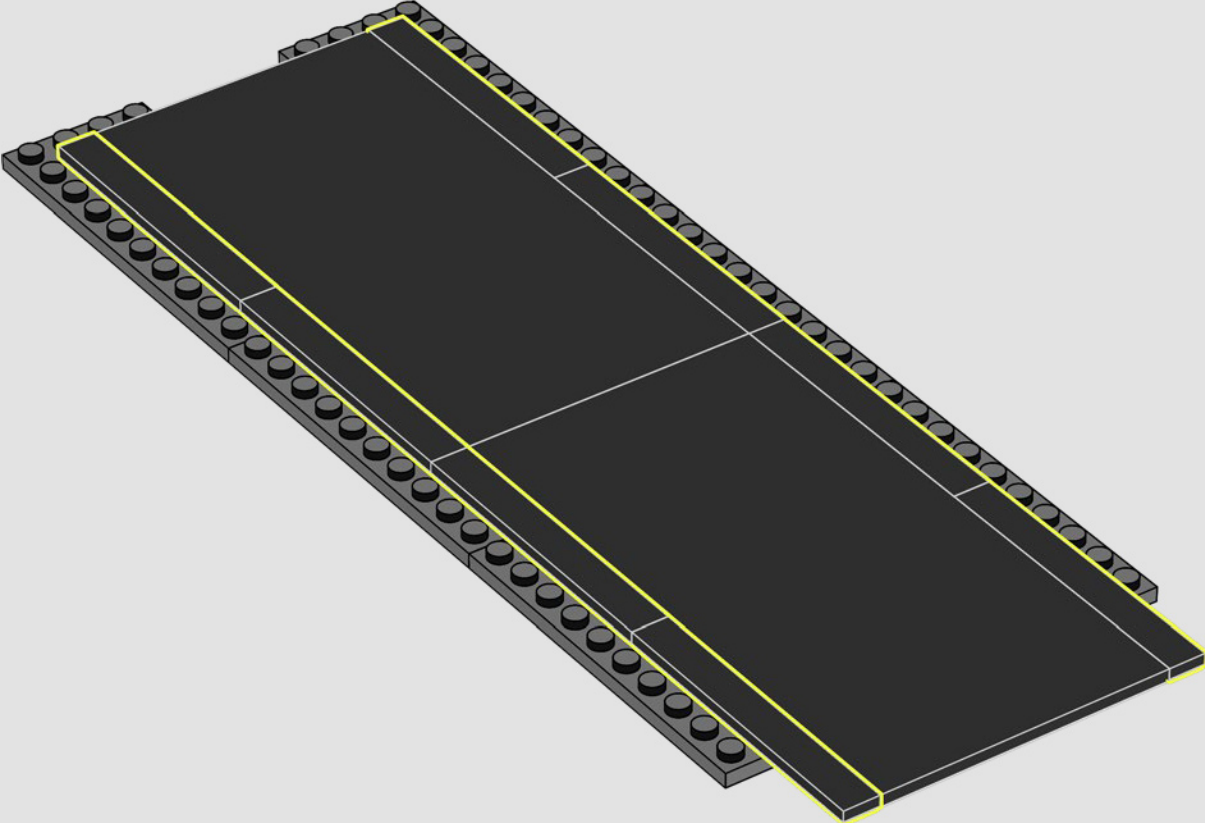



279

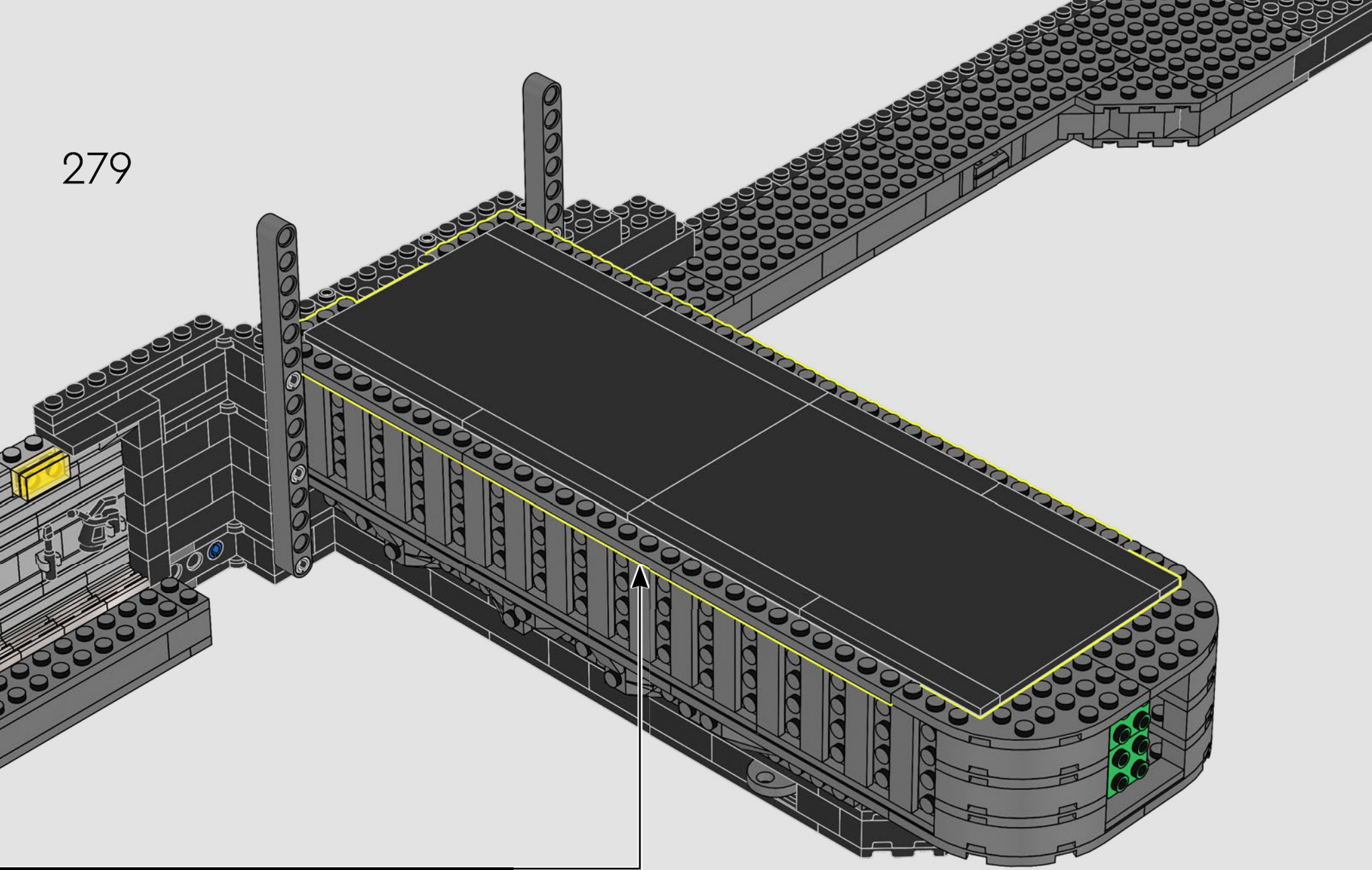

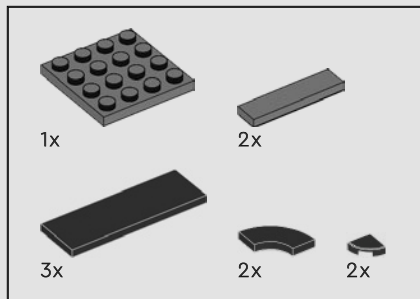

280

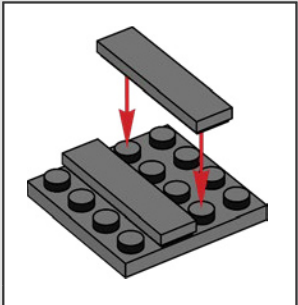
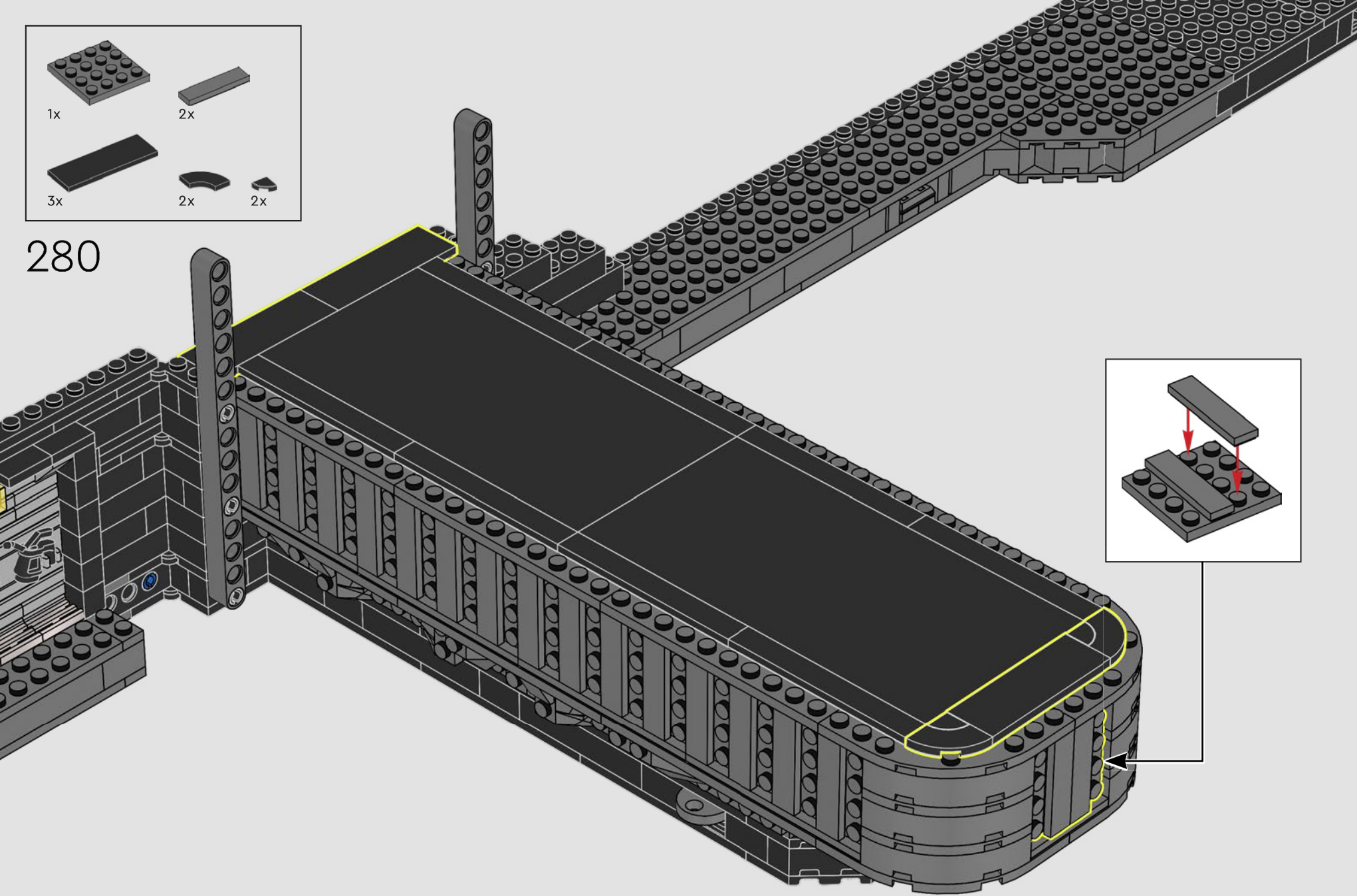

14x 14x

281

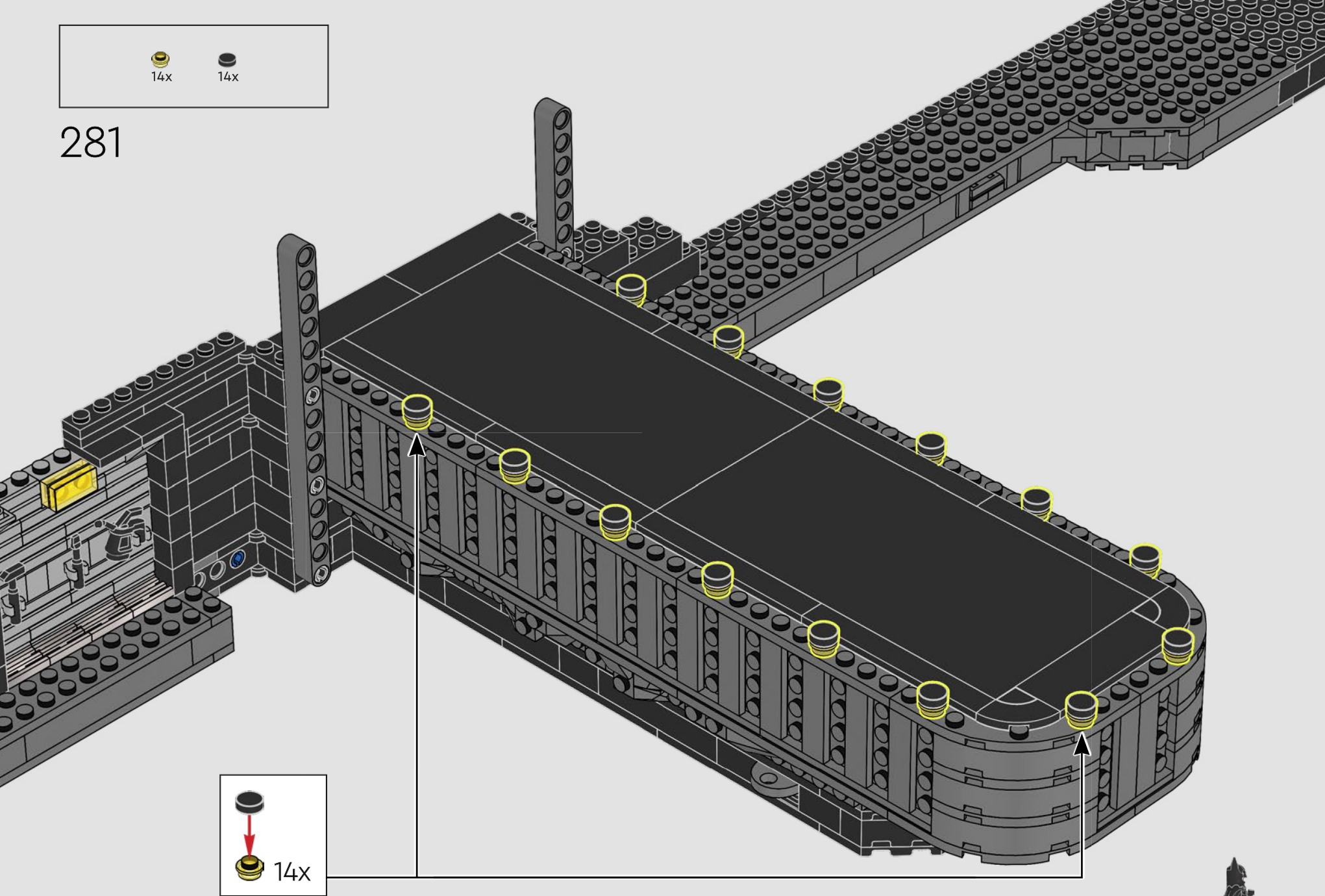

14x



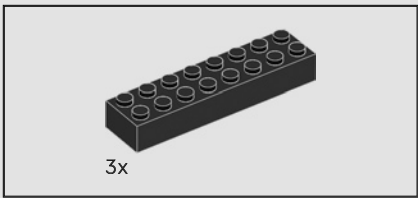

282

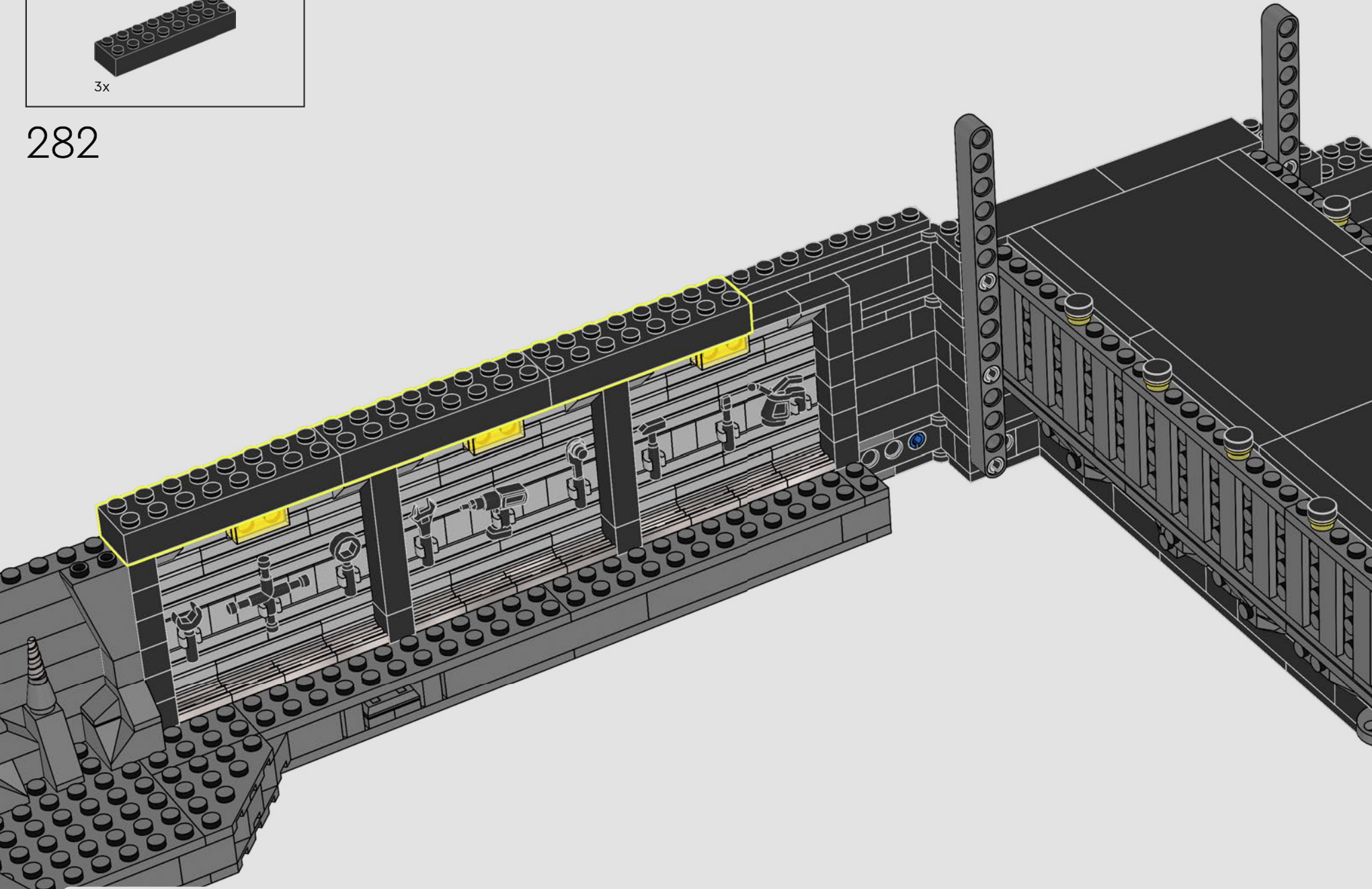

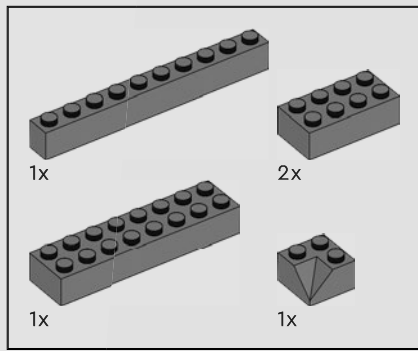

283

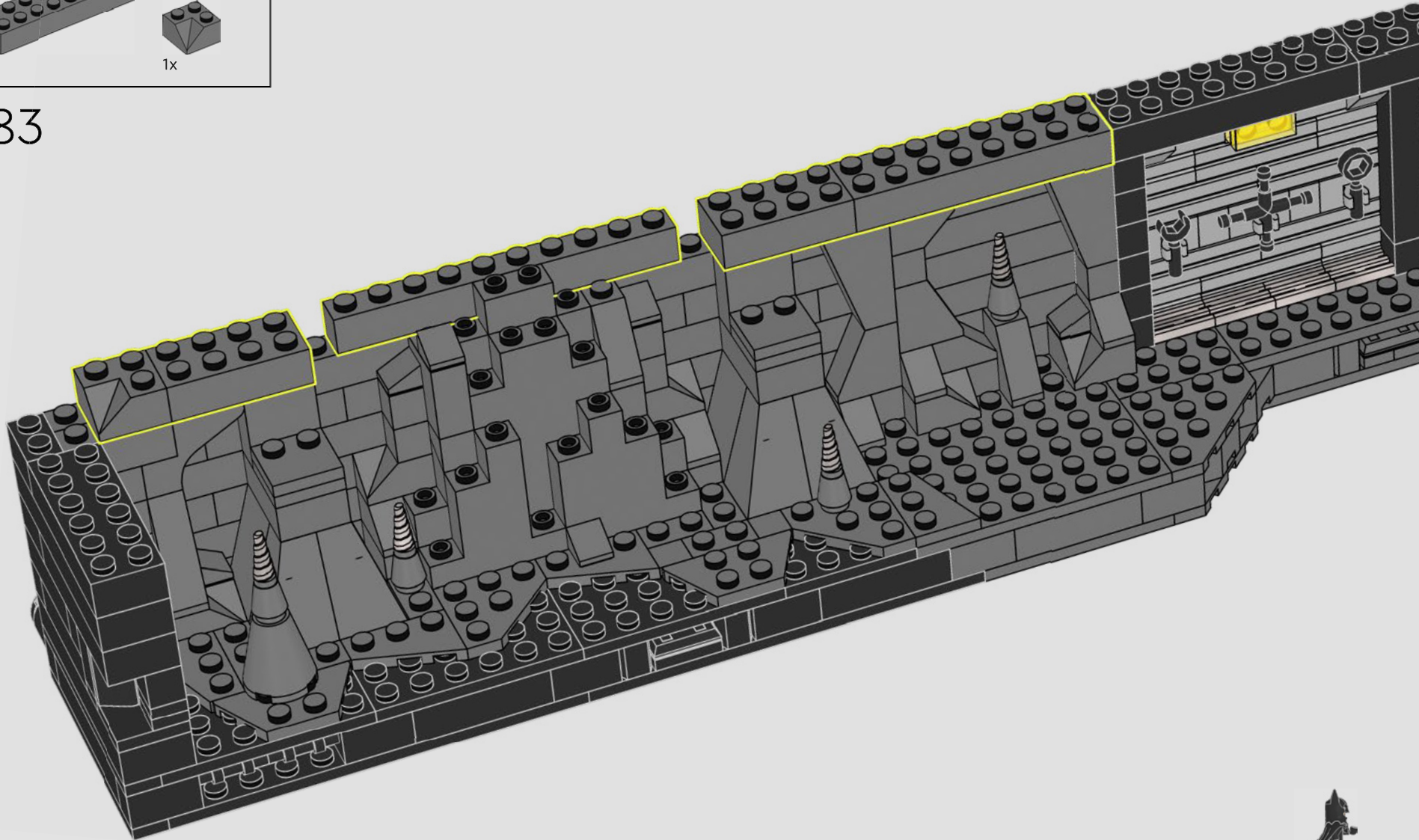

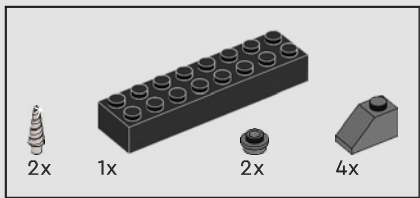

284

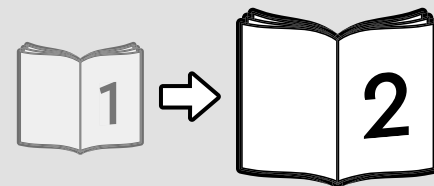
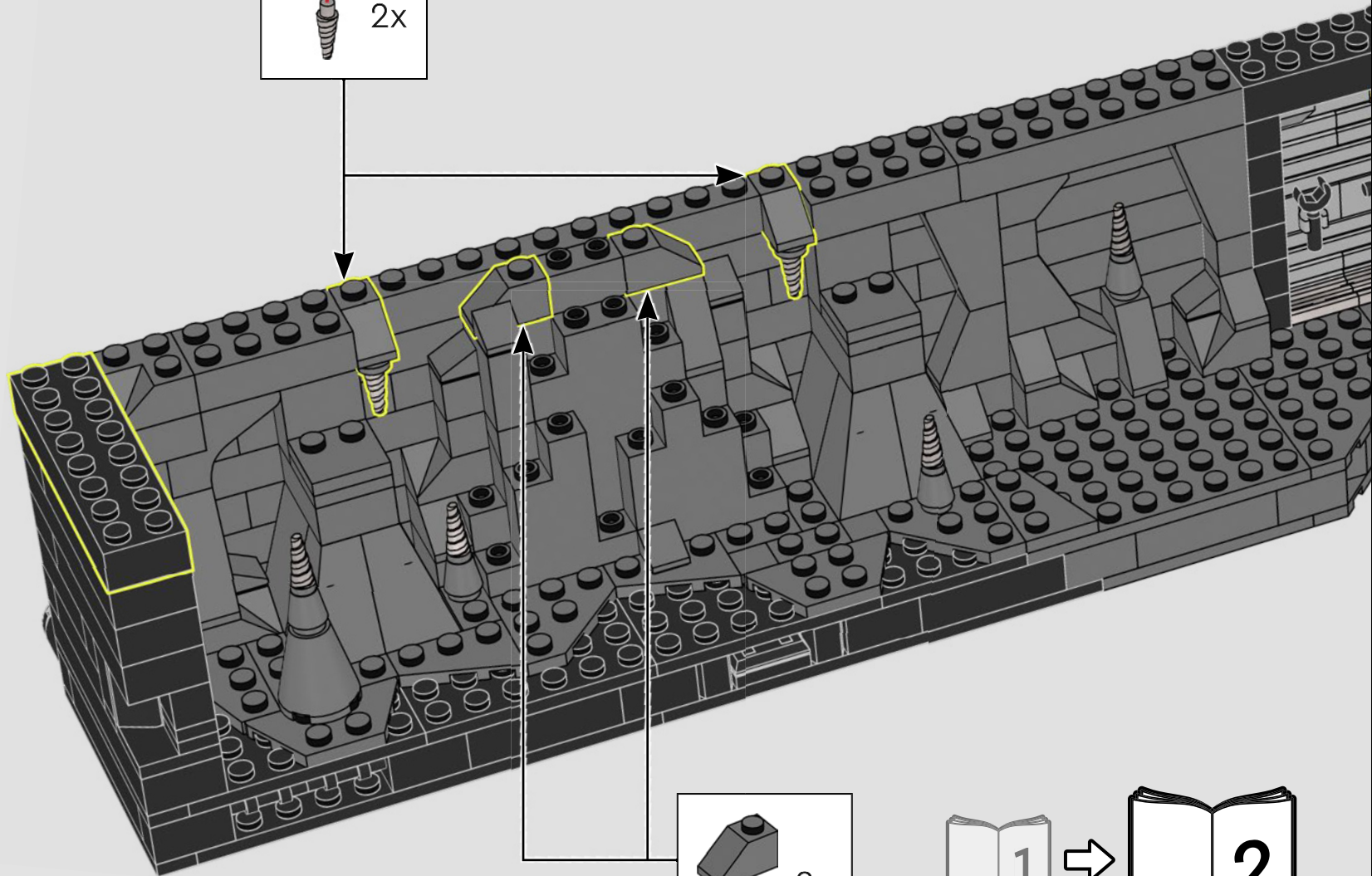
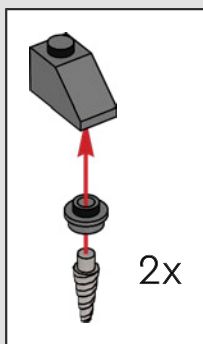



# YOU COULD WIN



## YOU COULD WIN

Your feedback will help shape the future development of this product series.

Visit:

## DU KÖNNTEST GEWINNEN

Dein Feedback trägt zur Weiterentwicklung dieser Produktreihe bei.

Geh auf:

## VOUS POURRIEZ GAGNER

Vos commentaires nous aideront à concevoir les futurs produits de cette gamme.

Visitez :

## POTRESTI VINCERE TU

La tua opinione ci aiuterà a migliorare la creazione futura di questa linea di prodotti.

Visita:

## PUEDES GANAR

Tu opinión contribuirá al futuro de esta serie de productos.

Visita:

## 轻松获奖

您的反馈将有助于我们在今后改进本产品系列。

请访问:

---

**[LEGO.com/productfeedback](https://www.lego.com/productfeedback)**

---

You also have the chance to win a LEGO® set.

Terms and conditions apply.\*

Außerdem hast du die Chance, ein LEGO® Set zu gewinnen.

Es gelten die Teilnahmebedingungen.\*

Vous pourriez également gagner un ensemble LEGO®.

Des conditions s'appliquent.\*

Hai anche la possibilità di vincere un set LEGO®.

Termini e condizioni sono applicabili.\*

También tienes la oportunidad de ganar un set LEGO®.

Aplican términos y condiciones.\*

您还有机会赢取乐高®套装。

条款和条件适用。\*

\*[LEGO.com/productfeedback-terms](https://www.lego.com/productfeedback-terms)

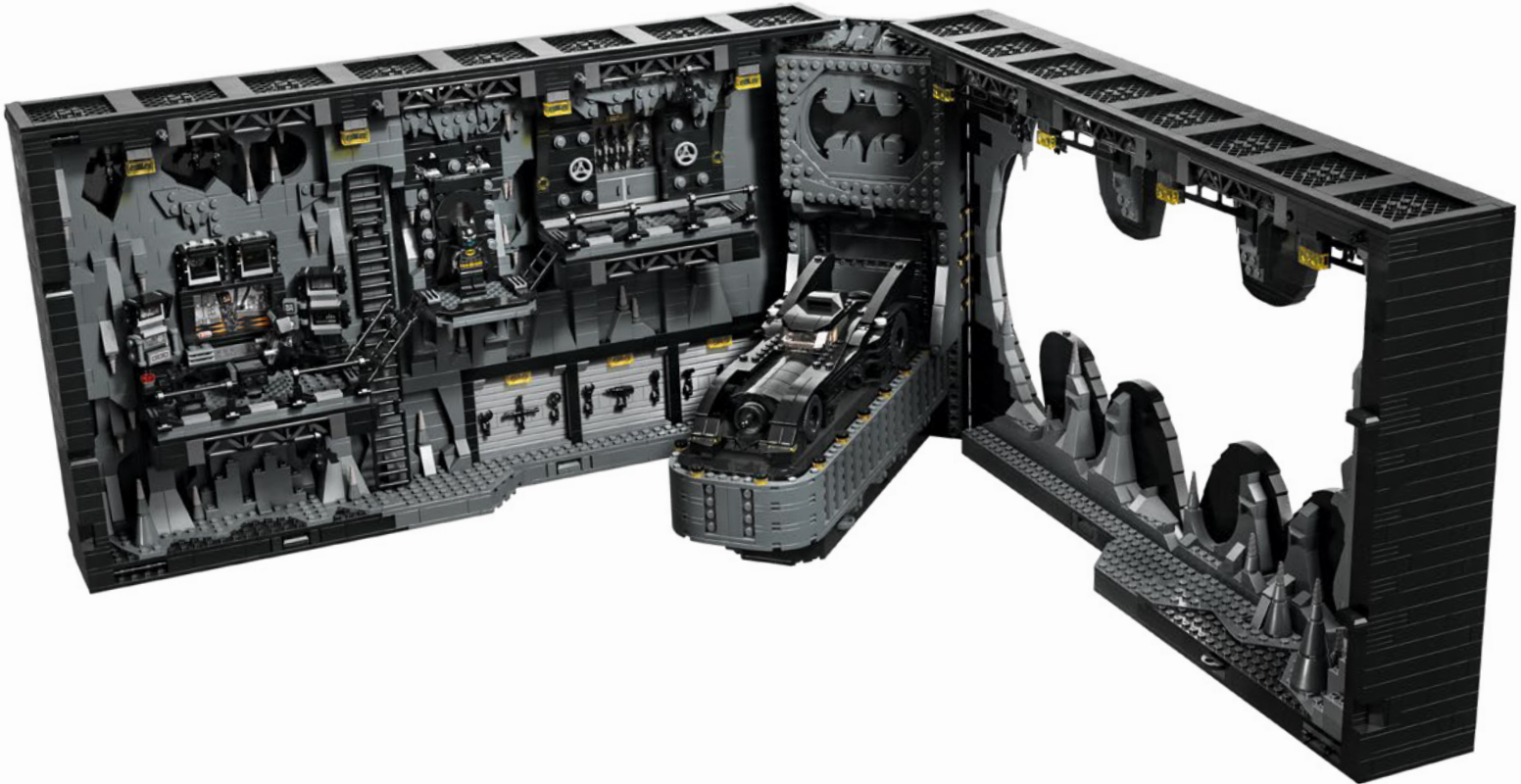

## 76252

LEGO and the LEGO logo are trademarks of the LEGO Group. ©2023 The LEGO Group.  
BATMAN RETURNS and all related characters and elements © & ™ DC and Warner Bros. Entertainment Inc. (s23)

