



MARVEL

76278



Q LEGO® Builder



Get excited about our new packaging!

We're switching from plastic to paper-based packaging. That's why you might find a mix of paper and plastic in our boxes!

Nos nouveaux emballages vous emballeront !

Nous passons des emballages en plastique aux emballages à base de papier. C'est pourquoi vous pourriez trouver un mélange de papier et de plastique dans nos boîtes !

¡Te presentamos nuestros nuevos empaques!

Estamos sustituyendo las bolsas de plástico por bolsas con base de papel. ¡Por eso, puedes encontrar una mezcla de papel y de plástico en nuestras cajas!

[LEGO.com/sustainable-packaging](https://www.lego.com/sustainable-packaging)



BUILDER



Apple and the Apple logo are trademarks of Apple Inc., registered in the U.S. and other countries and regions. App Store is a service mark of Apple Inc. Google Play and the Google Play logo are trademarks of Google LLC. Tencent and the Tencent logo are trademarks of Tencent Inc.

LEGO.com/devicecheck

EN Ask parents' permission before going online | DE Eltern um Erlaubnis bitten, bevor du online gehst | FR Demande l'autorisation d'un parent avant d'aller en ligne | IT Chiedi il permesso ai tuoi genitori prima di andare online | ES Pídeles permiso a tus papás antes de conectarte a Internet | PT Peça autorização aos pais antes de acederes online | ZH 上网前应先征得父母的同意 | PL Poproś rodziców o zgodę, zanim wejdiesz do Internetu | CS Než půjdeš na internet, požádej rodiče o svolení | SK Skôr než pôjdeš na internet, vypýtaj si povolenie od rodičov | HU Kérj szülői engedélyt, mielőtt online csatlakoznál! | RO Cere permisiunea părinților înainte de a te conecta online | BG Поискайте разрешение от родител, преди да влезете онлайн | LV Pirms došanās tiešsaistē palūdz atļauju vecākiem | ET Enne Interneti kasutamist küsi vanematelt luba | LT Prieš prisijungdami prie interneto, atsklauskite tėvų

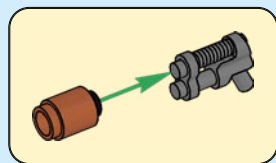
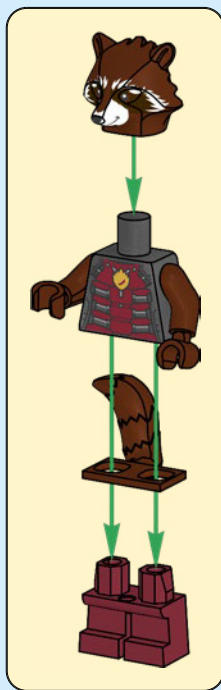

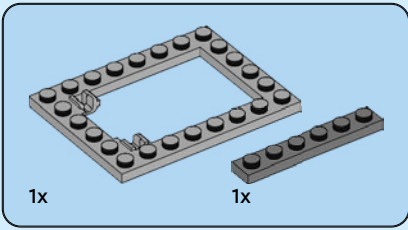

1

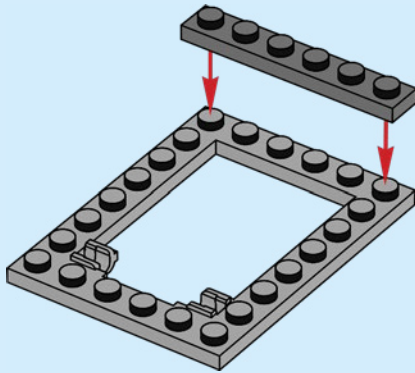

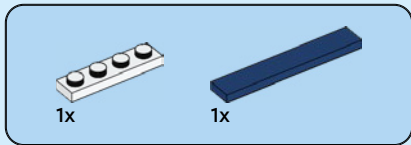

2

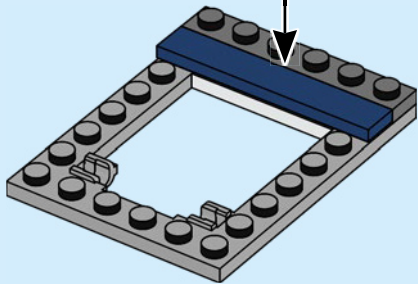
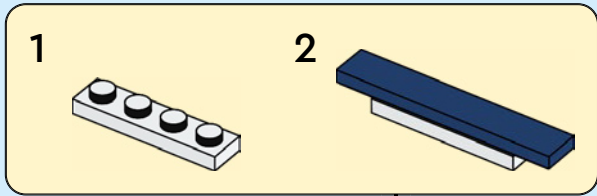

3

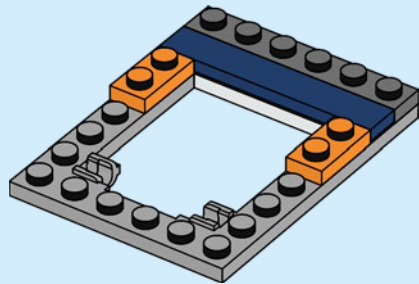

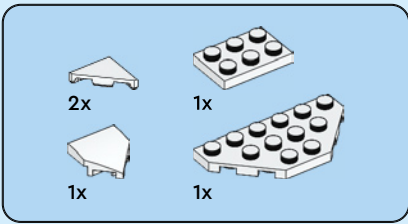

4

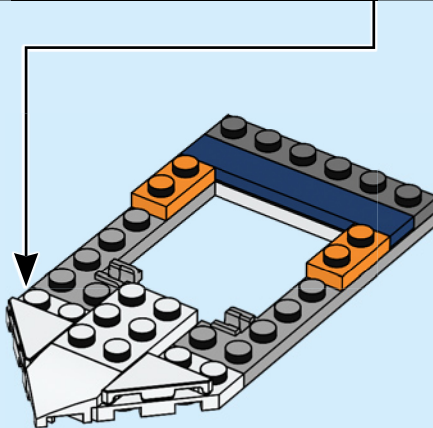
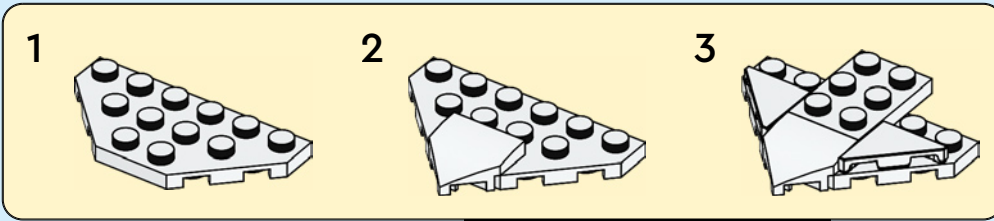

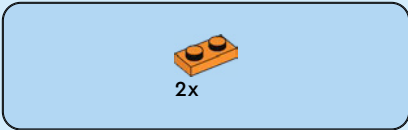

5

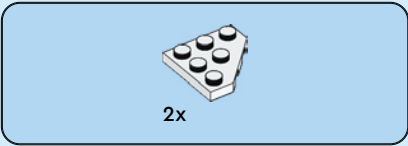
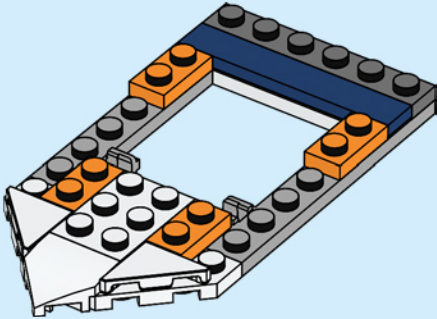

6

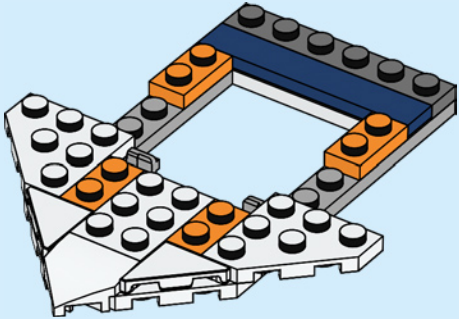

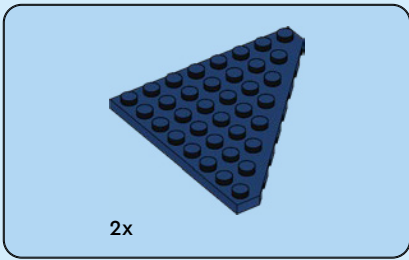

7

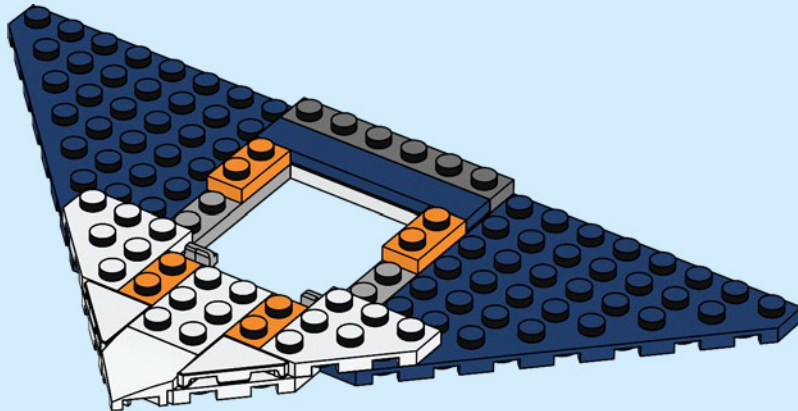



2x

8

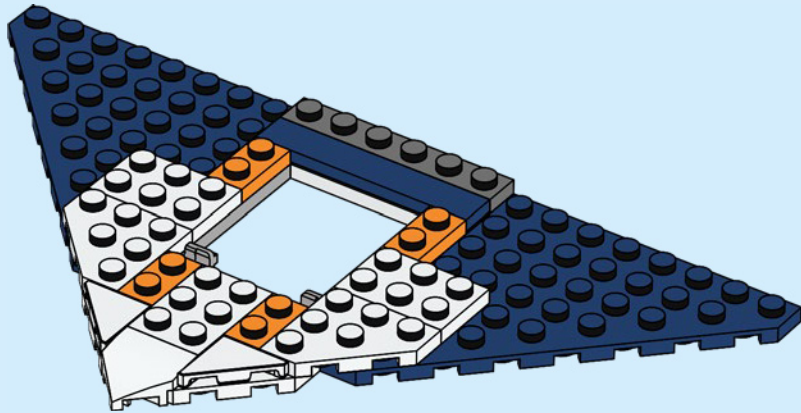

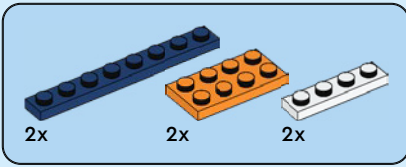

9

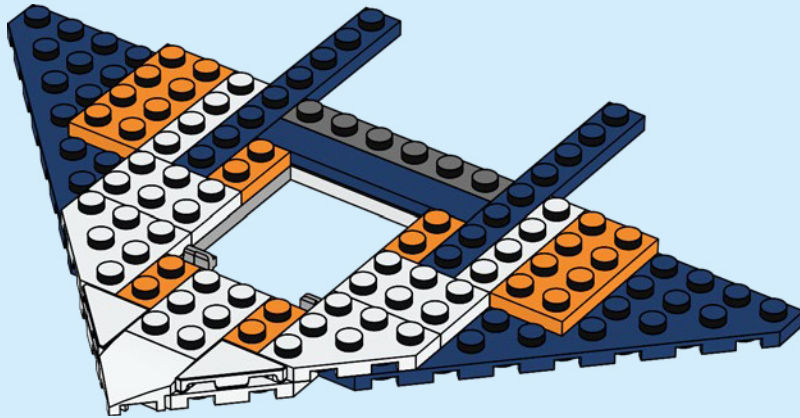

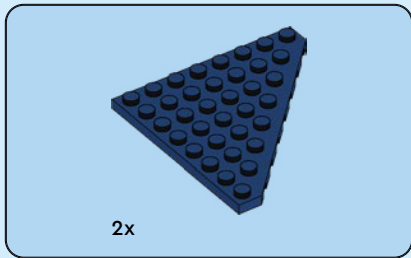

10

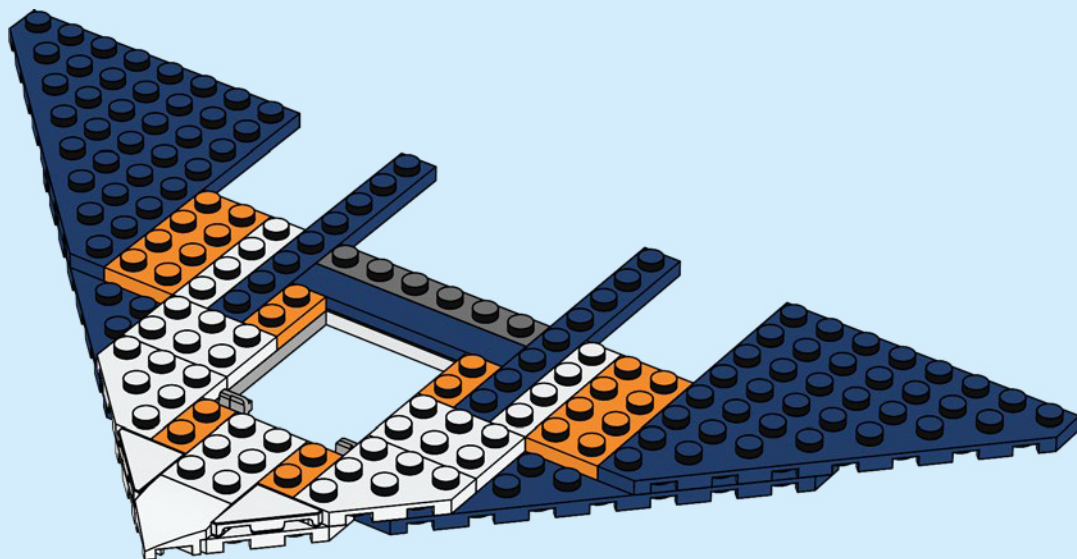



2x

11

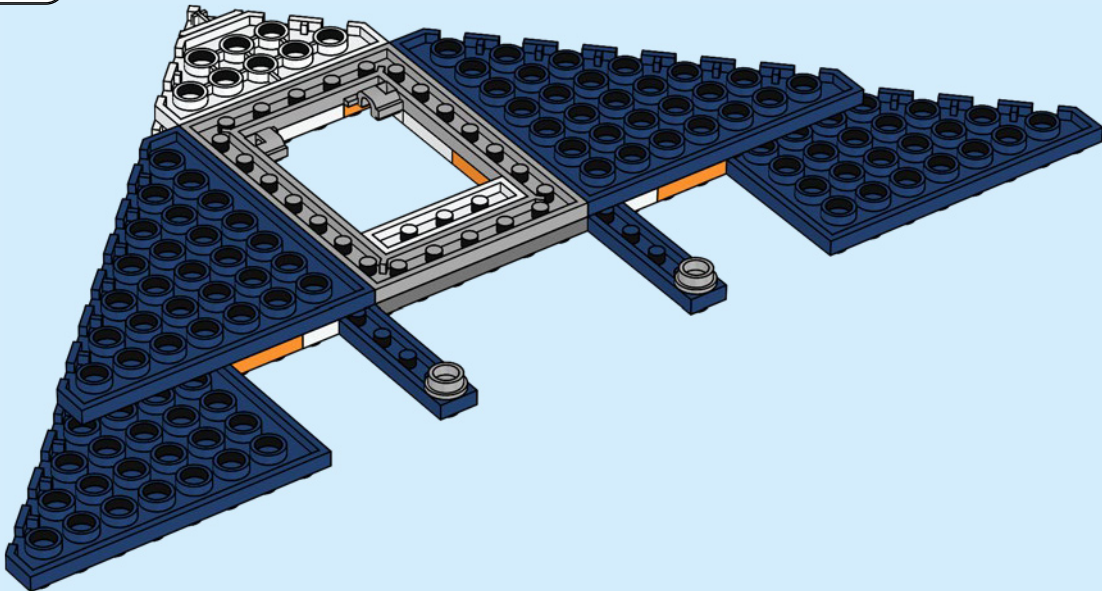

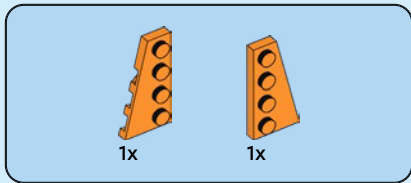

12

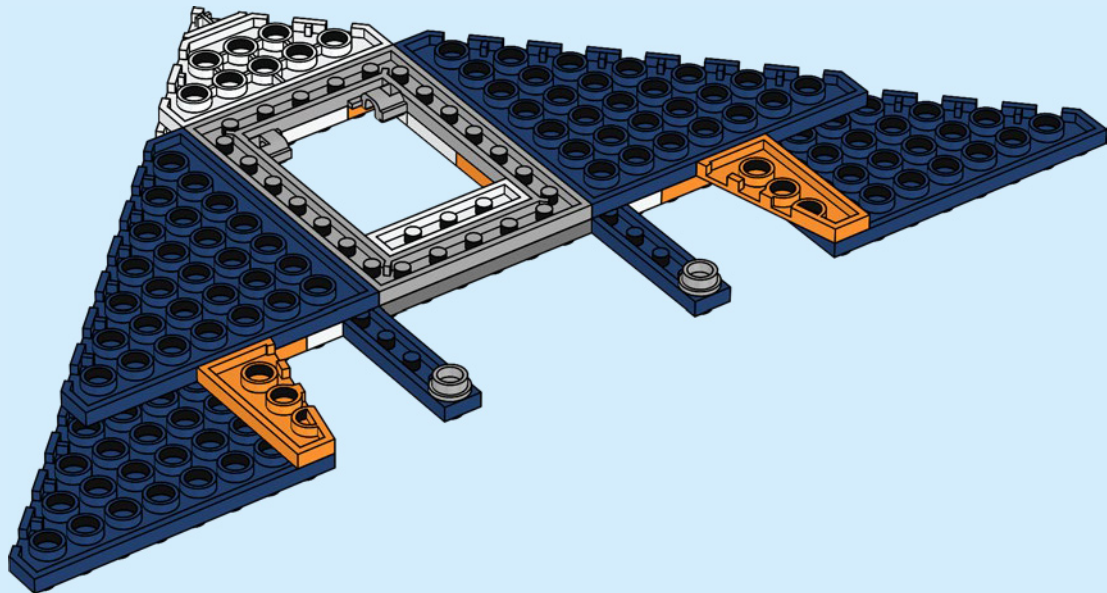

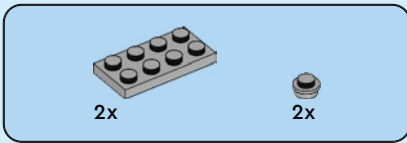

13

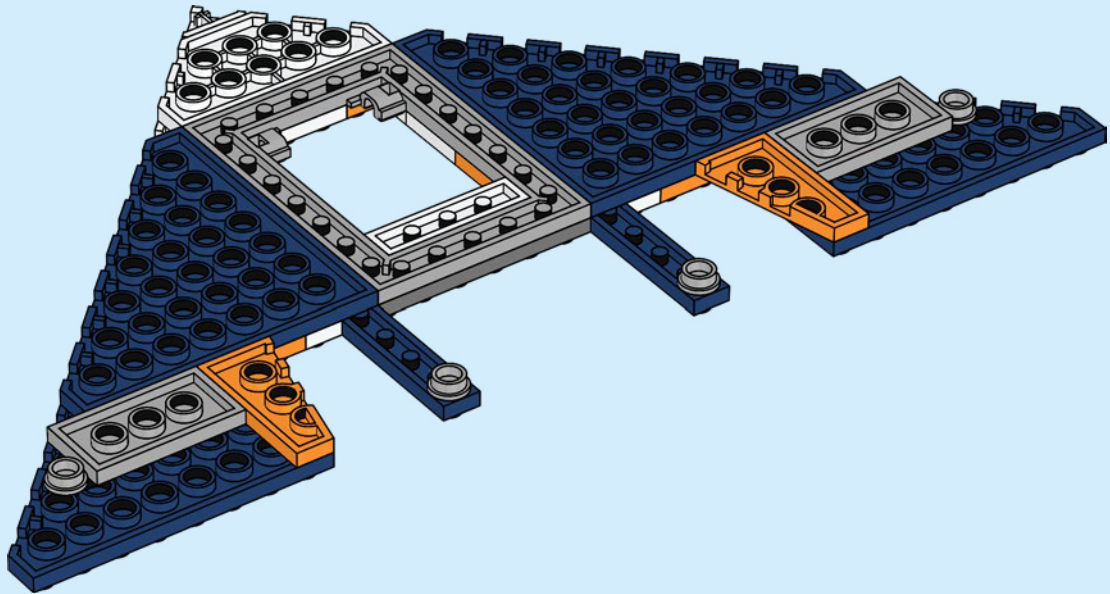

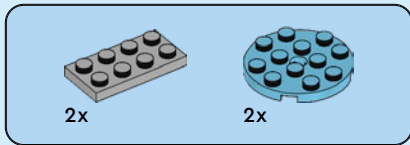

14

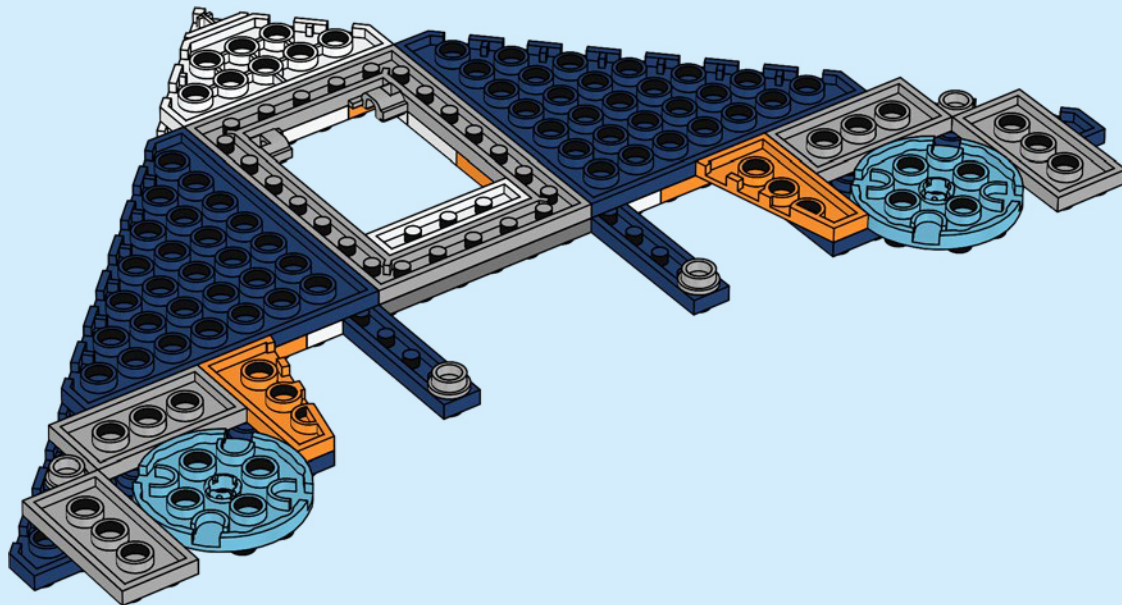

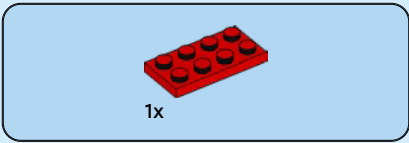

15

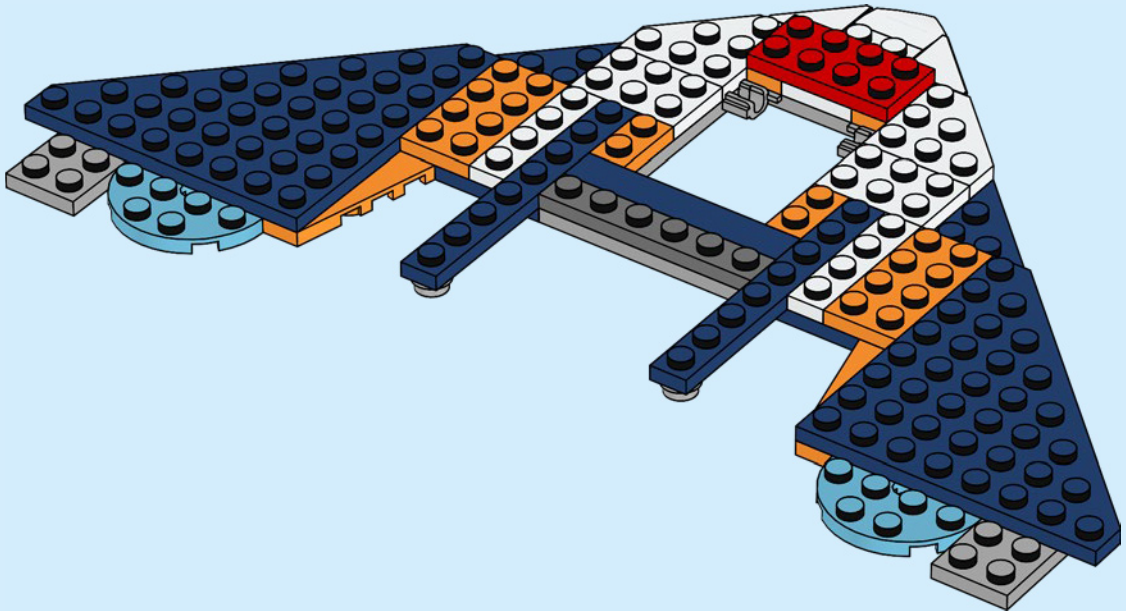



4x

16

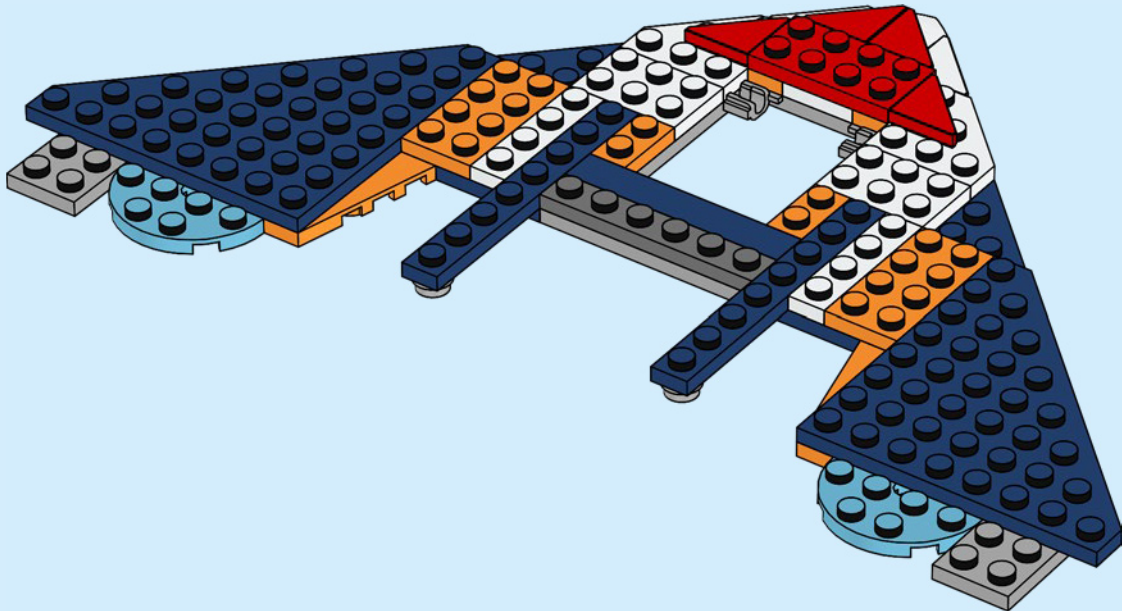

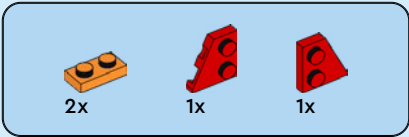

17

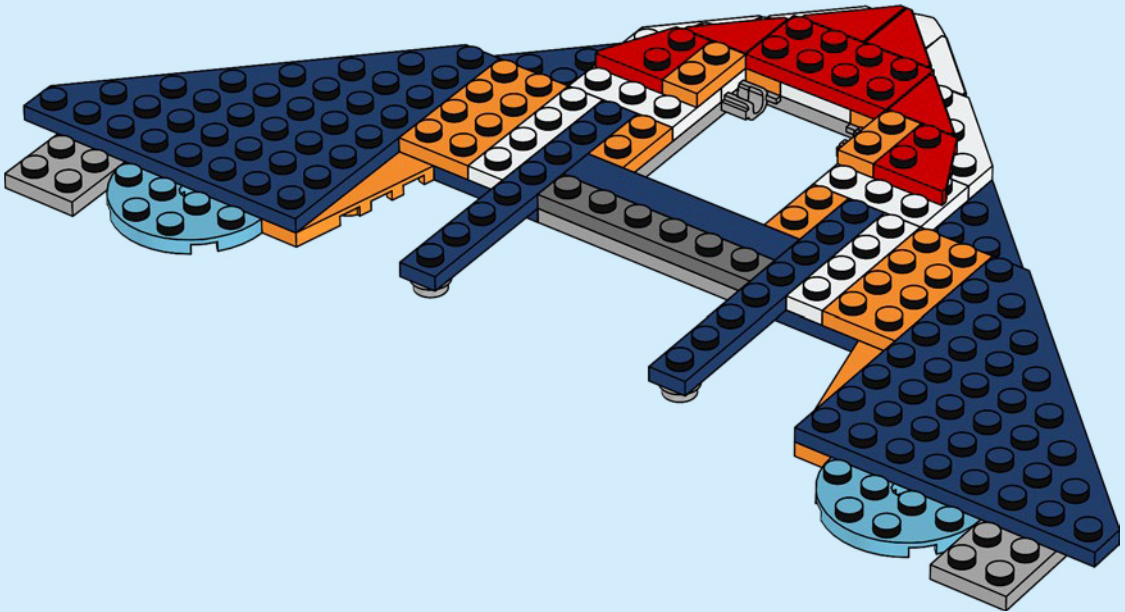

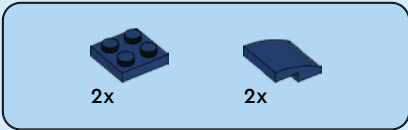

18

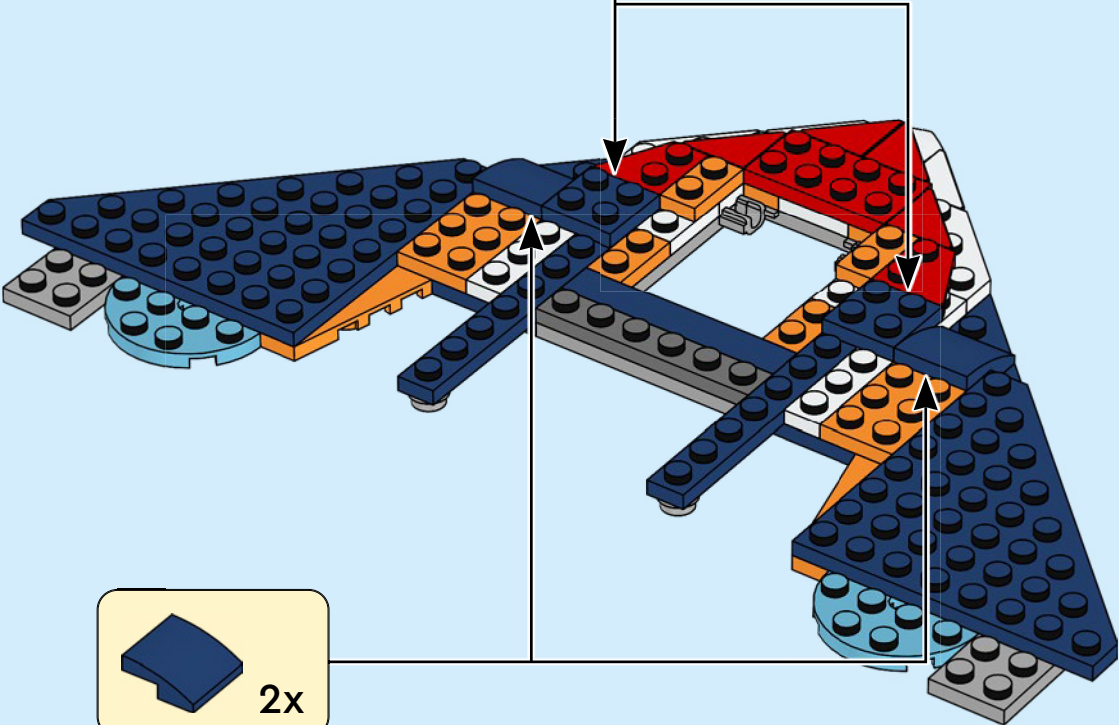
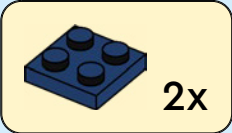



2x

19



2x

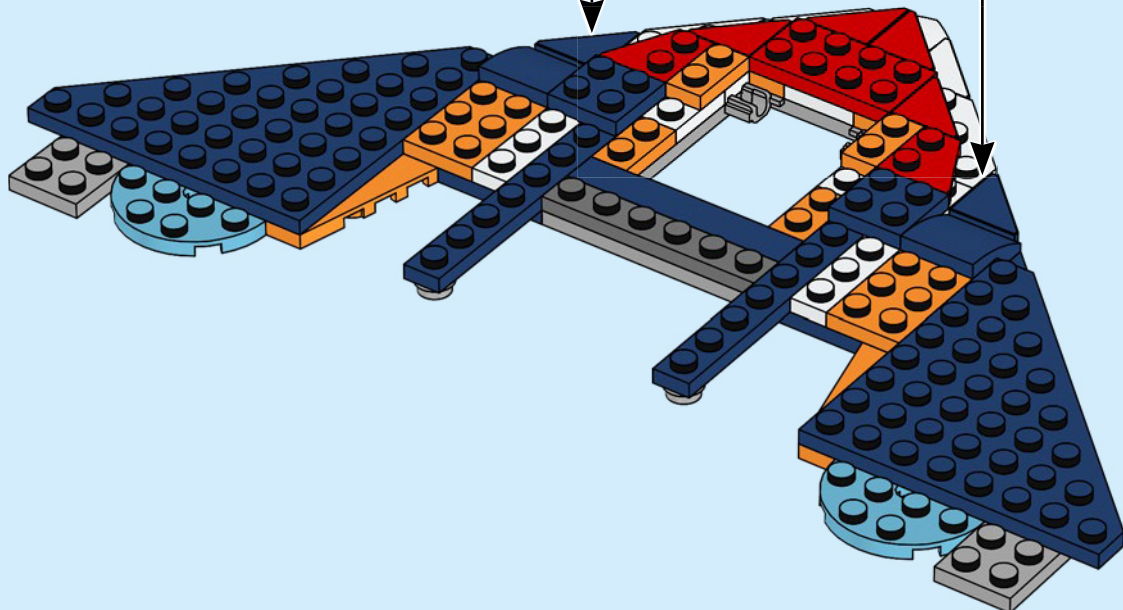

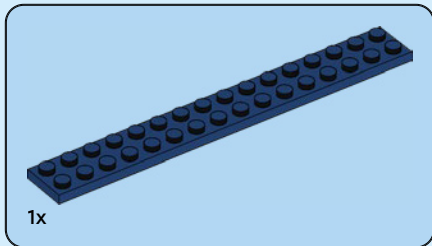

20

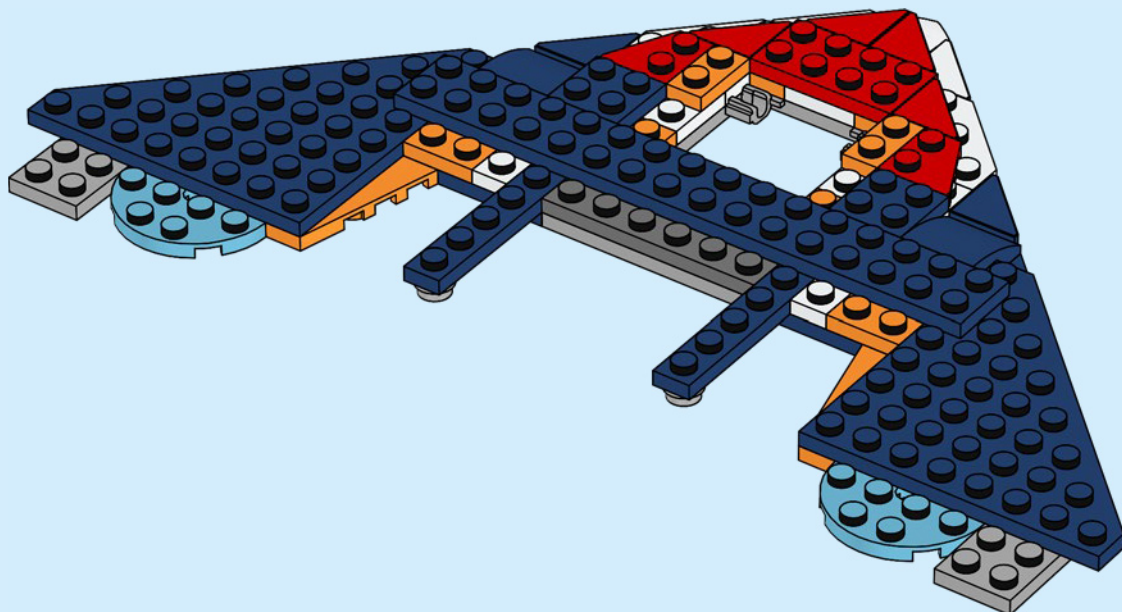



1x



1x

21

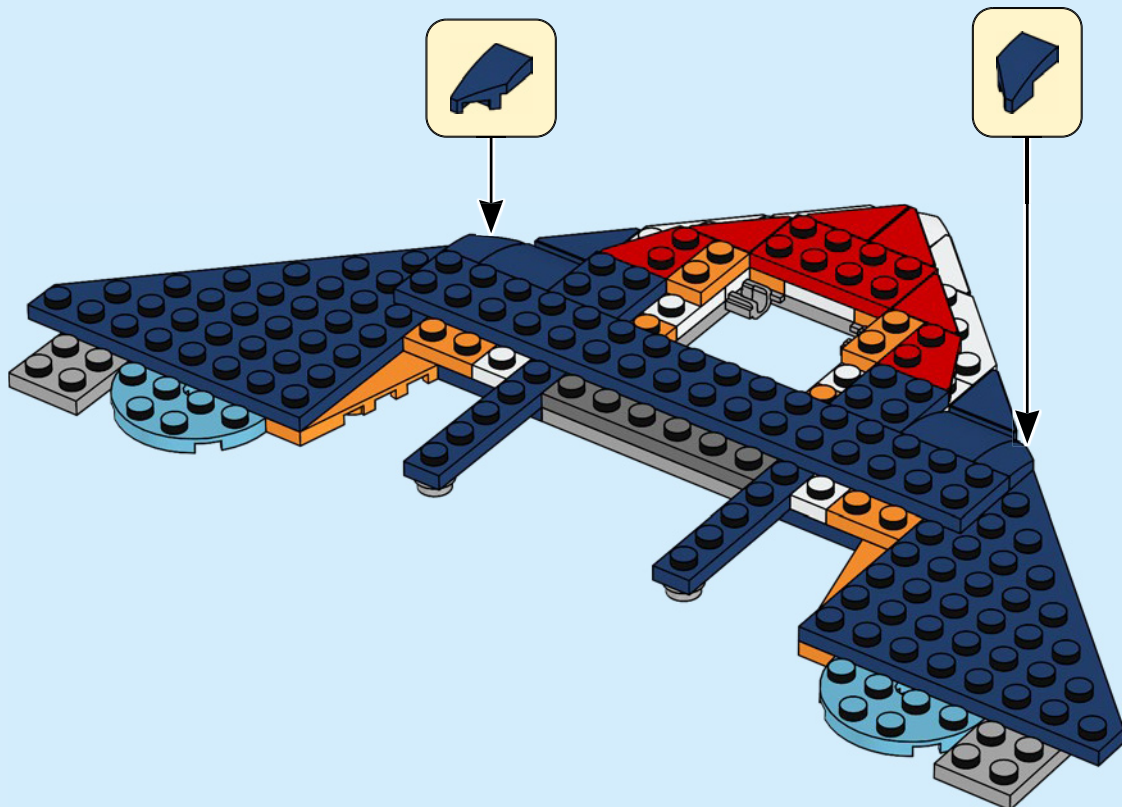

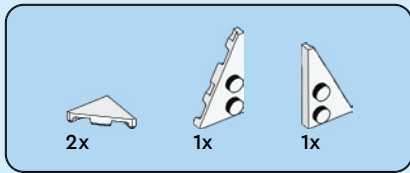

22

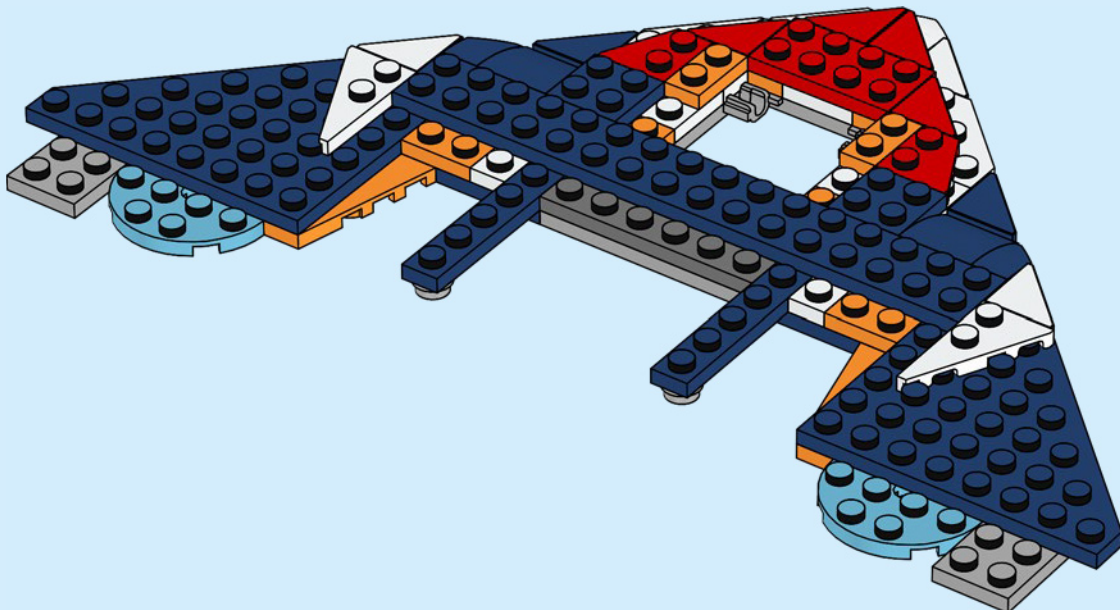

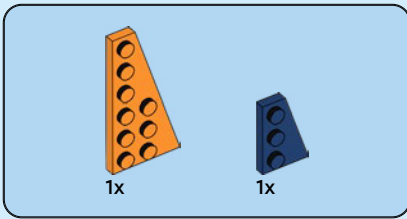

23

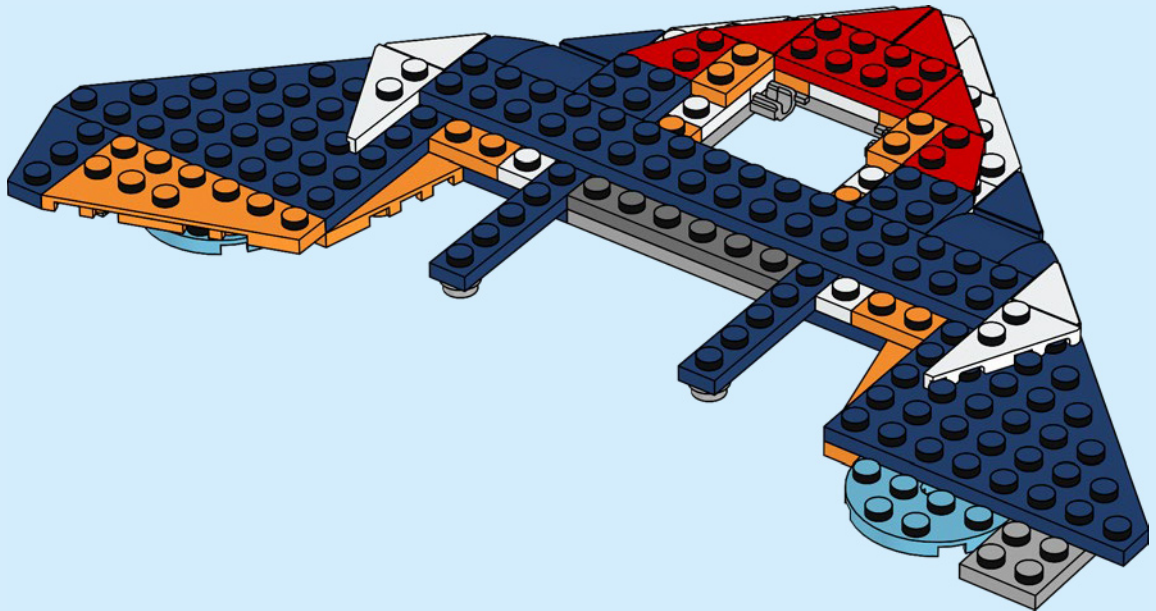

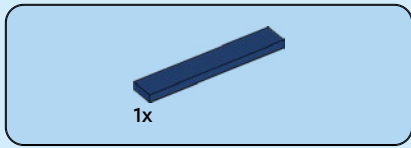

24

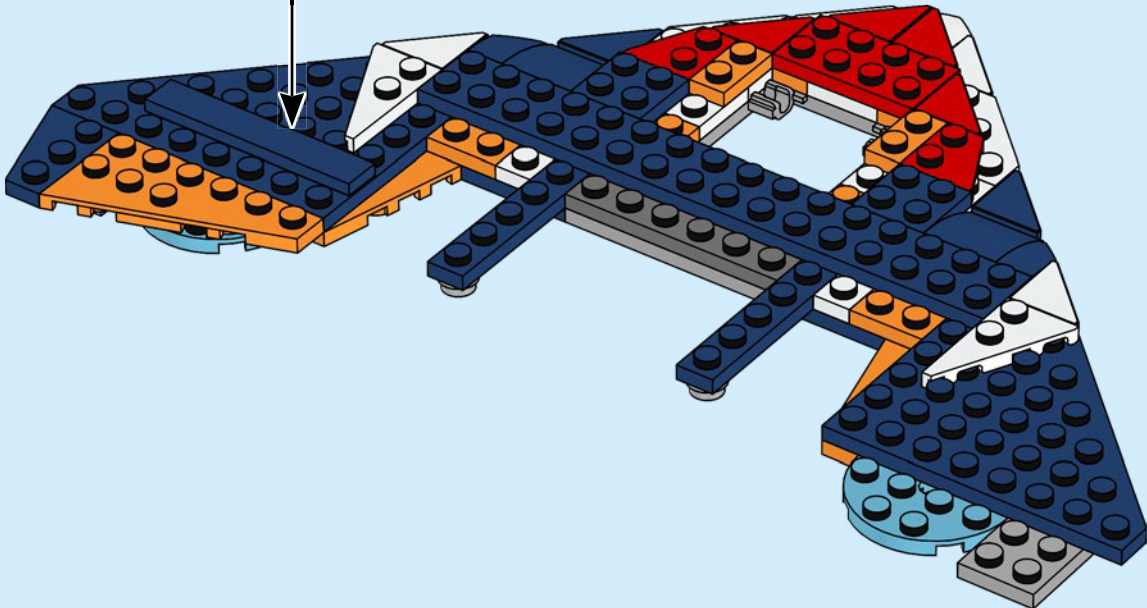
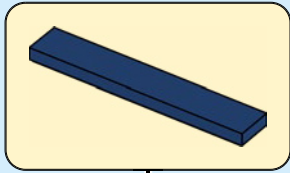

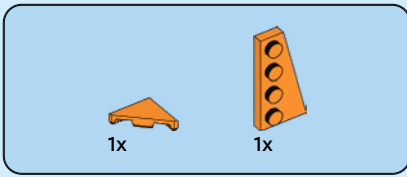

25

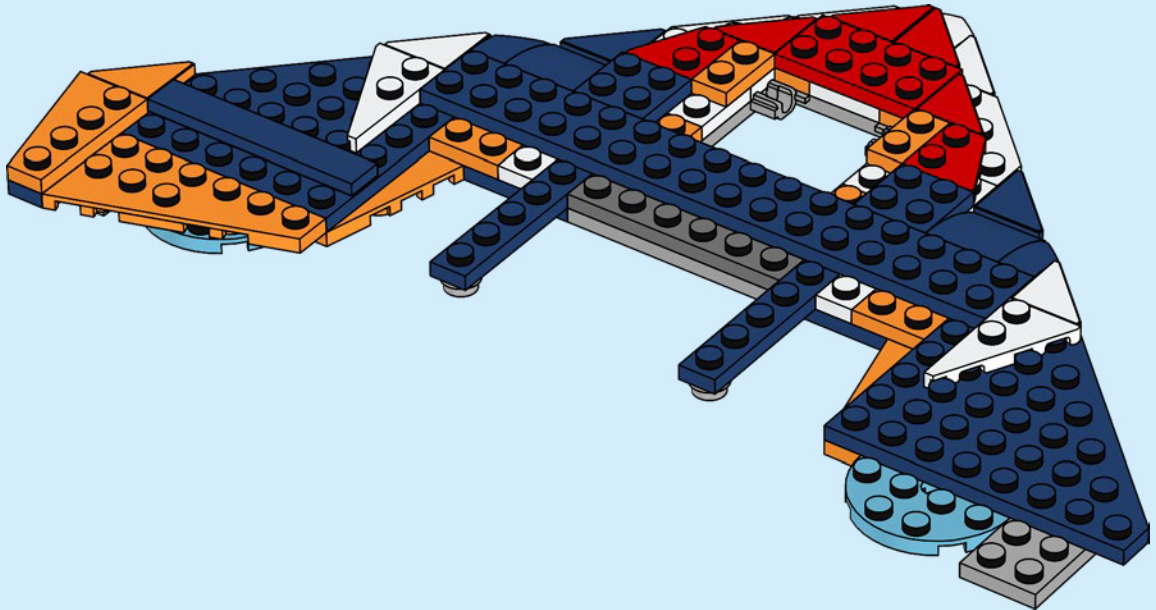

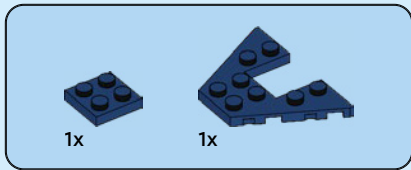

26

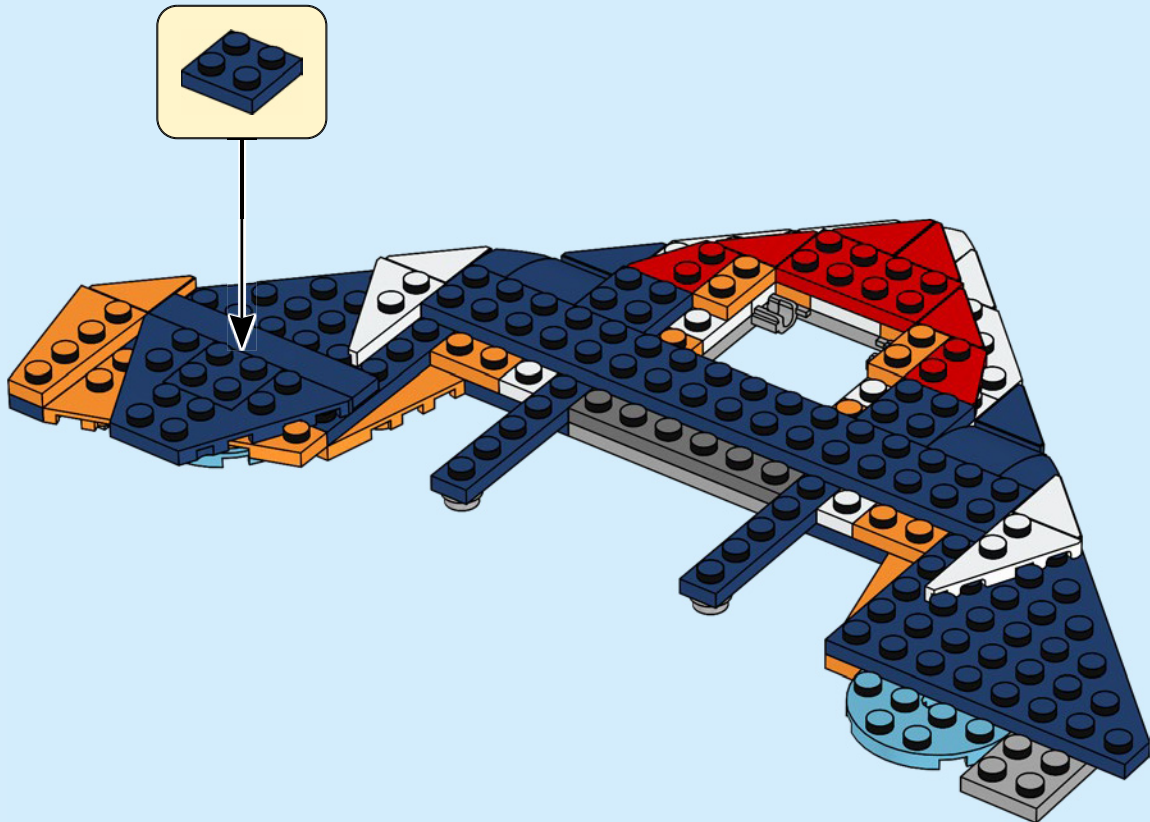



1x

27

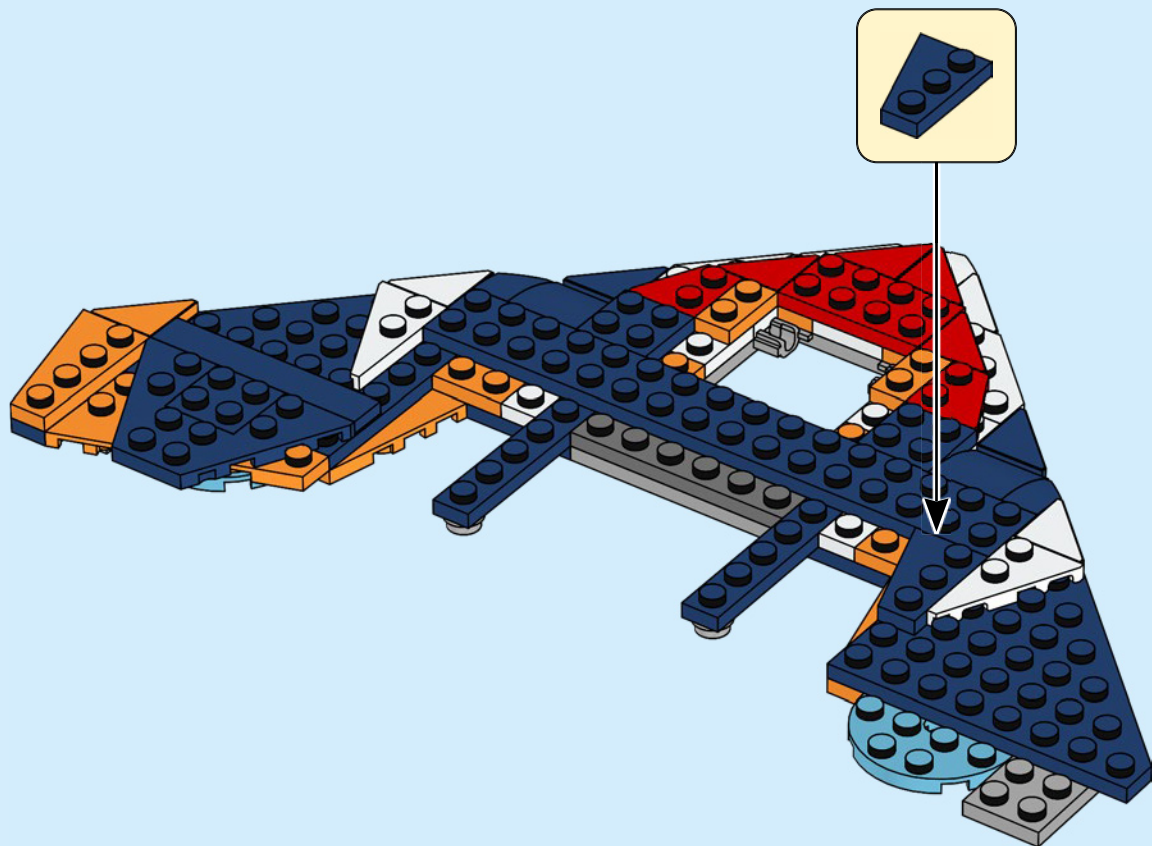

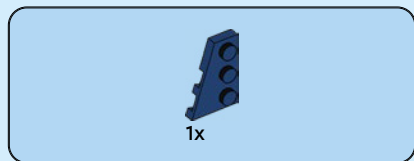

28

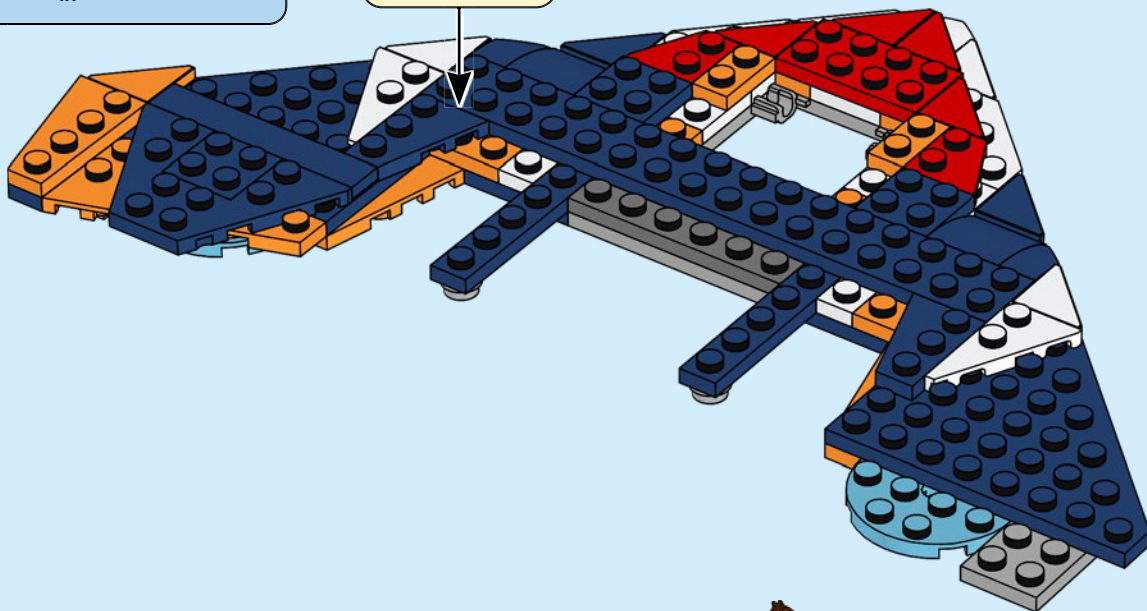
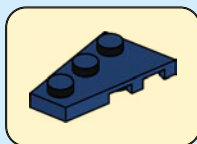

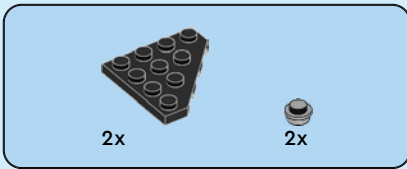

29

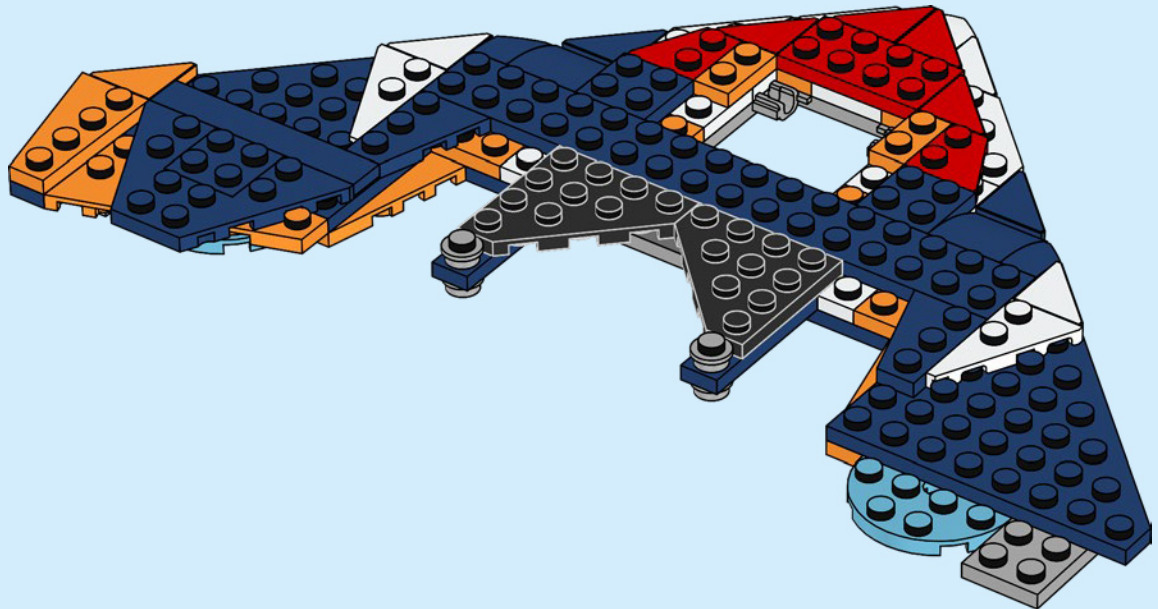

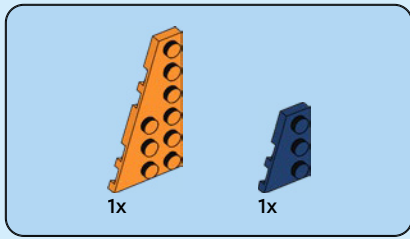

30

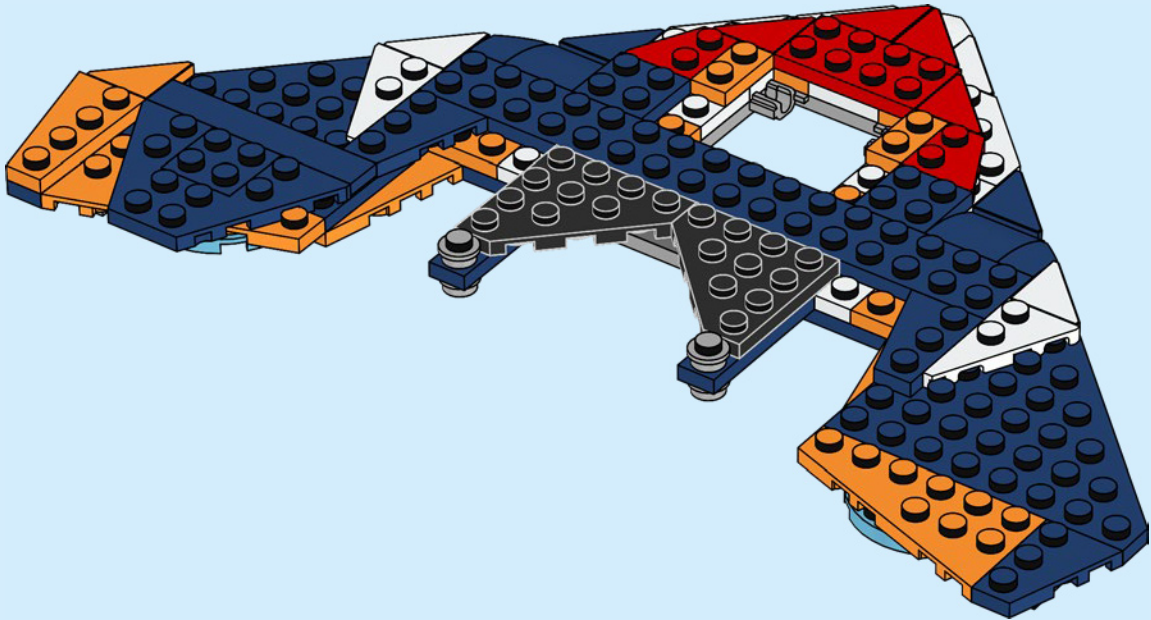

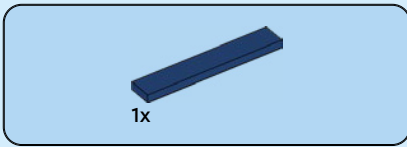

31

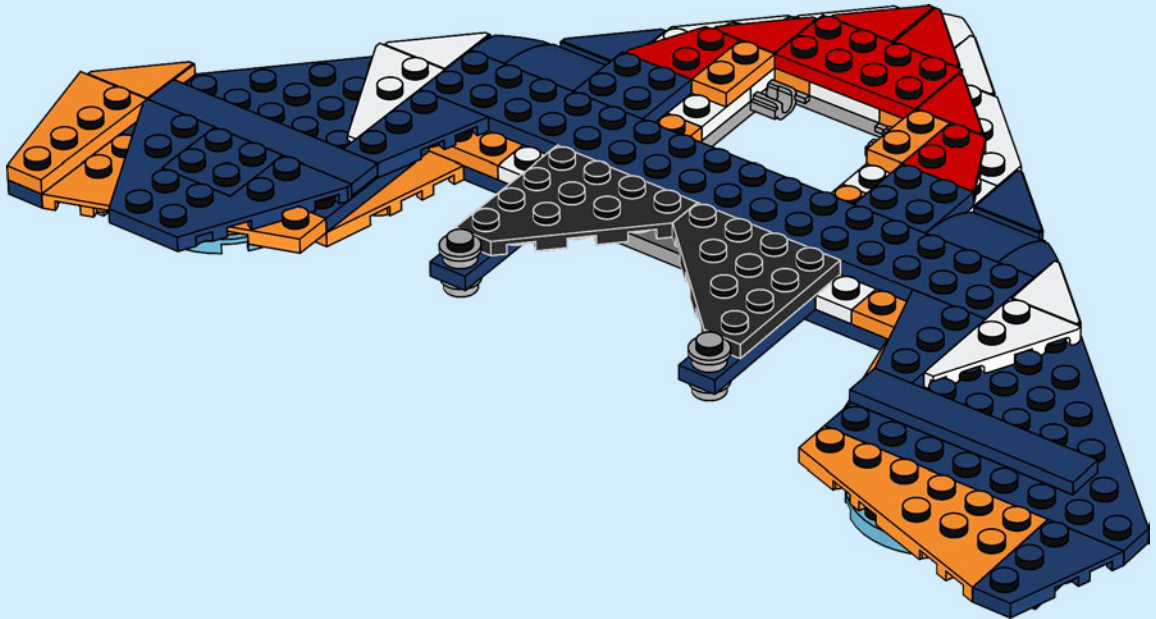

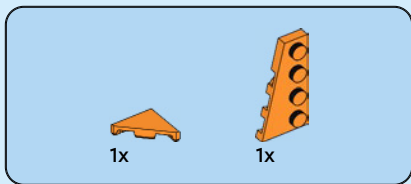

32

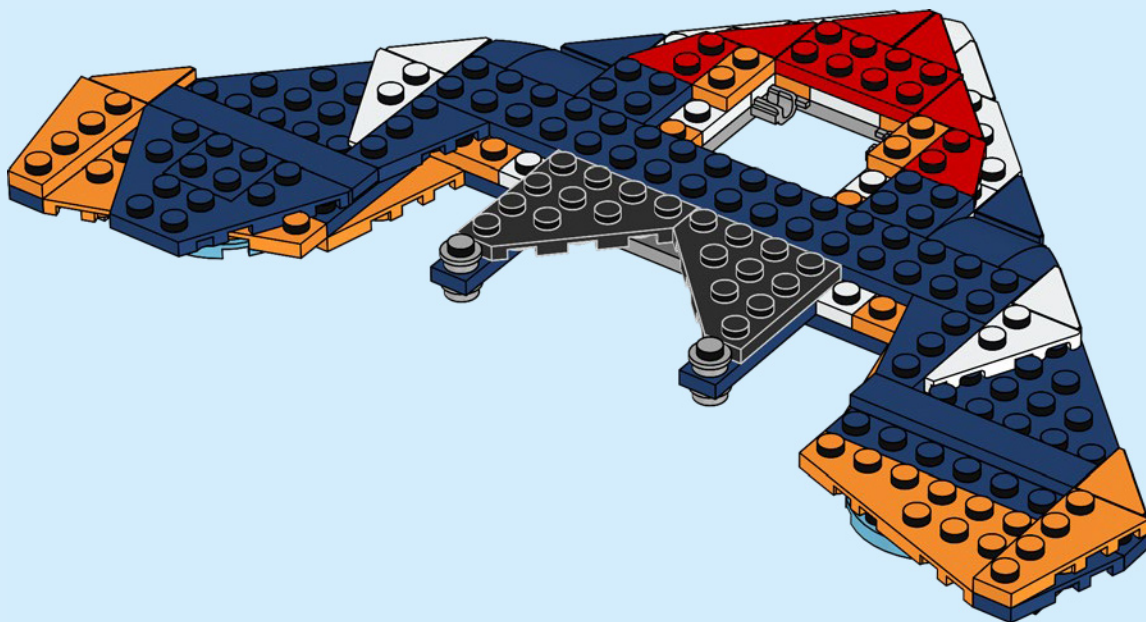

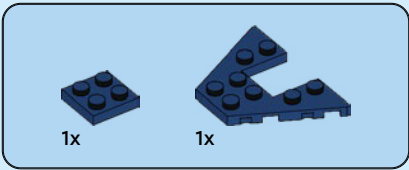

33

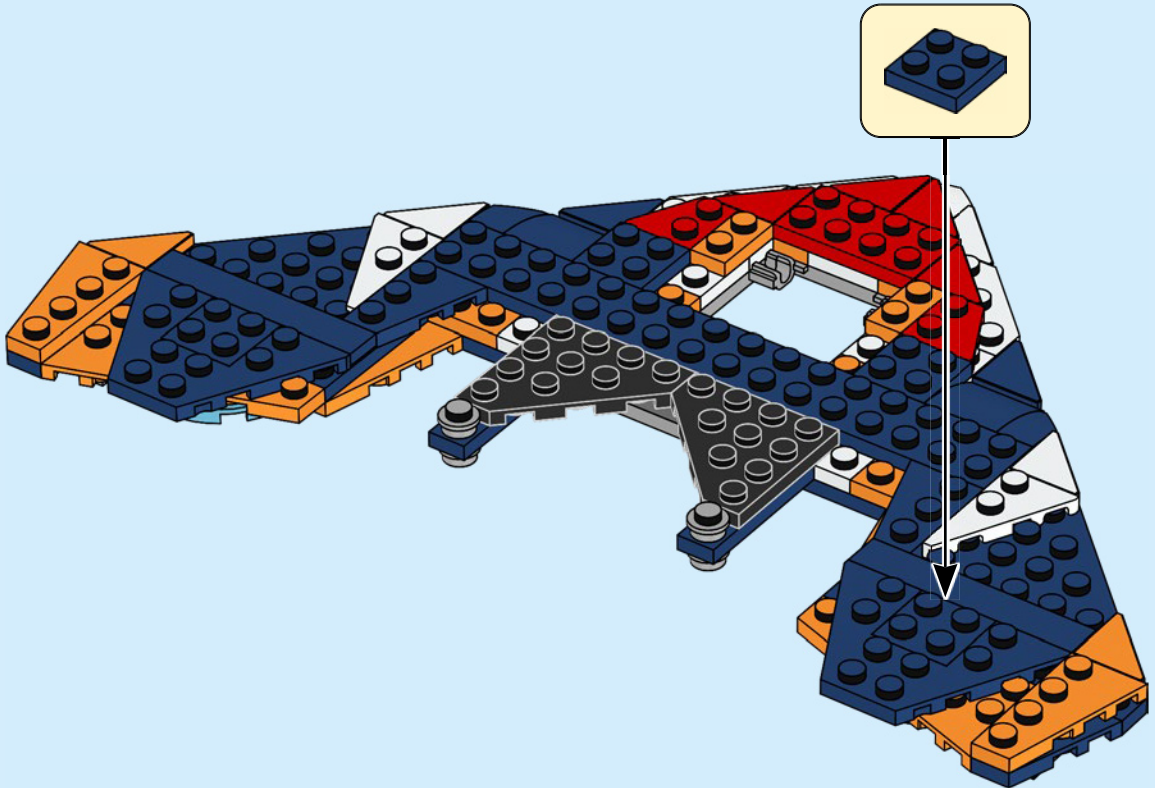



2x

34

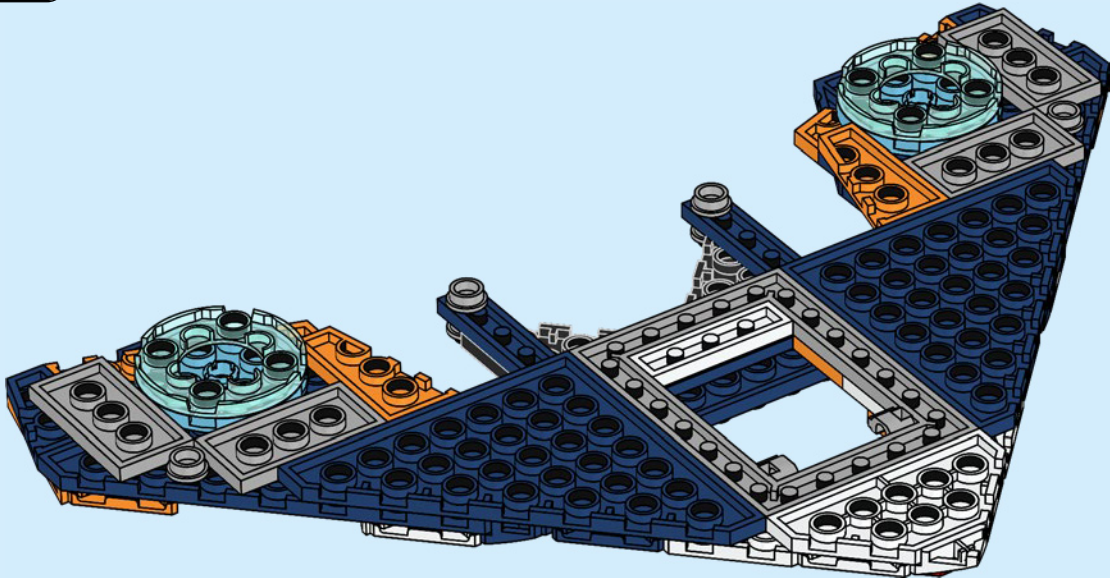



2x

35

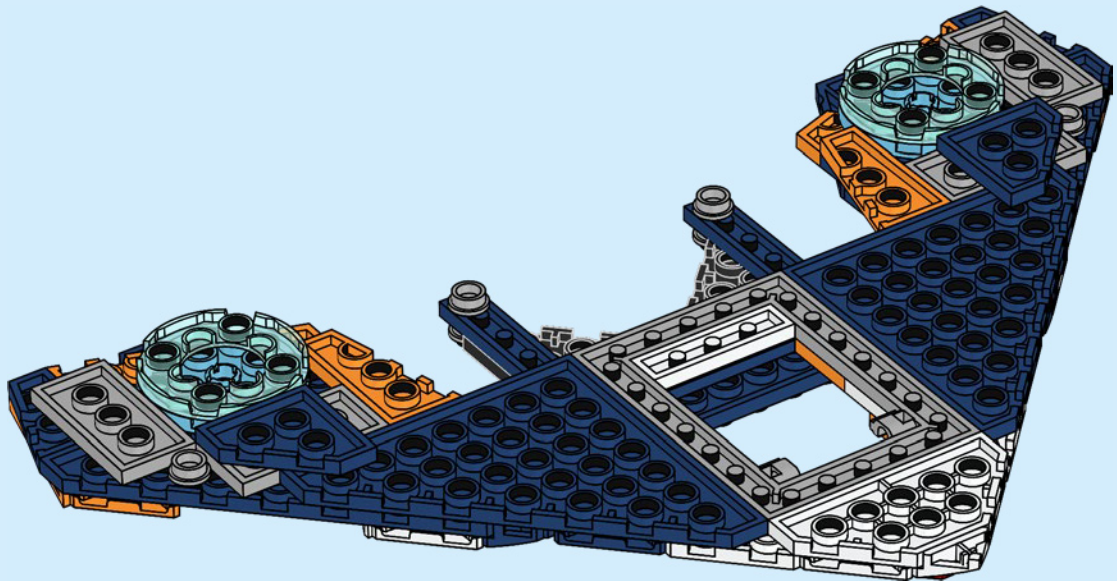

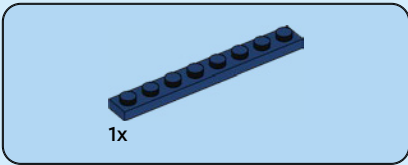

36

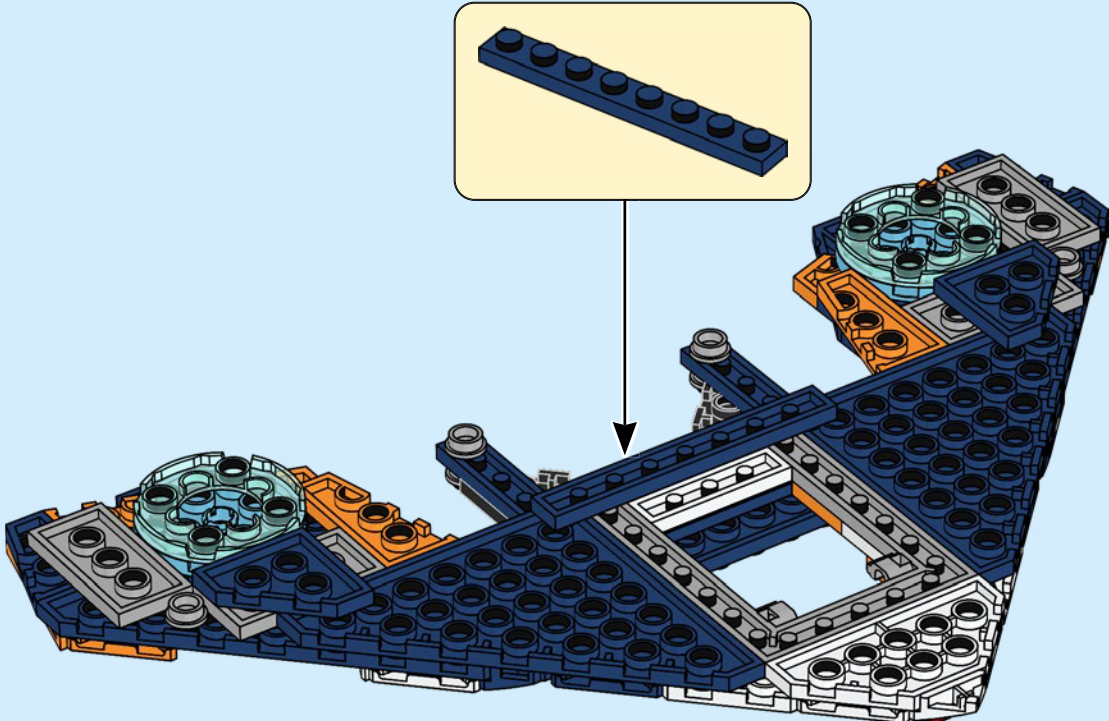

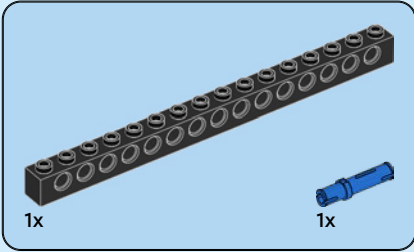
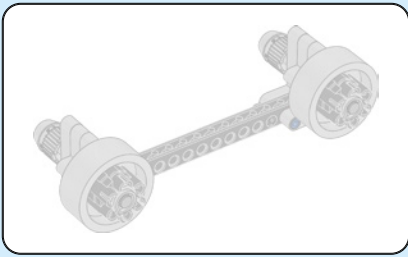

37

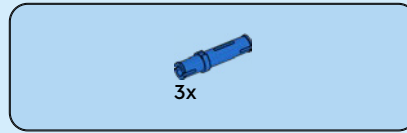
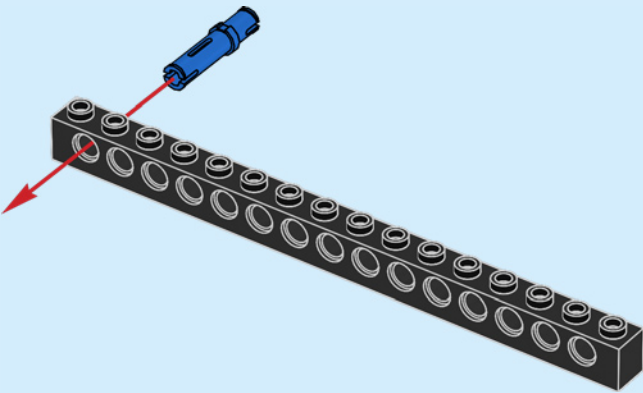

38

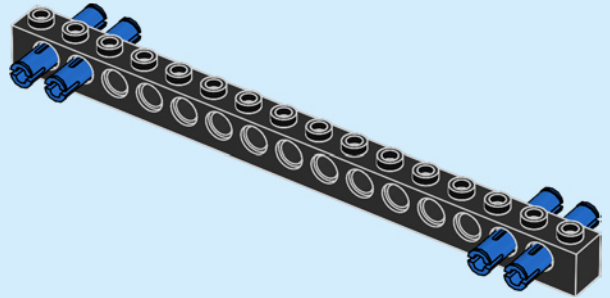

2x

2x

39

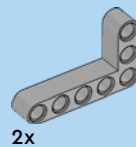
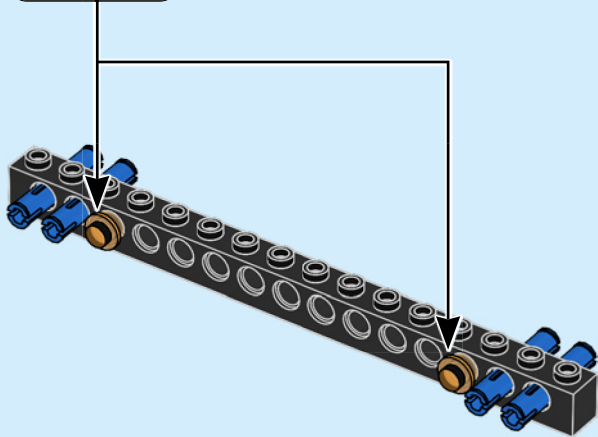
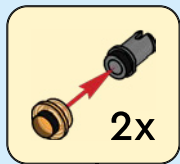

40

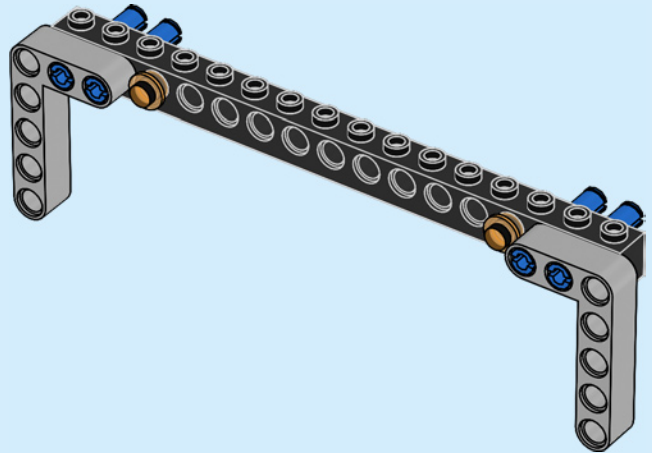

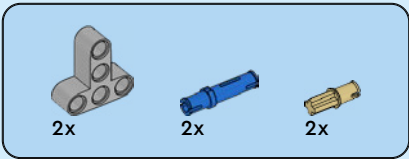

41

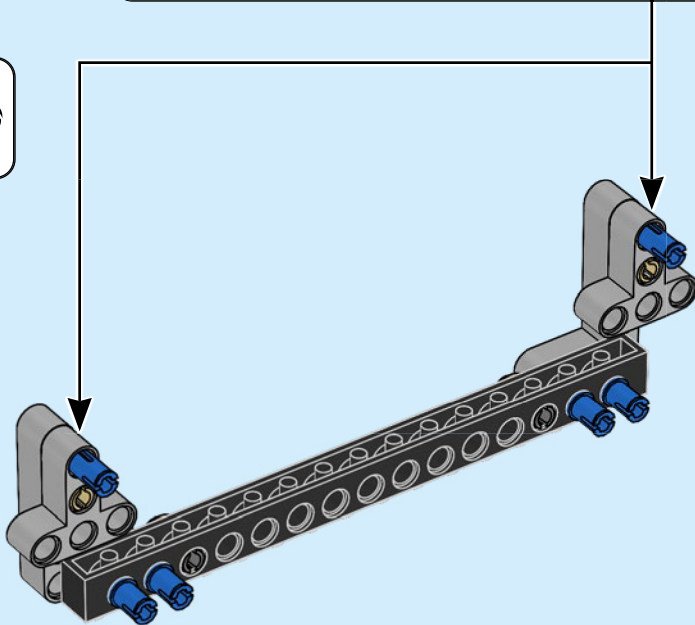
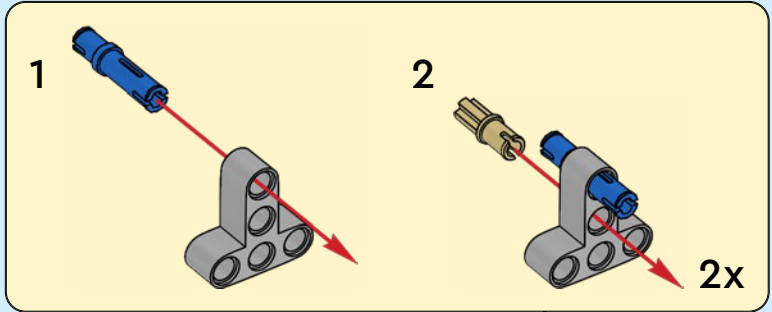

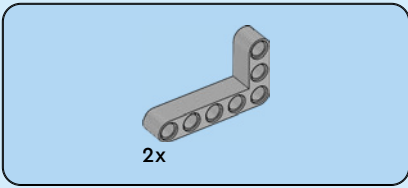

42

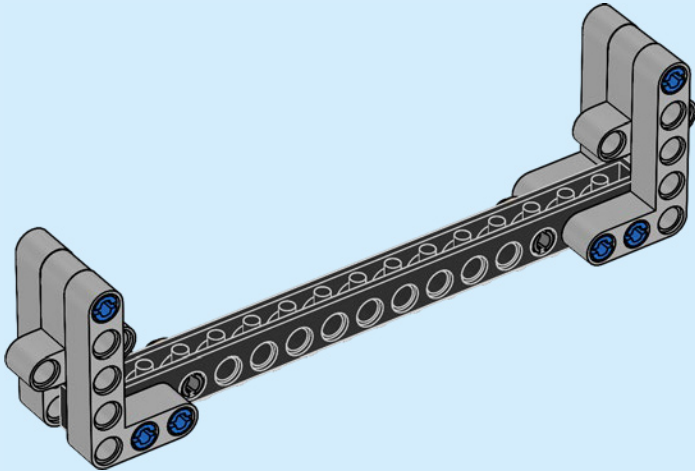

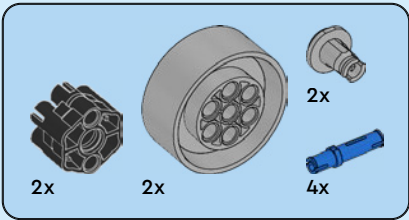

43

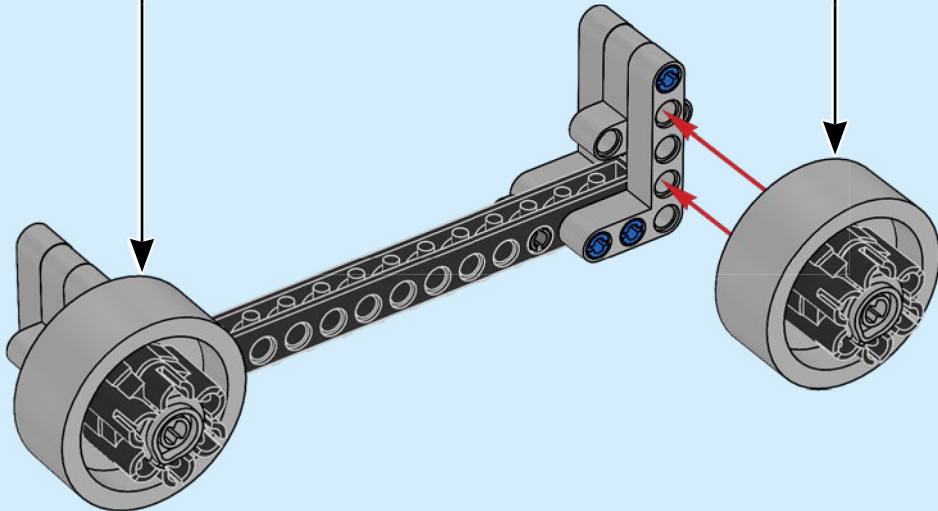
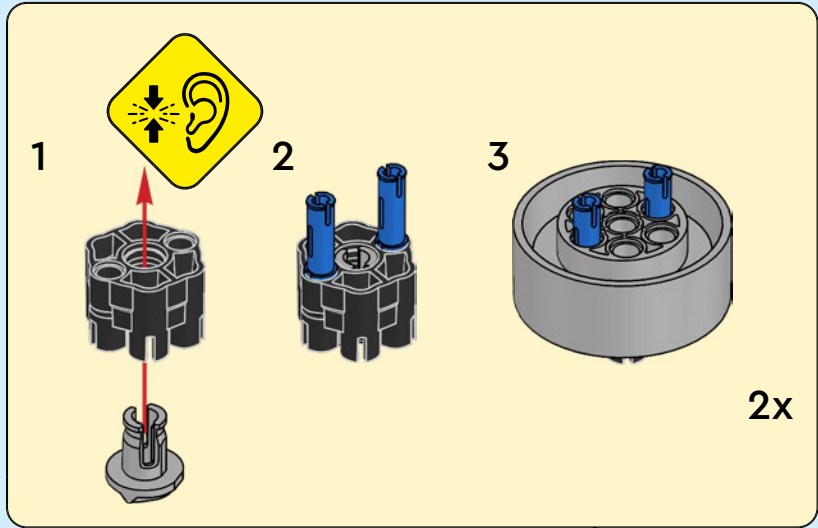

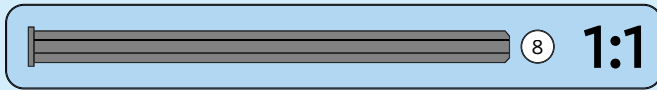
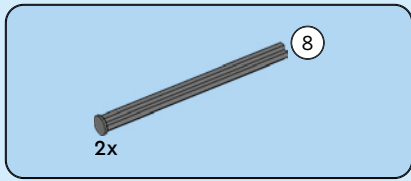

44

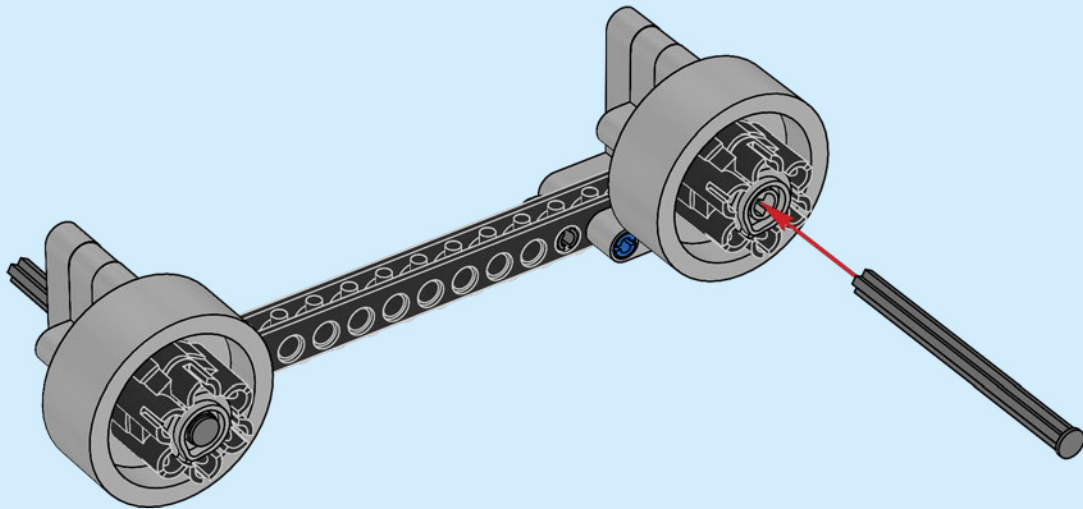

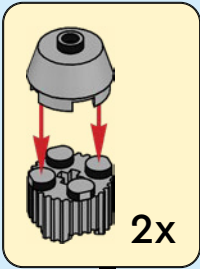
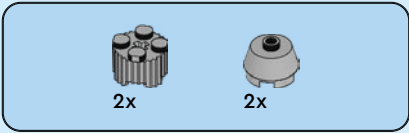

45

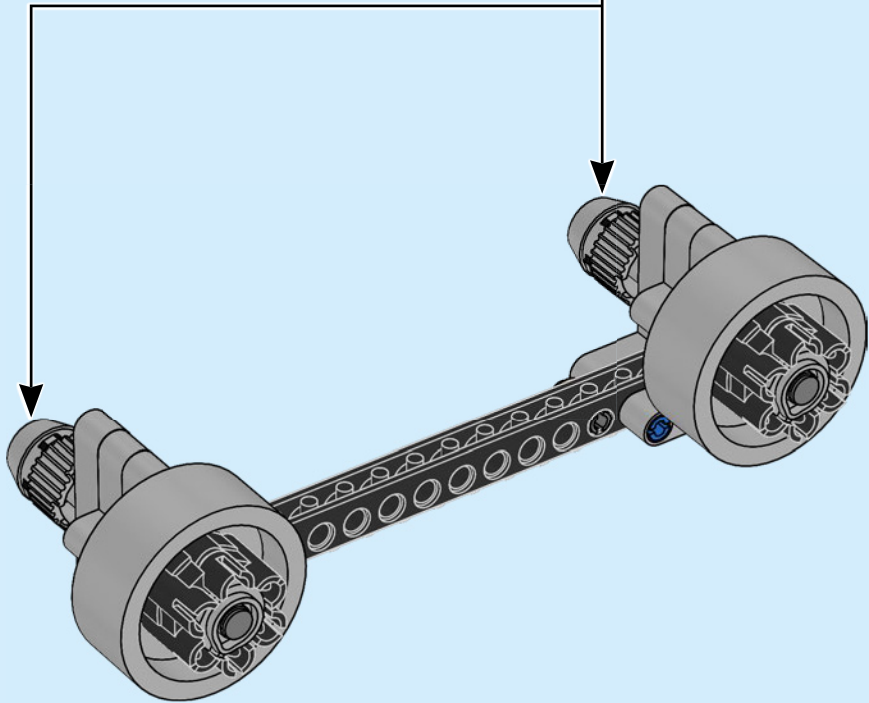

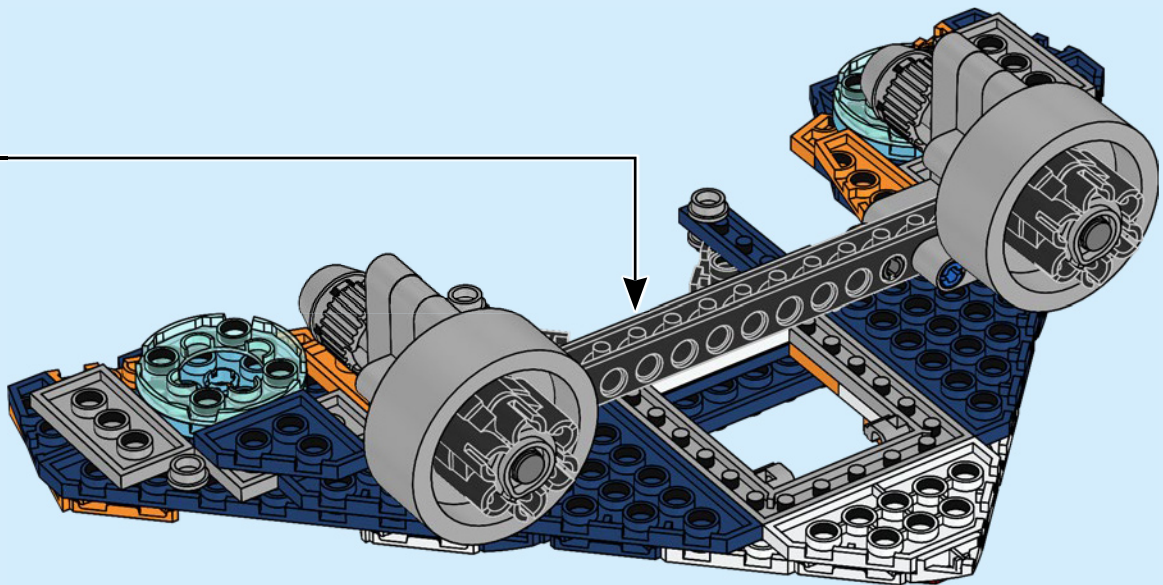



2x

47

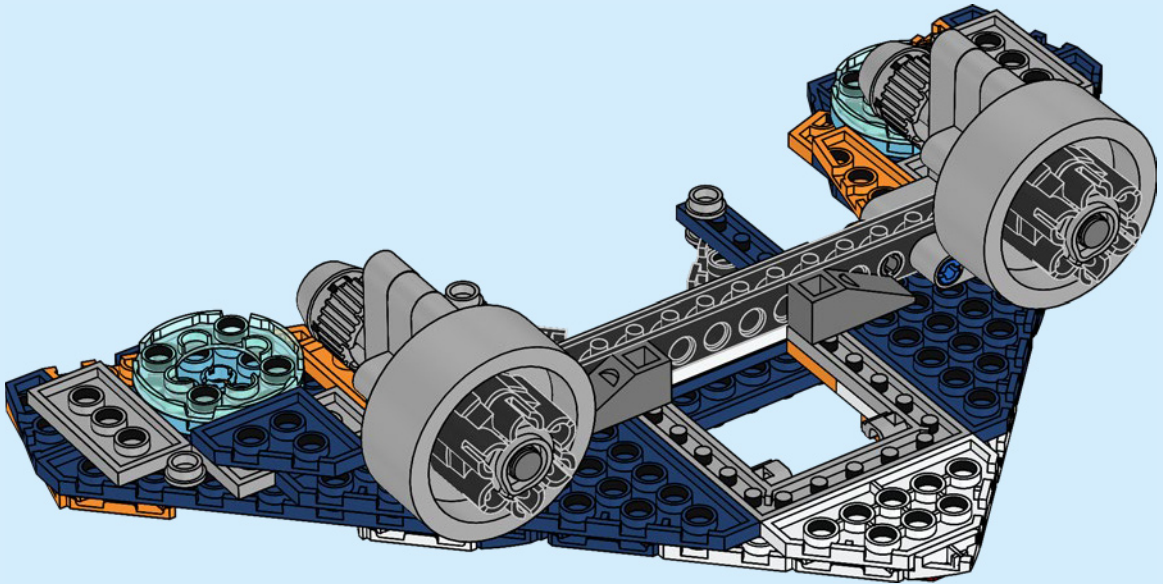

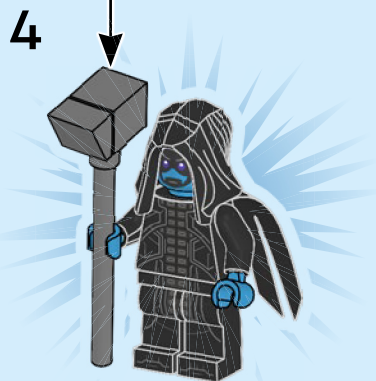
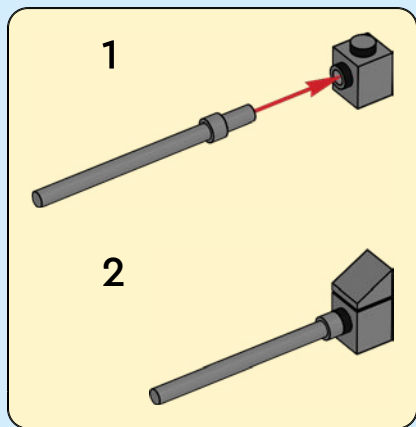
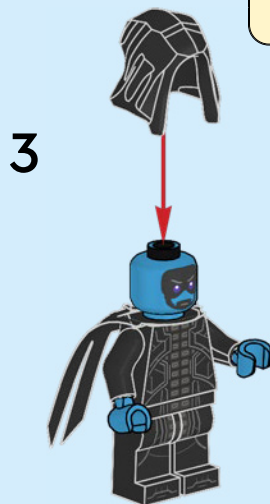
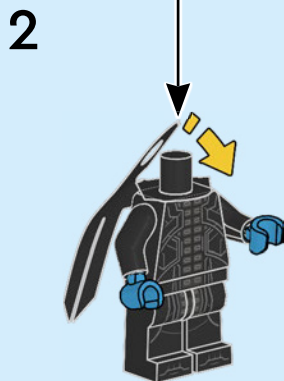
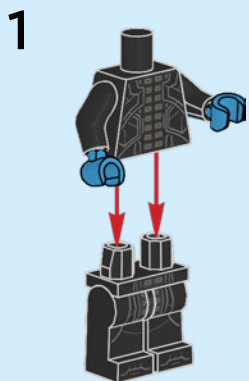
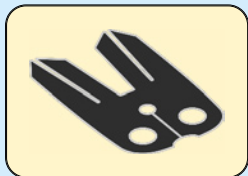

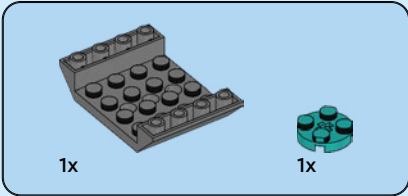
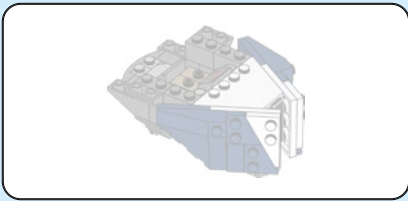

48

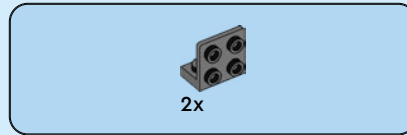
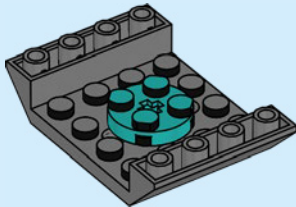

49

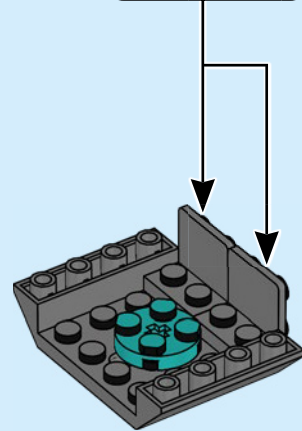
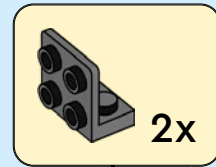

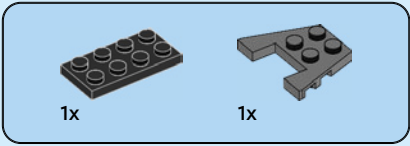

50

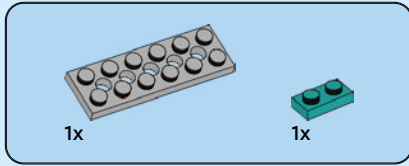
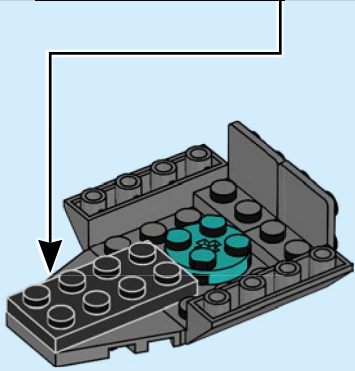
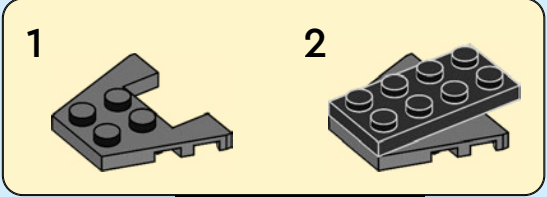

51

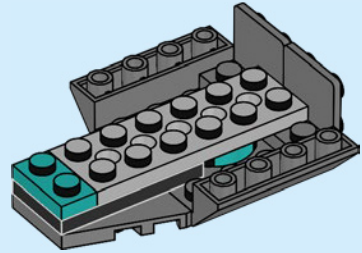



1x

52

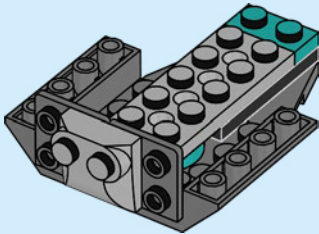

2x

53



2x

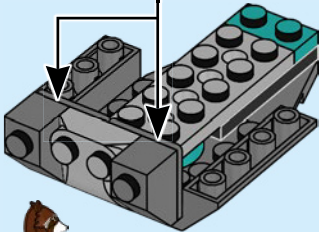

2x

54

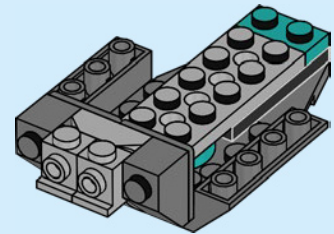

1x

55

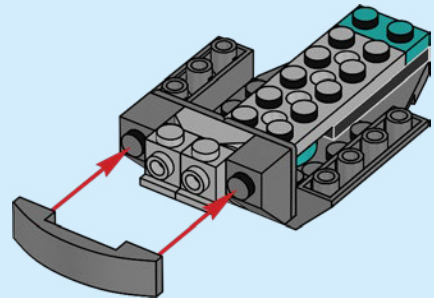

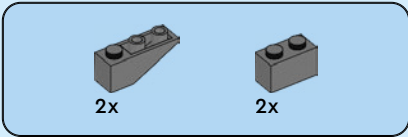

56

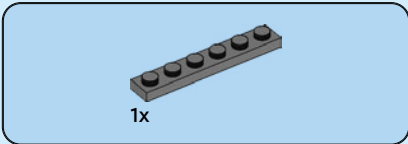
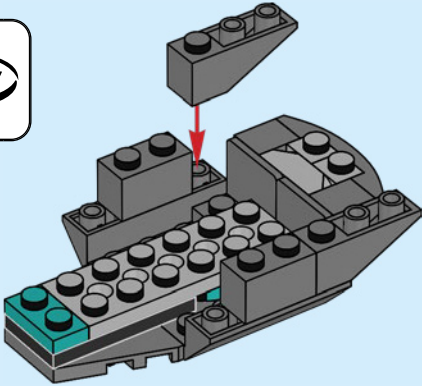

57

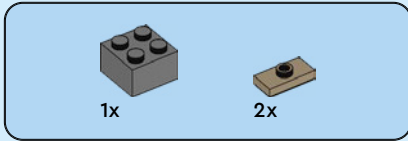
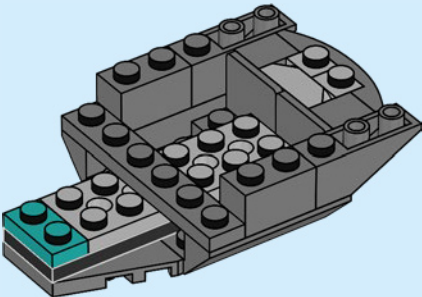

58

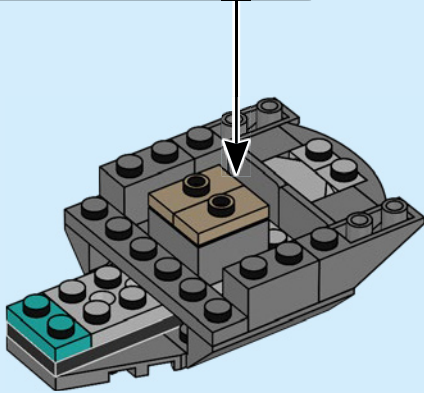
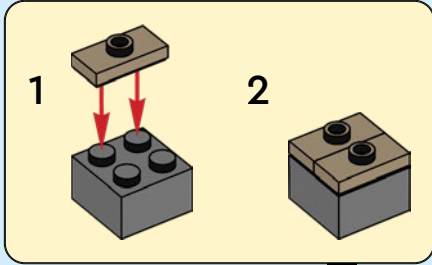

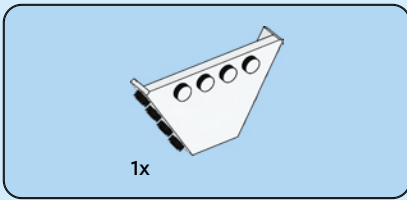

59

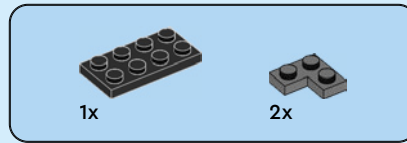
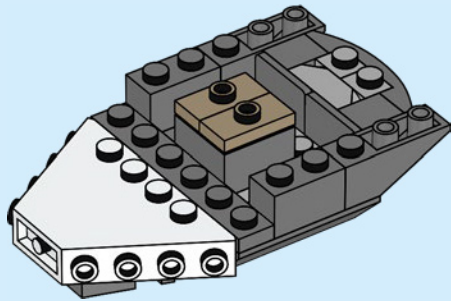

60

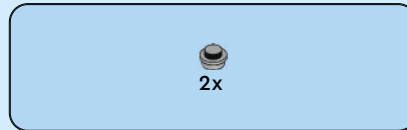
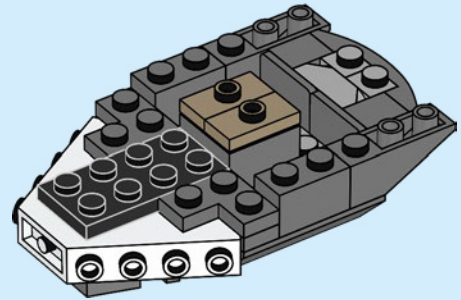

61

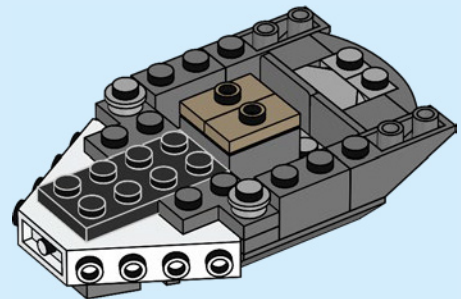

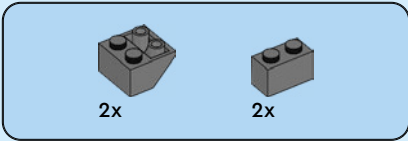

62

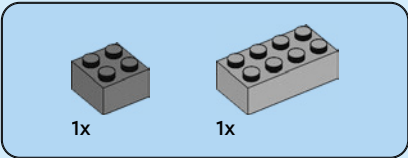
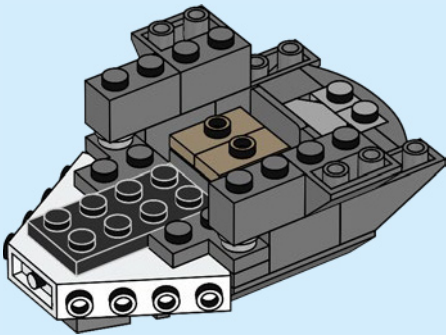

63

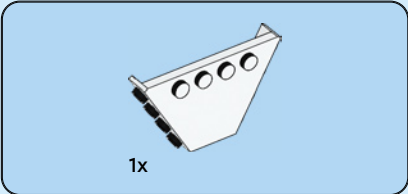
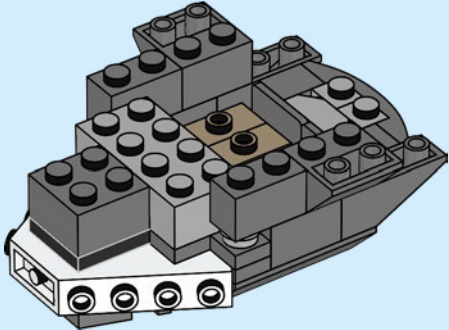

64

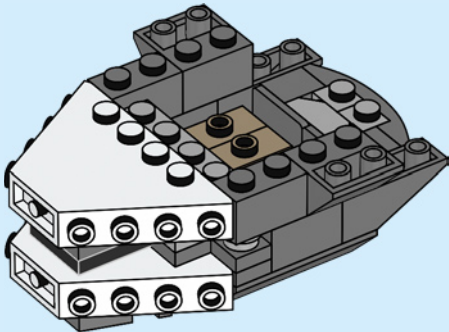



1x

65

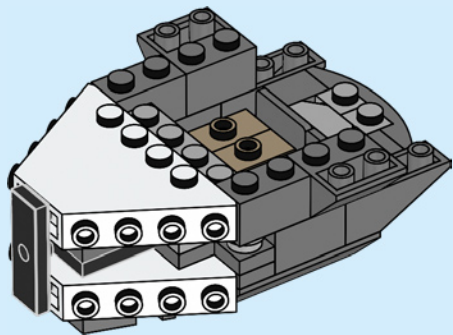

1x

66

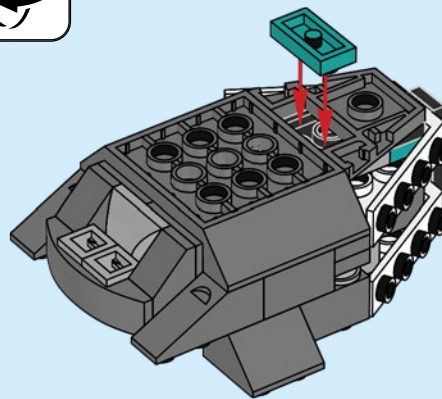
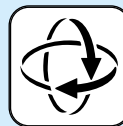

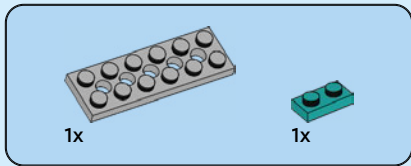

67

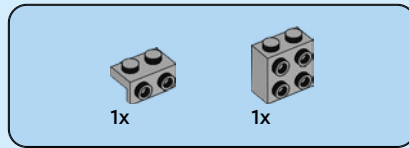
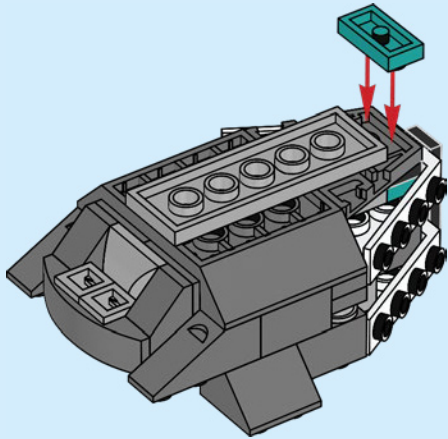

68

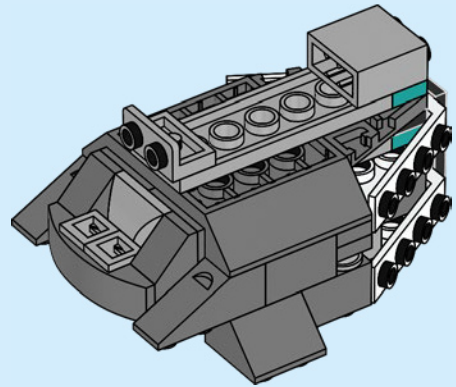

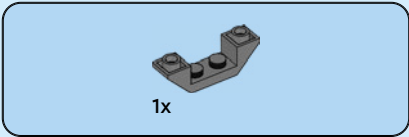

69

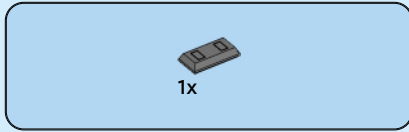
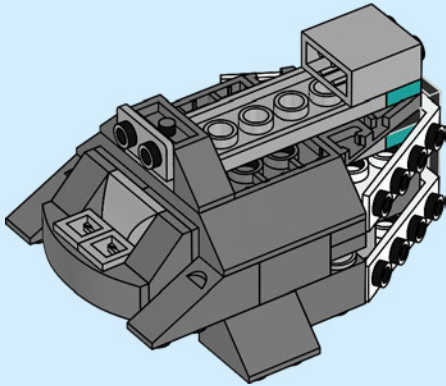

70

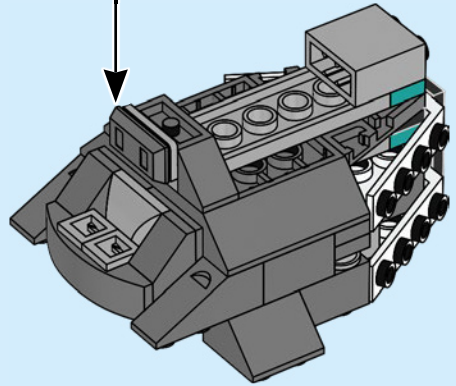
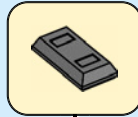



1x

71

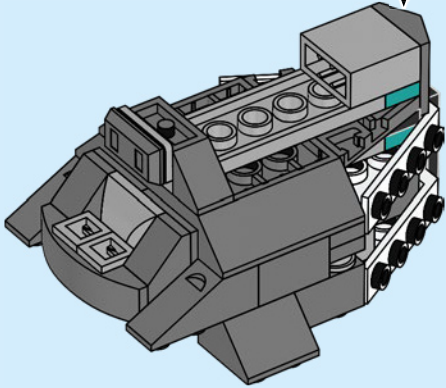

1x

72

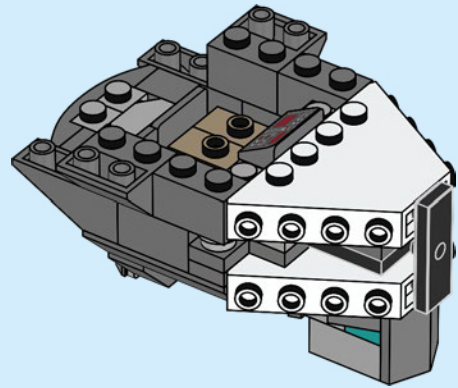
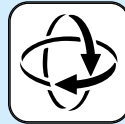

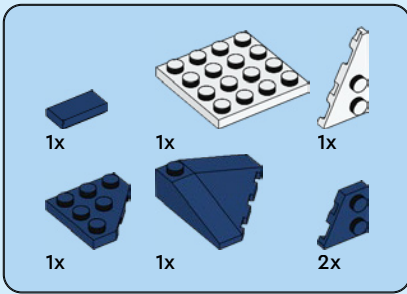

73

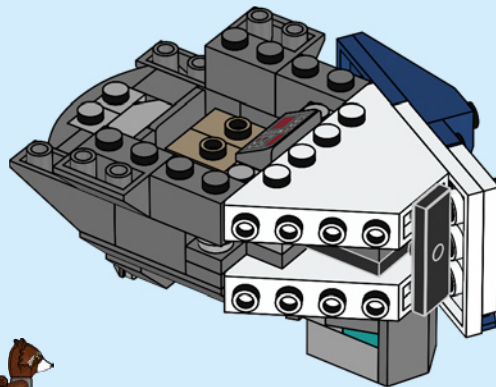
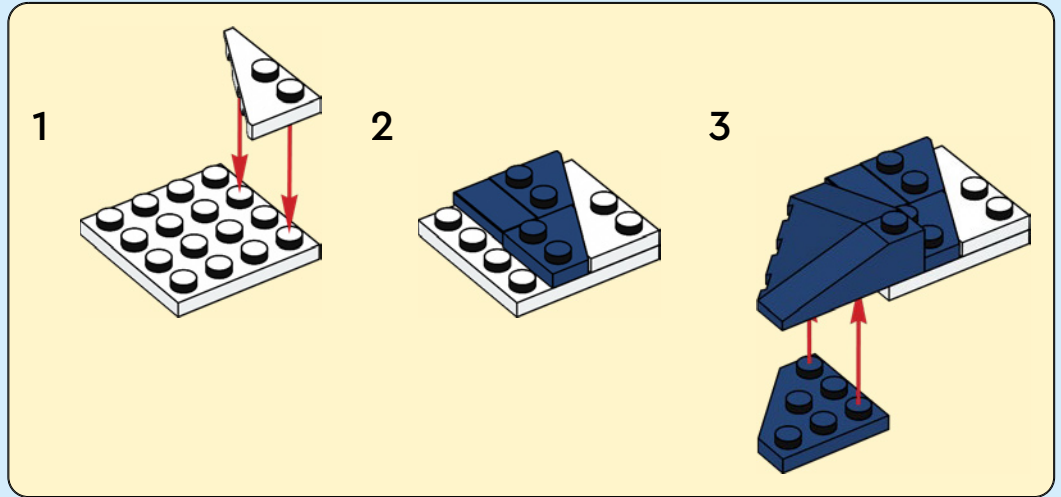

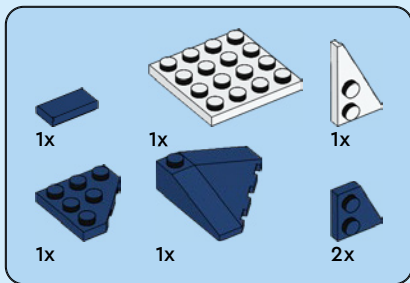

74

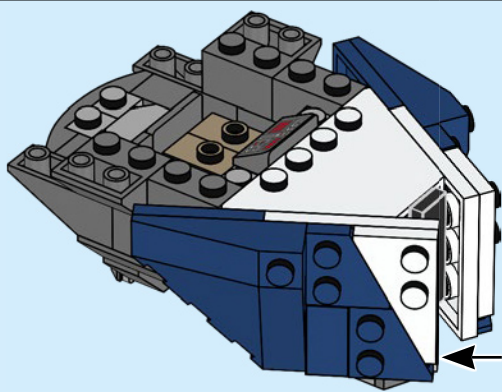
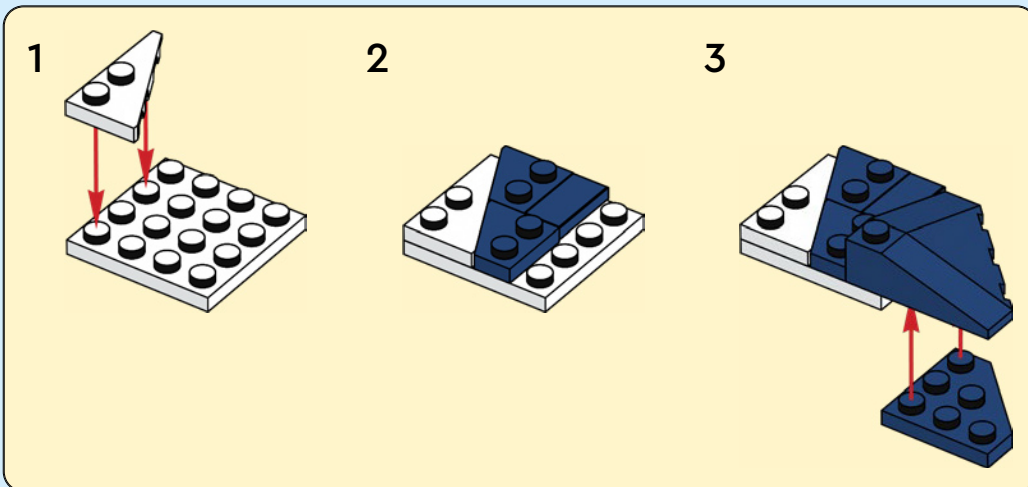

75

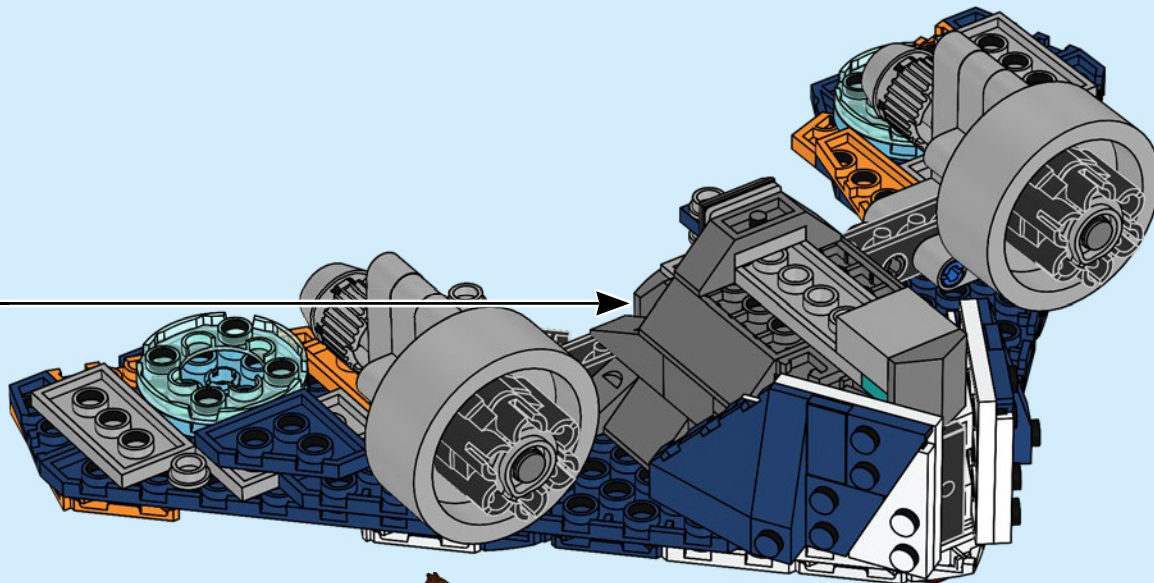
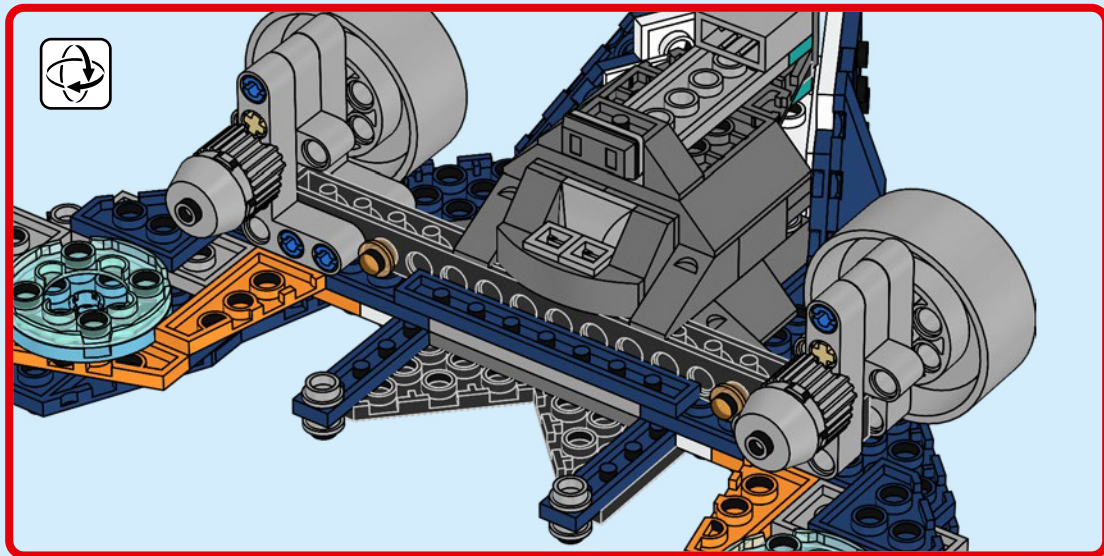

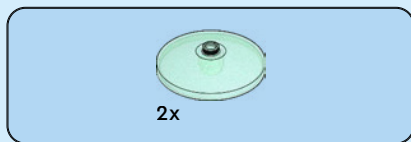

76

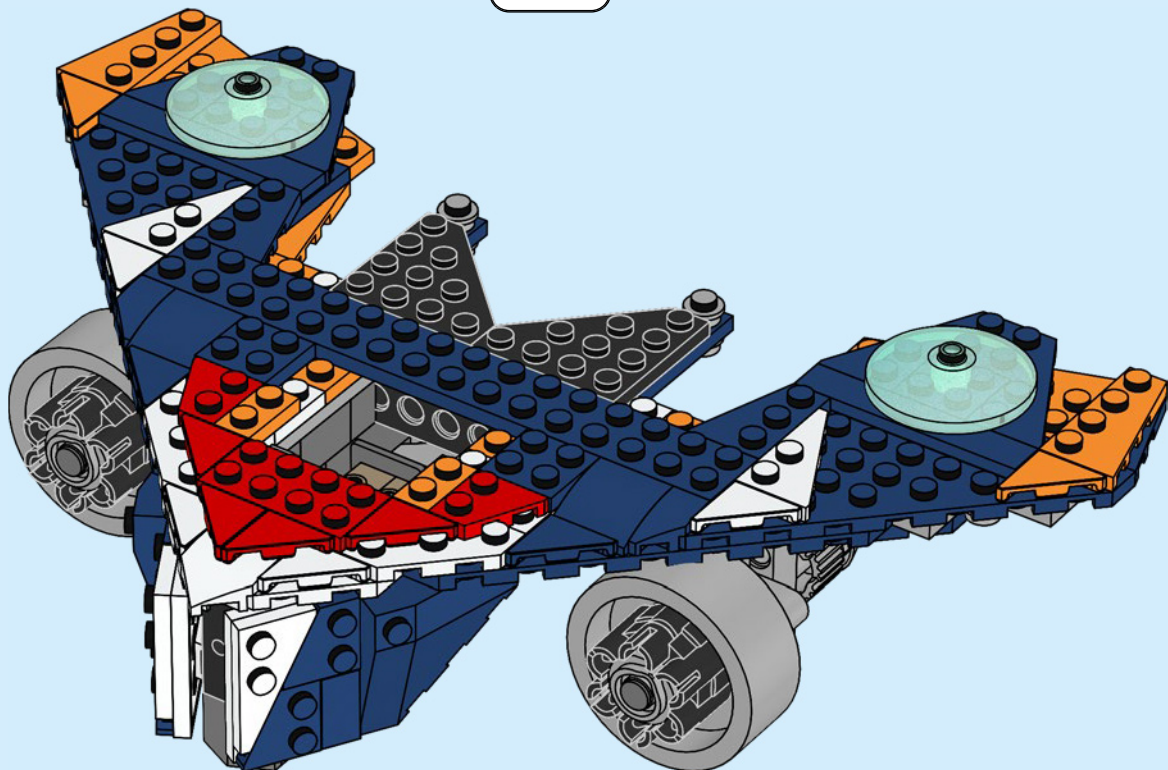

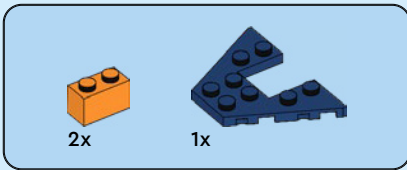

77

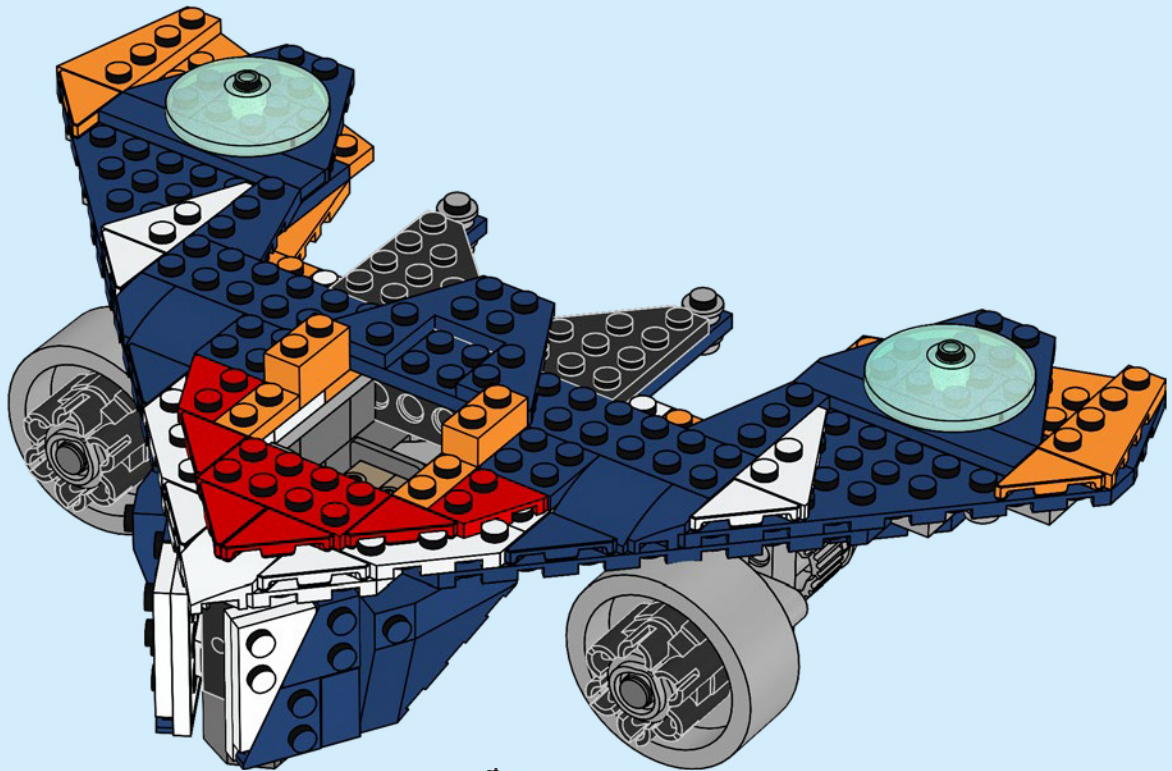



4x

78

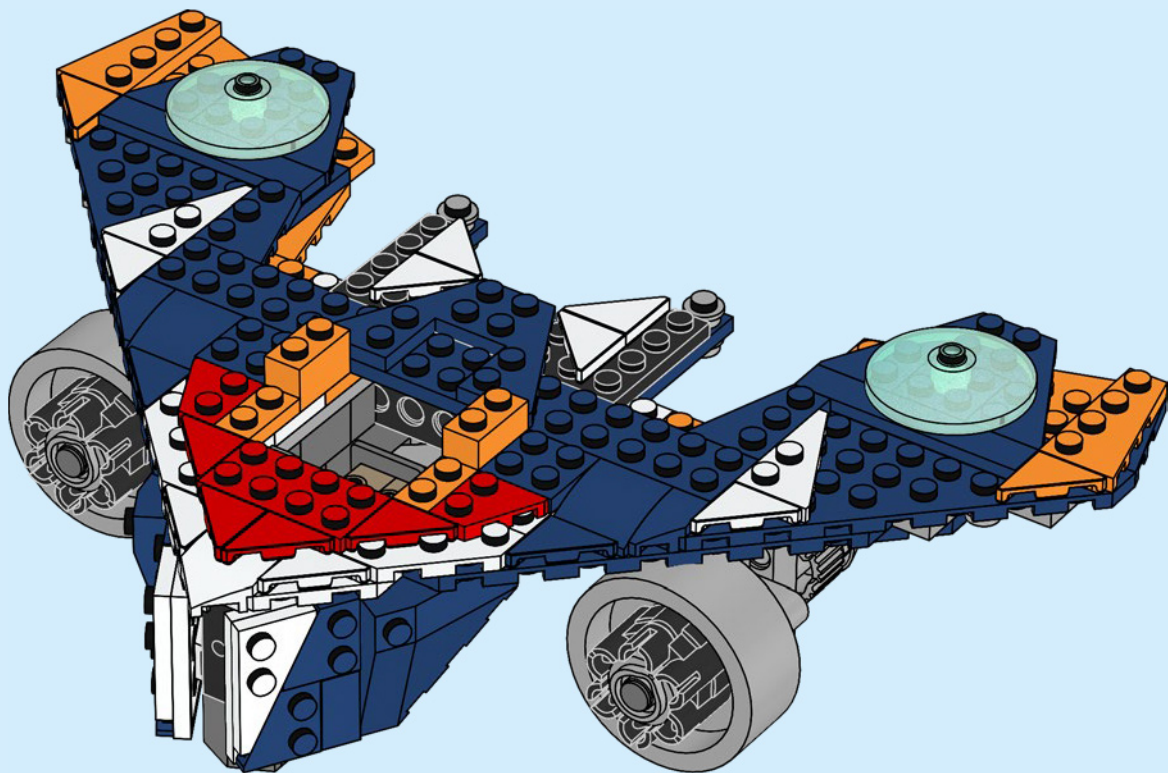



2x



2x

79

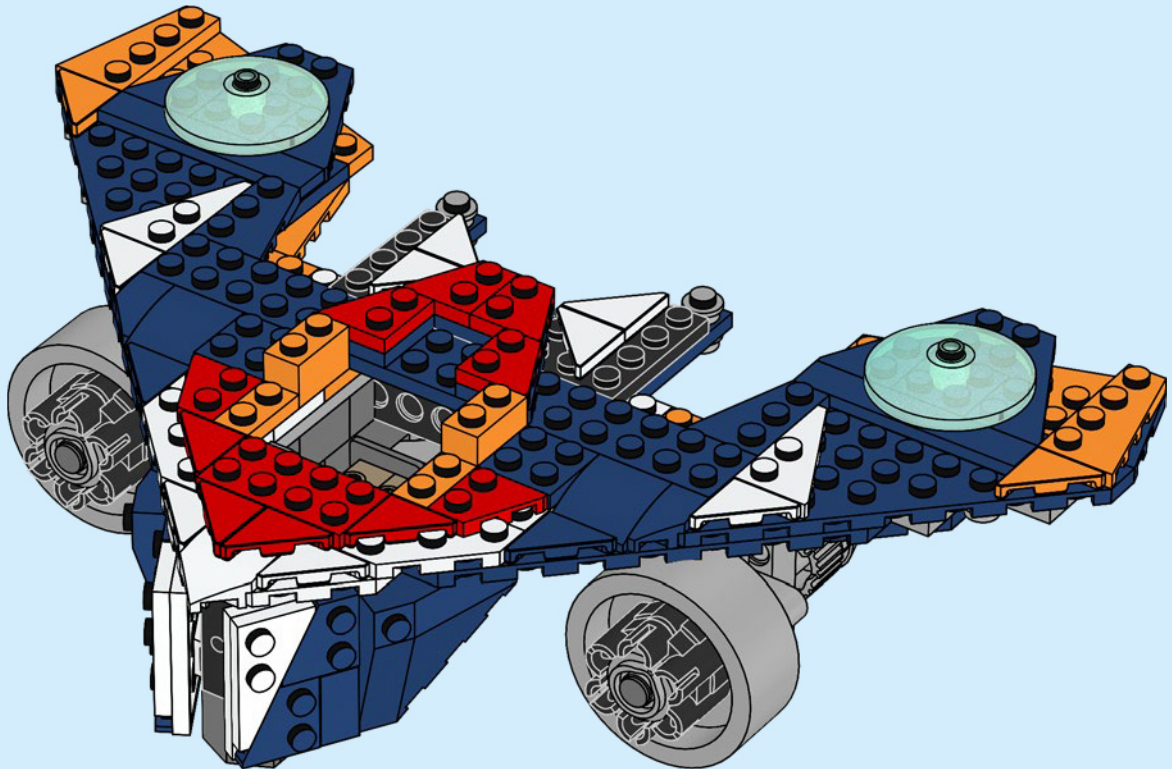



1x

80

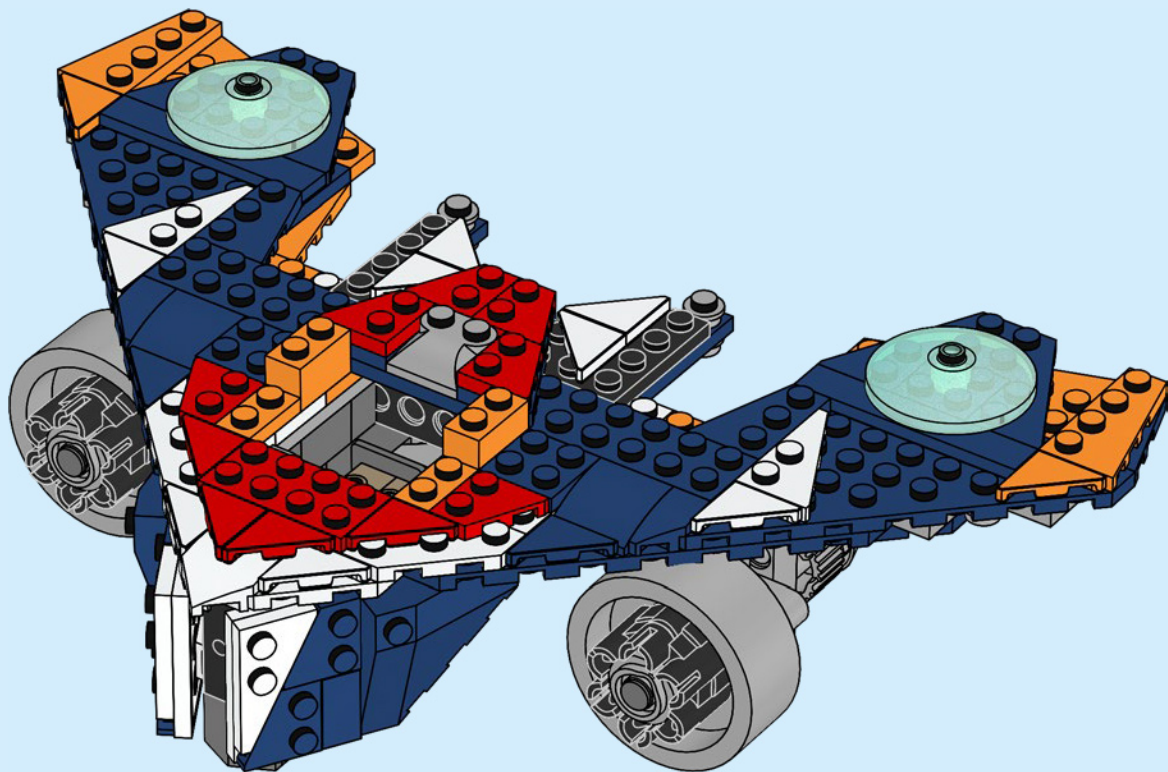

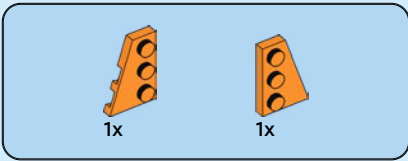

81

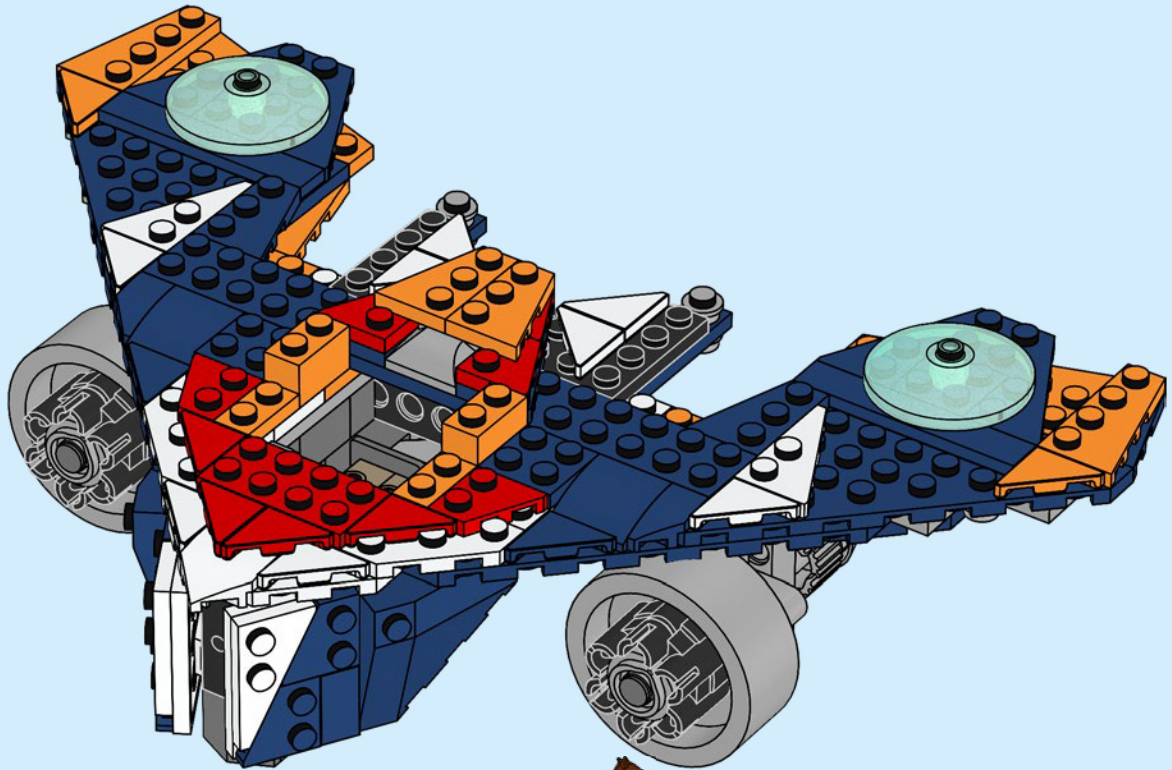



2x

82

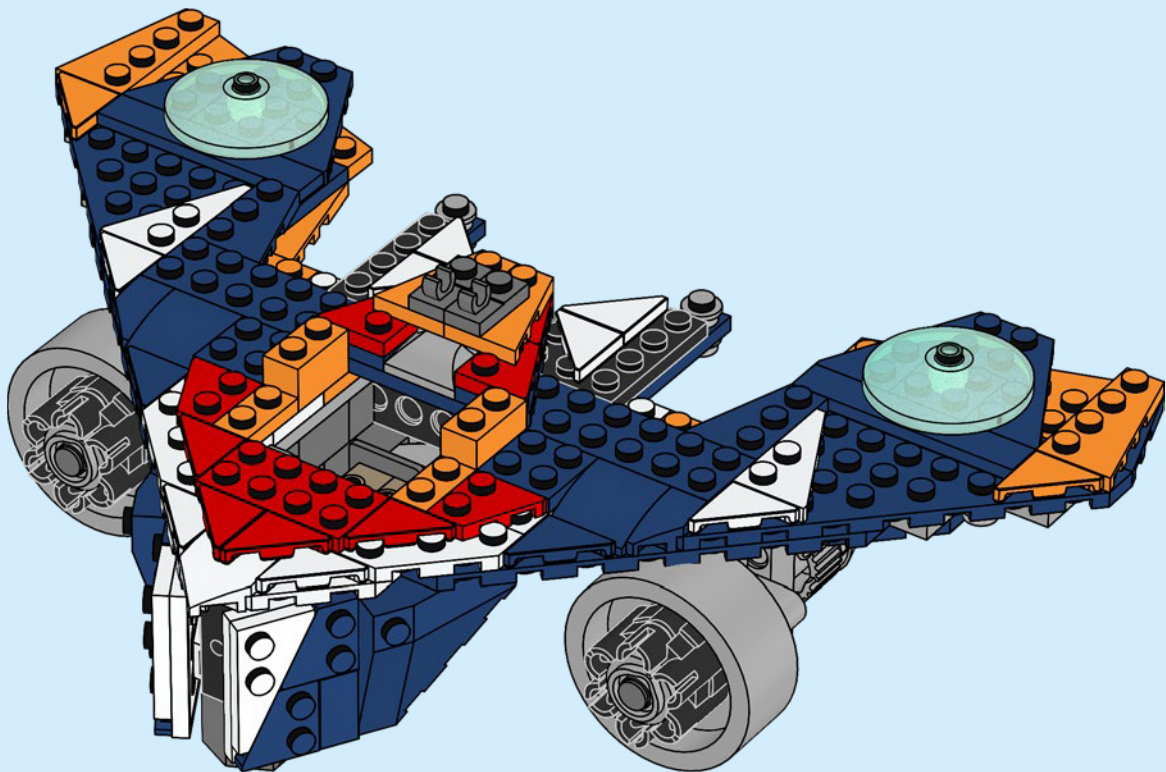



1x

83

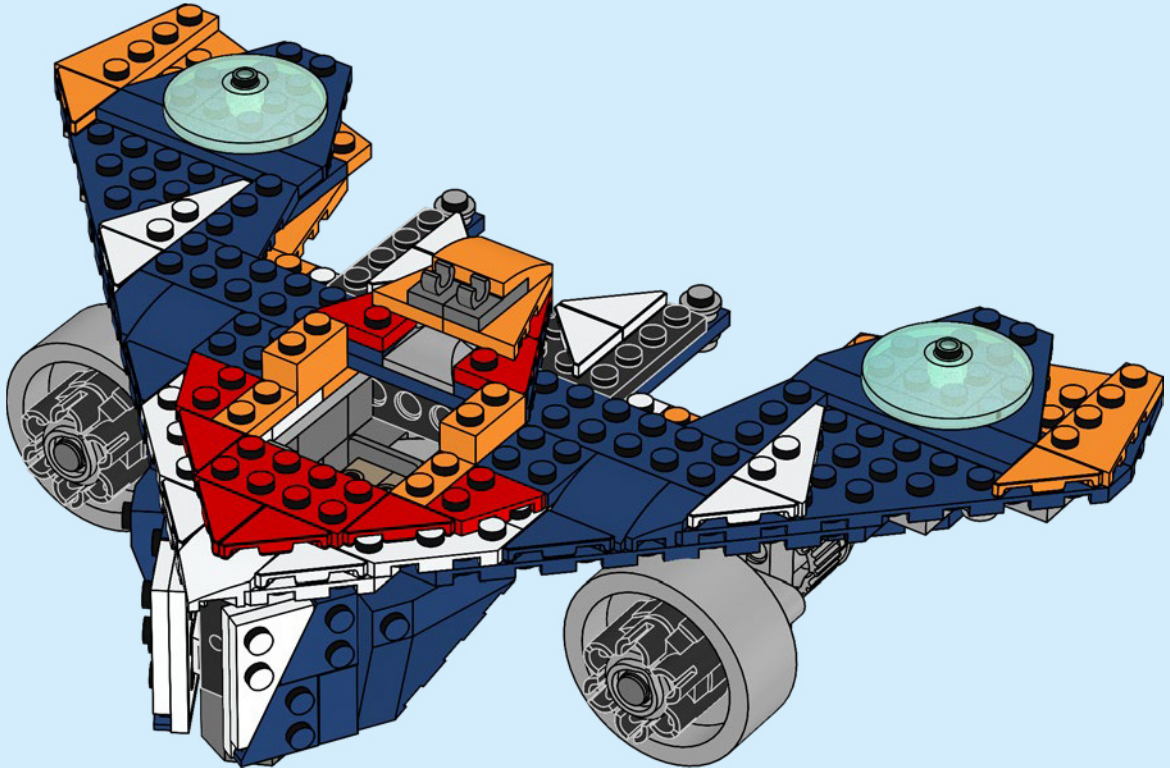



84

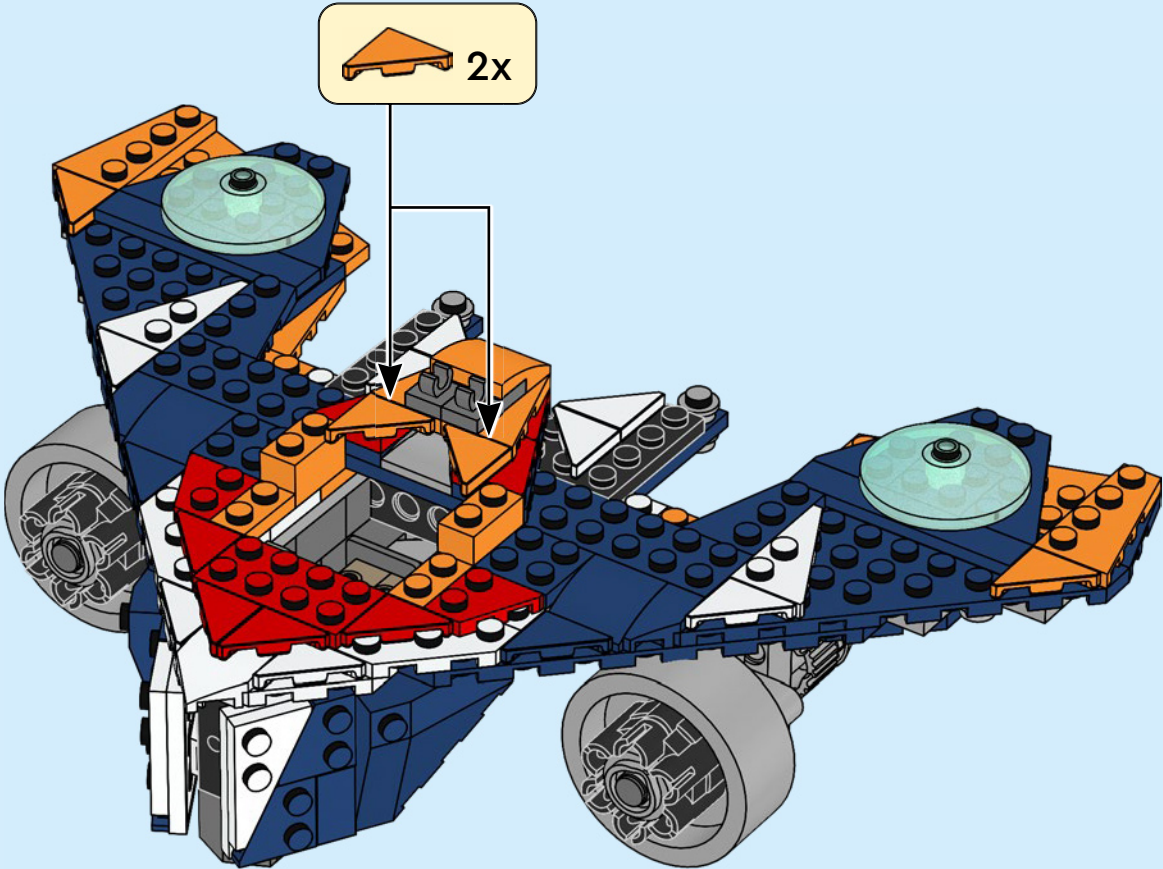



2x



2x

85

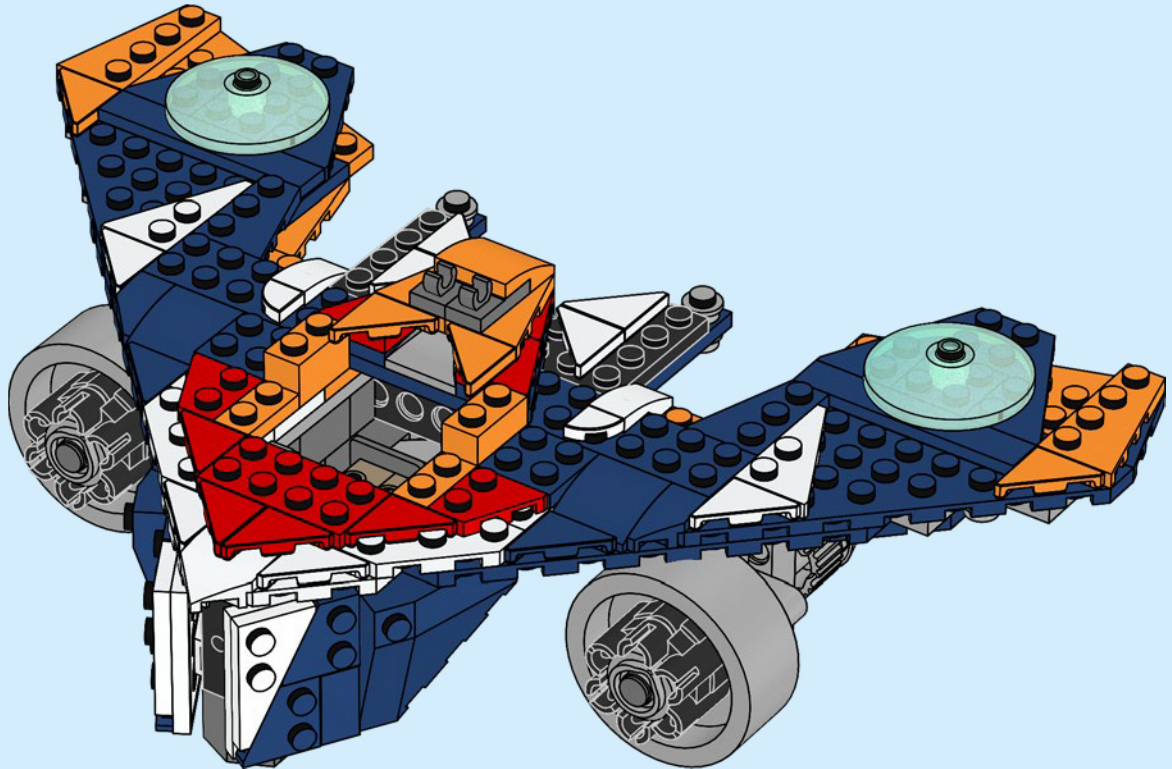



2x

86

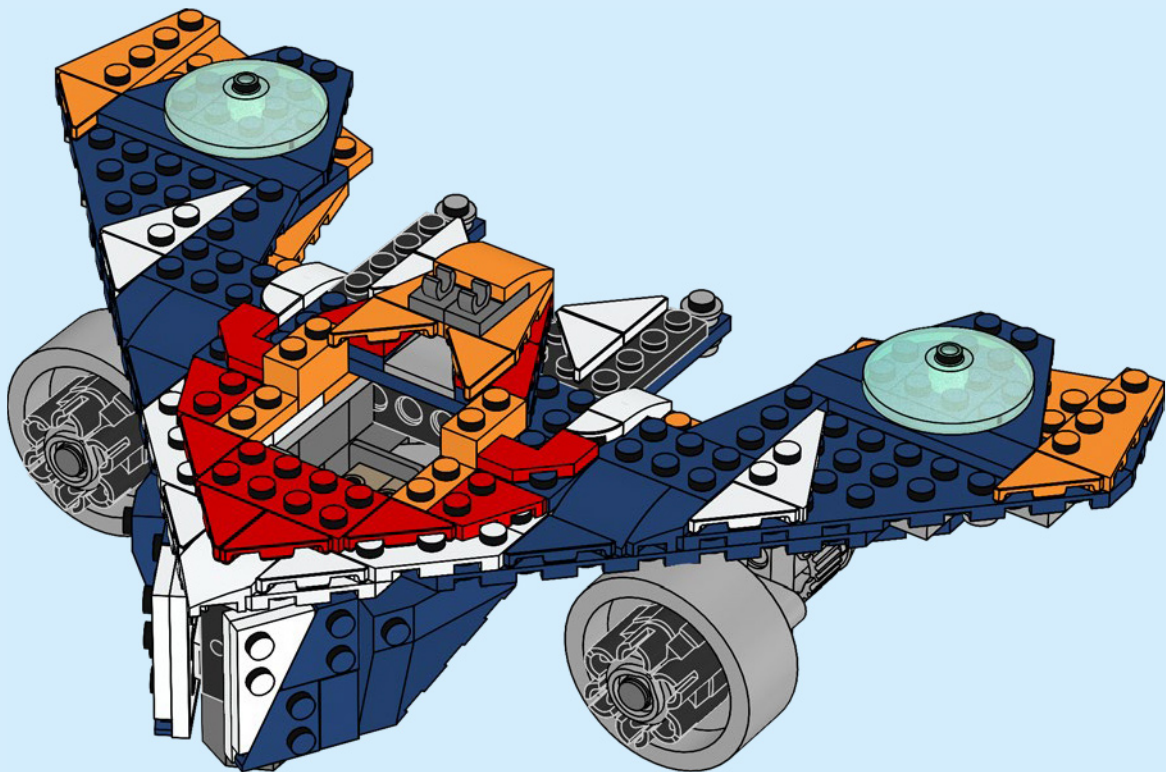

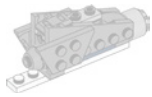

2x

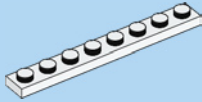

1x



1x

87

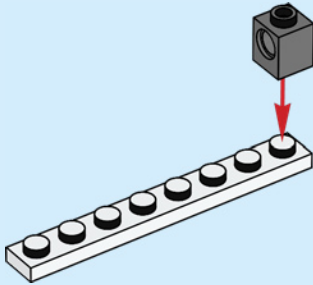

1x



1x

88

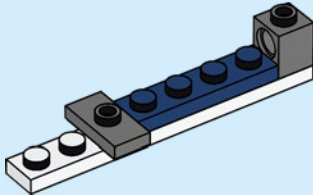

2x



1x

89

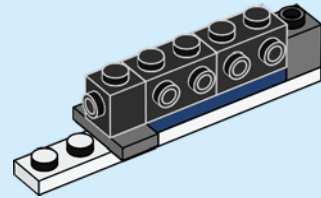

1x

90

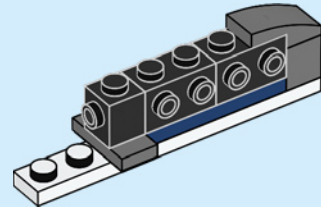

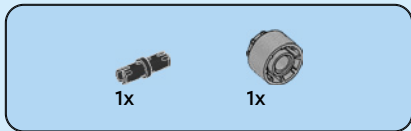

91

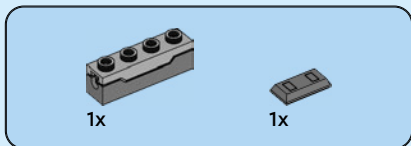
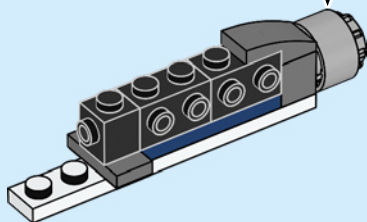
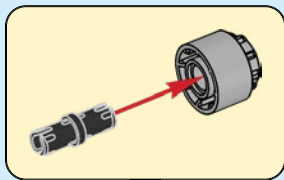

92

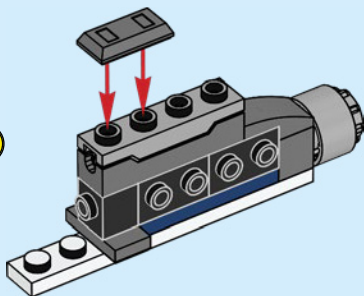

93

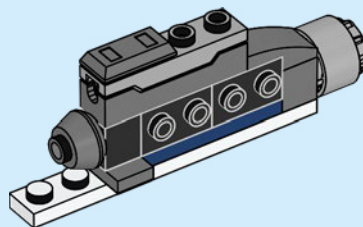

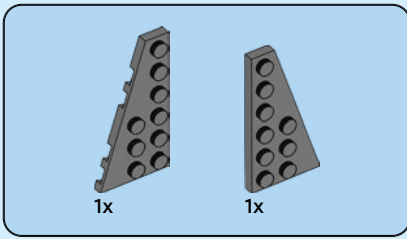

94

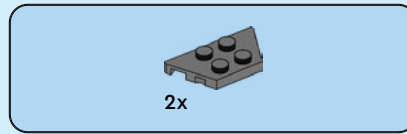
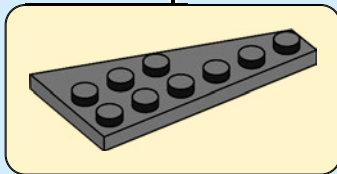
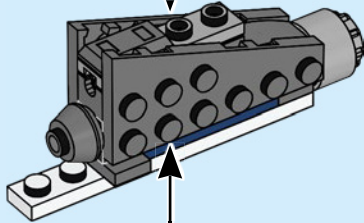
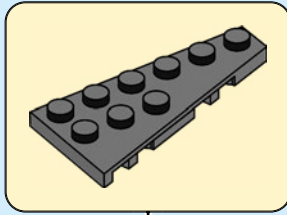

95

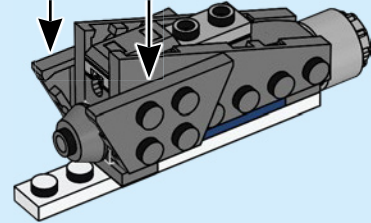
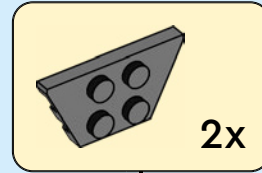

2x



96

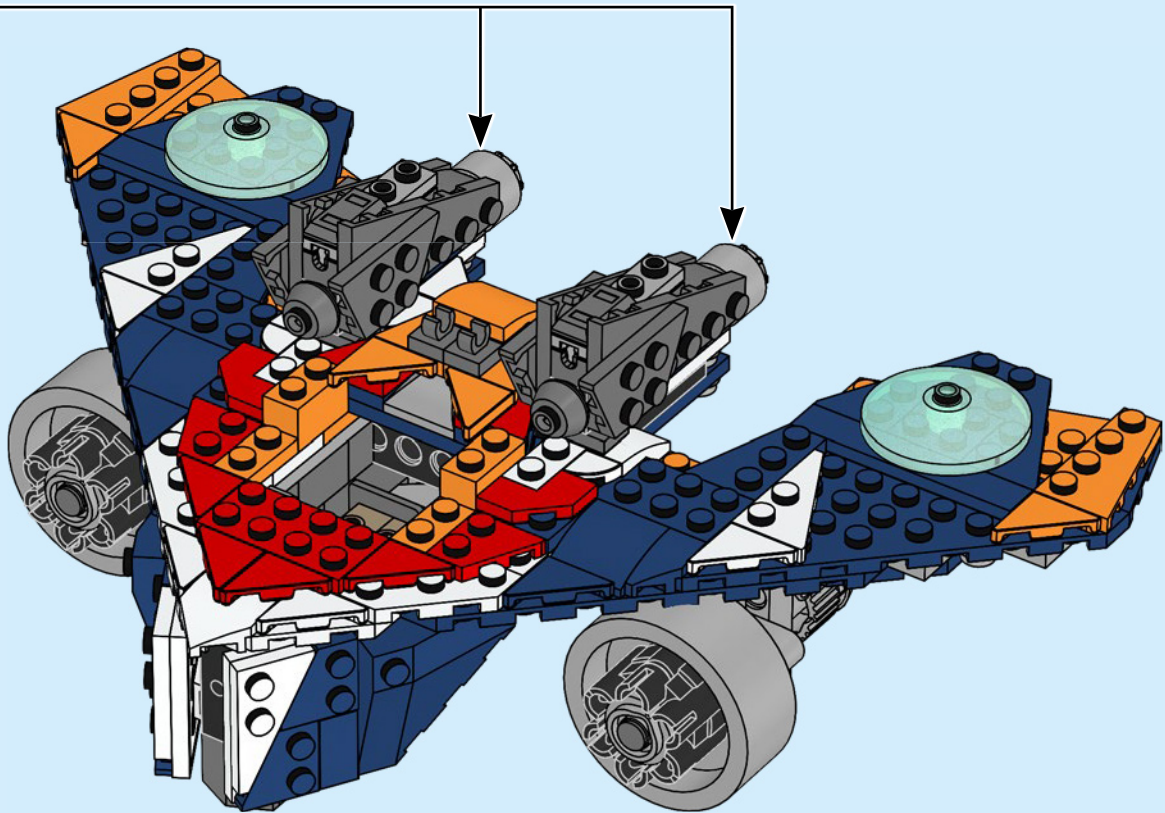



2x

97

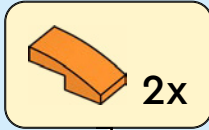

2x

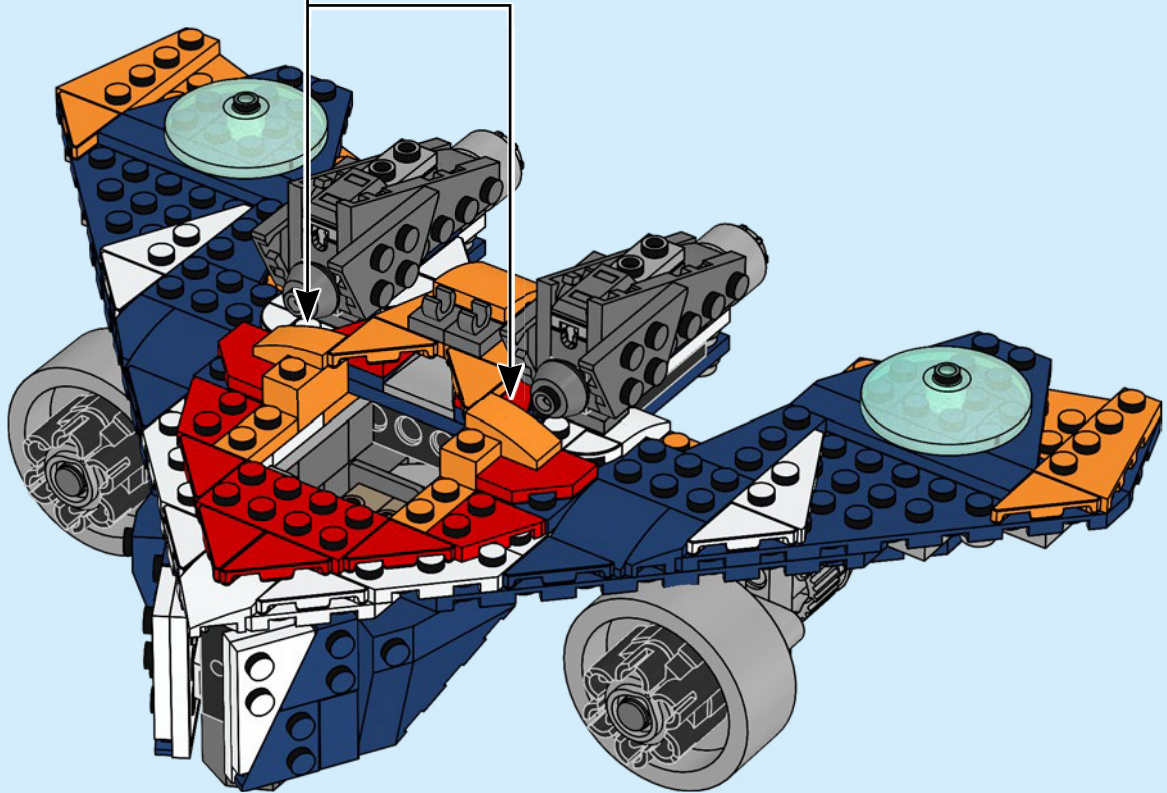



1x



1x

98

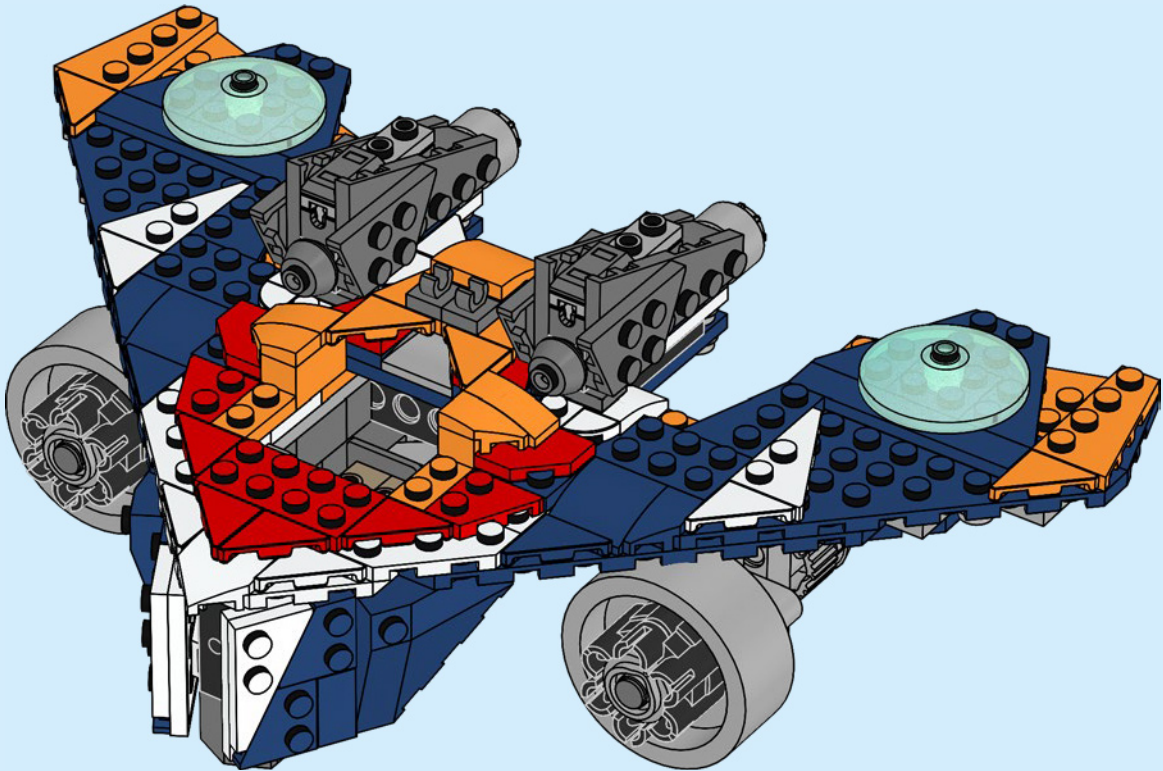

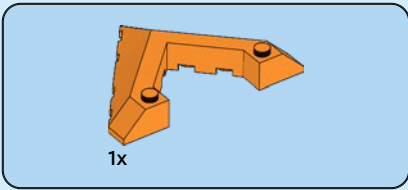

99

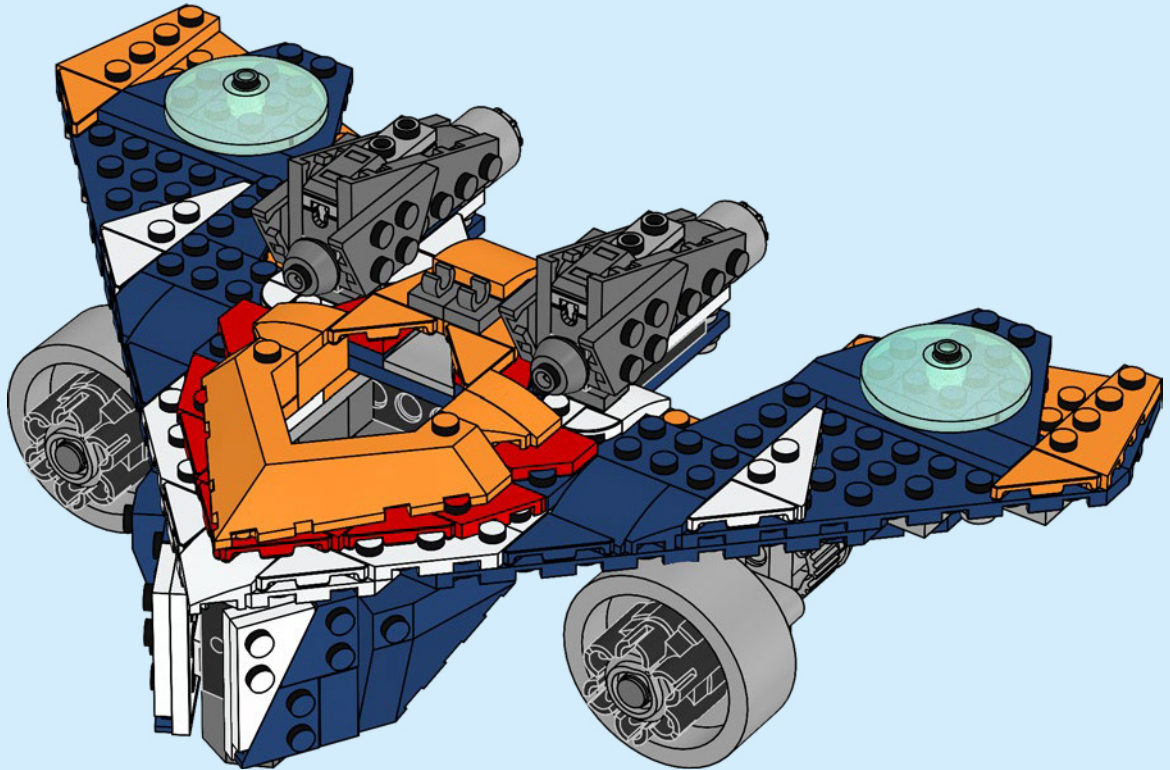

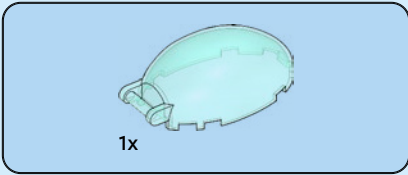

100

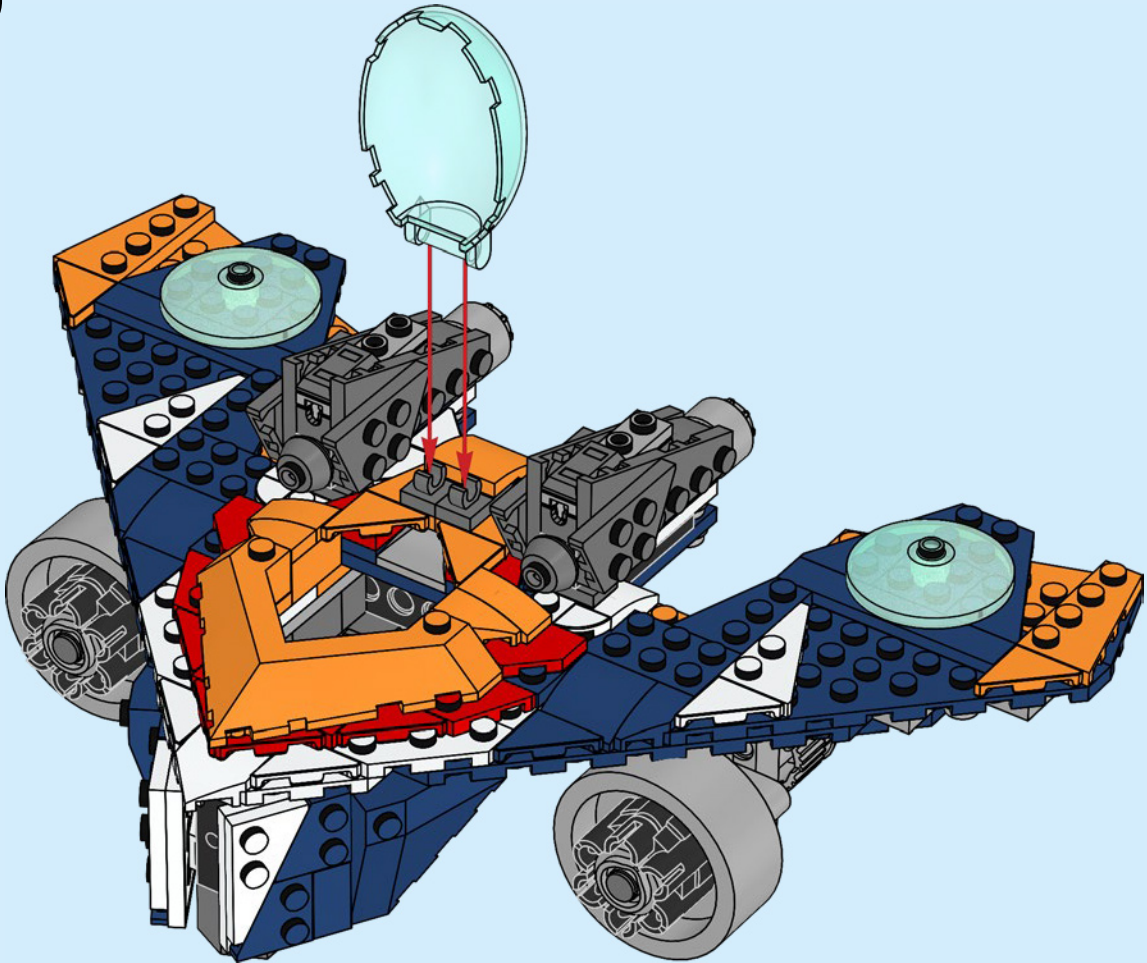

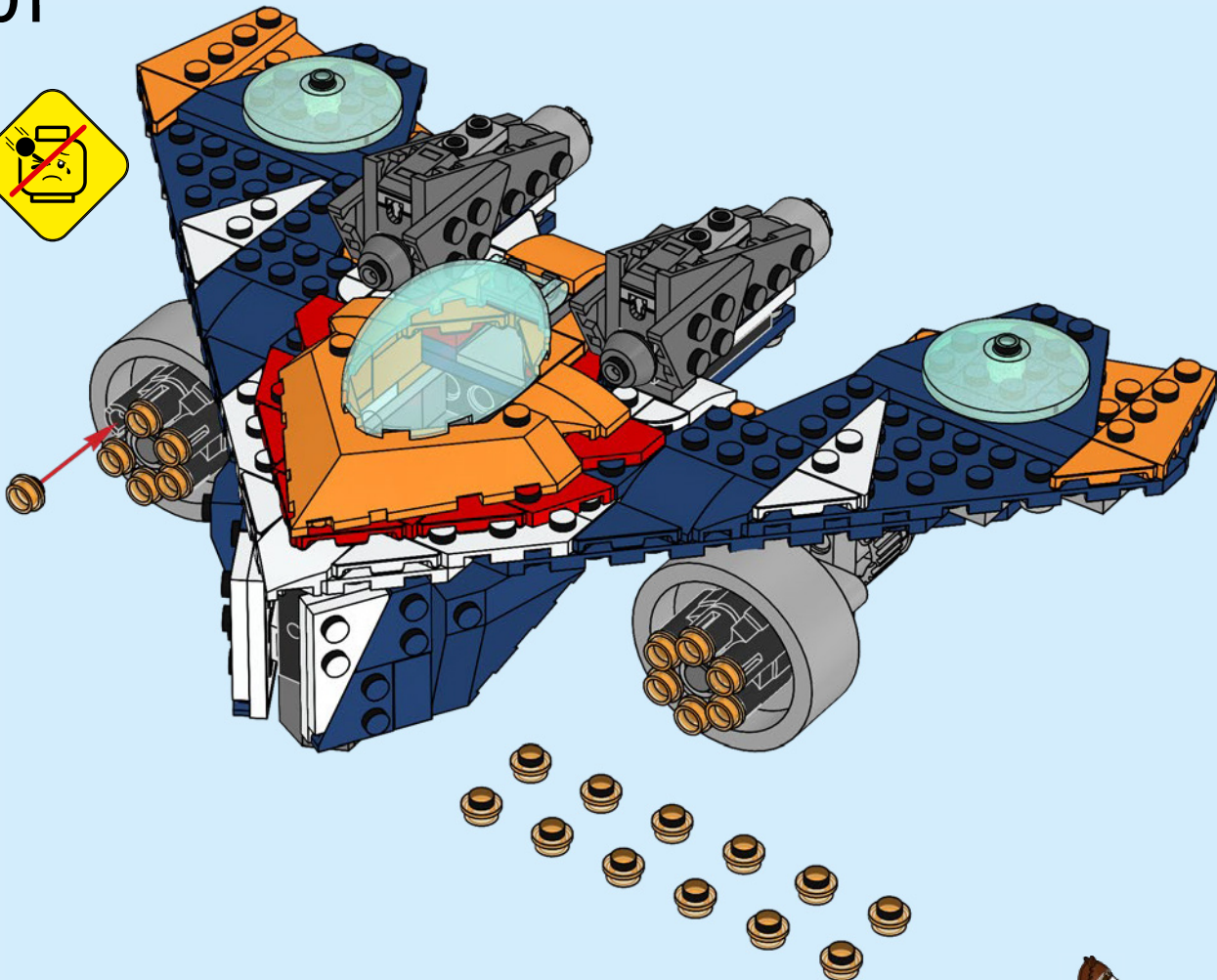

24x

101

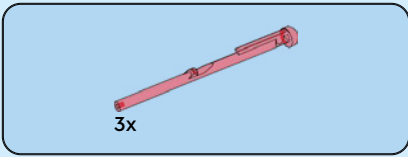

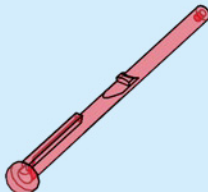
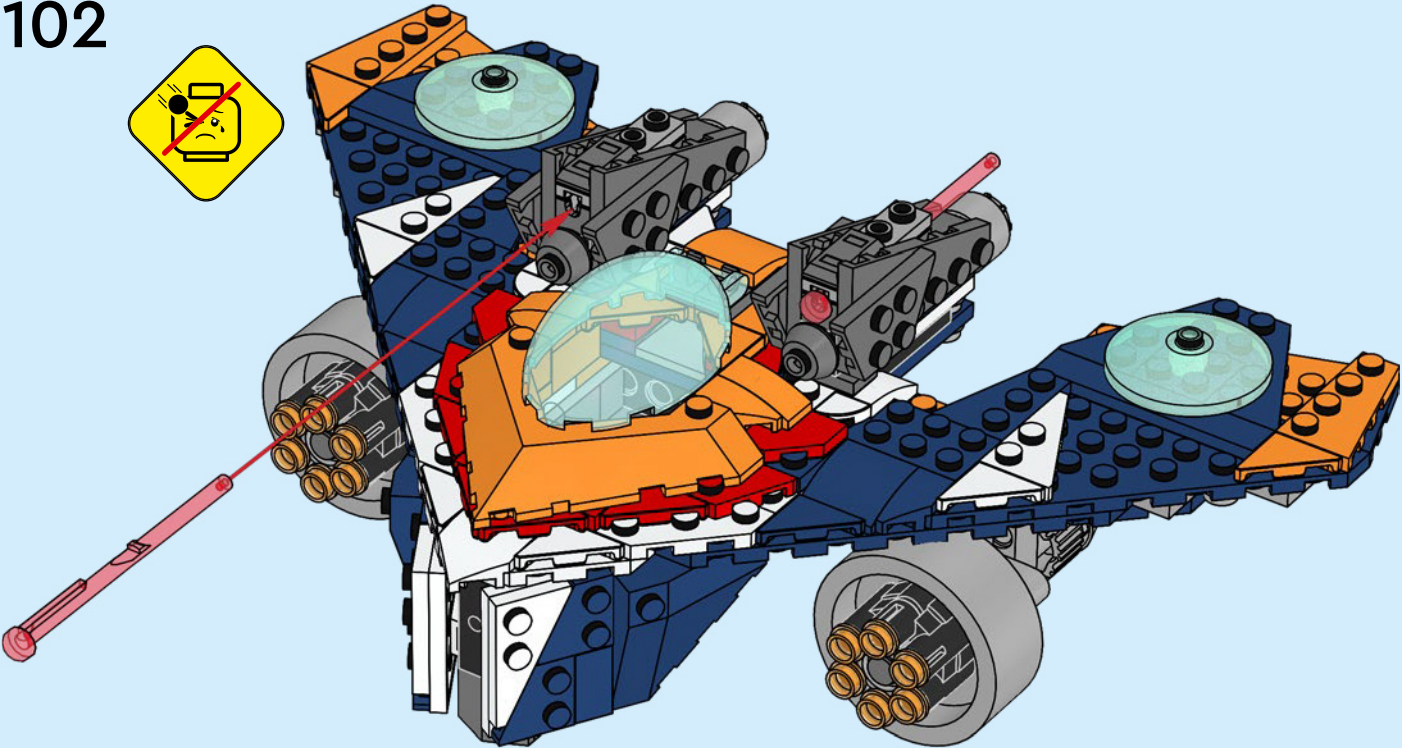

102



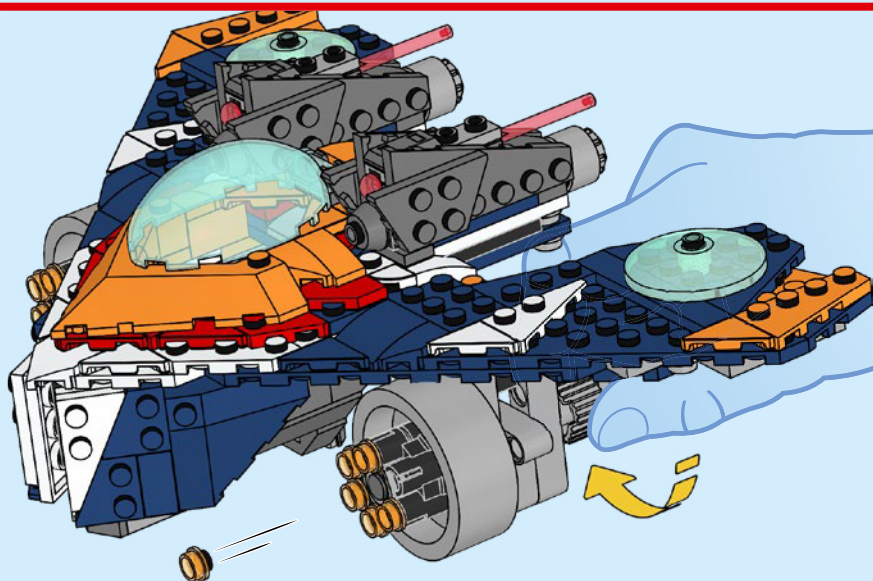
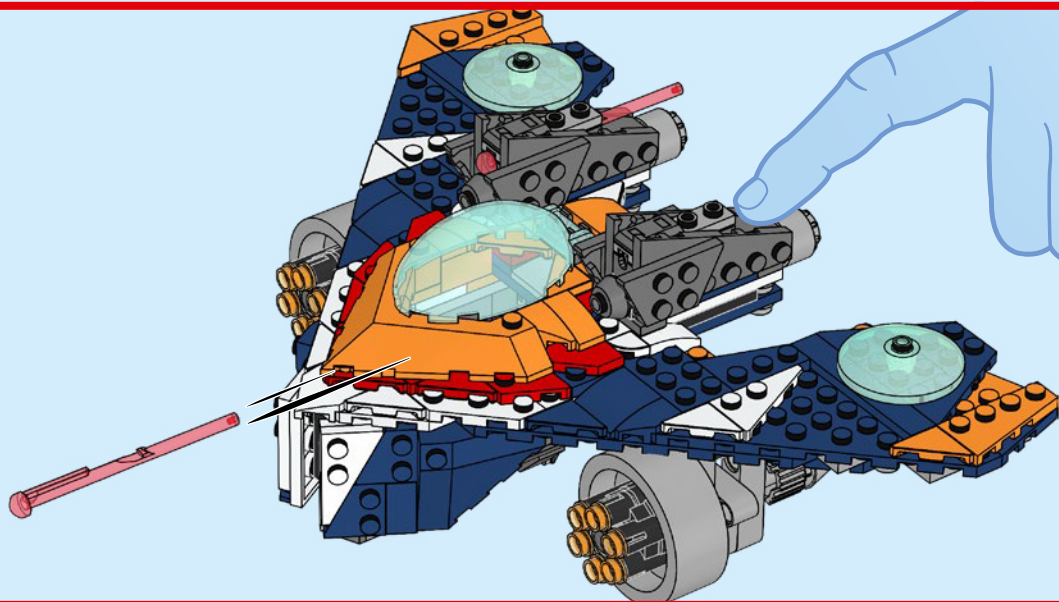





Rebuild
the
world™



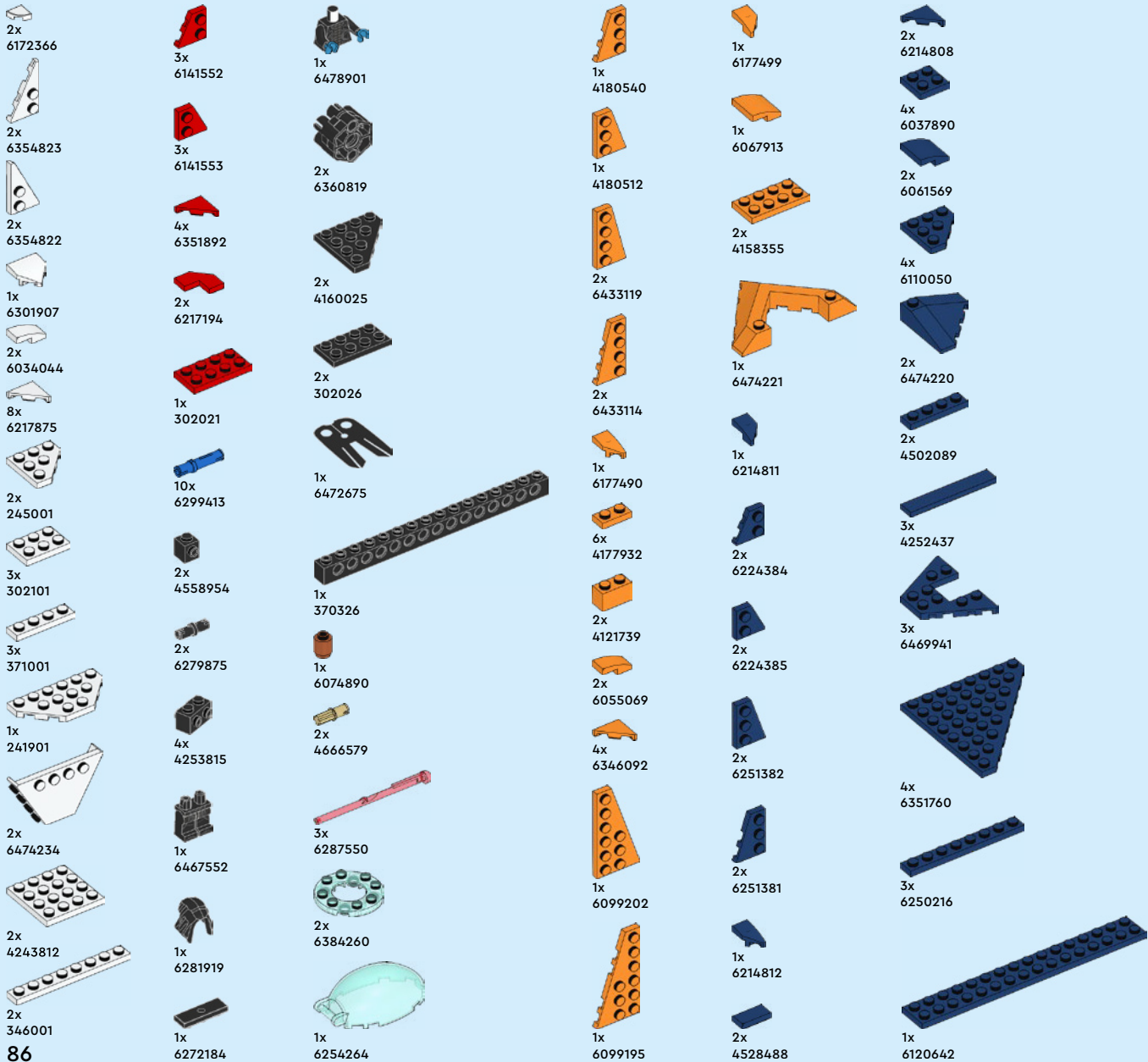

1x
6475602

26x
6240227

1x
6442581

1x
6337817

8x
4211525

2x
4211476

2x
4650645

2x
6028324

2x
6307931

2x
6361703

1x
6123809

1x
4654582

2x
4494475

2x
4552348

2x
6324200

4x
4211395

1x
4211385

4x
4211713

2x
6303442

2x
4211542

1x
6152230

1x
6467550

2x
6102828

2x
6395635

2x
4210639

2x
6340333

1x
4558955

1x
4623236

1x
6152814

2x
6344754

3x
6331866

4x
4211088

2x
4211135

2x
6029948

2x
6092572

2x
6308045

2x
4290150

1x
4504378

2x
4290149

2x
4211000

2x
4211060

2x
4210635

1x
6446786

4x
4211068

4x
4527082

1x
4648256

1x
6185675

1x
6170522

1x
6170420

2x
4211056

1x
4549999

2x
4499858

1x
6478845

2x
6349465

1x
6210400

3x
6213777

2x
6092591

8



 [LEGO.com/service](https://www.LEGO.com/service)

YOU COULD **WIN**

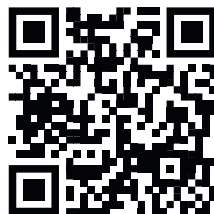

Scan this QR code or go to **LEGO.COM/PRODUCTFEEDBACK** and give us your short feedback about this LEGO® set for a chance to win a cool LEGO prize.

Terms and Conditions apply*



EN: YOU COULD WIN. Terms and Conditions apply* **DE: Du könntest GEWINNEN.** Es gelten die Teilnahmebedingungen* **FR: Tu pourrais GAGNER.** Des conditions s'appliquent* **IT: Potresti VINCERE tu.** Termini e condizioni sono applicabili* **ES: Puedes GANAR.** Aplican términos y condiciones* **PT: Poderá GANHAR.** Aplicam-se termos e condições* **ZH: 轻松获奖. 条款和条件适用*** **PL: Szansa na WYGRANĄ.** Obowiązują warunki korzystania* **CS: Máte šanci VYHRÁT.** Platí všeobecné smluvní podmínky* **SK: Máte šancu VYHRAŤ.** Platia všeobecné zmluvné podmienky* **HU: TE IS NYERHETSZ.** Felhasználási feltételek érvényesek* **RO: Ai putea CÂȘTIGA.** Se aplică termeni și condiții* **BG: Можете да СПЕЧЕЛИТЕ.** Има определени правила и условия* **LV: Tu vari LAIMĒT.** Ir spēkā noteikumi un nosacījumi.* **ET: Sul on võimalus VÕITA.** Kehtivad tingimused* **LT: Jūs galite LAIMĖTI.** Taikomos sąlygos*

*[LEGO.com/productfeedback-terms](https://www.lego.com/productfeedback-terms)

LEGO and the LEGO logo are trademarks of the/son des marques de commerce du/son marcas registradas de LEGO Group. ©2024 The LEGO Group.
© 2024 MARVEL