

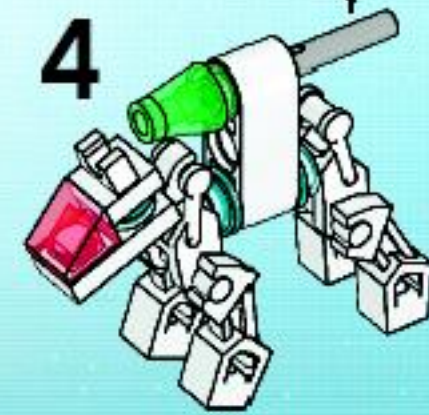

4561957

WARNING: CHOKING HAZARD.
Small parts. Not for children under 3 years.

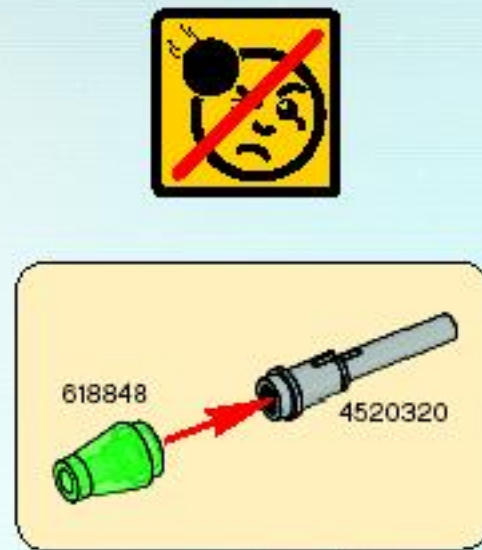
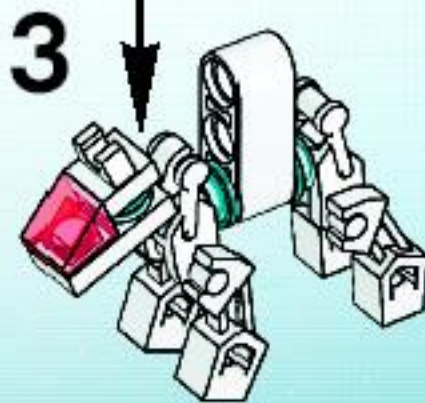
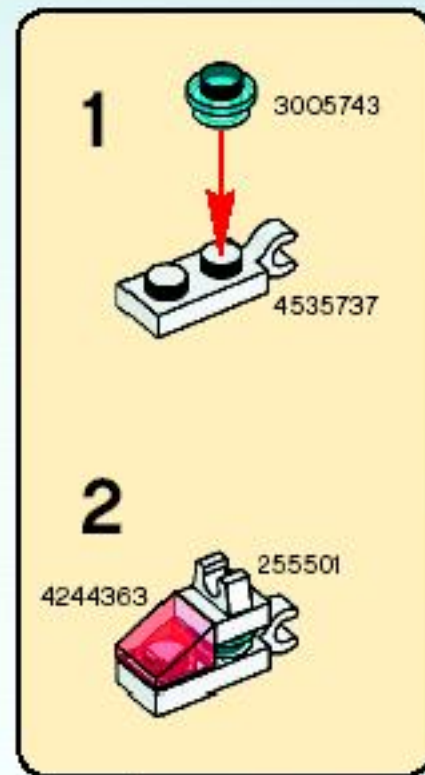
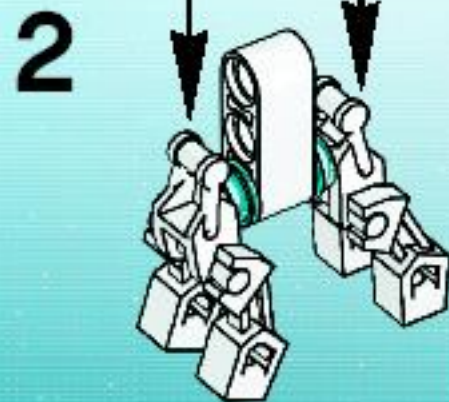
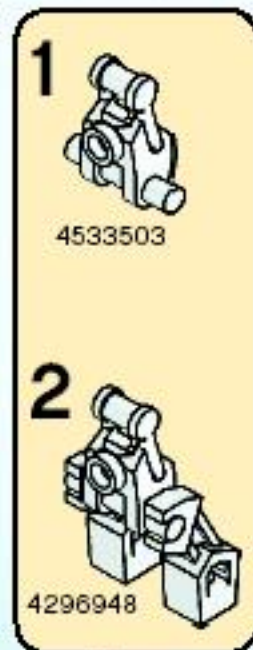
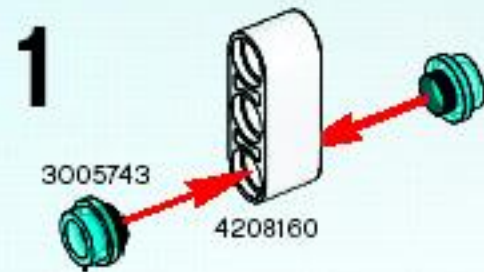

AVERTISSEMENT : RISQUE DÉTOUFFEMENT.
Contient des petites pièces. Ne convient pas aux enfants de moins de 3 ans.

ADVERTENCIA: PELIGRO DE ASFIXIA.
No recomendado para niños menores de 3 años. Contiene piezas pequeñas.

FREE! GRATIS! GRATUIT!

LEGO club MAGAZINE

www.LEGOclub.com



00800 5346 5555

1-866-534-6258 • 1-877-518-5346

US & Canada only Canada seulement

* Téléphone. Heures de charges may apply. * Numéro sans frais. Des frais peuvent s'appliquer avec les téléphones cellulaires.

* Telefonnummern. Kosten für Anrufe aus Mobilfunknetzen können anfallen. * Anrufe über Festnetz sind kostenlos.

* Datanett gratis nummer; når du ringer Pro PostboksPost. * Datanett gratis; når du ringer Pro PostboksPost.



VISIT THE WORLD'S BIGGEST LEGO® SHOP!

www.LEGOshop.com

©2009 The LEGO Group. 4.561.957



LEGO SPACE POLICE

LEGO PIRATES



LEGO CITY

