

4

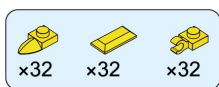

5

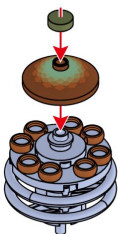
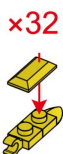

6



=3=

7



8



9



=4=

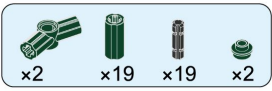

10

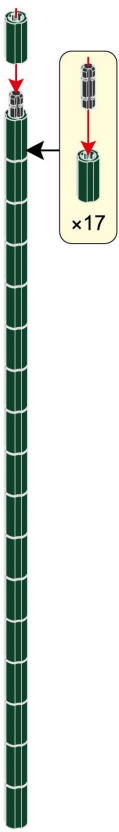

11

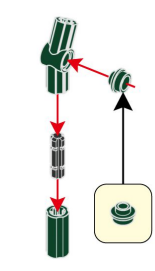

12

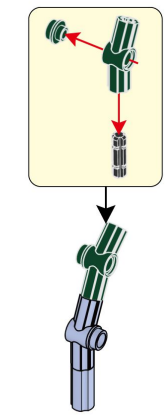

=5=

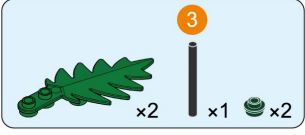

13

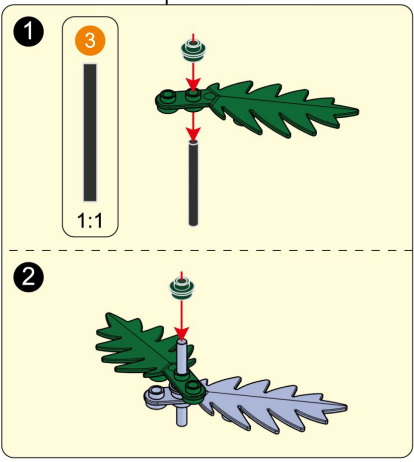
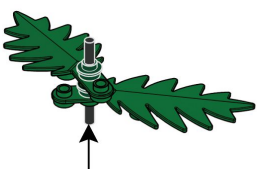
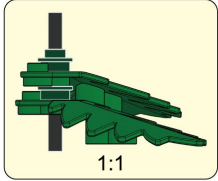

=6=

14

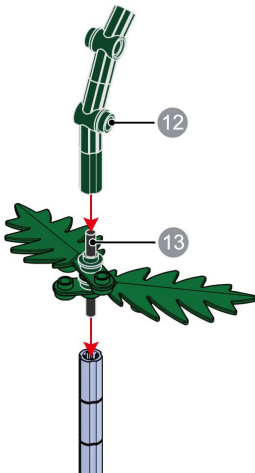

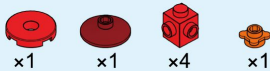
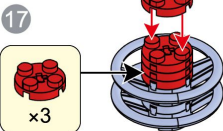
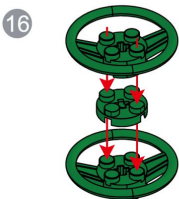
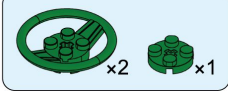
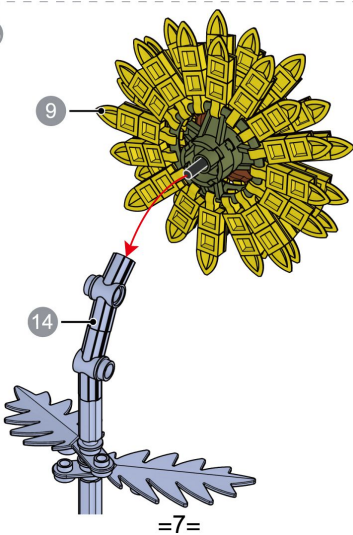

15

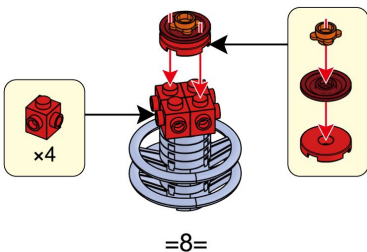

18





=8=

 x2  x2  x2

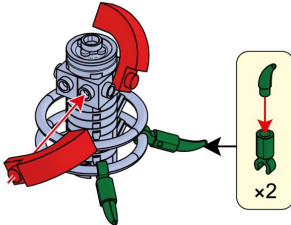





19

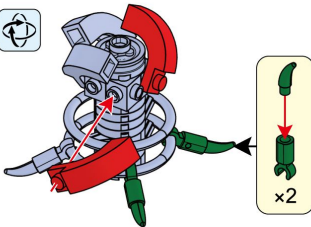

 x2  x2  x2

20



 x8  x8  x16
 x8  x8  x8  x8

21

x8

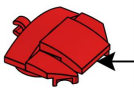

1

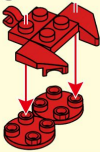

2

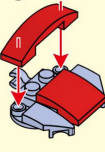

=9=

22

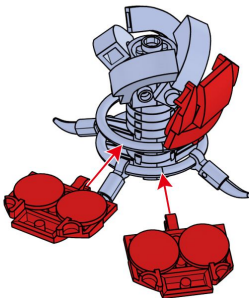

23

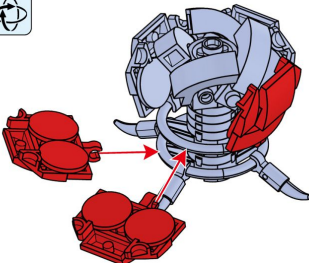

24

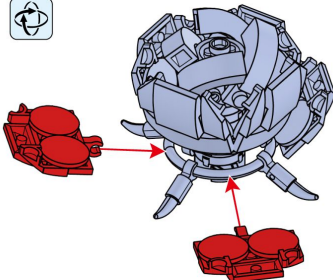

=10=

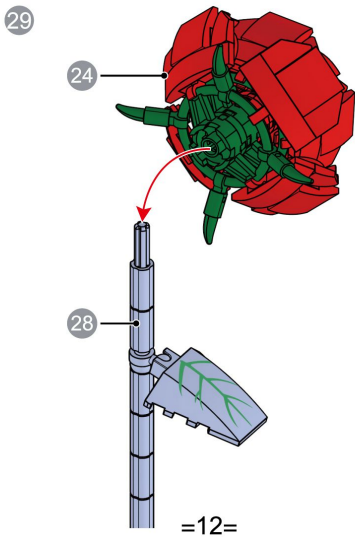
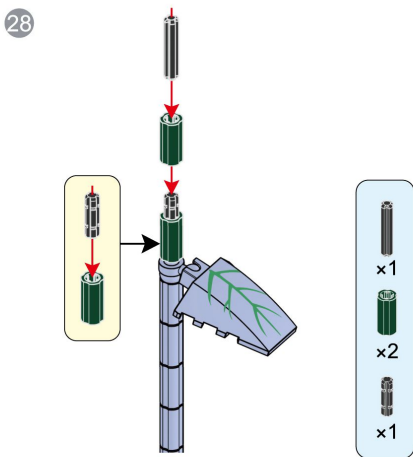
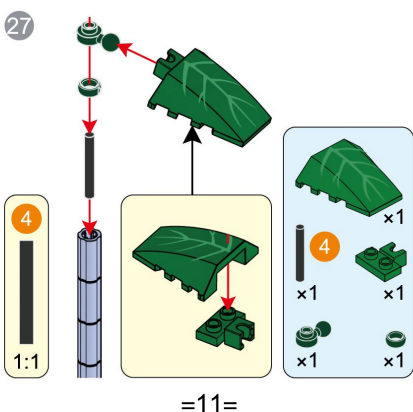
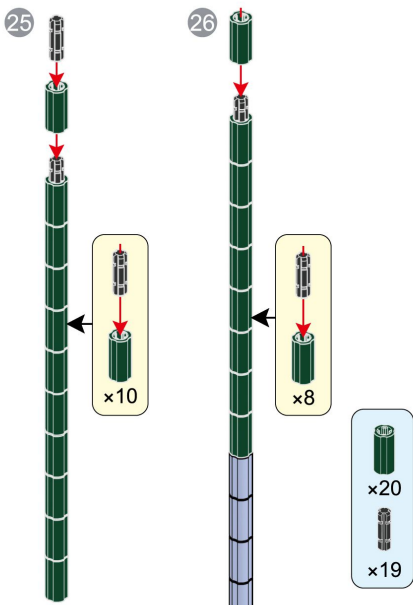

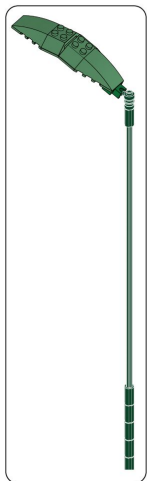

31

30

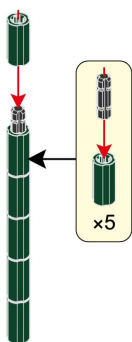

x5



x1

x6

x5

=13=

4



32

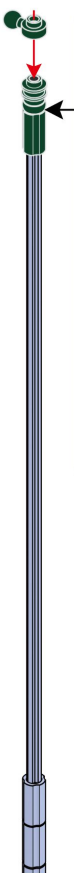

4

1:1

1:1

=14=

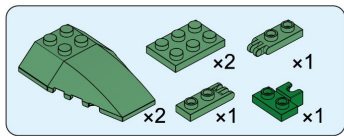

33

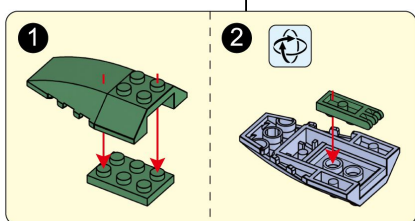
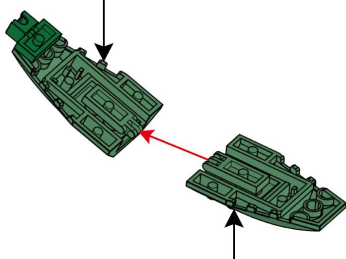
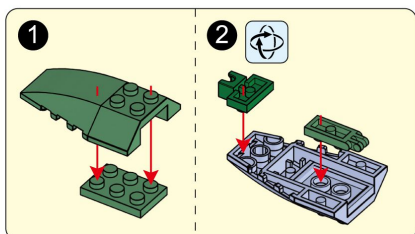

=15=

34

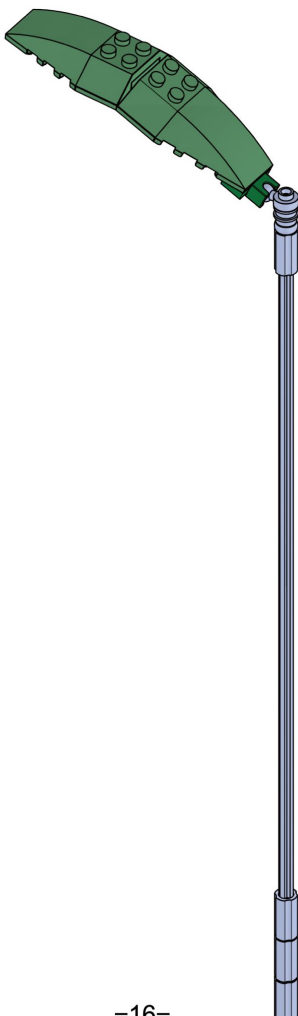

=16=

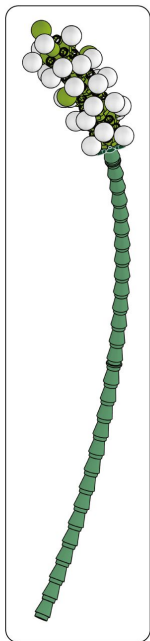

35

2



1:1

2



x1

x1

36

x5



1



2



x5



x20

=17=



x1



x1

37

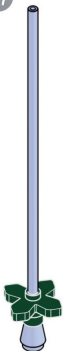

38

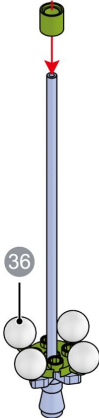

x1



x1



x3



x1

39

1



2



=18=

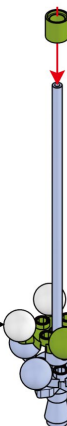



40

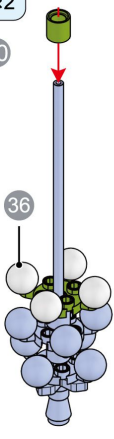

41

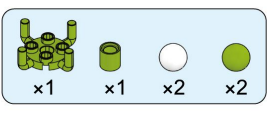
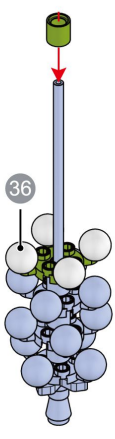

42

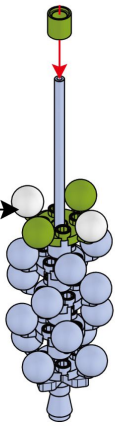
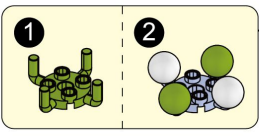

=19=



43

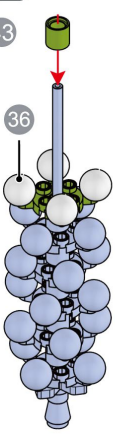

44

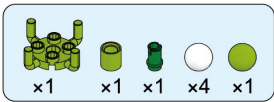
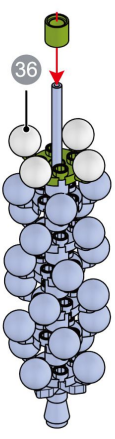

45

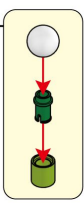
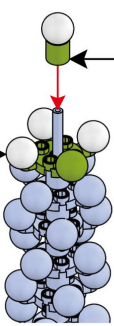
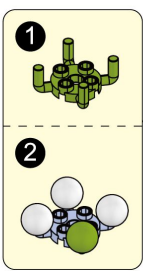

=20=

46



47

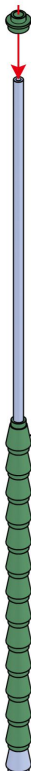

48



1



=21=

49

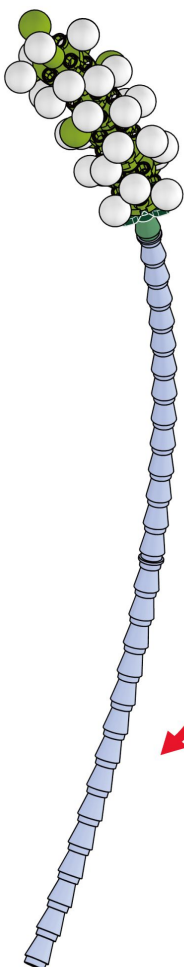

=22=

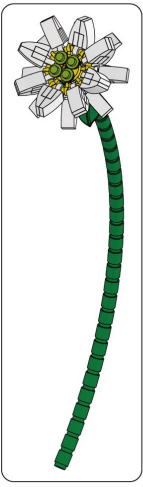

50

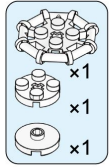
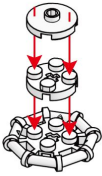

51

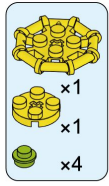
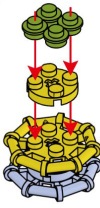

52

x8

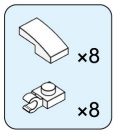

53

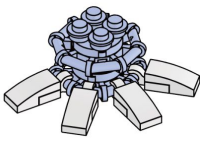

54

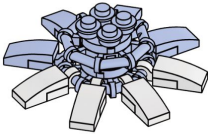

=23=

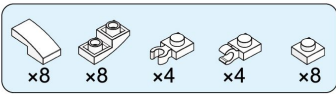

55

x4

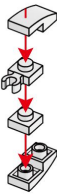

56

x4

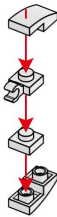

57

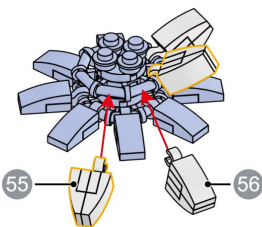

58

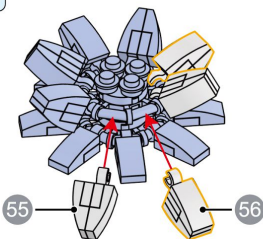

=24=

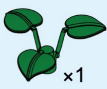

x1



3

x1



x1



x2

59

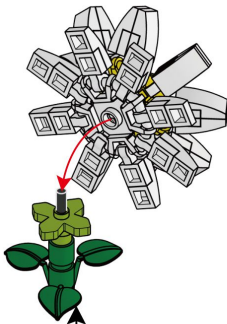

1



1:1



1:1

2

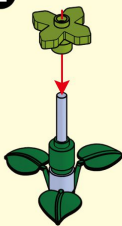

=25=

60



1



61



x25

1



x1

x26

x1

x1

x1

=26=

62

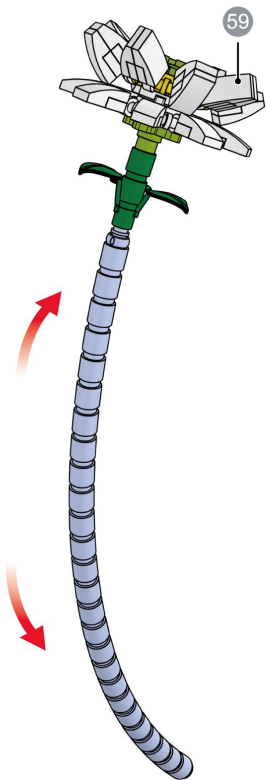

=27=

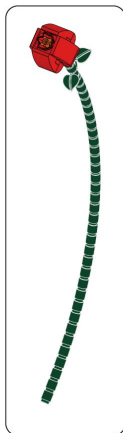

63

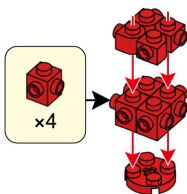

64

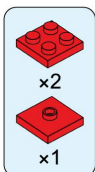
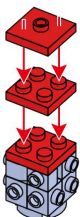

65



=28=

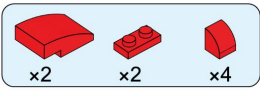

66

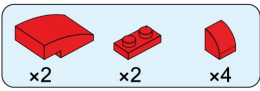
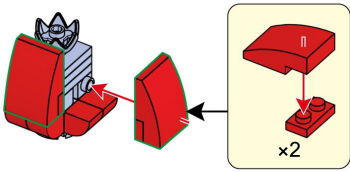

67

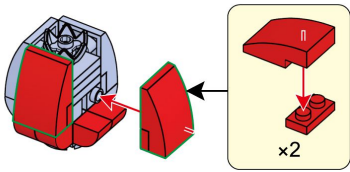

=29=

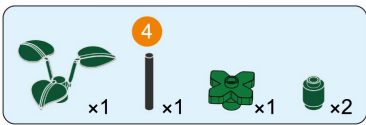

68

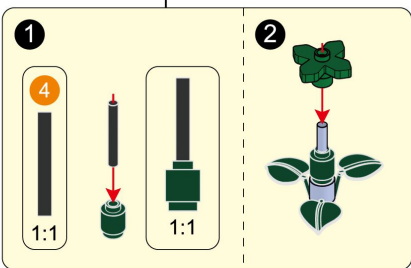
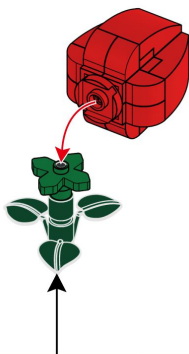

=30=

69

1



70

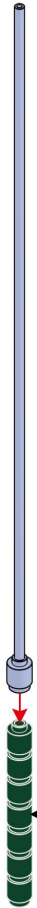

71



=31=

72

68

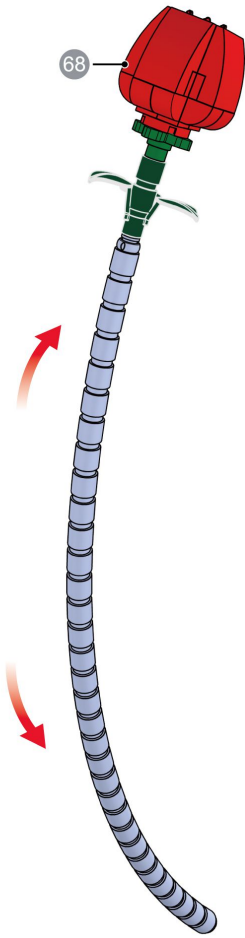

=32=

